

EPA/630/R-95/002F  
April 1998

**Guidelines for  
Ecological Risk Assessment**

(Published on May 14, 1998, Federal Register 63(93):26846-26924)

U.S. Environmental Protection Agency  
Washington, DC

## **DISCLAIMER**

This document has been reviewed in accordance with U.S. Environmental Protection Agency policy and approved for publication. Mention of trade names or commercial products does not constitute endorsement or recommendation for use.

## **NOTICE**

This report contains the full text of the Guidelines for Ecological Risk Assessment. However, the format of this version differs from the Federal Register version, as follows: text boxes that are included in this document at their point of reference were instead listed at the end of the Federal Register document as text notes, due to format limitations for Federal Register documents.

# GUIDELINES FOR ECOLOGICAL RISK ASSESSMENT

[FRL-6011-2]

**AGENCY:** U.S. Environmental Protection Agency

**ACTION:** Notice of availability of final Guidelines for Ecological Risk Assessment

**SUMMARY:** The U.S. Environmental Protection Agency (EPA) is today publishing in final form a document entitled *Guidelines for Ecological Risk Assessment* (hereafter “Guidelines”). These Guidelines were developed as part of an interoffice program by a Technical Panel of the Risk Assessment Forum. These Guidelines will help improve the quality of ecological risk assessments at EPA while increasing the consistency of assessments among the Agency’s program offices and regions.

These Guidelines were prepared during a time of increasing interest in the field of ecological risk assessment and reflect input from many sources both within and outside the Agency. The Guidelines expand upon and replace the previously published EPA report *Framework for Ecological Risk Assessment* (EPA/630/R-92/001, February 1992), which proposed principles and terminology for the ecological risk assessment process. From 1992 to 1994, the Agency focused on identifying a structure for the Guidelines and the issues that the document would address. EPA sponsored public and Agency colloquia, developed peer-reviewed ecological assessment case studies, and prepared a set of peer-reviewed issue papers highlighting important principles and approaches. Drafts of the proposed Guidelines underwent formal external peer review and were reviewed by the Agency’s Risk Assessment Forum, by Federal interagency subcommittees of the Committee on Environment and Natural Resources of the Office of Science and Technology Policy, and by the Agency’s Science Advisory Board (SAB). The proposed Guidelines were published for public comment in 1996 (61 FR 47552-47631, September 9, 1996). The final Guidelines incorporate revisions based on the comments received from the public and the SAB on the proposed Guidelines. EPA appreciates the efforts of all participants in the process and has tried to address their recommendations in these Guidelines.

**DATES:** The Guidelines will be effective April 30, 1998.

**ADDRESSES:** The Guidelines will be made available in several ways:

(1) The electronic version will be accessible on the EPA National Center for Environmental Assessment home page on the Internet at <http://www.epa.gov/ncea/>.

(2) 3½" high-density computer diskettes in WordPerfect format will be available from ORD Publications, Technology Transfer and Support Division, National Risk Management Research Laboratory, Cincinnati, OH; telephone: 513-569-7562; fax: 513-569-7566. Please provide the EPA No. (EPA/630/R-95/002Fa) when ordering.

(3) This notice contains the full document. (However, because of Federal Register format limitations, text boxes that would normally be included at their point of reference in the document are instead listed at the end of the Guidelines as text notes.) Copies of the Guidelines will be available for inspection at EPA headquarters and regional libraries, through the U.S. Government Depository Library program, and for purchase from the National Technical Information Service (NTIS), Springfield, VA; telephone: 703-487-4650, fax: 703-321-8547. Please provide the NTIS PB No. (PB98-117849) when ordering.

**FOR FURTHER INFORMATION, CONTACT:** Risk Assessment Forum (8061-D), U.S. Environmental Protection Agency, 1200 Pennsylvania Avenue, N.W., Washington D.C. 20460; telephone (202) 564-3361, facsimile (202) 565-0062, E-mail: [risk.forum@epa.gov](mailto:risk.forum@epa.gov) (*This pdf document has been updated to reflect current point-of-contact information. The text of the document is otherwise unchanged from the original publication.*)

**SUPPLEMENTARY INFORMATION:** Ecological risk assessment “evaluates the likelihood that adverse ecological effects may occur or are occurring as a result of exposure to one or more stressors” (U.S. EPA, 1992a). It is a flexible process for organizing and analyzing data, information, assumptions, and uncertainties to evaluate the likelihood of adverse ecological effects. Ecological risk assessment provides a critical element for environmental decision making by giving risk managers an approach for considering available scientific information along with the other factors they need to consider (e.g., social, legal, political, or economic) in selecting a course of action.

To help improve the quality and consistency of the U.S. Environmental Protection Agency’s ecological risk assessments, EPA’s Risk Assessment Forum initiated development of these Guidelines. The primary audience for this document is risk assessors and risk managers at EPA, although these Guidelines also may be useful to others outside the Agency. These Guidelines expand on and replace the 1992 report *Framework for Ecological Risk Assessment* (referred to as the Framework Report; see Appendix A). They were written by a Forum technical panel and have been revised on the basis of extensive comments from outside peer reviewers as well as Agency staff. The Guidelines retain the

Framework Report's broad scope, while expanding on some concepts and modifying others to reflect Agency experiences. EPA intends to follow these Guidelines with a series of shorter, more detailed documents that address specific ecological risk assessment topics. This "bookshelf" approach provides the flexibility necessary to keep pace with developments in the rapidly evolving field of ecological risk assessment while allowing time to form consensus, where appropriate, on science policy (default assumptions) to bridge gaps in knowledge. EPA will revisit guidelines documents as experience and scientific consensus evolve. The Agency recognizes that ecological risk assessment is only one tool in the overall management of ecological risks. Therefore, there are ongoing efforts within the Agency to develop other tools and processes that can contribute to an overall approach to ecological risk management, addressing topics such as ecological benefits assessment and cost-benefit analyses.

Ecological risk assessment includes three primary phases: problem formulation, analysis, and risk characterization. In problem formulation, risk assessors evaluate goals and select assessment endpoints, prepare the conceptual model, and develop an analysis plan. During the analysis phase, assessors evaluate exposure to stressors and the relationship between stressor levels and ecological effects. In the third phase, risk characterization, assessors estimate risk through integration of exposure and stressor-response profiles, describe risk by discussing lines of evidence and determining ecological adversity, and prepare a report. The interface among risk assessors, risk managers, and interested parties during planning at the beginning and communication of risk at the end of the risk assessment is critical to ensure that the results of the assessment can be used to support a management decision. Because of the diverse expertise required (especially in complex ecological risk assessments), risk assessors and risk managers frequently work in multidisciplinary teams.

Both risk managers and risk assessors bring valuable perspectives to the initial planning activities for an ecological risk assessment. Risk managers charged with protecting the environment can identify information they need to develop their decision, risk assessors can ensure that science is effectively used to address ecological concerns, and together they can evaluate whether a risk assessment can address identified problems. However, this planning process is distinct from the scientific conduct of an ecological risk assessment. This distinction helps ensure that political and social issues, while helping to define the objectives for the risk assessment, do not introduce undue bias.

Problem formulation, which follows these planning discussions, provides a foundation upon which the entire risk assessment depends. Successful completion of problem formulation depends on the quality of three products: assessment endpoints, conceptual models, and an analysis plan. Since problem formulation is an interactive, nonlinear process, substantial reevaluation is expected to occur during the development of all problem formulation products.

The analysis phase includes two principal activities: characterization of exposure and characterization of ecological effects. The process is flexible, and interaction between the two evaluations is essential. Both activities evaluate available data for scientific credibility and relevance to assessment endpoints and the conceptual model. Exposure characterization describes sources of stressors, their distribution in the environment, and their contact or co-occurrence with ecological receptors. Ecological effects characterization evaluates stressor- response relationships or evidence that exposure to stressors causes an observed response. The bulk of quantitative uncertainty analysis is performed in the analysis phase, although uncertainty is an important consideration throughout the entire risk assessment. The analysis phase products are summary profiles that describe exposure and the stressor-response relationships.

Risk characterization is the final phase of an ecological risk assessment. During this phase, risk assessors estimate ecological risks, indicate the overall degree of confidence in the risk estimates, cite evidence supporting the risk estimates, and interpret the adversity of ecological effects. To ensure mutual understanding between risk assessors and managers, a good risk characterization will express results clearly, articulate major assumptions and uncertainties, identify reasonable alternative interpretations, and separate scientific conclusions from policy judgments. Risk managers use risk assessment results, along with other factors (e.g., economic or legal concerns), in making risk management decisions and as a basis for communicating risks to interested parties and the general public.

After completion of the risk assessment, risk managers may consider whether follow-up activities are required. They may decide on risk mitigation measures, then develop a monitoring plan to determine whether the procedures reduced risk or whether ecological recovery is occurring. Managers may also elect to conduct another planned tier or iteration of the risk assessment if necessary to support a management decision.

---

Dated

---

Carol M. Browner  
Administrator



# CONTENTS

## PART A: GUIDELINES FOR ECOLOGICAL RISK ASSESSMENT

List of Figures .....	ix
List of Text Boxes .....	x
1. Introduction .....	1
1.1. The Ecological Risk Assessment Process .....	2
1.2. Ecological Risk Assessment in a Management Context .....	6
1.2.1. Contributions of Ecological Risk Assessment to Environmental Decision Making .....	6
1.2.2. Factors Affecting the Value of Ecological Risk Assessment for Environmental Decision Making .....	7
1.3. Scope and Intended Audience .....	8
1.4. Guidelines Organization .....	9
2. Planning the Risk Assessment .....	10
2.1. The Roles of Risk Managers, Risk Assessors, and Interested Parties in Planning .....	11
2.2. Products of Planning .....	12
2.2.1. Management Goals .....	14
2.2.2. Management Options to Achieve Goals .....	16
2.2.3. Scope and Complexity of the Risk Assessment .....	18
2.3. Planning Summary .....	19
3. Problem Formulation Phase .....	21
3.1. Products of Problem Formulation .....	22
3.2. Integration of Available Information .....	22
3.3. Selecting Assessment Endpoints .....	25
3.3.1. Criteria for Selection .....	25
3.3.1.1. Ecological Relevance .....	27
3.3.1.2. Susceptibility to Known or Potential Stressors .....	29

## CONTENTS (continued)

3.3.1.3. Relevance to Management Goals .....	31
3.3.2. Defining Assessment Endpoints .....	32
3.4. Conceptual Models .....	36
3.4.1. Risk Hypotheses .....	38
3.4.2. Conceptual Model Diagrams .....	39
3.4.3. Uncertainty in Conceptual Models .....	40
3.5. Analysis Plan .....	41
3.5.1. Selecting Measures .....	42
3.5.2. Ensuring That Planned Analyses Meet Risk Managers' Needs .....	45
4. Analysis Phase .....	48
4.1. Evaluating Data and Models for Analysis .....	50
4.1.1. Strengths and Limitations of Different Types of Data .....	50
4.1.2. Evaluating Measurement or Modeling Studies .....	53
4.1.2.1. Evaluating the Purpose and Scope of the Study .....	55
4.1.2.2. Evaluating the Design and Implementation of the Study .....	55
4.1.3. Evaluating Uncertainty .....	56
4.2. Characterization of Exposure .....	60
4.2.1. Exposure Analyses .....	61
4.2.1.1. Describe the Source(s) .....	61
4.2.1.2. Describe the Distribution of the Stressors or Disturbed Environment .....	63
4.2.1.3. Describe Contact or Co-Occurrence .....	67
4.2.2. Exposure Profile .....	71
4.3. Characterization of Ecological Effects .....	73
4.3.1. Ecological Response Analysis .....	73
4.3.1.1. Stressor-Response Analysis .....	73
4.3.1.2. Establishing Cause-and-Effect Relationships (Causality) .....	78
4.3.1.3. Linking Measures of Effect to Assessment Endpoints .....	82
4.3.2. Stressor-Response Profile .....	89
5. Risk Characterization .....	92
5.1. Risk Estimation .....	92

## CONTENTS (continued)

5.1.1. Results of Field Observational Studies .....	92
5.1.2. Categories and Rankings .....	94
5.1.3. Single-Point Exposure and Effects Comparisons .....	95
5.1.4. Comparisons Incorporating the Entire Stressor-Response Relationship .....	99
5.1.5. Comparisons Incorporating Variability in Exposure and/or Effects .....	99
5.1.6. Application of Process Models .....	101
5.2. Risk Description .....	103
5.2.1. Lines of Evidence .....	103
5.2.2. Determining Ecological Adversity .....	106
5.3. Reporting Risks .....	109
6. Relating Ecological Information to Risk Management Decisions .....	112
Appendix A: Changes from EPA's Ecological Risk Assessment Framework .....	A-1
Appendix B: Key Terms .....	B-1
Appendix C: Conceptual Model Examples .....	C-1
Appendix D: Analysis Phase Examples .....	D-1
Appendix E: Criteria for Determining Ecological Adversity: A Hypothetical Example .....	E-1
References .....	R-1

## **PART B: RESPONSE TO SCIENCE ADVISORY BOARD AND PUBLIC COMMENTS**

1. Introduction .....	1
2. Response to General Comments .....	1

**CONTENTS (continued)**

3. Response to Comments on Specific Questions ..... 3

## LIST OF FIGURES

Figure 1-1. The framework for ecological risk assessment .....	3
Figure 1-2. The ecological risk assessment framework, with an expanded view of each phase .....	4
Figure 3-1. Problem formulation phase .....	23
Figure 4-1. Analysis phase .....	49
Figure 4-2. A simple example of a stressor-response relationship. ....	74
Figure 4-3. Variations in stressor-response relationships. ....	75
Figure 5-1. Risk characterization .....	93
Figure 5-2. Risk estimation techniques. a. Comparison of exposure and stressor-response point estimates. b. Comparison of point estimates from the stressor-response relationship with uncertainty associated with an exposure point estimate .....	96
Figure 5-3. Risk estimation techniques: comparison of point estimates with associated uncertainties .....	98
Figure 5-4. Risk estimation techniques: stressor-response curve versus a cumulative distribution of exposures .....	100
Figure 5-5. Risk estimation techniques: comparison of exposure distribution of an herbicide in surface waters with freshwater single-species toxicity data .....	102

## LIST OF TEXT BOXES

Text Box 1-1. Related Terminology .....	2
Text Box 1-2. Flexibility of the Framework Diagram .....	5
Text Box 2-1. Who Are Risk Managers? .....	10
Text Box 2-2. Who Are Risk Assessors? .....	11
Text Box 2-3. Who Are Interested Parties? .....	12
Text Box 2-4. Questions Addressed by Risk Managers and Risk Assessors .....	13
Text Box 2-5. Sustainability as a Management Goal .....	14
Text Box 2-6. Management Goals for Waquoit Bay .....	15
Text Box 2-7. What is the Difference Between a Management Goal and Management Decision? .....	17
Text Box 2-8. Tiers and Iteration: When Is a Risk Assessment Done? .....	18
Text Box 2-9. Questions to Ask About Scope and Complexity .....	19
Text Box 3-1. Avoiding Potential Shortcomings Through Problem Formulation .....	21
Text Box 3-2. Uncertainty in Problem Formulation .....	23
Text Box 3-3. Initiating a Risk Assessment: What's Different When Stressors, Effects, or Values Drive the Process? .....	24
Text Box 3-4. Assessing Available Information: Questions to Ask Concerning Source, Stressor, and Exposure Characteristics, Ecosystem Characteristics, and Effects .....	26
Text Box 3-5. Salmon and Hydropower: Salmon as the Basis for an Assessment Endpoint .....	27
Text Box 3-6. Cascading Adverse Effects: Primary (Direct) and Secondary (Indirect) .....	28
Text Box 3-7. Identifying Susceptibility .....	29
Text Box 3-8. Sensitivity and Secondary Effects: The Mussel-Fish Connection .....	31
Text Box 3-9. Examples of Management Goals and Assessment Endpoints .....	34
Text Box 3-10. Common Problems in Selecting Assessment Endpoints .....	36
Text Box 3-11. What Are the Benefits of Developing Conceptual Models? .....	37
Text Box 3-12. What Are Risk Hypotheses, and Why Are They Important? .....	38
Text Box 3-13. Examples of Risk Hypotheses .....	39
Text Box 3-14. Uncertainty in Problem Formulation .....	41
Text Box 3-15. Why Was <i>Measurement Endpoint</i> Changed? .....	43
Text Box 3-16. Examples of a Management Goal, Assessment Endpoint, and Measures .....	44

## LIST OF TEXT BOXES (continued)

Text Box 3-17. How Do Water Quality Criteria Relate to Assessment Endpoints? .....	45
Text Box 3-18. The Data Quality Objectives Process .....	46
Text Box 4-1. Data Collection and the Analysis Phase .....	48
Text Box 4-2. The American National Standard for Quality Assurance .....	54
Text Box 4-3. Questions for Evaluating a Study's Utility for Risk Assessment .....	54
Text Box 4-4. Uncertainty Evaluation in the Analysis Phase .....	58
Text Box 4-5. Considering the Degree of Aggregation in Models .....	60
Text Box 4-6. Questions for Source Description .....	62
Text Box 4-7. Questions to Ask in Evaluating Stressor Distribution .....	64
Text Box 4-8. General Mechanisms of Transport and Dispersal .....	64
Text Box 4-9. Questions to Ask in Describing Contact or Co-occurrence .....	67
Text Box 4-10. Example of an Exposure Equation: Calculating a Potential Dose via Ingestion .....	68
Text Box 4-11. Measuring Internal Dose Using Biomarkers and Tissue Residues .....	69
Text Box 4-12. Questions Addressed by the Exposure Profile .....	71
Text Box 4-13. Questions for Stressor-Response Analysis .....	74
Text Box 4-14. Qualitative Stressor-Response Relationships .....	75
Text Box 4-15. Median Effect Levels .....	76
Text Box 4-16. No-Effect Levels Derived From Statistical Hypothesis Testing .....	77
Text Box 4-17. General Criteria for Causality .....	79
Text Box 4-18. Koch's Postulates .....	80
Text Box 4-19. Examples of Extrapolations to Link Measures of Effect to Assessment Endpoints .....	82
Text Box 4-20. Questions Related to Selecting Extrapolation Approaches .....	83
Text Box 4-21. Questions to Consider When Extrapolating From Effects Observed in the Laboratory to Field Effects of Chemicals .....	85
Text Box 4-22. Questions Addressed by the Stressor-Response Profile .....	90
Text Box 5-1. An Example of Field Methods Used for Risk Estimation .....	94
Text Box 5-2. Using Qualitative Categories to Estimate Risks of an Introduced Species .....	95
Text Box 5-3. Applying the Quotient Method .....	97
Text Box 5-4. Comparing an Exposure Distribution With a Point Estimate of Effects .....	99
Text Box 5-5. Comparing Cumulative Exposure and Effects Distributions for Chemical	

**LIST OF TEXT BOXES (continued)**

Stressors ..... 101

Text Box 5-6. Estimating Risk With Process Models ..... 103

Text Box 5-7. What Are Statistically Significant Effects? ..... 107

Text Box 5-8. Possible Risk Assessment Report Elements ..... 110

Text Box 5-9. Clear, Transparent, Reasonable, and Consistent Risk Characterizations ..... 111

Text Box 6-1. Questions Regarding Risk Assessment Results ..... 112

Text Box 6-2. Risk Communication Considerations for Risk Managers ..... 113

Text Box A-1. Stressor vs. Agent ..... A-3



## 1. INTRODUCTION

Ecological risk assessment is a process that evaluates the likelihood that adverse ecological effects may occur or are occurring as a result of exposure to one or more stressors (U.S. EPA, 1992a). The process is used to systematically evaluate and organize data, information, assumptions, and uncertainties in order to help understand and predict the relationships between stressors and ecological effects in a way that is useful for environmental decision making. An assessment may involve chemical, physical, or biological stressors, and one stressor or many stressors may be considered.

Ecological risk assessments are developed within a risk management context to evaluate human-induced changes that are considered undesirable. As a result, these Guidelines focus on stressors and adverse effects generated or influenced by anthropogenic activity. Defining adversity is important because a stressor may cause adverse effects on one ecosystem component but be neutral or even beneficial to other components. Changes often considered undesirable are those that alter important structural or functional characteristics or components of ecosystems. An evaluation of adversity may include a consideration of the type, intensity, and scale of the effect as well as the potential for recovery. The acceptability of adverse effects is determined by risk managers. Although intended to evaluate adverse effects, the ecological risk assessment process can be adapted to predict beneficial changes or risk from natural events.

Descriptions of the likelihood of adverse effects may range from qualitative judgments to quantitative probabilities. Although risk assessments may include quantitative risk estimates, quantitation of risks is not always possible. It is better to convey conclusions (and associated uncertainties) qualitatively than to ignore them because they are not easily understood or estimated.

Ecological risk assessments can be used to predict the likelihood of future adverse effects (prospective) or evaluate the likelihood that effects are caused by past exposure to stressors (retrospective). In many cases, both approaches are included in a single risk assessment. For example, a retrospective risk assessment designed to evaluate the cause for amphibian population declines may also be used to predict the effects of future management actions. Combined retrospective and prospective risk assessments are typical in situations where ecosystems have a history of previous impacts and the potential for future effects from multiple chemical, physical, or biological stressors. Other terminology related to ecological risk assessment is referenced in text box 1-1.

## 1.1. THE ECOLOGICAL RISK ASSESSMENT PROCESS

The ecological risk assessment process is based on two major elements: characterization of effects and characterization of exposure. These provide the focus for conducting the three phases of risk assessment: problem formulation, analysis, and risk characterization.

The overall ecological risk assessment process<sup>1</sup> is shown in figure 1-1. The format remains consistent with the diagram from the 1992 report *Framework for Ecological Risk Assessment* (referred to as the Framework Report). However, the process and products within each phase have been refined, and these changes are detailed in figure 1-2. The three phases of risk assessment are enclosed by a dark solid line. Boxes outside this line identify critical activities that influence why and how a risk assessment is conducted and how it will be used.

Problem formulation, the first phase, is shown at the top. In problem formulation, the purpose for the assessment is articulated, the problem is defined, and a plan for analyzing and characterizing risk is determined. Initial work in problem formulation includes the integration of available information on sources, stressors, effects, and ecosystem and receptor characteristics. From this information two products are generated: assessment endpoints and conceptual models. Either product may be generated first (the order depends on the type of risk assessment), but both are needed to complete an analysis plan, the final product of problem formulation.

Analysis, shown in the middle box, is directed by the products of problem formulation. During the analysis phase, data are evaluated to determine how exposure to stressors is likely to occur (characterization of exposure) and, given this exposure, the potential and type of ecological effects that can be expected (characterization of ecological effects). The first step in analysis is to determine the strengths and limitations of data on exposure, effects, and ecosystem and receptor characteristics. Data

### Text Box 1-1. Related Terminology

The following terms overlap to varying degrees with the concept of ecological risk assessment used in these Guidelines (see Appendix B for definitions):

- Hazard assessment
- Comparative risk assessment
- Cumulative ecological risk assessment
- Environmental impact statement

---

<sup>1</sup>Changes in process and terminology from EPA's previous ecological risk assessment framework (U.S. EPA, 1992a) are summarized in Appendix A.

are then analyzed to characterize the nature of potential or actual exposure and the ecological responses under the circumstances defined in the conceptual

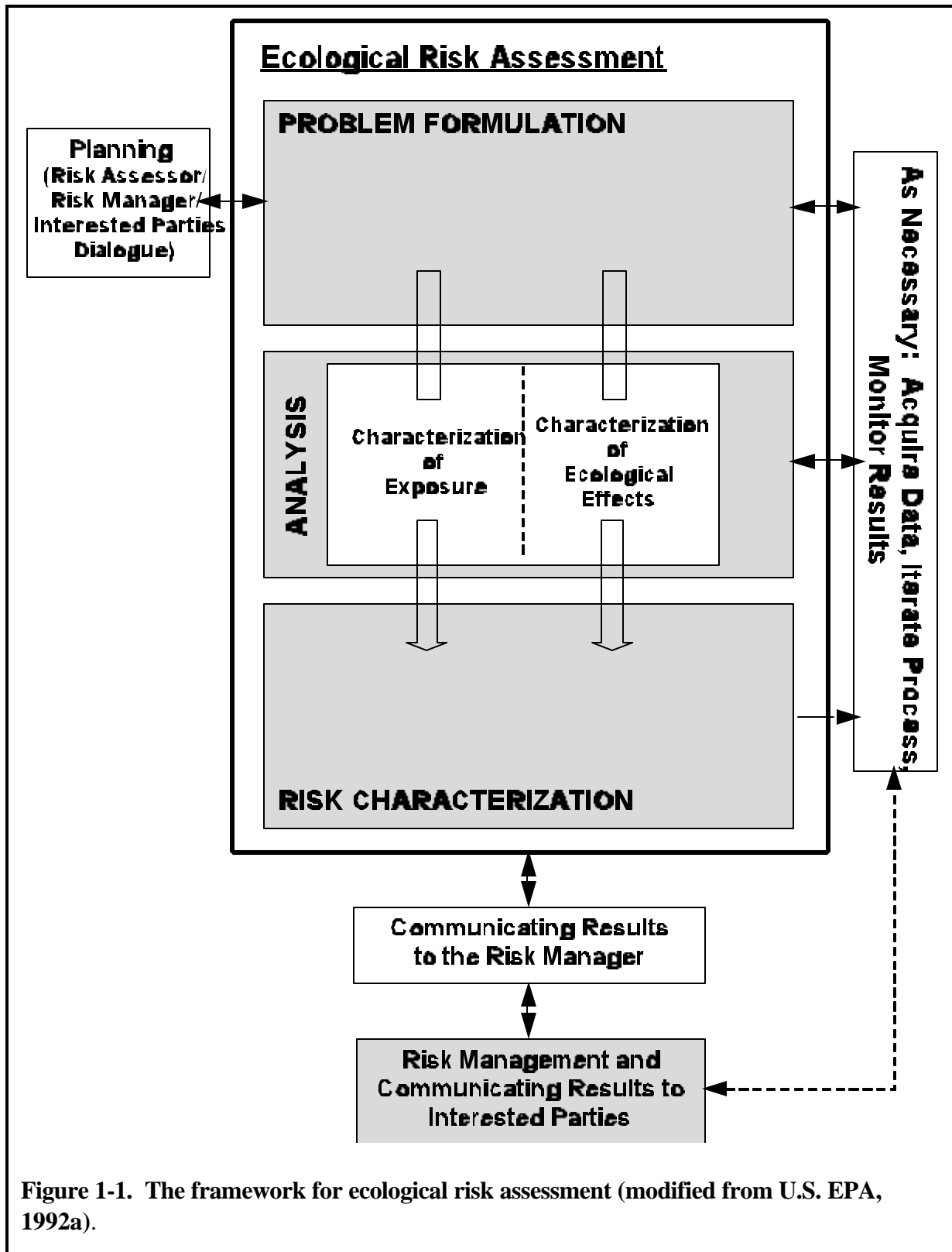

Figure 1-1. The framework for ecological risk assessment (modified from U.S. EPA, 1992a).

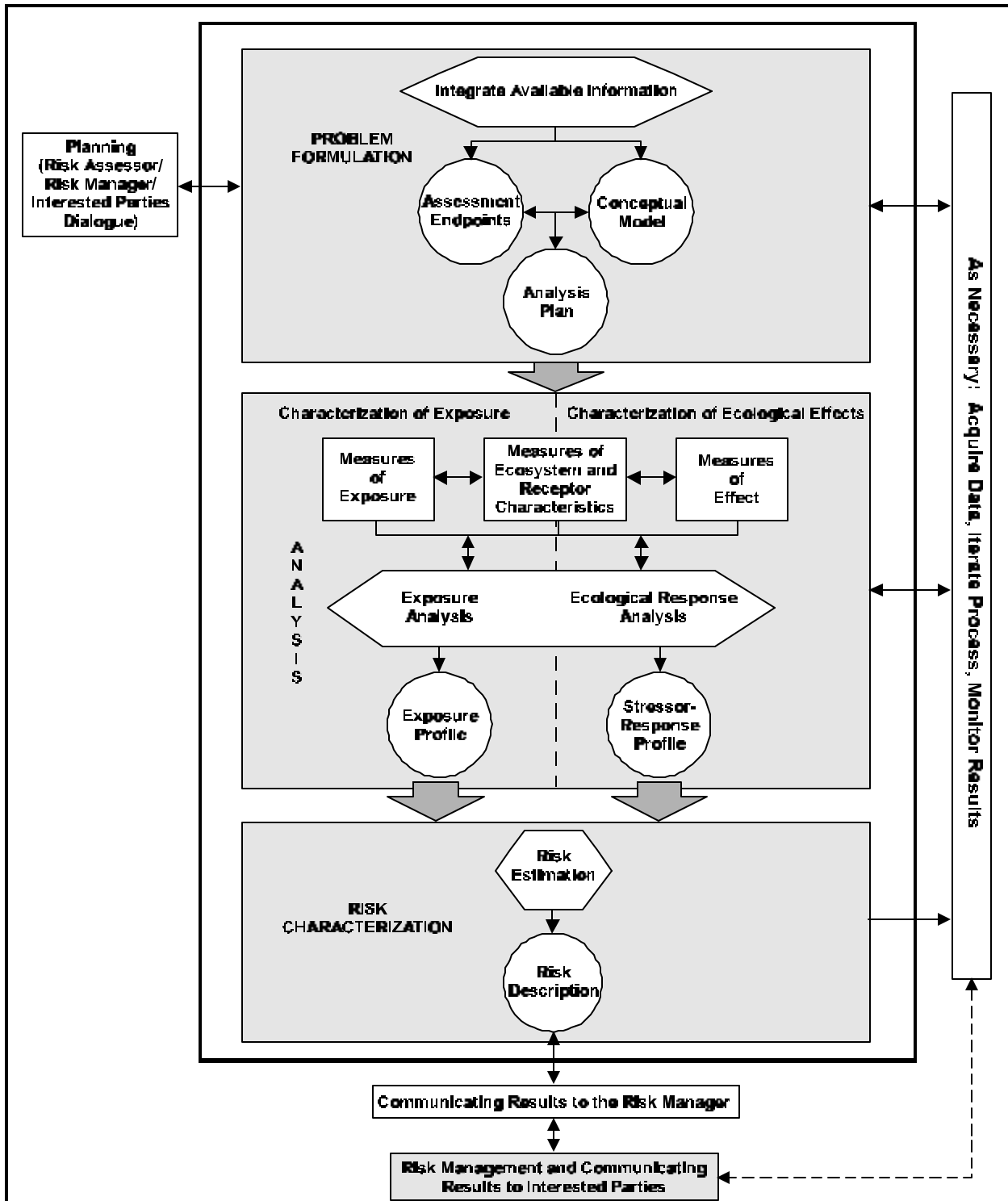

Figure 1-2. The ecological risk assessment framework, with an expanded view of each phase. Within each phase, rectangles designate inputs, hexagons indicate actions, and circles represent outputs. Problem formulation, analysis, and risk characterization are discussed in sections 3, 4, and 5, respectively. Sections 2 and 6 describe interactions between risk assessors and risk managers.

model(s). The products from these analyses are two profiles, one for exposure and one for stressor response. These products provide the basis for risk characterization.

During risk characterization, shown in the third box, the exposure and stressor-response profiles are integrated through the risk estimation process. Risk characterization includes a summary of assumptions, scientific uncertainties, and strengths and limitations of the analyses. The final product is a risk description in which the results of the integration are presented, including an interpretation of ecological adversity and descriptions of uncertainty and lines of evidence.

Although problem formulation, analysis, and risk characterization are presented sequentially, ecological risk assessments are frequently iterative. Something learned during analysis or risk characterization can lead to a reevaluation of problem formulation or new data collection and analysis (see text box 1-2).

Interactions among risk assessors, risk managers, and other interested parties are shown in two places in the diagram. The side box on the upper left represents planning, where agreements are made about the management goals, the purpose for the risk assessment, and the resources available to conduct the work. The box following risk characterization represents when the results of the risk assessment are formally communicated by risk assessors to risk managers. Risk managers generally communicate risk assessment results to interested parties. These activities are shown outside the ecological risk assessment process diagram to emphasize that risk assessment and risk management are two distinct activities. The former involves the evaluation of the likelihood of adverse effects, while the latter involves the selection of a course of action in response to an identified risk that is based on many factors (e.g., social, legal, political, or economic) in addition to the risk assessment results.

**Text Box 1-2. Flexibility of the Framework Diagram**

The framework process (figure 1-1) is a general representation of a complex and varied group of assessments. This diagram represents a flexible process, as illustrated by the examples below.

- In problem formulation, an assessment may begin with a consideration of endpoints, stressors, or ecological effects. Problem formulation is generally interactive and iterative, not linear.
- In the analysis phase, characterization of exposure and effects frequently become intertwined, as when an initial exposure leads to a cascade of additional exposures and secondary effects. The analysis phase should foster an understanding of these complex relationships.
- Analysis and risk characterization are shown as separate phases. However, some models may combine the analysis of exposure and effects data with the integration of these data that occurs in risk characterization.

The bar along the right side of figure 1-2 highlights data acquisition, iteration, and monitoring. Monitoring data provide important input to all phases of a risk assessment. They can provide the impetus for a risk assessment by identifying changes in ecological condition. They can also be used to evaluate a risk assessment's predictions. For example, follow-up studies could determine whether mitigation efforts were effective, help verify whether source reduction was effective, or determine the extent and nature of ecological recovery. It is important for risk assessors and risk managers to use monitoring results to evaluate risk assessment predictions so they can gain experience and help improve the risk assessment and risk management process (Commission on Risk Assessment and Risk Management, 1997).

Even though the risk assessment focuses on data analysis and interpretation, acquiring the appropriate quantity and quality of data for use in the process is critical. If data are unavailable, the risk assessment may stop until data are obtained. The process is more often iterative than linear, since the evaluation of new data or information may require revisiting a part of the process or conducting a new assessment (see text box 2-8). The dotted line between the side bar and the risk management box indicates that additional data acquisition, iteration, or monitoring, while important, are not always required.

## **1.2. ECOLOGICAL RISK ASSESSMENT IN A MANAGEMENT CONTEXT**

Ecological risk assessments are designed and conducted to provide information to risk managers about the potential adverse effects of different management decisions. Attempts to eliminate risks associated with human activities in the face of uncertainties and potentially high costs present a challenge to risk managers (Ruckelshaus, 1983; Suter, 1993a). Although many considerations and sources of information are used by managers in the decision process, ecological risk assessments are unique in providing a scientific evaluation of ecological risk that explicitly addresses uncertainty.

### **1.2.1. Contributions of Ecological Risk Assessment to Environmental Decision Making**

At EPA, ecological risk assessments are used to support many types of management actions, including the regulation of hazardous waste sites, industrial chemicals, and pesticides, or the management of watersheds or other ecosystems affected by multiple nonchemical and chemical stressors. The ecological risk assessment process has several features that contribute to effective environmental decision making:

- Through an iterative process, new information can be incorporated into risk assessments, which can be used to improve environmental decision making. This feature is consistent with adaptive management principles (Holling, 1978) used in managing natural resources.
- Risk assessments can be used to express changes in ecological effects as a function of changes in exposure to stressors. This capability may be particularly useful to the decision maker who must evaluate tradeoffs, examine different alternatives, or determine the extent to which stressors must be reduced to achieve a given outcome.
- Risk assessments explicitly evaluate uncertainty. Uncertainty analysis describes the degree of confidence in the assessment and can help the risk manager focus research on those areas that will lead to the greatest reductions in uncertainty.
- Risk assessments provide a basis for comparing, ranking, and prioritizing risks. The results can also be used in cost-benefit and cost-effectiveness analyses that offer additional interpretation of the effects of alternative management options.
- Risk assessments consider management goals and objectives as well as scientific issues in developing assessment endpoints and conceptual models during problem formulation. Such initial planning activities help ensure that results will be useful to risk managers.

### **1.2.2. Factors Affecting the Value of Ecological Risk Assessment for Environmental Decision Making**

The wide use and important advantages of ecological risk assessments do not mean they are the sole determinants of management decisions; risk managers consider many factors. Legal mandates and political, social, and economic considerations may lead risk managers to make decisions that are more or less protective. Reducing risk to the lowest level may be too expensive or not technically feasible. Thus, although ecological risk assessments provide critical information to risk managers, they are only part of the environmental decision-making process.

In some cases, it may be desirable to broaden the scope of a risk assessment during the planning phase. A risk assessment that is too narrowly focused on one type of stressor in a system (e.g., chemicals) could fail to consider more important stressors (e.g., habitat alteration). However,



options for modifying the scope of a risk assessment may be limited when the scope is defined by statute.

In other situations, management alternatives may be available that completely circumvent the need for a risk assessment. For example, the risks associated with building a hydroelectric dam may be avoided by considering alternatives for meeting power needs that do not involve a new dam. In these situations, the risk assessment may be redirected to assess the new alternative, or one may not be needed at all.

### **1.3. SCOPE AND INTENDED AUDIENCE**

These Guidelines describe general principles and give examples to show how ecological risk assessment can be applied to a wide range of systems, stressors, and biological, spatial, and temporal scales. They describe the strengths and limitations of alternative approaches and emphasize processes and approaches for analyzing data rather than specifying data collection techniques, methods, or models. They do not provide detailed guidance, nor are they prescriptive. This approach, although intended to promote consistency, provides flexibility to permit EPA's offices and regions to develop specific guidance suited to their needs.

Agency preferences are expressed where possible, but because ecological risk assessment is a rapidly evolving discipline, requirements for specific approaches could soon become outdated. EPA intends to develop a series of shorter, more detailed documents on specific ecological risk assessment topics following publication of these Guidelines.

The interface between risk assessors and risk managers is discussed in the Guidelines. However, details on the use of ecological risk assessment in the risk management process are beyond the scope of these Guidelines. Other EPA publications discuss how ecological concerns have been addressed in decision making at EPA (U.S. EPA, 1994a), propose ecological entities that may be important to protect (U.S. EPA, 1997a), and provide an introduction to ecological risk assessment for risk managers (U.S. EPA, 1995a).

Policies in this document are intended as internal guidance for EPA. Risk assessors and risk managers at EPA are the primary audience, although these Guidelines may be useful to others outside the Agency. This document is not a regulation and is not intended for EPA regulations. The Guidelines set forth current scientific thinking and approaches for conducting and evaluating ecological risk assessments. They are not intended, nor can they be relied upon, to create any rights enforceable by any party in litigation with the United States. As with other EPA guidelines (e.g., developmental

toxicity, 56 FR 63798-63826; exposure assessment, 57 FR 22888-22938; and carcinogenicity, 61 FR 17960-18011), EPA will revisit these Guidelines as experience and scientific consensus evolve.

These Guidelines replace the Framework Report (U.S. EPA, 1992a). They expand on and modify framework concepts to reflect Agency experience since the Framework Report was published (see Appendix A).

#### **1.4. GUIDELINES ORGANIZATION**

These Guidelines follow the ecological risk assessment format as presented in figures 1-1 and 1-2. Section 2 (planning) describes the dialogue among risk assessors, risk managers, and interested parties before the risk assessment begins. Section 3 (problem formulation) describes how management goals are interpreted, assessment endpoints selected, conceptual models constructed, and analysis plans developed. Section 4 (analysis) addresses how to evaluate potential exposure of receptors and the relationship between stressor levels and ecological effects. Section 5 (risk characterization) describes the process of estimating risk through the integration of exposure and stressor-response profiles and discusses lines of evidence, interpretation of adversity, and uncertainty. Finally, section 6 (on relating ecological information to risk management decisions) addresses communicating the results of the risk assessment to risk managers.

## 2. PLANNING THE RISK ASSESSMENT

Ecological risk assessments are conducted to transform scientific data into meaningful information about the risk of human activities to the environment. Their purpose is to enable risk managers to make informed environmental decisions. To ensure that risk assessments meet this need, risk managers and risk assessors (see text boxes 2-1 and 2-2) and, where appropriate, interested parties (see text box 2-3), engage in a planning dialogue as a critical first step toward initiating problem formulation (see figure 1-2).

The planning dialogue is the beginning of a necessary interface between risk managers and risk assessors. However, it is imperative to remember that planning remains distinct from the scientific conduct of a risk assessment. This distinction helps ensure that political and social issues, though helping define the objectives for the assessment, do not bias the scientific evaluation of risk.

The first step in planning may be to determine if a risk assessment is the best option for supporting the decision. Risk managers and risk assessors both consider the potential value of conducting a risk assessment to address identified problems. Their discussion explores what is known about the degree of risk, what management options are available to mitigate or prevent it, and the value of conducting a risk assessment compared with other ways of learning about and addressing environmental concerns. In some cases, a risk assessment may add little value to the decision process because management alternatives may be available that completely circumvent the need for a risk assessment (see section 1.2.2). In other cases, the need for a risk assessment may be investigated through a simple tiered risk evaluation based on minimal data and a simple model (see section 2.2.2).

### **Text Box 2-1. Who Are Risk Managers?**

Risk managers are individuals and organizations who have the responsibility, or have the authority to take action or require action, to mitigate an identified risk. The expression “risk manager” is often used to represent a decision maker in agencies such as EPA or State environmental offices who has legal authority to protect or manage a resource. However, risk managers may include a diverse group of interested parties who also have the ability to take action to reduce or mitigate risk. In situations where a complex of ecosystem values (e.g., watershed resources) is at risk from multiple stressors, and management will be implemented through community action, these groups may function as risk management teams. Risk management teams may include decision officials in Federal, State, local, and tribal governments; commercial, industrial, and private organizations; leaders of constituency groups; and other sectors of the public such as property owners. For additional insights on risk management and manager roles, see text boxes 2-3 and 2-4.

Once the decision is made to conduct a risk assessment, the next step is to ensure that all key participants are appropriately involved. Risk management may be carried out by one decision maker in an agency such as EPA or it may be implemented by several risk managers working together as a team (see text box 2-1). Likewise, risk assessment may be conducted by a single risk assessor or a team of risk assessors (see text box 2-2). In some cases, interested parties play an important role (see text box 2-3). Careful consideration up front about who will participate, and the character of that participation, will determine the success of planning.

#### **Text Box 2-2. Who Are Risk Assessors?**

Risk assessors are a diverse group of professionals who bring a needed expertise to a risk assessment team. When a specific risk assessment process is well defined through regulations and guidance, one trained individual may be able to complete a risk assessment given sufficient information (e.g., premanufacture notice of a chemical). However, for complex risk assessments, one individual can rarely provide the necessary breadth of expertise. Every risk assessment team should include at least one professional who is knowledgeable and experienced in using the risk assessment process. Other team members bring specific expertise relevant to the locations, stressors, ecosystems, scientific issues, and other expertise as needed, depending on the type of assessment.

### **2.1. THE ROLES OF RISK MANAGERS, RISK ASSESSORS, AND INTERESTED PARTIES IN PLANNING**

During the planning dialogue, risk managers and risk assessors each bring important perspectives to the table. Risk managers, charged with protecting human health and the environment, help ensure that risk assessments provide information relevant to their decisions by describing why the risk assessment is needed, what decisions it will influence, and what they want to receive from the risk assessor. It is also helpful for managers to consider and communicate problems they have encountered in the past when trying to use risk assessments for decision making.

In turn, risk assessors ensure that scientific information is effectively used to address ecological and management concerns. Risk assessors describe what they can provide to the risk manager, where problems are likely to occur, and where uncertainty may be problematic. In addition, risk assessors may provide insights to risk managers about alternative management options likely to achieve stated goals because the options are ecologically grounded.

In some risk assessments, interested parties also take an active role in planning, particularly in goal development. The National Research Council describes participation by interested parties in risk assessment as an iterative process of “analysis” and “deliberation” (NRC, 1996). Interested parties

may communicate their concerns to risk managers about the environment, economics, cultural changes, or other values potentially at risk from environmental management activities.

Where they have the ability to increase or mitigate risk to ecological values of concern that are identified, interested parties may become part of the risk management team (see text box 2-1). However, involvement by interested parties is not always needed or appropriate. It depends on the purpose of the risk assessment, the regulatory requirements, and the characteristics of the management problem (see section 2.2.1). When interested parties become risk managers on a team, they directly participate in planning.

During planning, risk managers and risk assessors are responsible for coming to agreement on the goals, scope, and timing of a risk assessment and the resources that are available and necessary to achieve the goals. Together they use information on the area's ecosystems, regulatory requirements, and publicly perceived environmental values to interpret the goals for use in the ecological risk assessment. Examples of questions that risk managers and risk assessors may address during planning are provided in text box 2-4.

## **2.2. PRODUCTS OF PLANNING**

The characteristics of an ecological risk assessment are directly determined by agreements reached by risk managers and risk assessors during planning dialogues. These

### **Text Box 2-3. Who Are Interested Parties?**

Interested parties (commonly called “stakeholders”) may include Federal, State, tribal, and municipal governments, industrial leaders, environmental groups, small-business owners, landowners, and other segments of society concerned about an environmental issue at hand or attempting to influence risk management decisions. Their involvement, particularly during management goal development, may be key to successful implementation of management plans since implementation is more likely to occur when backed by consensus. Large diverse groups may require trained facilitators and consensus-building techniques to reach agreement.

In some cases, interested parties may provide important information to risk assessors. Local knowledge, particularly in rural communities, and traditional knowledge of native peoples can provide valuable insights about ecological characteristics of a place, past conditions, and current changes. This knowledge should be considered when assessing available information during problem formulation (see section 3.2).

The context of involvement by interested parties can vary widely and may or may not be appropriate for a particular risk assessment. Interested parties may be limited to providing input to goal development, or they may become risk managers, depending on the degree to which they can take action to manage risk and the regulatory context of the decision. When and how interested parties influence risk assessments and risk management are areas of current discussion (NRC, 1996). See additional information in text box 2-1 and section 2.1.

agreements are the products of planning. They include (1) clearly established and

**Text Box 2-4. Questions Addressed by Risk Managers and Risk Assessors**

**Questions principally for risk managers to answer:**

- C What is the nature of the problem and the best scale for the assessment?
- C What are the management goals and decisions needed, and how will risk assessment help?
- C What are the ecological values (e.g., entities and ecosystem characteristics) of concern?
- C What are the policy considerations (law, corporate stewardship, societal concerns, environmental justice, intergenerational equity)?
- C What precedents are set by similar risk assessments and previous decisions?
- C What is the context of the assessment (e.g., industrial site, national park)?
- C What resources (e.g., personnel, time, money) are available?
- C What level of uncertainty is acceptable?

**Questions principally for risk assessors to answer:**

- C What is the scale of the risk assessment?
- C What are the critical ecological endpoints and ecosystem and receptor characteristics?
- C How likely is recovery, and how long will it take?
- C What is the nature of the problem: past, present, future?
- C What is our state of knowledge of the problem?
- C What data and data analyses are available and appropriate?
- C What are the potential constraints (e.g., limits on expertise, time, availability of methods and data)?

articulated management goals, (2) characterization of decisions to be made within the context of the management goals, and (3) agreement on the scope, complexity, and focus of the risk assessment, including the expected output and the technical and financial support available to complete it.

### 2.2.1. Management Goals

Management goals are statements about the desired condition of ecological values of concern. They may range from “maintain a sustainable aquatic community” (see text boxes 2-5 and 2-6) to “restore a wetland” or “prevent toxicity.” Management goals driving a specific risk assessment may come from the law, interpretations of the law by regulators, desired outcomes voiced by community leaders and the public, and interests expressed by affected parties. All involve input from the public. However, the process used to establish management goals influences how well they provide guidance to a risk assessment team, how they foster community participation, and whether the larger affected community will support implementation of management decisions to achieve the goal.

A majority of Agency risk assessments incorporate legally established management goals found in enabling legislation. In these cases, goals were derived through public debate among interested parties when the law was enacted. Such management goals (e.g., the Clean Water Act goals to “protect and restore the chemical, physical and biological integrity of the Nation’s waters”) are often open to considerable interpretation and rarely provide sufficient guidance to a risk assessor. To address this, the Agency has interpreted these goals into regulations and guidance for implementation at the national scale (e.g., water quality criteria, see text box 3-17). Mandated goals may be interpreted by Agency managers and staff into a particular risk assessment format and then applied consistently across stressors of the same type (e.g., evaluation of new chemicals). In cases where laws and regulations are specifically applied to a particular site,

#### **Text Box 2-5. Sustainability as a Management Goal**

To sustain is to keep in existence, maintain, or prolong. Sustainability is used as a management goal in a variety of settings (see U.S. EPA, 1995a). Sustainability and other concepts such as biotic or community integrity may be very useful as guiding principles for management goals. However, in each case these principles should be explicitly defined and interpreted for a place to support a risk assessment. To do this, key questions need to be addressed: What does sustainability or integrity mean for the particular ecosystem? What must be protected to meet sustainable goals or system integrity? Which ecological resources and processes are to be sustained and why? How will we know we have achieved it? Answers to these questions serve to clarify the goals for a particular ecosystem. Concepts like sustainability and integrity do not meet the criteria for an assessment endpoint (see section 3.3.2).

interaction between risk assessors and risk managers is needed to translate the law and regulations into management goals appropriate for the site or ecosystem of concern (e.g., Superfund site cleanup).

Although this approach has been effective, most regulations and guidance are stated in terms of measures or specific actions that must or must not be taken rather than establishing a



## **Text Box 2-6. Management Goals for Waquoit Bay**

A key challenge for risk assessors when dealing with a general management goal is interpreting the goal for a risk assessment. This can be done by generating a set of management objectives that represent what must be achieved in a particular ecosystem in order for the goal to be met. An example of this process was developed in the Waquoit Bay watershed risk assessment (U.S. EPA, 1996a).

Waquoit Bay is a small estuary on Cape Cod showing signs of degradation, including loss of eelgrass, fish, and shellfish and an increase in macroalgae mats and fish kills. The management goal for Waquoit Bay was established through public meetings, preexisting goals from local organizations, and State and Federal regulations:

Reestablish and maintain water quality and habitat conditions in Waquoit Bay and associated freshwater rivers and ponds to (1) support diverse self-sustaining commercial, recreational, and native fish and shellfish populations and (2) reverse ongoing degradation of ecological resources in the watershed.

To interpret this goal for the risk assessment, it was converted into 10 management objectives that defined what must be true in the watershed for the goal to be achieved and provide the foundation for management decisions. The management objectives are:

- Reduce or eliminate hypoxic or anoxic events
- Prevent toxic levels of contamination in water, sediments, and biota
- Restore and maintain self-sustaining native fish populations and their habitat
- Reestablish viable eelgrass beds and associated aquatic communities in the bay
- Reestablish a self-sustaining scallop population in the bay that can support a viable sport fishery
- Protect shellfish beds from bacterial contamination that results in closures
- Reduce or eliminate nuisance macroalgal growth
- Prevent eutrophication of rivers and ponds
- Maintain diversity of native biotic communities
- Maintain diversity of water-dependent wildlife

From these objectives, eight ecological entities and their attributes in the bay were selected as assessment endpoints (see section 3.3.2) to best represent the management goals and objectives, one of which is *areal extent and patch size of eelgrass beds*. Eelgrass was selected because (1) scallops and other benthic organisms and juvenile finfish depend directly on eelgrass beds for survival, (2) eelgrass is highly sensitive to excess macroalgal growth, and (3) abundant eelgrass represents a healthy bay to human users.

value-based management goal or desired state. As environmental protection efforts shift from implementing controls toward achieving measurable environmental results, value-based management goals at the national scale will be increasingly important as guidance for risk assessors. Such goals as “no unreasonable effects on bird survival” or “maintaining areal extent of wetlands” will provide a basis for risk assessment design (see also U.S. EPA, 1997a, for additional examples and discussion).

The “place-based” or “community-based” approach for managing ecological resources recommended in the Edgewater Consensus (U.S. EPA, 1994b) generally requires that management goals be developed for each assessment. Management goals for “places” such as watersheds are formed as a consensus based on diverse values reflected in Federal, State, tribal, and local regulations and on constituency-group and public concerns. Public meetings, constituency-group meetings, evaluation of resource management organizational charters, and other means of looking for shared goals may be necessary to reach consensus among these diverse groups, commonly called “stakeholders” (see text box 2-3). However, goals derived by consensus are normally general. For use in a risk assessment, risk assessors must interpret the goals into more specific objectives about what must occur in a place in order for the goal to be achieved and identify ecological values that can be measured or estimated in the ecosystem of concern (see text box 2-6). For these risk assessments, the interpretation is unique to the ecosystem being assessed and is done on a case-by-case basis as part of the planning process. Risk assessors and risk managers should agree on the interpretations.

Early discussion on and selection of clearly established management goals provide risk assessors with a fuller understanding of how different risk management options under consideration may result in achieving the goal. Such information helps the risk assessor identify and gather critical data and information. Regardless of how management goals are established, those that explicitly define ecological values to be protected provide the best foundation for identifying actions to reduce risk and generating risk assessment objectives. The objectives for the risk assessment derive from the type of management decisions to be made.

### **2.2.2. Management Options to Achieve Goals**

Risk managers must implement decisions to achieve management goals (see text box 2-7). These risk management decisions may establish national policy applied consistently across the country (e.g., premanufacture notices [PMN] for new chemicals, protection of endangered species) or be applied to a specific site (e.g., hazardous waste site cleanup level) or management concern (e.g., number of combined sewer overflow events allowable per year) intended to achieve an environmental goal when implemented. Management decisions often begin as one of

several management options identified during planning. Management options may range from preventing the introduction of a stressor to restoration of affected ecological values. When several options are defined during planning for a particular problem (e.g., leave alone, clean up, or pave a contaminated site), risk assessments can be used to predict potential risk across the range of these management options and, in some cases, combined with cost-benefit analyses to aid decision making. When risk assessors are made aware of possible options, they can use them to ensure that the risk assessment addresses a sufficient breadth of issues.

Explicitly stated management options provide a framework for defining the scope, focus, and conduct of a risk assessment. Some risk assessments are specifically designed to determine if a preestablished decision criterion is exceeded (e.g., see the data quality objectives process, U.S. EPA, 1994c, and section 3.5.2 for more details). Decision criteria often contain inherent assumptions about exposure, the range of possible stressors, or conditions under which the targeted stressor is operating. To ensure that decision options include appropriate assumptions and the risk assessment is designed to address management issues, these assumptions need to be clearly stated.

Decision criteria are often used within a tiering framework to determine how extensive a risk assessment should be. Early screening tiers may have predetermined decision criteria to answer whether a potential risk exists. Later tiers frequently do not because the management question changes from “yes-no” to questions of “what, where, and how great is the risk.” Results from these risk assessments require risk managers to evaluate risk characterization and generate a decision, perhaps through formal decision analysis (e.g., Clemen, 1996), or managers may request an iteration of the risk assessment to address issues of continuing concern (see text box 2-8).

Risk assessments designed to support management initiatives for a region or watershed where multiple stressors, ecological values, and political and economic factors influence decision making require great flexibility and more complex iterative risk assessments. They generally

**Text Box 2-7. What Is the Difference Between a Management Goal and Management Decision?**

Management goals are desired characteristics of ecological values that the public wants to protect. Clean water, protection of endangered species, maintenance of ecological integrity, clear mountain views, and fishing opportunities are all possible management goals. Management decisions determine the means to achieve the end goal. For instance, a goal may be “fishable, swimmable” waters. The management options under consideration to achieve that goal may include increasing enforcement of point-source discharges, restoring fish habitat, designing alternative sewage treatment facilities, or implementing all of the above.

### **Text Box 2-8. Tiers and Iteration: When Is a Risk Assessment Done?**

Risk assessments range from very simple to complex and resource demanding. How is it possible to decide the level of effort? How many times should the risk assessor revisit data and assessment issues? When is the risk assessment done?

Many of these questions can be addressed by designing a set of tiered assessments. These are preplanned and prescribed sets of risk assessments of progressive data and resource intensity. The outcome of a given tier is to either make a management decision, often based on decision criteria, or continue to the next level of effort. Many risk assessors and public and private organizations use this approach (e.g., see Gaudet, 1994; European Community, 1993; Cowan et al., 1995; Baker et al., 1994; Urban and Cook, 1986; Lynch et al., 1994).

An iteration is an unprescribed reevaluation of information that may occur at any time during a risk assessment, including tiered assessments. It is done in response to an identified need, new information, or questions raised while conducting an assessment. As such, iteration is a normal characteristic of risk assessments but is not a formal planned step. An iteration may include redoing the risk assessment with new assumptions and new data.

Setting up tiered assessments and decision criteria may reduce the need for iteration. Up-front planning and careful development of problem formulation will also reduce the need for revisiting data, assumptions, and models. However, there are no rules to dictate how many iterations will be necessary to answer management questions or ensure scientific validity. A risk assessment can be considered complete when risk managers have sufficient information and confidence in the results of the risk assessment to make a decision they can defend.

require an examination of ecological processes most influenced by diverse human actions. Risk assessments used in this application are often based on a general goal statement and multiple potential decisions. These require significant planning to determine which array of management decisions may be addressed and to establish the purpose, scope, and complexity of the risk assessment.

### **2.2.3. Scope and Complexity of the Risk Assessment**

Although the purpose for conducting a risk assessment determines whether it is national, regional, or local in scope, resource availability determines its extent, complexity, and the level of confidence in results that can be expected. Each risk assessment is constrained by the availability of valid data and scientific understanding, expertise, time, and financial resources.

Risk managers and risk assessors consider the nature of the decision (e.g., national policy, local impact), available resources, opportunities for increasing the resource base (e.g., partnering, new data

collection, alternative analytical tools), potential characteristics of the risk assessment team, and the output that will provide the best information for the required decisions (see text box 2-9). They must often be flexible in determining what level of effort is warranted for a risk assessment. The most detailed assessment process is neither applicable nor necessary in every instance. Screening assessments may be the appropriate level of effort. One approach for determining the needed level of effort in the risk assessment is to set up tiered evaluations, as discussed in section 2.2.2. Where tiers are used, specific descriptions of management questions and decision criteria should be included in the plan.

Part of the agreement on scope and complexity is based on the maximum uncertainty that can be tolerated for the decision the risk assessment supports. Risk assessments completed in response to legal mandates and likely to be challenged in court often require rigorous attention to potential sources of uncertainty to help ensure that conclusions from the assessment can be defended. A frank discussion is needed between the risk manager and risk assessor on the sources of uncertainty and ways uncertainty can be reduced (if necessary or possible) through selective investment of resources. Resource planning may account for the iterative nature of risk assessment or include explicitly defined steps, such as tiers that represent increasing cost and complexity, each tier designed to increase understanding and reduce uncertainty. Advice on addressing the interplay of management decisions, study boundaries, data needs, uncertainty, and specifying limits on decision errors may be found in EPA's guidance on data quality objectives (U.S. EPA, 1994c).

### 2.3. PLANNING SUMMARY

The planning phase is complete when agreements are reached on (1) the management goals for ecological values, (2) the range of management options the risk assessment is to support, (3) objectives

#### **Text Box 2-9. Questions to Ask About Scope and Complexity**

- C Is this risk assessment mandated, required by a court decision, or providing guidance to a community?
- C Will decisions be based on assessments of a small area evaluated in depth or a large-scale area in less detail?
- C What are the spatial and temporal boundaries of the problem?
- C What information is already available compared to what is needed?
- C How much time can be taken, and how many resources are available?
- C What practicalities constrain data collection?
- C Is a tiered approach an option?

for the risk assessment, including criteria for success, (4) the focus and scope of the assessment, and (5) resource availability. Agreements may encompass the technical approach to be taken in a risk assessment as determined by the regulatory or management context and reason for initiating the risk assessment (see section 3.2), the spatial scale (e.g., local, regional, or national), and the temporal scale (e.g., the time frame over which stressors or effects will be evaluated).

In mandated risk assessments, planning agreements may be codified in regulations, and little documentation of agreements is warranted. In others, a summary of planning agreements may be important for ensuring that the risk assessment remains consistent with its original intent. A summary can provide a point of reference for determining if early decisions need to be changed in response to new information. There is no predetermined format, length, or complexity for a planning summary. It is a useful reference only and should be tailored to the risk assessment it represents. However, a summary will help ensure quality communication between risk managers and risk assessors and will document agreed-upon decisions.

Once planning is complete, the formal process of risk assessment begins. During problem formulation, risk assessors should continue the dialogue with risk managers, particularly following assessment endpoint selection and completion of the analysis plan. At these points, potential problems can be identified before the risk assessment proceeds.

### 3. PROBLEM FORMULATION PHASE

Problem formulation is a process for generating and evaluating preliminary hypotheses about why ecological effects have occurred, or may occur, from human activities. It provides the foundation for the entire ecological risk assessment. Early in problem formulation, objectives for the risk assessment are refined. Then the nature of the problem is evaluated and a plan for analyzing data and characterizing risk is developed. Any deficiencies in problem formulation will compromise all subsequent work on the risk assessment (see text box 3-1). The quality of the assessment will depend in part on the team conducting the assessment and its responsiveness to the risk manager's needs.

#### **Text Box 3-1. Avoiding Potential Shortcomings Through Problem Formulation**

The importance of problem formulation has been shown repeatedly in the Agency's analysis of ecological risk assessment case studies and in interactions with senior EPA managers and regional risk assessors (U.S. EPA, 1993a, 1994d). Shortcomings consistently identified in the case studies include (1) absence of clearly defined goals, (2) endpoints that are ambiguous and difficult to define and measure, and (3) failure to identify important risks. These and other shortcomings can be avoided through rigorous development of the products of problem formulation as described in this section of the Guidelines.

The makeup of the risk assessment team assembled to conduct problem formulation depends on the requirements of the risk assessment. The team should include professionals with expertise directly related to the level and type of problem under consideration and the ecosystem where the problem is likely to occur. Teams may range from one individual calculating a simple quotient where the information and algorithm are clearly established to a large interdisciplinary, interagency team typical of ecosystem-level risk assessments involving multiple stressors and ecological values.

Involvement by the risk management team and other interested parties in problem formulation can be most valuable during final selection of assessment endpoints, review of the conceptual models, and adjustments to the analysis plan. The degree of participation is commensurate with the complexity of the risk assessment and the magnitude of the risk management decision to be faced. Participation normally consists of approval and refinement rather than technical input (but see text box 2-3). The format used to involve risk managers needs to gain from, and be responsive to, their input without compromising the scientific validity of the risk assessment. The level of involvement by interested parties in problem formulation is determined by risk managers.

### **3.1. PRODUCTS OF PROBLEM FORMULATION**

Problem formulation results in three products: (1) assessment endpoints that adequately reflect management goals and the ecosystem they represent, (2) conceptual models that describe key relationships between a stressor and assessment endpoint or between several stressors and assessment endpoints, and (3) an analysis plan. The first step toward developing these products is to integrate available information as shown in the hexagon in figure 3-1; the products are shown as circles. While the assessment of available information is begun up front in problem formulation and the analysis plan is the final product, the order in which assessment endpoints and conceptual models are produced depends on why the risk assessment was initiated (see section 3.2). To enhance clarity, the following discussion is presented as a linear progression. However, problem formulation is frequently interactive and iterative rather than linear. Reevaluation may occur during any part of problem formulation.

### **3.2. INTEGRATION OF AVAILABLE INFORMATION**

The foundation for problem formulation is based on how well available information on stressor sources and characteristics, exposure opportunities, characteristics of the ecosystem(s) potentially at risk, and ecological effects are integrated and used (see figure 3-1). Integration of available information is an iterative process that normally occurs throughout problem formulation. Initial evaluations often provide the basis for generating preliminary conceptual models or assessment endpoints, which in turn may lead risk assessors to seek other types of available information not previously recognized as needed.

The quality and quantity of information determine the course of problem formulation. When key information is of the appropriate type and sufficient quality and quantity, problem formulation can proceed effectively. When data are unavailable, the risk assessment may be suspended while additional data are collected or, if this is not possible, may be developed on the basis of what is known and what can be extrapolated from what is known. Risk assessments are frequently begun without all needed information, in which case the problem formulation process helps identify missing data and provides a framework for further data collection. Where data are few, the limitations of conclusions, or uncertainty, from the risk assessment should be clearly articulated in risk characterization (see text box 3-2).

The impetus for an ecological risk assessment influences what information is available at the outset and what information should be collected. For example, a risk assessment can be initiated because a known or potential stressor may enter the environment. Risk assessors



evaluating a source or stressor will seek data on the effects with which the stressor might be associated and the ecosystems in which it will likely be introduced or found. If an observed

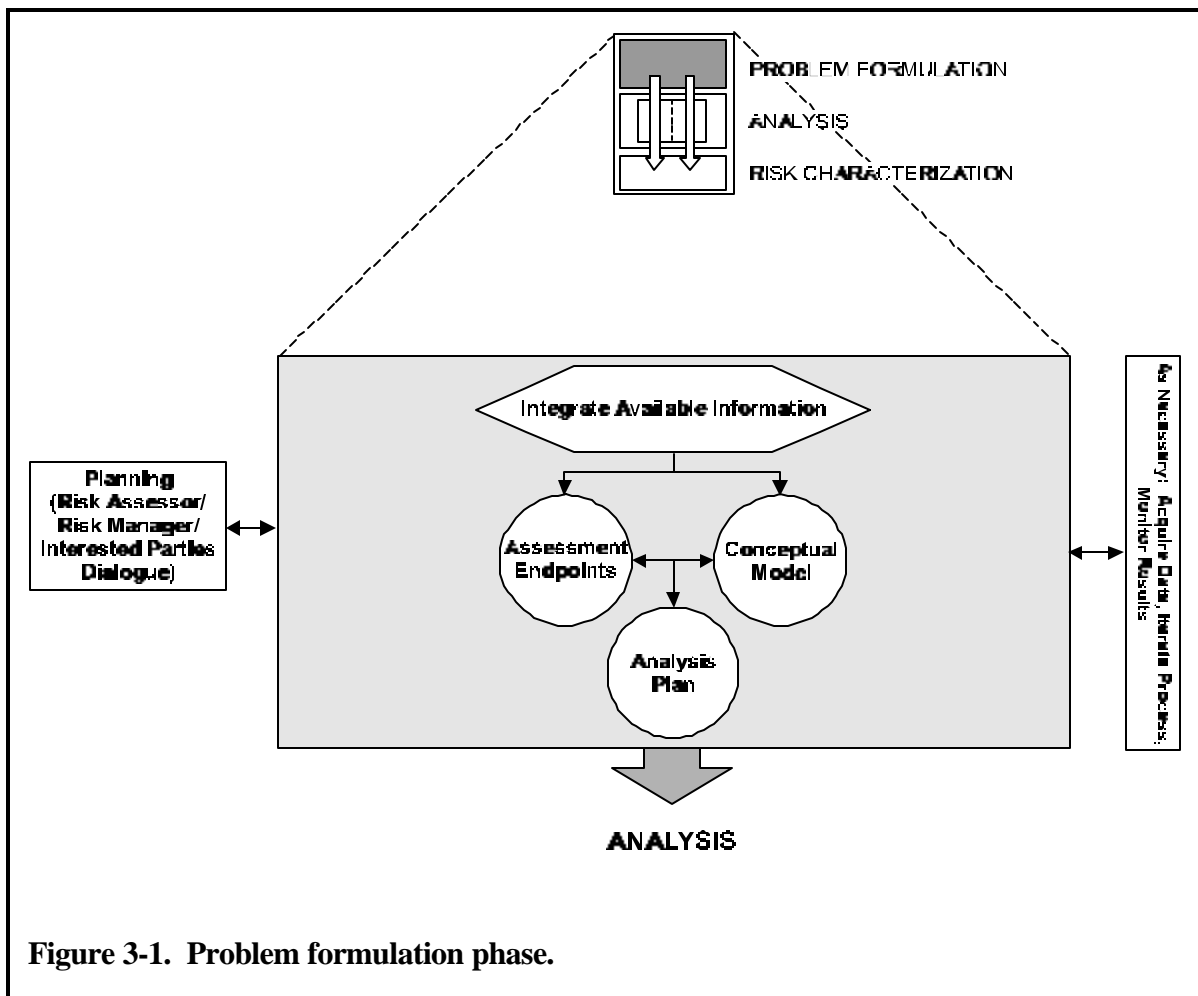

adverse effect or change in ecological condition initiates the assessment, risk assessors will seek information about potential stressors and sources that could have caused the effect. When a risk assessment is initiated because of a desire to better manage an ecological value or entity (e.g., species, communities, ecosystems, or places), risk assessors will seek information on the specific condition or effect of interest, the characteristics of relevant ecosystems, and potential stressors and sources (see text box 3-3).

Information (actual, inferred, or estimated) is initially integrated in a scoping process that provides the foundation for developing problem formulation. Knowledge

**Text Box 3-2. Uncertainty in Problem Formulation**

Throughout problem formulation, risk assessors consider what is known and not known about a problem and its setting. Each product of problem formulation contains uncertainty. The explicit treatment of uncertainty during problem formulation is particularly important because it will have repercussions throughout the remainder of the assessment. Uncertainty is discussed in section 3.4 (Conceptual Models).

### **Text Box 3-3. Initiating a Risk Assessment: What's Different When Stressors, Effects, or Values Drive the Process?**

The reasons for initiating a risk assessment influence when risk assessors generate products in problem formulation. When the assessment is initiated because of concerns about stressors, risk assessors use what is known about the stressor and its source to focus the assessment. Objectives for the assessment are based on determining how the stressor is likely to come in contact with and affect possible receptors. This information forms the basis for developing conceptual models and selecting assessment endpoints. When an observed effect is the basis for initiating the assessment, endpoints are normally established first. Frequently, the affected ecological entities and their response form the basis for defining assessment endpoints. Goals for protecting the assessment endpoints are then established, which support the development of conceptual models. The models aid in the identification of the most likely stressor(s). Value-initiated risk assessments are driven by goals for the ecological values of concern. These values might involve ecological entities such as species, communities, ecosystems, or places. Based on these goals, assessment endpoints are selected first to serve as an interpretation of the goals. Once selected, the endpoints provide the basis for identifying an array of stressors that may be influencing the assessment endpoints and describing the diversity of potential effects. This information is then captured in the conceptual model(s).

gained during scoping is used to identify missing information and potential assessment endpoints, and it provides the basis for early conceptualization of the problem being assessed. As problem formulation proceeds, information quality and applicability to the particular problem of concern are increasingly scrutinized. Where appropriate, further iterations may result in a comprehensive evaluation that helps risk assessors generate an array of risk hypotheses (see section 3.4.1). Once analysis plans are being formed, data validity becomes a significant factor for risk assessors to evaluate (see section 4.1 for a discussion of assessing data quality). Thus an evaluation of available information is an ongoing activity throughout problem formulation. The level of effort is driven by the type of assessment.

As the complexity and spatial scale of a risk assessment increase, information needs often escalate. Risk assessors consider the ways ecosystem characteristics directly influence when, how, and why particular ecological entities may become exposed and exhibit adverse effects due to particular stressors. Predicting risks from multiple chemical, physical, and biological stressors requires an effort to understand their interactions. Risk assessments for a region or watershed, where multiple stressors are the rule, require consideration of ecological processes operating at larger spatial scales.

Despite our limited knowledge of ecosystems and the stressors influencing them, the process of problem formulation offers a systematic approach for organizing and evaluating available information on stressors and possible effects. It can function as a preliminary risk assessment that is useful to risk

assessors and decision makers. Text box 3-4 provides a series of questions that risk assessors should attempt to answer. This exercise will help risk assessors identify known and unknown relationships, both of which are important in problem formulation.

Problem formulation proceeds with the identification of assessment endpoints and the development of conceptual models and an analysis plan (discussed below). Early recognition that the reasons for initiating the risk assessment affect the order in which products are generated will help facilitate the development of problem formulation (see text box 3-3).

### **3.3. SELECTING ASSESSMENT ENDPOINTS**

Assessment endpoints are explicit expressions of the actual environmental value that is to be protected, operationally defined by an ecological entity and its attributes (see section 3.3.2). Assessment endpoints are critical to problem formulation because they structure the assessment to address management concerns and are central to conceptual model development. Their relevance is determined by how well they target susceptible ecological entities. Their ability to support risk management decisions depends on whether they are measurable ecosystem characteristics that adequately represent management goals. The selection of ecological concerns and assessment endpoints at EPA has traditionally been done internally by individual Agency program offices (U.S. EPA, 1994a). More recently, interested and affected parties have helped identify management concerns and assessment endpoints in efforts to implement watershed or community-based environmental protection.

This section provides guidance on selecting and defining assessment endpoints. It is presented in two parts. Section 3.3.1 establishes three criteria (ecological relevance, susceptibility, and relevance to management goals) for determining how to select, among a broad array of possibilities, the specific ecological characteristics to target in the risk assessment that are responsive to general management goals and are scientifically defensible. Section 3.3.2 then provides specific guidance on how to convert selected ecological characteristics into operationally defined assessment endpoints that include both a defined entity and specific attributes amenable to measurement.

#### **3.3.1. Criteria for Selection**

All ecosystems are diverse, with many levels of ecological organization (e.g., individuals, populations, communities, ecosystems, landscapes) and multiple ecosystem processes. It is rarely clear which of these characteristics are most critical to ecosystem function, nor do professionals or the public always agree on which are most valuable. As a result, it is often a

**Text Box 3-4. Assessing Available Information: Questions to Ask Concerning Source, Stressor, and Exposure Characteristics, Ecosystem Characteristics, and Effects** (derived in part from Barnhouse and Brown, 1994)

**Source and Stressor Characteristics**

- What is the source? Is it anthropogenic, natural, point source, or diffuse nonpoint?
- What type of stressor is it: chemical, physical, or biological?
- What is the intensity of the stressor (e.g., the dose or concentration of a chemical, the magnitude or extent of physical disruption, the density or population size of a biological stressor)?
- What is the mode of action? How does the stressor act on organisms or ecosystem functions?

**Exposure Characteristics**

- With what frequency does a stressor event occur (e.g., is it isolated, episodic, or continuous; is it subject to natural daily, seasonal, or annual periodicity)?
- What is its duration? How long does it persist in the environment (e.g., for chemical, what is its half-life, does it bioaccumulate; for physical, is habitat alteration sufficient to prevent recovery; for biological, will it reproduce and proliferate)?
- What is the timing of exposure? When does it occur in relation to critical organism life cycles or ecosystem events (e.g., reproduction, lake overturn)?
- What is the spatial scale of exposure? Is the extent or influence of the stressor local, regional, global, habitat-specific, or ecosystemwide?
- What is the distribution? How does the stressor move through the environment (e.g., for chemical, fate and transport; for physical, movement of physical structures; for biological, life-history dispersal characteristics)?

**Ecosystems Potentially at Risk**

- What are the geographic boundaries? How do they relate to functional characteristics of the ecosystem?
- What are the key abiotic factors influencing the ecosystem (e.g., climatic factors, geology, hydrology, soil type, water quality)?
- Where and how are functional characteristics driving the ecosystem (e.g., energy source and processing, nutrient cycling)?
- What are the structural characteristics of the ecosystem (e.g., species number and abundance, trophic relationships)?
- What habitat types are present?
- How do these characteristics influence the susceptibility (sensitivity and likelihood of exposure) of the ecosystem to the stressor(s)?
- Are there unique features that are particularly valued (e.g., the last representative of an ecosystem type)?
- What is the landscape context within which the ecosystem occurs?

**Ecological Effects**

- What are the type and extent of available ecological effects information (e.g., field surveys, laboratory tests, or structure-activity relationships)?
- Given the nature of the stressor (if known), which effects are expected to be elicited by the stressor?
- Under what circumstances will effects occur?

challenge to consider the array of possibilities and choose which ecological characteristics to protect to meet management goals. Those choices are critical, however, because they become the basis for defining assessment endpoints, the transition between broad management goals and the specific measures used in a risk assessment.

Three principal criteria are used to select ecological values that may be appropriate for assessment endpoints: (1) ecological relevance, (2) susceptibility to known or potential stressors, and (3) relevance to management goals. Of these, ecological relevance and susceptibility are essential for selecting assessment endpoints that are scientifically defensible. However, to increase the likelihood that the risk assessment will be used in management decisions, assessment endpoints are more effective when they also reflect societal values and management goals. Given the complex functioning of ecosystems and the interdependence of ecological entities, it is likely that potential assessment endpoints can be identified that are both responsive to management goals and meet scientific criteria. Assessment endpoints that meet all three criteria provide the best foundation for an effective risk assessment (e.g., see text box 3-5).

#### **3.3.1.1. *Ecological Relevance***

Ecologically relevant endpoints reflect important characteristics of the system and are functionally related to other endpoints (U.S. EPA, 1992a). Ecologically relevant endpoints may be identified at any level of organization (e.g., individual, population, community, ecosystem, landscape). The consequences of changes in these endpoints may be quantified (e.g., alteration of community structure from the loss of a keystone

#### **Text Box 3-5. Salmon and Hydropower: Salmon as the Basis for an Assessment Endpoint**

A hydroelectric dam is to be built on a river in the Pacific Northwest where anadromous fish such as salmon spawn. Assessment endpoints should be selected to assess potential ecological risk. Of the anadromous fish, salmon that spawn in the river are an appropriate choice because they meet the criteria for good assessment endpoints. Salmon fry and adults are important food sources for a multitude of aquatic and terrestrial species and are major predators of aquatic invertebrates (ecological relevance). Salmon are sensitive to changes in sedimentation and substrate pebble size, require quality cold-water habitats, and have difficulty climbing fish ladders. Hydroelectric dams represent significant, and normally fatal, habitat alteration and physical obstacles to successful salmon breeding and fry survival (susceptibility). Finally, salmon support a large commercial fishery, some species are endangered, and they have ceremonial importance and are key food sources for Native Americans (relevance to management goals). “Salmon reproduction and population recruitment” is a good assessment endpoint for this risk assessment. In addition, if salmon populations are protected, other anadromous fish populations are likely to be protected as well. However, one assessment endpoint can rarely provide the basis for a risk assessment of complex ecosystems. These are better represented by a set of assessment endpoints.

species) or inferred (e.g., survival of individuals is needed to maintain populations). Ecological entities are not ecologically relevant unless they are currently, or were historically, part of the ecosystem under consideration.

Ecologically relevant endpoints often help sustain the natural structure, function, and biodiversity of an ecosystem or its components. They may contribute to the food base (e.g., primary production), provide habitat (e.g., for food or reproduction), promote regeneration of critical resources (e.g., decomposition or nutrient cycling), or reflect the structure of the community, ecosystem, or landscape (e.g., species diversity or habitat mosaic). In landscape-level risk assessments, careful selection of assessment endpoints that address both species of concern and landscape-level ecosystem processes becomes important. It may be possible to select one or more species and an ecosystem process to represent larger functional community or ecosystem processes.

Ecological relevance is linked to the nature and intensity of potential effects, the spatial and temporal scales where effects may occur, and the potential for recovery (see Determining Ecological Adversity, section 5.2.2). It is also linked to the level of ecological organization that could be adversely affected (see U.S. EPA, 1997a, for a discussion of how different levels of organization are used by the Agency in defining assessment endpoints). When changes in selected ecosystem entities are likely to cause multiple or widespread effects, such entities can be powerful components of assessment endpoints. They are particularly valuable when risk assessors are trying to identify the potential cascade of adverse effects that could result from loss or reduction of a species or a change in ecosystem function (see text box 3-6). Although a cascade of effects may be predictable, it is often difficult to predict the nature of all potential effects. Determining ecological relevance in specific cases requires

**Text Box 3-6. Cascading Adverse Effects: Primary (Direct) and Secondary (Indirect)**

The interrelationships among entities and processes in ecosystems foster a potential for cascading effects: as one population, species, process, or other entity in the ecosystem is altered, other entities are affected as well. Primary, or direct, effects occur when a stressor acts directly on the assessment endpoint and causes an adverse response. Secondary, or indirect, effects occur when the entity's response becomes a stressor to another entity. Secondary effects are often a series of effects among a diversity of organisms and processes that cascade through the ecosystem. For example, application of an herbicide on a wet meadow results in direct toxicity to plants. Death of the wetland plants leads to secondary effects such as loss of feeding habitat for ducks, breeding habitat for red-winged blackbirds, alteration of wetland hydrology that changes spawning habitat for fish, and so forth.

professional judgment based on site-specific information, preliminary surveys, or other available information.

### **3.3.1.2. *Susceptibility to Known or Potential Stressors***

Ecological resources are considered susceptible when they are sensitive to a stressor to which they are, or may be, exposed. Susceptibility can often be identified early in problem formulation, but not always. Risk assessors may be required to use their best professional judgment to select the most likely candidates (see text box 3-7).

Sensitivity refers to how readily an ecological entity is affected by a particular stressor. Sensitivity is directly related to the mode of action of the stressors (e.g., chemical sensitivity is influenced by individual physiology and metabolic pathways). Sensitivity is also influenced by individual and community life-history characteristics. For example, stream species assemblages that depend on cobble and gravel habitat for reproduction are sensitive to fine sediments that fill in spaces between cobbles. Species with long life cycles and low reproductive rates are often more vulnerable to extinction from increases in mortality than species with short life cycles and high reproductive rates. Species with large home ranges may be more sensitive to habitat fragmentation when the fragment is smaller than their required home range compared to species with smaller home ranges that are encompassed within a fragment. However, habitat fragmentation may also affect species with small home ranges where migration is a necessary part of their life history and fragmentation prevents migration and genetic exchange among

#### **Text Box 3-7. Identifying Susceptibility**

Often it is possible to identify ecological entities most likely to be susceptible to a stressor. However, in some cases where stressors are not known at the initiation of a risk assessment, or specific effects have not been identified, the most susceptible entities may not be known. Where this occurs, professional judgment may be required to make initial selections of potential endpoints.

Once done, available information on potential stressors in the system can be evaluated to determine which of the endpoints are most likely susceptible to identified stressors. If an assessment endpoint is selected for a risk assessment that directly supports management goals and is ultimately found not susceptible to stressors in the system, then a conclusion of no risk is appropriate. However, where there are multiple possible assessment endpoints that address management goals and only some of those are susceptible to a stressor, the susceptible endpoints should be selected. If the susceptible endpoints are not initially selected for an assessment, an additional iteration of the risk assessment with alternative assessment endpoints may be needed to determine risk.



subpopulations. Such life-history characteristics are important to consider when evaluating potential sensitivity.

Sensitivity can be related to the life stage of an organism when exposed to a stressor. Frequently, young animals are more sensitive to stressors than adults. For instance, Pacific salmon eggs and fry are very sensitive to fine-grain sedimentation in river beds because they can be smothered. Age-dependent sensitivity, however, is not only in the young. In many species, events like migration (e.g., in birds) and molting (e.g., in harbor seals) represent significant energy investments that increase vulnerability to stressors. Finally, sensitivity may be enhanced by the presence of other stressors or natural disturbances. For example, the presence of insect pests and disease may make plants more sensitive to damage from ozone (Heck, 1993). To determine how sensitivity at a particular life stage is critical to population parameters or community-level assessment endpoints may require further evaluation.

Measures of sensitivity may include mortality or adverse reproductive effects from exposure to toxics. Other possible measures of sensitivity include behavioral abnormalities; avoidance of significant food sources and nesting sites; loss of offspring to predation because of the proximity of stressors such as noise, habitat alteration, or loss; community structural changes; or other factors.

Exposure is the second key determinant in susceptibility. Exposure can mean co-occurrence, contact, or the absence of contact, depending on the stressor and assessment endpoint. Questions concerning where a stressor originates, how it moves through the environment, and how it comes in contact with the assessment endpoint are evaluated to determine susceptibility (see section 4.2 for more discussion on characterizing exposure). The amount and conditions of exposure directly influence how an ecological entity will respond to a stressor. Thus, to determine which entities are susceptible, it is important that the assessor consider the proximity of an ecological value to stressors of concern, the timing of exposure (both in terms of frequency and duration), and the intensity of exposure occurring during sensitive periods.

Adverse effects of a particular stressor may be important during one part of an organism's life cycle, such as early development or reproduction. They may result from exposure to a stressor or to the absence of a necessary resource during a critical life stage. For example, if fish are unable to find suitable nesting sites during their reproductive phase, risk is significant even when water quality is high and food sources abundant. The interplay between life stage and stressors can be very complex (see text box 3-8).

Exposure may occur in one place or time, but effects may not be observed until another place or time. Both life-history characteristics and the circumstances of exposure influence susceptibility in

this case. For instance, the temperature of the egg incubation medium of marine turtles affects the sex ratio of hatchlings, but population impacts are not observed until years later when the cohort of affected turtles begins to reproduce. Delayed effects and multiple-stressor exposures add complexity to evaluations of susceptibility (e.g., although toxicity tests may determine receptor sensitivity to one stressor, susceptibility may depend on the co-occurrence of another stressor that significantly alters receptor response). Conceptual models (see section 3.4) need to reflect these factors. If a species or other ecological entity is unlikely to be directly or indirectly exposed to the stressor of concern, or to the secondary effects of stressor exposure, it may be inappropriate as an assessment endpoint (see text box 3-7).

### **3.3.1.3. *Relevance to Management Goals***

Ultimately, the effectiveness of a risk assessment depends on whether it is used and improves the quality of management decisions. Risk managers are more willing to use a risk assessment for making decisions when it is based on ecological values that people care about.

Thus, candidates for assessment endpoints include endangered species or ecosystems, commercially or recreationally important species, functional attributes that support food sources or flood control (e.g., wetland water sequestration), aesthetic values such as clean air in national parks, or the existence of charismatic species such as eagles or whales. However, selection of assessment endpoints based on public perceptions alone could lead to management decisions that do not consider important ecological information. While responsiveness to the public is important, it does not obviate the requirement for scientific validity.

The challenge is to find ecological values that meet the necessary scientific rigor as assessment endpoints that are also recognized as valuable by risk managers and the public. As an illustration, suppose an assessment is designed to evaluate the risk of applying pesticide around a lake to control insects. At this lake, however, midges are susceptible to the pesticide and form the base of a complex

#### **Text Box 3-8. Sensitivity and Secondary Effects: The Mussel-Fish Connection**

Native freshwater mussels are endangered in many streams. Management efforts have focused on maintaining suitable habitat for mussels because habitat loss has been considered the greatest threat to this group. However, larval unionid mussels must attach to the gills of a fish host for one month during development. Each species of mussel must attach to a particular host species of fish. In situations where the fish community has been changed, perhaps due to stressors to which mussels are insensitive, the host fish may no longer be available. Mussel larvae will die before reaching maturity as a result. Regardless of how well managers restore mussel habitat, mussels will be lost from this system unless the fish community is restored. In this case, risk is caused by the absence of exposure to a critical resource.

food web that supports a native fish population popular with sportsmen. While both midges and fish represent key components of the aquatic community, selecting the fishery as the value for defining the assessment endpoint targets both ecological and community concerns. Selecting midges would not. The risk assessment can then characterize the risk to the fishery if the midge population is adversely affected. This choice maintains the scientific validity of the risk assessment while being responsive to management concerns. In those cases where a critical assessment endpoint is identified that is unpopular with the public, the risk assessor may find it necessary to present a persuasive case in its favor to risk managers based on scientific arguments.

Practical issues may influence what values are selected as potential assessment endpoints, such as what is required by statute (e.g., endangered species) or whether it is possible to achieve a particular management goal. For example, in a river already impounded throughout its reach by multiple dams, goals for reestablishing spawning habitat for free-living anadromous salmon may be feasible only if dams are removed. If this will not be considered, selection of other ecological values as potential endpoints in this highly modified system may be the only option. Another concern may be whether it is possible to directly measure important variables. Where it is possible to directly measure attributes of an assessment endpoint, extrapolation is unnecessary, thus preventing the introduction of a source of uncertainty. Assessment endpoints that cannot be measured directly but can be represented by measures that are easily monitored and modeled may still provide a good foundation for a risk assessment. However, while established measurement protocols are convenient and useful, they do not determine whether an assessment endpoint is appropriate. Data availability alone is not an adequate criterion for selection.

To ensure scientific validity, risk assessors are responsible for selecting and defining potential assessment endpoints based on an understanding of the ecosystem of concern. Risk managers and risk assessors should then come to agreement on the final selection.

### **3.3.2. Defining Assessment Endpoints**

Once ecological values are selected as potential assessment endpoints, they need to be operationally defined. Two elements are required to define an assessment endpoint. The first is the identification of the specific valued ecological entity. This can be a species (e.g., eelgrass, piping plover), a functional group of species (e.g., piscivores), a community (e.g., benthic invertebrates), an ecosystem (e.g., lake), a specific valued habitat (e.g., wet meadows), a unique place (e.g., a remnant of native prairie), or other entity of concern. The second is the characteristic about the entity of concern that is important to protect and potentially at risk. Thus, it is necessary to define what is important for

piping plovers (e.g., nesting and feeding conditions), a lake (e.g., nutrient cycling), or wet meadow (e.g., endemic plant community diversity). For an assessment endpoint to serve as a clear interpretation of the management goals and the basis for measurement in the risk assessment, both an entity and an attribute are required.

What distinguishes assessment endpoints from management goals is their neutrality and specificity. Assessment endpoints do not represent a desired achievement (i.e., goal). As such, they do not contain words like “protect,” “maintain,” or “restore,” or indicate a direction for change such as “loss” or “increase.” Instead they are ecological values defined by specific entities and their measurable attributes, providing a framework for measuring stress-response relationships. When goals are very broad it may be difficult to select appropriate assessment endpoints until the goal is broken down into multiple management objectives. A series of management objectives can clarify the inherent assumptions within the goal and help a risk assessor determine which ecological entities and attributes best represent each objective (see text box 2-6). From this, multiple assessment endpoints may be selected. See text box 3-9 for examples of management goals and assessment endpoints.

Assessment endpoints may or may not be distinguishable from measures, depending on the assessment endpoints selected and the type of measures. While it is the entity that influences the scale and character of a risk assessment, it is the attributes of an assessment endpoint that determine what to measure. Sometimes direct measures of effect can be collected on the attribute of concern. Where this occurs, the assessment endpoint and measure of effect are the same and no extrapolation is necessary (e.g., if the assessment endpoint is “reproductive success of blue jays,” egg production and fledgling success could potentially be directly measured under different stressor exposure scenarios). In other cases, direct measures may not be possible (e.g., toxicity in endangered species) and surrogate measures of effect must be selected. Thus, although assessment endpoints must be defined in terms of measurable attributes, selection does not depend on the ability to measure those attributes directly or on whether methods, models, and data are currently available. For practical reasons, it may be helpful to use assessment endpoints that have well-developed test methods, field measurement techniques, and predictive models (see Suter, 1993a). However, it is not necessary for methods to be standardized protocols, nor should assessment endpoints be selected simply because standardized protocols are readily available. The appropriate measures to use are generally identified during conceptual model development and specified in the analysis plan. Measures of ecosystem characteristics and exposure are determined by the entity and attributes selected and serve as important information in conceptual model development. See section 3.5.1 for issues surrounding the selection of measures.

Clearly defined assessment endpoints provide direction and boundaries for the risk assessment and can minimize miscommunication and reduce uncertainty; where they are poorly defined, inappropriate, or at the incorrect scale, they can be very problematic. Endpoints may be too broad, vague, or narrow, or they may be inappropriate for the ecosystem requiring protection. “Ecological integrity” is a frequently cited but vague goal and is too vague for an assessment endpoint. “Integrity” can only be used effectively when its meaning is explicitly characterized for a particular ecosystem, habitat, or entity. This may be done by selecting key entities or

### Text Box 3-9. Examples of Management Goals and Assessment Endpoints

Case	Regulatory context/management goal	Assessment endpoint
Assessing Risks of New Chemical Under Toxic Substances Control Act (Lynch et al., 1994)	Protect “the environment” from “an unreasonable risk of injury” (TSCA §2[b][1] and [2]); protect the aquatic environment. Goal was to exceed a concentration of concern on no more than 20 days a year.	Survival, growth, and reproduction of fish, aquatic invertebrates, and algae
Special Review of Granular Carbofuran Based on Adverse Effects on Birds (Houseknecht, 1993)	Prevent . . . “unreasonable adverse effects on the environment” (FIFRA §§3[c][5] and 3[c][6]); using cost-benefit considerations. Goal was to have no regularly repeated bird kills.	Individual bird survival
Modeling Future Losses of Bottomland Forest Wetlands (Brody et al., 1993)	National Environmental Policy Act may apply to environmental impact of new levee construction; also Clean Water Act §404.	(1) Forest community structure and habitat value to wildlife species (2) Species composition of wildlife community
Pest Risk Assessment on Importation of Logs From Chile (USDA, 1993)	Assessment was done to help provide a basis for any necessary regulation of the importation of timber and timber products into the United States.	Survival and growth of tree species in the western United States
Baird and McGuire Superfund Site (terrestrial component); (Burmester et al., 1991; Callahan et al., 1991; Menzie et al., 1992)	Protection of the environment (CERCLA/SARA).	(1) Survival of soil invertebrates (2) Survival and reproduction of song birds
Waquoit Bay Estuary Watershed Risk Assessment (U.S. EPA, 1996a)	Clean Water Act—wetlands protection; water quality criteria—pesticides; endangered species. National Estuarine Research Reserve, Massachusetts, Area of Critical Environmental Concern. Goal was to reestablish and maintain water quality and habitat conditions to support diverse self-sustaining commercial, recreational, and native fish, water-dependent wildlife, and shellfish and to reverse ongoing degradation.	(1) Estuarine eelgrass habitat abundance and distribution (2) Estuarine fish species diversity and abundance (3) Freshwater pond benthic invertebrate species diversity and abundance

processes for an ecosystem and describing attributes that best represent integrity for that system. Assessment endpoints that are too narrowly defined may not support effective risk management. If an assessment is focused only on protecting the habitat of an endangered species, for example, the risk assessment may overlook other equally important characteristics of the ecosystem and fail to include critical variables (see text box 3-8). Finally, the assessment endpoint could fail to represent the ecosystem at risk. For instance, selecting a game fish that grows well in reservoirs may meet a “fishable” management goal, but it would be inappropriate for evaluating risk from a new hydroelectric dam if the ecosystem of concern is a stream in which salmon spawn (see text box 3-5). Although the game fish will satisfy “fishable” goals and may be highly desired by local fishermen, a reservoir species does not represent the ecosystem at risk. Substituting “reproducing populations of indigenous salmonids” for a vague “viable fish populations” assessment endpoint could therefore prevent the development of an inappropriate risk assessment.

When well selected, assessment endpoints become powerful tools in the risk assessment process. One endpoint that is sensitive to many of the identified stressors, yet responds in different ways to different stressors, may provide an opportunity to consider the combined effects of multiple stressors while still distinguishing their effects. For example, fish population recruitment may be adversely affected at several life stages, in different habitats, through different ways, and by different stressors. Therefore, measures of effect, exposure, and ecosystem and receptor characteristics could be chosen to evaluate recruitment and provide a basis for distinguishing different stressors, individual effects, and their combined effects.

The assessment endpoint can provide a basis for comparing a range of stressors if carefully selected. The National Crop Loss Assessment Network (Heck, 1993) selected crop yields as the assessment endpoint to evaluate the cumulative effects of multiple stressors. Although the primary stressor was ozone, the crop-yield endpoint also allowed the risk assessors to consider the effects of sulfur dioxide and soil moisture. As Barnthouse et al. (1990) pointed out, an endpoint should be selected so that all the effects can be expressed in the same units (e.g., changes in the abundance of 1-year-old fish from exposure to toxicity, fishing pressure, and habitat loss). This is especially true when selecting assessment endpoints for multiple stressors. However, in situations where multiple stressors act on the structure and function of aquatic and terrestrial communities in a watershed, an array of assessment endpoints that represent the community and associated ecological processes is more effective than a single endpoint. When based on differing susceptibility to an array of stressors, carefully selected assessment endpoints can help risk assessors distinguish the effects of diverse

stressors. Exposure to multiple stressors may lead to effects at different levels of biological organization, for a cascade of adverse effects that should be considered.

Professional judgment and an understanding of the characteristics and function of an ecosystem are important for translating general goals into usable assessment endpoints. The less information available, the more critical it is to have informed professionals help in the selection. Common problems encountered in selecting assessment endpoints are summarized in text box 3-10.

Final assessment endpoint selection is an important risk manager-risk assessor checkpoint during problem formulation. Risk assessors and risk managers should agree that selected assessment endpoints effectively represent the management goals. In addition, the scientific rationale for their selection should be made explicit in the risk assessment.

### 3.4. CONCEPTUAL MODELS

A conceptual model in problem formulation is a written description and visual representation of predicted relationships between ecological entities and the stressors to which they may be exposed. Conceptual models represent many relationships. They may include ecosystem processes that influence receptor responses or exposure scenarios that qualitatively link land-use activities to stressors.

They may describe primary, secondary, and tertiary exposure pathways (see section 4.2) or co-occurrence among exposure pathways, ecological effects, and ecological receptors. Multiple conceptual models may be generated to address several issues in a given risk

#### **Text Box 3-10. Common Problems in Selecting Assessment Endpoints**

- Endpoint is a goal (e.g., maintain and restore endemic populations)
- Endpoint is vague (e.g., estuarine integrity instead of eelgrass abundance and distribution)
- Ecological entity is better as a measure (e.g., emergence of midges can be used to evaluate an assessment endpoint for fish feeding behavior)
- Ecological entity may not be as sensitive to the stressor (e.g., catfish versus salmon for sedimentation)
- Ecological entity is not exposed to the stressor (e.g., using insectivorous birds for avian risk of pesticide application to seeds)
- Ecological entities are irrelevant to the assessment (e.g., lake fish in salmon stream)
- Importance of a species or attributes of an ecosystem are not fully considered (e.g., mussel-fish connection, see Text Box 3-8).
- Attribute is not sufficiently sensitive for detecting important effects (e.g., survival compared with recruitment for endangered species)



assessment. Some of the benefits gained by developing conceptual models are featured in text box 3-11.

Conceptual models for ecological risk assessments are developed from information about stressors, potential exposure, and predicted effects on an ecological entity (the assessment endpoint). Depending on why a risk assessment is initiated, one or more of these categories of information are known at the outset (refer to section 3.2 and text box 3-3). The process of creating conceptual models helps identify the unknown elements.

The complexity of the conceptual model depends on the complexity of the problem: the number of stressors, number of assessment endpoints, nature of effects, and characteristics of the ecosystem. For single stressors and single assessment endpoints, conceptual models may be simple. In some cases, the same basic conceptual model may be used repeatedly (e.g., in EPA's new chemical risk assessments). However, when conceptual models are used to describe pathways of individual stressors and assessment endpoints and the interaction of multiple and diverse stressors and assessment endpoints (e.g., assessments initiated to protect ecological values), more complex models and several submodels will often be needed. In this case, it can be helpful to create models that also represent expected ecosystem characteristics and function when stressors are not present.

Conceptual models consist of two principal components:

- A set of risk hypotheses that describe predicted relationships among stressor, exposure, and assessment endpoint response, along with the rationale for their selection
- A diagram that illustrates the relationships presented in the risk hypotheses.

### **Text Box 3-11. What Are the Benefits of Developing Conceptual Models?**

- The process of creating a conceptual model is a powerful learning tool.
- Conceptual models are easily modified as knowledge increases.
- Conceptual models highlight what is known and not known and can be used to plan future work.
- Conceptual models can be a powerful communication tool. They provide an explicit expression of the assumptions and understanding of a system for others to evaluate.
- Conceptual models provide a framework for prediction and are the template for generating more risk hypotheses.

### 3.4.1. Risk Hypotheses

Hypotheses are assumptions made in order to evaluate logical or empirical consequences, or suppositions tentatively accepted to provide a basis for evaluation. Risk hypotheses are specific assumptions about potential risk to assessment endpoints (see text box 3-12) and may be based on theory and logic, empirical data, mathematical models, or probability models. They are formulated using a combination of professional judgment and available information on the ecosystem at risk, potential sources of stressors, stressor characteristics, and observed or predicted ecological effects on selected or potential assessment endpoints. These hypotheses may predict the effects of a stressor before they occur, or they may postulate why observed ecological effects occurred and ultimately what

caused the effect. Depending on the scope of the risk assessment, risk hypotheses may be very simple, predicting the potential effect of one stressor on one receptor, or extremely complex, as is typical in value-initiated risk assessments that often include prospective and retrospective hypotheses about the effects of multiple complexes of stressors on diverse ecological receptors. Risk hypotheses represent relationships in the conceptual model and are not designed for statistically testing null and alternative hypotheses. However, they can be used to generate questions appropriate for research.

Although risk hypotheses are valuable even when information is limited, the amount and quality of data and information will affect the specificity and level of uncertainty associated with risk hypotheses and the conceptual models they form. When preliminary information is conflicting, risk hypotheses can be constructed specifically to differentiate between competing predictions. The predictions can then be evaluated systematically either by using available data during the analysis phase or by collecting new data before proceeding with the risk assessment. Hypotheses and predictions set a framework for using data to evaluate functional relationships (e.g., stressor-response curves).

#### **Text Box 3-12. What Are Risk Hypotheses, and Why Are They Important?**

Risk hypotheses are proposed answers to questions risk assessors have about what responses assessment endpoints will show when they are exposed to stressors and how exposure will occur. Risk hypotheses clarify and articulate relationships that are posited through the consideration of available data, information from scientific literature, and the best professional judgment of risk assessors developing the conceptual models. This explicit process opens the risk assessment to peer review and evaluation to ensure the scientific validity of the work. Risk hypotheses are not equivalent to statistical testing of null and alternative hypotheses. However, predictions generated from risk hypotheses can be tested in a variety of ways, including standard statistical approaches.

Early conceptual models are normally broad, identifying as many potential relationships as possible. As more information is incorporated, the plausibility of specific hypotheses helps risk assessors sort through potentially large numbers of stressor-effect relationships, and the ecosystem processes that influence them, to identify those risk hypotheses most appropriate for the analysis phase. It is then that justifications for selecting and omitting hypotheses are documented. Examples of risk hypotheses are provided in text box 3-13.

### 3.4.2. Conceptual Model Diagrams

Conceptual model diagrams are a visual representation of risk hypotheses. They are useful tools for communicating important pathways clearly and concisely and can be used to generate new questions about relationships that help formulate plausible risk hypotheses.

Typical conceptual model diagrams are flow diagrams containing boxes and arrows to illustrate relationships (see Appendix C). When this approach is used, it is helpful to use distinct and consistent shapes to distinguish stressors, assessment endpoints, responses, exposure routes, and ecosystem processes. Although flow diagrams are often used to illustrate conceptual models, there is no set configuration. Pictorial representations can be very effective (e.g., Bradley and Smith, 1989). Regardless of the configuration, a diagram's usefulness is linked to

#### **Text Box 3-13. Examples of Risk Hypotheses**

Hypotheses include known information that sets the problem in perspective and the proposed relationships that need evaluation.

**Stressor-initiated:** Chemicals with a high  $K_{ow}$  tend to bioaccumulate. PMN chemical A has a  $K_{ow}$  of 5.5 and molecular structure similar to known chemical stressor B.

**Hypotheses:** Based on the  $K_{ow}$  of chemical A, the mode of action of chemical B, and the food web of the target ecosystem, when the PMN chemical is released at a specified rate, it will bioaccumulate sufficiently in 5 years to cause developmental problems in wildlife and fish.

**Effects-initiated:** Bird kills were repeatedly observed on golf courses following the application of the pesticide carbofuran, which is highly toxic.

**Hypotheses:** Birds die when they consume recently applied granulated carbofuran; as the level of application increases, the number of dead birds increases. Exposure occurs when dead and dying birds are consumed by other animals. Birds of prey and scavenger species will die from eating contaminated birds.

**Ecological value-initiated:** Waquoit Bay, Massachusetts, supports recreational boating and commercial and recreational shellfishing and is a significant nursery for finfish. Large mats of macroalgae clog the estuary, most of the eelgrass has died, and the scallops are gone.

**Hypotheses:** Nutrient loading from septic systems, air pollution, and lawn fertilizers causes eelgrass loss by shading from algal growth and direct toxicity from nitrogen compounds. Fish and shellfish populations are decreasing because of loss of eelgrass habitat and periodic hypoxia from excess algal growth and low dissolved oxygen.

the detailed written descriptions and justifications for the relationships shown. Without this, diagrams can misrepresent the processes they are intended to illustrate.

When developing conceptual model diagrams, factors to consider include the number of relationships depicted, the comprehensiveness of the information, the certainty surrounding a linkage, and the potential for measurement. The number of relationships that can be depicted in one flow diagram depends on their complexity. Several models that increasingly show more detail for smaller portions can be more effective than trying to create one model that shows everything at the finest detail. Flow diagrams that highlight data abundance or scarcity can provide insights on how the analyses should be approached and can be used to show the risk assessor's confidence in the relationship. They can also show why certain pathways were pursued and others were not.

Diagrams provide a working and dynamic representation of relationships. They should be used to explore different ways of looking at a problem before selecting one or several to guide analysis. Once the risk hypotheses are selected and flow diagrams drawn, they set the framework for final planning for the analysis phase.

### **3.4.3. Uncertainty in Conceptual Models**

Conceptual model development may account for one of the most important sources of uncertainty in a risk assessment. If important relationships are missed or specified incorrectly, the risk characterization may misrepresent actual risks. Uncertainty arises from lack of knowledge about how the ecosystem functions, failure to identify and interrelate temporal and spatial parameters, omission of stressors, or overlooking secondary effects. In some cases, little may be known about how a stressor moves through the environment or causes adverse effects. Multiple stressors are the norm and a source of confounding variables, particularly for conceptual models that focus on a single stressor. Professionals may not agree on the appropriate conceptual model configuration. While simplification and lack of knowledge may be unavoidable, risk assessors should document what is known, justify the model, and rank model components in terms of uncertainty (see Smith and Shugart, 1994).

Uncertainty associated with conceptual models can be explored by considering alternative relationships. If more than one conceptual model is plausible, the risk assessor may evaluate whether it is feasible to follow separate models through analysis or whether the models can be combined to create a better model.

Conceptual models should be presented to risk managers to ensure that they communicate well and address managers' concerns. This check for completeness and clarity is a way to assess the need for changes before analysis begins. It is also valuable to revisit and where necessary revise conceptual

models during risk assessments to incorporate new information and recheck the rationale. If this is not feasible, it is helpful to present any new information during risk characterization along with associated uncertainties.

Throughout problem formulation, ambiguities, errors, and disagreements will occur, all of which contribute to uncertainty. Wherever possible, these sources of uncertainty should be eliminated through better planning. Because all uncertainty cannot be eliminated, a description of the nature of the uncertainties should be summarized at the close of problem formulation. See text box 3-14 for recommendations on how to address uncertainty.

### 3.5. ANALYSIS PLAN

The analysis plan is the final stage of problem formulation. During analysis planning, risk hypotheses are evaluated to determine how they will be assessed using available and new data. The plan includes a delineation of the assessment design, data needs, measures, and methods for conducting the analysis phase of the risk assessment. Analysis plans may be brief or extensive depending on the assessment. For some assessments (e.g., EPA's new chemical assessments), the analysis plan is already part of the established protocol and a new plan is generally unnecessary. As risk assessments become more unique and complex, the importance of a good analysis plan increases.

The analysis plan includes pathways and relationships identified during problem formulation that will be pursued during the analysis phase. Those hypotheses considered more likely to contribute to risk are targeted. The rationale for selecting and omitting risk hypotheses is incorporated into the plan and includes acknowledgment of data gaps and uncertainties. It also may include a comparison of the level of confidence needed for the management decision with that expected from alternative analyses in

#### **Text Box 3-14. Uncertainty in Problem Formulation**

Uncertainties in problem formulation are manifested in the quality of conceptual models. To address uncertainty:

- Be explicit in defining assessment endpoints; include both an entity and its measurable attributes.
- Reduce or define variability by carefully defining boundaries for the assessment.
- Be open and explicit about the strengths and limitations of pathways and relationships depicted in the conceptual model.
- Identify and describe rationale for key assumptions made because of lack of knowledge, model simplification, approximation, or extrapolation.
- Describe data limitations.

order to determine data needs and evaluate which analytical approach is best. When new data are needed, the feasibility of obtaining them can be taken into account.

Identification of the most critical relationships to evaluate in a risk assessment is based on the relationship of assessment endpoints to ecosystem structure and function, the relative importance or influence and mode of action of stressors on assessment endpoints, and other variables influencing ecological adversity (see section 5.2.2). However, final selection of relationships that can be pursued in analysis is based on the strength of known relationships between stressors and effects, the completeness of known exposure pathways, and the quality and availability of data.

In situations where data are few and new data cannot be collected, it may be possible to extrapolate from existing data. Extrapolation allows the use of data collected from other locations or organisms where similar problems exist. For example, the relationship between nutrient availability and algal growth is well established and consistent. This relationship can be acknowledged despite differences in how it is manifested in particular ecosystems. When extrapolating from data, it is important to identify the source of the data, justify the extrapolation method, and discuss recognized uncertainties.

A phased, or tiered, risk assessment approach (see section 2.2) can facilitate management decisions in cases involving minimal data sets. However, where few data are available, recommendations for new data collection should be part of the analysis plan. When new data are needed and cannot be obtained, relationships that cannot be assessed are a source of uncertainty and should be described in the analysis plan and later discussed in risk characterization.

When determining what data to analyze and how to analyze them, consider how these analyses may increase understanding and confidence in the conclusions of the risk assessment and address risk management questions. During selection, risk assessors may ask questions such as: How relevant will the results be to the assessment endpoint(s) and conceptual model(s)? Are there sufficient data of high quality to conduct the analyses with confidence? How will the analyses help establish cause-and-effect relationships? How will results be presented to address managers' questions? Where are uncertainties likely to become a problem? Consideration of these questions during analysis planning will improve future characterization of risk (see section 5.2.1 for discussion of lines of evidence).

### **3.5.1. Selecting Measures**

Assessment endpoints and conceptual models help risk assessors identify measurable attributes to quantify and predict change. However, determining what measures to use to evaluate risk hypotheses is both challenging and critical to the success of a risk assessment.

There are three categories of measures. Measures of effect are measurable changes in an attribute of an assessment endpoint or its surrogate in response to a stressor to which it is exposed (formerly measurement endpoints; see text box 3-15). Measures of exposure are measures of stressor existence and movement in the environment and their contact or co-occurrence with the assessment endpoint. Measures of ecosystem and receptor characteristics are measures of ecosystem characteristics that influence the behavior and location of entities selected as the assessment endpoint, the distribution of a stressor, and life-history characteristics of the assessment endpoint or its surrogate that may affect exposure or response to the stressor. Examples of the three types of measures are provided in text box 3-16 (see also Appendix A.2.1).

### **Text Box 3-15. Why Was Measurement Endpoint Changed?**

The original definition of *measurement endpoint* was “a measurable characteristic that is related to the valued characteristic chosen as the assessment endpoint” (Suter, 1989; U.S. EPA, 1992a). The definition refers specifically to the response of an assessment endpoint to a stressor. It does not include measures of ecosystem characteristics, life-history considerations, exposure, or other measures. Because *measurement endpoint* does not encompass these other important measures and there was confusion about its meaning, the term was replaced with *measures of effect* and supplemented by two other categories of measures.

The selection of appropriate measures is particularly complicated when a cascade of ecological effects is likely to occur from a stressor. In these cases, the effect on one entity (i.e., the measure of effect) may become a stressor for other ecological entities (i.e., become a measure of exposure) and may result in impacts on one or more assessment endpoints. For example, if a pesticide reduces earthworm populations, change in earthworm population density could be the direct measure of effect of toxicity and in some cases may be an assessment endpoint. However, the reduction of worm populations may then become a secondary stressor to which worm-eating birds become exposed, measured as lowered food supply. This exposure may then result in a secondary measurable effect of starvation of young. In this case, although “bird fledgling success” may be an assessment endpoint that could be measured directly, measures of earthworm density, pesticide residue in earthworms and other food sources, availability of alternative foods, nest site quality, and competition for nests from other bird species may all be useful measurements.

When direct measurement of assessment endpoint responses is not possible, the selection of surrogate measures is necessary. The selection of what, where, and how to measure surrogate

responses determines whether the risk assessment is still relevant to management decisions about an assessment endpoint. As an example, an assessment may be conducted to evaluate the potential risk of a pesticide used on seeds to an endangered species of seed-eating bird. The assessment endpoint entity is the endangered species. Example attributes include feeding behavior, survival, growth, and reproduction. While it may be possible to directly collect measures of exposure and assessment endpoint life-history characteristics on the endangered species, it would not be appropriate to expose the endangered species to the pesticide to measure sensitivity. In this case, to evaluate susceptibility, the most appropriate surrogate measures would be on seed-eating birds with similar life-history characteristics and phylogeny. While insectivorous birds may serve as an adequate surrogate measure for determining the sensitivity of the endangered bird to the pesticide, they do not address issues of exposure.

Problem formulations based on assessment endpoints and selected measures that address both sensitivity and likely exposure to stressors will be relevant to management concerns. If assessment endpoints are not susceptible, their use in assessing risk can lead to poor management decisions (see section 3.3.1). To highlight the relationships among goals, assessment endpoints, and measures, text box 3-

### **Text Box 3-16. Examples of a Management Goal, Assessment Endpoint, and Measures**

**Goal:** Viable, self-sustaining coho salmon population that supports a subsistence and sport fishery.

**Assessment Endpoint:** Coho salmon breeding success, fry survival, and adult return rates.

#### **Measures of Effects**

- Egg and fry response to low dissolved oxygen
- Adult behavior in response to obstacles
- Spawning behavior and egg survival with changes in sedimentation

#### **Measures of Ecosystem and Receptor Characteristics**

- Water temperature, water velocity, and physical obstructions
- Abundance and distribution of suitable breeding substrate
- Abundance and distribution of suitable food sources for fry
- Feeding, resting, and breeding behavior
- Natural reproduction, growth, and mortality rates

#### **Measures of Exposure**

- Number of hydroelectric dams and associated ease of fish passage
- Toxic chemical concentrations in water, sediment, and fish tissue.
- Nutrient and dissolved oxygen levels in ambient waters
- Riparian cover, sediment loading, and water temperature



17 illustrates how these are related in water quality criteria. In this example, it is instructive to note that although water quality criteria are considered risk-based, they are not full risk assessments. Water quality criteria provide an effects benchmark for decision making and do not incorporate measures of exposure in the environment. Within that benchmark, there are a number of assumptions about significance (e.g., aquatic communities will be protected by achieving a benchmark derived from individual species' toxicological responses to a single chemical) and exposure (e.g., 1-hour and 4-day exposure averages). Such assumptions embedded in decision rules are important to articulate (see section 3.5.2).

The analysis plan provides a synopsis of measures that will be used to evaluate risk hypotheses. The plan is strongest when it contains explicit statements for how measures were selected, what they are intended to evaluate, and which analyses they support. Uncertainties associated with selected measures and analyses and plans for addressing them should be included in the plan when possible.

### **3.5.2. Ensuring That Planned Analyses Meet Risk Managers' Needs**

The analysis plan is a risk manager-risk assessor checkpoint. Risk assessors and risk managers review the plan to ensure that the analyses will provide information the manager can use for decision making. These discussions

#### **Text Box 3-17. How Do Water Quality Criteria Relate to Assessment Endpoints?**

Water quality criteria (U.S. EPA, 1986a) have been developed for the protection of aquatic life from chemical stressors. This text box shows how the elements of a water quality criterion correspond to management goals, management decisions, assessment endpoints, and measures.

##### **Regulatory Goal**

- Clean Water Act, §101: Protect the chemical, physical, and biological integrity of the Nation's waters

##### **Program Management Decisions**

- Protect 99% of individuals in 95% of the species in aquatic communities from acute and chronic effects resulting from exposure to a chemical stressor

##### **Assessment Endpoints**

- Survival of fish, aquatic invertebrate, and algal species under acute exposure
- Survival, growth, and reproduction of fish, aquatic invertebrate, and algal species under chronic exposure

##### **Measures of Effect**

- Laboratory LC<sub>50</sub>s for at least eight species meeting certain requirements
- Chronic no-observed-adverse-effect levels (NOAELs) for at least three species meeting certain requirements

##### **Measures of Ecosystem and Receptor Characteristics**

- Water hardness (for some metals)
- pH

The water quality criterion is a benchmark level derived from a distributional analysis of single-species toxicity data. It is assumed that the species tested adequately represent the composition and sensitivities of species in a natural community.

may also identify what can and cannot be done on the basis of a preliminary evaluation of problem formulation. A reiteration of the planning discussion helps ensure that the appropriate balance of requirements for the decision, data availability, and resource constraints is established for the risk assessment. This is also an appropriate time to conduct a technical review of the planning outcome.

Analysis plans include the analytical methods planned and the nature of the risk characterization options and considerations to be generated (e.g., quotients, narrative discussion, stressor-response curve with probabilities). A description of how data analyses will distinguish among risk hypotheses, the kinds of analyses to be used, and rationale for why different hypotheses were selected and eliminated are included. Potential extrapolations, model characteristics, types of data (including quality), and planned analyses (with specific tests for different types of data) are described. Finally, the plan includes a discussion of how results will be presented upon completion and the basis used for data selection.

Analysis planning is similar to the data quality objectives (DQO) process (see text box 3-18), which emphasizes identifying the problem by establishing study boundaries and determining necessary data quality, quantity, and applicability to the problem being evaluated (U.S. EPA, 1994c). The most important difference between problem formulation and the DQO process is the presence of a decision rule in a DQO that defines a benchmark for a management decision before the risk assessment is completed. The decision rule step specifies the statistical parameter that characterizes the population, specifies the action level for the study, and combines outputs from the previous DQO steps

### **Text Box 3-18. The Data Quality Objectives Process**

The data quality objectives (DQO) process combines elements of both planning and problem formulation in its seven-step format.

**Step 1. State the problem.** Review existing information to concisely describe the problem to be studied.

**Step 2. Identify the decision.** Determine what questions the study will try to resolve and what actions may result.

**Step 3. Identify inputs to the decision.** Identify information and measures needed to resolve the decision statement.

**Step 4. Define study boundaries.** Specify time and spatial parameters and where and when data should be collected.

**Step 5. Develop decision rule.** Define statistical parameter, action level, and logical basis for choosing alternatives.

**Step 6. Specify tolerable limits on decision errors.** Define limits based on the consequences of an incorrect decision.

**Step 7. Optimize the design.** Generate alternative data collection designs and choose most resource-effective design that meets all DQOs.

into an “if . . . then” decision rule that defines conditions under which the decision maker will choose alternative options (often used in tiered assessments; see also section 2.2.2). This approach provides the basis for establishing null and alternative hypotheses appropriate for statistical testing for significance that can be effective in this application. While this approach is sometimes appropriate, only certain kinds of risk assessments are based on benchmark decisions. Presentation of stressor-response curves with uncertainty bounds will be more appropriate than statistical testing of decision criteria where risk managers must evaluate the range of stressor effects to which they compare a range of possible management options (see Suter, 1996).

The analysis plan is the final synthesis before the risk assessment proceeds. It summarizes what has been done during problem formulation, shows how the plan relates to management decisions that must be made, and indicates how data and analyses will be used to estimate risks. When the problem is clearly defined and there are enough data to proceed, analysis begins.

## 4. ANALYSIS PHASE

Analysis is a process that examines the two primary components of risk, exposure and effects, and their relationships between each other and ecosystem characteristics. The objective is to provide the ingredients necessary for determining or predicting ecological responses to stressors under exposure conditions of interest.

Analysis connects problem formulation with risk characterization. The assessment endpoints and conceptual models developed during problem formulation provide the focus and structure for the analyses. Analysis phase products are summary profiles that describe exposure and the relationship between the stressor(s) and response. These profiles provide the basis for estimating and describing risks in risk characterization.

At the beginning of the analysis phase, the information needs identified during problem formulation should have already been addressed (text box 4-1). During the analysis phase (figure 4-1), the risk assessor:

- Selects the data that will be used on the basis of their utility for evaluating the risk hypotheses (section 4.1)
- Analyzes exposure by examining the sources of stressors, the distribution of stressors in the environment, and the extent of co-occurrence or contact (section 4.2)
- Analyzes effects by examining stressor-response relationships, the evidence for causality, and the relationship between measures of effect and assessment endpoints (section 4.3)

### **Text Box 4-1. Data Collection and the Analysis Phase**

Data needs are identified during problem formulation (the analysis plan step), and data are collected before the start of the analysis phase. These data may be collected for the specific purpose of a particular risk assessment, or they may be available from previous studies. If additional data needs are identified as the assessment proceeds, the analysis phase may be temporarily halted while data are collected or the assessor (in consultation with the risk manager) may choose to iterate the problem formulation again. Data collection methods are not described in these Guidelines. However, the evaluation of data for the purposes of risk assessment is discussed in section 4.2.

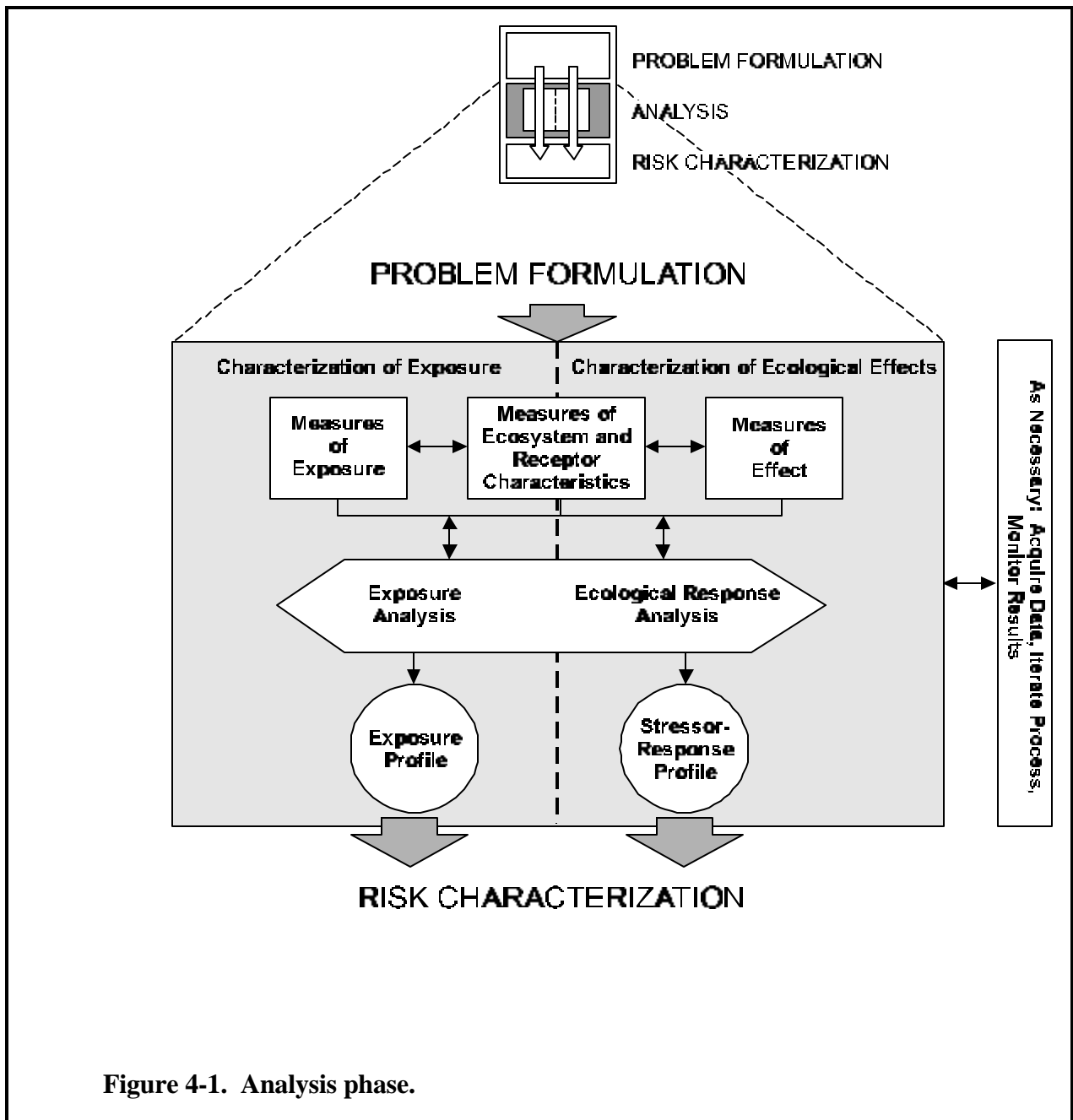

**Figure 4-1. Analysis phase.**

- Summarizes the conclusions about exposure (section 4.2.2) and effects (section 4.3.2).

The analysis phase is flexible, with substantial interaction between the effects and exposure characterizations as illustrated by the dotted line in figure 4-1. In particular, when secondary stressors and effects are of concern, exposure and effects analyses are conducted iteratively for different ecological entities, and they can become intertwined and difficult to differentiate. In the bottomland

hardwoods assessment, for example (Appendix D), potential changes in the plant and animal communities under different flooding scenarios were examined. Risk assessors combined the stressor-response and exposure analyses within the FORFLO model for primary effects on the plant community and within the Habitat Suitability Index for secondary effects on the animal community. In addition, the distinction between analysis and risk estimation can become blurred. The model results developed for the bottomland hardwoods assessment were used directly in risk characterization.

The nature of the stressor influences the types of analyses conducted. The results may range from highly quantitative to qualitative, depending on the stressor and the scope of the assessment. For chemical stressors, exposure estimates emphasize contact and uptake into the organism, and effects estimations often entail extrapolation from test organisms to the organism of interest. For physical stressors, the initial disturbance may cause primary effects on the assessment endpoint (e.g., loss of wetland acreage). In many cases, however, secondary effects (e.g., decline of wildlife populations that depend on wetlands) may be the principal concern. The point of view depends on the assessment endpoints. Because adverse effects can occur even if receptors do not physically contact disturbed habitat, exposure analyses may emphasize co-occurrence with physical stressors rather than contact. For biological stressors, exposure analysis is an evaluation of entry, dispersal, survival, and reproduction (Orr et al., 1993). Because biological stressors can reproduce, interact with other organisms, and evolve over time, exposure and effects cannot always be quantified with confidence; therefore, they may be assessed qualitatively by eliciting expert opinion (Simberloff and Alexander, 1994).

#### **4.1. EVALUATING DATA AND MODELS FOR ANALYSIS**

At the beginning of the analysis phase, the assessor critically examines the data and models to ensure that they can be used to evaluate the conceptual model developed in problem formulation (see sections 4.1.1 and 4.1.2). Section 4.1.3 addresses uncertainty evaluation.

##### **4.1.1. Strengths and Limitations of Different Types of Data**

Many types of data can be used for risk assessment. Data may come from laboratory or field studies or may be produced as output from a model. Familiarity with the strengths and limitations of different types of data can help assessors build on strengths and avoid pitfalls. Such a strategy improves confidence in the conclusions of the risk assessment.

Both laboratory and field studies (including field experiments and observational studies) can provide useful data for risk assessment. Because conditions can be controlled in laboratory studies,

responses may be less variable and smaller differences easier to detect. However, the controls may limit the range of responses (e.g., animals cannot seek alternative food sources), so they may not reflect responses in the environment. In addition, larger-scale processes are difficult to replicate in the laboratory.

Field observational studies (surveys) measure biological changes in uncontrolled situations. Ecologists observe patterns and processes in the field and often use statistical techniques (e.g., correlation, clustering, factor analysis) to describe an association between a disturbance and an ecological effect. For instance, physical attributes of streams and their watersheds have been associated with changes in stream communities (Richards et al., 1997). Field surveys are often reported as status and trend studies. Messer et al. (1991) correlated a biotic index with acid concentrations to describe the extent and proportion of lakes likely to be impacted.

Field surveys usually represent exposures and effects (including secondary effects) better than estimates generated from laboratory studies or theoretical models. Field data are more important for assessments of multiple stressors or where site-specific factors significantly influence exposure. They are also often useful for analyses of larger geographic scales and higher levels of biological organization. Field survey data are not always necessary or feasible to collect for screening-level or prospective assessments.

Field surveys should be designed with sufficient statistical rigor to define one or more of the following:

- Exposure in the system of interest
- Differences in measures of effect between reference sites and study areas
- Lack of differences.

Because conditions are not controlled in field studies, variability may be higher and it may be difficult to detect differences. For this reason, it is important to verify that studies have sufficient power to detect important differences.

Field surveys are most useful for linking stressors with effects when stressor and effect levels are measured concurrently. The presence of confounding factors can make it difficult to attribute observed effects to specific stressors. For this reason, field studies designed to minimize effects of potentially confounding factors are preferred, and the evidence for causality should be carefully evaluated (see section 4.3.1.2). In addition, because treatments may not be randomly applied or replicated, classical statistical methods need to be applied with caution (Hurlbert, 1984; Stewart-Oaten

et al., 1986; Wiens and Parker, 1995; Eberhardt and Thomas, 1991). Intermediate between laboratory and field are studies that use environmental media collected from the field to examine response in the laboratory. Such studies may improve the power to detect differences and may be designed to provide evidence of causality.

Most data will be reported as measurements for single variables such as a chemical concentration or the number of dead organisms. In some cases, however, variables are combined and reported as indices. Several indices are used to evaluate effects, for example, the rapid bioassessment protocols (U.S. EPA, 1989a) and the Index of Biotic Integrity, or IBI (Karr, 1981; Karr et al., 1986). These have several advantages (Barbour et al., 1995), including the ability to:

- Provide an overall indication of biological condition by incorporating many attributes of system structure and function, from individual to ecosystem levels
- Evaluate responses from a broad range of anthropogenic stressors
- Minimize the limitations of individual metrics for detecting specific types of responses.

Indices also have several drawbacks, many of which are associated with combining heterogeneous variables. The final value may depend strongly on the function used to combine variables. Some indices (e.g., the IBI) combine only measures of effects. Differential sensitivity or other factors may make it difficult to attribute causality when many response variables are combined. To investigate causality, such indices may need to be separated into their components, or analyzed using multivariate methods (Suter, 1993b; Ott, 1978). Interpretation becomes even more difficult when an index combines measures of exposure and effects because double counting may occur or changes in one variable can mask changes in another. Measures of exposure and effects may need to be separated in order to make appropriate conclusions. For these reasons, professional judgment plays a critical role in developing and applying indices.

Experience from similar situations is particularly useful in assessments of stressors not yet released (i.e., prospective assessments). Lessons learned from past experiences with related organisms are often critical in trying to predict whether an organism will survive, reproduce, and disperse in a new environment. Another example is toxicity evaluation for new chemicals through the use of structure-activity relationships, or SARs (Auer et al., 1994; Clements and Nabholz, 1994). The simplest application of SARs is to identify a suitable analog for which data are available to estimate the toxicity



of a compound for which data are lacking. More advanced applications use quantitative structure-activity relationships (QSARs), which mathematically model the relationships between chemical structures and specific biological effects and are derived using information on sets of related chemicals (Lipnick, 1995; Cronin and Dearden, 1995). The use of analogous data without knowledge of the underlying processes may substantially increase the uncertainty in the risk assessment (e.g., Bradbury, 1994); however, use of these data may be the only option available.

Even though models may be developed and used as part of the risk assessment, sometimes the risk assessor relies on output of a previously developed model. Models are particularly useful when measurements cannot be taken, for example, when predicting the effects of a chemical yet to be manufactured. They can also provide estimates for times or locations that are impractical to measure and can provide a basis for extrapolating beyond the range of observation. Because models simplify reality, they may omit important processes for a particular system and may not reflect every condition in the real world. In addition, a model's output is only as good as the quality of its input variables, so critical evaluation of input data is important, as is comparing model outputs with measurements in the system of interest whenever possible.

Data and models for risk assessment are often developed in a tiered fashion (also see section 2.2). For example, simple models that err on the side of conservatism may be used first, followed by more elaborate models that provide more realistic estimates. Effects data may also be collected using a tiered approach. Short-term tests designed to evaluate effects such as lethality and immobility may be conducted first. If the chemical exhibits high toxicity or a preliminary characterization indicates a risk, then more expensive, longer-term tests that measure sublethal effects such as changes to growth and reproduction can be conducted. Later tiers may employ multispecies tests or field experiments. Tiered data should be evaluated in light of the decision they are intended to support; data collected for early tiers may not support more sophisticated needs.

#### **4.1.2. Evaluating Measurement or Modeling Studies**

The assessor's first task in the analysis phase is to carefully evaluate studies to determine whether they can support the objectives of the risk assessment. Each study should include a description of the purpose, methods used to collect data, and results of the work. The assessor evaluates the utility of studies by carefully comparing study objectives with those of the risk assessment for consistency. In addition, the assessor should determine whether the intended objectives were met and whether the data are of sufficient quality to support the risk assessment. This is a good opportunity to note the confidence in the information and the implications of different studies for use in the risk

characterization, when the overall confidence in the assessment is discussed. Finally, the risk assessor should identify areas where existing data do not meet risk assessment needs. In these cases, collecting additional data is recommended.

EPA is in the process of adopting the American Society for Quality Control's E-4 guidelines for assuring environmental data quality throughout the Agency (ASQC, 1994) (text box 4-2). These guidelines describe procedures for collecting new data and provide a valuable resource for evaluating existing studies. Readers may also refer to Smith and Shugart, 1994; U.S. EPA, 1994e; and U.S. EPA, 1990, for more information on evaluating data and models.

A study's documentation determines whether it can be evaluated for its utility in risk assessment. Studies should contain sufficient information so that results can be reproduced, or at least so the details of the author's work can be accessed and evaluated. Ideally, one should be able to access findings in their entirety; this provides the opportunity to conduct additional analyses of the data, if needed. For models, a number of factors increase the accessibility of methods and results. These begin with model code and documentation availability. Reports describing model results should include all important equations, tables of all parameter values, any parameter estimation techniques, and tables or graphs of results.

**Text Box 4-2. The American National Standard for Quality Assurance**

The Specifications and Guidelines for Quality Systems for Environmental Data Collection and Environmental Technology Programs (ASQC, 1994) recognize several areas that are important to ensuring that environmental data will meet study objectives, including:

- Planning and scoping
- Designing data collection operations
- Implementing and monitoring planned operations
- Assessing and verifying data usability.

Study descriptions may not provide all the information needed to evaluate their utility for risk assessment. Assessors should communicate with the principal investigator or other study participants to gain information on study plans and their implementation. Useful questions for evaluating studies are shown in text box 4-3.

#### **4.1.2.1. *Evaluating the Purpose and Scope of the Study***

Assessors should pay particular attention to the objectives and scope of studies that were designed for purposes other than the risk assessment at hand. This can identify important uncertainties and ensure that the information is

used appropriately. An example is the evaluation of studies that measure condition (e.g., stream surveys, population surveys): While the measurements used to evaluate condition may be the same as the measures of effects identified in problem formulation, to support a causal argument they must be linked with stressors. In the best case, this means that the stressor was measured at the same time and place as the effect.

Similarly, a model may have been developed for purposes other than risk assessment. Its description should include the intended application, theoretical framework, underlying assumptions, and limiting conditions. This information can help assessors identify important limitations in its application for risk assessment. For example, a model developed to evaluate chemical transport in the water column alone is of limited utility for a risk assessment of a chemical that partitions readily into sediments.

The variables and conditions examined by studies should also be compared with those identified during problem formulation. In addition, the range of variability explored in the study should be compared with that of the risk assessment. A study that examines animal habitat needs in the winter, for example, may miss important breeding-season requirements. Studies that minimize the amount of extrapolation needed are preferred. These are studies that represent:

- The measures identified in the analysis plan (i.e., measures of exposure, effects, and ecosystem and receptor characteristics)

#### **Text Box 4-3. Questions for Evaluating a Study's Utility for Risk Assessment**

- Ⓒ Are the study objectives relevant to the risk assessment?
- Ⓒ Are the variables and conditions the study represents comparable with those important to the risk assessment?
- Ⓒ Is the study design adequate to meet its objectives?
- Ⓒ Was the study conducted properly?
- Ⓒ How are variability and uncertainty treated and reported?

- The time frame of interest
- The ecosystem and location of interest
- The environmental conditions of interest
- The exposure route of interest.

#### **4.1.2.2. *Evaluating the Design and Implementation of the Study***

The assessor evaluates study design and implementation to determine whether the study objectives were met and the information is of sufficient quality to support the risk assessment. The study design provides insight into the sources and magnitude of uncertainty associated with the results (see section 4.1.3 for further discussion of uncertainty). Among the most important design issues of an effects study is whether it has enough statistical power to detect important differences or changes. Because this information is rarely reported (Peterman, 1990), the assessor may need to calculate the magnitude of an effect that could be detected under the study conditions (Rotenberry and Wiens, 1985).

Part of the exercise examines whether the study was conducted properly:

- For laboratory studies, this may mean determining whether test conditions were properly controlled and control responses were within acceptable bounds.
- For field studies, issues include identification and control of potentially confounding variables and careful reference site selection. (A discussion of reference site selection is beyond the scope of these Guidelines; however, it has been identified as a candidate topic for future development.)
- For models, issues include the program's structure and logic and the correct specification of algorithms in the model code (U.S. EPA, 1994e).

Evaluation is easier if standard methods or quality assurance/quality control (QA/QC) protocols are available and followed by the study. However, the assessor should still consider whether the identified precision and accuracy goals were achieved and whether they are appropriate for the risk

assessment. For instance, detection limits identified for one environmental matrix may not be achievable for another, and thus it may not be possible to detect concentrations of interest. Study results can still be useful even if a standard method was not used. However, this places an additional burden on both the authors and the assessors to provide and evaluate evidence that the study was conducted properly.

#### **4.1.3. Evaluating Uncertainty**

Uncertainty evaluation is a theme throughout the analysis phase. The objective is to describe and, where possible, quantify what is known and not known about exposure and effects in the system of interest. Uncertainty analyses increase the credibility of assessments by explicitly describing the magnitude and direction of uncertainties, and they provide the basis for efficient data collection or application of refined methods. Uncertainties characterized during the analysis phase are used during risk characterization, when risks are estimated (section 5.1) and the confidence in different lines of evidence is described (see section 5.2.1).

This section discusses sources of uncertainty relevant to the analysis of ecological exposure and effects; source and example strategies are shown in text box 4-4. Section 3.4.3 discusses uncertainty in conceptual model development. Readers are also referred to the discussion of uncertainties in the exposure assessment guidelines (U.S. EPA, 1992b).

Sources of uncertainty that are encountered when evaluating information include unclear communication of the data or its manipulation and errors in the information itself (descriptive errors). These are usually characterized by critically examining the sources of information and documenting the decisions made when handling it. The documentation should allow the reader to make an independent judgment about the validity of the assessor's decisions.

Sources of uncertainty that primarily arise when estimating the value of a parameter include variability, uncertainty about a quantity's true value, and data gaps. The term *variability* is used here to describe a characteristic's true heterogeneity. Examples include the variability in soil organic carbon, seasonal differences in animal diets, or differences in chemical sensitivity in different species. Variability is usually described during uncertainty analysis, although heterogeneity may not reflect a lack of knowledge and cannot usually be reduced by further measurement. Variability can be described by presenting a distribution or specific percentiles from it (e.g., mean and 95th percentile).

Uncertainty about a quantity's true value may include uncertainty about its magnitude, location, or time of occurrence. This uncertainty can usually be reduced by taking additional measurements. Uncertainty about a quantity's true magnitude is usually described by sampling error (or *variance* in experiments) or measurement error. When the quantity of interest is biological response, sampling error

can greatly influence a study's ability to detect effects. Properly designed studies will specify sample sizes large enough to detect important signals. Unfortunately, many studies have sample sizes that are too small to detect anything but gross changes (Smith and Shugart, 1994; Peterman, 1990). The discussion should highlight situations where the power to detect difference is low. Meta-analysis has been suggested as a way to combine results from different studies to improve the ability to detect effects (Laird and Mosteller, 1990; Petitti, 1994). However, these approaches have thus far been applied primarily in human epidemiology and are still controversial (Mann, 1990).

Interest in quantifying spatial uncertainty has increased with the increasing use of geographic information systems (GIS). Strategies include verifying the locations of remotely sensed features and ensuring that the spatial resolution of data or a method is commensurate with the needs of the assessment. A growing literature is addressing other analytical challenges often associated with using spatial data (e.g., collinearity and autocorrelation, boundary and scale effects, lack of true replication) (Johnson and Gage, 1997; Fotheringham and Rogerson, 1993;

#### Text Box 4-4. Uncertainty Evaluation in the Analysis Phase

Source of uncertainty	Example analysis phase strategies	Specific example
Unclear communication	Contact principal investigator or other study participants if objectives or methods of literature studies are unclear.	Clarify whether the study was designed to characterize local populations or regional populations.
	Document decisions made during the course of the assessment.	Discuss rationale for selecting the critical toxicity study.
Descriptive errors	Verify that data sources followed appropriate QA/QC procedures.	Double-check calculations and data entry.
Variability	Describe heterogeneity using point estimates (e.g., central tendency and high end) or by constructing probability or frequency distributions.	Display differences in species sensitivity using a cumulative distribution function.
	Differentiate from uncertainty due to lack of knowledge.	
Data gaps	Collect needed data.	Discuss rationale for using a factor of 10 to extrapolate between a lowest-observed-adverse-effect level (LOAEL) and a NOAEL.
	Describe approaches used for bridging gaps and their rationales.	
	Differentiate science-based judgments from policy-based judgments.	
Uncertainty about a quantity's true value	Use standard statistical methods to construct probability distributions or point estimates (e.g., confidence limits).	Present the upper confidence limit on the arithmetic mean soil concentration, in addition to the best estimate of the arithmetic mean.
	Evaluate power of designed experiments to detect differences.	
	Collect additional data.	
	Verify location of samples or other spatial features.	Ground-truth remote sensing data.
Model structure uncertainty (process models)	Discuss key aggregations and model simplifications.	Discuss combining different species into a group based on similar feeding habits.
	Compare model predictions with data collected in the system of interest.	
Uncertainty about a model's form (empirical models)	Evaluate whether alternative models should be combined formally or treated separately.	Present results obtained using alternative models.
	Compare model predictions with data collected in the system of interest.	Compare results of a plant uptake model with data collected in the field.

Wiens and Parker, 1995). Large-scale assessments generally require aggregating information at smaller scales. It is not known how aggregation affects uncertainty (Hunsaker et al., 1990).

Nearly every assessment must treat situations where data are unavailable or available only for parameters other than those of interest. Examples include using laboratory data to estimate a wild animal's response to a stressor or using a bioaccumulation measurement from a different ecosystem. These data gaps are usually bridged with a combination of scientific analyses, scientific judgment, and perhaps policy decisions. In deriving an ambient water quality criterion (text box 3-17), for example, data and analyses are used to construct distributions of species sensitivity for a particular chemical. Scientific judgment is used to infer that species selected for testing will adequately represent the range of sensitivity of species in the environment. Policy defines the extent to which individual species should be protected (e.g., 90% vs. 95% of the species). It is important to distinguish these elements.

Data gaps can often be filled by completing additional studies on the unknown parameter. When possible, the necessary data should be collected. At the least, opportunities for filling data gaps should be noted and carried through to risk characterization. Data or knowledge gaps that are so large that they preclude the analysis of either exposure or ecological effects should also be noted and discussed in risk characterization.

An important objective is to distinguish variability from uncertainties that arise from lack of knowledge (e.g., uncertainty about a quantity's true value) (U.S. EPA, 1995b). This distinction facilitates the interpretation and communication of results. For instance, in their food web models of herons and mink, MacIntosh et al. (1994) separated expected variability in individual animals' feeding habits from the uncertainty in the mean concentration of chemical in prey species. They could then place error bounds on the exposure distribution for the animals using the site and estimate the proportion of the animal population that might exceed a toxicity threshold.

Sources of uncertainty that arise primarily during model development and application include process model structure and the relationships between variables in empirical models. Process model descriptions should include assumptions, simplifications, and aggregations of variables (see text box 4-5). Empirical model descriptions should include the rationale for selection and model performance statistics (e.g., goodness of fit). Uncertainty in process or empirical models can be quantitatively evaluated by comparing model results to measurements taken in the system of interest or by comparing the results of different models.

Methods for analyzing and describing uncertainty can range from simple to complex. When little is known, a useful approach is to estimate exposure and effects based on alternative sets of assumptions (scenarios). Each scenario is carried through to risk characterization, where



the underlying assumptions and the scenario's plausibility are discussed. Results can be presented as a series of point estimates with different aspects of uncertainty reflected in each. Classical statistical methods (e.g., confidence limits, percentiles) can readily describe parameter uncertainty. For models, sensitivity analysis can be used to evaluate how model output changes with changes in input variables, and uncertainty propagation can be analyzed to examine how uncertainty in individual parameters can affect the overall uncertainty in the results. The availability of software for Monte Carlo analysis has greatly increased the use of probabilistic methods; readers are encouraged to follow suggested best practices (e.g., U.S. EPA, 1996b, 1997b). Other methods (e.g., fuzzy mathematics, Bayesian methodologies) are available but have not yet been extensively applied to ecological risk assessment (Smith and Shugart, 1994). The Agency does not endorse the use of any one method and cautions that the poor execution of any method can obscure rather than clarify the impact of uncertainty on an assessment's results. No matter what technique is used, the sources of uncertainty discussed above should be addressed.

#### **Text Box 4-5. Considering the Degree of Aggregation in Models**

Wiegert and Bartell (1994) suggest the following considerations for evaluating the proper degree of aggregation or disaggregation:

1. Do not aggregate components with greatly disparate flux rates.
2. Do not greatly increase the disaggregation of the structural aspects of the model without a corresponding increase in the sophistication of the functional relationships and controls.
3. Disaggregate models only insofar as required by the goals of the model to facilitate testing.

## **4.2. CHARACTERIZATION OF EXPOSURE**

Exposure characterization describes potential or actual contact or co-occurrence of stressors with receptors. It is based on measures of exposure and ecosystem and receptor characteristics that are used to analyze stressor sources, their distribution in the environment, and the extent and pattern of contact or co-occurrence (discussed in section 4.2.1). The objective is to produce a summary exposure profile (section 4.2.2) that identifies the receptor (i.e., the exposed ecological entity), describes the course a stressor takes from the source to the receptor (i.e., the exposure pathway), and describes the intensity and spatial and temporal extent of co-occurrence or contact. The profile also describes the impact of variability and uncertainty on exposure estimates and reaches a conclusion about the likelihood that exposure will occur.

The exposure profile is combined with an effects profile (discussed in section 4.3.2) to estimate risks. For the exposure profile to be useful, it should be compatible with the stressor-response relationship generated in the effects characterization.

#### **4.2.1. Exposure Analyses**

Exposure is contact or co-occurrence between a stressor and a receptor. The objective is to describe exposure in terms of intensity, space, and time in units that can be combined with the effects assessment. In addition, the assessor should be able to trace the paths of stressors from the source(s) to the receptors (i.e., describe the exposure pathway).

A complete picture of how, when, and where exposure occurs or has occurred is developed by evaluating sources and releases, the distribution of the stressor in the environment, and the extent and pattern of contact or co-occurrence. The order of these topics here is not necessarily the order in which they are executed. The assessor may start with information about tissue residues, for example, and attempt to link these residues with a source.

##### **4.2.1.1. *Describe the Source(s)***

A source can be defined in two general ways: as the place where the stressor originates or is released (e.g., a smokestack, historically contaminated sediments) or the management practice or action (e.g., dredging) that produces stressors. In some assessments, the original sources may no longer exist and the source may be defined as the current location of the stressors. For example, contaminated sediments might be considered a source because the industrial plant that produced the contaminants no longer operates. A source is the first component of the exposure pathway and significantly influences where and when stressors eventually will be found. In addition, many management alternatives focus on modifying the source.

Exposure analyses may start with the source when it is known, begin with known exposures and attempt to link them to sources, or start with known stressors and attempt to identify sources and quantify contact. In any case, the objective of this step is to identify the sources, evaluate what stressors are generated, and identify other potential sources. Text box 4-6 provides some useful questions to ask when describing sources.

In addition to identifying sources, the assessor examines the intensity, timing, and location of stressors' release. The location of a source and the environmental media that first receive stressors are two attributes that deserve particular attention. For chemical stressors, the source characterization

should also consider whether other constituents emitted by a source influence transport, transformation, or bioavailability of the stressor of interest. The presence of

chloride in the feedstock of a coal-fired power plant influences whether mercury is emitted in divalent (e.g., as mercuric chloride) or elemental form (Meij, 1991), for example. In the best case, stressor generation is measured or modeled quantitatively; however, sometimes it can only be qualitatively described.

Many stressors have natural counterparts or multiple sources, so it may be necessary to characterize these as well. Many chemicals occur naturally (e.g., most metals), are generally widespread from other sources (e.g., polycyclic aromatic hydrocarbons in urban ecosystems), or may have significant sources outside the boundaries of the current assessment (e.g., atmospheric nitrogen deposited in Chesapeake Bay). Many physical stressors also have natural counterparts. For instance, construction activities may release fine sediments into a stream in addition to those coming from a naturally undercut bank. Human activities may also change the magnitude or frequency of natural disturbance cycles. For example, development may decrease the frequency but increase the severity of fires or may increase the frequency and severity of flooding in a watershed.

The assessment scope identified during planning determines how multiple sources are evaluated. Options include (in order of increasing complexity):

#### **Text Box 4-6. Questions for Source Description**

- C Where does the stressor originate?
- C What environmental media first receive stressors?
- C Does the source generate other constituents that will influence a stressor's eventual distribution in the environment?
- C Are there other sources of the same stressor?
- C Are there background sources?
- C Is the source still active?
- C Does the source produce a distinctive signature that can be seen in the environment, organisms, or communities?

#### **Additional questions for introduction of biological stressors:**

- C Is there an opportunity for repeated introduction or escape into the new environment?
- C Will the organism be present on a transportable item?
- C Are there mitigation requirements or conditions that would kill or impair the organism before entry, during transport, or at the port of entry?

- Focus only on the source under evaluation and calculate the incremental risks attributable to that source (common for assessments initiated with an identified source or stressor).
- Consider all sources of a stressor and calculate total risks attributable to that stressor. Relative source attribution can be accomplished as a separate step (common for assessments initiated with an observed effect or an identified stressor).
- Consider all stressors influencing an assessment endpoint and calculate cumulative risks to that endpoint (common for assessments initiated because of concern for an ecological value).

Source characterization can be particularly important for introduced biological stressors, since many of the strategies for reducing risks focus on preventing entry in the first place. Once the source is identified, the likelihood of entry may be characterized qualitatively. In their risk analysis of Chilean log importation, for example, the assessment team concluded that the beetle *Hylurgus ligniperda* had a high potential for entry into the United States. Their conclusion was based on the beetle's attraction to freshly cut logs and tendency to burrow under the bark, which would provide protection during transport (USDA, 1993).

#### **4.2.1.2. Describe the Distribution of the Stressors or Disturbed Environment**

The second objective of exposure analysis is to describe the spatial and temporal distribution of stressors in the environment. For physical stressors that directly alter or eliminate portions of the environment, the assessor describes the temporal and spatial distribution of the disturbed environment. Because exposure occurs when receptors co-occur with or contact stressors, this characterization is a prerequisite for estimating exposure. Stressor distribution in the environment is examined by evaluating pathways from the source as well as the formation and subsequent distribution of secondary stressors (see text box 4-7).

**4.2.1.2.1. Evaluating Transport Pathways.** Stressors can be transported via many pathways (see text box 4-8). A careful evaluation can help ensure that measurements are taken in the appropriate media and locations and that models include the most important processes.

For a chemical stressor, the evaluation usually begins by determining into which media it can partition. Key considerations include physicochemical properties such as solubility and vapor pressure. For example, chemicals with low solubility in water tend to be found in environmental compartments with higher proportions of organic carbon such as soils, sediments, and biota. From there, the evaluation may examine the transport of the contaminated medium. Because chemical mixture constituents may have different properties, the analysis should consider how the composition of a mixture may change over time or as it moves through the environment. Guidance on evaluating the fate and transport of chemicals (including bioaccumulation) is beyond the scope of these Guidelines; readers are referred to the exposure assessment guidelines (U.S. EPA, 1992b) for additional information. The topics of bioaccumulation and biomagnification have been identified as candidates for further development.

The attributes of physical stressors also influence where they will go. The size of suspended particles determines where they will eventually deposit in a stream, for example. Physical stressors that eliminate ecosystems or portions of them (e.g., fishing activities or the construction of dams) may require no modeling of pathways—the fish are harvested or the valley is flooded. For these direct disturbances, the challenge is usually to evaluate secondary stressors and effects.

The dispersion of biological stressors has been described in two ways, as diffusion and jump-dispersal (Simberloff and Alexander, 1994). Diffusion involves a gradual spread from the establishment site and is primarily a function

#### **Text Box 4-7. Questions to Ask in Evaluating Stressor Distribution**

- C What are the important transport pathways?
- C What characteristics of the stressor influence transport?
- C What characteristics of the ecosystem will influence transport?
- C What secondary stressors will be formed?
- C Where will they be transported?

#### **Text Box 4-8. General Mechanisms of Transport and Dispersal**

##### **Physical, chemical, and biological stressors:**

- By air current
- In surface water (rivers, lakes, streams)
- Over and/or through the soil surface
- Through ground water

##### **Primarily chemical stressors:**

- Through the food web

##### **Primarily biological stressors:**

- Splashing or raindrops
- Human activity (boats, campers)
- Passive transmittal by other organisms
- Biological vectors

of reproductive rates and motility. Jump-dispersal involves erratic spreads over periods of time, usually by means of a vector. The gypsy moth and zebra mussel have spread this way, the gypsy moth via egg masses on vehicles and the zebra mussel via boat ballast water. Some biological stressors can use both strategies, which may make dispersal rates very difficult to predict. The evaluation should consider factors such as vector availability, attributes that enhance dispersal (e.g., ability to fly, adhere to objects, disperse reproductive units), and habitat or host needs.

For biological stressors, assessors should consider the additional factors of survival and reproduction. Organisms use a wide range of strategies to survive in adverse conditions; for example, fungi form resting stages such as sclerotia and chlamydo spores and some amphibians become dormant during drought. The survival of some organisms can be measured to some extent under laboratory conditions. However, it may be impossible to determine how long resting stages (e.g., spores) can survive under adverse conditions: many can remain viable for years. Similarly, reproductive rates may vary substantially depending on specific environmental conditions. Therefore, while life-history data such as temperature and substrate preferences, important predators, competitors or diseases, habitat needs, and reproductive rates are of great value, they should be interpreted with caution, and the uncertainty should be addressed by using several different scenarios.

Ecosystem characteristics influence the transport of all types of stressors. The challenge is to determine the particular aspects of the ecosystem that are most important. In some cases, ecosystem characteristics that influence distribution are known. For example, fine sediments tend to accumulate in areas of low energy in streams such as pools and backwaters. Other cases need more professional judgment. When evaluating the likelihood that an introduced organism will become established, for instance, it is useful to know whether the ecosystem is generally similar to or different from the one where the biological stressor originated. Professional judgment is used to determine which characteristics of the current and original ecosystems should be compared.

**4.2.1.2.2. *Evaluating Secondary Stressors.*** Secondary stressors can greatly alter conclusions about risk; they may be of greater or lesser concern than the primary stressor. Secondary stressor evaluation is usually part of exposure characterization; however, it should be coordinated with the ecological effects characterization to ensure that all potentially important secondary stressors are considered.

For chemicals, the evaluation usually focuses on metabolites, biodegradation products, or chemicals formed through abiotic processes. As an example, microbial action increases the bioaccumulation of mercury by transforming inorganic forms to organic species. Many azo dyes are not

toxic because of their large molecular size, but in an anaerobic environment, the polymer is hydrolyzed into more toxic water-soluble units. Secondary stressors can also be formed through ecosystem processes. Nutrient inputs into an estuary can decrease dissolved oxygen concentrations because they increase primary production and subsequent decomposition. Although transformation can be investigated in the laboratory, rates in the field may differ substantially, and some processes may be difficult or impossible to replicate in a laboratory. When evaluating field information, though, it may be difficult to distinguish between transformation processes (e.g., oil degradation by microorganisms) and transport processes (e.g., volatilization). Although they may be difficult to distinguish, the assessor should be aware that these two different processes will largely determine if secondary stressors are likely to be formed. A combination of these factors will also determine how much of the secondary stressor(s) may be bioavailable to receptors. These considerations reinforce the need to have a chemical risk assessment team experienced in physical/chemical as well as biological processes.

Physical disturbances can also generate secondary stressors, and identifying the specific consequences that will affect the assessment endpoint can be a difficult task. The removal of riparian vegetation, for example, can generate many secondary stressors, including increased nutrients, stream temperature, sedimentation, and altered stream flow. However, it may be the temperature change that is most responsible for adult salmon mortality in a particular stream.

Stressor distribution in the environment can be described using measurements, models, or a combination of the two. If stressors have already been released, direct measurement of environmental media or a combination of modeling and measurement is preferred. Models enhance the ability to investigate the consequences of different management scenarios and may be necessary if measurements are not possible or practicable. They are also useful if a quantitative relationship of sources and stressors is desired. As examples, land use activities have been related to downstream suspended solids concentrations (Oberts, 1981), and downstream flood peaks have been predicted from the extent of wetlands in a watershed (Novitski, 1979; Johnston et al., 1990). Considerations for evaluating data collection and modeling studies are discussed in section 4.1. For chemical stressors, readers may also refer to the exposure assessment guidelines (U.S. EPA, 1992b). For biological stressors, distribution may be difficult to predict quantitatively. If it cannot be measured, it can be evaluated qualitatively by considering the potential for transport, survival, and reproduction (see above).

By the end of this step, the environmental distribution of the stressor or the disturbed environment should be described. This description provides the foundation for estimating the contact or co-occurrence of the stressor with ecological entities. When contact is known to have occurred,



describing the stressor's environmental distribution can help identify potential sources and ensure that all important exposures are addressed.

#### 4.2.1.3. *Describe Contact or Co-Occurrence*

The third objective is to describe the extent and pattern of co-occurrence or contact between stressors and receptors (i.e., exposure). This is critical—if there is no exposure, there can be no risk. Therefore, assessors should be careful to include situations where exposure may occur in the future, where exposure has occurred in the past but is not currently evident (e.g., in some retrospective assessments), and where ecosystem components important for food or habitat are or may be exposed, resulting in impacts to the valued entity (e.g., see figure D-2). Exposure can be described in terms of stressor and receptor co-occurrence, actual stressor contact with receptors, or stressor uptake by a receptor. The terms in which exposure is described depend on how the stressor causes adverse effects and how the stressor-response relationship is described. Relevant questions for examining contact or co-occurrence are shown in text box 4-9.

Co-occurrence is particularly useful for evaluating stressors that can cause effects without physically contacting ecological receptors. Whooping cranes provide a case in point: they use sandbars in rivers for their resting areas, and they prefer sandbars with unobstructed views. Manmade obstructions such as bridges can interfere with resting behavior without ever actually contacting the birds. Co-occurrence is evaluated by comparing stressor distributions with that of the receptor. For instance, stressor location maps may be overlaid with maps of ecological receptors (e.g., bridge placement overlaid on maps showing historical crane resting habitat). Co-occurrence of a biological stressor and receptor may be used to evaluate exposure when, for example, introduced species and native species compete for the same resources. GIS has provided new tools for evaluating co-occurrence.

#### **Text Box 4-9. Questions To Ask in Describing Contact or Co-Occurrence**

- C Must the receptor actually contact the stressor for adverse effects to occur?
- C Must the stressor be taken up into a receptor for adverse effects to occur?
- C What characteristics of the receptors will influence the extent of contact or co-occurrence?
- C Will abiotic characteristics of the environment influence the extent of contact or co-occurrence?
- C Will ecosystem processes or community-level interactions influence the extent of contact or co-occurrence?

Most stressors must contact receptors to cause an effect. For example, tree roots must contact flood waters before their growth is impaired. Contact is a function of the amount or extent of a stressor in an environmental medium and activity or behavior of the receptors. For biological stressors, risk assessors usually rely on professional judgment; contact is often assumed to occur in areas and during times where the stressor and receptor are both present. Contact variables such as the mode of transmission between organisms may influence the contact between biological stressors and receptors.

For chemicals, contact is quantified as the amount of a chemical ingested, inhaled, or in material applied to the skin (potential dose). In its simplest form, it is quantified as an environmental concentration, with the assumptions that the chemical is well mixed or that the organism moves randomly through the medium. This approach is commonly used for respired media (water for aquatic organisms, air for terrestrial organisms). For ingested media (food, soil), another common approach combines modeled or measured contaminant concentrations with assumptions or parameters describing the contact rate (U.S. EPA, 1993b) (see text box 4-10).

Finally, some stressors must not only be contacted but also must be internally absorbed. A toxicant that causes liver tumors in fish, for example, must be absorbed and reach the target organ to cause the effect. Uptake is evaluated by considering the amount of stressor internally absorbed by an organism. It is a function of the stressor (e.g., a chemical's form or a pathogen's size), the medium (sorptive properties or presence of solvents), the biological membrane (integrity,

**Text Box 4-10. Example of an Exposure Equation: Calculating a Potential Dose via Ingestion**

$$ADD_{pot} = \sum_{k=1}^m (C_k \times FR_k \times NIR_k)$$

Where:

- $ADD_{pot}$  = Potential average daily dose (e.g., in mg/kg-day)
- $C_k$  = Average contaminant concentration in the  $k^{th}$  type of food (e.g., in mg/kg wet weight)
- $FR_k$  = Fraction of intake of the  $k^{th}$  food type that is from the contaminated area (unitless)
- $NIR_k$  = Normalized ingestion rate of the  $k^{th}$  food type on a wet-weight basis (e.g., in kg food/kg body-weight-day).
- $m$  = Number of contaminated food types

Note: A similar equation can be used to calculate uptake by adding an absorption factor that accounts for the fraction of the chemical in the  $k^{th}$  food type that is absorbed into the organism. The choice of potential dose or uptake depends on the form of the stressor-response relationship.

Source: U.S. EPA, 1993b.

permeability), and the organism (sickness, active uptake) (Suter et al., 1994). Because of interactions between these four factors, uptake will vary on a situation-specific basis. Uptake is usually assessed by modifying an estimate of contact with a factor indicating the proportion of the stressor that is available for uptake (the bioavailable fraction) or actually absorbed. Absorption factors and bioavailability measured for the chemical, ecosystem, and organism of interest are preferred. Internal dose can also be evaluated by using a pharmacokinetic model or by measuring biomarkers or residues in receptors (see text box 4-11). Most stressor-response relationships express the amount of stressor in terms of media concentration or potential dose rather than internal dose; this limits the utility of uptake estimates in risk calculations. However, biomarkers and tissue residues can provide valuable confirmatory evidence that exposure has occurred, and tissue residues in prey organisms can be used for estimating risks to their predators.

#### **Text Box 4-11. Measuring Internal Dose Using Biomarkers and Tissue Residues**

Biomarkers and tissue residues are particularly useful when exposure across many pathways must be integrated and when site-specific factors influence bioavailability. They can also be very useful when metabolism and accumulation kinetics are important, although these factors can make interpretation of results more difficult (McCarty and Mackay, 1993). These methods are most useful when they can be quantitatively linked to the amount of stressor originally contacted by the organism. In addition, they are most useful when the stressor-response relationship expresses the amount of stressor in terms of the tissue residue or biomarker (van Gestel and van Brummelen, 1996). Standard analytical methods are generally available for tissue residues, making them more readily usable for routine assessments than biomarkers. Readers are referred to the review in *Ecotoxicology* (Vol. 3, Issue 3, 1994), Huggett et al. (1992), and the debate in *Human Health and Ecological Risk Assessment* (Vol. 2, Issue 2, 1996).

The characteristics of the ecosystem and receptors must be considered to reach appropriate conclusions about exposure. Abiotic attributes may increase or decrease the amount of a stressor contacted by receptors. For example, naturally anoxic areas above contaminated sediments in an estuary may reduce the time bottom-feeding fish spend in contact with sediments and thereby reduce their exposure to contaminants. Biotic interactions can also influence exposure. For example, competition for high-quality resources may force some organisms into disturbed areas. The interaction between exposure and receptor behavior can influence both initial and subsequent exposures. Some chemicals reduce the prey's ability to escape predators, for instance, and thereby may increase predator exposure to the chemical as well as the prey's risk of predation. Alternatively, organisms may

avoid areas, food, or water with contamination they can detect. While avoidance can reduce exposure to chemicals, it may increase other risks by altering habitat usage or other behavior.

Three dimensions should be considered when estimating exposure: intensity, time, and space. Intensity is the most familiar dimension for chemical and biological stressors and may be expressed as the amount of chemical contacted per day or the number of pathogenic organisms per unit area.

The temporal dimension of exposure has aspects of duration, frequency, and timing. Duration can be expressed as the time over which exposure occurs, some threshold intensity is exceeded, or intensity is integrated. If exposure occurs as repeated discrete events of about the same duration, frequency is the important temporal dimension of exposure (e.g., the frequency of high-flow events in streams). If the repeated events have significant and variable durations, both duration and frequency should be considered. In addition, the timing of exposure, including the order or sequence of events, can be an important factor. Adirondack Mountain lakes receive high concentrations of hydrogen ions and aluminum during snow melt; this period also corresponds to the sensitive life stages of some aquatic organisms.

In chemical assessments, intensity and time are often combined by averaging intensity over time. The duration over which intensity is averaged is determined by considering the ecological effects of concern and the likely pattern of exposure. For example, an assessment of bird kills associated with granular carbofuran focused on short-term exposures because the effect of concern was acute lethality (Houseknecht, 1993). Because toxicological tests are usually conducted using constant exposures, the most realistic comparisons between exposure and effects are made when exposure in the real world does not vary substantially. In these cases, the arithmetic average exposure over the time period of toxicological significance is the appropriate statistic (U.S. EPA, 1992b). However, as concentrations or contact rates become more episodic or variable, the arithmetic average may not reflect the toxicologically significant aspect of the exposure pattern. In extreme cases, averaging may not be appropriate at all, and assessors may need to use a toxicodynamic model to assess chronic effects.

Spatial extent is another dimension of exposure. It is most commonly expressed in terms of area (e.g., hectares of paved habitat, square meters that exceed a particular chemical threshold). At larger spatial scales, however, the shape or arrangement of exposure may be an important issue, and area alone may not be the appropriate descriptor of spatial extent for risk assessment. A general solution to the problem of incorporating pattern into ecological assessments has yet to be developed; however, landscape ecology and GIS have greatly expanded the options for analyzing and presenting the spatial dimension of exposure (e.g., Pastorok et al., 1996).

The results of exposure analysis are summarized in the exposure profile, which is discussed in the next section.

#### 4.2.2. Exposure Profile

The final product of exposure analysis is an exposure profile. Exposure should be described in terms of intensity, space, and time in units that can be combined with the effects assessment. The assessor should summarize the paths of stressors from the source to the receptors, completing the exposure pathway. Depending on the risk assessment, the profile may be a written document or a module of a larger process model. In any case, the objective is to ensure that the information needed for risk characterization has been collected and evaluated. In addition, compiling the exposure profile provides an opportunity to verify that the important exposure pathways identified in the conceptual model were evaluated.

The exposure profile identifies the receptor and describes the exposure pathways and intensity and spatial and temporal extent of co-occurrence or contact. It also describes the impact of variability and uncertainty on exposure estimates and reaches a conclusion about the likelihood that exposure will occur (see text box 4-12).

The profile should describe the applicable exposure pathways. If exposure can occur through many pathways, it may be useful to rank them, perhaps by contribution to total exposure. As an illustration, consider an assessment of risks to grebes feeding in a

mercury-contaminated lake. The grebes may be exposed to methyl mercury in fish that originated from historically contaminated sediments. They may also be exposed by drinking lake water, but comparing the two exposure pathways may show that the fish pathway contributes the vast majority of exposure to mercury.

The profile should identify the ecological entity that the exposure estimates represent. For example, the exposure estimates may describe the local population of grebes feeding on a specific lake during the summer months.

#### **Text Box 4-12. Questions Addressed by the Exposure Profile**

- C How does exposure occur?
- C What is exposed?
- C How much exposure occurs? When and where does it occur?
- C How does exposure vary?
- C How uncertain are the exposure estimates?
- C What is the likelihood that exposure will occur?

The assessor should explain how each of the three general dimensions of exposure (intensity, time, and space) was treated. Continuing with the grebe example, exposure might be expressed as the daily potential dose averaged over the summer months and over the extent of the lake.

The profile should also describe how exposure can vary depending on receptor attributes or stressor levels. For instance, the exposure may be higher for grebes eating a larger proportion of bigger, more contaminated fish. Variability can be described by using a distribution or by describing where a point estimate is expected to fall on a distribution. Cumulative-distribution functions (CDFs) and probability-density functions (PDFs) are two common presentation formats (see Appendix B, figures B-1 and B-2). Figures 5-3 to 5-5 show examples of cumulative frequency plots of exposure data. The point estimate/descriptor approach is used when there is not enough information to describe a distribution. Descriptors discussed in U.S. EPA, 1992b, are recommended, including *central tendency* to refer to the mean or median of the distribution, *high end* to refer to exposure estimates that are expected to fall between the 90th and 99.9th percentile of the exposure distribution, and *bounding estimates* to refer to those higher than any actual exposure.

The exposure profile should summarize important uncertainties (e.g., lack of knowledge; see section 4.1.3 for a discussion of the different sources of uncertainty). In particular, the assessor should:

- Identify key assumptions and describe how they were handled
- Discuss (and quantify, if possible) the magnitude of sampling and/or measurement error
- Identify the most sensitive variables influencing exposure
- Identify which uncertainties can be reduced through the collection of more data.

Uncertainty about a quantity's true value can be shown by calculating error bounds on a point estimate, as shown in figure 5-2.

All of the above information is synthesized to reach a conclusion about the likelihood that exposure will occur, completing the exposure profile. It is one of the products of the analysis phase and is combined with the stressor-response profile (the product of the ecological effects characterization discussed in the next section) during risk characterization.

### **4.3. CHARACTERIZATION OF ECOLOGICAL EFFECTS**

To characterize ecological effects, the assessor describes the effects elicited by a stressor, links them to the assessment endpoints, and evaluates how they change with varying stressor levels. The characterization begins by evaluating effects data to specify the effects that are elicited, verify that they are consistent with the assessment endpoints, and confirm that the conditions under which they occur are consistent with the conceptual model. Once the effects of interest are identified, the assessor conducts an ecological response analysis (section 4.3.1), evaluating how the magnitude of the effects change with varying stressor levels and the evidence that the stressor causes the effect, and then linking the effects with the assessment endpoint. Conclusions are summarized in a stressor-response profile (section 4.3.2).

#### **4.3.1. Ecological Response Analysis**

Ecological response analysis examines three primary elements: the relationship between stressor levels and ecological effects (section 4.3.1.1), the plausibility that effects may occur or are occurring as a result of exposure to stressors (section 4.3.1.2), and linkages between measurable ecological effects and assessment endpoints when the latter cannot be directly measured (section 4.3.1.3).

##### **4.3.1.1. *Stressor-Response Analysis***

To evaluate ecological risks, one must understand the relationships between stressors and resulting responses. The stressor-response relationships used in a particular assessment depend on the scope and nature of the ecological risk assessment as defined in problem formulation and reflected in the analysis plan. For example, an assessor may need a point estimate of an effect (such as an  $LC_{50}$ ) to compare with point estimates from other stressors. The shape of the stressor-response curve may be needed to determine the presence or absence of an effects threshold or for evaluating incremental risks, or stressor-response curves may be used as input for effects models. If sufficient data are available, the risk assessor may construct cumulative distribution functions using multiple-point estimates of effects. Or the assessor may use process models that already incorporate empirically derived stressor-response relationships (see section 4.3.1.3). Text box 4-13 provides some questions for stressor-response analysis.

This section describes a range of stressor-response approaches available to risk assessors following a theme of variations on the classical stressor-response relationship (e.g., figure 4-2). More complex relationships are shown in figure 4-3, which illustrates a range of projected responses of

zooplankton populations to pesticide exposure based on laboratory tests. In field studies, the complexity of these responses could increase even further, considering factors such as potential indirect effects of pesticides on zooplankton populations (e.g., competitive interactions between species). More complex patterns can also occur at higher levels of biological organization; ecosystems may respond to stressors with abrupt shifts to new community or system types (Holling, 1978).

In simple cases, one response variable (e.g., mortality, incidence of abnormalities) is analyzed, and most quantitative techniques have been developed for univariate analysis. If the response of interest is composed of many

**Text Box 4-13. Questions for Stressor-Response Analysis**

- C Does the assessment require point estimates or stressor-response curves?
- C Does the assessment require the establishment of a “no-effect” level?
- C Would cumulative effects distributions be useful?
- C Will analyses be used as input to a process model?



individual variables (e.g., species

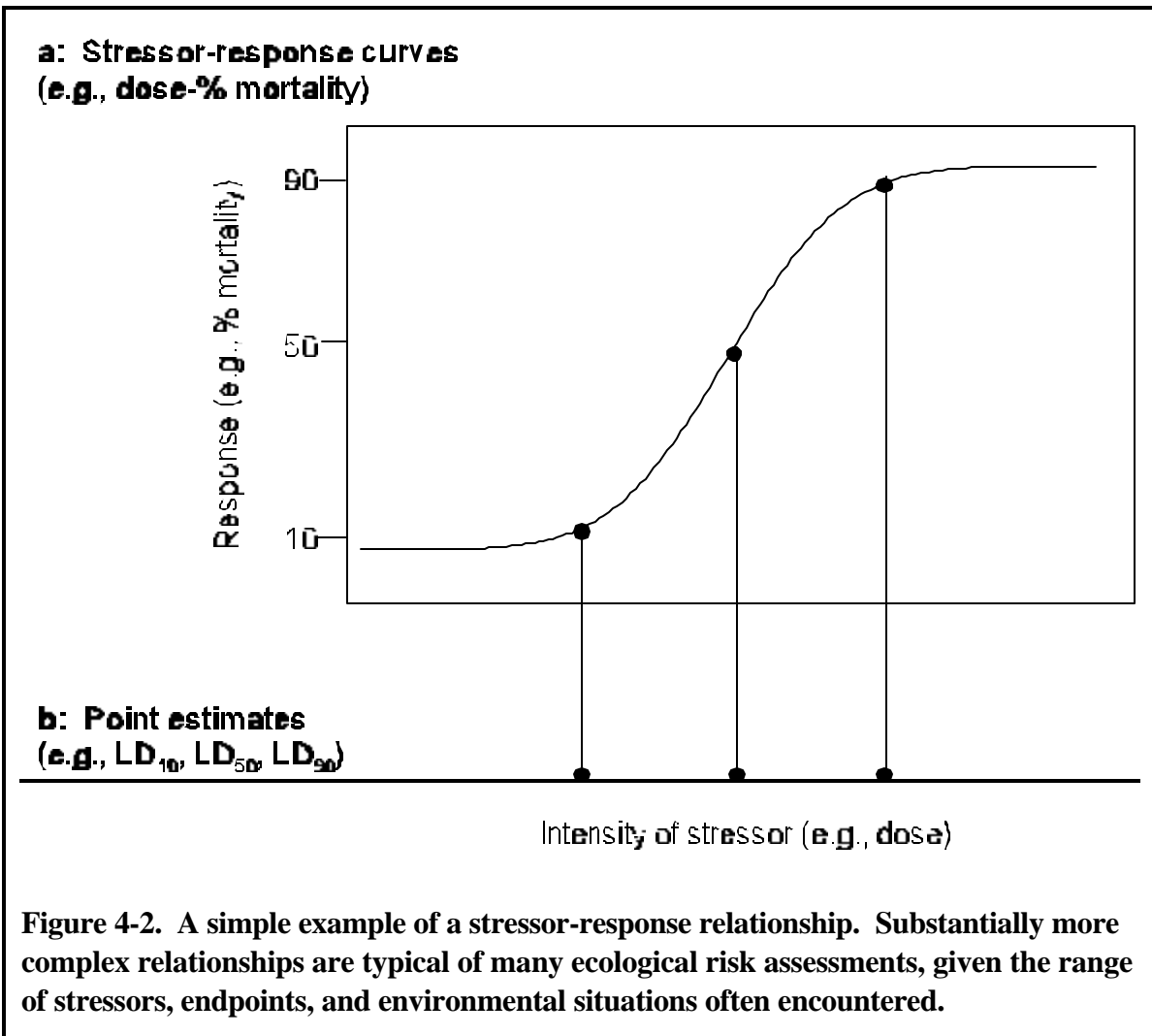

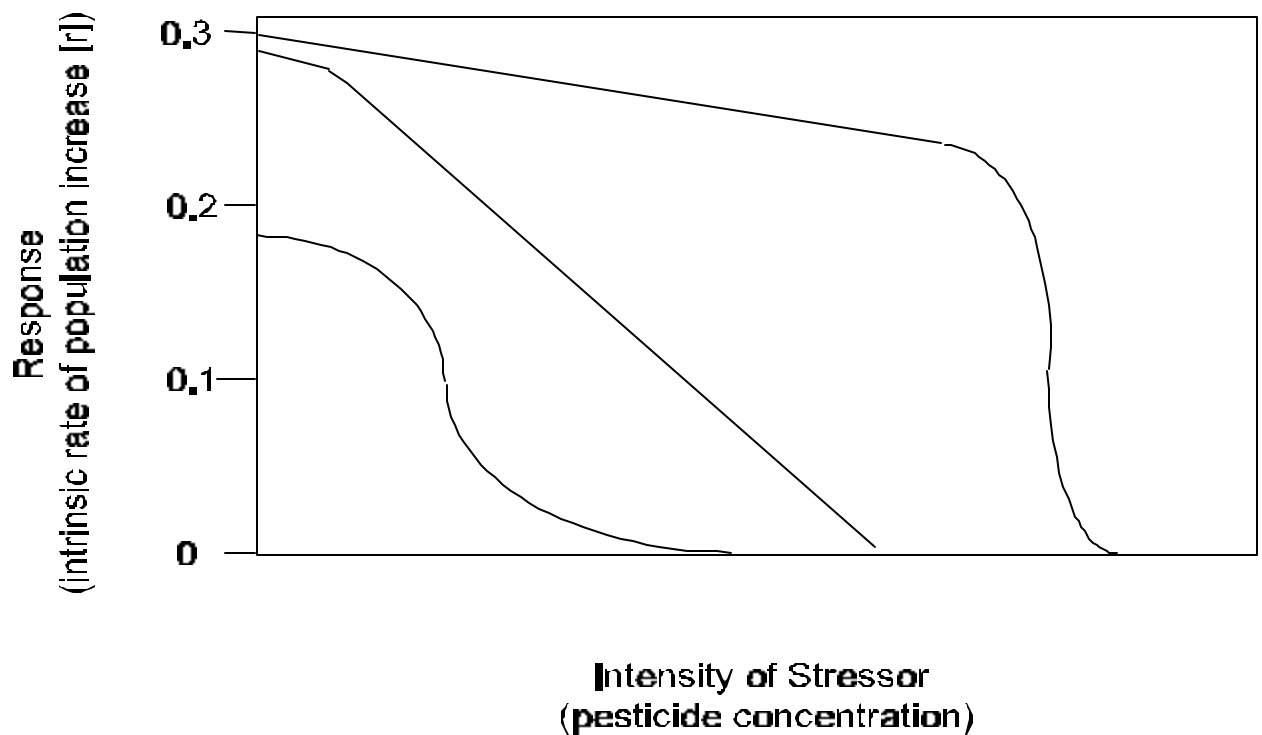

**Figure 4-3. Variations in stressor-response relationships. These curves illustrate a range of responses to pesticide exposure of the intrinsic rate of increase of zooplankton populations (adapted from Schindler, 1987).**

abundances in an aquatic community), multivariate techniques may be useful. These have a long history of use in ecology (see texts by Gauch, 1982; Pielou, 1984; Ludwig and Reynolds, 1988) but have not yet been extensively applied in risk assessment. While quantifying stressor-response relationships is encouraged, qualitative evaluations are also possible (text box 4-14).

Stressor-response relationships can be described using intensity, time, or space. Intensity is probably the most familiar of these and is often used for chemicals (e.g., dose, concentration). Exposure duration is also

**Text Box 4-14. Qualitative Stressor-Response Relationships**

The relationship between stressor and response can be described qualitatively, for instance, using categories of high, medium, and low, to describe the intensity of response given exposure to a stressor. For example, Pearlstine et al. (1985) assumed that seeds would not germinate if they were inundated with water at the critical time. This stressor-response relationship was described simply as a yes or no. In most cases, however, the objective is to describe quantitatively the intensity of response associated with exposure, and in the best case, to describe how intensity of response changes with incremental increases in exposure.

commonly used for chemical stressor-response relationships; for example, median acute effects levels are always associated with a time parameter (e.g., 24 hours). As noted in text box 4-14, the timing of exposure was the critical dimension in evaluating the relationship between seed germination and soil moisture (Pearlstone et al., 1985). The spatial dimension is often of concern for physical stressors. For instance, the extent of suitable habitat was related to the probability of sighting a spotted owl (Thomas et al., 1990), and water-table depth was related to tree growth by Phipps (1979).

Single-point estimates and stressor-response curves can be generated for some biological stressors. For pathogens such as bacteria and fungi, inoculum levels (e.g., spores per milliliter; propagules per unit of substrate) may be related to symptoms in a host (e.g., lesions per area of leaf surface, total number of plants infected) or actual signs of the pathogen (asexual or sexual fruiting bodies, sclerotia, etc.). For other biological stressors such as introduced species, simple stressor-response relationships may be inappropriate.

Data from individual experiments can be used to develop curves and point estimates both with and without associated uncertainty estimates (see figures 5-2 and 5-3). The advantages of curve-fitting approaches include using all of the available experimental data and the ability to interpolate to values other than the data points measured. If extrapolation outside the range of experimental data is required, risk assessors should justify that the observed experimental relationships remain valid. A disadvantage of curve fitting is that the number of data points required to complete an analysis may not always be available. For example, while standard toxicity tests with aquatic organisms frequently contain sufficient experimental treatments to permit regression analysis, this is often not the case for toxicity tests with wildlife species.

Risk assessors sometimes use curve-fitting analyses to determine particular levels of effect. These point estimates are interpolated from the fitted line. Point estimates may be adequate for simple assessments or comparative studies of risk and are also useful if a decision rule for the assessment was identified during the planning phase (see section 2). Median effect levels (text box 4-15) are frequently selected because the level of uncertainty is minimized at

#### **Text Box 4-15. Median Effect Levels**

Median effects are those effects elicited in 50% of the test organisms exposed to a stressor, typically chemical stressors. Median effect concentrations can be expressed in terms of lethality or mortality and are known as  $LC_{50}$  or  $LD_{50}$ , depending on whether concentrations (in the diet or in water) or doses (mg/kg) were used. Median effects other than lethality (e.g., effects on growth) are expressed as  $EC_{50}$  or  $ED_{50}$ . The median effect level is always associated with a time parameter (e.g., 24 or 48 hours). Because these tests seldom exceed 96 hours, their main value lies in evaluating short-term effects of chemicals. Stephan (1977) discusses several statistical methods to estimate the median effect level.

the midpoint of the regression curve. While a 50% effect level for an endpoint such as survival may not be appropriately protective for the assessment endpoint, median effect levels can be used for preliminary assessments or comparative purposes, especially when used in combination with uncertainty modifying factors (see text box 5-3). Selection of a different effect level (10%, 20%, etc.) can be arbitrary unless there is some clearly defined benchmark for the assessment endpoint. Thus, it is preferable to carry several levels of effect or the entire stressor-response curve forward to risk estimation.

When risk assessors are particularly interested in effects at lower stressor levels, they may seek to establish “no-effect” stressor levels based on comparisons between experimental treatments and controls. Statistical hypothesis testing is frequently used for this purpose. (Note that statistical hypotheses are different from the risk hypotheses discussed in problem formulation; see text box 3-12). An example of this approach for deriving chemical no-effect

levels is provided in text box 4-16. A feature of statistical hypothesis testing is that the risk assessor is not required to pick a particular effect level of concern. The no-effect level is determined instead by experimental conditions such as the number of replicates as well as the variability inherent in the data. Thus it is important to consider the level of effect detectable in the experiment (i.e., its power) in addition to reporting the no-effect level. Another drawback of this approach is that it is difficult to evaluate effects associated with stressor levels other than the actual treatments tested. Several investigators (Stephan and Rogers, 1985; Suter, 1993a) have proposed using regression analysis as an alternative to statistical hypothesis testing.

In observational field studies, statistical hypothesis testing is often used to compare site conditions with a reference site(s). The difficulties of drawing proper conclusions from these types of studies (which frequently cannot

#### **Text Box 4-16. No-Effect Levels Derived From Statistical Hypothesis Testing**

Statistical hypothesis tests have typically been used with chronic toxicity tests of chemical stressors that evaluate multiple endpoints. For each endpoint, the objective is to determine the highest test level for which effects are not statistically different from the controls (the no-observed-adverse-effect level, NOAEL) and the lowest level at which effects were statistically significant from the control (the lowest-observed-adverse-effect level, LOAEL). The range between the NOAEL and the LOAEL is sometimes called the maximum acceptable toxicant concentration, or MATC. The MATC, which can also be reported as the geometric mean of the NOAEL and the LOAEL (i.e., GMATC), provides a useful reference with which to compare toxicities of various chemical stressors.

Reporting the results of chronic tests in terms of the MATC or GMATC has been widely used within the Agency for evaluating pesticides and industrial chemicals (e.g., Urban and Cook, 1986; Nabholz, 1991).

employ replication) have been discussed by many investigators (see section 4.1.1). Risk assessors should examine whether sites were carefully matched to minimize differences other than the stressor and consider whether potential covariates should be included in any analysis. In contrast with observational studies, an advantage of experimental field studies is that treatments can be replicated, increasing the confidence that observed differences are due to the treatment.

Experimental data can be combined to generate multiple-point estimates that can be displayed as cumulative distribution functions. Figure 5-5 shows an example for species sensitivity derived from multiple-point estimates (EC<sub>5</sub>s) for freshwater algae (and one vascular plant species) exposed to an herbicide. These distributions can help identify stressor levels that affect a minority or majority of species. A limiting factor in the use of cumulative frequency distributions is the amount of data needed as input. Cumulative effects distribution functions can also be derived from models that use Monte Carlo or other methods to generate distributions based on measured or estimated variation in input parameters for the models.

When multiple stressors are present, stressor-response analysis is particularly challenging. Stressor-response relationships can be constructed for each stressor separately and then combined. Alternatively, the relationship between response and the suite of stressors can be combined in one analysis. It is preferable to directly evaluate complex chemical mixtures present in environmental media (e.g., wastewater effluents, contaminated soils [U.S. EPA, 1986b]), but it is important to consider the relationship between the samples tested and the potential spatial and temporal variability in the mixture. The approach taken for multiple stressors depends on the feasibility of measuring them and whether an objective of the assessment is to project different stressor combinations.

In some cases, multiple regression analysis can be used to empirically relate multiple stressors to a response. Detenbeck (1994) used this approach to evaluate change in the water quality of wetlands resulting from multiple physical stressors. Multiple regression analysis can be difficult to interpret if the explanatory variables (i.e., the stressors) are not independent. Principal components analysis can be used to extract independent explanatory variables formed from linear combinations of the original variables (Pielou, 1984).

#### **4.3.1.2. *Establishing Cause-and-Effect Relationships (Causality)***

Causality is the relationship between cause (one or more stressors) and effect (response to the stressor[s]). Without a sound basis for linking cause and effect, uncertainty in the conclusions of an ecological risk assessment is likely to be high. Developing causal relationships is especially important for risk assessments driven by observed adverse ecological effects such as bird or fish kills or a shift in

the species composition of an area. This section describes considerations for evaluating causality based on criteria developed by Fox (1991) primarily for observational data and additional criteria for experimental evaluation of causality modified from Koch's postulates (e.g., see Woodman and Cowling, 1987).

Evidence of causality may be derived from observational evidence (e.g., bird kills are associated with field application of a pesticide) or experimental data (laboratory tests with the pesticides in question show bird kills at levels similar to those found in the field), and causal associations can be strengthened when both types of information are available. But since not all situations lend themselves to formal experimentation, scientists have looked for other criteria, based largely on observation rather than experiment, to support a plausible argument for cause and effect. Text box 4-17 provides criteria based on Fox (1991) that are very similar to others reviewed by Fox (U.S. Department of Health, Education, and Welfare, 1964; Hill, 1965; Susser, 1986a, b). While data to support some criteria may be incomplete or missing for any given assessment, these criteria offer a useful way to evaluate available information.

The strength of association between stressor and response is often the main reason that adverse effects such as bird kills are linked to specific events or actions. A stronger response to a hypothesized cause is more likely to indicate true causation. Additional strong evidence of causation is when a response follows after a change in the hypothesized cause (predictive performance).

The presence of a biological gradient or stressor-response relationship is another important criterion for causality. The stressor-response relationship need not be linear. It can be a threshold, sigmoidal, or parabolic phenomenon, but in any case it is important that

**Text Box 4-17. General Criteria for Causality** (Adapted From Fox, 1991)

**Criteria strongly affirming causality:**

- Strength of association
- Predictive performance
- Demonstration of a stressor-response relationship
- Consistency of association

**Criteria providing a basis for rejecting causality:**

- Inconsistency in association
- Temporal incompatibility
- Factual implausibility

**Other relevant criteria:**

- Specificity of association
- Theoretical and biological plausibility

it can be demonstrated. Biological gradients, such as effects that decrease with distance from a toxic discharge, are frequently used as evidence of causality. To be credible, such relationships should be consistent with current biological or ecological knowledge (biological plausibility).

A cause-and-effect relationship that is demonstrated repeatedly (consistency of association) provides strong evidence of causality. Consistency may be shown by a greater number of instances of association between stressor and response, occurrences in diverse ecological systems, or associations demonstrated by diverse methods (Hill, 1965). Fox (1991) adds that in ecoepidemiology, an association's occurrence in more than one species and population is very strong evidence for causation. An example would be the many bird species killed by carbofuran applications (Houseknecht, 1993). Fox (1991) also believes that causality is supported if the same incident is observed by different persons under different circumstances and at different times.

Conversely, inconsistency in association between stressor and response is strong evidence against causality (e.g., the stressor is present without the expected effect, or the effect occurs but the stressor is not found). Temporal incompatibility (i.e., the presumed cause does not precede the effect) and incompatibility with experimental or observational evidence (factual implausibility) are also indications against a causal relationship.

Two other criteria may be of some help in defining causal relationships: specificity of an association and probability. The more specific or diagnostic the effect, the more likely it is to have a consistent cause. However, Fox (1991) argues that effect specificity does little to strengthen a causal claim. Disease can have multiple causes, a substance can behave differently in different environments or cause several different effects, and biochemical events may elicit many biological responses. But in general, the more specific or localized the effects, the easier it is to identify the cause.

Sometimes, a stressor may have a distinctive mode of action that suggests its role. Yoder and Rankin (1995) found that patterns of change observed in fish and benthic invertebrate communities could serve as indicators for different types of anthropogenic impact (e.g., nutrient enrichment vs. toxicity).

For some pathogenic biological stressors, the causal evaluations proposed by Koch (see text box 4-18) may be useful. For

**Text Box 4-18. Koch's Postulates (Pelczar and Reid, 1972)**

- A pathogen must be consistently found in association with a given disease.
- The pathogen must be isolated from the host and grown in pure culture.
- When inoculated into test animals, the same disease symptoms must be expressed.
- The pathogen must again be isolated from the test organism.

chemicals, ecotoxicologists have slightly modified Koch's postulates to provide evidence of causality (Suter, 1993a). The modifications are:

- The injury, dysfunction, or other putative effect of the toxicant must be regularly associated with exposure to the toxicant and any contributory causal factors.
- Indicators of exposure to the toxicant must be found in the affected organisms.
- The toxic effects must be seen when organisms or communities are exposed to the toxicant under controlled conditions, and any contributory factors should be manifested in the same way during controlled exposures.
- The same indicators of exposure and effects must be identified in the controlled exposures as in the field.

These modifications are conceptually identical to Koch's postulates. While useful, this approach may not be practical if resources for experimentation are not available or if an adverse effect may be occurring over such a wide spatial extent that experimentation and correlation may prove difficult or yield equivocal results.

Woodman and Cowling (1987) provide a specific example of a causal evaluation. They proposed three rules for establishing the effects of airborne pollutants on the health and productivity of forests: (1) the injury or dysfunction symptoms observed in the case of individual trees in the forest must be associated consistently with the presence of the suspected causal factors, (2) the same injury or dysfunction symptoms must be seen when healthy trees are exposed to the suspected causal factors under controlled conditions, and (3) natural variation in resistance and susceptibility observed in forest trees also must be seen when clones of the same trees are exposed to the suspected causal factors under controlled conditions.

Experimental techniques are frequently used for evaluating causality in complex chemical mixtures. Options include evaluating separated components of the mixture, developing and testing a synthetic mixture, or determining how a mixture's toxicity relates to that of individual components. The choice of method depends on the goal of the assessment and the resources and test data that are available.



Laboratory toxicity identification evaluations (TIEs) can be used to help determine which components of a chemical mixture cause toxic effects. By using fractionation and other methods, the TIE approach can help identify chemicals responsible for toxicity and show the relative contributions of different chemicals in aqueous effluents (U.S. EPA, 1988a, 1989b, c) and sediments (e.g., Ankley et al., 1990).

Risk assessors may utilize data from synthetic chemical mixtures if the individual chemical components are well characterized. This approach allows for manipulation of the mixture and investigation of how varying the components that are present or their ratios may affect mixture toxicity, but it also requires additional assumptions about the relationship between effects of the synthetic mixture and those of the environmental mixture. (See section 5.1.3 for additional discussion of mixtures.)

#### **4.3.1.3. *Linking Measures of Effect to Assessment Endpoints***

Assessment endpoints express the environmental values of concern for a risk assessment, but they cannot always be measured directly. When measures of effect differ from assessment endpoints, sound and explicit linkages between them are needed. Risk assessors may make these linkages in the analysis phase or, especially when linkages rely on professional judgment, work with measures of effect through risk estimation (in risk characterization) and then connect them with assessment endpoints. Common extrapolations used to link measures of effect with assessment endpoints are shown in text box 4-19.

**4.3.1.3.1. *General Considerations.*** During the preparation of the analysis plan, risk assessors identify the extrapolations required between assessment endpoints and measures of effect. During the analysis phase, risk assessors

#### **Text Box 4-19. Examples of Extrapolations To Link Measures of Effect to Assessment Endpoints**

Every risk assessment has data gaps that should be addressed, but it is not always possible to obtain more information. When there is a lack of time, monetary resources, or a practical means to acquire more data, extrapolations such as those listed below may be the only way to bridge gaps in available data. Extrapolations may be:

- Between taxa (e.g., bluegill to rainbow trout)
- Between responses (e.g., mortality to growth or reproduction)
- From laboratory to field
- Between geographic areas
- Between spatial scales
- From data collected over a short time frame to longer-term effects

should revisit the questions listed in text box 4-20 before proceeding with specific extrapolation approaches.

The nature of the risk assessment and the type and amount of data that are available largely determine how conservative a risk assessment will be. The early stages of a tiered risk assessment typically use conservative estimates because the data needed to adequately assess exposure and effects are usually lacking. When a risk has been identified, subsequent tiers use additional data to address the uncertainties that were incorporated into the initial assessment(s) (see text box 2-8).

The scope of the risk assessment also influences extrapolation through the nature of the assessment endpoint. Preliminary assessments that evaluate risks to general trophic levels such as herbivores may extrapolate between different genera or families to obtain a range of sensitivity to the stressor. On the other hand, assessments concerned with management strategies for a particular species may employ population models.

Analysis phase activities may suggest additional extrapolation needs. Evaluation of exposure may indicate different spatial or temporal scales than originally planned. If spatial scales are broadened, additional receptors may need to be included in extrapolation models. If a stressor persists for an extended time, it may be necessary to extrapolate short-term responses over a longer exposure period, and population-level effects may become more important. Whatever methods are employed to link assessment endpoints with measures of effect, it is important to apply them in a manner consistent with sound ecological principles and use enough appropriate data. For example, it is inappropriate to use structure-activity relationships to predict toxicity from chemical structure unless the chemical under consideration has a similar mode of toxic action to the reference chemicals (Bradbury, 1994). Similarly, extrapolations between two species may be more credible if factors such as similarities in food preferences, body mass, physiology, and seasonal behavior (e.g., mating and migration habits) are considered (Sample et al., 1996). Rote or biologically implausible extrapolations will erode the assessment's overall credibility.

**Text Box 4-20. Questions Related to Selecting Extrapolation Approaches**

- C How specific is the assessment endpoint?
- C Does the spatial or temporal extent of exposure suggest the need for additional receptors or extrapolation models?
- C Are the quantity and quality of the data available sufficient for planned extrapolations and models?
- C Is the proposed extrapolation technique consistent with ecological information?
- C How much uncertainty is acceptable?

Finally, many extrapolation methods are limited by the availability of suitable databases. Although many data are available for chemical stressors and aquatic species, they do not exist for all taxa or effects. Chemical effects databases for wildlife, amphibians, and reptiles are extremely limited, and there is even less information on most biological and physical stressors. Risk assessors should be aware that extrapolations and models are only as useful as the data on which they are based and should recognize the great uncertainties associated with extrapolations that lack an adequate empirical or process-based rationale.

The rest of this section addresses the approaches used by risk assessors to link measures of effect to assessment endpoints, as noted below.

- Linkages based on professional judgment. This is not as desirable as empirical or process-based approaches, but is the only option when data are lacking.
- Linkages based on empirical or process models. Empirical extrapolations use experimental or observational data that may or may not be organized into a database. Process-based approaches rely on some level of understanding of the underlying operations of the system of interest.

#### ***4.3.1.3.2. Judgment Approaches for Linking Measures of Effect to Assessment Endpoints.***

Professional-judgment approaches rely on the professional expertise of risk assessors, expert panels, or others to relate changes in measures of effect to changes in assessment endpoints. They are essential when databases are inadequate to support empirical models and process models are unavailable or inappropriate. Professional-judgment linkages between measures of effect and assessment endpoints can be just as credible as empirical or process-based expressions, provided they have a sound scientific basis. This section highlights professional-judgment extrapolations between species, from laboratory data to field effects, and between geographic areas.

Because of the uncertainty in predicting the effects of biological stressors such as introduced species, professional-judgment approaches are commonly used. For example, there may be measures of effect data on a foreign pathogen that attacks a certain tree species not found in the United States, but the assessment endpoint concerns the survival of a commercially important tree found only in the United States. In this case, a careful evaluation and comparison of the life history and environmental requirements of both the pathogen and the two tree species may contribute toward a useful

determination of potential effects, even though the uncertainty may be high. Expert panels are typically used for this kind of evaluation (USDA, 1993).

Risks to organisms in field situations are best estimated from studies at the site of interest. However, such data are not always available. Frequently, risk assessors must extrapolate from laboratory toxicity test data to field effects. Text box 4-21 summarizes some of the considerations for risk assessors when extrapolating from laboratory test results to field situations for chemical stressors. Factors altering exposure in the field are among the most important factors limiting extrapolations from laboratory test results, but indirect effects on exposed organisms due to predation, competition, or other biotic or abiotic factors not evaluated in the laboratory may also be significant. Variations in direct chemical effects between laboratory tests and field situations may not contribute as much to the overall uncertainty of the extrapolation.

In addition to single-species tests, laboratory multiple-species tests are sometimes used to predict field effects. While these tests have the advantage of evaluating some aspects of a real ecological system, they also have inherent scale limitations (e.g., lack of top trophic levels) and may not adequately represent features of the field system important to the assessment endpoint.

Extrapolations based on professional judgment are frequently required when assessors wish to use field data obtained from one geographic area and apply them to a different area of concern, or to extrapolate from the results of laboratory tests to more than one geographic region. In either case, risk assessors

**Text Box 4-21. Questions To Consider When Extrapolating From Effects Observed in the Laboratory to Field Effects of Chemicals**

**Exposure factors:**

- C How will environmental fate and transformation of the chemical affect exposure in the field?
- C How comparable are exposure conditions and the timing of exposure?
- C How comparable are the routes of exposure?
- C How do abiotic factors influence bioavailability and exposure?
- C How likely are preference or avoidance behaviors?

**Effects factors:**

- C What is known about the biotic and abiotic factors controlling populations of the organisms of concern?
- C To what degree are critical life-stage data available?
- C How may exposure to the same or other stressors in the field have altered organism sensitivity?

should consider variations between regions in environmental conditions, spatial scales and heterogeneities, and ecological forcing functions (see below).

Variations in environmental conditions in different geographic regions may alter stressor exposure and effects. If exposures to chemical stressors can be accurately estimated and are expected to be similar (e.g., see text box 4-21), the same species in different areas may respond similarly. For example, if the pesticide granular carbofuran were applied at comparable rates throughout the country, seed-eating birds could be expected to be similarly affected by the pesticide (Houseknecht, 1993). Nevertheless, the influence of environmental conditions on stressor exposure and effects can be substantial.

For biological stressors, environmental conditions such as climate, habitat, and suitable hosts play major roles in determining whether a biological stressor becomes established. For example, climate would prevent establishment of the Mediterranean fruit fly in the much colder northeastern United States. Thus, a thorough evaluation of environmental conditions in the area versus the natural habitat of the stressor is important. Even so, many biological stressors can adapt readily to varying environmental conditions, and the absence of natural predators or diseases may play an even more important role than abiotic factors.

For physical stressors that have natural counterparts, such as fire, flooding, or temperature variations, effects may depend on the difference between human-caused and natural variations in these parameters for a particular region. Thus, the comparability of two regions depends on both the pattern and range of natural disturbances.

Spatial scales and heterogeneities affect comparability between regions. Effects observed over a large scale may be difficult to extrapolate from one geographical location to another, mainly because the spatial heterogeneity is likely to differ. Factors such as number and size of land-cover patches, distance between patches, connectivity and conductivity of patches (e.g., migration routes), and patch shape may be important. Extrapolations can be strengthened by using appropriate reference sites, such as sites in comparable ecoregions (Hughes, 1995).

Ecological forcing functions may differ between geographic regions. Forcing functions are critical abiotic variables that exert a major influence on the structure and function of ecological systems. Examples include temperature fluctuations, fire frequency, light intensity, and hydrologic regime. If these differ significantly between sites, it may be inappropriate to extrapolate effects from one system to another.

Bedford and Preston (1988), Detenbeck et al. (1992), Gibbs (1993), Gilbert (1987), Gosselink et al. (1990), Preston and Bedford (1988), and Risser (1988) may be useful to risk assessors concerned with effects in different geographical areas.

**4.3.1.3.3. *Empirical and Process-Based Approaches for Linking Measures of Effect to Assessment Endpoints.*** A variety of empirical and process-based approaches are available to risk assessors, depending on the scope of the assessment and the data and resources available. Empirical and process-based approaches include numerical extrapolations between measures of effects and assessment endpoints. These linkages range in sophistication from applying an uncertainty factor to using a complex model requiring extensive measures of effects and measures of ecosystem and receptor characteristics as input. But even the most sophisticated quantitative models involve qualitative elements and assumptions and thus require professional judgment for evaluation. Individuals who use models and interpret their results should be familiar with the underlying assumptions and components contained in the model.

**4.3.1.3.3.1. *Empirical Approaches.*** Empirical approaches are derived from experimental data or observations. Empirically based uncertainty factors or taxonomic extrapolations may be used when adequate effects databases are available but the understanding of underlying mechanisms of action or ecological principles is limited. When sufficient information on stressors and receptors is available, process-based approaches such as pharmacokinetic/pharmacodynamic models or population or ecosystem process models may be used. Regardless of the options used, risk assessors should justify and adequately document the approach selected.

Uncertainty factors are used to ensure that measures of effects are sufficiently protective of assessment endpoints. Uncertainty factors are empirically derived numbers that are divided into measure of effects values to give an estimated stressor level that should not cause adverse effects to the assessment endpoint. Uncertainty factors have been developed most frequently for chemicals because extensive ecotoxicologic databases are available, especially for aquatic organisms. Uncertainty factors are useful when decisions must be made about stressors in a short time and with little information.

Uncertainty factors have been used to compensate for assessment endpoint/effect measures differences between endpoints (acute to chronic effects), between species, and between test situations (e.g., laboratory to field). Typically, they vary inversely with the quantity and type of measures of effects data available (Zeeman, 1995). They have been used in screening-level assessments of new chemicals (Nabholz, 1991), in assessing the risks of pesticides to aquatic and terrestrial organisms

(Urban and Cook, 1986), and in developing benchmark dose levels for human health effects (U.S. EPA, 1995c).

Despite their usefulness, uncertainty factors can also be misused, especially when used in an overly conservative fashion, as when chains of factors are multiplied together without sufficient justification. Like other approaches to bridging data gaps, uncertainty factors are often based on a combination of scientific analysis, scientific judgment, and policy judgment (see section 4.1.3). It is important to differentiate these three elements when documenting the basis for the uncertainty factors used.

Empirical data can be used to facilitate extrapolations between species, genera, families, or orders or functional groups (e.g., feeding guilds) (Suter, 1993a). Suter et al. (1983), Suter (1993a), and Barnhouse et al. (1987, 1990) developed methods to extrapolate toxicity between freshwater and marine fish and arthropods. As Suter notes (1993a), the uncertainties associated with extrapolating between orders, classes, and phyla tend to be very high. However, one can extrapolate with fair certainty between aquatic species within genera and genera within families. Further applications of this approach (e.g., for chemical stressors and terrestrial organisms) are limited by a lack of suitable databases.

In addition to taxonomic databases, dose-scaling or allometric regression is used to extrapolate the effects of a chemical stressor to another species. Allometry is the study of change in the proportions of various parts of an organism as a consequence of growth and development. Processes that influence toxicokinetics (e.g., renal clearance, basal metabolic rate, food consumption) tend to vary across species according to allometric scaling factors that can be expressed as a nonlinear function of body weight. These scaling factors can be used to estimate bioaccumulation and to improve interspecies extrapolations (Newman, 1995; Kenaga, 1973; U.S. EPA 1992c, 1995d). Although allometric relationships are commonly used for human health risk assessments, they have not been applied as extensively to ecological effects (Suter, 1993a). For chemical stressors, allometric relationships can enable an assessor to estimate toxic effects to species not commonly tested, such as native mammals. It is important that the assessor consider the taxonomic relationship between the known species and the one of interest. The closer they are related, the more likely the toxic response will be similar. Allometric approaches should not be applied to species that differ greatly in uptake, metabolism, or depuration of a chemical.

**4.3.1.3.3.2. *Process-Based Approaches.*** Process models for extrapolation are representations or abstractions of a system or process (Starfield and Bleloch, 1991) that incorporate causal relationships

and provide a predictive capability that does not depend on the availability of existing stressor-response information as empirical models do (Wiegert and Bartell, 1994). Process models enable assessors to translate data on individual effects (e.g., mortality, growth, and reproduction) to potential alterations in specific populations, communities, or ecosystems. Such models can be used to evaluate risk hypotheses about the duration and severity of a stressor on an assessment endpoint that cannot be tested readily in the laboratory.

There are two major types of models: single-species population models and multispecies community and ecosystem models. Population models describe the dynamics of a finite group of individuals through time and have been used extensively in ecology and fisheries management and to assess the impacts of power plants and toxicants on specific fish populations (Barnthouse et al., 1987, 1990). They can help answer questions about short- or long-term changes of population size and structure and can help estimate the probability that a population will decline below or grow above a specified abundance (Ginzburg et al., 1982; Ferson et al., 1989). The latter application may be useful when assessing the effects of biological stressors such as introduced or pest species. Barnthouse et al. (1986) and Wiegert and Bartell (1994) present excellent reviews of population models. Emlen (1989) has reviewed population models that can be used for terrestrial risk assessment.

Proper use of population models requires a thorough understanding of the natural history of the species under consideration, as well as knowledge of how the stressor influences its biology. Model input can include somatic growth rates, physiological rates, fecundity, survival rates of various classes within the population, and how these change when the population is exposed to the stressor and other environmental factors. In addition, the effects of population density on these parameters are important (Hassell, 1986) and should be considered in the uncertainty analysis.

Community and ecosystem models (e.g., Bartell et al., 1992; O'Neill et al., 1982) are particularly useful when the assessment endpoint involves structural (e.g., community composition) or functional (e.g., primary production) elements. They can also be useful when secondary effects are of concern. Changes in various community or ecosystem components such as populations, functional types, feeding guilds, or environmental processes can be estimated. By incorporating submodels describing the dynamics of individual system components, these models permit evaluation of risk to multiple assessment endpoints within the context of the ecosystem.

Risk assessors should determine the appropriate degree of aggregation in population or multispecies model parameters based both on the input data available and on the desired output of the model (also see text box 4-5). For example, if a decision is required about a particular species, a



model that lumps species into trophic levels or feeding guilds will not be very useful. Assumptions concerning aggregation in model parameters should be included in the uncertainty discussion.

#### 4.3.2. Stressor-Response Profile

The final product of ecological response analysis is a summary profile of what has been learned. This may be a written document or a module of a larger process model. In any case, the objective is to ensure that the information needed for risk characterization has been collected and evaluated. A useful approach in preparing the stressor-response profile is to imagine that it will be used by someone else to perform the risk characterization. Profile compilation also provides an opportunity to verify that the assessment endpoints and measures of effect identified in the conceptual model were evaluated.

Risk assessors should address several questions in the stressor-response profile (text box 4-22). Affected ecological entities may include single species, populations, general trophic levels, communities, ecosystems, or landscapes. The nature of the effect(s) should be germane to the assessment endpoint(s). Thus if a single species is affected, the effects should represent parameters appropriate for that level of organization. Examples include effects on mortality, growth, and reproduction. Short- and long-term effects should be reported as appropriate. At the community level, effects may be summarized in terms of structure or function depending on the assessment endpoint. At the landscape level, there may be a suite of assessment endpoints, and each should be addressed separately.

#### **Text Box 4-22. Questions Addressed by the Stressor-Response Profile**

- C What ecological entities are affected?
- C What is the nature of the effect(s)?
- C What is the intensity of the effect(s)?
- C Where appropriate, what is the time scale for recovery?
- C What causal information links the stressor with any observed effects?
- C How do changes in measures of effects relate to changes in assessment endpoints?
- C What is the uncertainty associated with the analysis?

Examples of different approaches for displaying the intensity of effects were provided in section 4.3.1.1. Other information such as the spatial area or time to recovery may also be appropriate. Causal analyses are important, especially for assessments that include field observational data.

Ideally, the stressor-response profile should express effects in terms of the assessment endpoint, but this is not always possible. Where it is necessary to use qualitative extrapolations

between assessment endpoints and measures of effect, the stressor-response profile may contain information only on measures of effect. Under these circumstances, risk will be estimated using the measures of effects, and extrapolation to the assessment endpoints will occur during risk characterization.

Risk assessors need to clearly describe any uncertainties associated with the ecological response analysis. If it was necessary to extrapolate from measures of effect to the assessment endpoint, both the extrapolation and its basis should be described. Similarly, if a benchmark or similar reference dose or concentration was calculated, the extrapolations and uncertainties associated with its development need to be discussed. For additional information on establishing reference concentrations, see Nabholz (1991), Urban and Cook (1986), Stephan et al. (1985), Van Leeuwen et al. (1992), Wagner and Løkke (1991), and Okkerman et al. (1993). Finally, the assessor should clearly describe major assumptions and default values used in the models.

At the end of the analysis phase, the stressor-response and exposure profiles are used to estimate risks. These profiles provide the opportunity to review what has been learned and to summarize this information in the most useful format for risk characterization. Whatever form the profiles take, they ensure that the necessary information is available for risk characterization.

## **5. RISK CHARACTERIZATION**

Risk characterization (figure 5-1) is the final phase of ecological risk assessment and is the culmination of the planning, problem formulation, and analysis of predicted or observed adverse ecological effects related to the assessment endpoints. Completing risk characterization allows risk assessors to clarify the relationships between stressors, effects, and ecological entities and to reach conclusions regarding the occurrence of exposure and the adversity of existing or anticipated effects. Here, risk assessors first use the results of the analysis phase to develop an estimate of the risk posed to the ecological entities included in the assessment endpoints identified in problem formulation (section 5.1). After estimating the risk, the assessor describes the risk estimate in the context of the significance of any adverse effects and lines of evidence supporting their likelihood (section 5.2). Finally, the assessor identifies and summarizes the uncertainties, assumptions, and qualifiers in the risk assessment and reports the conclusions to risk managers (section 5.3).

Conclusions presented in the risk characterization should provide clear information to risk managers in order to be useful for environmental decision making (NRC, 1994; see section 6). If the risks are not sufficiently defined to support a management decision, risk managers may elect to proceed with another iteration of one or more phases of the risk assessment process. Reevaluating the conceptual model (and associated risk hypotheses) or conducting additional studies may improve the risk estimate. Alternatively, a monitoring program may help managers evaluate the consequences of a risk management decision.

### **5.1. RISK ESTIMATION**

Risk estimation is the process of integrating exposure and effects data and evaluating any associated uncertainties. The process uses exposure and stressor-response profiles developed according to the analysis plan (section 3.5). Risk estimates can be developed using one or more of the following techniques: (1) field observational studies, (2) categorical rankings, (3) comparisons of single-point exposure and effects estimates, (4) comparisons incorporating the entire stressor-response relationship, (5) incorporation of variability in exposure and/or effects estimates, and (6) process models that rely partially or entirely on theoretical approximations of exposure and effects. These techniques are described in the following sections.

#### **5.1.1. Results of Field Observational Studies**

Field observational studies (surveys) can serve as risk estimation techniques because they provide empirical evidence linking exposure to effects. Field surveys measure biological

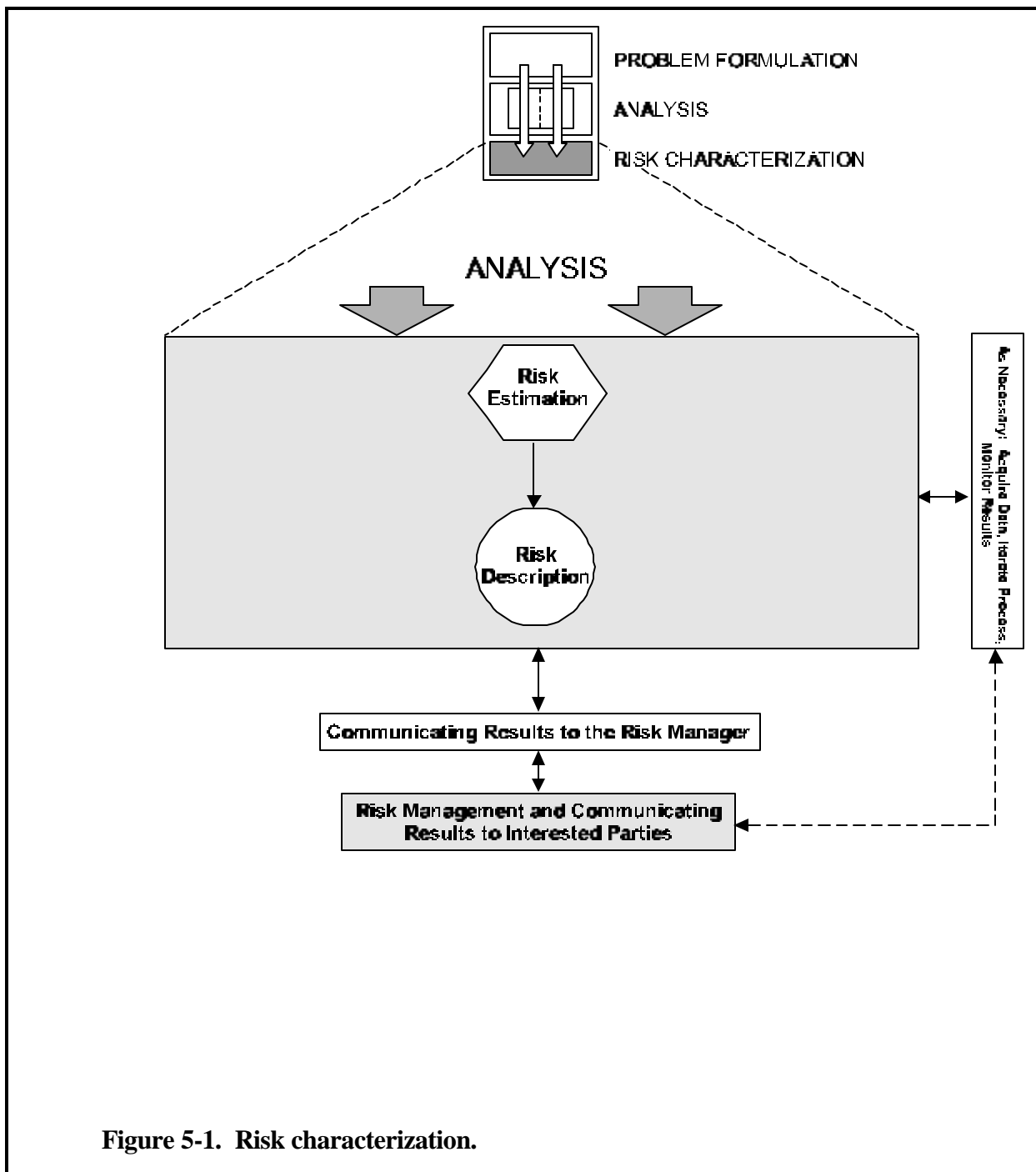

**Figure 5-1. Risk characterization.**

changes in natural settings through collection of exposure and effects data for ecological entities identified in problem formulation.

A major advantage of field surveys is that they can be used to evaluate multiple stressors and complex ecosystem relationships that cannot be replicated in the laboratory. Field surveys are designed to delineate both exposures and effects (including secondary effects) found in

natural systems, whereas estimates generated from laboratory studies generally delineate either exposures or effects under controlled or prescribed conditions (see text box 5-1).

While field studies may best represent reality, as with other kinds of studies they can be limited by (1) a lack of replication, (2) bias in obtaining representative samples, or (3) failure to measure critical components of the system or random variations. Further, a lack of observed effects in a field survey may occur because the measurements lack the sensitivity to detect ecological effects. See section 4.1.1 for additional discussion of the strengths and limitations of different types of data.

Several assumptions or qualifications need to be clearly articulated when describing the results of field surveys. A primary qualification is whether a causal relationship between stressors and effects (section 4.3.1.2) is supported. Unless causal relationships are carefully examined, conclusions about effects that are observed may be inaccurate because the effects are caused by factors unrelated to the stressor(s) of concern. In addition, field surveys taken at one point in time are usually not predictive; they describe effects associated only with exposure scenarios associated with past and existing conditions.

### **5.1.2. Categories and Rankings**

In some cases, professional judgment or other qualitative evaluation techniques may be used to rank risks using categories, such as low, medium, and high, or yes and no. This approach is most frequently used when exposure and effects data are limited or are not easily expressed in quantitative terms. The U.S. Forest Service risk assessment of pest introduction from importation of logs from Chile used qualitative categories owing to limitations in both the exposure and effects data for the introduced species of concern as well as the resources available for the assessment (see text box 5-2).

#### **Text Box 5-1. An Example of Field Methods Used for Risk Estimation**

Along with quotients comparing field measures of exposure with laboratory acute toxicity data (see Text Box 5-3), EPA evaluated the risks of granular carbofuran to birds based on incidents of bird kills following carbofuran applications. More than 40 incidents involving nearly 30 species of birds were documented. Although reviewers identified problems with individual field studies (e.g., lack of appropriate control sites, lack of data on carcass-search efficiencies, no examination of potential synergistic effects of other pesticides, and lack of consideration of other potential receptors such as small mammals), there was so much evidence of mortality associated with carbofuran application that the study deficiencies did not alter the conclusions of high risk found by the assessment (Houseknecht, 1993).

Ranking techniques can be used to translate qualitative judgment into a mathematical comparison. These methods are frequently used in comparative risk exercises. For example, Harris et al. (1994) evaluated risk reduction opportunities in Green Bay (Lake Michigan), Wisconsin, employing an expert panel to compare the relative risk of several stressors against their potential effects. Mathematical analysis based on fuzzy set theory was used to rank the risk from each stressor from a number of perspectives, including degree of immediate risk, duration of impacts, and prevention and remediation management. The results served to rank potential environmental risks from stressors based on best professional judgment.

**Text Box 5-2. Using Qualitative Categories to Estimate Risks of an Introduced Species**

The importation of logs from Chile required an assessment of the risks posed by the potential introduction of the bark beetle, *Hylurgus ligniperda* (USDA, 1993). Experts judged the potential for colonization and spread of the species, and their opinions were expressed as high, medium, or low as to the likelihood of establishment (exposure) or consequential effects of the beetle. Uncertainties were similarly expressed. A ranking scheme was then used to sum the individual elements into an overall estimate of risk (high, medium, or low). Narrative explanations of risk accompanied the overall rankings.

**5.1.3. Single-Point Exposure and Effects Comparisons**

When sufficient data are available to quantify exposure and effects estimates, the simplest approach for comparing the estimates is a ratio (figure 5-2a). Typically, the ratio (or quotient) is expressed as an exposure concentration divided by an effects concentration. Quotients are commonly used for chemical stressors, where reference or benchmark toxicity values are widely available (see text box 5-3).

The principal advantages of the quotient method are that it is simple and quick to use and risk assessors and managers are familiar with its application. It provides an efficient, inexpensive means of identifying high- or low-risk situations that can allow risk management decisions to be made without the need for further information.

Quotients have also been used to integrate the risks of multiple chemical stressors: quotients for the individual constituents in a mixture are generated by dividing each exposure level by a corresponding toxicity endpoint (e.g., LC<sub>50</sub>, EC<sub>50</sub>, NOAEL). Although the toxicity of a chemical mixture may be greater than or less than predicted from the toxicities of individual constituents of the mixture, a quotient addition approach assumes that toxicities are additive or approximately additive.

This assumption may be most applicable when the modes of action of chemicals in a mixture are similar, but there is evidence that even with chemicals having



### a: Comparison of point estimates

Exposure estimate  
(e.g., mean concentration)

Stressor-response estimate  
(e.g., LC<sub>10</sub>)

### b: Comparison of a point estimate of a stressor-response relationship with uncertainty associated with an exposure point estimate

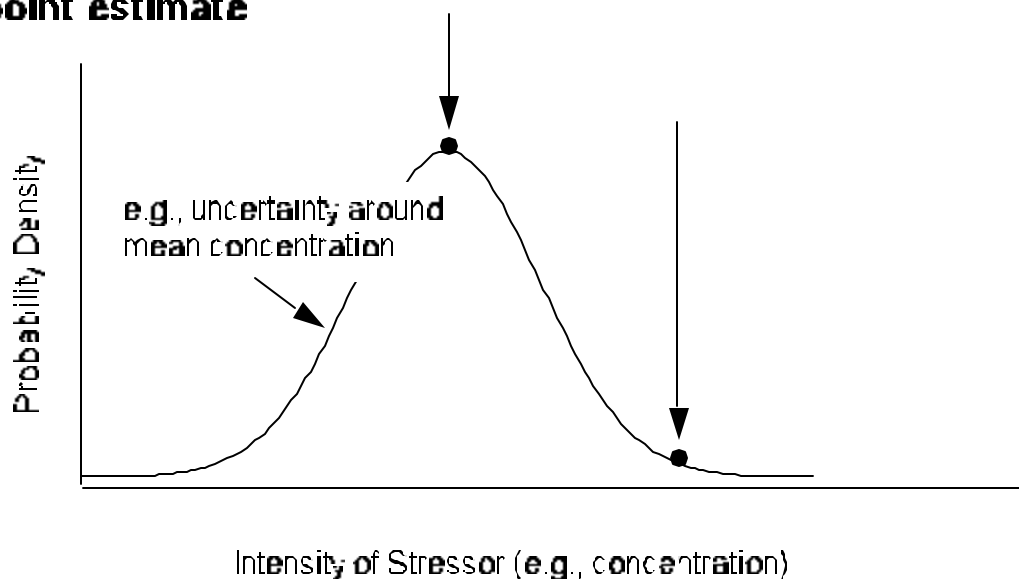

**Figure 5-2. Risk estimation techniques. a. Comparison of exposure and stressor-response point estimates. b. Comparison of a point estimate from the stressor-response relationship with uncertainty associated with an exposure point estimate.**

dissimilar modes of action, additive or near-additive interactions are common (Könemann, 1981; Broderius, 1991; Broderius et al., 1995; Hermens et al., 1984a, b; McCarty and Mackay, 1993; Sawyer and Safe, 1985). However, caution should be used when assuming that chemicals in a mixture

act independently of one another, since many of the supporting studies were conducted with aquatic organisms, and so may not be relevant for other endpoints, exposure scenarios, or species. When the modes of action for constituent chemicals are unknown, the assumptions and rationale concerning chemical interactions should be clearly stated.

A number of limitations restrict application of the quotient method (see Smith and Cairns, 1993; Suter, 1993a). While a quotient can be useful in answering whether risks are high or low, it may not be helpful to a risk manager who needs to make a decision requiring an incremental quantification of risks. For example, it is seldom useful to say that a risk mitigation approach will reduce a quotient value from 25 to 12, since this reduction cannot by itself be clearly interpreted in terms of effects on an assessment endpoint.

Other limitations of quotients may be caused by deficiencies in the problem formulation and analysis phases. For example, an  $LC_{50}$  derived from a 96-hour laboratory test using constant exposure levels may not be appropriate for an assessment of effects on reproduction resulting from short-term, pulsed exposures.

In addition, the quotient method may not be the most appropriate method for predicting secondary effects (although such effects may be inferred). Interactions and effects beyond what are predicted from the simple quotient may be critical to characterizing the full extent of impacts from exposure to the stressors (e.g., bioaccumulation, eutrophication, loss of prey species, opportunities for invasive species).

Finally, in most cases, the quotient method does not explicitly consider uncertainty (e.g., extrapolation from tested species to the species or community of concern). Some uncertainties,

### **Text Box 5-3. Applying the Quotient Method**

When applying the quotient method to chemical stressors, the effects concentration or dose (e.g., an  $LC_{50}$ ,  $LD_{50}$ ,  $EC_{50}$ ,  $ED_{50}$ , NOAEL, or LOAEL) is frequently adjusted by uncertainty factors before division into the exposure number (U.S. EPA, 1984; Nabholz, 1991; Urban and Cook, 1986; see section 4.3.1.3), although EPA used a slightly different approach in estimating the risks to the survival of birds that forage in agricultural areas where the pesticide granular carbofuran is applied (Houseknecht, 1993). In this case, EPA calculated the quotient by dividing the estimated exposure levels of carbofuran granules in surface soils (number/ft<sup>2</sup>) by the granules/ $LD_{50}$  derived from single-dose avian toxicity tests. The calculation yields values with units of  $LD_{50}/ft^2$ . It was assumed that a higher quotient value corresponded to an increased likelihood that a bird would be exposed to lethal levels of granular carbofuran at the soil surface. Minimum and maximum values for  $LD_{50}/ft^2$  were estimated for songbirds, upland game birds, and waterfowl that may forage within or near 10 different agricultural crops.

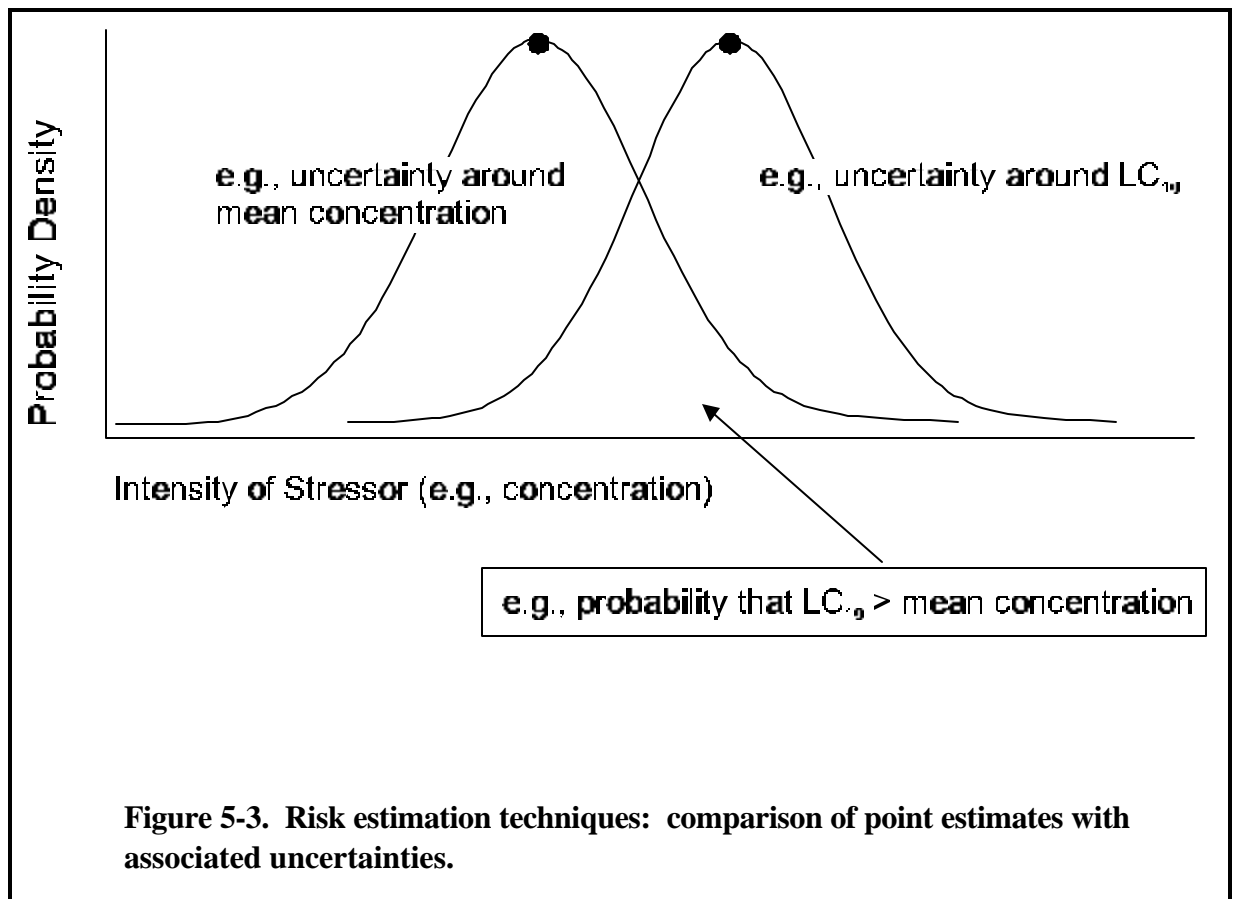

however, can be incorporated into single-point estimates to provide a statement of likelihood that the effects point estimate exceeds the exposure point estimate (figures 5-2b and 5-3). If exposure variability is quantified, then the point estimate of effects can be compared with a cumulative

exposure distribution as described in text box 5-4. Further discussion of comparisons between point estimates of effects and distributions of exposure may be found in Suter et al., 1983.

In view of the advantages and limitations of the quotient method, it is important for risk assessors to consider the points listed below when evaluating quotient method estimates.

- How does the effect concentration relate to the assessment endpoint?
- What extrapolations are involved?
- How does the point estimate of exposure relate to potential spatial and temporal variability in exposure?

- Are data sufficient to provide confidence intervals on the endpoints?

#### **5.1.4. Comparisons Incorporating the Entire Stressor-Response Relationship**

If a curve relating the stressor level to the magnitude of response is available, then risk estimation can examine risks associated with many different levels of exposure (figure 5-4). These estimates are particularly useful when the risk assessment outcome is not based on exceedance of a predetermined decision rule, such as a toxicity benchmark level.

There are advantages and limitations to comparing a stressor-response curve with an exposure distribution. The slope of the effects curve shows the magnitude of change in effects associated with incremental changes in exposure, and the capability to predict changes in the magnitude and likelihood of effects for different exposure scenarios can be used to compare different risk management options. Also, uncertainty can be incorporated by calculating uncertainty bounds on the stressor-response or exposure estimates. Comparing exposure and stressor-response curves provides a predictive ability lacking in the quotient method. Like the quotient method, however, limitations from the problem formulation and analysis phases may limit the utility of the results. These limitations may include not fully considering secondary effects, assuming the exposure pattern used to derive the stressor-response curve is comparable to the environmental exposure pattern, and failure to consider uncertainties, such as extrapolations from tested species to the species or community of concern.

#### **Text Box 5-4. Comparing an Exposure Distribution With a Point Estimate of Effects**

The EPA Office of Pollution Prevention and Toxics uses a Probabilistic Dilution Model (PDM3) to generate a distribution of daily average chemical concentrations based on estimated variations in stream flow in a model system. The PDM3 model compares this exposure distribution with an aquatic toxicity test endpoint to estimate how many days in a 1-year period the endpoint concentration is exceeded (Nabholz et al., 1993; U.S. EPA, 1988b). The frequency of exceedance is based on the duration of the toxicity test used to derive the effects endpoint. Thus, if the endpoint was an acute toxicity level of concern, an exceedance would be identified if the level of concern was exceeded for 4 days or more (not necessarily consecutive). The exposure estimates are conservative in that they assume instantaneous mixing of the chemical in the water column and no losses due to physical, chemical, or biodegradation effects.

#### **5.1.5. Comparisons Incorporating Variability in Exposure and/or Effects**

If the exposure or stressor-response profiles describe the variability in exposure or effects, then many different risk estimates can be calculated. Variability in exposure can be used to estimate risks to

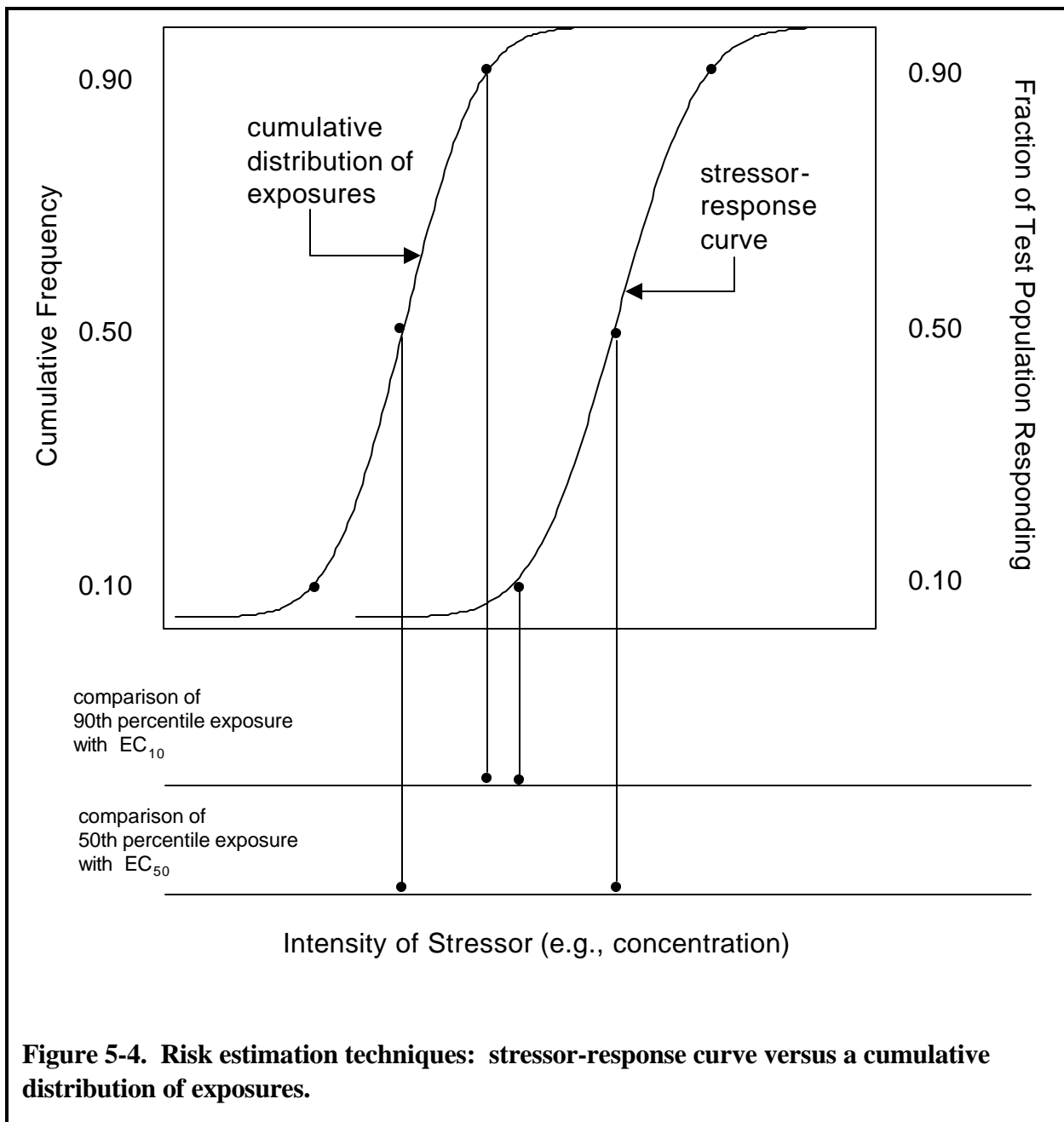

moderately or highly exposed members of a population being investigated, while variability in effects can be used to estimate risks to average or sensitive population

members. A major advantage of this approach is its ability to predict changes in the magnitude and likelihood of effects for different exposure scenarios and thus provide a means for comparing different risk management options. As noted above, comparing distributions also allows one to identify and quantify risks to different segments of the population. Limitations include the increased data

requirements compared with previously described techniques and the implicit assumption that the full range of variability in the exposure and effects data is adequately represented. As with the quotient method, secondary effects are not readily evaluated with this technique. Thus, it is desirable to corroborate risks estimated by distributional comparisons with field studies or other lines of evidence. Text box 5-5 and figure 5-5 illustrate the use of cumulative exposure and effects distributions for estimating risk.

### 5.1.6. Application of Process Models

Process models are mathematical expressions that represent our understanding of the mechanistic operation of a system under evaluation. They can be useful tools in both analysis (see section 4.1.2) and risk characterization. For illustrative purposes, it is useful to distinguish between analysis process models, which focus individually on either exposure or effects evaluations, and risk estimation process models, which integrate exposure and effects information (see text box 5-6). The assessment of risks associated with long-term changes in hydrologic conditions in bottomland forest wetlands in Louisiana using the FORFLO model (Appendix D) linked the attributes and placement of levees and corresponding water level measurements (exposure) with changes in forest community structure and wildlife habitat suitability (effects).

A major advantage of using process models for risk estimation is the ability to

#### **Text Box 5-5. Comparing Cumulative Exposure and Effects Distributions for Chemical Stressors**

Exposure distributions for chemical stressors can be compared with effects distributions derived from point estimates of acute or chronic toxicity values for different species (e.g., HCN, 1993; Cardwell et al., 1993; Baker et al., 1994; Solomon et al., 1996). Figure 5-5 shows a distribution of exposure concentrations of an herbicide compared with single-species toxicity data for algae (and one vascular plant species) for the same chemical. The degree of overlap of the curves indicates the likelihood that a certain percentage of species may be adversely affected. For example, figure 5-5 indicates that the 10th centile of algal species' EC<sub>5</sub> values is exceeded less than 10% of the time.

The predictive value of this approach is evident. The degree of risk reduction that could be achieved by changes in exposure associated with proposed risk mitigation options can be readily determined by comparing modified exposure distributions with the effects distribution curve.

When using effects distributions derived from single-species toxicity data, risk assessors should consider the following questions:

- Does the subset of species for which toxicity test data are available represent the range of species present in the environment?
- Are particularly sensitive (or insensitive) groups of organisms represented in the distribution?
- If a criterion level is selected—e.g., protect 95% of species—does the 5% of potentially affected species include organisms of ecological, commercial, or recreational significance?

consider “what if” scenarios and to forecast beyond the limits of observed data that constrain techniques based solely on empirical data. The process model can also consider secondary effects, unlike other risk estimation techniques such as the quotient method or comparisons of exposure and effect distributions. In addition, some process models can forecast the combined effects of

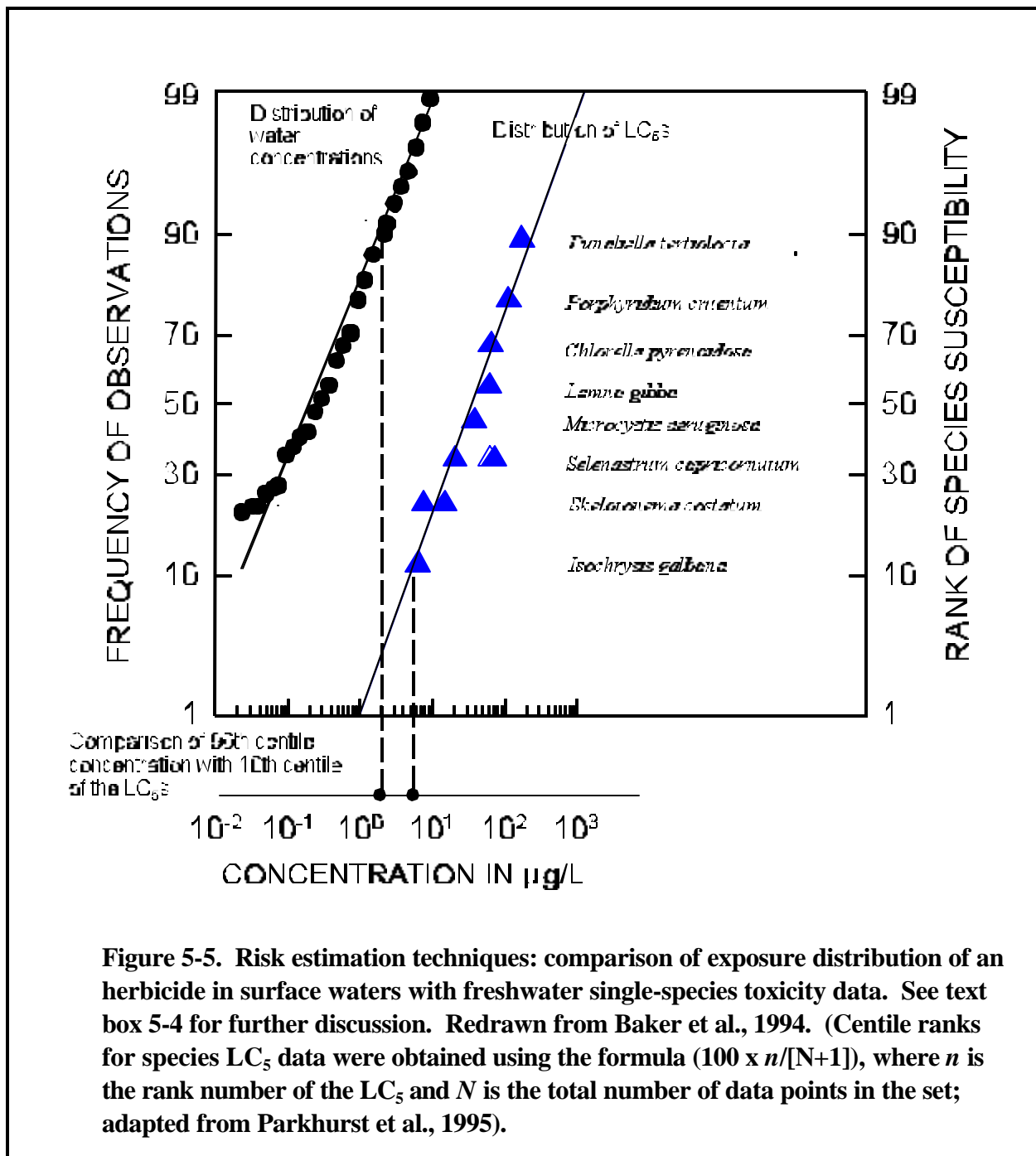

**Figure 5-5. Risk estimation techniques: comparison of exposure distribution of an herbicide in surface waters with freshwater single-species toxicity data. See text box 5-4 for further discussion. Redrawn from Baker et al., 1994. (Centile ranks for species LC<sub>5</sub> data were obtained using the formula  $(100 \times n/[N+1])$ , where  $n$  is the rank number of the LC<sub>5</sub> and  $N$  is the total number of data points in the set; adapted from Parkhurst et al., 1995).**

multiple stressors, such as the effects of multiple chemicals on fish population sustainability (Barnhouse et al., 1990).

Process model outputs may be point estimates, distributions, or correlations; in all cases, risk assessors should interpret them with care. They may imply a higher level of certainty than is



appropriate and are all too often viewed without sufficient attention to underlying assumptions. The lack of knowledge on basic life histories for many species and incomplete knowledge on the structure and function of a particular ecosystem is often lost in the model output. Since process models are only as good as the assumptions on which they are based, they should be treated as hypothetical representations of reality until appropriately tested with empirical data. Comparing model results to field data provides a check on whether our understanding of the system was correct (Johnson, 1995), particularly with respect to the risk hypotheses presented in problem formulation.

## **5.2. RISK DESCRIPTION**

Following preparation of the risk estimate, risk assessors need to interpret and discuss the available information about risks to the assessment endpoints. Risk description includes an evaluation of the lines of evidence supporting or refuting the risk estimate(s) and an interpretation of the significance of the adverse effects on the assessment endpoints. During the analysis phase, the risk assessor may have established the relationship between the assessment endpoints and measures of effect and associated lines of evidence in quantifiable, easily described terms (section 4.3.1.3). If not, the risk assessor can relate the available lines of evidence to the assessment endpoints using qualitative links. Regardless of the risk estimation technique, the technical narrative supporting the risk estimate is as important as the risk estimate itself.

### **5.2.1. Lines of Evidence**

The development of lines of evidence provides both a process and a framework for reaching a conclusion regarding confidence in the risk estimate. It is not the kind of proof demanded by experimentalists (Fox, 1991), nor is it a rigorous examination of weights of evidence. (Note that the term “weight of evidence” is sometimes used in legal discussions or in other documents, e.g., Urban and

#### **Text Box 5-6. Estimating Risk With Process Models**

Models that integrate both exposure and effects information can be used to estimate risk. During risk estimation, it is important that both the strengths and limitations of a process model approach be highlighted. Brody et al. (1993; see Appendix D) linked two process models to integrate exposure and effects information and forecast spatial and temporal changes in forest communities and their wildlife habitat value. While the models were useful for projecting long-term effects based on an understanding of the underlying mechanisms of change in forest communities and wildlife habitat, they could not evaluate all possible stressors of concern and were limited in the plant and wildlife species they could consider. Understanding both the strengths and limitations of models is essential for accurately representing the overall confidence in the assessment.

Cook, 1986; Menzie et al., 1996.) The phrase *lines of evidence* is used to de-emphasize the balancing of opposing factors based on assignment of quantitative values to reach a conclusion about a “weight” in favor of a more inclusive approach, which evaluates all available information, even evidence that may be qualitative in nature. It is important that risk assessors provide a thorough representation of all lines of evidence developed in the risk assessment rather than simply reduce their interpretation and description of the ecological effects that may result from exposure to stressors to a system of numeric calculations and results.

Confidence in the conclusions of a risk assessment may be increased by using several lines of evidence to interpret and compare risk estimates. These lines of evidence may be derived from different sources or by different techniques relevant to adverse effects on the assessment endpoints, such as quotient estimates, modeling results, or field observational studies.

There are three principal categories of factors for risk assessors to consider when evaluating lines of evidence: (1) adequacy and quality of data, (2) degree and type of uncertainty associated with the evidence, and (3) relationship of the evidence to the risk assessment questions (see also sections 3 and 4).

Data quality directly influences how confident risk assessors can be in the results of a study and conclusions they may draw from it. Specific concerns to consider for individual lines of evidence include whether the experimental design was appropriate for the questions posed in a particular study and whether data quality objectives were clear and adhered to. An evaluation of the scientific understanding of natural variability in the attributes of the ecological entities under consideration is important in determining whether there were sufficient data to satisfy the analyses chosen and to determine if the analyses were sufficiently sensitive and robust to identify stressor-caused perturbations.

Directly related to data quality issues is the evaluation of the relative uncertainties of each line of evidence. One major source of uncertainty comes from extrapolations. The greater the number of extrapolations, the more uncertainty introduced into a study. For example, were extrapolations used to infer effects in one species from another, or from one temporal or spatial scale to another? Were conclusions drawn from extrapolations from laboratory to field effects, or were field effects inferred from limited information, such as chemical structure-activity relationships? Were no-effect or low-effect levels used to address likelihood of effects? Risk assessors should consider these and any other sources of uncertainty when evaluating the relative importance of particular lines of evidence.

Finally, how directly lines of evidence relate to the questions asked in the risk assessment may determine their relative importance in terms of the ecological entity and the attributes of the assessment endpoint. Lines of evidence directly related to the risk hypotheses, and those that establish a cause-

and-effect relationship based on a definitive mechanism rather than associations alone, are likely to be of greatest importance.

The evaluation process, however, involves more than just listing the evidence that supports or refutes the risk estimate. The risk assessor should carefully examine each factor and evaluate its contribution in the context of the risk assessment. The importance of lines of evidence is that each and every factor is described and interpreted. Data or study results are often not reported or carried forward in the risk assessment because they are of insufficient quality. If such data or results are eliminated from the evaluation process, however, valuable information may be lost with respect to needed improvements in methodologies or recommendations for further studies.

As a case in point, consider the two lines of evidence described for the carbofuran example (see text boxes 5-1 and 5-3), field studies and quotients. Both approaches are relevant to the assessment endpoint (survival of birds that forage in agricultural areas where carbofuran is applied), and both are relevant to the exposure scenarios described in the conceptual model (see figure D-1). The quotients, however, are limited in their ability to express incremental risks (e.g., how much greater risk is expressed by a quotient of “2” versus a quotient of “4”), while the field studies had some design flaws (see text box 5-1). Nevertheless, because of the strong evidence of causal relationships from the field studies and consistency with the laboratory-derived quotient, confidence in a conclusion of high risk to the assessment endpoint is supported.

Sometimes lines of evidence do not point toward the same conclusion. It is important to investigate possible reasons for any disagreement rather than ignore inconvenient evidence. A starting point is to distinguish between true inconsistencies and those related to differences in statistical powers of detection. For example, a model may predict adverse effects that were not observed in a field survey. The risk assessor should ask whether the experimental design of the field study had sufficient power to detect the predicted difference or whether the endpoints measured were comparable with those used in the model. Conversely, the model may have been unrealistic in its predictions. While iteration of the risk assessment process and collection of additional data may help resolve uncertainties, this option is not always available.

Lines of evidence that are to be evaluated during risk characterization should be defined early in the risk assessment (during problem formulation) through the development of the conceptual model and selection of assessment endpoints. Further, the analysis plan should incorporate measures that will contribute to the interpretation of the lines of evidence, including methods of reviewing, analyzing, and summarizing the uncertainty in the risk assessment.

Also, risk assessments often rely solely on laboratory or in situ bioassays to assess adverse effects that may occur as a result of exposure to stressors. Although they may not be manifested in the field, ecological effects demonstrated in the laboratory should not be discounted as a line of evidence.

### **5.2.2. Determining Ecological Adversity**

At this point in risk characterization, the changes expected in the assessment endpoints have been estimated and the supporting lines of evidence evaluated. The next step is to interpret whether these changes are considered adverse. Adverse ecological effects, in this context, represent changes that are undesirable because they alter valued structural or functional attributes of the ecological entities under consideration. The risk assessor evaluates the degree of adversity, which is often a difficult task and is frequently based on the risk assessor's professional judgment.

When the results of the risk assessment are discussed with the risk manager (section 6), other factors, such as the economic, legal, or social consequences of ecological damage, should be considered. The risk manager will use all of this information to determine whether a particular adverse effect is acceptable and may also find it useful when communicating the risk to interested parties.

The following are criteria for evaluating adverse changes in assessment endpoints:

- Nature of effects and intensity of effects
- Spatial and temporal scale
- Potential for recovery.

The extent to which the criteria are evaluated depends on the scope and complexity of the risk assessment. Understanding the underlying assumptions and science policy judgments, however, is important even in simple cases. For example, when exceedance of a previously established decision rule, such as a benchmark stressor level, is used as evidence of adversity (e.g., see Urban and Cook, 1986, or Nabholz, 1991), the reasons why this is considered adverse should be clearly understood. In addition, any evaluation of adversity should examine all relevant criteria, since none are considered singularly determinative.

To distinguish adverse ecological changes from those within the normal pattern of ecosystem variability or those resulting in little or no significant alteration of biota, it is important to consider the nature and intensity of effects. For example, for an assessment endpoint involving survival, growth, and reproduction of a species, do predicted effects involve survival and reproduction or only growth? If survival of offspring will be affected, by what percentage will it diminish?

It is important for risk assessors to consider both the ecological and statistical contexts of an effect when evaluating intensity. For example, a statistically significant 1% decrease in fish growth (see text box 5-7) may not be relevant to an assessment endpoint of fish population viability, and a 10% decline in reproduction may be worse for a population of slowly reproducing trees than for rapidly reproducing planktonic algae.

Natural ecosystem variation can make it very difficult to observe (detect) stressor-related perturbations. For example, natural fluctuations in marine fish populations are often large, with intra- and interannual variability in population levels covering several orders of magnitude. Furthermore, cyclic events of various periods (e.g., bird migration, tides) are very important in natural systems and may mask or delay stressor-related effects. Predicting the effects of anthropogenic stressors against this background of variation can be very difficult. Thus, a lack of statistically significant effects in a field study does not automatically mean that adverse ecological effects are absent. Rather, risk assessors should then consider other lines of evidence in reaching their conclusions.

It is also important to consider the location of the effect within the biological hierarchy and the mechanisms that may result in ecological changes. The risk assessor may rely on mechanistic explanations to describe complex ecological interactions and the resulting effects that otherwise may be masked by variability in the ecological components.

The boundaries (global, landscape, ecosystem, organism) of the risk assessment are initially identified in the analysis plan prepared during problem formulation. These spatial and temporal scales are further defined in the analysis phase, where specific exposure and effects scenarios are evaluated. The spatial dimension encompasses both the extent and pattern of effect as well as the context of the effect within the landscape. Factors to consider include the absolute area affected, the extent of critical habitats affected compared with a larger area of interest, and the role or use of the affected area within the landscape.

Adverse effects to assessment endpoints vary with the absolute area of the effect. A larger affected area may be (1) subject to a greater number of other stressors, increasing the complications

### **Text Box 5-7. What Are Statistically Significant Effects?**

Statistical testing is the “statistical procedure or decision rule that leads to establishing the truth or falsity of a hypothesis . . .” (Alder and Roessler, 1972). Statistical significance is based on the number of data points, the nature of their distribution, whether intertreatment variance exceeds intratreatment variance in the data, and the a priori significance level ( $\alpha$ ). The types of statistical tests and the appropriate protocols (e.g., power of test) for these tests should be established as part of the analysis plan during problem formulation.

from stressor interactions, (2) more likely to contain sensitive species or habitats, or (3) more susceptible to landscape-level changes because many ecosystems may be altered by the stressors.

Nevertheless, a smaller area of effect is not always associated with lower risk. The function of an area within the landscape may be more important than the absolute area. Destruction of small but unique areas, such as critical wetlands, may have important effects on local and regional wildlife populations. Also, in river systems, both riffle and pool areas provide important microhabitats that maintain the structure and function of the total river ecosystem. Stressors acting on these microhabitats may result in adverse effects to the entire system.

Spatial factors are important for many species because of the linkages between ecological landscapes and population dynamics. Linkages between landscapes can provide refuge for affected populations, and organisms may require corridors between habitat patches for successful migration.

The temporal scale for ecosystems can vary from seconds (photosynthesis, prokaryotic reproduction) to centuries (global climate change). Changes within a forest ecosystem can occur gradually over decades or centuries and may be affected by slowly changing external factors such as climate. When interpreting adversity, risk assessors should recognize that the time scale of stressor-induced changes operates within the context of multiple natural time scales. In addition, temporal responses for ecosystems may involve intrinsic time lags, so responses to a stressor may be delayed. Thus, it is important to distinguish a stressor's long-term impacts from its immediately visible effects. For example, visible changes resulting from eutrophication of aquatic systems (turbidity, excessive macrophyte growth, population decline) may not become evident for many years after initial increases in nutrient levels.

Considering the temporal scale of adverse effects leads logically to a consideration of recovery. Recovery is the rate and extent of return of a population or community to some aspect of its condition prior to a stressor's introduction. (While this discussion deals with recovery as a result of natural processes, risk mitigation options may include restoration activities to facilitate or speed up the recovery process.) Because ecosystems are dynamic and, even under natural conditions, constantly changing in response to changes in the physical environment (e.g., weather, natural disturbances) or other factors, it is unrealistic to expect that a system will remain static at some level or return to exactly the same state that it was before it was disturbed (Landis et al., 1993). Thus, the attributes of a "recovered" system should be carefully defined. Examples might include productivity declines in a eutrophic system, reestablishment of a species at a particular density, species recolonization of a damaged habitat, or the restoration of health of diseased organisms. The Agency considered the recovery rate of biological

communities in streams and rivers from disturbances in setting exceedance frequencies for chemical stressors in waste effluents (U.S. EPA, 1991).

Recovery can be evaluated in spite of the difficulty in predicting events in ecological systems (e.g., Niemi et al., 1990). For example, it is possible to distinguish changes that are usually reversible (e.g., stream recovery from sewage effluent discharge), frequently irreversible (e.g., establishment of introduced species), and always irreversible (e.g., extinction). Risk assessors should consider the potential irreversibility of significant structural or functional changes in ecosystems or ecosystem components when evaluating adversity. Physical alterations such as deforestation in the coastal hills of Venezuela in recent history and in Britain during the Neolithic period, for example, changed soil structure and seed sources such that forests cannot easily grow again (Fisher and Woodmansee, 1994).

The relative rate of recovery can also be estimated. For instance, fish populations in a stream are likely to recover much faster from exposure to a degradable chemical than from habitat alterations resulting from stream channelization. Risk assessors can use knowledge of factors, such as the temporal scales of organisms' life histories, the availability of adequate stock for recruitment, and the interspecific and trophic dynamics of the populations, in evaluating the relative rates of recovery. A fisheries stock or forest might recover in decades, a benthic invertebrate community in years, and a planktonic community in weeks to months.

Risk assessors should note natural disturbance patterns when evaluating the likelihood of recovery from anthropogenic stressors. Alternatively, if an ecosystem has become adapted to a disturbance pattern, it may be affected when the disturbance is removed (e.g., fire-maintained grasslands). The lack of natural analogs makes it difficult to predict recovery from uniquely anthropogenic stressors (e.g., synthetic chemicals).

Appendix E illustrates how the criteria for ecological adversity (nature and intensity of effects, spatial and temporal scales, and recovery) might be used in evaluating two cleanup options for a marine oil spill. This example also shows that recovery of a system depends not only on how quickly a stressor is removed, but also on how the cleanup efforts themselves affect the recovery.

### **5.3. REPORTING RISKS**

When risk characterization is complete, risk assessors should be able to estimate ecological risks, indicate the overall degree of confidence in the risk estimates, cite lines of evidence supporting the risk estimates, and interpret the adversity of ecological effects. Usually this information is included in a risk assessment report (sometimes referred to as a risk characterization report because of the integrative nature of risk characterization). While the breadth of ecological risk assessment precludes

providing a detailed outline of reporting elements, the risk assessor should consider the elements listed in text box 5-8 when preparing a risk assessment report.

Like the risk assessment itself, a risk assessment report may be brief or extensive, depending on the nature of and the resources available for the assessment. While it is important to address the elements described in text box 5-8, risk assessors should judge the level of detail required. The report need not be overly complex or lengthy; it is most important that the information required to support a risk management decision be presented clearly and concisely.

To facilitate mutual understanding, it is critical that the risk assessment results are properly presented. Agency policy requires that risk characterizations be prepared “in a manner that is *clear, transparent, reasonable, and consistent* with other risk characterizations of similar scope prepared across programs in the Agency” (U.S. EPA, 1995b). Ways to achieve such characteristics are described in text box 5-9.

After the risk assessment report is prepared, the results are discussed with risk managers. Section 6 provides information on communication between risk assessors and risk managers, describes the use of the risk assessment in a risk management context, and briefly discusses communication of risk assessment results from risk managers to interested parties and the general public.

**Text Box 5-8. Possible Risk Assessment Report Elements**

- C Describe risk assessor/risk manager planning results.
- C Review the conceptual model and the assessment endpoints.
- C Discuss the major data sources and analytical procedures used.
- C Review the stressor-response and exposure profiles.
- C Describe risks to the assessment endpoints, including risk estimates and adversity evaluations.
- C Review and summarize major areas of uncertainty (as well as their direction) and the approaches used to address them.
  - < Discuss the degree of scientific consensus in key areas of uncertainty.
  - < Identify major data gaps and, where appropriate, indicate whether gathering additional data would add significantly to the overall confidence in the assessment results.
  - < Discuss science policy judgments or default assumptions used to bridge information gaps and the basis for these assumptions.
  - < Discuss how the elements of quantitative uncertainty analysis are embedded in the estimate of risk.



### **Text Box 5-9. Clear, Transparent, Reasonable, and Consistent Risk Characterizations**

#### **For clarity:**

- Be brief; avoid jargon.
- Make language and organization understandable to risk managers and the informed lay person.
- Fully discuss and explain unusual issues specific to a particular risk assessment.

#### **For transparency:**

- Identify the scientific conclusions separately from policy judgments.
- Clearly articulate major differing viewpoints of scientific judgments.
- Define and explain the risk assessment purpose (e.g., regulatory purpose, policy analysis, priority setting).
- Fully explain assumptions and biases (scientific and policy).

#### **For reasonableness:**

- Integrate all components into an overall conclusion of risk that is complete, informative, and useful in decision making.
- Acknowledge uncertainties and assumptions in a forthright manner.
- Describe key data as experimental, state-of-the-art, or generally accepted scientific knowledge.
- Identify reasonable alternatives and conclusions that can be derived from the data.
- Define the level of effort (e.g., quick screen, extensive characterization) along with the reason(s) for selecting this level of effort.
- Explain the status of peer review.

#### **For consistency with other risk characterizations:**

- Describe how the risks posed by one set of stressors compare with the risks posed by a similar stressor(s) or similar environmental conditions.

## 6. RELATING ECOLOGICAL INFORMATION TO RISK MANAGEMENT DECISIONS

After characterizing risks and preparing a risk assessment report (section 5), risk assessors discuss the results with risk managers (figure 5-1). Risk managers use risk assessment results, along with other factors (e.g., economic or legal concerns), in making risk management decisions and as a basis for communicating risks to interested parties and the general public.

Mutual understanding between risk assessors and risk managers regarding risk assessment results can be facilitated if the questions listed in text box 6-1 are addressed. Risk managers need to know the major risks to assessment endpoints and have an idea of whether the conclusions are supported by a large body of data or if there are significant data gaps. Insufficient resources, lack of consensus, or other factors may preclude preparation of a detailed and well-documented risk characterization. If this is the case, the risk assessor should clearly articulate any issues, obstacles, and correctable deficiencies for the risk manager's consideration.

In making decisions regarding ecological risks, risk managers consider other information, such as social, economic, political, or legal issues in combination with risk assessment results. For example, the risk assessment results may be used as part of an ecological cost-benefit analysis, which may require translating resources (identified through the assessment endpoints) into monetary values. Traditional economic

**Text Box 6-1. Questions Regarding Risk Assessment Results** (Adapted From U.S. EPA, 1993c)

**Questions principally for risk assessors to ask risk managers:**

- Are the risks sufficiently well defined (and data gaps small enough) to support a risk management decision?
- Was the right problem analyzed?
- Was the problem adequately characterized?

**Questions principally for risk managers to ask risk assessors:**

- What effects might occur?
- How adverse are the effects?
- How likely is it that effects will occur?
- When and where do the effects occur?
- How confident are you in the conclusions of the risk assessment?
- What are the critical data gaps, and will information be available in the near future to fill these gaps?
- Are more ecological risk assessment iterations required?
- How could monitoring help evaluate the results of the risk management decision?

considerations may only partially address changes in ecological resources that are not considered commodities, intergenerational resource values, or issues of long-term or irreversible effects (U.S. EPA, 1995a; Costanza et al., 1997); however, they may provide a means of comparing the results of the risk assessment in commensurate units such as costs. Risk managers may also consider alternative strategies for reducing risks, such as risk mitigation options or substitutions based on relative risk comparisons. For example, risk mitigation techniques, such as buffer strips or lower field application rates, can be used to reduce the exposure (and risk) of a pesticide. Further, by comparing the risk of a new pesticide to other pesticides currently in use during the registration process, lower overall risk may result. Finally, risk managers consider and incorporate public opinion and political demands into their decisions. Collectively, these other factors may render very high risks acceptable or very low risks unacceptable.

Risk characterization provides the basis for communicating ecological risks to interested parties and the general public. This task is usually the responsibility of risk managers, but it may be shared with risk assessors. Although the final risk assessment document (including its risk characterization sections) can be made available to the public, the risk communication process is best served by tailoring information to a particular audience. Irrespective of the specific format, it is important to clearly describe the ecological resources at risk, their value, and the monetary and other costs of protecting (and failing to protect) the resources (U.S. EPA, 1995a).

Managers should clearly describe the sources and causes of risks and the potential adversity of the risks (e.g., nature and intensity, spatial and temporal scale, and recovery potential). The degree of confidence in the risk assessment, the rationale for the risk management decision, and the options for reducing risk are also important (U.S. EPA, 1995a). Other risk communication considerations are provided in text box 6-2.

Along with discussions of risk and communications with the public, it is important for risk managers to consider whether additional

**Text Box 6-2. Risk Communication Considerations for Risk Managers (U.S. EPA, 1995b)**

- Plan carefully and evaluate the success of your communication efforts.
- Coordinate and collaborate with other credible sources.
- Accept and involve the public as a legitimate partner.
- Listen to the public's specific concerns.
- Be honest, frank, and open.
- Speak clearly and with compassion.
- Meet the needs of the media.

follow-on activities are required. Depending on the importance of the assessment, confidence in its results, and available resources, it may be advisable to conduct another iteration of the risk assessment (starting with problem formulation or analysis) in order to support a final management decision. Another option is to proceed with the decision, implement the selected management alternative, and develop a monitoring plan to evaluate the results (see section 1). If the decision is to mitigate risks through exposure reduction, for example, monitoring could help determine whether the desired reduction in exposure (and effects) is achieved.

## **APPENDIX A—CHANGES FROM EPA’S ECOLOGICAL RISK ASSESSMENT FRAMEWORK**

EPA has gained much experience with the ecological risk assessment process since the publication of the Framework Report (U.S. EPA, 1992a) and has received many suggestions for modifications of both the process and the terminology. While EPA is not recommending major changes in the overall ecological risk assessment process, modifications are summarized here to assist those who may already be familiar with the Framework Report. Changes in the diagram are discussed first, followed by changes in terminology and definitions.

### **A.1. CHANGES IN THE FRAMEWORK DIAGRAM**

The revised framework diagram is shown in figure 1-2. Within each phase, rectangles are used to designate inputs, hexagons indicate actions, and circles represent outputs. There have been some minor changes in the wording for the boxes outside of the risk assessment process (planning; communicating results to the risk manager; acquire data, iterate process, monitor results). “Iterate process” was added to emphasize the iterative (and frequently tiered) nature of risk assessment. The term “interested parties” was added to the planning and risk management boxes to indicate their increasing role in the risk assessment process (Commission on Risk Assessment and Risk Management, 1997). The new diagram of problem formulation contains several changes. The hexagon emphasizes the importance of integrating available information before selecting assessment endpoints and building conceptual models. The three products of problem formulation are enclosed in circles. Assessment endpoints are shown as a key product that drives conceptual model development. The conceptual model remains a central product of problem formulation. The analysis plan has been added as an explicit product of problem formulation to emphasize the need to plan data evaluation and interpretation before analyses begin.

In the analysis phase, the left-hand side of figure 1-2 shows the general process of characterization of exposure, and the right-hand side shows the characterization of ecological effects. It is important that evaluation of these two aspects of analysis is an interactive process to ensure compatible outputs that can be integrated in risk characterization. The dotted line and hexagon that include both the exposure and ecological response analyses emphasize this interaction. In addition, the first three boxes in analysis now include the measures of exposure, effects, and ecosystem and receptor characteristics that provide input to the exposure and ecological response analyses.

Experience with the application of risk characterization as outlined in the Framework Report suggests the need for several modifications in this process. Risk estimation entails the integration of exposure and effects estimates along with an analysis of uncertainties. The process of risk estimation outlined in the Framework Report separates integration and uncertainty. The original purpose for this separation was to emphasize the importance of estimating uncertainty. This separation is no longer needed since uncertainty analysis is now explicitly addressed in most risk integration methods.

The description of risk is similar to the process described in the Framework Report. Topics included in the risk description include the lines of evidence that support causality and a determination of the ecological adversity of observed or predicted effects. Considerations for reporting risk assessment results are also described.

## **A.2. CHANGES IN DEFINITIONS AND TERMINOLOGY**

Except as noted below, these Guidelines retain definitions used in the Framework Report (see Appendix B). Some definitions have been revised, especially those related to endpoints and exposure. Some changes in the classification of uncertainty from the Framework Report are also described in this section.

### **A.2.1. Endpoint Terminology**

The Framework Report uses the assessment and measurement endpoint terminology of Suter (1990), but offers no specific terms for measures of stressor levels or ecosystem characteristics. Experience has demonstrated that measures unrelated to effects are sometimes inappropriately called measurement endpoints, which were defined by Suter (1990) as “measurable responses to a stressor that are related to the valued characteristic chosen as assessment endpoints.” These Guidelines replace measurement endpoint with measure of effect, which is “a change in an attribute of an assessment endpoint or its surrogate in response to a stressor to which it is exposed.” An assessment endpoint is an explicit expression of the environmental value to be protected, operationally defined by an entity and its attributes. Since data other than those required to evaluate responses (i.e., measures of effects) are required for an ecological risk assessment, two additional types of measures are used. Measures of exposure include stressor and source measurements, while measures of ecosystem and receptor characteristics include, for example, habitat measures, soil parameters, water quality conditions, or life-history parameters that may be necessary to better characterize exposure or effects. Any of the three types of measures may be actual data (e.g., mortality), summary statistics (e.g., an  $LC_{50}$ ), or estimated values (e.g., an  $LC_{50}$  estimated from a structure-activity relationship).

### A.2.2. Exposure Terminology

These Guidelines define exposure in a manner that is relevant to any chemical, physical, or biological entity. While the broad concepts are the same, the language and approaches vary depending on whether a chemical, physical, or biological entity is the subject of assessment. Key exposure-related terms and their definitions are:

- **Source.** A source is an entity or action that releases to the environment or imposes on the environment a chemical, physical, or biological stressor or stressors. Sources may include a waste treatment plant, a pesticide application, a logging operation, introduction of exotic organisms, or a dredging project.

- **Stressor.** A stressor is any physical, chemical, or biological entity that can induce an adverse response. This term is used broadly to encompass entities that cause primary effects and those primary effects that can cause secondary (i.e., indirect) effects. Stressors may be chemical (e.g., toxics or nutrients), physical (e.g., dams, fishing nets, or suspended sediments), or biological (e.g., exotic or genetically engineered organisms). While risk assessment is concerned with the

#### Text Box A-1. Stressor vs. Agent

Agent has been suggested as an alternative for the term stressor (Suter et al., 1994). Agent is thought to be a more neutral term than stressor, but agent is also associated with certain classes of chemicals (e.g., chemical warfare agents). In addition, agent has the connotation of the entity that is initially released from the source, whereas stressor has the connotation of the entity that causes the response. Agent is used in EPA's Guidelines for Exposure Assessment (U.S. EPA, 1992b) (i.e., with exposure defined as "contact of a chemical, physical, or biological agent"). The two terms are considered to be nearly synonymous, but stressor is used throughout these Guidelines for internal consistency.

characterization of adverse responses, under some circumstances a stressor may be neutral or produce effects that are beneficial to certain ecological components (see text box A-1). Primary effects may also become stressors. For example, a change in a bottomland hardwood plant community affected by rising water levels can be thought of as a stressor influencing the wildlife community. Stressors may also be formed through abiotic interactions; for example, the increase in ultraviolet light reaching the Earth's

surface results from the interaction of the original stressors released (chlorofluorocarbons) with the ecosystem (stratospheric ozone).

- **Exposure.** As discussed above, these Guidelines use the term exposure broadly to mean “subjected to some action or influence.” Used in this way, exposure applies to physical and biological stressors as well as to chemicals (organisms are commonly said to be exposed to radiation, pathogens, or heat). Exposure is also applicable to higher levels of biological organization, such as exposure of a benthic community to dredging, exposure of an owl population to habitat modification, or exposure of a wildlife population to hunting. Although the operational definition of exposure, particularly the units of measure, depends on the stressor and receptor (defined below), the following general definition is applicable: Exposure is the contact or co-occurrence of a stressor with a receptor.
- **Receptor.** The receptor is the ecological entity exposed to the stressor. This term may refer to tissues, organisms, populations, communities, and ecosystems. While either “ecological component” (U.S. EPA, 1992a) or “biological system” (Cohrssen and Covello, 1989) are alternative terms, “receptor” is usually clearer in discussions of exposure where the emphasis is on the stressor-receptor relationship.

As discussed below, both disturbance and stress regime have been suggested as alternative terms for exposure. Neither term is used in these Guidelines, which instead use exposure as broadly defined above.

- **Disturbance.** A disturbance is any event or series of events that disrupts ecosystem, community, or population structure and changes resources, substrate availability, or the physical environment (modified slightly from White and Pickett, 1985). Defined in this way, disturbance is clearly a kind of exposure (i.e., an event that subjects a receptor, the disturbed system, to the actions of a stressor). Disturbance may be a useful alternative to stressor specifically for physical stressors that are deletions or modifications (e.g., logging, dredging, flooding).



- **Stress Regime.** The term stress regime has been used in at least three distinct ways: (1) to characterize exposure to multiple chemicals or to both chemical and nonchemical stressors (more clearly described as multiple exposure, complex exposure, or exposure to mixtures), (2) as a synonym for exposure that is intended to avoid overemphasis on chemical exposures, and (3) to describe the series of interactions of exposures and effects resulting in secondary exposures, secondary effects, and, finally, ultimate effects (also known as risk cascade [Lipton et al., 1993]), or causal chain, pathway, or network (Andrewartha and Birch, 1984). Because of the potential for confusion and the availability of other, clearer terms, this term is not used in these Guidelines.

### **A.2.3. Uncertainty Terminology**

The Framework Report divided uncertainty into conceptual model formation, information and data, stochasticity, and error. These Guidelines discuss uncertainty throughout the process, focusing on the conceptual model (section 3.4.3), the analysis phase (section 4.1.3), and the incorporation of uncertainty in risk estimates (section 5.1). The bulk of the discussion appears in section 4.1.3, where the discussion is organized according to the following sources of uncertainty:

- Unclear communication
- Descriptive errors
- Variability
- Data gaps
- Uncertainty about a quantity's true value
- Model structure uncertainty (process models)
- Uncertainty about a model's form (empirical models).

### **A.2.4. Lines of Evidence**

The Framework Report used the phrase weight of evidence to describe the process of evaluating multiple lines of evidence in risk characterization. These Guidelines use the phrase lines of evidence instead to de-emphasize the balancing of opposing factors based on assignment of quantitative values to reach a conclusion about a "weight" in favor of a more inclusive approach, which evaluates all available information, even evidence that may be qualitative in nature.

## APPENDIX B—KEY TERMS (Adapted from U.S. EPA, 1992a)

**Adverse ecological effects**—Changes that are considered undesirable because they alter valued structural or functional characteristics of ecosystems or their components. An evaluation of adversity may consider the type, intensity, and scale of the effect as well as the potential for recovery.

**Agent**—Any physical, chemical, or biological entity that can induce an adverse response (synonymous with stressor).

**Assessment endpoint**—An explicit expression of the environmental value that is to be protected, operationally defined by an ecological entity and its attributes. For example, salmon are valued ecological entities; reproduction and age class structure are some of their important attributes. Together “salmon reproduction and age class structure” form an assessment endpoint.

**Attribute**—A quality or characteristic of an ecological entity. An attribute is one component of an assessment endpoint.

**Characterization of ecological effects**—A portion of the analysis phase of ecological risk assessment that evaluates the ability of a stressor(s) to cause adverse effects under a particular set of circumstances.

**Characterization of exposure**—A portion of the analysis phase of ecological risk assessment that evaluates the interaction of the stressor with one or more ecological entities. Exposure can be expressed as co-occurrence or contact, depending on the stressor and ecological component involved.

**Community**—An assemblage of populations of different species within a specified location in space and time.

**Comparative risk assessment**—A process that generally uses a professional judgment approach to evaluate the relative magnitude of effects and set priorities among a wide range of environmental problems (e.g., U.S. EPA, 1993d). Some applications of this process are similar to the problem formulation portion of an ecological risk assessment in that the outcome may help select topics for further evaluation and help focus limited resources on areas having the greatest risk reduction potential. In other situations, a comparative risk assessment is conducted more like a preliminary risk assessment. For example, EPA’s Science Advisory Board used professional judgment and an ecological risk assessment approach to analyze future ecological risk scenarios and risk management alternatives (U.S. EPA, 1995e).

**Conceptual model**—A conceptual model in problem formulation is a written description and visual representation of predicted relationships between ecological entities and the stressors to which they may be exposed.

**Cumulative distribution function (CDF)**—Cumulative distribution functions are particularly useful for describing the likelihood that a variable will fall within different ranges of  $x$ .  $F(x)$  (i.e., the value of  $y$  at  $x$  in a CDF plot) is the probability that a variable will have a value less than or equal to  $x$  (figure B-1).

**Cumulative ecological risk assessment**—A process that involves consideration of the aggregate ecological risk to the target entity caused by the accumulation of risk from multiple stressors.

**Disturbance**—Any event or series of events that disrupts ecosystem, community, or population structure and changes resources, substrate availability, or the physical environment (modified from White and Pickett, 1985).

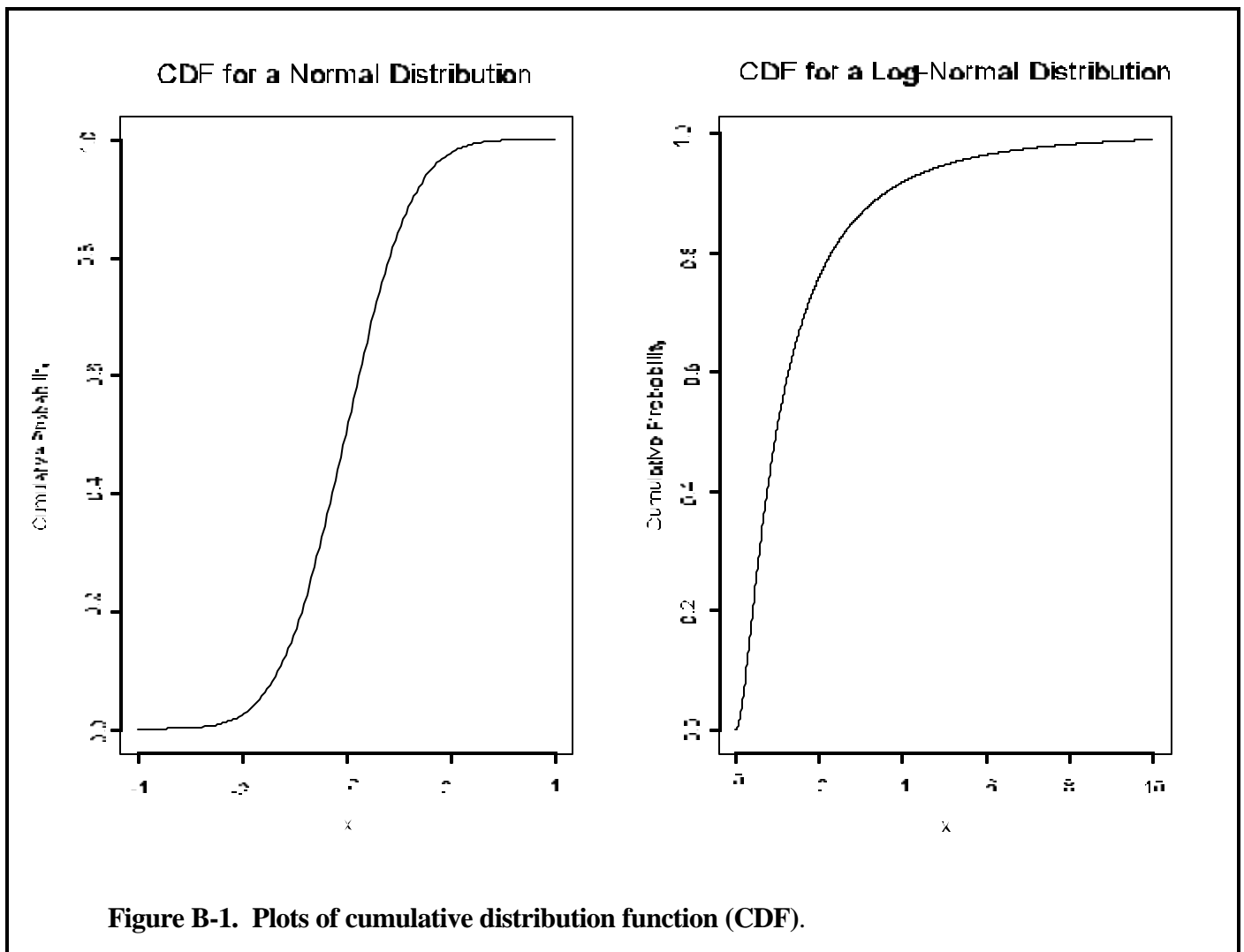

**Figure B-1. Plots of cumulative distribution function (CDF).**

**EC<sub>50</sub>**—A statistically or graphically estimated concentration that is expected to cause one or more specified effects in 50% of a group of organisms under specified conditions (ASTM, 1996).

**Ecological entity**—A general term that may refer to a species, a group of species, an ecosystem function or characteristic, or a specific habitat. An ecological entity is one component of an assessment endpoint.

**Ecological relevance**—One of the three criteria for assessment endpoint selection. Ecologically relevant endpoints reflect important characteristics of the system and are functionally related to other endpoints.

**Ecological risk assessment**—The process that evaluates the likelihood that adverse ecological effects may occur or are occurring as a result of exposure to one or more stressors.

**Ecosystem**—The biotic community and abiotic environment within a specified location in space and time.

**Environmental impact statement (EIS)**—Environmental impact statements are prepared under the National Environmental Policy Act by Federal agencies as they evaluate the environmental consequences of proposed actions. EISs describe baseline environmental conditions; the purpose of, need for, and consequences of a proposed action; the no-action alternative; and the consequences of a reasonable range of alternative actions. A separate risk assessment could be prepared for each alternative, or a comparative risk assessment might be developed. However, risk assessment is not the only approach used in EISs.

**Exposure**—The contact or co-occurrence of a stressor with a receptor.

**Exposure profile**—The product of characterization of exposure in the analysis phase of ecological risk assessment. The exposure profile summarizes the magnitude and spatial and temporal patterns of exposure for the scenarios described in the conceptual model.

**Exposure scenario**—A set of assumptions concerning how an exposure may take place, including assumptions about the exposure setting, stressor characteristics, and activities that may lead to exposure.

**Hazard assessment**—This term has been used to mean either (1) evaluating the intrinsic effects of a stressor (U.S. EPA, 1979) or (2) defining a margin of safety or quotient by comparing a toxicologic effects concentration with an exposure estimate (SETAC, 1987).

**LC<sub>50</sub>**—A statistically or graphically estimated concentration that is expected to be lethal to 50% of a group of organisms under specified conditions (ASTM, 1996).

**Lines of evidence**—Information derived from different sources or by different techniques that can be used to describe and interpret risk estimates. Unlike the term “weight of evidence,” it does not necessarily imply assignment of quantitative weightings to information.

**Lowest-observed-adverse-effect level (LOAEL)**—The lowest level of a stressor evaluated in a test that causes statistically significant differences from the controls.

**Maximum acceptable toxic concentration (MATC)**—For a particular ecological effects test, this term is used to mean either the range between the NOAEL and the LOAEL or the geometric mean of the NOAEL and the LOAEL. The geometric mean is also known as the chronic value.

**Measure of ecosystem and receptor characteristics**—Measures that influence the behavior and location of ecological entities of the assessment endpoint, the distribution of a stressor, and life-history characteristics of the assessment endpoint or its surrogate that may affect exposure or response to the stressor.

**Measure of effect**—A change in an attribute of an assessment endpoint or its surrogate in response to a stressor to which it is exposed.

**Measure of exposure**—A measure of stressor existence and movement in the environment and its contact or co-occurrence with the assessment endpoint.

**Measurement endpoint**—See “measure of effect.”

**No-observed-adverse-effect level (NOAEL)**—The highest level of a stressor evaluated in a test that does not cause statistically significant differences from the controls.

**Population**—An aggregate of individuals of a species within a specified location in space and time.

**Primary effect**—An effect where the stressor acts on the ecological component of interest itself, not through effects on other components of the ecosystem (synonymous with direct effect; compare with definition for secondary effect).

**Probability density function (PDF)**—Probability density functions are particularly useful in describing the relative likelihood that a variable will have different particular values of  $x$ . The probability that a variable will have a value within a small interval around  $x$  can be approximated by multiplying  $f(x)$  (i.e., the value of  $y$  at  $x$  in a PDF plot) by the width of the interval (figure B-2).

**Prospective risk assessment**—An evaluation of the future risks of a stressor(s) not yet released into the environment or of future conditions resulting from an existing stressor(s).

**Receptor**—The ecological entity exposed to the stressor.

**Recovery**—The rate and extent of return of a population or community to some aspect(s) of its previous condition. Because of the dynamic nature of ecological systems, the attributes of a “recovered” system should be carefully defined.

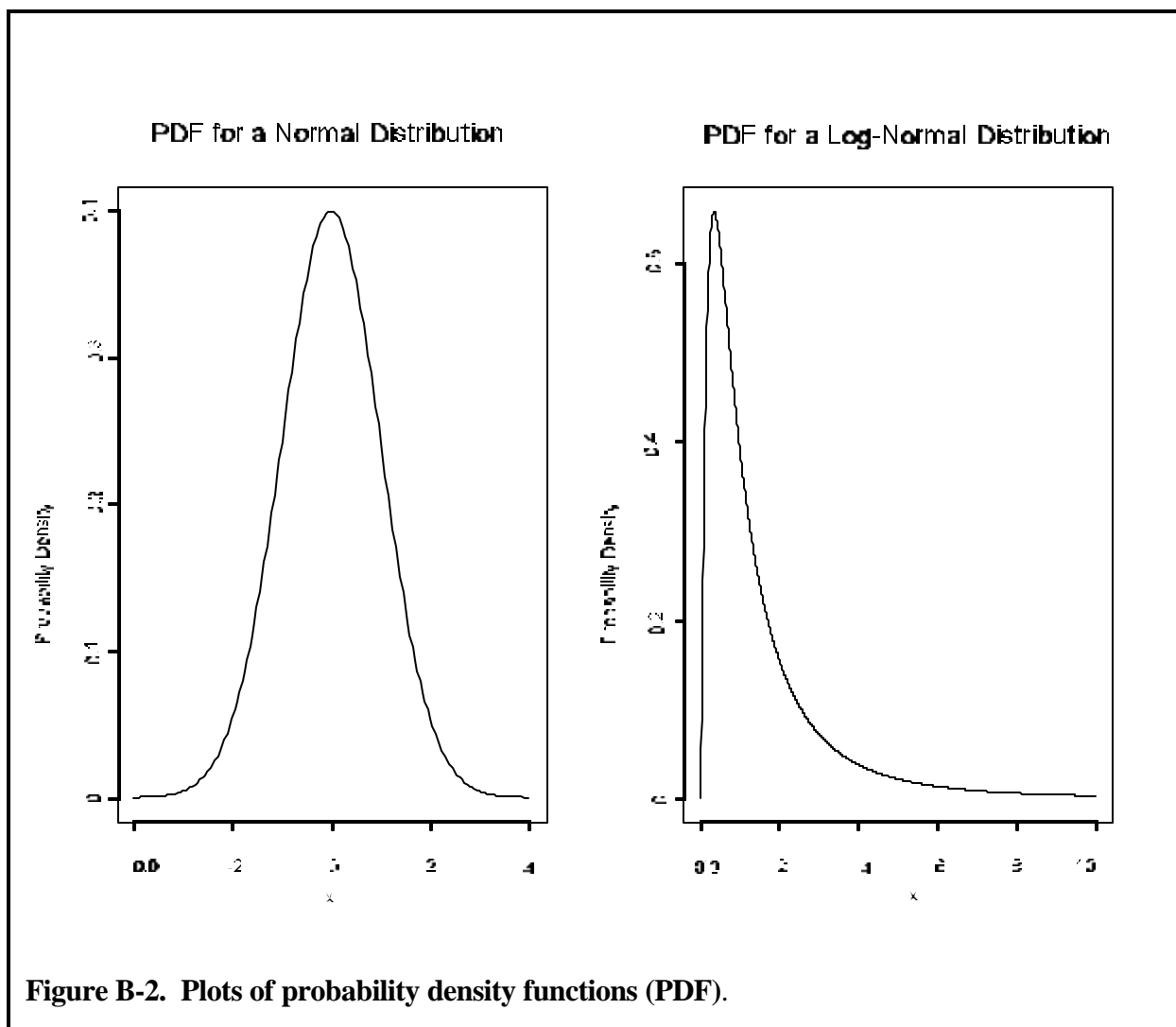

**Figure B-2. Plots of probability density functions (PDF).**

**Relative risk assessment**—A process similar to comparative risk assessment. It involves estimating the risks associated with different stressors or management actions. To some, relative risk connotes the use of quantitative risk techniques, while comparative risk approaches more often rely on professional judgment. Others do not make this distinction.

**Retrospective risk assessment**—An evaluation of the causal linkages between observed ecological effects and stressor(s) in the environment.

**Risk characterization**—A phase of ecological risk assessment that integrates the exposure and stressor response profiles to evaluate the likelihood of adverse ecological effects associated with exposure to a stressor. Lines of evidence and the adversity of effects are discussed.

**Secondary effect**—An effect where the stressor acts on supporting components of the ecosystem, which in turn have an effect on the ecological component of interest (synonymous with indirect effects; compare with definition for primary effect).

**Source**—An entity or action that releases to the environment or imposes on the environment a chemical, physical, or biological stressor or stressors.

**Source term**—As applied to chemical stressors, the type, magnitude, and patterns of chemical(s) released.

**Stressor**—Any physical, chemical, or biological entity that can induce an adverse response (synonymous with agent).

**Stressor-response profile**—The product of characterization of ecological effects in the analysis phase of ecological risk assessment. The stressor-response profile summarizes the data on the effects of a stressor and the relationship of the data to the assessment endpoint.

**Stress regime**—The term “stress regime” has been used in at least three distinct ways: (1) to characterize exposure to multiple chemicals or to both chemical and nonchemical stressors (more clearly described as multiple exposure, complex exposure, or exposure to mixtures), (2) as a synonym for exposure that is intended to avoid overemphasis on chemical exposures, and (3) to describe the series of interactions of exposures and effects resulting in secondary exposures, secondary effects and, finally, ultimate effects (also known as risk cascade [Lipton et al., 1993]), or causal chain, pathway, or network (Andrewartha and Birch, 1984).

**Trophic levels**—A functional classification of taxa within a community that is based on feeding relationships (e.g., aquatic and terrestrial green plants make up the first trophic level and herbivores make up the second).



## APPENDIX C—CONCEPTUAL MODEL EXAMPLES

Conceptual model diagrams are visual representations of the conceptual models. They may be based on theory and logic, empirical data, mathematical models, or probability models. These diagrams are useful tools for communicating important pathways in a clear and concise way. They can be used to ask new questions about relationships that help generate plausible risk hypotheses. Further discussion of conceptual models is found in section 3.4.

Flow diagrams like those shown in figures C-1 through C-3 are typical conceptual model diagrams. When constructing flow diagrams, it is helpful to use distinct and consistent shapes to distinguish between stressors, assessment endpoints, responses, exposure routes, and ecosystem

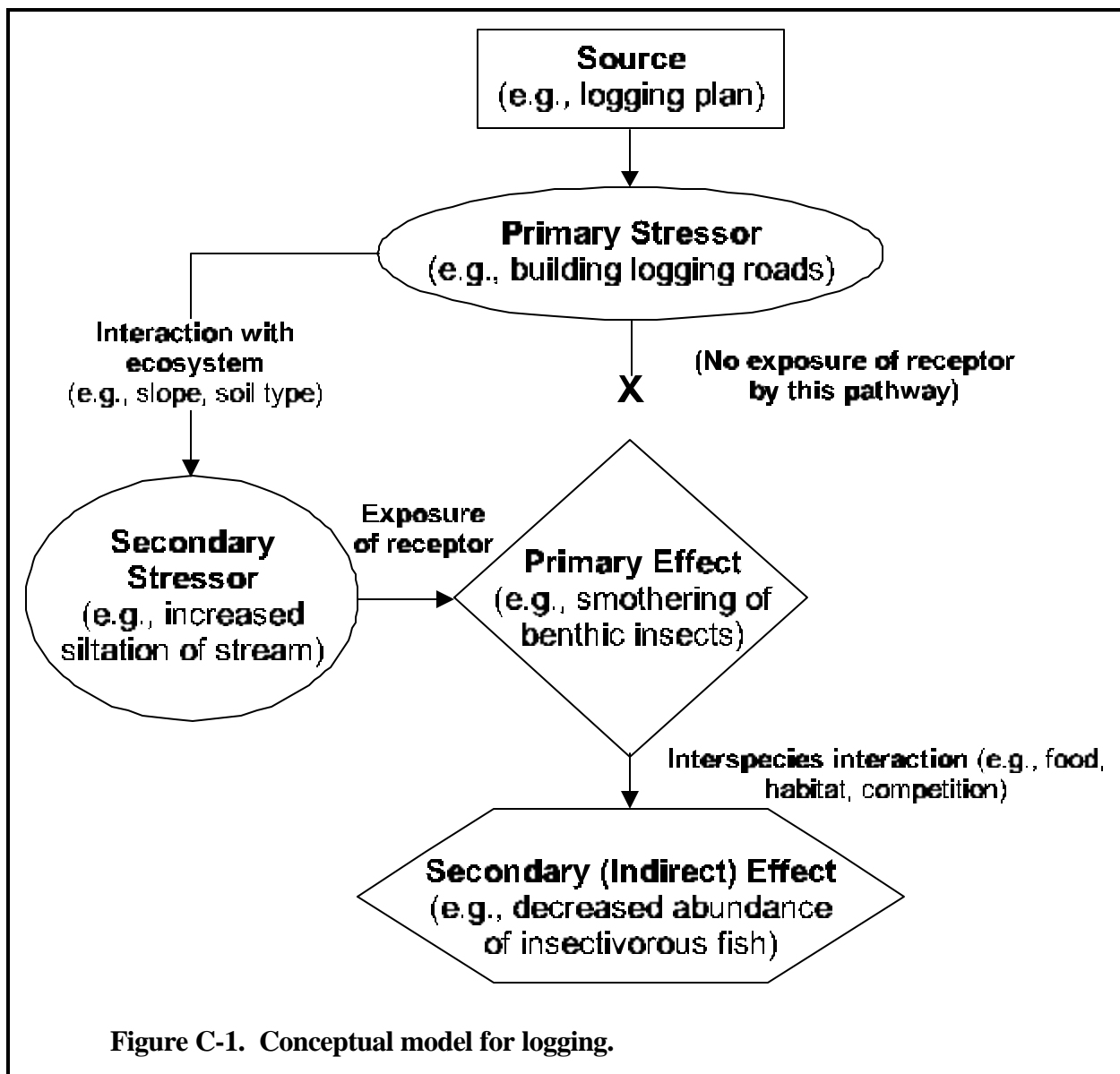

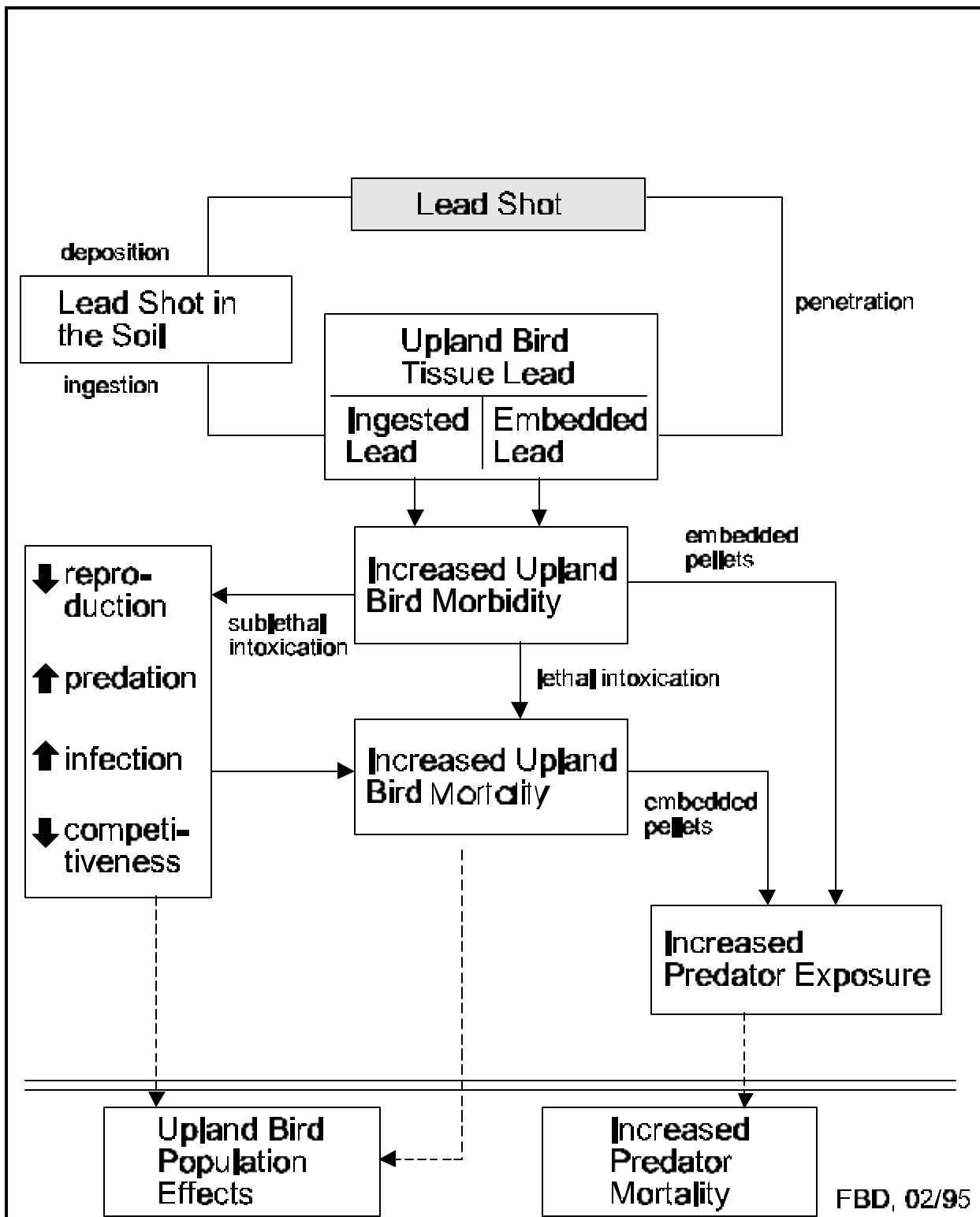
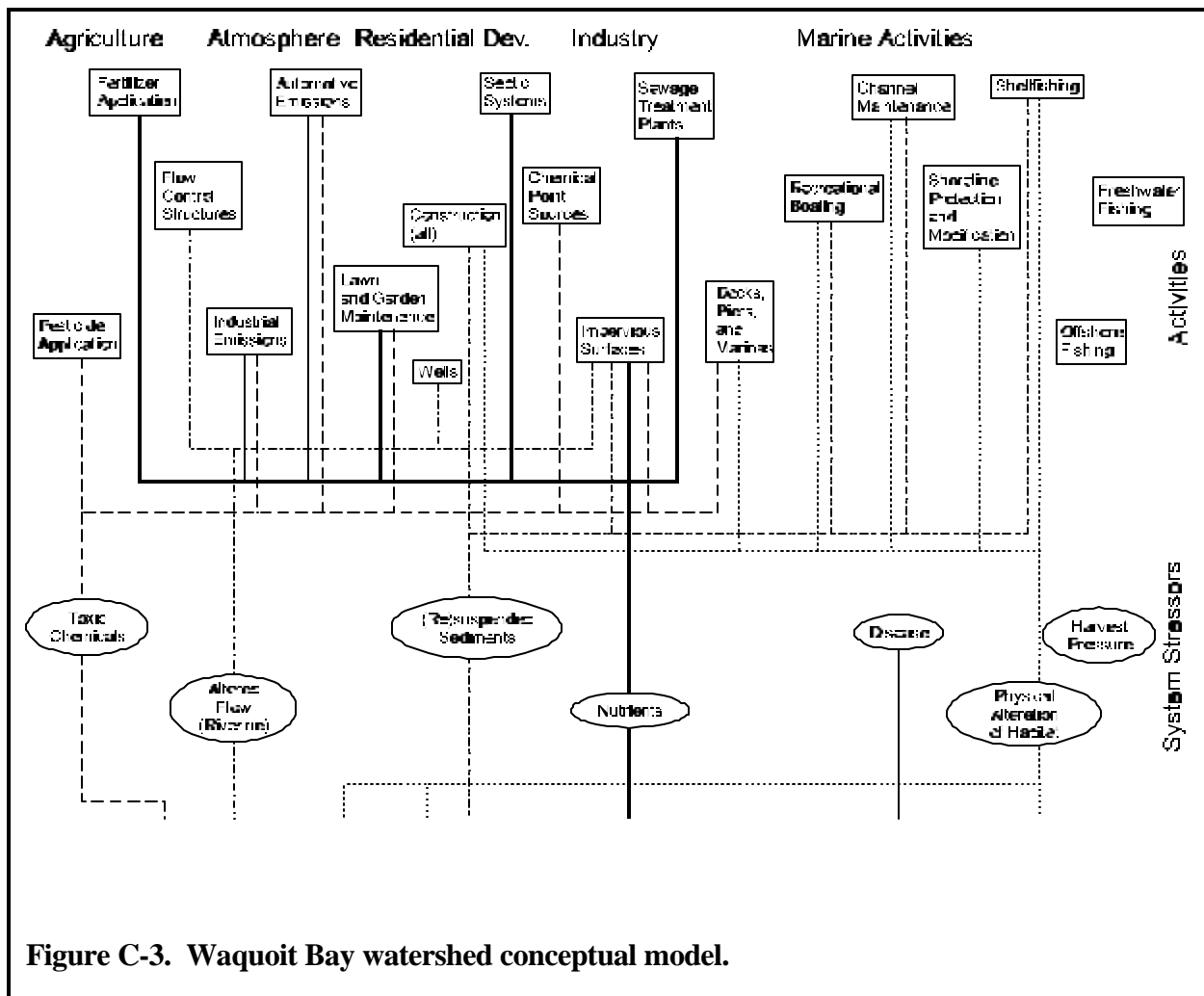

Figure C-2. Conceptual model for tracking stress associated with lead shot through upland ecosystems. Reprinted from *Environmental Toxicology and Chemistry* by Kendall et al. (1996) with permission of the Society of Environmental Toxicology and Chemistry (copyright 1996).



**Figure C-3. Waquoit Bay watershed conceptual model.**

processes. Although flow diagrams are often used to illustrate conceptual models, there is no set configuration for conceptual model diagrams, and the level of complexity may vary considerably depending on the assessment. Pictorial representations of the processes of an ecosystem can be more effective (e.g., Bradley and Smith, 1989).

Figure C-1 illustrates the relationship between a primary physical stressor (logging roads) and an effect on an assessment endpoint (fecundity in insectivorous fish). This simple diagram illustrates the effect of building logging roads (which could be considered a stressor or a source) in ecosystems where slope, soil type, low riparian cover, and other ecosystem characteristics lead to the erosion of soil, which enters streams and smothers the benthic organisms (exposure pathway is not explicit in this diagram). Because of the dependence of insectivorous fish on benthic organisms, the fish are believed to be at risk from the building of logging roads. Each arrow in this diagram represents a hypothesis

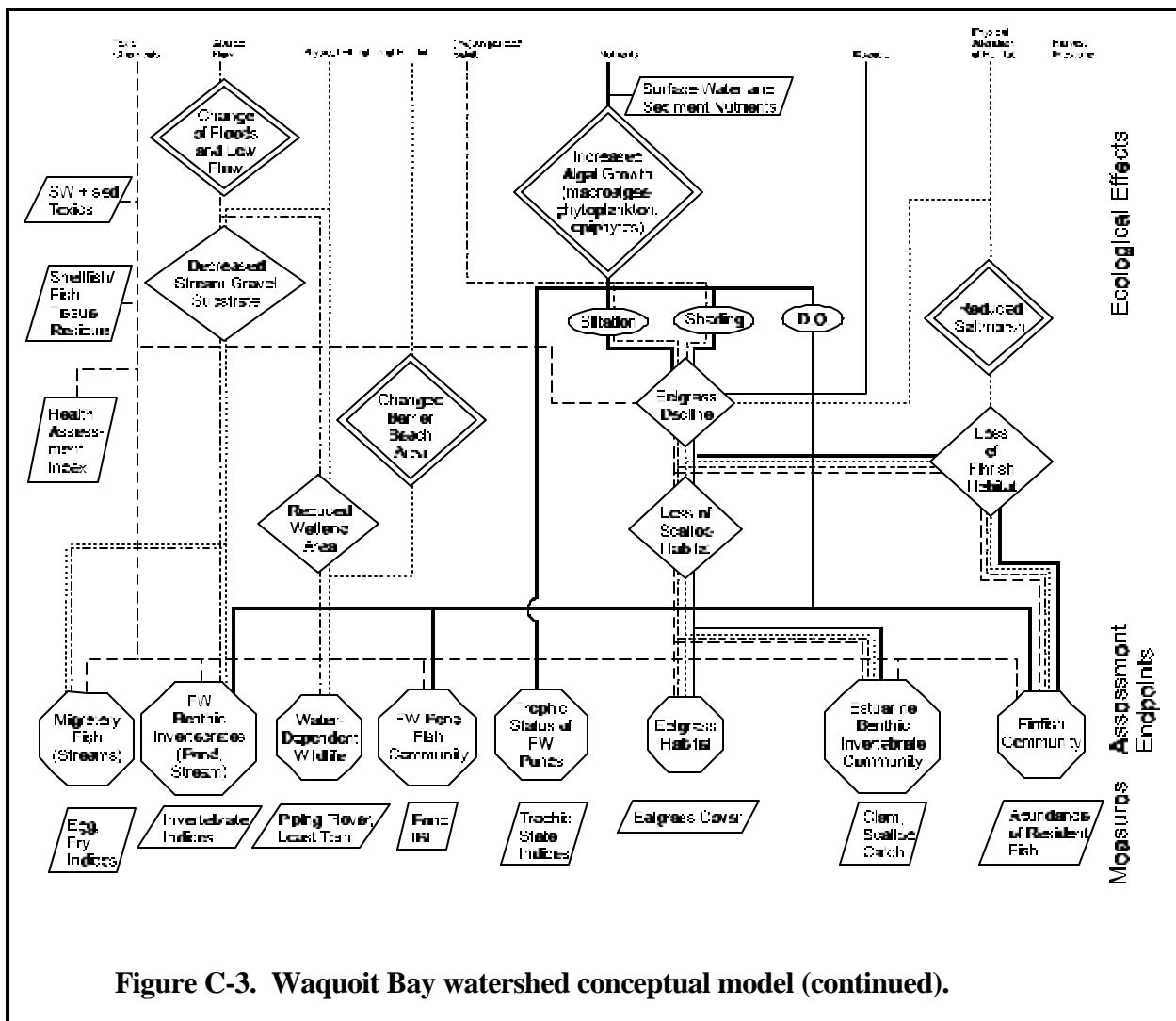

about the proposed relationship (e.g., human action and stressor, stressor and effect, primary effect to secondary effect). Each risk hypothesis

provides insights into the kinds of data that will be needed to verify that the hypothesized relationships are valid.

Figure C-2 is a conceptual model used by Kendall et al. (1996) to track a contaminant through upland ecosystems. In this example, upland birds are exposed to lead shot when it becomes embedded in their tissue after being shot and by ingesting lead accidentally when feeding on the ground. Both are hypothesized to result in increased morbidity (e.g., lower reproduction and competitiveness and higher predation and infection) and mortality, either directly (lethal intoxication) or indirectly (effects of morbidity leading to mortality). These effects are believed to result in changes in upland bird populations

and, because of hypothesized exposure of predators to lead, to increased predator mortality. This example shows multiple exposure pathways for effects on two assessment endpoints. Each arrow contains within it assumptions and hypotheses about the relationship depicted that provide the basis for identifying data needs and analyses.

Figure C-3 is a conceptual model adapted from the Waquoit Bay watershed risk assessment. At the top of the model, multiple human activities that occur in the watershed are shown in rectangles. Those sources of stressors are linked to stressor types depicted in ovals. Multiple sources are shown to contribute to an individual stressor, and each source may contribute to more than one stressor. The stressors then lead to multiple ecological effects depicted again in rectangles. Some rectangles are double-lined to indicate effects that can be directly measured for data analysis. Finally, the effects are linked to particular assessment endpoints. The connections show that one effect can result in changes in many assessment endpoints. To fully depict exposure pathways and types of effects, specific portions of this conceptual model would need to be expanded to illustrate those relationships.

## APPENDIX D—ANALYSIS PHASE EXAMPLES

The analysis phase process is illustrated here for a chemical, physical, and biological stressor. These examples do not represent all possible approaches, but they illustrate the analysis phase process using information from actual assessments.

### D.1. SPECIAL REVIEW OF GRANULAR FORMULATIONS OF CARBOFURAN BASED ON ADVERSE EFFECTS ON BIRDS

Figure D-1 is based on an assessment of the risks of carbofuran to birds under the Federal Insecticide, Fungicide, and Rodenticide Act (FIFRA) (Houseknecht, 1993). Carbofuran is a broad-spectrum insecticide and nematicide applied primarily in granular form on 27 crops as well as forests and pine seed orchards. The assessment endpoint was survival of birds that forage in agricultural areas where carbofuran is applied.

The analysis phase focused on birds that may incidentally ingest granules as they forage or that may eat other animals that contain granules or residues. Measures of exposure included application rates, attributes of the formulation (e.g., size of granules), and residues in prey organisms. Measures of the ecosystem and receptors included an inventory of bird species that may be exposed following applications for 10 crops. The birds' respective feeding behaviors were considered in developing routes of exposure. Measures of effect included laboratory toxicity studies and field investigations of bird mortality.

The source of the chemical was application of the pesticide in granular form. The distribution of the pesticide in agricultural fields was estimated on the basis of the application rate. The number of exposed granules was estimated from literature data. On the basis of a review of avian feeding behavior, seed-eating birds were assumed to ingest any granules left uncovered in the field. The intensity of exposure was summarized as the number of exposed granules per square foot.

The stressor-response relationship was described using the results of toxicity tests. These data were used to construct a toxicity statistic expressed as the number of granules needed to kill 50% of the test birds (i.e., granules per  $LD_{50}$ ), assuming 0.6 mg of active ingredient per granule and average body weights for the birds tested. Field studies were used to document the occurrence of bird deaths following applications and provide further causal evidence. Carbofuran residues and cholinesterase levels were used to confirm that exposure to carbofuran caused the deaths.

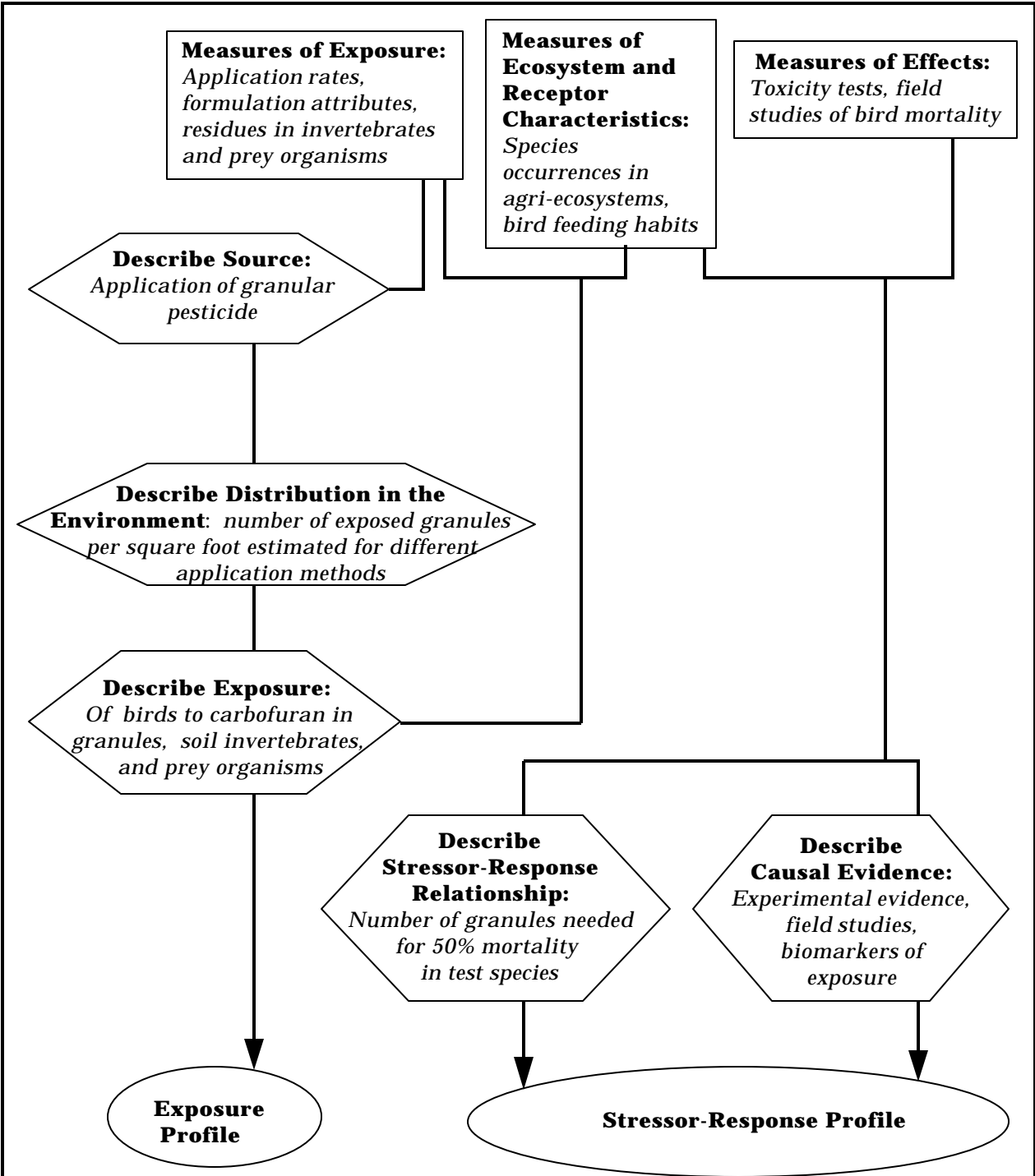

**Figure D-1. Example of the analysis phase process: special review of carbofuran. Rectangles indicate inputs, hexagons indicate actions, and circles indicate outputs.**





## **D.2. MODELING LOSSES OF BOTTOMLAND-FOREST WETLANDS**

Figure D-2 is based on an assessment of the ecological consequences (risks) of long-term changes in hydrologic conditions (water-level elevations) for three habitat types in the Lake Verret Basin of Louisiana (Brody et al., 1989, 1993; Conner and Brody, 1989). The project was intended to provide a habitat-based approach for assessing the environmental impacts of Federal water projects under the National Environmental Policy Act and Section 404 of the Clean Water Act. Output from the models provided risk managers with information on how changes in water elevation might alter the ecosystem. The primary anthropogenic stressor addressed in this assessment was artificial levee construction for flood control, which contributes to land subsidence by reducing sediment deposition in the floodplain. Assessment endpoints included forest community structure and habitat value to wildlife species and the species composition of the wildlife community.

The analysis phase began by considering primary (direct) effects of water-level changes on plant community composition and habitat characteristics. Measures of exposure included the attributes and placement of the levees and water-level measurements. Measures of ecosystem and receptor characteristics included location and extent of bottomland-hardwood communities, plant species occurrences within these communities, and information on historic flow regimes. Measures of effects included laboratory studies of plant response to moisture and field measurements along moisture gradients.

While the principal stressor under evaluation was the construction of levees, the decreased gradient of the river due to sediment deposition at its mouth also contributed to increased water levels. The extent and frequency of flooding were simulated by the FORFLO model based on estimates of net subsidence rates from levee construction and decreased river gradient. Seeds and seedlings of the tree species were assumed to be exposed to the altered flooding regime. Stressor-response relationships describing plant response to moisture (e.g., seed germination, survival) were embedded within the FORFLO model. This information was used by the model to simulate changes in plant communities: the model tracks the species type, diameter, and age of each tree on simulated plots from the time the tree enters the plot as a seedling or sprout until it dies. The FORFLO model calculated changes in the plant community over time (from 50 to 280 years). The spatial extent of the three habitat types of interest—wet bottomland hardwoods, dry bottomland hardwoods, and cypress-tupelo swamp—was mapped into a GIS along with the hydrological information. The changes projected by FORFLO were then manually linked to the GIS to show how the spatial distribution of different communities would change. Evidence that flooding would actually cause these changes included comparisons of model predictions with field measurements, the laboratory studies of plant response to

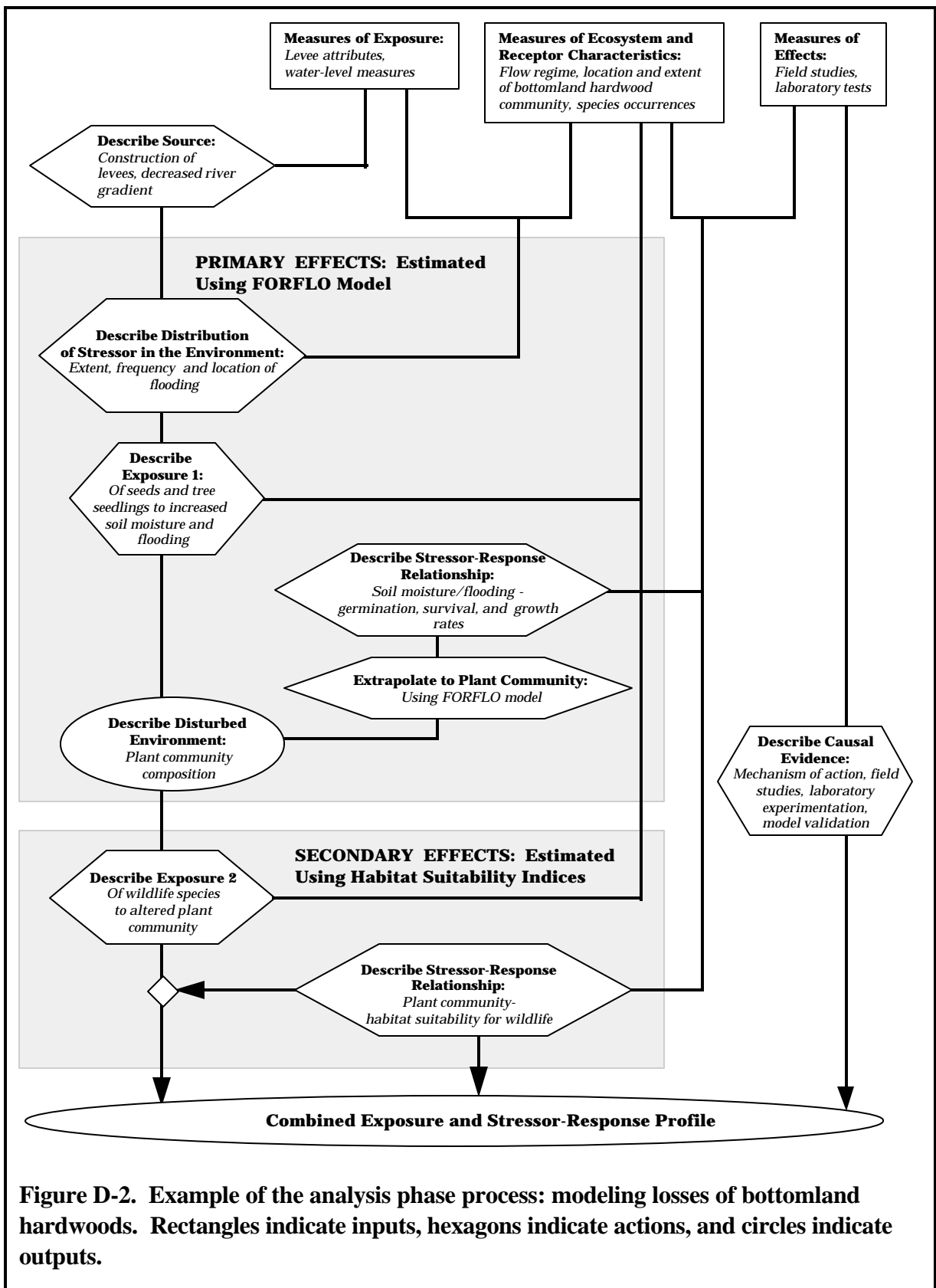

moisture, and knowledge of the mechanisms by which flooding elicits changes in plant communities.

Secondary (indirect) effects on wildlife associated with changes in the habitat provided by the plant community formed the second part of the analysis phase. Important measures included life-history characteristics and habitat needs of the wildlife species. Effects on wildlife were inferred by evaluating the suitability of the plant community as habitat. Specific aspects of the community structures calculated by the FORFLO model provided the input to this part of the analysis. For example, the number of snags was used to evaluate habitat value for woodpeckers. Resident wildlife (represented by five species) was assumed to co-occur with the altered plant community. Habitat value was evaluated by calculating the Habitat Suitability Index (HSI) for each habitat type multiplied by the habitat type's area.

A combined exposure and stressor-response profile is shown in figure D-2; these two elements were combined with the models used for the analysis and then used directly in risk characterization.

### **D.3. PEST RISK ASSESSMENT OF IMPORTATION OF LOGS FROM CHILE**

Figure D-3 is based on the assessment of potential risks to U.S. forests due to the incidental introduction of insects, fungi, and other pests inhabiting logs harvested in Chile and transported to U.S. ports (USDA, 1993). This risk assessment was used to determine whether actions to restrict or regulate the importation of Chilean logs were needed to protect U.S. forests and was conducted by a team of six experts under the auspices of the U.S. Department of Agriculture Forest Service. Stressors include insects, forest pathogens (e.g., fungi), and other pests. The assessment endpoint was the survival and growth of tree species (particularly conifers) in the western United States. Damage that would affect the commercial value of the trees as lumber was clearly of interest.

The analysis phase was carried out by eliciting professional opinions from a team of experts. Measures of exposure used by the team included distribution information for the imported logs and attributes of the insects and pathogens such as dispersal mechanisms and life-history characteristics. Measures of ecosystem and receptor characteristics included the climate of the United States, location of geographic barriers, knowledge of host suitability, and ranges of potential host species. Measures of effect included knowledge of the infectivity of these pests in other countries and the infectivity of similar pests on U.S. hosts.

This information was used by the risk assessment team to evaluate the potential for exposure. They began by evaluating the likelihood of entry of infested logs into the United States. The distribution of the organism's given entry was evaluated by considering the potential

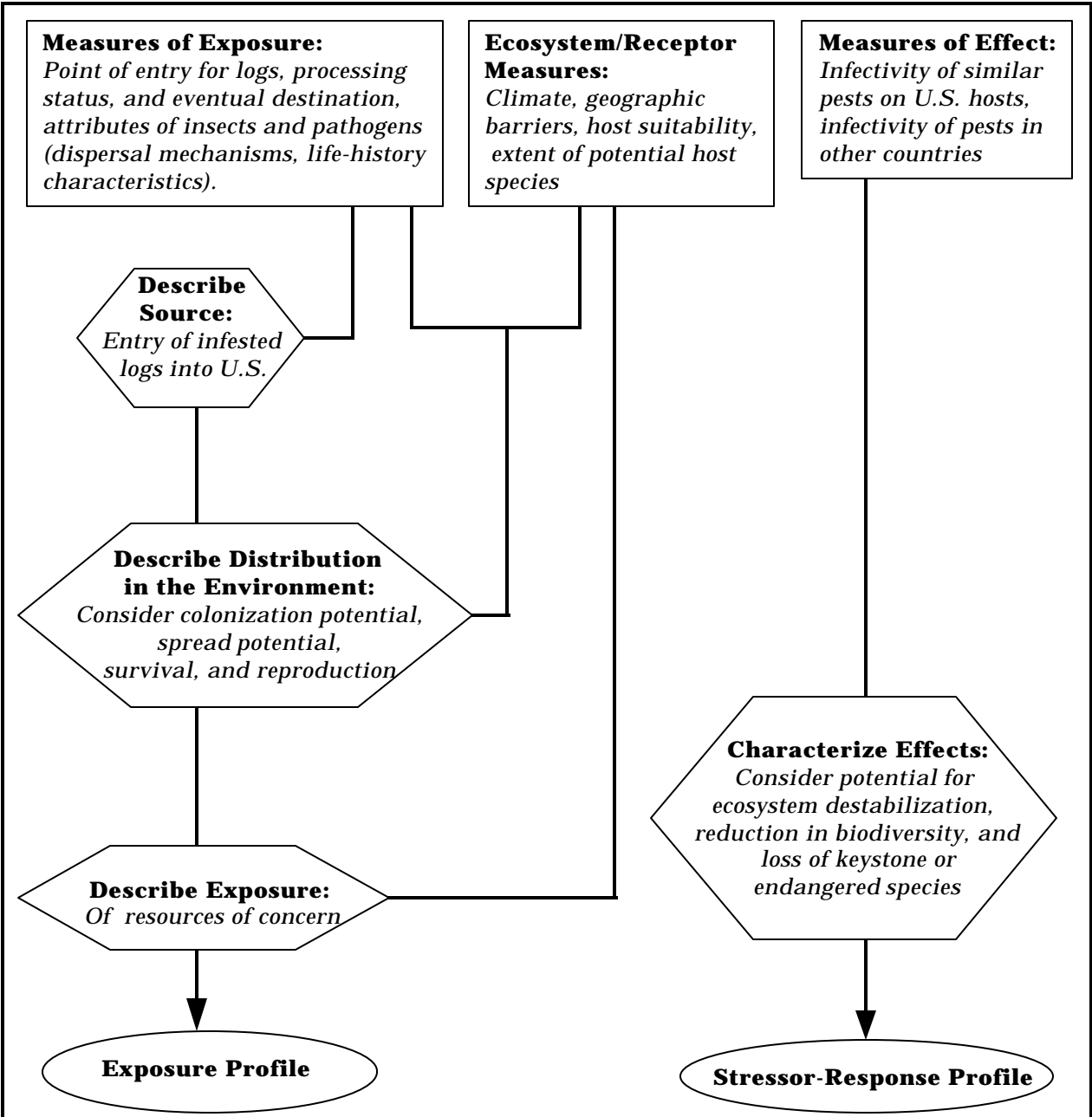

**Figure D-3. Example of the analysis phase process: pest risk assessment of the importation of logs from Chile. Rectangles indicate inputs, hexagons indicate actions, and circles indicate outputs.**



for colonization and spread beyond the point of entry as well as the likelihood of the organisms surviving and reproducing. The potential for exposure was summarized by assigning each of the above elements a judgment-based value of high, medium, or low.

The evaluation of ecological effects was also conducted on the basis of collective professional judgment. Of greatest relevance to this guidance was the consideration of environmental damage potential, defined as the likelihood of ecosystem destabilization, reduction in biodiversity, loss of keystone species, and reduction or elimination of endangered or threatened species. (The team also considered economic damage potential and social and political influences; however, for the purposes of these Guidelines, those factors are considered to be part of the risk management process.) Again, each consideration was assigned a value of high, medium, or low to summarize the potential for ecological effects.

**APPENDIX E—CRITERIA FOR DETERMINING ECOLOGICAL ADVERSITY: A  
HYPOTHETICAL EXAMPLE (Adapted from Hartwell et al., 1994)<sup>2</sup>**

As a result of a collision at sea, an oil tanker releases 15 million barrels of #2 fuel oil 3 km offshore. It is predicted that prevailing winds will carry the fuel onshore within 48 to 72 hours. The coastline has numerous small embayments that support an extensive shallow, sloping subtidal community and a rich intertidal community. A preliminary assessment determines that if no action is taken, significant risks to the communities will result. Additional risk assessments are conducted to determine which of two options should be used to clean up the oil spill.

Option 1 is to use a dispersant to break up the slick, which would reduce the likelihood of extensive onshore contamination but would cause extensive mortality to the phytoplankton, zooplankton, and ichthyoplankton (fish larvae), which are important for commercial fisheries. Option 2 is to try to contain and pump off as much oil as possible; this option anticipates that a shift in wind direction will move the spill away from shore and allow for natural dispersal at sea. If this does not happen, the oil will contaminate the extensive sub- and intertidal mud flats, rocky intertidal communities, and beaches and pose an additional hazard to avian and mammalian fauna. It is assumed there will be a demonstrable change beyond natural variability in the assessment endpoints (e.g., structure of planktonic, benthic, and intertidal communities). What is the adversity of each option?

- Nature and intensity of the effect. For both options, the magnitude of change in the assessment endpoints is likely to be severe. Planktonic populations often are characterized by extensive spatial and temporal variability. Nevertheless, within the spatial boundaries of the spill, the use of dispersants is likely to produce complete mortality of all planktonic forms within the upper 3 m of water. For benthic and intertidal communities, which generally are stable and have less spatial and temporal variability than planktonic forms, oil contamination will likely result in severe impacts on survival and chronic effects lasting for several years. Thus, under both options, changes in the assessment endpoints will probably exceed the natural variability for threatened communities in both space and time.

---

<sup>2</sup> This example is simplified for illustrative purposes. In other situations, it may be considerably more difficult to draw clear conclusions regarding relative ecological adversity.

- Spatial scale. The areal extent of impacts is similar for each of the options. While extensive, the area of impact constitutes a small percentage of the landscape. This leaves considerable area available for replacement stocks and creates significant fragmentation of either the planktonic or inter- and subtidal habitats. Ecological adversity is reduced because the area is not a mammalian or avian migratory corridor.
- Temporal scale and recovery. On the basis of experience with other oil spills, it is assumed that the effects are reversible over some time period. The time needed for reversibility of changes in phytoplankton and zooplankton populations should be short (days to weeks) given their rapid generation times and easy immigration from adjacent water masses. There should not be a long recovery period for ichthyoplankton, since they typically experience extensive natural mortality, and immigration is readily available from surrounding water masses. On the other hand, the time needed for reversibility of changes in benthic and intertidal communities is likely to be long (years to decades). First, the stressor (oil) would be likely to persist in sediments and on rocks for several months to years. Second, the life histories of the species comprising these communities span 3 to 5 years. Third, the reestablishment of benthic intertidal community and ecosystem structure (hierarchical composition and function) often requires decades.

Both options result in (1) assessment endpoint effects that are of great severity, (2) exceedances of natural variability for those endpoints, and (3) similar estimates of areal impact. What distinguishes the two options is temporal scale and reversibility. In this regard, changes to the benthic and intertidal ecosystems are considerably more adverse than those to the plankton. On this basis, the option of choice would be to disperse the oil, effectively preventing it from reaching shore where it would contaminate the benthic and intertidal communities.



## REFERENCES

- Alder, HL; Roessler, EB. (1972) Introduction to probability and statistics. San Francisco, CA: WH Freeman and Co.
- American Society for Quality Control (ASQC). (1994) American National Standard: specifications and guidelines for quality systems for environmental data collection and environmental technology programs. ANSI/ASQC E4-1994. Milwaukee, WI: SQC.
- American Society for Testing and Materials. (1996) Standard terminology relating to biological effects and environmental fate. E943-95a. In: ASTM; 1996 Annual Book of ASTM Standards, Section 11, Water and Environmental Technology. Philadelphia, PA: ASTM.
- Andrewartha, HG; Birch, LC. (1984) The ecological web: more on the distribution and abundance of animals. Chicago, IL: University of Chicago Press.
- Ankley, GT; Katko, A; Arthur, JW. (1990) Identification of ammonia as an important sediment-associated toxicant in the Lower Fox River and Green Bay, Wisconsin. Environ Toxicol Chem 9:313-322.
- Auer, CM; Zeeman, M; Nabholz, JV; Clements, RG. (1994) SAR—the U.S. regulatory perspective. SAR QSAR Environ Res 2:29-38.
- Baker, JL; Barefoot, AC; Beasley, LE; Burns, LA; Caulkins, PP; Clark, JE; Feulner, RL; Giesy, JP; Graney, RL; Griggs, RH; Jacoby, HM; Laskowski, DA; Maciorowski, AF; Mihaich, EM; Nelson, HP, Jr.; Parrish, PR; Siefert, RE; Solomon, KR; van der Schalie, WH, eds. (1994) Aquatic dialogue group: pesticide risk assessment and mitigation. Pensacola, FL: SETAC Press.
- Barbour, MT; Stribling, JB; Karr, JR. (1995) Multimetric approach for establishing biocriteria and measuring biological condition. In: Biological assessment and criteria, tools for water resource planning and decision making. Davis, WS; Simon, TP, eds. Boca Raton, FL: Lewis Publishers, pp. 63-77.
- Barnhouse, LW; Brown, J. (1994) Issue paper on conceptual model development. In: Ecological risk assessment issue papers. Washington, DC: Risk Assessment Forum, U.S. Environmental Protection Agency, pp. 3-1 to 3-70. EPA/630/R-94/009.
- Barnhouse, LW; O'Neill, RV; Bartell, SM; Suter, GW, II. (1986) Population and ecosystem theory in ecological risk assessment. In: Aquatic ecology and hazard assessment, 9th symposium. Poston, TM; Purdy, R, eds. Philadelphia, PA: American Society for Testing and Materials, pp. 82-96.
- Barnhouse, LW; Suter, GW, II; Rosen, AE; Beauchamp, JJ. (1987) Estimating responses of fish populations to toxic contaminants. Environ Toxicol Chem 6:811-824.

Barnhouse, LW; Suter, GW, II; Rosen, AE. (1990) Risks of toxic contaminants to exploited fish populations: influence of life history, data uncertainty, and exploitation intensity. *Environ Toxicol Chem* 9:297-311.

Bartell, SM; Gardner, RH; O'Neill, RV. (1992) *Ecological risk estimation*. Boca Raton, FL: Lewis Publishers.

Bedford, BL; Preston, EM. (1988) Developing the scientific basis for assessing cumulative effects of wetland loss and degradation on landscape functions: status, perspectives, and prospects. *Environ Manage* 12:751-771.

Bradbury, SP. (1994) Predicting modes of toxic action from chemical structure: an overview. *SAR QSAR Environ Res* 2:89-104.

Bradley, CE; Smith, DG. (1989) Plains cottonwood recruitment and survival on a prairie meandering river floodplain. Milk River, Southern Alberta in Northern Canada. *Can J Botany* 64:1433-1442.

Broderius, SJ. (1991) Modeling the joint toxicity of xenobiotics to aquatic organisms: basic concepts and approaches. In: *Aquatic toxicology and risk assessment: fourteenth volume*. Mayes, MA; Barron, MG, eds. ASTM STP 1124. Philadelphia, PA: American Society for Testing and Materials, pp. 107-127.

Broderius, SJ; Kahl, MD; Hoglund, MD. (1995) Use of joint toxic response to define the primary mode of toxic action for diverse industrial organic chemicals. *Environ Toxicol Chem* 9:1591-1605.

Brody, M; Conner, W; Pearlstine, L; Kitchens, W. (1989) Modeling bottomland forest and wildlife habitat changes in Louisiana's Atchafalaya Basin. In: *Freshwater wetlands and wildlife*. Sharitz, RR; Gibbons, JW, eds. U.S. Department of Energy Symposium Series, No. 61. CONF-8603100. Oak Ridge, TN: Office of Science and Technical Information, U.S. Department of Energy.

Brody, MS; Troyer, ME; Valette, Y. (1993) Ecological risk assessment case study: modeling future losses of bottomland forest wetlands and changes in wildlife habitat within a Louisiana basin. In: *A review of ecological assessment case studies from a risk assessment perspective*. Washington, DC: Risk Assessment Forum, U.S. Environmental Protection Agency, pp. 12-1 to 12-39. EPA/630/R-92/005.

Burmester, DE; Menzie, CA; Freshman, JS; Burris, JA; Maxwell, NI; Drew, SR. (1991) Assessment of methods for estimating aquatic hazards at Superfund-type sites: a cautionary tale. *Environ Toxicol Chem* 10:827-842.

Callahan, CA; Menzie, CA; Burmester, DE; Wilborn, DC; Ernst, T. (1991) On-site methods for assessing chemical impacts on the soil environment using earthworms: a case study at the Baird and McGuire Superfund site, Holbrook, Massachusetts. *Environ Toxicol Chem* 10:817-826.

Cardwell, RD; Parkhurst, BR; Warren-Hicks, W; Volosin, JS. (1993) Aquatic ecological risk. *Water Environ Technol* 5:47-51.

Clemen, RT. (1996) *Making hard decisions*. 2nd ed. New York: Duxbury Press, 664 pp.

Clements, RG; Nabholz, JV. (1994) ECOSAR: a computer program for estimating the ecotoxicity of industrial chemicals based on structure activity relationships, user's guide. Washington, DC: Environmental Effects Branch, Health and Environmental Review Division (7402), U.S. Environmental Protection Agency. EPA/748/R-93/002.

Cohrssen, J; Covello, VT. (1989) Risk analysis: a guide to principles and methods for analyzing health and ecological risks. Washington, DC: Council on Environmental Quality.

Commission on Risk Assessment and Risk Management. (1997) Framework for environmental health risk management. Final Report. Volume 1. Washington, DC: Commission on Risk Assessment and Risk Management.

Conner, WH; Brody, M. (1989) Rising water levels and the future of southeastern Louisiana swamp forests. *Estuaries* 12(4):318-323.

Costanza, R; d'Arge, R; de Groot, R; Farber, S; Grasso, M; Hannon, B; Limburg, K; Naeem, S; O'Neill, RV; Paruelo, J; Raskinm, RG; Sutton, P; van den Belt, M. (1997) The value of the world's ecosystem services and natural capital. *Nature* 387:253-260.

Cowan, CE; Versteeg, DJ; Larson, RJ; Kloepper-Sams, PJ. (1995) Integrated approach for environmental assessment of new and existing substances. *Regul Toxicol Pharmacol* 21:3-31.

Cronin, MTD; Dearden, JC. (1995) QSAR in toxicology. 1. Prediction of aquatic toxicity. *Quant Struct-Act Relat* 14:1-7.

Detenbeck, N. (1994) Ecological risk assessment case study: effects of physical disturbance on water quality status and water quality improvement function of urban wetlands. In: A review of ecological assessment case studies from a risk assessment perspective, vol. II. Washington, DC: Risk Assessment Forum, U.S. Environmental Protection Agency, pp. 4-1 to 4-58. EPA/630/R-94/003.

Detenbeck, NE; DeVore, PW; Niemi, GJ; Lima, A. (1992) Recovery of temperate-stream fish communities from disturbance: a review of case studies and synthesis of theory. *Environ Manage* 16(1):33-53.

Eberhardt, LL; Thomas, JM. (1991) Designing environmental field studies. *Ecol Mono* 61(1):53-73.

Emlen, JM. (1989) Terrestrial population models for ecological risk assessment: a state-of-the-art review. *Environ Toxicol Chem* 8:831-842.

European Community (EC). (1993) Technical guidance document in support of the risk assessment Commission Directive (93/67/EEC) for new substances notified in accordance with the requirements of Council Directive 67/548/EEC. Brussels, Belgium.

Ferson, S; Ginzburg, L; Silvers, A. (1989) Extreme event risk analysis for age-structured populations. *Ecol Model* 47:175-187.

- Fisher, SG; Woodmansee, R. (1994) Issue paper on ecological recovery. In: Ecological risk assessment issue papers. Washington, DC: Risk Assessment Forum, U.S. Environmental Protection Agency, pp. 7-1 to 7-54. EPA/630/R-94/009.
- Fotheringham, AS; Rogerson, PA. (1993) GIS and spatial analytical problems. *Int J Geograph Inf Syst* 7(1):3-19.
- Fox, GA. (1991) Practical causal inference for ecoepidemiologists. *J Toxicol Environ Health* 33:359-373.
- Gauch, HG. (1982) *Multivariate analysis in community ecology*. Cambridge, MA: Cambridge University Press.
- Gaudet, C. (1994) *A framework for ecological risk assessment at contaminated sites in Canada: review and recommendations*. Ottawa, Canada: Environment Canada.
- Gibbs, JP. (1993) Importance of small wetlands for the persistence of local populations of wetland-associated animals. *Wetlands* 13(1):25-31.
- Gilbert, RO. (1987) *Statistical methods for environmental pollution monitoring*. New York, NY: Van Nostrand Reinhold.
- Ginzburg, LR; Slobodkin, LB; Johnson, K; Bindman, AG. (1982) Quasiextinction probabilities as a measure of impact on population growth. *Risk Anal* 2:171-182.
- Gosselink, JG; Shaffer, GP; Lee, LC; Burdick, DL; Childer, NC; Leibowitz, NC; Hamilton, SC; Boumans, R; Cushman, D; Fields, S; Koch, M; Visser, JM. (1990) Landscape conservation in a forested wetland watershed: can we manage cumulative impacts? *Bioscience* 40(8):588-600.
- Harris, HJ; Wenger, RB; Harris, VA; Devault, DS. (1994) A method for assessing environmental risk: a case study of Green Bay, Lake Michigan, USA. *Environ Manage* 18(2):295-306.
- Harwell, MJ; Norton, B; Cooper, W; Gentile, J. (1994) Issue paper on ecological significance. In: Ecological risk assessment issue papers. Washington, DC: Risk Assessment Forum, U.S. Environmental Protection Agency, pp. 2-1 to 2-49. EPA/630/R-94/009.
- Hassell, MP. (1986) Detecting density dependence. *Trends Ecol Evol* 1:90-93.
- Health Council of the Netherlands (HCN). (1993) Ecotoxicological risk assessment and policy-making in the Netherlands—dealing with uncertainties. *Network* 6(3)/7(1):8-11.
- Heck, WW. (1993) Ecological assessment case study: the National Crop Loss Assessment Network. In: *A review of ecological assessment case studies from a risk assessment perspective*. Washington, DC: Risk Assessment Forum, U.S. Environmental Protection Agency, pp. 6-1 to 6-32. EPA/630/R-92/005.

- Hermens, J; Canton, H; Janssen, P; De Jong, R. (1984a) Quantitative structure-activity relationships and toxicity studies of mixtures of chemicals with anaesthetic potency: acute lethal and sublethal toxicity to *Daphnia magna*. *Aquatic Toxicol* 5:143-154.
- Hermens, J; Canton, H; Steyger, N; Wegman, R. (1984b) Joint effects of a mixture of 14 chemicals on mortality and inhibition of reproduction of *Daphnia magna*. *Aquatic Toxicol* 5:315-322.
- Hill, AB. (1965) The environment and disease: association or causation? *Proc R Soc Med* 58:295-300.
- Holling, CS, ed. (1978) Adaptive environmental assessment and management. Chichester, UK: John Wiley & Sons.
- Houseknecht, CR. (1993) Ecological risk assessment case study: special review of the granular formulations of carbofuran based on adverse effects on birds. In: A review of ecological assessment case studies from a risk assessment perspective. Washington, DC: Risk Assessment Forum, U.S. Environmental Protection Agency, pp. 3-1 to 3-25. EPA/630/R-92/005.
- Huggett, RJ; Kimerle, RA; Merhle, PM, Jr.; Bergman, HL, eds. (1992) Biomarkers: biochemical, physiological, and histological markers of anthropogenic stress. Boca Raton, FL: Lewis Publishers.
- Hughes, RM. (1995) Defining acceptable biological status by comparing with reference conditions. In: Biological assessment and criteria: tools for water resource planning and decision making. Davis, WS; Simon, TP, eds. Boca Raton, FL: Lewis Publishers, pp. 31-47.
- Hunsaker, CT; Graham, RL; Suter, GW, II; O'Neill, RV; Barnhouse, LW; Gardner, RH. (1990) Assessing ecological risk on a regional scale. *Environ Manage* 14(3):325-332.
- Hurlbert, SH. (1984) Pseudoreplication and the design of ecological field experiments. *Ecol Mono* 54:187-211.
- Johnson, BL. (1995) Applying computer simulation models as learning tools in fishery management. *North Am J Fisheries Manage* 15:736-747.
- Johnson, LB; Gage, SH. (1997) Landscape approaches to the analysis of aquatic ecosystems. *Freshwater Biol* 37:113-132.
- Johnston, CA; Detenbeck, NE; Niemi, GJ. (1990) The cumulative effect of wetlands on stream water quality and quantity: a landscape approach. *Biogeochemistry* 10:105-141.
- Karr, JR. (1981) Assessment of biotic integrity using fish communities. *Fisheries* 6(6):21-27.
- Karr, JR; Fausch, KD; Angermeier, PL; Yant, PR; Schlosser, IJ. (1986) Assessing biological integrity in running waters: a method and its rationale. Illinois Natural History Survey. Special Publication 5. Champaign, IL.

- Kenaga, EE. (1973) Factors to be considered in the evaluation of the toxicity of pesticides to birds in their environment. *Environ Qual Saf* 2:166-181.
- Kendall, RJ; Lacher, TE; Bunck, C; Daniel, B; Driver, C; Grue, CE; Leighton, F; Stansley, W; Watanabe, PG; Whitworth, M. (1996) An ecological risk assessment of lead shot exposure in non-waterfowl avian species: upland game birds and raptors. *Environ Toxicol Chem* 15:4-20.
- Könemann, H. (1981) Fish toxicity tests with mixtures of more than two chemicals: a proposal for a quantitative approach and experimental results. *Aquatic Toxicol* 19:229-238.
- Laird, NM; Mosteller, R. (1990) Some statistical methods for combining experimental results. *Int J Technol Assess Health Care* 6:5-30.
- Landis, WG; Matthews, RA; Markiewicz, AJ; Matthews, GB. (1993) Multivariate analysis of the impacts of the turbine fuel JP-4 in a microcosm toxicity test with implications for the evaluation of ecosystem dynamics and risk assessment. *Ecotoxicology* 2:271-300.
- Lipnick, RL. (1995) Structure-activity relationships. In: *Fundamentals of aquatic toxicology effects, environmental fate, and risk assessment*. Rand, GM; Petrocelli, SR, eds. London, UK: Taylor and Francis, pp. 609-655.
- Lipton, J; Galbraith, H; Burger, J; Wartenberg, D. (1993) A paradigm for ecological risk assessment. *Environ Manage* 17:1-5.
- Ludwig, JA; Reynolds, JF. (1988) *Statistical ecology*. New York, NY: Wiley-Interscience, 337 pp.
- Lynch, DG; Macek, GJ; Nabholz, JV; Sherlock, SM; Wright, R. (1994) Ecological risk assessment case study: assessing the ecological risks of a new chemical under the Toxic Substances Control Act. In: *A review of ecological assessment case studies from a risk assessment perspective, vol. II*. Washington, DC: Risk Assessment Forum, U.S. Environmental Protection Agency, pp. 1-1 to 1-35. EPA/630/R-94/003.
- MacIntosh, DL; Suter GW, II; Hoffman, FO. (1994) Uses of probabilistic exposure models in ecological risk assessments of contaminated sites. *Risk Anal* 14(4):405-419.
- Mann, C. (1990) Meta-analysis in the breech. *Science* 249:476-480.
- McCarty, LS; Mackay, D. (1993) Enhancing ecotoxicological modeling and assessment: body residues and modes of toxic action. *Environ Sci Technol* 27:1719-1728.
- Meij, R. (1991) The fate of mercury in coal-fired power plants and the influence of wet flue-gas desulphurization. *Water Air Soil Pollut* 56:21-33.

Menzie, CA; Burmaster, DE; Freshman, JS; Callahan, CA. (1992) Assessment of methods for estimating ecological risk in the terrestrial component: a case study at the Baird & McGuire Superfund Site in Holbrook, Massachusetts. *Environ Toxicol Chem* 11:245-260.

Menzie, C; Henning, MH; Cura, J; Finkelstein, K; Gentile, J; Maughan J; Mitchell, D; Petron, S; Potocki, B; Svirsky, S; Tyler, P. (1996) Special report of the Massachusetts weight-of-evidence workgroup: a weight of evidence approach for evaluating ecological risks. *Human Ecol Risk Assess* 2:277-304.

Messer, JJ; Linthurst, RA; Overton, WS. (1991) An EPA program for monitoring ecological status and trends. *Environ Monitor Assess* 17:67-78.

Nabholz, JV. (1991) Environmental hazard and risk assessment under the United States Toxic Substances Control Act. *Science Total Environ* 109/110: 649-665.

Nabholz, JV; Miller, P; Zeeman, M. (1993) Environmental risk assessment of new chemicals under the Toxic Substances Control Act (TSCA) section five. In: *Environmental toxicology and risk assessment*. Landis, WG; Hughes, SG; Lewis, M; Gorsuch, JW, eds. ASTM STP 1179. Philadelphia, PA: American Society for Testing and Materials, pp. 40-55.

National Research Council. (1994) *Science and judgment in risk assessment*. Washington, DC: National Academy Press.

National Research Council. (1996) *Understanding risk: informing decisions in a democratic society*. Washington, DC: National Academy Press.

Newman, MC. (1995) *Advances in trace substances research: quantitative methods in aquatic ecotoxicology*. Boca Raton, FL: Lewis Publishers.

Niemi, GJ; DeVore, P; Detenbeck, N; Taylor, D; Lima, A; Pastor, J; Yount, JD; Naiman, RJ. (1990) Overview of case studies on recovery of aquatic systems from disturbance. *Environ Manage* 14:571-587.

Novitski, RP. (1979) Hydrologic characteristics of Wisconsin's wetlands and their influence on floods, stream flow, and sediment. In: *Wetland functions and values: the state of our understanding*. Greeson, PE; Clark, JR; Clark, JE, eds. Minneapolis, MN: American Water Resources Association, pp. 377-388.

Oberts, GL. (1981) Impact of wetlands on watershed water quality. In: *Selected proceedings of the Midwest Conference on Wetland Values and Management*. Richardson, B, ed. Navarre, MN: Freshwater Society, pp. 213-226.

Okkerman, PC; Plassche, EJVD; Emans, HJB. (1993) Validation of some extrapolation methods with toxicity data derived from multispecies experiments. *Ecotoxicol Environ Saf* 25:341-359.

O'Neill, RV; Gardner, RH; Barnthouse, LW; Suter, GW, II; Hildebrand, SG; Gehrs, CW. (1982) Ecosystem risk analysis: a new methodology. *Environ Toxicol Chem* 1:167-177.

Orr, RL; Cohen, SD; Griffin, RL. (1993) Generic non-indigenous pest risk assessment process. Beltsville, MD: USDA Animal and Plant Health Inspection Service.

Ott, WR. (1978) Environmental indices—theory and practice. Ann Arbor, MI: Ann Arbor Science. Cited in: Suter, GW, II. (1993) A critique of ecosystem health concepts and indexes. *Environ Toxicol Chem* 12:1533-1539.

Parkhurst, BR; Warren-Hicks, W; Etchison, T; Butcher, JB; Cardwell, RD; Voloson, J. (1995) Methodology for aquatic ecological risk assessment. RP91-AER-1 1995. Alexandria, VA: Water Environment Research Foundation.

Pastorok, RA; Butcher, MK; Nielsen, RD. (1996) Modeling wildlife exposure to toxic chemicals: trends and recent advances. *Human Ecol Risk Assess* 2:444-480.

Pearlstine, L; McKellar, H; Kitchens, W. (1985) Modelling the impacts of a river diversion on bottomland forest communities in the Santee River Floodplain, South Carolina. *Ecol Model* 29:281-302.

Pelczar, MJ; Reid, RD. (1972) *Microbiology*. New York, NY: McGraw-Hill Company.

Peterman, RM. (1990) The importance of reporting statistical power: the forest decline and acidic deposition example. *Ecology* 71:2024-2027.

Petitti, DB. (1994) Meta-analysis, decision analysis and cost-effectiveness analysis: methods for quantitative synthesis in medicine. *Monographs in epidemiology and biostatistics*, vol. 24. New York, NY: Oxford University Press.

Phipps, RL. (1979) Simulation of wetlands forest vegetation dynamics. *Ecol Model* 7:257-288.

Pielou, EC. (1984) The interpretation of ecological data. A primer on classification and ordination. New York, NY: Wiley-Interscience, 263 pp.

Preston, EM; Bedford, BL. (1988) Evaluating cumulative effects on wetland functions: a conceptual overview and generic framework. *Environ Manage* 12(5):565-583.

Richards, C; Haro, RJ; Johnson, LB; Host, GE. (1997) Catchment and reach-scale properties as indicators of macroinvertebrate species traits. *Freshwater Biol* 37:219-230.

Risser, PG. (1988) General concepts for measuring cumulative impacts on wetland ecosystems. *Environ Manage* 12(5):585-589.

Rotenberry, JT; Wiens, JA. (1985) Statistical power analysis and community-wide patterns. *Am Naturalist* 125:164-168.



- Ruckelshaus, WD. (1983) Science, risk, and public policy. *Science* 221:1026-1028.
- Sample, BE; Opresko, DM; Suter, GW, II. (1996) Toxicological benchmarks for wildlife: 1996 revision. ES/ER/TM-86/R3. Oak Ridge, TN: Oak Ridge National Laboratory, Health Sciences Research Division.
- Sawyer, TW; Safe, S. (1985) In vitro AHH induction by polychlorinated biphenyl and dibenzofuran mixtures: additive effects. *Chemosphere* 14:79-84.
- Schindler, DW. (1987) Detecting ecosystem responses to anthropogenic stress. *Can J Fish Aquat Sci* 44(Suppl.1):6-25.
- Simberloff, D; Alexander, M. (1994) Issue paper on biological stressors. In: Ecological risk assessment issue papers. Washington, DC: Risk Assessment Forum, U.S. Environmental Protection Agency, pp. 6-1 to 6-59. EPA/630/R-94/009.
- Smith, EP; Cairns, J, Jr. (1993) Extrapolation methods for setting ecological standards for water quality: statistical and ecological concerns. *Ecotoxicology* 2:203-219.
- Smith, EP; Shugart, HH. (1994) Issue paper on uncertainty in ecological risk assessment. In: Ecological risk assessment issue papers. Washington, DC: Risk Assessment Forum, U.S. Environmental Protection Agency, pp. 8-1 to 8-53. EPA/630/R-94/009.
- Society of Environmental Toxicology and Chemistry (SETAC). (1987) Research priorities in environmental risk assessment. Report of a workshop held in Breckenridge, CO, August 16-21, 1987. Washington, DC: SETAC.
- Solomon, KR; Baker, DB; Richards, RP; Dixon, KR; Klaine, SJ; La Point, TW; Kendall, RJ; Weisskopf, CP; Giddings, JM; Geisy, JP; Hall, LW; Williams, WM. (1996) Ecological risk assessment of atrazine in North American surface waters. *Environ Toxicol Chem* 15(1):31-76.
- Starfield, AM; Bleloch, AL. (1991) Building models for conservation and wildlife management. Edina, MN: Burgess International Group, Inc.
- Stephan, CE. (1977) Methods for calculating an  $LC_{50}$ . In: ASTM Special Technical Publication 634. Philadelphia, PA: American Society for Testing and Materials, pp. 65-88.
- Stephan, CE; Rogers, JR. (1985) Advantages of using regression analysis to calculate results of chronic toxicity tests. In: Aquatic toxicology and hazard assessment. Eighth symposium. Bahner, RC; Hanse, DJ, eds. Philadelphia, PA: American Society for Testing and Materials, pp. 328-339.
- Stephan, CE; Mount, DI; Hansen, DJ; Gentile, JH; Chapman, GA; Brungs, WA. (1985) Guidelines for deriving numerical national water quality criteria for the protection of aquatic organisms and their uses. Duluth, MN: Office of Research and Development, U.S. Environmental Protection Agency. PB85-227049.

Stewart-Oaten, A; Murdoch, WW; Parker, KR. (1986) Environmental impact assessment: "pseudoreplication" in time? Ecology 67(4):929-940.

Susser, M. (1986a) Rules of inference in epidemiology. Regul Toxicol Pharmacol 6:116-128.

Susser, M. (1986b) The logic of Sir Carl Popper and the practice of epidemiology. Am J Epidemiol 124:711-718.

Suter, GW, II. (1989) Ecological endpoints. In: Ecological assessments of hazardous waste sites: a field and laboratory reference document. Warren-Hicks, W; Parkhurst BR; Baker, SS, Jr, eds. Washington, DC: U.S. Environmental Protection Agency. EPA 600/3-89/013.

Suter, GW, II. (1990) Endpoints for regional ecological risk assessments. Environ Manage 14:19-23.

Suter, GW, II. (1993a) Ecological risk assessment. Boca Raton, FL: Lewis Publishers.

Suter, GW, II. (1993b) A critique of ecosystem health concepts and indexes. Environ Toxicol Chem 12:1533-1539.

Suter, GW, II. (1996) Abuse of hypothesis testing statistics in ecological risk assessment. Human Ecol Risk Assess 2:331-347.

Suter, GW, II; Vaughan, DS; Gardner, RH. (1983) Risk assessment by analysis of extrapolation error. A demonstration for effects of pollutants on fish. Environ Toxicol Chem 2:369-377.

Suter, GW, II; Gillett, JW; Norton, SB. (1994) Issue paper on characterization of exposure. In: Ecological risk assessment issue papers. Washington, DC: Risk Assessment Forum, U.S. Environmental Protection Agency, pp. 4-1 to 4-64. EPA/630/R-94/009.

Thomas, JW; Forsman, ED; Lint, JB; Meslow, EC; Noon, BR; Verner, J. (1990) A conservation strategy for the spotted owl. Interagency Scientific Committee to Address the Conservation of the Northern Spotted Owl. 1990-791/20026. Washington, DC: U.S. Government Printing Office.

Urban, DJ; Cook, JN. (1986) Ecological risk assessment. Hazard Evaluation Division standard procedure. Washington, DC: Office of Pesticide Programs, U.S. Environmental Protection Agency. EPA-54019-83-001.

U.S. Department of Agriculture. (1993) Pest risk assessment of the importation of *Pinus radiata*, *Nothofagus dombeyi*, and *Laurelia philippiana* logs from Chile. Forest Service Miscellaneous Publication 1517.

U.S. Department of Health, Education, and Welfare. (1964) Smoking and health. Report of the Advisory Committee to the Surgeon General. Public Health Service Publication 1103. Washington, DC: U.S. Department of Health, Education, and Welfare.

U.S. Environmental Protection Agency. (1979) Toxic Substances Control Act. Discussion of premanufacture testing policies and technical issues: request for comment. Federal Register 44:16240-16292.

U.S. Environmental Protection Agency. (1984) Estimating concern levels for concentrations of chemical substances in the environment. Washington, DC: U.S. Environmental Protection Agency, Health and Environmental Review Division, Environmental Effects Branch.

U.S. Environmental Protection Agency. (1986a) Quality criteria for water. Washington, DC: Office of Water, U.S. Environmental Protection Agency. EPA/440/5-86/001.

U.S. Environmental Protection Agency. (1986b) Guidelines for the health risk assessment of chemical mixtures. Federal Register 52:34014-34025.

U.S. Environmental Protection Agency. (1988a) Methods for aquatic toxicity identification evaluations: phase I toxicity characterization procedures. Duluth, MN: Environmental Research Laboratory, U.S. Environmental Protection Agency. EPA/600/3-88/034.

U.S. Environmental Protection Agency. (1988b) User's guide to PDM3, final report. Prepared by Versar, Inc., for Exposure Assessment Branch, Exposure Evaluation Division, U.S. Environmental Protection Agency, Washington, DC, under EPA contract no. 68-02-4254, task no. 117.

U.S. Environmental Protection Agency. (1989a) Rapid bioassessment protocols for use in streams and rivers: benthic macroinvertebrates and fish. Washington, DC: Office of Water, U.S. Environmental Protection Agency. EPA/440/4-89/001.

U.S. Environmental Protection Agency. (1989b) Methods for aquatic toxicity identification evaluations: phase II toxicity identification procedures. Duluth, MN: Environmental Research Laboratory, U.S. Environmental Protection Agency. EPA/600/3-88/035.

U.S. Environmental Protection Agency. (1989c) Methods for aquatic toxicity identification evaluations: phase III toxicity confirmation procedures. Duluth, MN: Environmental Research Laboratory, U.S. Environmental Protection Agency. EPA/600/3-88/035.

U.S. Environmental Protection Agency. (1990) Guidance for data useability in risk assessment. Washington, DC: U.S. Environmental Protection Agency. EPA/540/G-90/008.

U.S. Environmental Protection Agency. (1991) Technical support document for water quality-based toxics control. Washington, DC: Office of Water, U.S. Environmental Protection Agency. EPA/505/2-90/001.

U.S. Environmental Protection Agency. (1992a) Framework for ecological risk assessment. Washington, DC: Risk Assessment Forum, U.S. Environmental Protection Agency. EPA/630/R-92/001.

U.S. Environmental Protection Agency. (1992b) Guidelines for exposure assessment: notice. Federal Register 57:22888-22938.

U.S. Environmental Protection Agency. (1992c) A cross-species scaling factor for carcinogenic risk assessment based on equivalence of  $\text{mg}/\text{kg}^{3/4}/\text{day}$ : draft report. Federal Register 57(109):24152-24173.

U.S. Environmental Protection Agency. (1993a) A review of ecological risk assessment case studies from a risk assessment perspective. Washington, DC: Risk Assessment Forum, U.S. Environmental Protection Agency. EPA/630/R-92/005.

U.S. Environmental Protection Agency. (1993b) Wildlife exposure factors handbook. Washington, DC: Office of Research and Development, U.S. Environmental Protection Agency. EPA/600/R-93/187a and 187b.

U.S. Environmental Protection Agency. (1993c) Communicating risk to senior EPA policy makers: a focus group study. Research Triangle Park, NC: Office of Air Quality Planning and Standards, U.S. Environmental Protection Agency.

U.S. Environmental Protection Agency. (1993d) A guidebook to comparing risks and setting environmental priorities. Washington, DC: Office of Policy, Planning, and Evaluation, U.S. Environmental Protection Agency. EPA/230/B-93/003.

U.S. Environmental Protection Agency. (1994a) Managing ecological risks at EPA: issues and recommendations for progress. Washington, DC: Center for Environmental Research Information, U.S. Environmental Protection Agency. EPA/600/R-94/183.

U.S. Environmental Protection Agency. (1994b) "Ecosystem protection." Memorandum from Robert Perciaspe, David Gardiner, and Johnathan Cannon to Carol Browner, March 1994.

U.S. Environmental Protection Agency. (1994c) Guidance for the data quality objectives process. Washington, DC: Quality Assurance Management Staff. EPA QA/G-4.

U.S. Environmental Protection Agency. (1994d) A review of ecological assessment case studies from a risk assessment perspective, vol. II. Washington, DC: Risk Assessment Forum, U.S. Environmental Protection Agency. EPA/630/R-94/003.

U.S. Environmental Protection Agency. (1994e) Environmental Services Division guidelines. Hydrogeologic modeling. Seattle, WA: Region X, U.S. Environmental Protection Agency.

U.S. Environmental Protection Agency. (1995a) Ecological risk: a primer for risk managers. Washington, DC: U.S. Environmental Protection Agency. EPA/734/R-95/001.

U.S. Environmental Protection Agency. (1995b) "EPA risk characterization program." Memorandum to EPA managers from Administrator Carol Browner, March 1995.

U.S. Environmental Protection Agency. (1995c) The use of the benchmark dose approach in health risk assessment. Washington, DC: Risk Assessment Forum, U.S. Environmental Protection Agency. EPA/630/R-94/007.

U.S. Environmental Protection Agency. (1995d) Great Lakes water quality initiative technical support document for wildlife. Washington, DC: Office of Water, U.S. Environmental Protection Agency. EPA/820/B-95/009.

U.S. Environmental Protection Agency. (1995e) An SAB report: ecosystem management—imperative for a dynamic world. Washington, DC: Science Advisory Board. EPA-SAB-EPEC-95-003.

U.S. Environmental Protection Agency. (1996a) Waquoit Bay watershed. Ecological risk assessment planning and problem formulation (draft). Washington, DC: Risk Assessment Forum, U.S. Environmental Protection Agency. EPA/630/R-96/004a.

U.S. Environmental Protection Agency. (1996b) Summary report for the workshop on Monte Carlo analysis. Washington, DC: Office of Research and Development, U.S. Environmental Protection Agency. EPA/630/R-96/010.

U.S. Environmental Protection Agency. (1997a) Priorities for ecological protection: an initial list and discussion document for EPA. Washington, DC: Office of Research and Development, U.S. Environmental Protection Agency. EPA/600/S-97/002.

U.S. Environmental Protection Agency. (1997b) Policy for use of probabilistic analysis in risk assessment: guiding principles for Monte Carlo analysis. Washington, DC: Office of Research and Development, U.S. Environmental Protection Agency. EPA/630/R-97/001.

van Gestel, CAM; van Brummelen, TC. (1996) Incorporation of the biomarker concept—ecotoxicology calls for a redefinition of terms. *Ecotoxicol* 5:217-225.

Van Leeuwen, CJ; Van der Zandt, PTJ; Aldenberg, T; Verhar, HJM; Hermens, JLM. (1992) Extrapolation and equilibrium partitioning in aquatic effects assessment. *Environ Toxicol Chem* 11:267-282.

Wagner, C; Løkke, H. (1991) Estimation of ecotoxicological protection levels from NOEC toxicity data. *Water Res* 25:1237-1242.

White, PS; Pickett, STA. (1985) Natural disturbance and patch dynamics: an introduction. In: *The ecology of natural disturbance and patch dynamics*. Pickett, STA; White, PS, eds. Orlando, FL: Academic Press, pp. 3-13.

Wiegert, RG; Bartell, SM. (1994) Issue paper on risk integration methods. In: *Ecological risk assessment issue papers*. Washington, DC: Risk Assessment Forum, Environmental Protection Agency, pp. 9-1 to 9-66. EPA/630/R-94/009.

Wiens, JA; Parker, KR. (1995) Analyzing the effects of accidental environmental impacts: approaches and assumptions. *Ecol Appl* 5(4):1069-1083.

Woodman, JN; Cowling, EB. (1987) Airborne chemicals and forest health. *Environ Sci Technol* 21:120-126.

Yoder, CO; Rankin, ET. (1995) Biological response signatures and the area of degradation value: new tools for interpreting multi-metric data. In: *Biological assessment and criteria: tools for water resource planning and decision making*. Davis, WS; Simon, TP, eds. Boca Raton, FL: Lewis Publishers.

Zeeman, M. (1995) EPA's framework for ecological effects assessment. In: *Screening and testing chemicals in commerce*. OTA-BP-ENV-166. Washington, DC: Office of Technology Assessment, pp. 69-78.

## **PART B: RESPONSE TO SCIENCE ADVISORY BOARD AND PUBLIC COMMENTS**

### **1. INTRODUCTION**

This section summarizes the major issues raised in public comments and by EPA's Science Advisory Board (SAB) on the previous draft of these Guidelines (the Proposed Guidelines for Ecological Risk Assessment, hereafter "Proposed Guidelines"). A notice of availability for public comment of the Proposed Guidelines was published September 9, 1996 (61 FR 47552-47631). Forty-four responses were received. The Ecological Processes and Effects Committee of the SAB reviewed the Proposed Guidelines on September 19-20, 1996, and provided comments in January 1997 (EPA-SAB-EPEC-97-002).

The SAB and public comments were diverse, reflecting the different perspectives of the reviewers. Many of the comments were favorable, expressing agreement with the overall approach to ecological risk assessment. Many comments were beyond the scope of the Guidelines, including requests for guidance on risk management issues (such as considering social or economic impacts in decision making). Major issues raised by reviewers are summarized below. In addition to providing general comments (section 2), reviewers were asked to comment on seven specific questions (section 3).

### **2. RESPONSE TO GENERAL COMMENTS**

Probably the most common request was for greater detail in specific areas. In some cases, additional discussion was added (for example, on the use of tiering and iteration and the respective roles of risk assessors, risk managers, and interested parties throughout the process). In other areas, topics for additional discussion were included in a list of potential areas for further development (see response to question 2, below). Still other topics are more appropriately addressed by regional or program offices within the context of a certain regulation or issue, and are deferred to those sources.

A few reviewers felt that since ecological risk assessment is a relatively young science, it is premature to issue guidelines at this time. The Agency feels that it is appropriate to issue guidance at this time, especially since the Guidelines contain major principles but refrain from recommending specific methodologies that might become rapidly outdated. To help ensure the continued relevance of the Guidelines, the Agency intends to develop documents addressing specific topics (see response to question 2 below) and will revise these Guidelines as experience and scientific consensus evolve.

Some reviewers asked whether the Guidelines would be applied to previous or ongoing ecological risk assessments, and whether existing regional or program office guidance would be

superseded in conducting ecological risk assessments. As described in section 1.3 (Scope and Intended Audience), the Guidelines are principles, and are not regulatory in nature. It is anticipated that guidance from program and regional offices will evolve to implement the principles set forth in these Guidelines. Similarly, some reviewers requested that assessments require a comparison of the risks of alternative scenarios (including background or baseline conditions) or an assignment of particular levels of ecological significance to habitats. These decisions would be most appropriately made on a case-by-case basis, or by a program office in response to program-specific needs.

Several Native American groups noted a lack of acknowledgment of tribal governments in the document. This Agency oversight was corrected by including tribal governments at points in the Guidelines where other governmental organizations are mentioned.

Several reviewers noted that the Proposed Guidelines mentioned the need for “expert judgment” in several places and asked how the Agency defined “expert” and what qualifications such an individual should have. At present, there is no standard set of qualifications for an ecological risk assessor, and such a standard would be very difficult to produce, since ecological assessments are frequently done by teams of individuals with expertise in many areas. To avoid this problem, the Guidelines now use the term “professional judgment,” and note that it is important to document the rationale for important decisions.

Some reviewers felt that the Guidelines should address effects only at the population level and above. The Guidelines do not make this restriction for several reasons. First, some assessments, such as those involving endangered species, do involve considerations of individual effects. Second, the decision as to which ecological entity to protect should be the result, on a case-by-case basis, of the planning process involving risk assessors, risk managers, and interested parties, if appropriate. Some suggestions have been proposed (U.S. EPA, 1997a). Finally, there appears to be some confusion among reviewers between conducting an assessment concerned with population-level effects, and using data from studies of effects on individuals (e.g., toxicity test results) to infer population-level effects. These inferences are commonly used (and generally accepted) in chemical screening programs, such as the Office of Pollution Prevention and Toxics Premanufacturing Notification program (U.S. EPA, 1994d).

The use of environmental indices received a number of comments. Some reviewers wanted the Guidelines to do more to encourage the use of indices, while others felt that the disadvantages of indices should receive greater emphasis. The Guidelines discuss both the advantages and limitations of using indices to guide risk assessors in their proper use.



Other reviewers requested that the Guidelines take a more definitive position on the use of “realistic exposure assumptions,” such as those proposed in the Agency’s exposure guidelines (U.S. EPA, 1992b). Although the exposure guidelines offer many useful suggestions that are applicable to human health risk assessment, it was not possible to generalize the concepts to ecological risk assessment, given the various permutations of the exposure concept for different types of stressors or levels of biological organization. The Guidelines emphasize the importance of documenting major assumptions (including exposure assumptions) used in an assessment.

Several reviewers requested more guidance and examples using nonchemical stressors, i.e., physical or biological stressors. This topic has been included in the list of potential subjects for future detailed treatment (see response to question 2, below).

### **3. RESPONSE TO COMMENTS ON SPECIFIC QUESTIONS**

Both the Proposed Guidelines and the charge to the SAB for its review contained a set of seven questions asked by the Agency. These questions, along with the Agency’s response to comments received, are listed below.

*(1) Consistent with a recent National Research Council report (NRC, 1996), these Proposed Guidelines emphasize the importance of interactions between risk assessors and risk managers as well as the critical role of problem formulation in ensuring that the results of the risk assessment can be used for decision making. Overall, how compatible are these Proposed Guidelines with the National Research Council concept of the risk assessment process and the interactions among risk assessors, risk managers, and other interested parties?*

Most reviewers felt there was general compatibility between the Proposed Guidelines and the NRC report, although some emphasized the need for continued interactions among risk assessors, risk managers, and interested parties (or stakeholders) throughout the ecological risk assessment process and asked that the Guidelines provide additional details concerning such interactions. To give greater emphasis to these interactions, the ecological risk assessment diagram was modified to include “interested parties” in the planning box at the beginning of the process and “communicating with interested parties” in the risk management box following the risk assessment. Some additional discussion concerning interactions among risk assessors, risk managers, and interested parties was added, particularly to section 2 (planning). However, although risk assessor/risk manager interrelationships are discussed, too great an emphasis in this area is inconsistent with the scope of the Guidelines, which focus on the interface between risk assessors and risk managers, not on providing risk management guidance.

*(2) The Proposed Guidelines are intended to provide a starting point for Agency programs and regional offices that wish to prepare ecological risk assessment guidance suited to their needs. In addition, the Agency intends to sponsor development of more detailed guidance on certain ecological risk assessment topics. Examples might include identification and selection of assessment endpoints, selection of surrogate or indicator species, or the development and application of uncertainty factors. Considering the state of the science of ecological risk assessment and Agency needs and priorities, what topics most require additional guidance?*

Reviewers recommended numerous topics for further development. Examples include:

- landscape ecology
- data sources and quality
- physical and biological stressors
- multiple stressors
- defining reference areas for field studies
- ecotoxicity thresholds
- the role of biological and other types of indicators
- bioavailability, bioaccumulation, and bioconcentration
- uncertainty factors
- stressor-response relationships (e.g., threshold vs. continuous)
- risk characterization techniques
- risk communication to the public
- public participation
- comparative ecological risk
- screening and tiering assessments
- identifying and selecting assessment endpoints.

These suggestions will be included in a listing of possible topics proposed to the Agency's Risk Assessment Forum for future development.

*(3) Some reviewers have suggested that the Proposed Guidelines should provide more discussion of topics related to the use of field observational data in ecological risk assessments, such as selection of reference sites, interpretation of positive and negative field data, establishing causal linkages, identifying measures of ecological condition, the role and uses of monitoring, and resolving conflicting lines of evidence between field and laboratory data. Given the general*

*scope of these Proposed Guidelines, what, if any, additional material should be added on these topics and, if so, what principles should be highlighted?*

In response to a number of comments, the discussion of field data in the Guidelines was expanded, especially in section 4.1. Nevertheless, many suggested topics requested a level of detail that was inconsistent with the scope of the Guidelines. Some areas may be covered through the development of future Risk Assessment Forum documents.

*(4) The scope of the Proposed Guidelines is intentionally broad. However, while the intent is to cover the full range of stressors, ecosystem types, levels of biological organization, and spatial/temporal scales, the contents of the Proposed Guidelines are limited by the present state of the science and the relative lack of experience in applying risk assessment principles to some areas. In particular, given the Agency's present interest in evaluating risks at larger spatial scales, how could the principles of landscape ecology be more fully incorporated into the Proposed Guidelines?*

Landscape ecology is critical to many aspects of ecological risk assessment, especially assessments conducted at larger spatial scales. However, given the general nature of these Guidelines and the responses received to this question, the Guidelines could not be expanded substantially at this time. This topic has been added to the list of potential subjects for future development.

*(5) Assessing risks when multiple stressors are present is a challenging task. The problem may be how to aggregate risks attributable to individual stressors or identify the principal stressors responsible for an observed effect. Although some approaches for evaluating risks associated with chemical mixtures are available, our ability to conduct risk assessments involving multiple chemical, physical, and biological stressors, especially at larger spatial scales, is limited. Consequently, the Proposed Guidelines primarily discuss predicting the effects of chemical mixtures and general approaches for evaluating causality of an observed effect. What additional principles can be added?*

Few additional principles were provided that could be included in the Guidelines. To further progress in evaluating multiple stressors, EPA cosponsored a workshop on this issue, held by the Society of Environmental Toxicology and Chemistry in September 1997. In addition, evaluating multiple stressors is one of the proposed topics for further development.

*(6) Ecological risk assessments are frequently conducted in tiers that proceed from simple evaluations of exposure and effects to more complex assessments. While the Proposed Guidelines acknowledge the importance of tiered assessments, the wide range of applications of tiered*

*assessments make further generalizations difficult. Given the broad scope of the Proposed Guidelines, what additional principles for conducting tiered assessments can be discussed?*

Many reviewers emphasized the importance of tiered assessments, and in response the discussion of tiered assessments was significantly expanded in the planning phase of ecological risk assessment. Including more detailed information (such as specific decision criteria to proceed from one tier to the next) would require a particular context for an assessment. Such specific guidance is left to the EPA program offices and regions.

*(7) Assessment endpoints are “explicit expression of the environmental value that is to be protected.” As used in the Proposed Guidelines, assessment endpoints include both an ecological entity and a specific attribute of the entity (e.g., eagle reproduction or extent of wetlands). Some reviewers have recommended that assessment endpoints also include a decision criterion that is defined early in the risk assessment process (e.g., no more than a 20% reduction in reproduction, no more than a 10% loss of wetlands). While not precluding this possibility, the Proposed Guidelines suggest that such decisions are more appropriately made during discussions between risk assessors and managers in risk characterization at the end of the process. What are the relative merits of each approach?*

Reviewer reaction was quite evenly divided between those who felt strongly that decision criteria should be defined in problem formulation and those who felt just as strongly that such decisions should be delayed until risk characterization. Although the Guidelines contain more discussion of this topic, they still take the position that assessment endpoints need not contain specific decision criteria.