

**UNITED STATES DEPARTMENT OF AGRICULTURE
FOREST SERVICE**

**FSH 6709.11
HEALTH AND SAFETY CODE HANDBOOK**

**FOREST SERVICE HANDBOOK
WASHINGTON**

**FSH 6709.11 – HEALTH AND
SAFETY CODE HANDBOOK**

Amendment No. 6709.11-99-1

Effective December 1, 1999

POSTING NOTICE. This amendment is the first in a new numbering series corresponding to the year in which the Handbook direction is amended. Since this amendment replaces all text, including Interim Directives (IDs), do not check for the last transmittal received for this Handbook title. Replace the entire Handbook text. Place this transmittal sheet in front of the Handbook title page.

| <i>Documents</i> | <i>Superseded</i> | <i>New</i> |
|--|--------------------------|------------|
| | <i>(Number of Pages)</i> | |
| Replace the entire Handbook, Chapters 1 through 9, with the following: | 349 | — |
| <i>Document Name</i> | | |
| !!6709.11,Transmittal | — | 2 |
| !6709.11,Contents | — | 1 |
| 6709.11,0 | — | 7 |
| 6709.11,10 | — | 51 |
| 6709.11,20 | — | 130 |
| 6709.11,30 | — | 71 |
| 6709.11,40 | — | 73 |
| 6709.11,50 | — | 56 |
| 6709.11,60 | — | 55 |
| 6709.11,70 | — | 28 |
| 6709.11,Glossary | — | 7 |
| 6709.11,Index | — | 22 |

Digest

This amendment revises the text of the entire FSH 6709.11, Health and Safety Code Handbook, and issues the official paper copy in a pocket-sized format.

Distribution of Paper and Electronic Copies

The official version of this Handbook is issued in paper in pocket-sized format. Additional paper copies may be obtained from:

Landover Warehouse, OO
Central Supply
3222 Hubbard Road
Landover, MD 20785

Orders should be placed using Form AD-14, and the form number block should be completed with FSH 6709.11.

An electronic version of this Handbook is available to the public from the Forest Service Directives Home Page on the Internet (World Wide Web) at:

<http://www.fs.fed.us/im/directives/>

Forest Service employees may obtain electronic copies also from the Directives Home Page on the Intranet (FSWeb) at:

<http://fsweb.wo.fs.fed.us/directives/index.html>

Comments on FSH 6709.11

Following this transmittal is a comment sheet intended for internal voluntary use by Forest Service employees who wish to provide feedback on text corrections, additions, or recommendations on format. The comment sheet may be mailed to:

Attn: Program Leader, Safety
Technology and Development Center, Missoula
Building 1, Fort Missoula
Missoula, MT 59804-7294

Comments may be sent by e-mail to:

mtdc/wo_mtdc@fs.fed.us

MIKE DOMBECK
Chief



COMMENT SHEET

FSH 6709.11-Health and Safety Code Handbook

(**Note:** This comment sheet is intended for internal voluntary use by Forest Service employees.)

Your name: _____

Unit: _____

Work phone: _____

E-mail: _____

Date: _____

Format: (If you believe the format of this document could be improved, please list your specific recommendations below.)

Corrections: (If you find inaccuracies or incomplete information we would appreciate it if you would identify those for us.)

Additions: (If you would like to suggest future additions, please note them.)

Please mail to:

Attn: Program Leader, Safety
Technology and Development Center, Missoula
Building 1, Fort Missoula
Missoula, MT 59804-7294
e-mail address: mtdc/wo_mtdc@fs.fed.us

FSH 6709.11 – HEALTH AND SAFETY CODE HANDBOOK

Contents

ZERO CODE

Chapter

- 10 TRAVEL**
- 20 WORK PROJECTS AND ACTIVITIES**
- 30 FACILITIES**
- 40 EQUIPMENT AND MACHINERY**
- 50 EMPLOYEE SAFETY, SECURITY, AND HEALTH**
- 60 HAZARDOUS MATERIALS**
- 70 JOB HAZARD ANALYSIS (FORM FS-6700-7) AND
PERSONAL PROTECTIVE EQUIPMENT**

GLOSSARY

INDEX

ZERO CODE

Contents

01 AUTHORITY

02 OBJECTIVE

04 RESPONSIBILITY

04.1 Line Officers

04.2 First-Line Supervisors

04.3 Work Leaders

04.4 All Employees

05 DEFINITIONS

08 ACCIDENT INVESTIGATION AND REPORTING

08.1 Fatalities, Serious Injuries, or Hospitalization of Three or More Employees, Enrollees, Cooperators, Contract Employees, or Private Citizens

ZERO CODE

The Health and Safety Code Handbook is the primary source of standards for safe and healthful workplace conditions, project inspections, and operational procedures and practices in the Forest Service, in addition to the standards and regulations of the Occupational Safety and Health Administration (OSHA) (sec. 01).

The primary audience for the Handbook is first-line supervisors and work leaders. However, the Handbook's direction applies to all Forest Service employees.

Direction in the Handbook generally is written in the imperative mood, which conveys mandatory compliance: "Wear a hardhat on the fireline." The use of the helping verbs "must" and "shall" also conveys mandatory compliance. The use of "should" conveys required compliance, except where justifiable circumstances make compliance unnecessary because there is no threat to worker safety or health. The use of "may" and "can" conveys optional compliance.

Sentences in bold italic type indicate that a fatality resulted because of a failure to comply with a standard operating procedure or practice.

01 – AUTHORITY.

1. The basic authority for safety and health standards is the Occupational Safety and Health Act of 1970 (sec. 19 and 24), as amended (Title 29 United States Code (U.S.C.), 668, 673), and the implementing regulations issued by the Department of Labor, Occupational Safety and Health Administration (OSHA) in Title 29, Code of Federal Regulations (29 CFR), Part 1910, Occupational Safety and Health Standards; Part 1926, Construction Standards; and Part 1960, Basic Program Elements for Federal Employee Occupational Safety and Health Programs and Related Matters.

2. Executive Order 12196, February 26, 1980, explains the required occupational safety and health programs for Federal employees.

3. Department of Transportation, Federal Highway Administration safety regulations regarding Federal Motor Carriers are found in 49 CFR.

4. National Fire Codes of the National Fire Protection Association (NFPA), 1 Batterymarch Park, P.O. Box 9101, Quincy, MA 02269-9101, telephone number (617) 770-3000, provide required national compliance standards.

5. The Fireline Handbook, issued by the National Wildfire Coordinating Group (NWCG) as NWCG Handbook 3 and incorporated in the Forest Service directive system as FSH 5109.32a, serves as a field reference for wildland fire agencies that use the Incident Command System (ICS). Copies are available from the National Interagency Fire Center, Great Basin Cache Supply Office, 3833 South Development Avenue, Boise, ID 83705, telephone number (208) 387-5542.

6. The Master Agreement Between the Forest Service and National Federation of Federal Employees—Article 27, Safety and Health, defines the elements required to create and maintain a safe and healthful workplace.

02 – OBJECTIVE. To ensure safe and healthful workplaces by instituting procedures and practices that help prevent accidents, injuries, and illnesses to Forest Service employees, cooperators, contractors, volunteers, and the visiting public.

04 – RESPONSIBILITY.

04.1 – Line Officers. It is the responsibility of line officers to provide for the health, safety, and training of employees. Line officers provide professional leadership and guidance to employees. All job hazard analyses (JHAs) (sec. 05) shall be approved by the appropriate line officer and reviewed at least annually.

04.2 – First-Line Supervisors. It is the responsibility of first-line supervisors to identify job-related hazards and to eliminate potential causes of accidents, injuries, and illnesses at worksites to the best of their ability by:

1. Considering an employee's identified personal, physical, and mental condition when assigning duties.
2. Knowing the type of equipment being used and its limitations.
3. Preparing a JHA with involved employees for each work project or activity (FSM 6713, Form FS-6700-7 or equivalent). Employees may request review of a JHA with their supervisor at any time.
4. Eliminating unacceptable risks by inspecting the work project or activity and by identifying, evaluating, correcting, and following up on recognized hazards.
5. Conducting "tailgate" safety and health sessions to emphasize precautions identified in JHAs (sec. 05).
6. Making inquiries into all incidents, accidents, and injuries that they observe or that are reported to them; following through with the appropriate investigation procedures and corrective actions (FSM 6731); and ensuring that all threats, assaults, intimidation, or other like acts are reported immediately to the Law Enforcement and Investigations Staff.

04.3 – Work Leaders. It is the responsibility of work leaders to:

1. Assist in the development of the JHA.
2. Distribute and balance workloads among their crew members.
3. Provide new crew members with on-the-job training.
4. Ensure crew members engage in safe work practices.

04.4 – All Employees. It is the responsibility of all employees to:

1. Inform their supervisor of any personal, physical, or mental condition that could compromise the safety or health of the crew or themselves.
2. Comply with the JHA and the established safety and health procedures and practices.

3. Take the initiative for their own safety and health, and that of their co-workers, by pointing out unsafe conditions and unsafe work practices and, immediately reporting any threats by persons against themselves or Forest Service facilities to their supervisor and the Law Enforcement and Investigations Staff.

05 – DEFINITIONS.

First-line Supervisor. Any employee responsible for the planning or implementing of project work activities of other employees.

Job Hazard Analysis (JHA). A systematic process to identify safety and health hazards in a work project or activity and to develop abatement actions for those hazards. A JHA (Form FS-6700-7 or equivalent) results in a document that outlines special procedural and personal protective equipment/clothing (PPE) requirements, qualifications, training, safety practices, and emergency evacuation procedures. A JHA is designed for some flexibility. Line officers, supervisors, and employees may utilize the JHA to justify specific PPE needs or variances for a particular work project or activity.

Line Officer. Any employee, from the Chief and Associate Chief to District Ranger, who carries out line authority.

Personal Protective Equipment. Personal protective equipment for eyes, head, and extremities; protective clothing; respiratory devices; and protective shields and barriers.

Tailgate Safety and Health Session. A documented discussion among the first-line supervisor, work leaders, and crew members concerning any aspect of a work project or activity. These sessions take place before a new project or activity is begun, when changes are made (such as location, new crew members, or job responsibilities), or whenever involved employees believe such a session is needed. Topics often focus on the recognized hazards associated with the job and the methods to mitigate such hazards.

Work Leaders. Individuals involved in day-to-day supervision of field crews. Work leaders report the progress and problems of their crews to the first-line supervisor.

08 – ACCIDENT INVESTIGATION AND REPORTING. Every occupational illness and accident—including accidents involving property damage only—regardless of how minor, warrants investigation. The extent of such investigation shall be reflective of the seriousness of the accident and of the Forest Service involvement (FSH 6709.12, ch. 30).

08.1 – Fatalities, Serious Injuries, or Hospitalization of Three or More Employees, Enrollees, Cooperators, Contract Employees, or Private Citizens. Initiate an investigation for any accident involving fatality, serious injury (where death is likely), or hospitalization of three or more employees, cooperators, contract employees, or private citizens, with direct Forest Service involvement. Notify the appropriate Occupational Safety and Health Administration (OSHA) field office and USDA Safety and Health Management Division (SHMD) within 8 hours. The SHMD shall notify OSHA Headquarters within the required 8 hours.

CHAPTER 10 – TRAVEL

Contents

11 GENERAL TRAVEL

- 11.01 Authority
- 11.06 Reference
- 11.1 Requirements for All Travel
- 11.11 Qualifications
- 11.12 Job Hazard Analyses
- 11.2 Back-country Travel
- 11.21 Personal Protective Equipment
- 11.22 Safety Practices
- 11.3 Winter Travel
- 11.31 Safety Practices for Travel in Avalanche Areas
- 11.32 Safety Practices for Travel on Ice

12 MOTORIZED VEHICLES

- 12.01 Authority
- 12.03 Policy
- 12.04 Responsibility
- 12.04a First-line Supervisors
- 12.04b Drivers/Operators
- 12.06 References
- 12.1 Qualifications
- 12.11 Training
- 12.12 Suspensions
- 12.2 Required Vehicle Equipment
- 12.3 Safety Practices
- 12.31 Work/Rest Guidelines
- 12.32 Emergency Driving
- 12.33 Before Driving
- 12.34 While Driving
- 12.35 Driving on Limited Access Highways
- 12.36 Special Hazards while Driving on Forest Service Roads
- 12.4 Defensive Driving Techniques
- 12.5 Transporting Flammable/Combustible Liquids
- 12.6 Battery Jump-Starting Safety
- 12.7 Vehicle Fires
- 12.71 Procedures
- 12.72 Safety Practices

13 SPECIALIZED EQUIPMENT

- 13.01 Authority
- 13.06 Reference
- 13.1 Four-Wheel-Drive Vehicles
- 13.11 Operation
- 13.12 All-Wheel-Drive Vehicles
- 13.2 All-Terrain Vehicles
- 13.21 Qualifications
- 13.22 Personal Protective Equipment
- 13.23 Loading and Hauling
- 13.24 Operation
- 13.3 Motorcycles
- 13.31 Qualifications
- 13.32 Personal Protective Equipment
- 13.33 Operation
- 13.4 Snowmobiles
- 13.41 Qualifications
- 13.42 Personal Protective Equipment
- 13.43 Operation
- 13.5 Snow Cats
- 13.51 Qualifications
- 13.52 Personal Protective Equipment
- 13.53 Operation
- 13.6 Trailers
- 13.61 Qualifications
- 13.62 Pre-trip Safety Inspection
- 13.63 Operation
- 13.64 Equipment
- 13.7 Transporting Passengers
- 13.71 Safety Practices

14 AVIATION SAFETY**15 WATERCRAFT SAFETY**

- 15.01 Authority
- 15.04 Responsibility
- 15.04a Boat Operator
- 15.04b Supervisor
- 15.1 Watercraft Operation
- 15.11 Qualifications
- 15.12 Personal Protective Equipment

- 15.13 Safety Practices
- 15.13a General Safety Practices
- 15.13b Fire Suppression
- 15.14 Watercraft Less Than 26 Feet (8 m)
- 15.15 Watercraft 26 Feet (8 m) and Over
- 15.16 Paddlecraft

16 LIVESTOCK HANDLING

- 16.04 Responsibility
- 16.06 Reference
- 16.1 General Livestock Transportation
- 16.11 Transporting Livestock in Trailers
- 16.11a Loading
- 16.11b Securing Livestock
- 16.11c Unloading
- 16.12 Transporting Livestock in Trucks
- 16.12a Loading
- 16.2 Safe Driving Practices
- 16.3 Personal Protective Equipment
- 16.4 Riding Livestock
- 16.41 Riding Practices
- 16.42 Securing Livestock
- 16.43 Packing Livestock
- 16.44 Leading Livestock
- 16.45 Feeding Livestock
- 16.5 Other Livestock Handling Concerns
- 16.51 Draft Stock
- 16.52 Private Livestock
- 16.53 Shoeing

17 BICYCLE SAFETY

- 17.01 Authority
- 17.04 Responsibility
- 17.06 Reference
- 17.1 Qualifications
- 17.2 Defensive Driving
- 17.3 Personal Protective Equipment
- 17.4 Procedures
- 17.5 Safety Practices

18 WALKING AND HIKING SAFETY

18.06 References

18.1 Foot Care

18.2 Footwear

18.21 General Requirement

18.22 Specific Requirement

18.3 Wildland Walking

CHAPTER 10 – TRAVEL

11 – GENERAL TRAVEL. This section contains direction related to safety and health requirements for travel to and from work projects and other activities.

11.01 – Authority. Regulations regarding general travel are in Title 29, Code of Federal Regulations (29 CFR), Parts 1910 and 1926.

11.06 – Reference. McClung, David, and P. Schaerer. 1993. The Avalanche Handbook. The Mountaineers Books. Seattle, WA.

11.1 – Requirements for All Travel.

11.11 – Qualifications. Qualifications for field work crews and office personnel include the following:

1. Each field work crew and office group shall be trained in first aid/cardiopulmonary resuscitation (CPR) or have at least one person certified to render first aid/CPR.

2. Prior to using a global positioning system (GPS), employees shall be trained in the use of GPS.

3. Employees and their supervisor shall utilize tailgate safety sessions to address safety concerns for local incidental travel, such as running short errands or postal services.

11.12 – Job Hazard Analyses. Job hazard analysis (JHA) for all work projects and activities involving travel shall include:

1. An itinerary listing planned route(s) of travel, date of travel, destination, and estimated time of departure/arrival, as needed.

2. Check-out/check-in system (such as a sign out board) for internal use only.

3. Name of employees.

4. Emergency phone numbers/communication system and contact points.

5. Other information relevant to the project or activity. (Some items required for the JHA are available in other documents, such

as a district or project safety and health plan, and may be included by reference.)

If employees fail to call in or return on schedule, the supervisor shall take those actions required by the JHA.

11.2 – Back-country Travel. *Never travel or work alone in isolated areas without preparing and discussing a detailed JHA that includes emergency evacuation procedures and a communication plan (sec. 21.14).* For all back-country travel, remember that terrain and weather may make aid and rescue an impossibility for several days. A minor accident can have serious consequences due to time and exposure, so plan ahead.

11.21 – Personal Protective Equipment.

1. The following personal protective equipment (PPE) is required for back-country travel:
 - a. First aid kit (refer to the Glossary).
 - b. Map and compass.
 - c. Matches or fire starter in weatherproof container.
 - d. Water or water purifier.
 - e. Food for 1 to 3 days.
 - f. Flashlight with extra batteries and bulb.
 - g. Two-way radio, cellular phone, or similar personal communications device.
 - h. Eye protection and sunscreen.
 - i. Lightweight shelter and appropriate clothing for climatic conditions.
 - j. Additional PPE identified by the JHA.
2. The following PPE is recommended for back-country travel:
 - a. GPS receiver (sec. 21.12 and 72).
 - b. Multi-purpose belt tool.
 - c. Whistle and signal mirror.

11.22 – Safety Practices.

1. Be aware of local conditions.
 - a. Weather, road traffic, and trail conditions.
 - b. Potential hazards, unusual activities, and animals that may be encountered (sec. 51, 53, and 54).

2. Choose campsites carefully. They should be free of:
 - a. Snags and other overhead hazards.
 - b. Leaning green trees in unstable or saturated soils.
 - c. Danger from rolling rocks and slides.
 - d. Danger of flash flooding.
 - e. Known animal problems.
3. If disoriented due to dehydration or other causes:
 - a. Keep calm. DON'T panic.
 - b. Contact the unit dispatcher for assistance.
 - c. Be aware that fatigue causes hallucinations.
 - d. Do not walk aimlessly. Try to orient yourself. Trust your GPS receiver, map, and compass.
4. If lost:
 - a. Contact the unit dispatcher for assistance.
 - b. Select a sheltered area, prepare a camp, and stay there. Conserve your strength.
 - c. Gather fuel for a warming fire BEFORE DARK.
 - d. Remember that warmth and liquids are more important than food.
 - e. Put out visual markers if available.

11.3 – Winter Travel. Employees traveling in the mountains in winter shall be skilled in winter mountaineering techniques, including emergency survival and avalanche hazard, and hazard tree recognition. Employees shall be skilled at their mode of travel, whether skis, snow shoes, or mechanized over-snow equipment and vehicles.

Employees shall carry a survival kit that includes items identified in the JHA and PPE appropriate for the conditions and hazards anticipated. Ski helmets or equivalent head protection should be considered when traversing areas known for avalanche and/or snag hazards.

11.31 – Safety Practices for Travel in Avalanche Areas. Employees shall be trained at a Forest Service sponsored/recognized national avalanche school or at the Forest Service National Avalanche Center.

Employees shall learn to identify avalanche-prone localities, recognize snow pack instability, travel safely in avalanche

terrain, carry out an effective, safe rescue, and know what rescue equipment/clothing is required. Years of experience are required to identify all potential avalanche hazards. If unsure of the safety of the terrain, turn back or go around.

11.32 – Safety Practices for Travel on Ice. Travel on frozen lakes and streams is permitted only after a JHA is prepared and all travelers sign it verifying that they have read and understand its direction.

1. Precautions.

- a. Planning shall include information on the depth of water before freezing and the age/thickness of ice. Do not travel over newly frozen lakes, on shore ice, or during periods of unstable ice conditions. Flowing water from springs and streams and extremely slick ice indicate hazard areas.
- b. Operating motorized vehicles on frozen lakes and streams shall be authorized only by local line officers and must be justified in writing.

2. Ice Rescue. *Personnel shall not put their lives in jeopardy where an ice rescue cannot be accomplished in a safe manner, even if the victim(s) are unable to help themselves. Always follow safe established rescue techniques.*

12 – MOTORIZED VEHICLES.

12.01 – Authority. The authority for the use of motorized vehicles is in Title 29, Code of Federal Regulations (29 CFR), sections 1910.106 and 1926.601; 36 CFR 261.16a; and 49 CFR Parts 171-180 and 383-397.

The authority for transportation of flammable and combustible liquids is in National Fire Protection Association (NFPA) 30, Flammable and Combustible Liquids Code (1996), National Fire Protection Association, Quincy, MA, and 49 CFR Parts 171 through 180.

FSM 5130 contains direction on structure and vehicle fires.

12.03 – Policy.

1. Employees shall not operate a motor vehicle while under the influence of alcohol and drugs nor while sick or suffering from excessive fatigue or emotional stress.

2. Drivers must observe all State and local traffic regulations.

12.04 – Responsibility.

12.04a – First-line Supervisors. First-line supervisors have the responsibility to observe drivers for vision, hearing, dexterity, or other physical limitations that might impair their ability to drive safely.

Supervisors shall review driving abilities of new employees within 30 days of employment. The authorization for an employee to drive on official business must be reviewed and documented by the supervisor when the employee starts work; 30 days later; and on a subsequent 4-year interval.

12.04b – Drivers/Operators. Drivers/operators have the responsibility to:

1. Inform their supervisors of any physical, mental, or emotional condition that might impair their ability to safely drive a motorized vehicle or operate machinery.
2. ***Know and observe all State and local traffic regulations.***
3. Drive safely while operating the vehicle within its mechanical limits.
4. Consider the needs of passengers with disabilities when traveling, such as accessibility and actions necessary in the event of vehicle fires or accidents.

12.06 – References.

1. U.S. Department of Agriculture, Forest Service. 1992. Driver-Operator Guide. EM-7130-2. Engineering Staff, Washington Office.

2. U.S. Department of Agriculture, Forest Service. Master Agreement Between Forest Service and National Federation of Federal Employees—Article 27, Safety and Health. Washington, DC.

12.1 – Qualifications. All Forest Service employees who operate Government vehicles (or private vehicles used on official duty) shall hold a valid State driver's license with the proper endorsements for the size and class being driven and a Forest Service-issued identification card indicating the type of vehicle or equipment the operator is authorized and qualified to operate (FSM 7134.1).

If a commercial driver's license is required for an employee's work duties, the employee shall be included in the Department of Transportation Federal Highway Administration Drug and Alcohol Testing Program. Operators shall be familiar with the Driver-Operator Guide (sec. 12.06).

12.11 – Training. Defensive driving training is required for all Forest Service employees who drive Government or private vehicles on official duty. Drivers must attend a Forest Service or National Safety Council or equivalent defensive driving course at least every 3 years.

12.12 – Suspensions. Supervisors may recommend and line officers may suspend an employee's authorization to drive on official business for:

1. Repeated disregard of safe driving practices.
2. Personal deficiencies that make driving unsafe.
3. Abuse of a vehicle and/or equipment.
4. Unauthorized use of a Government vehicle while on official duty.
5. Repeated violations of State driving regulations (such as speeding, reckless driving, and substance or alcohol abuse).
6. Involvement in a driving accident that displays negligence. After reviewing the initial accident report, the line officer may suspend the employee's driving authorization pending final disposition of the case.

Supervisors shall give the employee written notification of suspension (with appeal rights) and file a copy in the employee's official personnel folder.

12.2 – Required Vehicle Equipment. Factory installed safety devices and equipment shall not be nullified, altered, or removed. Ensure that Government vehicles are equipped with:

1. Safety belts for all passengers. Refer to 49 CFR 392.9 for exception of bus passengers.
2. Warning markers or reflectors and flashlight.
3. First aid kit. The standard first aid kit in all Government vehicles must contain two packets of the standard protective equipment (rubber gloves, face masks, eye protection, and CPR clear-mouth barrier) (refer to the Glossary).
4. Chock blocks.
5. Tire chains.
6. Window scraper.
7. Fire extinguishers (A:B:C or B:C) (sec. 35.11a). If the vehicle is carrying explosives, flammables, or 16 or more passengers, these rules apply:
 - a. Explosives: 2 extinguishers rated 2A-10B:C or more.
 - b. Flammables: 1 extinguisher rated 10B:C or more.
 - c. 16 or more passengers: 1 extinguisher rated 5B:C or more or 2 extinguishers rated 4B: or more.

12.3 – Safety Practices. Vehicle operators shall comply with all traffic laws, regulations, or ordinances, even in emergency driving situations (sec. 12.32).

12.31 – Work/Rest Guidelines. Vehicle operators must comply with these work/rest guidelines except for limited exceptions (during the first 24 hours) of emergency driving situations (sec. 12.32).

1. Employees and contractors operating Government vehicles shall drive:
 - a. Only if they have had at least 8 consecutive hours off duty before beginning a shift.
 - b. ***No more than 2 hours without a rest stop. Operators of vehicles carrying 16 or more passengers (including the driver) shall stop for 10 minutes every hour.***

- c. No more than 10 hours per shift. A shift must not exceed 16 hours, from beginning of shift to the end of shift including rest and meal stops.

2. Contractors operating Government commercial motor vehicles must adhere to the hours of service for drivers as required by the U.S. Department of Transportation (DOT) (sec. 12.01). An exception may be made only when an emergency is officially declared.

12.32 – Emergency Driving. Determine the type of emergency before driving. Emergency situations shall be justified in writing and approved in writing by the appropriate line officer.

1. When transporting passengers during an officially declared emergency, follow these precautions:

- a. **National or State emergency.** Declared by the President or Governor. Base allowable driving hours on the driving assignment, from starting point to destination. Upon the driver's arrival at the destination, do not permit further driving if work/rest guidelines in section 12.31 have been exceeded.
- b. **Regional emergency.** Local decision made by the line officer to provide direct assistance to supplement State and local efforts and capabilities to save lives.

2. Where city or county ordinances require emergency vehicles using a siren and red lights to continue their route of travel regardless of traffic signals, drivers shall comply with such ordinances; however, such travel through an intersection shall never exceed 10 mph (16 km/hour).

12.33 – Before Driving.

1. Determine conditions in the area to be traveled and choose the appropriate vehicle and route (sec. 51.11). Verify directions to your destination, obtain a map for reference if possible.

2. Check the owner's manual for instructions and location of tire changing equipment, headlights, wipers, heat, and air conditioning. If the vehicle has a computerized braking system designed to prevent wheel lockup, remember these points about automatic braking systems (ABS):

- a. ABS does not mean drivers can drive faster on snowy or icy roads.
 - b. In a two-wheel-drive vehicle or four-wheel-drive vehicle with ABS, maintain firm steady pressure on the brakes. Pumping or releasing the brakes negates ABS.
 - c. ABS does not function in some four-wheel-drive vehicles when four-wheel-drive is engaged.
 - d. Some vehicles, mostly pickups, have ABS on rear wheels only. Operate a vehicle so equipped the same as one without ABS. If the front wheels lockup, reduce brake pedal pressure to regain control.
3. Observe the “Circle of Safety” rule. Walk around the vehicle.
- a. Check the windshield, wipers, and wiper fluid level.
 - b. Scrape snow/ice from all windows.
 - c. Keep windows, mirrors, and lights clean to better see and be seen.
 - d. Check headlights, turn signals, and front tires (including wheels and lug nuts).
 - e. Adjust mirrors.
 - f. Check taillights, reflectors, and rear tires (including wheels and lug nuts).
4. Check the brakes by pressing firmly on the foot pedal, check the steering for any looseness, and check the horn. Know the function and location of all controls.
5. Before moving a vehicle, turn on the defroster fan to dislodge any dust and debris.
6. If the vehicle uses an alternative fuel, such as methanol, ethanol, diesel, or propane, familiarize yourself with the refueling procedures. Know in advance where the next funding station equipped with such fuel is located.
7. Do not fill a fuel tank beyond the normal shut off point and always allow for vapor expansion.
8. Secure all objects inside the cab and cargo area(s).
9. Operators of vehicles 10,000 gross vehicle weight rating (GVWR) and larger (single or in combination) must check wheels and lug nuts daily.

10. When work is performed on the wheel/tire/hub assembly (such as wheel bearings being packed), the operator should check for tightness after driving 50 to 100 miles (80 to 161 km).

11. Monitor vehicle performance when driving. Inspect a vehicle after use. Correct or report problems before a vehicle is used again.

12.34 – While Driving.

1. ***Always wear your safety belt(s).*** The vehicle operator shall ensure passengers also wear safety belts. If two types of restraint are available, use both.

2. Honor the right-of-way of pedestrians.

3. ***To prevent accidents, make concessions to other drivers who are thoughtless, unskilled, or ignorant of the hazards they create. Drive defensively and yield the right-of-way even when by all rules of the road it is yours.***

4. Be aware of traffic situations developing far ahead of the vehicle. Use the rearview and sideview mirrors often and keep your eyes moving to enlarge the “big picture.”

5. ***Drive to avoid accident situations created by the mistakes of others or by weather and road conditions.***

6. Do not compromise your safety, the safety of your passengers, or public safety when driving. The following are prohibited:

- a. Engaging in distracting conversation or activities.
- b. ***Eating or drinking.***
- c. Using a two-way radio.
- d. Using a hand-held cellular telephone.
- e. Using radio/stereo headphones.
- f. Taking prescription drugs that may cause dizziness or lack of concentration or reduce response time.
- g. Reading maps, instructions, or other material.
- h. Transporting pets. Transporting pets in Government vehicles generally is not allowed. Transporting pets shall be addressed on a case-by-case basis and documented in the job hazard analysis.

7. **Keep well to the right side on narrow roads and blind curves. Be able to stop within less than half of the visible distance.**

8. Reduce speed when driving on wet, hard-surfaced roads. The front wheels may hydroplane and lose contact with the road surface.

9. Adjust the vehicle speed and select the proper gear before ascending or descending a hill and entering turns.

10. **Pull off the road for a break or to change drivers if you experience any of these warning signs:**

- a. Vehicle begins to feel too warm.
- b. Drowsiness, especially after meals.
- c. Eye strain.
- d. **Inattention, daydreaming.**
- e. Hallucinations (for example, misinterpreting shadows, reflections, objects on or near road) resulting in an impulse to strongly control the vehicle.
- f. Impatience, irritability not normally experienced.
- g. Stress that results in anxiety, anger, or lack of concentration.
- h. Muscular tension, restlessness, or inability to get comfortable.

11. Emergency Stopping.

- a. When it is safe to do so, move the vehicle to the shoulder of the road, away from traffic.
- b. Set the emergency brake.
- c. Activate four-way flashers.
- d. Keep alert to passing traffic.
- e. Exit the vehicle when traffic volume/flow presents undue hazards.
- f. Raise the hood.
- g. Display emergency reflectors, triangles, or other suitable warning devices (ex. 01).

12. If the vehicle is jacked up and/or parked on a grade, follow these steps:

- a. Turn the wheels into bank or curb to avoid rolling.

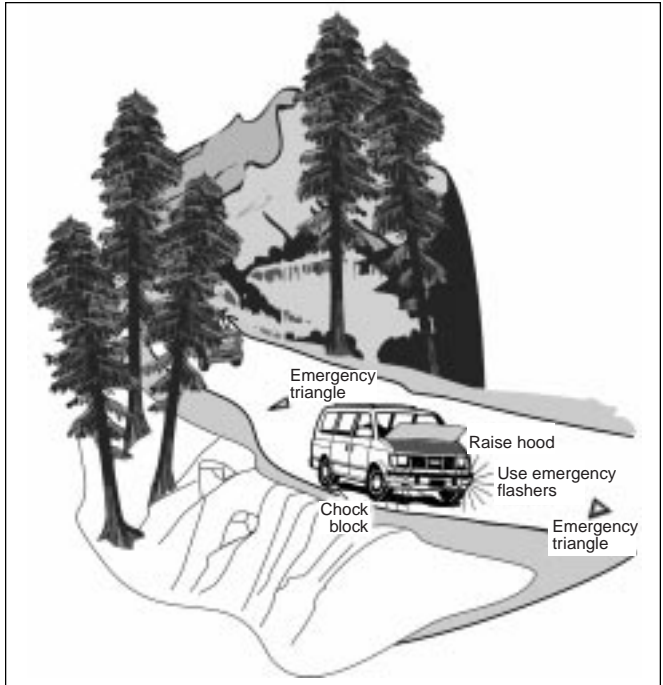
12.34 – Exhibit 01 – Emergency Stopping

- b. Shut off engine while your foot is on the service brake and then set the emergency brake. Put the transmission in the lowest gear that is the direction the vehicle would roll or into park for an automatic transmission.
- c. Block at least one wheel with chock blocks (or other suitable chock, such as a rock or log) . Chocking two wheels is preferred.

13. Prevent carbon monoxide poisoning in a parked vehicle by partially opening a downwind window when running the engine for heat.

12.35 – Driving on Limited Access Highways. When traveling on major divided highways designed for high-speed travel:

1. Plan your trip in advance; know the route and the highway numbers. Adverse weather conditions or construction work may require an alternate route or extra time. Know where to exit. Have adequate fuel.
2. Under ideal driving conditions, use the “2-second rule” in calculating following distance. Watch the vehicle ahead. When it passes a stationary point, such as a sign post or mileage marker, count “1 thousand 1, 1 thousand 2.” This is 2 seconds. If you reach the same stationary point before you finish those words, you are following too closely. Always compensate for changing weather and road conditions by increasing your following distance.

12.36 – Special Hazards while Driving on Forest Service Roads. Special hazards that drivers may encounter are:

1. **Road Width.** Roads with narrow driving surfaces, roads classified as single-lane with turnouts, and roads with few places to park or turn around.
2. **Grade.** Varying grade; range is from 0 to 18 percent.
3. **Surface.** A variety of road surfaces, including those that may be affected by weather.
4. **Sight Distance.** Sight distance which may be limited by adverse weather, blind curves, foliage, dust, smoke, and ambient light.
5. **Other Road Users.** Tourists, heavy equipment operators, motorcyclists, mountain bicyclists, and many other types of road users. Wildlife and domestic stock also may be encountered.

12.4 – Defensive Driving Techniques.

1. Drive slowly and use transmission gearing, engine compression, and gravity to slow the vehicle as it travels uphill. Conversely, use engine compression and gearing on downhill grades.
2. Keep right. ***Drive as far to the right as possible without driving on the shoulder.***

3. Keep headlights, taillights, mirrors, and all windows clean and clear. When conditions limit visibility, slow down, and turn on your headlights.

4. Always maintain control of the vehicle. For example, if unexpected wildlife or domestic livestock are encountered, slow down and try to avoid the animal. Generally, it is safer to hit the animal rather than to drive off the shoulder of the road or cross the centerline and risk a head-on collision.

5. **Parking.**

- a. Select a location that allows a minimum of a 12 foot (4 m) width of unobstructed travel area and adequate sight distance in both directions.
- b. Assess the intended parking area for soft material, holes, rocks, or other debris that could damage tires/undercarriage.
- c. When parking, position the vehicle for a forward departure. Avoid backing the vehicle, when possible.
- d. Shut off the engine, set emergency brake, and put transmission in gear or park.
- e. Use chock blocks.

6. **Methods for Backing.** It is safer to do a backing maneuver when first parking rather than when returning to the vehicle. This allows the operator a complete and full view of the parking spot. It is better to park the vehicle (when possible) so the operator can drive forward and eliminate backing altogether.

- a. Never back up or make a U-turn on blind corners.
- b. Before backing:
 - (1) Select a wide spot with a view that provides adequate sight distance in each direction.
 - (2) Always use a person to serve as a guide for backing when available.
 - (3) Walk around the vehicle and check for hazards and obstructions.
 - (4) Back the rear of the vehicle toward a cutbank.
 - (5) Use caution when backing on fill-sloped edges of roadways.
 - (6) Always face the danger.

7. **Winter Driving.**

- a. In the JHA, identify winter driving hazards on a site-specific basis. Include precautions and techniques to abate hazards:
 - (1) Slow down and increase following distance.
 - (2) Do not use cruise control when roads might be slick. Cruise control can apply power at the wrong time and initiate a skid or make a small skid worse.
 - (3) Follow precautions in all vehicles, including all-wheel-drive vehicles and four-wheel-drive vehicles. Although all-wheel-drive vehicles and four-wheel-drive vehicles may provide better traction, they do not decrease the normal stopping distance.
- b. List necessary equipment/supplies in the JHA. Such equipment/supplies might include jumper cables, snow shovel, winter survival gear, and abrasive material (cat litter, sand, salt, or traction mats).
- c. Prior to winter driving season, conduct tailgate safety sessions to discuss safe winter driving practices, such as what to do in the event of a skid.

12.5 – Transporting Flammable/Combustible Liquids. Flammable liquids have a flash point below 100 °F (38 °C). Combustible liquids have a flash point at or above 100 °F (38 °C). Ensure that a JHA has been written before transporting such liquids. The following is a brief summary of the guidelines:

1. All employees who handle, transport, and use flammable/combustible liquids shall receive hazard communication standards training and be familiar with material safety data sheets.
2. Passengers shall not ride in the enclosed cargo portion of a vehicle hauling flammable/combustible liquids. If it is absolutely necessary to carry flammable/combustible liquids, a minimum amount only of such cargo shall be secured in a rack on the roof.
3. Flammable/combustible liquids shall be carried in approved safety containers as defined by NFPA 30 (sec. 12.01). Such containers shall comply with these requirements:
 - a. Department of Transportation approved.
 - b. Clearly labeled to identify the contents (sec. 38.12).
 - c. No more than 90 percent full.

4. Containers for flammable/combustible liquids shall be:
 - a. Free of leaks and other damage.
 - b. Treated as dangerous, even when empty.
 - c. Stored separate from items, such as human and animal food, to protect against contamination by accidental leakage.
 - d. Positioned upright and secured from movement in a cargo area separated from the passenger compartment by a solid wall, such as a pickup box.
 - e. Never transported in the same cargo area with oxidizers, acids, or radio equipment.

5. Vehicle placarding shall be required for hauling flammables/combustibles in containers larger than 110 gallons (447 L) or containers with other fuels capable of holding more than 1,000 pounds (453 kg), including the weight of the container (approximately 110 gallons or 416 L). Operators shall meet commercial driver's license requirements.

6. Nonflammable chemical agents, such as oleoresin capsicum aerosols (pepper spray) used for deterring bear attacks, may be transported inside the passenger compartment. Inform passengers of the substance to be transported. Requirements for transporting such chemical agents are:

- a. An approved protective case or secured wrapping that will contain all atomized mist.
- b. A safety device protecting the trigger mechanism from accidental discharge.
- c. Storage away from direct sunlight or exposure to temperatures exceeding 120 °F (48 °C).

For law enforcement exceptions to these requirements refer to section 25.3.

12.6 – Battery Jump-Starting Safety. Take the following steps and precautions to jump-start a battery:

1. Before Attaching Battery Cables.
 - a. Make sure vehicles do not touch. Set both vehicles' emergency brakes, set automatic transmissions to PARK or manual transmissions to NEUTRAL. Turn the ignition OFF.

- b. Do not jump-start unless both batteries are the same voltage.
 - c. Wear personal protective equipment/clothing (protective goggles, eyewear, and/or face protection, and gloves).
 - d. Extinguish all flammable materials. A spark can ignite hydrogen gas emitted from batteries.
 - e. Remove the caps of the dead battery if the battery is not the maintenance-free type. Add battery water, if needed. REPLACE CAPS and cover with a damp cloth. Do not jump-start if fluid is frozen.
2. Attaching Battery Cables (ex. 01).
 - a. Clamp the positive (red) end of battery cable to the positive (+) terminal on the dead battery.
 - b. Clamp the positive (red) cable's loose end to the positive (+) terminal of the good battery.

12.6 – Exhibit 01 – Battery Jump-Starting Safety

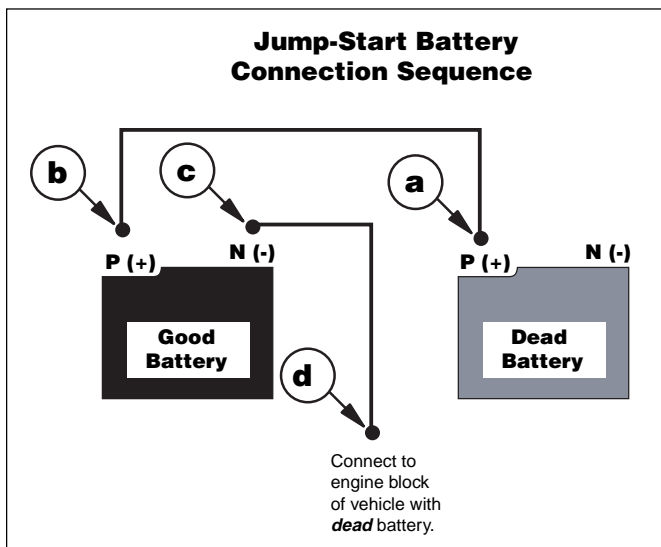

- c. Clamp the negative (black) end of the battery cable to the negative (-) terminal of the good battery.
- d. Clamp the negative (black) cable's loose end to the disabled car's engine block or other suitable ground on the opposite side away from the dead battery.
- e. Start the car with the good battery.
- f. Start the disabled car.
- g. Remove the negative (black) cable from the engine block (or ground) and the negative terminal of the good battery.
- h. Remove the positive (red) cables from the positive terminals.

12.7 – Vehicle Fires. Rely on local fire departments that have the skills and equipment for rescuing occupants and extinguishing vehicle fires. When local assistance is not available, the first priority is safety of personnel.

12.71 – Procedures. Only trained employees with appropriate equipment shall engage in the suppression of vehicle fires. Do not attempt to take any action beyond your level of training.

Secure the scene. Isolate the area and ensure the safety of people and the environment. Ask law enforcement personnel to provide traffic control to prevent accidents and interference with firefighting.

When monitoring vehicle fires during non-suppression actions, stay up wind out of the smoke.

12.72 – Safety practices. If the vehicle you are riding in catches fire, follow these practices.

1. Engine Compartment Fire Safety. Getting away from the fire is your first priority. If there is time:
 - a. Park at a location that provides personal and public safety.
 - b. Turn off the ignition.
 - c. Set the emergency brake.
 - d. Pull the hood latch — but don't raise the hood.
 - e. Exit the vehicle.
 - f. If a fire extinguisher is used, direct a quick burst through the radiator or fender well to reduce the fire and the chance of flash fire when the hood is raised.

2. Fire in Cargo/Hazardous Materials. Any substance may be encountered as cargo in a vehicle fire. Trucks are especially likely to contain materials that are volatile, toxic, gaseous, explosive, or flammable. If hazardous materials are encountered or suspected, the first priority is safety of personnel (sec. 61).

- a. Obtain and study the Department of Transportation (DOT) Emergency Response Guidebook (or equivalent) on hazardous materials.
- b. Maintain a current list of emergency phone numbers to call in experts on hazardous materials.

13 – SPECIALIZED EQUIPMENT. The provisions contained in sections 12 through 12.6 on motorized vehicles apply also to use of specialized equipment.

13.01 – Authority. The authority for the use of specialized vehicles is in Title 49, Code of Federal Regulations (49 CFR), Parts 172, 383-397.

13.06 – Reference. U.S. Department of Agriculture, Forest Service. Driver-Operator Guide. EM-7130-2. Engineering Staff, Washington Office.

13.1 – Four-Wheel-Drive Vehicles.

13.11 – Operation. Four-wheel-drive vehicles are designed to provide extra power and traction for traveling at a slow speed over rough or unusual terrain. When operating four-wheel-drive vehicles:

1. Be familiar with the vehicle before using it for assigned field project work or other activities.
2. Know your limitations and that of the vehicle for all driving conditions.
3. Do not exceed the safe limits for driving speeds allowed by terrain and road conditions.
4. When chains are needed, put them on the rear tires or on all four tires.

13.12 – All-Wheel-Drive Vehicles. Do not confuse all-wheel-drive vehicles with four-wheel-drive vehicles in relation to technical capa-

bilities and driving limitations. All-wheel-drive vehicles have ground clearance and handling characteristics similar to standard sedans and vans. All-wheel-drive vehicles are not specifically designed for unimproved or off-road travel.

13.2 – All-Terrain Vehicles. An all-terrain vehicle (ATV) is any motorized off-highway vehicle 50 inches (1-1/4 m) or less in width, having a dry weight of 600 pounds (272 kg) or less, traveling on three or more low pressure tires, and having a seat to be straddled by the operator and handlebar for steering control as defined by the ATV Safety Institute. For Forest Service application, only four-wheel ATVs will be used by Forest Service employees, as stated in Chapter 6 of the Driver-Operator Guide (sec. 13.06).

13.21 – Qualifications.

1. The supervisor shall ensure that a JHA is prepared for all projects or activities using ATVs and that operators possess the skills required for the work project or activity.
2. Only qualified and authorized employees shall operate ATVs. Qualifications include being familiar with the Driver-Operator Guide (sec. 13.06) and the ATV manufacturer's operating manual.
3. Prior to Forest Service endorsement, a competent Forest Service employee shall conduct a field operations evaluation to identify the proficiency level of the operator. State endorsement is required, if applicable.
4. Operators shall be reevaluated for field operations every 3 years.

13.22 – Personal Protective Equipment.

1. Personal protective equipment (PPE) required for ATV use is as follows:
 - a. Fire extinguisher.
 - b. First aid kit (refer to the Glossary).
 - c. Personal communications device.
 - d. Motorcycle helmet (full- or three-quarter face). Mouth protection is recommended when using three-quarter face helmets. The helmet shall meet requirements of the Department of Transportation (DOT), ANSI (Z90.1), or Snell Memorial Foundation (SMF) standards.

- e. Leather gloves.
- f. Long pants and long-sleeved shirt or jacket.
- g. Appropriate footwear.
- h. Eye protection (such as goggles/glasses, or face shield).
- i. Additional items identified in the JHA (such as a kidney belt or chest protector when employee is engaged in patrols or law enforcement).

2. PPE recommended for ATV use includes a manufacturer's tool kit.

13.23 – Loading and Hauling.

1. Use a hauling vehicle of adequately rated capacity and capability. A tilt/bed trailer designed especially for ATVs is generally best for hauling ATVs.

2. Use loading ramps that are sufficiently wide and that secure firmly to the truck bed.

3. While transporting an ATV, put it in gear, set the parking brake, securely tie it to the hauling vehicle, and close the tailgate.

13.24 – Operation.

1. Become familiar with local hazards.

2. Before riding, always perform a T-CLOC (ASI Program) or similar check:

T – Tires, Wheels

C – Controls, Clutch, Brake, Throttle

L – Lights

O – Oil, Fuel

C – Chassis, Suspension, Nuts, Bolts

3. Do not carry passengers.

4. Always turn off the engine when the ATV is parked. Remove the ignition key and set the brake.

5. When carrying equipment, equalize the load to maintain balance, stability, and center of gravity. Never exceed the recommended gross vehicle weight.

6. Do not drive recklessly or engage in horseplay.

7. Do not ford deep or swift moving water. Hazards exist when:
 - a. Stream bottom is unstable due to mud, sand, boulders, or submerged obstacles.
 - b. Water depth is not consistent through the entire route of travel.
 - c. Stream width prevents a complete view of the bottom across the route of travel.
 - d. Water depth and current may flood the engine.
 - e. Current is forceful enough to require you to counteract it to maintain balance or direction of travel.
8. Modify an ATV only with the manufacturer's written approval.

13.3 – Motorcycles.

13.31 – Qualifications.

1. The supervisor shall ensure that a JHA is prepared for all projects or activities using motorcycles and that operators possess the skills required for the work project or activity.
2. Only qualified and authorized employees shall operate motorcycles. Qualifications shall include being familiar with the Driver-Operator Guide (sec. 13.06), the manufacturer's operating manual, and uses and limitations of the machine.
3. Before operators undertake riding assignments, a qualified examiner shall certify operators for the type of machine and terrain typical of the work project or activity.
4. Where State law requires, operators shall have a motorcycle endorsement. Certification shall be noted on their Driver-Operator Identification Card or documentation authorizing use.
5. Operators are responsible for carrying out machine inspections before, during, and after use.

13.32 – Personal Protective Equipment.

1. PPE required for motorcycles is as follows:
 - a. First aid kit (refer to the Glossary).
 - b. Personal communications device.
 - c. Motorcycle helmet (full or three-quarter face). Mouth protection is recommended when using three-quarter

face helmets, goggles, or face shield. Helmet shall meet requirements of DOT, ANSI Z90.1, or Snell Memorial Foundation (SMF) standards.

- d. Leather gloves.
- e. Long pants and long-sleeved shirt or jacket.
- f. Appropriate footwear.
- g. Additional items identified in the JHA.
- h. Manufacturer's tool kit.

13.33 – Operation. Always perform a pre-ride inspection (sec. 13.24).

13.4 – Snowmobiles.

13.41 – Qualifications.

1. The supervisor shall ensure that a JHA, emergency evacuation procedures, and communications plan are prepared and approved by the appropriate line officer for all projects or activities using snowmobiles, and that operators possess the skills required for the work project or activity. An itinerary shall be filed with the supervisor and at the final destination when appropriate.

2. Only qualified and authorized employees shall operate snowmobiles. Qualifications include being familiar with the Driver-Operator Guide (sec. 13.06) and the manufacturer's operating manual.

3. Operators shall receive training in the use of and the loading/unloading of snowmobiles that includes classroom instruction and practical field exercise or demonstration of proficiency. Certification shall be noted on a Driver-Operator Identification Card or other documentation authorizing use. Employees shall be trained in emergency survival, avalanche hazard recognition, and, where needed, avalanche control.

4. Operators shall be recertified every 3 years.

13.42 – Personal Protective Equipment.

- 1. PPE required for snowmobile use is as follows:
 - a. Map and compass (a GPS receiver is optional; sec. 21.12 and Glossary).
 - b. Manufacturer's operating manual.

- c. Snowmobile helmet (DOT, ANSI, or Snell approved.)
 - d. Clothing adequate for winter travel, including goggles, gloves, and boots.
 - e. Personal communications device.
 - f. First aid kit (refer to the Glossary).
 - g. Flashlight with extra batteries and bulb.
 - h. Shovel.
 - i. Manufacturer's tool kit.
 - j. Collapsible (sectional) probes and avalanche rescue transceivers.
 - k. Emergency equipment/clothing identified in the JHA.
2. PPE recommended for snowmobiles includes skis or snowshoes and sunscreen.

13.43 – Operation.

1. Always inspect the machine thoroughly before use, following procedures outlined in the manufacturer's operating manual.
2. Plan travel according to the weather and snow conditions. Be flexible with your departure dates.
3. Do not carry passengers.
4. Do not drive recklessly or engage in horseplay.
5. Do not leave the engine running when parked. Turn it off, remove the ignition key, and set the parking brake. If the machine does not have a parking brake, secure it against movement.
6. Avoid travel at night and do not travel alone. If travel at night cannot be avoided, travel over familiar ground. Do not blaze a new trail. Reduce speed so you don't overdrive the machine's headlights.

13.5 – Snow Cats.

13.51 – Qualifications.

1. The supervisor shall ensure that a JHA, emergency evacuation procedures, and communications plan are prepared and approved by the appropriate line officer for all projects or activities using snow cats, and that operators possess the skills required for

the work project or activity. An itinerary shall be filed with the supervisor and at the final destination when appropriate.

2. Only qualified and authorized employees shall operate snow cats. Qualifications include being familiar with the Driver-Operator Guide (sec. 13.06) and the manufacturer's operating manual.

3. Operators shall receive training in the use of and the loading/unloading of snow cats that includes classroom instruction and practical field exercise or demonstration of proficiency. This training shall be given by the manufacturer, a Forest Service employee with at least 100 hours of snow cat experience, or by a certified instructor. Certification shall be noted on a Driver-Operator Identification Card or other documentation authorizing use. Employees shall be trained in emergency survival, avalanche hazard recognition, and, where needed, avalanche control.

13.52 – Personal Protective Equipment. In addition to PPE identified in section 13.42, the following equipment is required:

1. Hearing protection (85 dB and above).
2. Safety belts for operator and all passengers.
3. Skis or snowshoes, depending on travel distance, terrain, and snow conditions.
4. Emergency equipment/clothing identified in the JHA. Collapsible (sectional) probes and avalanche rescue transceivers when applicable.

13.53 – Operation.

1. Become familiar with local hazards.
2. Plan travel according to weather and snow conditions.
3. Know snow conditions, such as expected amount and type (whiteouts).
4. Avoid travel at night.
5. Conduct a pre-trip inspection of the snow cat. Follow the procedures outlined in the manufacturer's operating manual.

6. Ensure lights are operating. For backing operations, utilize an observer or functional back up alarm or both.
7. Do not engage in reckless driving or horseplay, which is strictly prohibited.
8. Avoid leaving any machine running unattended. When it is necessary to run the machine when parked, make sure the emergency brake is set.
9. Radio any deviations from your scheduled route of travel to the appropriate unit or servicing personnel office whenever possible.
10. Do not attempt major modifications of a snow cat without the manufacturer's written approval.

13.6 – Trailers.

13.61 – Qualifications. Only qualified and authorized personnel are permitted to tow trailers as indicated by an endorsement on a Driver-Operator Identification Card or documentation authorizing use.

Each Forest or unit shall have personnel qualified to train and to authorize drivers for towing trailers.

13.62 – Pre-trip Safety Inspection.

1. Ensure that wheel bearings have been packed periodically.
2. Check the following:
 - a. Wheel bearing play and tires. Grasp the top of each tire and attempt to move it side to side.
 - b. Wheels, lug nuts, and tires.
 - c. Wiring and light system.
 - d. Trailer brakes, if equipped.
 - e. Fenders and mud flaps, if equipped.
 - f. Springs and shackles.
 - g. Trailer floor surface for defects.
 - h. Safety chains.

13.63 – Operation. Trailers can adversely affect vehicle handling and stopping. Always drive at a speed that allows for full control of the vehicle and trailer.

1. Ensure that vehicles used for towing trailers comply with Federal, State, and specific Regional requirements regarding size, weight, and necessary equipment.
 - a. For tongue type, tag-a-long trailers, gross trailer weight (GTW) is not to exceed 75 percent of the towing vehicle's gross vehicle weight rating (GVWR). The actual loaded weights shall never exceed the gross axle weight ratings (GAWR).
 - b. As truck gross vehicle weight ratings (GVWR) increase, the actual truck weight does not increase in the same proportion. There are situations where the best way to determine the towing capability of trucks over the nominal 1 ton weight (GTW) is not to exceed 75 percent of the actual truck weight. Adding weight to the truck is a better choice than adding any weight to the trailer. This allows the towing unit to fully control the trailer.
 - c. For fifth-wheel or gooseneck type trailers, use the manufacturer's published gross combined rating (GCWR), available from the fleet manager or specific vehicle towing specifications. These ratings reflect a combination of proper truck components, including engine size, transmission, rear axle ratio, frame, and suspension. In no case shall the GCWR exceed the manufacturer's published GCWR nor shall any individual axle exceed the specific gross axle weight (GAWR) stamped on the manufacturer's plate.
2. Keep hands and feet away from the coupling device when maneuvering the trailer into position for locking.
3. Never permit riders in or on trailers.
4. When backing a trailer, first get out and check the area to the rear, sides, front, and overhead to ensure the vehicle is clear of obstructions. Use an observer when available.

13.64 – Equipment. The following equipment is required for trailer use.

1. Warning equipment, such as reflective triangles or other suitable warning devices.

2. Brakes, lights, and markings as required by State and Federal regulations.
3. Safety chains to match or exceed the trailer weight rating. Chains shall be in place and crossed under the tongue.
4. Side-view mirrors that provide adequate rear vision.
5. Trailer jacks (horse and heavy duty trailers), which are generally not needed for light trailers, such as those used for ATVs and snowmobiles.
6. Trailer brakes for trailers with 1,500 pounds (680 kg) GTWR or above.
7. Emergency break-away system and wet or gel cell battery (trailers 1,500 pounds (680 kg) GTWR and above).

13.7 – Transporting Passengers. Drivers operating vehicles designed to transport more than 16 passengers (including the driver) must have a Commercial Driver's License and a Forest Service endorsement.

Transport vehicles shall be equipped with the following:

1. Manufacturer's standard seat with appropriate safety belts for every person carried by the vehicle. Refer to 49 CFR 392.9 for the exception for bus passengers.
2. Steps for loading and unloading.
3. Right and left side-view mirrors.
4. A safety partition separating passengers from tools/equipment.
5. Emergency doors, windows, and exits.
 - a. The passengers and driver shall have unobstructed access to all exits. The means of egress shall not be restricted, blocked, or modified in any way (49 CFR 393.61).
 - b. The vehicle driver and/or supervisor shall identify and inform all passengers of exit locations and emergency exit procedures.

13.71 – Safety Practices. When transporting passengers, observe these precautions:

1. Every vehicle shall meet appropriate standards for carrying passengers.
2. Passengers shall ride inside the passenger compartment.
3. ***Passengers shall never be allowed to ride anywhere but on a manufacturer's provided, installed seat.***
4. Employees and equipment may be transported together only when:
 - a. Equipment is enclosed in a box attached to the floor and securely fastened, or
 - b. A safety partition has been provided to separate passengers from equipment (sec. 12.5), or
 - c. Equipment is wrapped in appropriate material and secured to the vehicle (emergency only).
5. Flammable/combustible liquids, such as tree marking paint, shall not be transported inside the vehicle with passengers and driver (sec. 22.47e).

14 – AVIATION SAFETY. (For further direction, see FSM 5700, FSH 5709.14, FSH 5709.16, and appropriate Interagency Aviation Guides.) Aviation management includes all activities associated with providing aircraft support services for natural resource protection and management functions of the Forest Service. Support services incorporate program leadership, supervision, cooperation, aviation expertise, training, and safety program management.

It is essential that all aviation operations be planned with the utmost consideration. Missions can be accomplished safely, provided that a high degree of planning, risk management, and analysis is applied. Consult your aviation officer prior to undertaking any aviation operation.

15 – WATERCRAFT SAFETY.

15.01 – Authority. The authority for watercraft operations is in:

1. National Fire Protection Association. Required standards related to fire protection are in the following NFPA publications: NFPA 10: Portable Fire Extinguishers; NFPA 30: Flammable and Combustible Liquids Code; NFPA 302: Pleasure and Commercial Motor Craft; NFPA 306: Control of Gas Hazards on Vessels.

2. Title 29, Code of Federal Regulations (29 CFR), section 1910.106 contains requirements for flammable and combustible liquids, and section 1926.605 contains requirements for marine operations and equipment.

3. U.S. Department of Transportation, U.S. Coast Guard. U.S. Coast Guard Boating Regulations and Federal Requirements. U.S. Coast Guard Boating Education Branch. U.S. Government Printing Office, Washington, DC.

15.04 – Responsibility.

15.04a – Boat Operator. The boat operator has the responsibility to:

1. Conduct a pre-trip inspection.
2. Operate the watercraft safely.
3. Protect personnel and Government property.

15.04b – Supervisor. The supervisor has the responsibility to ensure that crews of watercraft over 16 feet (4-4/5 m) are trained in firefighting procedures and know their duty stations and what is expected of their performance.

15.1 – Watercraft Operation. Government watercraft shall be equipped and operated in accordance with U.S. Coast Guard, Federal, State, and local rules and regulations. Watercraft must pass annual U.S. Coast Guard inspections, as required for the size of the vessel.

15.11 – Qualifications.

1. ***Watercraft operators shall be licensed and experienced. One operator shall be in charge of the watercraft at all times.***

2. The supervisor shall ensure that a JHA is prepared. The JHA shall specify the type of Personal Flotation Device (PFD) to be worn for specific work projects and activities and shall document emergency procedures for all watercraft operations.

3. Watercraft personnel should be able to swim. Nonswimmers should demonstrate proficiency in their PFDs by floating freely for 3 minutes.

4. Training qualifications shall be documented on the operator's Regional identification card or other documentation authorizing use, such as a license.

- a. Operators shall complete a boating class developed for their unit or attend the U.S. Coast Guard Safe Boating Skills and Seamanship class.
- b. To prepare for any emergency, personnel shall be trained to start and operate main and auxiliary engines, radios, and other necessary equipment.
- c. All operators and at least two members of the crews assigned to any watercraft shall be trained in first aid and CPR. This training is required for all operators.
- d. All personnel shall be trained in the use of the PFD. Supervisors shall use tailgate safety and health sessions for review.

5. Operators shall successfully complete check rides given by designated examiners. Experience shall be demonstrated by a combination of hands-on training and skill development as observed by a licensed operator.

15.12 – Personal Protective Equipment.

1. PPE required for both power watercraft and paddle craft includes:

- a. ***U.S. Coast Guard approved, properly fitted PFD.***
When immersion suits are required, they shall meet U.S. Coast Guard standards.
- b. First aid kit (refer to the Glossary).
- c. Area maps/compass.
- d. Flashlight with extra batteries and bulb.
- e. Bailing device.
- f. Personal communications device.

2. PPE recommended for both power watercraft and paddlecraft includes:
 - a. 50-100 feet (15-30 m) of rope.
 - b. Manufacturer's repair kit and emergency spare parts.
3. PPE required for power watercraft includes:
 - a. Sound-producing signal device.
 - b. Anchor and anchor line.
 - c. Marine charts.
 - d. Emergency flare kit. Pistol launched and hand-held parachute flares and meteors have many characteristics of a firearm and must be handled with caution. In some States, they are considered a firearm and are prohibited.
 - e. Carbon monoxide detectors for all watercraft with enclosed cabins.
4. PPE recommended for power watercraft includes a global positioning system (GPS) receiver (sec. 21.12 and the Glossary), in addition to maps, charts, and a compass.
5. PPE required for paddlecraft includes spare oars/paddles.
6. PPE recommended for paddlecraft includes:
 - a. Personal survival kit with items such as a knife, flares, fire starter, and space blanket.
 - b. Helmet.

15.13 – Safety Practices.

15.13a – General Safety Practices.

1. ***Coast Guard approved PFDs shall be provided and readily accessible at all times for each person in a watercraft.***
When the watercraft is underway, all occupants of any open Forest Service boat shall wear approved PFDs at all times. When a watercraft is underway, any occupant of any closed-cabin Forest Service boat shall wear an approved PFD whenever outside the cabin (exceptions may be made on boats 40 feet (12 m) and over, when authorized by the skipper). Follow the manufacturer's specifications for inspection, replacement, and storage requirements.
2. When boat engines or controls are provided with safety lanyards, boat operators are required to wear/attach the lanyard to themselves in open boats and boats with cable or tiller steering.

The use of lanyards in boats with enclosed cabins and hydraulic steering may be at the operator's discretion.

3. All regularly scheduled travel shall terminate at least 1 hour before sunset to allow time to initiate assistance, search, or rescue.

4. Radio contact for prescheduled float following check-ins is required for all water travel. Regular check-in schedules shall be established by the unit.

5. Watercraft shall be maintained in a safe, operable condition, and a record kept to verify regular maintenance schedule.

6. Walking surfaces, including the interiors of watercraft, shall be nonskid.

7. *The maximum allowable load limit for watercraft as specified by the manufacturer shall not be exceeded.*

8. Open ocean and beach surf landings should not be attempted in any watercraft. Only in emergencies may experienced personnel attempt such landings.

9. Operators shall secure a current weather forecast before travel and shall monitor the weather while underway.

15.13b – Fire Suppression.

1. Required standard safety equipment for fire suppression includes:

- a. Portable fire extinguishers, rated Class B, that comply with applicable regulations, such as U.S. Coast Guard and NFPA. Roman numerals I and II indicate the size of fire the extinguisher is capable of putting out (sec. 35.11a). The larger the number, the larger the fire it will extinguish (ex. 01).
- b. Emergency life raft for watercraft 26 feet (8 m) and over.

2. Fire extinguishers shall be mounted to watercraft and easily accessible. All crew members shall know the location of fire extinguishers and how to operate them (sec. 35.11).

- a. In case of fire, head the boat so that the fire is to leeward or head toward shore, whichever offers greater crew safety.

15.13b – Exhibit 01 – Watercraft Fire Extinguisher Requirements

| Minimum number of hand portable fire extinguishers required: | | |
|--|------------------------------|------------------------------------|
| <i>Vessel Length</i> | <i>No Fixed System</i> | <i>With Approved Fixed Systems</i> |
| Less than 26' | 1 B-I | 0 |
| 26' to less than 40' | 2 B-I or 1 B-II | 1 B-I |
| 40' to 65' | 3 B-I or 1 B-II and 1 B-I | 2 B-I or 1 B-I |

- b. Eliminate the fuel source, if possible; shut off the ignition and fuel supply during engine fires.
- c. Communicate your position and situation to shore stations or other boats.

15.14 – Watercraft Less Than 26 Feet (8 m).

1. Follow manufacturer's recommendations for engine size.
2. Before fueling, employees shall be familiar with material safety data sheets. Comply with the following recommended procedures:
 - a. Shut off the motor.
 - b. Extinguish all open flames.
 - c. Do not fill portable fuel containers aboard watercraft.
 - d. Carry gasoline in approved safety container(s).
 - e. Do not overfill tanks or containers. Allow for vapor expansion and clean up all spills immediately.
 - f. Follow specific instructions in section 15.15 paragraph 2 for boats with enclosed cabins.
 - g. Store hazardous materials in compliance with applicable regulations, such as NFPA and U.S. Coast Guard.
3. An auxiliary power source must be available when operating in salt water for trips more than 1/2 mile (1 km), and for trips of any length when adverse weather exists or is expected.

15.15 – Watercraft 26 Feet (8 m) and Over. The JHA shall identify the employee who will serve as watercraft operator. Preschedule trips and use float-following check-ins (refer to the Glossary).

1. Operator duties:
 - a. Perform and document a pre-trip inspection.
 - b. Comply with all navigation regulations.
 - c. Allow no one on deck in rough weather unless absolutely necessary.
 - d. Keep engine room and bilges well ventilated.
 - e. Keep decks free from oil, grease, and unnecessary equipment.

2. Recommended fueling procedures:
 - a. Secure the watercraft to prevent movement during fueling operations.
 - b. Remove all personnel except those essential for fueling operations.
 - c. Extinguish all open flames.
 - d. Shut off motors and electrical devices that may produce sparks.
 - e. Close all cabin and compartment openings.
 - f. Check fuel tank vents for functional operation and fuel lines for leakage during the fueling process.
 - g. Follow grounding and bonding procedures or use a self-grounding nozzle to prevent static sparks.
 - h. Close the fill opening after fueling. If fuel has spilled, clean up with proper materials and report the spill to the U.S. Coast Guard.
 - (1) Allow the boat to ventilate for 5 minutes. Before starting the engine, check all compartments for fuel odors.
 - (2) Open all ports, doors, and hatches.
 - (3) Turn on explosion-proof bilge blowers, where available.

3. Post safety regulations as required by the U.S. Coast Guard and conspicuously post equipment instructions.

4. Tag and mark all engine room valves to explain their function.

15.16 – Paddlecraft. Paddlecraft, such as canoes, kayaks, rafts, and rowboats, have very different handling characteristics, but they have one thing in common. They capsize easily if overloaded or improperly loaded. Paddlers need to realize their craft's vulnerabil-

ity, assess their own boating experience, their swimming ability, and determine the level of difficulty the waterway presents.

1. Loading.
 - a. ***NEVER exceed the manufacturer's recommended load capacity.***
 - b. Where possible, load cargo from the side rather than over an end.
 - c. Balance the load evenly both port to starboard and fore and aft, so the hull is stable and trim.
 - d. Secure cargo to prevent shifting when the craft is underway. Stow all loose rope, net, or tie downs that could hang up.
2. Operation.
 - a. Maintain balance of the watercraft.
 - (1) Use care when entering and exiting.
 - (2) Do not stand up or make sudden moves in small watercraft. Go to shore if it is necessary to change places, repair the motor, reposition cargo, or move to another watercraft.
 - b. Exercise care in releasing and raising the anchor.
 - c. Do not schedule night travel. If occasional night travel is required, it shall be addressed in the JHA and discussed with all crew members. Display all proper night navigation lights.

16 – LIVESTOCK HANDLING. Animals that display dangerous characteristics, such as uncontrollable bucking, shall not be accepted for service. If dangerous habits are discovered, remove the animal from service. Select appropriate livestock for the specific work project or activity.

16.04 – Responsibility. Supervisors shall ensure that personnel assigned to break, train, and ride pack/saddle livestock are competent in these tasks.

16.06 – Reference. U.S. Department of Agriculture, Forest Service. Driver-Operator Guide. EM-7130-2. Engineering Staff, 201 14th Street S.W., Washington, DC.

16.1 – General Livestock Transportation. Equip livestock vehicles with the following:

1. Secure footing for livestock, such as nonslip rubber matting or cleats. If cleats are used, inspect them frequently for loose or rotten boards and protruding nails. Sand or other absorbent or abrasive substances may be applied to floor as needed.

2. Racks or sideboards.

3. Trailer brakes for trailers 1,500 pounds (680 kg) gross trailer weight and over. Ensure that the trailer brake system is designed to be applied when the driver in the towing vehicle applies the normal truck service brakes (sec. 13.64, para. 6).

A round metal or rubber bumper is recommended for the rear of the vehicle.

16.11 – Transporting Livestock in Trailers. Ensure the trailer selected has the appropriate height and length clearance for the livestock. The trailer shall be free of sharp edges that might injure livestock during transport. Personnel hauling livestock in trailers shall have the proper trailer endorsement.

16.11a – Loading.

1. Never ride livestock into a trailer.
2. Load/unload livestock at previously identified loading ramps.
3. Do not exceed the load carrying capacity of the vehicle.
4. Do not carry loose gear, personnel, and animals together.
5. If it is necessary to lead an animal into a two-stall trailer, do not get into the same stall with or in front of the animal. Do not wrap the lead rope around your hand or any part of your body.
6. Rest the tailgate evenly on the loading ramp or surface level with the bed of the vehicle.
7. Stand to one side when raising or lowering the ramp tailgate.

16.11b – Securing Livestock.

1. Halter livestock and fasten the animal's head securely.
2. Use a rolling slipknot or hitching rack-tie to secure livestock.

3. Secure excess rope away from livestock so it does not drag on the ground.
4. When hauling one animal in a two-stall trailer, secure the animal on the left side to keep its weight near the center of the road (ex. 01).
5. Hook divider chains on two-stall trailers.
6. Close the tailgate immediately.

16.11c – Unloading.

1. Always untie the animal before opening the tailgate.
2. Open the tailgate from the side and stand clear.
3. Unhook divider chains on two-stall trailers. The animal may rapidly back out of trailer.
4. Unload livestock before jacking up a vehicle to change a tire.

16.12 – Transporting Livestock in Trucks. Personnel hauling livestock in trucks shall have the proper truck endorsement. Sites used to load and unload livestock shall be carefully selected.

16.12a – Loading.

1. Never ride livestock into the truck.

16.11b – Exhibit 01 – Livestock Transportation

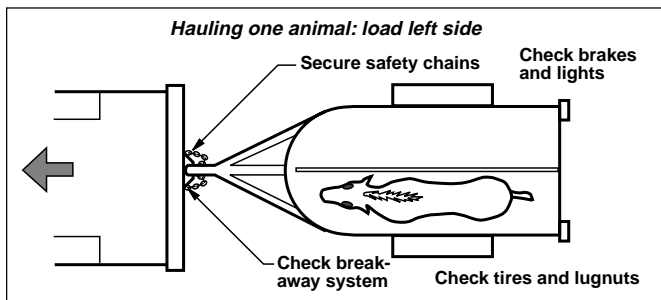

2. Load livestock to maintain balance, stability, and vehicle control.
3. Alternate the facing of each animal when hauling more than three animals.
4. Position them crosswise so each animal faces the side of the truck.
5. Secure divider ropes between each animal.
6. Coil and tie divider ropes to the sides of the truck when not in use.
7. Position ropes so they can be secured.
8. Close the tailgate and secure the locking mechanism.

16.2 – Safe Driving Practices.

1. Conduct a pre-trip safety inspection of trailer/truck.
2. Avoid quick starts and stops.
3. Remember, livestock may shift from side to side and back to front, making the load unstable.

16.3 – Personal Protective Equipment. The JHA shall identify PPE specific to the task to be performed. Standard PPE includes:

1. First aid kit (refer to the Glossary).
2. Riding boots, field boots, or work shoes that will not hang up in stirrups. Only experienced riders may wear spurs. Appropriate footwear shall be worn for specific work projects or activities after arrival.
3. Protective head gear designed for livestock riding is recommended for inexperienced riders and should be available to employees on request. Head gear shall meet American Society for Testing and Materials (ASTM) and Safety Equipment Institute (SEI) standards.

16.4 – Riding Livestock. The packer or individual assigned for pack/saddle livestock handling shall:

1. Match livestock with employee(s) according to riding skills.
2. Instruct employees that all livestock can be dangerous.
3. Before riding, hold tailgate safety sessions addressing livestock habits and characteristics.

16.41 – Riding Practices. Basic safety practices:

1. When working around stock, always speak to an animal when approaching from any direction.
2. Check the animal's shoes for excessive wear and looseness. Hooves should be checked and cleaned, if needed, at the beginning and end of each day.
3. Inspect the saddle and equipment (tack) to ensure it is in good condition. Bridle stock before mounting.
4. Always lead an animal around after being saddled and before being mounted or packed.
5. Be alert for insects, animals, and people that may spook livestock.
6. Do not wrap or tie reins around the saddle horn.
7. Do not tie the lead rope around the lead horse's saddle horn or wrap the rope around your hand.
8. ***Never ride an animal when a lightning storm is nearby or in progress.*** Dismount and seek shelter (sec. 54.23).
9. Keep excessive slack out of the lead rope.
10. Watch out for low-hanging obstacles, such as branches and wires.
11. Do not run the animal.
12. Always carry a cutting tool, such as a multi-purpose tool.
13. Ensure that the JHA addresses riding alone.
14. Do not secure tools or equipment on livestock being ridden or carry them in your hands while riding.

15. Ensure that only competent riders ride bareback.

16.42 – Securing Livestock. Do not use bridle reins to tie livestock.

1. When tying livestock, clear away debris and tie the lead rope at least 4 feet (2 m) above the ground to prevent entanglement.

2. Tie the animal to an object using a rolling slipknot. Where possible, tie the rope to an object that the animal cannot walk completely around.

3. After tying livestock, do not cross under the lead rope.

4. Do not tie the animal to a wire fence.

5. Do not position yourself in front of tied livestock.

6. Halter all animals under the bridle.

7. Use cotton rope at least 1/2-inch (12-3/4 mm) diameter for picketing.

8. Unless picketing or hobbling livestock, do not tie stock to movable objects.

9. When near the rear of livestock, stay close, maintain contact, and talk to the animal.

16.43 – Packing Livestock. Only persons competent in packing and unpacking livestock shall be allowed to perform these tasks.

1. Keep the animal's back clean, saddle pad straight, saddle blanket smooth, saddle properly fitted and tight, and side packs as equal in weight as possible.

2. Use breakaways to tie pack string together.

3. As a courtesy, generally yield to uphill pack strings in the morning; yield to downhill pack strings in the evening. There are exceptions where it may be safer to yield to larger or less experienced pack strings.

4. Hikers should yield to stock traffic. When encountering hikers who are unfamiliar with stock, ask them to stand on the

downhill side of the trail and wait quietly for the stock to pass. If stock spooks, standing downhill will encourage them to go uphill and lessen the chance of an accident.

16.44 – Leading Livestock. Use lead rope approximately 10 feet (3 m) in length, with smooth braid at the free end and no knots or loops.

1. Avoid excess rope that may become entangled.
2. Do not wrap coils around your hand or the saddle horn.

16.45 – Feeding Livestock. Take these precautions:

1. Do not feed or water a sweaty animal until it has cooled off.
2. When feeding or salting animals, exercise caution as even gentle animals may become aggressive and dangerous.

16.5 – Other Livestock Handling Concerns.

16.51 – Draft Stock. When using draft horses, mules, or other livestock for work projects or activities, refer to the JHA for specific requirements.

16.52 – Private Livestock. When it is necessary to impound private livestock on Federal lands, only competent (refer to the Glossary) personnel shall be assigned to round up and herd animals.

1. Exercise extreme caution in the presence of bulls or stallions.
2. Keep alert when in a corral with livestock.

16.53 – Shoeing. Only competent personnel shall be assigned to perform farrier duties.

17 – BICYCLE SAFETY.

17.01 – Authority. The authority for use of non-motorized bicycles on Forest Service lands is found in Title 36, Code of Federal Regulations (36 CFR), Part 261.

17.04 – Responsibility. The first-line supervisor shall ensure that a JHA is prepared for all projects or activities using bicycles and that

riders possess the skills required to operate bicycles safely under the conditions required by the project or activity.

17.06 – Reference. U.S. Department of Agriculture, Forest Service. 1992. Driver-Operator Guide. EM-7130-2. Engineering Staff, 201 14th Street S.W., Washington, DC.

17.1 – Qualifications. Bicycle riders shall follow all applicable laws and shall be competent in operating procedures. Inexperienced riders shall be trained and be accompanied by a competent rider. Defensive driving rules for vehicles apply to bicyclists also (sec. 17.01).

17.2 – Defensive Driving. *Most bicycle fatalities involve a collision with a motor vehicle.* Causes of bicycle/motor vehicle accidents include:

1. Failure to yield the right-of-way.
2. Not being seen by a motorist.
3. Riding against traffic.
4. Inattentiveness to traffic and surroundings.

17.3 – Personal Protective Equipment.

1. PPE required when riding bicycles includes:
 - a. Helmet (ANSI Z90.1 standard, SNELL, or ASME approved).
 - b. Gloves and eye protection.
 - c. Rear-facing red reflector and/or red lamp on back of bicycle.
 - d. Colorless or amber reflector in the spokes of the front wheel and an amber or red reflector in the spokes of the rear wheel.
 - e. First aid kit (refer to the Glossary).
 - f. Additional PPE identified by JHA.
2. PPE recommended when riding bicycles includes:
 - a. Light that illuminates the road or trail 50 feet (15-1/4 m) ahead and is visible to on-coming traffic 500 feet (152-1/2 m) ahead.

- b. Bell/horn and mirror.
- c. Drinking water and high-energy food.
- d. Tool kit, including an extra tube, tire levers, tire pump, and pocket knife or multi-purpose tool.

17.4 – Procedures. The first-line supervisor shall discuss the JHA and individual employee's operational capabilities/limitations. Suggested topics for discussion:

1. Employee's physical fitness.
2. Training in bicycle operation and safety.
3. Bicycle maintenance.
4. Knowledge of local hazards.
5. Trail etiquette.
6. Special concerns (sec. 17.5, para. 2).

17.5 – Safety Practices.

1. **Etiquette.**

- a. Ride defensively and be courteous.
- b. Ride in control and in small groups.
- c. Pass slowly and in single file.
- d. Yield right-of-way:
 - (1) When meeting domestic riding livestock or pack animals on a trail, dismount and stand to the lower side of the trail (ex. 01).
 - (2) When approaching other trail users from behind, call out a greeting and ask how best to proceed around them.

2. **Special Concerns.** Special concerns shall be addressed in the JHA.

- a. Weather: wind, lightning, and flash flooding.
- b. Health: giardiasis, insects, hypothermia, dehydration, sunburn, heat exhaustion/stroke, and fatigue.
- c. Safety: animal/human encounters, stream and river fords, hazardous trail conditions, snags, and riding during hunting season.

17.5 – Exhibit 01 – Bicycling Etiquette



18 – WALKING AND HIKING SAFETY. Slips, trips, and falls are the leading causes of field and office accidents and injuries.

18.06 – References.

1. American Podiatric Medical Association, Inc. 1991. Series: Your Podiatrist Talks. Bethesda, MD.
2. Lau, Susan. 1994. Series: Day by Day/42. Part 33. American Diabetes Association. Alexandria, VA.
3. U.S Department of Agriculture, Forest Service. 1991. Video: Meet Your Feet. Missoula, MT: Missoula Technology and Development Center, Forest Service.
4. U.S Department of Agriculture, Forest Service. 1989. Video: Wildlands Walking Techniques. Missoula, MT: Missoula Technology and Development Center, Forest Service.

18.1 – Foot Care.

1. Practice good hygiene. Ensure proper fit of footwear (ex. 01).

2. Break in new footwear before work projects and activities.

Effective foot care tips are:

- a. Change socks daily. Wear clean, quality socks for cushioning, wicking moisture, reducing friction, insulating against heat/cold, and providing general comfort. Socks should fit snugly to eliminate wrinkles and overlap. Avoid wearing socks with darns.
- b. Treat tender spots with protective material if redness appears.
- c. Wear protective rubber gloves when treating blisters. Clean area with antiseptic and cover with protective material.

18.2 – Footwear. A JHA shall identify what type of footwear is appropriate for the specific work project or activity.

18.1 – Exhibit 01 – Foot Care

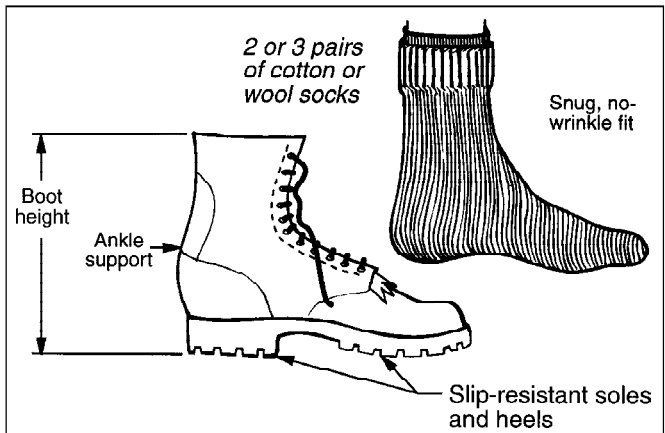

18.21 – General Requirement. Wear shoes with slip-resistant heels and soles with firm, flexible support.

18.22 – Specific Requirement. For fire-related activities, wear all-leather, lace up, 8-inch minimum (204 mm) boots, with nonskid or lug soles.

18.3 – Wildland Walking. First-line supervisors shall advise crews in the prevention of slips, trips, and falls. Discuss the importance of being physically fit as well as the need to practice these walking/falling techniques:

1. Identify safe routes and local conditions.
2. Use warm-up and stretching exercises. Stretching the calf muscles is particularly important to reduce the incidence of shin splints.
3. ***Test and use secure footing. Walk, never run, down slopes.***
4. Maintain a safe walking distance between people (10 feet or 3 meters minimum).
5. In heavy undergrowth, lift knees high to clear obstacles. Slow down and watch your step.
6. Always carry tools on the downhill side.
7. Know how to fall. Try to land in the least obstructed spot. Protect your head and back. Roll with the fall. ***Do not stick out your arms to break a fall.***

CHAPTER 20 – WORK PROJECTS AND ACTIVITIES

Contents

21 GENERAL PROJECT PLANNING

- 21.01 Authority
- 21.04 Responsibility
- 21.06 References
- 21.1 Job Hazard Analysis
- 21.11 Qualifications
- 21.12 Training
- 21.13 Personal Protective Equipment
- 21.13a General Requirements
- 21.13b Specific Requirements
- 21.14 Procedures
- 21.2 First Aid Training/Minimum
- 21.21 First Aid and Cardiopulmonary Resuscitation
- 21.22 First Aid Equipment
- 21.3 Safety Practices
- 21.31 Hunting Season

22 RESOURCE MANAGEMENT

- 22.01 Authority
- 22.06 References
- 22.07 Qualifications
- 22.08 Procedures
- 22.1 Environmental
- 22.11 Pesticide Application
- 22.11a Qualifications
- 22.11b Personal Protective Equipment
- 22.11c Procedures
- 22.11d Safety Practices
- 22.12 Aircraft Calibration for Pesticide Application
- 22.12a Safety Practices
- 22.2 Range
- 22.21 Qualifications
- 22.22 Fencing
- 22.22a Personal Protective Equipment
- 22.22b Safety Practices

- 22.3 Recreation
- 22.31 Qualifications
 - 22.31a Personal Protective Equipment
 - 22.31b Procedures
 - 22.31c Safety Practices
- 22.32 Administration of Developed Sites
 - 22.32a Standards
 - 22.32b Qualifications
 - 22.32c Personal Protective Equipment
 - 22.32d Procedures
 - 22.32e Safety Practices
- 22.33 Administration of Undeveloped Areas
 - 22.33a Qualifications
 - 22.33b Personal Protective Equipment
 - 22.33c Procedures
 - 22.33d Safety Practices
- 22.34 Trail Maintenance/Construction
 - 22.34a Standards
 - 22.34b Qualifications
 - 22.34c Personal Protective Equipment
 - 22.34d Safety Practices
- 22.35 Archeological Work Sites
 - 22.35a Standards
 - 22.35b Qualifications
 - 22.35c Personal Protective Equipment
 - 22.35d Procedures
 - 22.35e Safety Practices
- 22.36 Mountaineering
 - 22.36a Standards
 - 22.36b Qualifications
 - 22.36c Personal Protective Equipment
 - 22.36d Procedures
 - 22.36e Safety Practices
- 22.37 Caving
 - 22.37a Standards
 - 22.37b Qualifications
 - 22.37c Personal Protective Equipment
 - 22.37d Procedures
 - 22.37e Safety Practices

- 22.4 Forest Management
 - 22.41 Thinning and Girdling
 - 22.41a Qualifications
 - 22.41b Personal Protective Equipment
 - 22.41c Safety Practices
 - 22.42 Tree Pruning
 - 22.42a Qualifications
 - 22.42b Personal Protective Equipment
 - 22.42c Safety Practices
 - 22.43 Tree Planting
 - 22.43a Standards
 - 22.43b Qualifications
 - 22.43c Personal Protective Equipment
 - 22.43d Safety Practices
 - 22.44 Scaling
 - 22.44a Qualifications
 - 22.44b Personal Protective Equipment
 - 22.44c Procedures
 - 22.44d Safety Practices
 - 22.45 Mill Studies
 - 22.45a Standards
 - 22.45b Personal Protective Equipment
 - 22.45c Safety Practices
 - 22.46 Timber Sale Administration
 - 22.46a Standards
 - 22.46b Qualifications
 - 22.46c Personal Protective Equipment
 - 22.46d Procedures
 - 22.46e Safety Practices
 - 22.47 Timber Marking
 - 22.47a Standards
 - 22.47b Qualifications
 - 22.47c Personal Protective Equipment
 - 22.47d Procedures
 - 22.47e Safety Practices
 - 22.48 Chain Saw Operations
 - 22.48a Standards
 - 22.48b Qualifications
 - 22.48c Personal Protective Equipment
 - 22.48d Procedures

- 22.48e Safety Practices
- 22.48f Saw Handling Techniques
- 22.48g Felling, Bucking, and Limbing Techniques
- 22.48h Crosscut Saws
- 22.49 Tree Climbing
- 22.49a Standards
- 22.49b Qualifications
- 22.49c Personal Protective Equipment
- 22.49d Procedures
- 22.49e Safety Practices
- 22.5 Watershed and Air Management
- 22.51 Water Surveys
- 22.51a Qualifications
- 22.51b Personal Protective Equipment
- 22.51c Procedures
- 22.51d Safety Practices
- 22.52 Snow Surveys
- 22.52a Qualifications
- 22.52b Personal Protective Equipment
- 22.52c Safety Practices
- 22.53 Soil Surveys
- 22.53a Standards
- 22.53b Qualifications
- 22.53c Personal Protective Equipment
- 22.53d Safety Practices
- 22.6 Wildlife, Fish, and Sensitive Plant Management
- 22.61 Electrofishing
- 22.61a Qualifications
- 22.61b Personal Protective Equipment
- 22.61c Safety Practices
- 22.62 Diving
- 22.62a Standards
- 22.62b Qualifications
- 22.62c Procedures
- 22.62d Scientific Diving in Fisheries
- 22.63 Cavity Nesting Bird Work Projects and Activities
- 22.63a Qualifications
- 22.63b Personal Protective Equipment
- 22.63c Safety Practices
- 22.7 Special Uses [Reserved]

- 22.8 Minerals and Geology
- 22.81 Mine and Mineral Surveys
 - 22.81a Standards
 - 22.81b Qualifications
 - 22.81c Personal Protective Equipment
 - 22.81d Procedures
- 22.82 Oil and Gas Operations
 - 22.82a Qualifications
 - 22.82b Personal Protective Equipment
 - 22.82c Procedures

23 STATE AND PRIVATE FORESTRY [Reserved]

24 RESEARCH [Reserved]

25 PROTECTION AND DEVELOPMENT

- 25.01 Authority
- 25.06 References
- 25.07 Qualifications
- 25.08 Procedures
- 25.1 Fire
 - 25.11 Qualifications
 - 25.12 Personal Protective Equipment
 - 25.13 Wildland Firefighting
 - 25.13a Safety Practices
 - 25.13b Fatigue Factors
 - 25.13c After Work Activities Involving Swimming
 - 25.14 Prescribed Fire
 - 25.14a Qualifications
 - 25.14b Personal Protective Equipment
 - 25.14c Procedures
 - 25.14d Safety Practices
 - 25.14e Tractor Plow Use in Prescribed Fire
 - 25.14f All-Terrain Vehicle Use in Prescribed Fire
 - 25.14g Burning Out and Backfiring Operations
 - 25.14h Backfiring Equipment
 - 25.15 Brushing and Brush Piling
 - 25.15a Standards
 - 25.15b Personal Protective Equipment
 - 25.15c Procedures
 - 25.16 Vehicle Fires

- 25.16a Procedures
- 25.17 Boat Fires
- 25.2 Smokejumping
- 25.21 Helicopter Rappelling
- 25.3 Law Enforcement
- 25.31 Standards
- 25.32 Qualifications
- 25.33 Personal Protective Equipment
- 25.34 Safety Practices
- 25.35 Firearms
- 25.36 Search and Rescue
- 25.36a Authority and Responsibility
- 25.36b Procedures

26 MANAGEMENT SERVICES

- 26.07 Qualifications
- 26.08 Procedures
- 26.1 Personnel [Reserved]
- 26.2 Office Safety and Health
- 26.3 Procurement [Reserved]
- 26.4 Recycling
- 26.41 Qualifications
- 26.42 Personal Protective Equipment
- 26.43 Safety Practices
- 26.5 Finance and Accounting [Reserved]
- 26.6 Telecommunications
- 26.61 Standards
- 26.62 Tower/Pole Climbing
- 26.62a Qualifications
- 26.62b Personal Protective Equipment
- 26.62c Procedures
- 26.62d Safety Practices

27 ENGINEERING

- 27.01 Authority
- 27.1 Engineering Operations
- 27.11 Qualifications
- 27.12 Procedures
- 27.13 Surveying
- 27.13a Qualifications
- 27.13b Personal Protective Equipment

- 27.13c Safety Practices
- 27.14 Sign Installation/Maintenance
 - 27.14a Qualifications
 - 27.14b Personal Protective Equipment
 - 27.14c Procedures
 - 27.14d Safety Practices
- 27.15 Gravel Pit and Rock Quarry Operations
 - 27.15a Standards
 - 27.15b Qualifications
 - 27.15c Personal Protective Equipment
 - 27.15d Procedures
 - 27.15e Safety Practices
- 27.2 Buildings and Related Activities
 - 27.21 Carpentry
 - 27.21a Standards
 - 27.21b Qualifications
 - 27.21c Personal Protective Equipment
 - 27.21d Procedures
 - 27.21e Safety Practices
 - 27.22 Painting
 - 27.22a Standards
 - 27.22b Qualifications
 - 27.22c Personal Protective Equipment
 - 27.22d Procedures
 - 27.22e Safety Practices
 - 27.23 Welding and Cutting
 - 27.23a Standards
 - 27.23b Qualifications
 - 27.23c Personal Protective Equipment
 - 27.23d Procedures
 - 27.23e Safety Practices
 - 27.24 Demolition
 - 27.24a Standards
 - 27.24b Qualifications
 - 27.24c Personal Protective Equipment
 - 27.24d Procedures
 - 27.24e Safety Practices
 - 27.25 Trams
 - 27.25a Qualifications
 - 27.25b Personal Protective Equipment

- 27.25c Safety Practices
- 27.3 Public Health and Pollution Control
 - 27.31 Wastewater Treatment
 - 27.31a Standards
 - 27.31b Qualifications
 - 27.31c Personal Protective Equipment
 - 27.31d Procedures
 - 27.31e Safety Practices
 - 27.4 Water Storage and Transmission
 - 27.41 Dam Inspections
 - 27.41a Standards
 - 27.41b Qualifications
 - 27.41c Personal Protective Equipment
 - 27.41d Procedures
 - 27.41e Safety Practices
 - 27.5 Electrical [Reserved]
 - 27.6 Transportation
 - 27.61 Bridge Inspections
 - 27.61a Qualifications
 - 27.61b Personal Protective Equipment
 - 27.61c Procedures
 - 27.62 Road Maintenance
 - 27.62a Qualifications
 - 27.62b Personal Protective Equipment
 - 27.62c Procedures
 - 27.62d Safety Practices
 - 27.63 Clearing (Roadside and Land).
 - 27.63a Standards
 - 27.63b Personal Protective Equipment
 - 27.63c Safety Practices.
 - 27.63d Backpack Power Units
 - 27.63e Safety Practices

CHAPTER 20 – WORK PROJECTS AND ACTIVITIES

21 – GENERAL PROJECT PLANNING. This chapter provides general guidance for planning and accomplishing a variety of work projects and activities.

21.01 – Authority. The authority for Forest Service work projects and activities is Title 29, Code of Federal Regulations (29 CFR), Parts 1910, 1926, and 1960; 30 CFR Parts 1-199; 42 CFR Part 11; and 49 CFR Parts 1-199 and 301-399.

21.04 – Responsibility. Line officers and supervisors have the responsibility to:

1. Ensure the safety of both employees and the public.
2. Use the job hazard analysis (JHA) to document the level of experience and skill employees must possess to safely complete a specific work project or activity.
3. Analyze tools, equipment, and facility needs necessary for safe and healthful operations.
4. Require use of selected tools and personal protective equipment (PPE).
5. Select tools and personal protective equipment (PPE) to accommodate employee gender, size, and other special needs.

21.06 – References.

1. National Fire Protection Association. NFPA 1977: Protective Clothing and Equipment for Wildland Fire Fighting. Quincy, MA.
2. U.S. Department of Transportation, Federal Highway Administration. Manual on Uniform Traffic Control Devices. U.S. Government Printing Office, Washington, DC.

21.1 – Job Hazard Analysis. The JHA is developed to ensure safety and health by clearly assigning responsibility and accountability to employees, first-line supervisors, and line officers. Prepare a JHA for all work projects and activities. In the JHA, identify the worksite, name(s) of the employee(s) writing the JHA and the name of the approving line officer, and the date the JHA was devel-

oped. The supervisor shall document in the JHA that employees have read and understand the contents, have received the required training, and are qualified to perform the job (sec. 71).

21.11 – Qualifications. Specific qualifications are required for many work projects and activities. Examples are:

1. First Aid/Cardiopulmonary Resuscitation (CPR) Training.
2. Incident Command System Training.
3. Chain Saw Operation.
4. Hazardous Communication Training (Right-to-Know).
5. Motorized Heavy Equipment and Vehicle Endorsements/
Licenses.
6. Firearm Certification.
7. Blaster Certification.
8. Mountain Bicycling.
9. Pesticide Use and Application Training/Certification.
10. Forest Protection Officer Certification (law enforcement).

21.12 – Training. Before beginning any work project or activity, train employees in the basic safety and health precautions they need to follow. For example, refer field-going employees to section 55.11a for water supply information.

Ensure employees have a working knowledge of the tools, devices, and PPE they will use, the hazards to be faced, and defenses against those hazards. Never assume employees have the necessary training and experience. Refer to 29 CFR 1926.21, 29 CFR 1960.59, and section 52 of this Handbook for further direction.

It is essential that global positioning system (GPS) training be provided to field-going employees prior to GPS utilization (refer to the Glossary).

All field-going employees doing strenuous work should perform stretching and other warm-up exercises appropriate to the work project or activity.

21.13 – Personal Protective Equipment.

21.13a – General Requirements. For general requirements on PPE, refer to 29 CFR 1910.132. Follow these safety and health practices for selecting, training, using, and maintaining PPE.

1. Select PPE (such as color of Forest Service-approved hardhats) based on the hazards identified in the JHA.
 - a. PPE shall fit properly.
 - b. Defective, damaged, or unsanitary PPE shall not be used.
 - c. Supervisors shall be responsible to assure the adequacy (as well as proper maintenance and sanitation) of employee-owned equipment.
2. Train each employee to wear the PPE required by the JHA. Training shall include:
 - a. What PPE is necessary, and when and where it should be worn.
 - b. How to properly put on, adjust, wear, and remove PPE.
 - c. Proper care, maintenance, useful life, limitations, and disposal of PPE.
3. Before performing any work project or activity requiring or recommending PPE, ensure that employees can demonstrate an understanding of their training. Employees are accountable for accidents and injuries that result from not using or misusing required PPE.
4. Provide additional training as necessary. Circumstances in which supervisors should provide additional training include:
 - a. Workplace changes that make earlier training obsolete.
 - b. Changes in the PPE to be used.
 - c. Evidence that an employee's knowledge or use of PPE is not adequate.

21.13b – Specific Requirements. Section 72, exhibit 01 identifies PPE required, approved, and furnished by the agency without local JHA justification. Before starting a work project or activity, check the appropriate chapter of this Handbook for additional PPE requirements.

1. **Occupational Eye and Face Protection.** Ensure that employees wear appropriate eye and/or face protection (including side protection) when exposed to eye or face hazards such as flying particles, molten metal, liquid chemicals, acids or caustic liquids, chemical gases or vapors, or potentially injurious light radiation. These stipulations apply to employees and to visitors while they are in hazardous areas. Eye wear retention devices, such as elastic straps for goggles or for eyeglasses, are recommended. For specific requirements, refer to 29 CFR 1910.133. Eye protection shall meet the standards of ANSI Z87 (latest edition).

2. **Occupational Noise Exposure.** Provide protection against the effects of noise when the exposure for an 8-hour time-weighted average (TWA) measured on the A scale of a standard sound-level meter at slow response is 85 decibels or above. For specific requirements, refer to 29 CFR 1910.95.

When employees are subjected to sounds exceeding those listed in exhibit 01, institute administrative or engineering controls to reduce noise levels to acceptable levels. Where such controls are not practical (for example, in some field work situations) or fail to meet noise standards, provide and use PPE.

Implement hearing conservation programs in workplaces where employee noise exposure equals or exceeds an 8-hour time-weighted average (TWA) of 85 decibels.

In this program, include employee hearing tests (audiograms) that shall serve as baseline data for interpreting the results of future hearing tests. After obtaining the baseline audiogram, test affected employees annually.

21.13b – Exhibit 01 – Permissible Noise Exposure

| <i>Duration per Day-Hours</i> | <i>Sound Level dBA Slow Response</i> |
|-----------------------------------|--|
| 8 | 85 |
| 8 | 90 |
| 6 | 92 |
| 4 | 95 |
| 3 | 97 |
| 2 | 100 |
| 1-1/2 | 102 |
| 1 | 105 |
| 1/2 | 110 |
| 1/4 or less | 115 |

Units shall keep a current list of employees exposed to noise levels that exceed those in exhibit 01. Include these employees in all aspects of the hearing conservation program.

Provide and explain audiogram results to tested employees and maintain results in their medical folders (29 CFR 1910.95).

Provide a variety of suitable hearing protection devices and ensure that employees wear the devices in designated high noise areas.

Inform employees of:

- a. The effects of noise on hearing.
- b. The advantages, disadvantages, and attenuation of various types of protectors as well as instructions on selection, fitting, use, and care.

3. **Respiratory Protection.** Do not assign employees tasks requiring respirator use unless they are physically able to perform the work and can use the equipment properly. For specific requirements, refer to 29 CFR 1910.134.

- a. Include standard operating procedures in the JHA for selecting and using respirators.
- b. Select respirators on the basis of hazards to which the employee is exposed; refer to 42 CFR Part 84 for requirements.
- c. Instruct employees in the proper use, fit, maintenance, and storage of respirators and their limitations.
- d. Ensure that employees attend required hazard communication training when they have a potential exposure risk to a hazardous chemical under normal conditions of use or in a foreseeable emergency.
- e. Ensure that respirators are National Institute of Safety and Health (NIOSH) certified.
- f. Regularly inspect clean, disinfect, and store respirators in a convenient, clean, and sanitary location. Replace worn or deteriorated parts.
- g. Monitor work area conditions and the degree of employee exposure or stress levels.

4. **Occupational Head Protection.** Employees shall wear appropriate head protection when working where there is potential for head injuries. Ensure that hardhat/helmet protection is Forest

Service-approved and that the hardhats are made from material having a melting point of 350 °F (177 °C) or higher. For general and specific requirements, refer to 29 CFR 1910.132, 1910.135 and NFPA 1977 (sec. 21.06).

Inspect shells daily for dents, cracks, penetration, or any other damage that might compromise protection. Also inspect daily the suspension systems, headbands, sweatbands, and any accessories.

Follow manufacturer's recommended cleaning practices.

5. **Occupational Hand Protection.** Document the need for hand protection in the JHA. Ensure that the type of protection selected protects employees from the specific hazards identified. For specific requirements, refer to 29 CFR 1910.138.

6. **Occupational Foot Protection.** Employees shall wear protective footwear when working where there is a danger of foot injuries due to falling or rolling objects, objects piercing the soles of footwear, and electrical hazards.

Many different types of footwear are available. Section 72, exhibit 01 identifies foot protection required for specific projects or activities. In the site-specific JHA, identify foot protection necessary that is not covered in exhibit 01 (FSM 6716.03).

Supervisors must provide direction to employees as to which type of foot protection is best suited for their particular project or activity (sec. 18.2). Ensure that safety-toed footwear meets the latest ANSI Z41 and ANSI Z41.1 standards. For specific requirements, refer to 29 CFR 1910.136.

21.14 – Procedures. By review and signature approval of the JHA, a line officer or other competent person must approve and document the assignment of employees to work alone. If there is a significant potential hazard to a lone worker, assign additional personnel.

Discuss the approved JHA with employees before they start the job. Specifically:

1. Prepare instructions for each work project or activity not covered in other applicable documents.
2. Include methods to ensure public safety and health.
3. Correct recognized hazards before beginning work projects and activities.
4. Identify hazards that cannot be corrected. Inform all involved personnel as an initial abatement action of the hazards. Do not allow performance of work projects and activities having unacceptable risks.
5. Where hazardous chemicals/materials may be encountered, provide the applicable Material Safety Data Sheet (MSDS) and discuss the implications of the work with all employees.
6. Develop emergency evacuation procedures and pinpoint individual responsibilities for implementation.
7. Conduct and document tailgate sessions as needed. Tier the sessions to the JHA to provide more specific project/task safety concerns and requirements.

21.2 – First Aid Training/Minimum.

21.21 – First Aid and Cardiopulmonary Resuscitation (CPR).

Each field crew and office group shall have at least one person currently certified by a nationally recognized organization to render first aid and perform CPR (29 CFR 1910.151, 1910.1030, and 1926.50). Supervisors shall ensure that employees receive training or retraining in first aid and CPR before certifications expire. Refer to section 52.3 for direction on the bloodborne pathogens program.

21.22 – First Aid Equipment. Ensure that first aid/body fluid barrier kits (also referred to as a first aid kit) are available at each work site, whether in the field or office (refer to the Glossary).

1. Train one or more persons to render first aid, including CPR.
2. Ensure that a competent person checks first aid supplies and equipment at regular intervals and restocks as needed, paying particular attention to those items with expiration dates.

3. Select first aid supplies for the worksite based on the remoteness from medical facilities and anticipated types of injuries that can occur. For sites with chain saw operations, as a minimum, supply Type IV (belt) first aid kit(s).

4. Where employees may be exposed to injurious corrosive materials, provide facilities for quick flushing of the eyes at the work area. Maintain all eyewash stations in accordance with ANSI Z358.1 and inspect them per the manufacturer's instructions. Conduct frequent inspection and maintenance of squeeze bottles since they lose water through evaporation, become contaminated, and are easily misplaced (sec. 61.25 para. 4).

21.3 – Safety Practices. Discuss the JHA with involved employees and address safety concerns for the site-specific work project or activity.

21.31 – Hunting Season. Hunting season presents its own unique situations such as back road travel, fire-arm safety, camping restrictions, and road closures.

1. Post signs near work sites to warn hunters of crew and employee locations. Post "No Shooting" signs for administrative sites and public use areas, such as campgrounds and trailheads, located in hunting areas.

2. Wear hunter's orange vests.

3. Reschedule jobs to allow crews to safely work away from hunters when possible.

22 – RESOURCE MANAGEMENT. This section offers direction and safety guidelines for employees engaged in a variety of work projects and activities focused on managing National Forest System lands.

22.01 – Authority. For further direction on safety and health practices and requirements related to management of resources see FSM 2300, Recreation, Wilderness, and Related Resource Management; FSM 2350, Trail, River, and Similar Recreation Opportunities; FSM 2400, Timber Management; FSM 2807, Certification for Mineral Examiners; FSM 2883.4, Geologic Hazard Evaluation; FSM

7410, Administration; FSM 7421, Water Supply; FSM 2150, Pesticide Use, Management, and Coordination; chapter 30 of FSH 2109.14, Pesticide-use Management and Coordination Handbook; and Title 36, Code of Federal Regulations (36 CFR), Part 219.

22.06 – References.

1. Gempler's, Inc. 1994. Reference Guide for EPA's Worker Protection Standard. Mt. Horeb, WI.
2. Haskins, Roger A., Eugene Carlat, and Frederic B. Mullin. 1989. Field Handbook for Mineral Examiners. H-3890-1. Washington, DC: Department of the Interior, Bureau of Land Management.
3. Herrero, Stephen. 1985. Bear Attacks: Their Causes and Avoidance. Nick Lyons Books.
4. Hoshide, Gary T., and W. J. Makel. U.S. Department of Agriculture, Forest Service. 1995. Cleaning Recreation Sites. San Dimas, CA: San Dimas Technology and Development Center, Forest Service.
5. Reiner, Jeff. Lake Tahoe Basin Management Unit. 1999. Diving Management and Safety Manual. U.S. Department of Agriculture, Forest Service. U.S. Government Printing Office, Washington, DC.
6. Taylor, William E. and Robert G. Hooper. 1991. A Modification of Copeyon's Drilling Technique for Making Artificial Red-Cockaded Woodpecker Cavities. General Technical Report SE-72. Asheville, NC: U.S. Department of Agriculture, Forest Service. Southern Research Station.
7. U.S. Department of Agriculture, Forest Service. 1996. National Tree Climbing Field Guide. Missoula, MT: Missoula Technology and Development Center, Forest Service.
8. U.S. Department of Agriculture, Forest Service. Wildfire Powersaw. Training course S-212.
9. U.S. Department of Agriculture, Forest Service. 1984. Standard Specifications for Construction of Trails. EM-7720-102. Washington, DC: Forest Service.

22.07 – Qualifications. In addition to applicable training and certification listed in section 21.11, ensure that employees involved in resource management activities are trained in or familiar with:

1. Identification of hantavirus symptoms and preventive/precautionary measures (sec. 53.73a).
2. Use of body fluids protection items.
3. Identification and management of potentially hazardous animal behavior (sec. 22.06).
4. Use of chemical agents for self-defense.
5. Use of firearms for personal protection from aggressive animals.
6. Handling/disposal methods for hazardous materials.

22.08 – Procedures. Employees and their supervisor shall prepare a job hazard analysis (JHA) (sec. 21.1) that includes:

1. An itinerary of planned travel route(s), date of travel, destination, and estimated time of departure/arrival.
2. Check-out/check-in system.
3. Names of employees.
4. Emergency phone numbers/communication system and contact points.
5. Other information pertinent to the project or activity. Some requirements for the JHA that are available in other documents, such as a district or project safety and health plan, may be included by reference.

If employees fail to report or return on schedule, the supervisor shall take actions required by the JHA.

22.1 – Environmental.

22.11 – Pesticide Application. (FSM 2150, FSH 2109.14). Pesticides include insecticides, fungicides, herbicides, rodenticides, attractants, repellents, and wood preservatives. Application projects may involve ground or aerial activity (sec. 61.32b and 61.7).

22.11a – Qualifications. Employees working with pesticides shall be trained and have experience in the specific work project or activity (sec. 22.07). Personnel involved in restricted-use pesticide applications shall be licensed or certified by the Forest Service, Environmental Protection Agency (EPA), State, and local jurisdiction.

22.11b – Personal Protective Equipment. Employees involved in pesticide work shall use the personal protective equipment (PPE) specified by the product label, material safety data sheet (MSDS), and JHA. Refer to direction in sections 21.13 and 21.22 for identifying PPE in the JHA. The minimum PPE requirements for pesticide application are:

1. **First Aid Kits.** Have them readily available to all workers (refer to the Glossary).
2. **Hand Protection.** Wear gloves impervious to pesticides. Ensure washing facilities are available for employees at application site.
3. **Eye/Face Protection.** Wear goggles, safety glasses with side shields, or face shields at all times when handling pesticide containers, and when mixing, loading, or applying pesticides. Ensure that permanent or portable eye wash facilities are available on site when mixing and loading pesticides.
4. **Head/Hearing Protection.** Wear Forest Service-approved hardhats. Use hearing protection when operating power equipment (85 dB or above).
5. **Respirator.** Wear the respirator identified by the pesticide/product label, MSDS, or JHA (sec. 21.13). Train employees in respirator use (sec. 21.13).
6. **Rubberized Protective Equipment.** Wear rubberized protective equipment when it is specified on the pesticide/product label, MSDS, or JHA. Wearing waterproof socks and skin barrier cream to provide additional protection from chemical herbicides is recommended.
7. **Chemical-Resistant Garments.** Use chemical-resistant, disposable coveralls (temperature permitting) and waterproof, lower

leg protection (for spraying on hot days) to prevent chemical herbicide absorption through clothing.

22.11c – Procedures.

1. The project leader may appoint an employee to oversee the safety and health aspects of the pesticide application project or activity.
2. The supervisor shall ensure that material safety data sheets (MSDSs) and the manufacturer's product labels are available for all pesticides on every project. Discuss the MSDSs and explain any specific risks to the mixer, loader, and applicator(s). Post MSDSs where they can be easily read.
3. Before application, assign individual employees specific responsibilities to be carried out should an employee be contaminated or injured by pesticides. Detail an emergency response plan in the JHA. The first step in such a plan is to contact a physician immediately with the following information:
 - a. Nature of the victim's exposure and how the pesticide was used.
 - b. Product name, EPA registration number, and active ingredients.
 - c. First aid and medical information from product label.

22.11d – Safety Practices. Whenever pesticides are used, accident, injury, and illness prevention becomes every involved person's responsibility.

1. **General Applications.** Apply pesticides so that they do not endanger humans, livestock, crops, beneficial insects, fish, and wildlife. Standard general requirements for pesticide application are:
 - a. Do not apply pesticides when there is danger of wind drift that may contaminate water or non-targeted areas.
 - (1) If pesticides contact bare skin, wash those areas thoroughly. Follow manufacturer's direction for cleaning.
 - (2) Always wear a long-sleeved shirt with sleeves rolled down.

- (3) Cover your neck by wearing a bandana and turning up collar.
 - (4) Keep pant legs rolled down over ankles and boot tops.
 - (5) Change to clean clothes after each workday. Machine wash work clothes separately from other clothing after each workday. Use heavy-duty detergent and hot water. Run the machine through at least one additional wash cycle without clothes, using detergent and hot water, to clean the machine.
- b. Follow instructions on the pesticide/product label and in the MSDS and JHA.
 - c. Allow only trained and authorized persons in the mixing/loading area and near pesticides.
 - d. Inform workers of restricted entry intervals (REI). Do not allow entry into treated areas when REI applies. Post restricted entry notices at boundary of treatment area.
 - e. Dispose of pesticide container(s) in an authorized land-fill, according to directions on the label (sec. 61.71c).

2. **Aerial Applications.**

- a. Never permit Forest Service personnel to fly in any aircraft applying pesticides.
- b. Keep unnecessary personnel out of the pesticide drop zones and provide for public safety.
- c. Keep personnel at least 200 feet (61 m) from powerlines during aerial application.
- d. Never stand under poles, towers, or wires during application drops.

22.12 – Aircraft Calibration for Pesticide Application. Forest Service personnel shall inspect aircraft spray systems to ensure proper calibration and characterization of contract aircraft. Calibration may require work with both fixed-wing and rotary aircraft while engines are running and rotors are moving to measure the flow rate.

22.12a – Safety Practices.

1. Hold a safety and health session (tailgate or classroom) for all personnel involved before inspecting the aircraft spray system.

2. Brief the pilot before beginning calibration and stay within the pilot's view when doing the work.

22.2 – Range.

22.21 – Qualifications. In addition to applicable training and certification listed in section 22.07, provide training in horsemanship to employees routinely involved in range activities using horses (sec. 16). Also provide employees with training to handle special equipment. Monitor their progress to ensure employees achieve a level of proficiency needed to safely perform assigned tasks.

22.22 – Fencing.

22.22a – Personal Protective Equipment. Address specific PPE for each work project or activity in the JHA. Use the following general PPE required for fencing operations:

1. **Eye/Face Protection.** Wear safety goggles, safety glasses (with wrap-around or side shields), or face shield when working with wire and when driving nails or staples.
2. **Head/Hearing Protection.** Wear Forest Service-approved hardhats and hearing protection when operating power equipment (85 dB and above).
3. **First Aid Kit.** Have kit readily available (refer to the Glossary).
4. **Hand Protection.** Wear heavy-duty, cut-resistant, gauntlet-type gloves.
5. **Foot Protection.** Wear high-top cut-resistant (or leather), lace up work boots with nonskid soles (FSM 6716.03 and sec. 16.3).
6. **Clothing.** Wear long pants and long-sleeved shirts.

22.22b – Safety Practices. Steps for safe fencing operations are:

1. **Electrical Storms.** Suspend all fencing operations during electrical (lightning) storms or when powerlines may be down.
2. **Crossing Fence Lines.** Place hand-carried objects on the other side of the fence before you cross.

3. **Posts.**

- a. **Post Driving.** Use a post driver for driving metal posts.
- (1) Inspect the post driver before each work project or activity and periodically during use.
 - (2) Put the driver over the post while the post is in a leaning position, then swing the post upright into position. Do not attempt to put the driver over a tall upright post.
 - (3) When driving, use short strokes and do not operate the driver faster than you can maintain control.

4. **Wood Fences.** Do not store treated wood in enclosed spaces. Avoid contacting treated wood with bare skin.

5. **Wire Fences.** Always use caution when constructing fence. When possible, avoid installing fences under powerlines or near buried lines. Use properly maintained tools and equipment and use them only for the purpose designed.

- a. **Handling wire.** Be aware of wire “memory”! Firmly wrap or hook the end of wire to a fixed object when unrolling the wire from a spool. Use spool rollers with side guards to prevent side lash. Keep the wire spool level and unroll wire straight off the roll, not off the side.
- (1) When handling wire, always assign at least two persons to fencing projects.
 - (2) Wire can break under tension. To avoid whiplash and/or backlash, stay alert and safely positioned. Be aware of sloped terrain and maintain sound footing.
 - (3) When cutting wire, secure it on both sides of the pliers or cutting tool to prevent backlash. If necessary to ensure personal safety, have two people to cut the wire.
 - (4) When driving staples, do not place arms or legs over or under the wire to steady a fence post. Keep the wire close to your hand on the fence post.
 - (5) Wire can easily be severed. Do not drive staples hard enough to damage the galvanized coating on the wire.

b. Stretching wire.

- (1) When working with wire, always consider the gauge of the wire. Inspect the wire for nicks, weak spots, and splices. Repair the wire before stretching it. Remove and splice stressed kinks before the wire is stretched.
- (2) Roll up the wire slack slowly so kinks do not develop. Use a hammer or fence pliers to hold the wire in place while attaching weights, stapling, or releasing the wire from obstacles.
- (3) When releasing wire from obstacles, stay on the side of the fence post that is opposite the wire. Be aware of wire recoil.

6. **Electric Fences.** Address the need for signing electric fence during the environmental analysis of a project area. Assess existing fence for the need to sign fencing commensurate with public use and the implied potential liability. Make sure the electric fence energizer has its own separate grounding rod. Never permit more than one energizer to be connected to the same electric fence.

- a. Disconnect the feed wires of an electric fence during installation or repairs.
- b. When testing fence, wear rubber gloves, rubber soled shoes, and the appropriate Forest Service-approved hardhat.
- c. Keep all metallic implements away from electric fences.
- d. Do not tether livestock with chains near electric fences.
- e. Avoid accumulations of groundwater or moisture near electric fences.

7. **Clean Up.** Pick up all cut ends of wire, dropped staples, nails, and other debris after completing any fencing job.

22.3 – Recreation.

22.31 – Qualifications. In addition to applicable training and certification listed in section 22.07, employees involved in recreation-related activities shall receive training in or be familiar with:

1. Risk management.
2. Handling/disposal methods for hazardous materials associated with campgrounds and recreation facilities.

Employees involved in posting signs for recreational areas should be familiar with all signing requirements and regulations (sec. 22.06).

22.31a – Personal Protective Equipment. After considering all factors, such as anticipated activities, project location, and weather, identify required PPE in the JHA (sec. 21.13 and 21.22).

22.31b – Procedures. Safety inspect recreation sites annually prior to each season. Conduct monthly follow-up safety inspections during use. Take corrective actions and maintain documentation.

Prepare and discuss the JHA with employees for all recreation work projects or activities (sec. 22.08).

22.31c – Safety Practices. The following are basic safety and health practices for recreation-related activities:

1. Train employees to recognize existing and potential hazards, and abate them where possible. When abatement is not possible, the following actions may be taken:
 - a. Use interpretive programs and/or maps and brochures to alert the public to the hazard.
 - b. Post warning signs or notices.
 - c. Install physical barriers.
 - d. Use signs to restrict specific types of use, and/or the season of use, or close the site to the public.
2. Post safety rules for specific sites or activities.
3. Ensure that proper maintenance is scheduled.
4. Develop or require concession operators to prepare and implement safety and health operation plans.

22.32 – Administration of Developed Sites.

22.32a – Standards. The standards for occupational exposure to blood or other potentially infectious materials are in 29 CFR 1910.1030.

22.32b – Qualifications. In addition to ensuring applicable training and certification listed in section 22.07, train and certify employees in the use of specific mechanized equipment.

22.32c – Personal Protective Equipment. After considering all factors, such as specific activity, project location, and weather, identify required PPE in the JHA (sec. 21.13 and 21.22).

22.32d – Procedures. Make material safety data sheets (MSDSs) available, and discuss them with employees. Properly label containers to identify contents.

22.32e – Safety Practices. Follow basic safety and health practices for the administration of developed sites.

1. Monitor public water facilities in accordance with all Forest Service requirements, and Federal, State, and local regulations when applicable (sec. 22.06).

2. Have appropriate trash receptacles for the site and follow proper sanitation methods to eliminate conditions favorable to disease-spreading insects and rodents, to minimize obnoxious odors, and to prevent pollution of water supplies (sec. 55.11a and 55.11c).

3. Read product labels and follow instructions for safe use of cleaning products. Keep product labels on cleaning products to ensure that first aid information will be immediately available if needed (sec. 22.06).

4. Keep open flames out of areas where methane gas might tend to accumulate. Keep battery-operated systems well ventilated to prevent hydrogen gas build-up (sec. 22.06). Comply with requirements on confined spaces (sec. 38.2).

5. Treat all animals as potentially dangerous. Assess each situation and proceed with caution.

6. Identify all existing and potential hazards. Establish and maintain signs and/or other safety and health measures for hazards that cannot be eliminated.

7. Refer to section 52.3 for direction about bloodborne pathogens.

8. Refer to section 27.31 for direction about wastewater treatment.

22.33 – Administration of Undeveloped Areas.

22.33a – Qualifications. Train and certify employees in the applicable subject areas as listed in section 22.07. Survival training is required where and when warranted.

22.33b – Personal Protective Equipment. Identify required PPE in the JHA (sec. 21.13 and 21.22).

22.33c – Procedures. Develop an emergency backup plan for situations where radio communication is not possible.

22.33d – Safety Practices. Basic safety and health practices for working in undeveloped areas are:

1. Review general project planning procedures in section 21.14.
2. When assigned to work projects or activities, be prepared for unforeseen complications that could prevent scheduled transportation arrangements. Employees shall have survival equipment for an extra 48 hours.
3. Maintain visual, voice, or radio contact with each other at all times when and where the work environment warrants.
4. To prevent animal/human problems, maintain proper sanitation and follow required food storage and handling procedures (sec. 22.06).
5. Report unusual/unexpected evidence concerning animal or human activity to the proper authorities.
6. Treat all animals as potentially dangerous. Assess each situation and proceed with caution (sec. 53).

22.34 – Trail Maintenance/Construction.

22.34a – Standards. The standards for trail operations, maintenance, and construction are in the regulations at 36 CFR Parts 212 and 261.

22.34b – Qualifications. In addition to providing applicable training and certification listed in section 22.07, train employees in:

1. The use and care of appropriate hand and power tools and equipment required for each project.
2. Back-country travel/camping techniques following leave no trace principles (sec. 11.2 and 18).
3. Livestock handling, if required (sec. 16).
4. The use of motorized equipment, such as trail bikes and all-terrain vehicles (ATVs) (sec. 13.2).

22.34c – Personal Protective Equipment.

1. Forest Service-approved hardhat or helmet.
2. Gloves.
3. Nonskid boots. Material and height of boot shall be determined by the specific tool or tools to be used.
4. Eye protection.
5. Hearing protection (85 dB and above). For chain saw operation, refer to section 22.48c.

22.34d – Safety Practices. Basic safety and health practices for trail-maintenance work are:

1. Identify, communicate, and avoid hazards, both project related and environmental. When conditions significantly change, conduct an on-site safety session and adapt work tactics as necessary.
2. When changing from routine work to specialized project areas such as blasting, tree felling, or skidding, conduct a task-specific safety and health tailgate session. Emphasize safe and healthful practices, assignments, and high risks. The JHA should address in detail these specialized project areas.

22.35 – Archeological Work Sites.

22.35a – Standards. The standards for archeological work sites are in 29 CFR 1926.650 and Part 296.

22.35b – Qualifications. In addition to providing the applicable training and certification listed in section 22.07, train employees in handtool use.

22.35c – Personal Protective Equipment. The following PPE is required for archaeological work:

1. First aid kit (refer to the Glossary).
2. Gloves and eye protection.
3. Personal communications device (minimum of one).
4. Additional PPE as identified in the JHA.

22.35d – Procedures. Include in the JHA:

1. Description of work area.
2. Requirements of Federal, State, and local regulations.
3. Information about local hazards.
4. Known animal problems.
5. Special concerns:
 - a. Weather: Thunderstorms (lightning, flash flooding), sun, wind.
 - b. Health: Topics including, but not limited to, dust inhalation from sifting soil, back injuries from lifting heavy equipment, skin irritations from soil fungi, hazardous waste exposure associated with mining sites, altitude sickness, hypothermia, hantavirus, snakes, and insects.
 - c. Caves: Refer to section 22.37 for direction on caving.

22.35e – Safety Practices. The crew should begin each work day with a tailgate safety and health session.

22.36 – Mountaineering. Participation in resource management, public safety, and visitor information activities may require employees to engage in rock, snow, ice, or mixed environment climbing.

22.36a – Standards. The standards for selection criteria of mountaineering equipment are in American National Standards Institute (ANSI) Standard A10.14.

22.36b – Qualifications. In addition to providing the applicable training listed in section 22.07, ensure that inexperienced employees receive prior training in climbing and are accompanied by competent climbers. Determine competency based on employees' demonstrated proficiency.

1. Employees must receive training designed for the specific environment of the climb. The hazards of each environment are different; therefore the needed equipment and techniques may also differ.

2. Employees shall meet all physical requirements as determined by the JHA.

22.36c – Personal Protective Equipment. In the JHA, identify what PPE is required for the specific environment and activity. Where applicable, ensure that equipment meets ANSI or OSHA requirements, whichever is stricter. Required PPE may include:

1. Appropriate footwear.
2. Properly fitted climbing helmet (Union Internationale des Associations D'Alpinisme (UIAA) approved).
3. Climbing chest and seat harness.
4. Climbing ropes.
5. Appropriate hardware for anchoring, descending/ascending rope, and belaying protection.
6. Emergency gear, such as first aid kit, headlamps, signal flares/mirrors, and fire starter device.
7. Appropriate communication system, such as a two-way radio, a cellular phone, or signal devices.
8. Clothing for various climatic conditions and site-specific considerations.

22.36d – Procedures. Adequate planning and knowledge of safety and health practices are required for mountaineering activities.

1. Develop a project safety and health plan from the JHA to address the specific needs of the particular job site and climatic conditions.

2. Conduct a daily on-site safety and health session before climbing. Discuss all factors, including environmental hazards, that might affect the day's work, such as inclement weather, rock/ice fall, avalanche, and impending darkness.

3. Inspect climbing equipment before each climb.

4. Establish a communication system and make sure everyone understands it and what is expected of them.

5. ***Do not permit solo climbing (climbing alone with safety equipment) except by individuals competent in the technique who are capable of using extreme caution.*** Documented prior approval by the appropriate line officer is required.

22.36e – Safety Practices. In most cases, the climbing party shall consist of a minimum of two qualified climbers.

1. After every climb, conduct a debriefing. Review the safety aspects of the climb and inspect all equipment for repairs or replacement.

2. Store climbing ropes in a cool, dry, dark place (direct sunlight rapidly deteriorates rope fibers). Untie all knots before storage, and never hang a rope over a nail, small diameter peg, or hook. Ideally, rope should be coiled and stored in a tightly closed rope bag.

3. Maintain a written history on each rope: date purchased, type, date placed in service, and a complete usage record (where, when, how, inspection date, and comments).

4. Damage to climbing equipment (especially ropes and slings) may occur without showing visual evidence. Always follow the manufacturer's replacement guidelines. Immediately take out of service ropes that sustain severe shock from a fall. Whenever there is uncertainty about a rope's condition, take it out of service.

22.37 – Caving.

22.37a – Standards. The standards for the selection criteria of caving equipment are in American National Standards Institute (ANSI) Standard A10.14.

22.37b – Qualifications. In addition to providing applicable training listed in section 22.07, train employees in caving and mountaineering techniques. Teach and practice techniques on the surface under the supervision of a qualified instructor. Caving organizations, such as the National Speleological Society, can help identify local training opportunities and assist with other cave management needs. Ensure that employees receive training about special safety gear for caves.

22.37c – Personal Protective Equipment. In the JHA, identify what PPE is required for cave-related activities. Where applicable, equipment shall meet ANSI or OSHA requirements, whichever is stricter. Required PPE may include:

1. First aid kit (refer to the Glossary).
2. Food and drinking water.
3. Gloves.
4. Climbing helmet with a non-elastic chin strap.
5. Electric or carbide headlamp.
6. Two additional light sources, extra bulbs, and batteries.
(Each member of the party shall carry a total of three dependable light sources.)
7. Pack with no external protrusions for transporting equipment.
8. Appropriate communication system, such as a cellular phone.
9. Appropriate clothing for the specific cave environment:
 - a. **Warm, dry caves.** Lightweight clothing.
 - b. **Cold caves.** Coveralls and layered clothing.
 - c. **Wet caves.** Waterproof coveralls or drysuits.
10. Appropriate boots.
11. Additional PPE as identified in the JHA.

22.37d – Procedures. Prepare and discuss the JHA with all members of the cave exploration party for specific caving activities and before entering any cave (sec. 22.08).

22.37e – Safety Practices.

1. General.

- a. Never jump across openings or down drops since a fall can lead to serious injury. Distances underground are hard to judge and are often greater than they appear.
- b. When climbing, always maintain three points of contact with the rock, moving only one hand or one foot at a time.
- c. Prior to initial entry into a wild cave, assess the cave in accordance with OSHA's permit-required confined space program requirements (sec. 38.2).

2. Cave Exploration Party.

- a. The party leader shall consider the experience and capabilities of individuals when selecting members for the cave exploration party.
- b. The party leader shall keep the party together while moving through the cave. Solo exploration is not permitted.
- c. The party leader shall ensure that a belay is provided when necessary. Use fixed lines or belays in exposed areas, using appropriate cave climbing techniques and equipment.
- d. If the cave requires technical climbing, the party shall consist of at least four members, two of whom are qualified technical rock climbers. In case of injury, one member shall stay with the victim, while two go for help.
- e. In a cave where the use of climbing equipment is not necessary, a party of three is acceptable.

3. Weather.

- a. Caves subject to flooding, such as those in canyon bottoms and in run-off pits, shall not be visited during periods of heavy precipitation or unsettled weather.
- b. In the winter ice often forms on cliffs and in cave entrances. In the spring or during periods of warming, ice masses can detach and fall without warning. Cavers

shall avoid walking beneath ice masses and crossing winter snow that has blown into and plugged the tops of pits.

4. **Biological Hazards.**

- a. When entering caves, be aware of hazards associated with insects, reptiles, and mammals (sec. 53).
- b. When traveling through dusty areas within caves, wear dust masks. In desert areas and warm climates, cave dust can act as a vector for histoplasmosis, a serious lung ailment.

5. **Gases and Oxygen Deficient Atmospheres.**

- a. Determine that any wild cave designated for entry by employees is safe by assessing the air quality and abating any hazardous condition as identified in the JHA.
- b. Regularly test and monitor for radon and other gas levels in commercialized caves. Establish safe and healthful working levels (time spent in the cave) and ensure adherence by employees.

Radon is not a hazard to persons who infrequently visit caves; it is a health hazard for people exposed to high concentrations over long periods of time. It is only necessary to monitor caves where employees are required to work underground for hundreds of hours each year.

A naturally occurring colorless and odorless radioactive gas, radon is a by-product of decaying radioactive minerals. Radon is found in nearly all basements, homes, and caves.

- (1) Monitoring radon and establishing safe working levels should be done with the assistance of a knowledgeable industrial hygienist.
- (2) Radon concentrations vary widely from region to region and between caves due to factors such as rock composition, degree of natural ventilation, and season. As a result, monitoring programs should include air testing every month for at least 2 years to establish safe working levels.

- c. Carbon dioxide is a colorless, odorless gas, occasionally found in caves, which may reduce oxygen levels at the bottoms of pits or near stumps where it is produced by the biological decomposition of organic material, such as wood or leaves, which are washed into caves by floods. Carbon dioxide, in lethal concentration, is extremely rare and may never be encountered by a caver. Being heavier than air, carbon dioxide can concentrate in invisible pools near the floor or in depressions where it displaces air and reduces the availability of oxygen. Be aware of situations where organic material has collected in areas of poor air circulation. At any sign of reduced oxygen (dimming of carbide lamp flames and candles or rapid breathing) leave the area immediately by moving upslope.

22.4 – Forest Management.

1. **Qualifications.** In addition to providing the applicable training and certification listed in section 22.07, employees involved in timber-related activities shall be trained to recognize and abate associated hazards.

22.41 – Thinning and Girdling.

22.41a – Qualifications. Train employees in the use of tools needed for specific projects and work activities. Refer to sections 22.48, 41, and 43.

22.41b – Personal Protective Equipment. The following PPE is required for thinning and girdling:

1. Forest Service-approved hardhat.
2. Gloves.
3. Eye protection.
4. First aid kit (refer to the Glossary).
5. Nonskid boots. Material and height of boot shall be determined by the specific tool or tools to be used.

For chain saw-specific PPE requirements, refer to section 22.48c.

22.41c – Safety Practices. Basic safety and health practices for thinning and girdling include:

1. Keep members of a thinning crew separated by at least 2-1/2 times the height of the tallest tree being felled.
2. Be constantly alert for whiplash tops or chain kickback.
3. Refer to sections 22.48 and 52.4 for specific requirements and safety practices.

22.42 – Tree Pruning.

22.42a – Qualifications. Employees shall be trained in the use of handtools as needed (sec. 41). Tree climbing training is required for all employees who climb trees (sec. 22.49).

22.42b – Personal Protective Equipment. The following PPE is required for pruning:

1. Forest Service-approved hardhat.
2. Hearing protection (85 dB and above).
3. Eye or face protection.
4. Gloves.
5. First aid kit (refer to the Glossary).
6. Nonskid boots. Choose boots in a material and height appropriate to the specific tool or tools to be used.

For chain saw-specific PPE requirements, refer to section 22.48c.

22.42c – Safety Practices. Basic safety and health practices for pruning are:

1. Always carry pole pruners with saw pointing forward.
2. Keep workers apart by at least 1-1/2 pole pruner lengths.
3. Never stand directly under limbs being pruned. Stand up-wind to avoid wind-blown sawdust.
4. Regularly check saw bolts for tightness.

5. When pruning, always cut branches, do not break them. Notch larger diameter branches from below before through cutting from top to avoid breakage.

6. Suspend pruning during electrical (lightning) storms.

7. ***Never use metal pole pruners when working within 100 feet (31 m) of powerlines. Use only wooden or fiberglass poles within this 100-foot range. Perform no work within 30 feet (9 m) of powerlines.***

8. Sheathe cutting edges when transporting or storing pruning saws.

9. When not in use, lay tools on the ground where they are not a tripping hazard.

22.43 – Tree Planting.

22.43a – Standards. The standard for PPE selection is in 29 CFR 1910.132. The standard for use of material handling equipment is in 29 CFR 1926.602.

22.43b – Qualifications. Employees shall be trained in the use of hand and mechanized tools (sec. 41 and 43).

22.43c – Personal Protective Equipment. The following PPE is required:

1. **Handling Chemically Treated Trees.** Forest Service-approved hardhat, eye protection, nonskid boots, impervious gloves, water, soap, and towels.

2. **Hand Planting.** Forest Service-approved hardhat, eye protection, nonskid boots, and gloves.

3. **Auger Planting.** Forest Service-approved hardhat, safety goggles or glasses, hearing protection (85 dB and above), nonskid boots, and gloves.

4. **Machine Planting.**

a. **General.** Forest Service-approved hardhat, eye protection, hearing protection (85 dB and above), and gloves. Foot guards on machine that completely cover the bottom and sides of feet.

- b. **Tractor Planting-Machine.** Protected rearview mirror, shovel, axe, and fire extinguisher.
5. First aid kit (refer to the Glossary).
 6. Other PPE as identified in the JHA (sec. 22.48c).

22.43d – Safety Practices. Refer to section 53 for information on plant and animal hazards and section 52.4 for ergonomic concerns. Basic safety and health practices for tree planting are:

1. **Hand Planting.**
 - a. Be aware of overhanging hazards.
 - b. Avoid tool glance.
 - c. Maintain planting tools.
 - d. Be aware of the dangers of rolling logs and rocks.
 - e. Work in staggered lines.
 - f. Identify an escape route (pre-planned, safest, quickest route to avoid a hazard) if needed.
2. **Handling Chemically Treated Trees.** Follow instructions on the label and MSDS.
3. **Auger Planting.**
 - a. Make sure the auger has a “kill” switch or throttle-release mechanism to prevent runaways. Use only those augers so equipped.
 - b. Before drilling, attempt to check for roots, rocks, clay pockets, and slash that might bind bits.
 - c. Keep equipment in optimum operating condition.
 - d. Be alert and prepared for binding when drilling each hole. Get help to retrieve the bit when it does bind.
 - e. Continually check the condition of operators and rotate hourly.
 - f. Maintain a safe working distance between crew members. Stagger crew positions on slopes.
 - g. Stop the engine when taking breaks and when moving between job areas and planting sites.
 - h. Refer to the manufacturer's instructions for additional safety information.
 - i. When refueling, refer to the MSDS for instructions on flammables/combustibles, such as gasoline.

- (1) Stop and cool the engine at least 5 minutes before refueling.
- (2) Select bare ground for refueling spots. Store fuel in approved containers on shaded bare ground where possible. For fuel transportation requirements, refer to section 12.5.

4. **Machine Planting.**

- a. Check foot guards for damage before each shift.
- b. Attach a heavy screen guard to the planter to protect the operator in heavy brush. Keep the rear of the machine unguarded so the operator can get out quickly in an emergency.
- c. Do not run a machine through areas of logs or heavy brush.
- d. Provide a safety device like a buzzer, an ignition cutoff switch, or drawbar release for machine operators. Use a prearranged stop signal that is understood by both operators.
- e. Watch for sticks, logs, or brush that may poke up through openings in the machine.
- f. Confine the power unit to limited degree turns to prevent tipping.
- g. If you must plant behind the planting machine, stay at least 100 feet (31 m) back.

22.44 – Scaling. Scaling is the measurement of logs for merchantable volume. It is a high-risk activity generally performed in an industrial setting, often close to heavy equipment, and in various environmental conditions.

22.44a – Qualifications. Employees shall receive safety instructions for each scaling assignment.

22.44b – Personal Protective Equipment. The following PPE is required for scaling:

1. **All Scaling.**
 - a. First aid kit (refer to the Glossary).
 - b. Forest Service-approved hardhat and high-visibility vest.
 - c. Eye protection.

- d. Nonskid boots. For direction on boots and other clothing, see FSM 6716.03 – Condition of Hire. Refer to the JHA to determine when calk boots are appropriate.
- e. Hearing protection (85 dB and above).
- f. Other PPE as identified in the JHA (sec. 22.48c).

22.44c – Procedures. Forest product scaling covers a variety of methods and locations and is performed by scalers, check scalers, and sale administrators. In the JHA, include the relevant scaling methods, location, and specific job assignments of employees (sec. 22.08).

22.44d – Safety Practices.

1. **General. *Notify all woods workers when and where scaling will be conducted. Never depend on others for your personal safety.***
 - a. Be aware of changing conditions that create new hazards.
 - b. Keep scaling areas clear of non-essential people. Never engage in horseplay.
 - c. Maintain scaling tools and equipment in optimum condition.
 - d. Permit night scaling only on landings or scaling platforms that are adequately lighted. Lighting is considered adequate when shadows do not obscure hazards normal to the scaling operation.
 - e. In the woods or during truck scaling, as soon as scaling is completed, move to a safety zone to make notations in the scalebook.
2. **Scaling in Woods and Landings.**
 - a. Stay clear for each turn of logs until chokers are clear and skidding equipment is out of the way. Ensure logs have stopped rolling and sliding and are secured. Never scale on landings where logs are being moved if there is a danger of a roll or slippage.
 - b. Keep the scaling area clear of debris and unused rigging that may be snagged or rolled during the landing operation.
 - c. Be alert for and keep away from running lines, moving chokers, swinging logs, rigging, jammers, or cranes in operation.

- d. **Never walk between a truck and a loading operation.**
- e. Never turn your back on a moving truck. Stay clear of the loaded truck as it leaves the landing.
- f. Move to a safety zone when not actually scaling. Safety zones are usually toward the front of the landing, away from turnarounds, swinging lines, and the loading/decking activity.
- g. If possible, arrange to scale at least one landing behind the active landing site.

3. **Scaling on Trucks.**

- a. **Scale on trucks only after all logs are bound by chains or cables, and never scale during the loading operation.**
- b. Never allow binder adjustments while scaling.
- c. Scale a loaded truck only when the vehicle is stopped, with brakes set, and the vehicle engine is turned off. (Diesel trucks may idle, provided wheels are chocked and brakes are set.)
- d. Use a standard scaling ramp equipped with platform catwalks or safety ladders. Provide tail and front boards where they are usable and will add to scaler's safety. Most falling accidents have occurred while descending from a load; never jump from the wing log to the platform or ground.
 - (1) If a fully equipped scale ramp or platform is not available, then use a safety ladder when climbing or descending the load. The ladder must be equipped with a nonskid base and extend a minimum of 3 feet (1 m) above the wing log. Refer to section 33.1 for further direction.
 - (2) Avoid falls by being constantly alert for loose or wet bark, knots, limbs, binder chains, and slick spots on logs.
- e. Be aware of unguarded exhaust stacks and mud or ice build up on truck frames.

4. **Millyard Scaling.**

- a. Make your presence known to millyard workers.
- b. Be alert to millyard hazards while walking to and from your vehicle.

- c. Scale logs only if they are presented in an orderly, safe fashion:
- (1) The scaling area must be large enough to accommodate the amount of volume to be delivered. There should be adequate load separation between skids, and individual logs should be spread evenly on the ground to facilitate accurate scaling. Scaling bays should be located a safe distance from unloading areas, mill in feed, or decking operations. To avoid the possibility of rolling logs, never place scaling bays in front of log decks.
 - (2) Logs shall be well spread out on solid ground or skids not exceeding 14 inches (1/3 m) in height. Do not scale logs jackstrawed in bays or otherwise improperly spread (refer to the Glossary).
 - (3) Stop scaling and move to a safety zone if machinery becomes active in the scaling area.
 - (4) Stand clear when logs are being handled in adjacent scaling bays. Be aware of logs interlaced between scaling bays that may be moved or rolled.
 - (5) Keep one hand on your log measuring tape while retracting to control speed. Avoid edges that could cut.
 - (6) Do not carry calipers hooked over any part of your body.

22.45 – Mill Studies.

22.45a – Standards. The standards for housekeeping, PPE, and compressed air (used for cleaning) are in 29 CFR 1910.22, 1910.132, and 1910.242.

22.45b – Personal Protective Equipment. The following PPE is required for mill studies:

1. First aid kit (refer to the Glossary).
2. Hearing protection (85 dB and above).
3. Eye protection, Forest Service-approved hardhat, and high-visibility vest.
4. Nonskid boots.

5. Other PPE as identified in the JHA.

22.45c – Safety Practices. The following are basic safety and health practices for mill studies:

1. Be familiar with and obey company rules, and requirements on use of PPE.
2. Be aware of hazards posed by moving equipment and materials. Use extreme caution when passing close by moving machinery.
3. Never walk or run under suspended loads.
4. When required to cross a flow of materials, never step on powered rolls, belts, or chains.
5. Never use air under pressure for blowing dust from clothes or body.
6. Be aware of housekeeping and maintenance hazards.

22.46 – Timber Sale Administration.

22.46a – Standards. The standards for logging operations are in 29 CFR 1910.266.

22.46b – Qualifications. Employees shall be competent and qualified to administer contracts. They shall be familiar with multiple operations, road conditions, landmarks, safety signing, traffic and equipment locations and movements, and radio communications being used.

22.46c – Personal Protective Equipment. The following PPE is required for timber sale administration:

1. First aid kit (refer to the Glossary).
2. Forest Service-approved hardhat and nonskid boots.
3. High-visibility vest.
4. Other PPE as identified in the JHA.

22.46d – Procedures.

1. ***Notify loggers when you are working in the area.***

2. If you observe unsafe acts or operations, notify the purchaser through the proper delegated authorities under the timber sale contract. Document this notification.

22.46e – Safety Practices. Basic safety and health practices include:

1. **General.**

- a. Be alert for changing weather, falling trees, snags, hang-ups, rolling logs, and trees that have been notched and partially cut.
- b. Stay away from the sides of loaded logging trucks. Approach and count logs from the end of the load.
- c. Maintain a safe distance from moving equipment and ensure the operator sees you before approaching equipment.
- d. Do not stand on any downed tree that could be struck by a skidded log or could roll downhill.
- e. Always approach sawyers from above. Locate them and be sure they see you. Always wait for them to complete a cut.
- f. ***Never stand in any loop (bight) of a line or in line with a cable under tension.***
- g. If you must cross an active line in a cable logging operation, cross under the line at a place protected by a stump or draw; know the signals being used.
- h. Do not stand in front of any cable anchoring device, including stumps, rock bolts, and deadmen.
- i. Never walk below an active skid road or downhill cable logging operation.

2. **Landing Safety.**

- a. Keep your vehicle off the landing.
- b. When loading is in progress, never cross the landing until the loader operator has given the signal.
- c. Observe landing operations a few minutes before approaching.
- d. Be aware of all landing hazards.
 - (1) Watch for the swing of the counterweight from loaders and swingboom yarders. Never walk through a pinch point (the area between the coun-

terweight and the cutbank) while a swingboom yarder is operating.

- (2) Never conduct business on landings. Move to a safety zone.
- (3) Never walk past a loaded logging truck while the binders are being thrown.
- (4) Never walk on or immediately downhill of unstable log decks. Snow covered logs in decks are especially dangerous.

3. **Helicopter Logging Operations.**

- a. Never enter a drop zone until the helicopter is on the ground.
- b. Do not enter helicopter flight paths. Wear head, eye, and hearing protection when near helicopter operations. Rotor downwash can break branches, dislodge loose materials, and stir up a large amount of dust and debris.
 - (1) Never approach a helicopter until the rotors have stopped.
 - (2) Always approach a helicopter where the pilot has you in view.
 - (3) Wait for the pilot to give the signal to approach.
 - (4) Leave in the same direction, keeping your head low.

22.47 – Timber Marking.

22.47a – Standards. The standards for flammable/combustible liquids are in 29 CFR 1910.106.

22.47b – Qualifications. Ensure that employees receive basic safety and health training specific to their work responsibilities.

Topics covered shall include use of PPE, such as respirators, interpretation of MSDS, and application of safe and healthful work methods and practices.

22.47c – Personal Protective Equipment. Identify required PPE in the JHA after considering the specific work project or activity, location, and weather (sec. 21.13 and 21.22).

1. **Timber Marking PPE.**
 - a. First aid kit (refer to the Glossary).
 - b. Appropriate respirator.

- c. Vest (high-visibility during hunting season).
 - d. Eye protection.
 - e. Forest Service-approved hardhat.
 - f. Nonskid boots with sufficient ankle support. For direction on boots and other clothing, see FSM 6716.03, Condition of Hire.
 - g. Gloves.
 - h. Long-sleeved shirt.
2. **Solvent-Handling PPE.**
 - a. Apron.
 - b. Chemical-resistant rubber gloves.
 - c. Eye and face protection.
 - d. Long-sleeved shirt.

22.47d – Procedures.

1. Hold periodic tailgate safety and health sessions for the crew. This is a joint responsibility of the crew leader and crewmembers.
2. Obtain copies of the specifications and MSDS for the paint to be used. Refer to section 61.1 for further direction.

22.47e – Safety Practices. Basic safety and health practices are:

1. **Timber Marking Operation.**
 - a. Use only Forest Service-approved tree marking paint procured by the General Services Administration.
 - b. Transport solvent, paint, guns, and other equipment in a cargo area suitable for transporting flammable/combustible liquids and secured to prevent movement (sec. 12.5). Prevent vapors, such as from a leaking paint can, from reaching the passenger compartment. Do not store timber marking supplies and equipment with personal gear.
 - c. Be aware of changing wind conditions and direction to avoid spray when applying paint.
 - d. Make available and use hand cleaner, soap, and water before eating or drinking.
 - e. Keep paint and solvent away from food and drink.

2. **Solvent-Handling Activities.**

- a. In enclosed areas, use an appropriate and approved respirator.
- b. Wear PPE when cleaning and drying paint cans.
- c. Dispose of paint containers and remnants using the method identified in the JHA.
 - (1) Use approved can puncturers.
 - (2) Store paint and solvent-soaked rags in an approved flammable/combustible container and dispose of daily.
- d. Use hand cleaner, followed by soap and water, which is generally sufficient for cleanup.

22.48 – Chain Saw Operations. Chain saw operations include, but are not limited to, felling, bucking, brushing, limbing, and specialized uses. Individual chain saw operators have the obligation to say “NO” and walk away from any situation they determine to be an unacceptable risk. Complete a JHA for chain saw related work projects and activities (sec. 22.08).

22.48a – Standards. The standards for noise exposure, explosives, PPE, hand and portable powered tools, logging operations, first aid training, and hazard communication are in 29 CFR 1910.95, 1910.109, 1910.132, 1910.151, 1910.242, 1910.266, 1910.1030, and 1910.1200; and 1926.50, 1926.52, 1926.100 – 1926.102, 1926.301, and 1926.302.

22.48b – Qualifications.

1. In addition to having the applicable training and certifications listed in sections 22.07 and 22.48a, all saw operators shall be currently certified by a nationally recognized organization to render first aid and perform cardiopulmonary resuscitation (CPR). Supervisors shall ensure that saw operators receive training or retraining in first aid and CPR before certifications expire. Refer to section 52.3 for direction on the bloodborne pathogens program.

2. Every unit at the Region, Station, Area, and Institute level that utilizes crosscut saws and chain saws shall develop an approved crosscut/chain saw program that includes the following minimum requirements for employees involved in crosscut/chain saw work projects and activities:

- a. Classroom and field training encompassing in part or in total a national training program, such as Wildfire Power Saws S-212 (sec. 22.06).
 - b. Demonstration of sawing ability (to a certified operator or certified instructor) in functional areas.
 - c. Supervision by a certified instructor or certified operator of saw work by new operators.
3. The Regions, Stations, Area, and Institute shall appoint a crosscut/chain saw Program Coordinator. As a minimum the Program Coordinator shall:
- a. Possess current knowledge of policy and regulations pertaining to crosscut/chain saws and related equipment.
 - b. Be trained and certified to evaluate and certify or recertify saw instructors.
 - c. Be certified at the highest level of operator proficiency.
4. Sawyers must maintain national certification cards indicating their proficiency levels as follows:
- a. **“A” apprentice sawyer.** These sawyers have completed the nationally approved classroom and field training for general saw work (such as bucking, limbing, and the first basic steps in felling) or specialized uses (such as construction, maintenance, and fencing). Generally, they are trained at the local unit and must be supervised by a B or C level sawyer during saw work activity, which may include slashing and felling in the least complex situations. This certification expires 3 years after the date of issue. The certifier has full authority to impose restrictions on apprentice sawyers as deemed necessary.
 - b. **“B” intermediate sawyer.** This level includes skilled saw operators capable of performing only those tasks as approved by a certifier and documented on the back of the certification card. During saw activities, intermediate sawyers are not allowed to field certify sawyers. Certification is restricted to “C” advanced sawyers and “C” certifiers. This certification expires 3 years from the date of issue. The certifier has full authority to impose restrictions on intermediate sawyers as deemed necessary.

- c. **“C” advanced sawyer.** At this level of proficiency, advanced sawyers are approved to handle complex sawing and felling operations, including fireline construction. They are qualified to conduct classroom and field training at the “A,” “B,” and “C” level. They are also allowed to field certify “A” and “B” level sawyers. They are not allowed to field certify at the “C” level; this certification is restricted to “C” sawyer certifiers. This certification expires 3 years from the date of issue.
- d. **“C” sawyer certification.** The “C” sawyer certification level includes individuals who are currently “C” advanced sawyers and have been further trained through a formal Regional program to organize and conduct field certification sessions. They have demonstrated communication skills, the ability to transfer and relate concepts to others, and current knowledge of policy and regulations pertaining to saws and related equipment. This certification expires 3 years from the date of issue.

22.48c – Personal Protective Equipment. Maintain PPE in a clean and fully functional condition. The following PPE is required for chain saw operations:

1. Forest Service-approved hardhat.
2. Eye protection.
3. Hearing protection (85 dB and above).
4. Appropriate gloves (cut-resistant gloves for chain filing).
5. Long-sleeved shirt.
6. Chain saw chaps. The chain saw chaps shall meet the requirements of Forest Service Specification 6170-4; it is recommended that they overlap boots a minimum of 2 inches (51 mm).
7. Heavy-duty, cut-resistant or leather, waterproof or water-repellent, 8-inch high (204 mm) laced boots with nonskid soles (hard toes are optional). For further direction refer to FSM 6716.03, Personal Protective Equipment (Condition of Hire) Policy.
8. Fire shelter (wildfire and prescribed burn assignments).

9. Required chain saw features:
 - a. Throttle interlock.
 - b. Falling and bucking spikes (or dogs) for falling and bucking operations (full set of two). Note: There are exceptions for specialized non-felling uses.
 - c. Anti-vibration system.
 - d. Chain brake, fully functional.
 - e. Proper saw for the job, fully operational. A full wrap-around handle bar for felling operations is recommended. The full wraparound handlebar allows the operator to use the bottom of the bar from either side of the tree; the saw then cuts, pulling the chain and the spikes into the tree. When using the top of the bar, the saw has the potential to kick out of the cut, which causes the operator to put extra effort into holding the saw. This creates fatigue and takes attention away from other safety concerns associated with tree felling. Three-quarter handlebars are allowed for bucking and limbing only.
 - f. ***Proper bar length for the specific work project or activity.***
 - g. Bow bars with top and bottom chain guards and stingers.
 - h. Chain, filed and maintained.
10. General equipment.
 - a. First aid kit (refer to the Glossary).
 - b. Fire extinguisher.
 - c. Chain saw wrench.
 - d. Chain file with handle and guard.
 - e. Approved safety container for fuel.
 - f. Chain and bar oil container, clearly marked.
 - g. Proper wedges for the specific work project or activity (wooden wedges are not permitted).
 - h. Single-bit axe or maul, 3 to 5 pounds (1 to 2 kg).

22.48d – Procedures. Chain saw and crosscut saw operations are skill related and must be “hands-on-taught” and learned. To teach new employees and maintain operator proficiency, provide cutting areas for training to meet national saw training requirements.

1. Supervisors shall monitor proficiency of sawyers to recognize the need for recertification in less than 3 years in cases where employees have not used a chain saw enough to retain a safe skill level.

2. Instructors have complete authority to limit the scope of the certification and can impose restrictions such as specific project, specific function, size limitations, and species.

3. Standard procedures include:

- a. Ensure that personnel are alert and physically capable before allowing them to operate a saw.
- b. Ensure that tailgate safety and health sessions address saw safety before beginning work projects or activities. Refer to section 52.4 for ergonomic concerns.
- c. Include in the JHA: Spacing, leap frogging, and communications.
 - (1) Space employees and organize their duties so that the actions of one do not create hazards for others.
 - (2) When a danger tree is identified, it must be physically marked and no work can be conducted within the safety zone (2-1/2 tree lengths of the danger tree).
- d. Follow the manufacturer's safety, operation, and maintenance recommendations for the specific chain saw to be used on work project or activity.
- e. Ensure that trainee sawyers are under the supervision of a certified sawyer until they have demonstrated the ability to handle the saw independently and proficiently.

Refer to sections 12.2 and 12.5 for further direction on equipment requirements for vehicles and for transporting saws. Refer to sections 41, 43, and 44 for direction on requirements for handtools, power-operated tools, and heavy equipment.

22.48e – Safety Practices. Follow these basic safety and health practices:

1. **No felling at night.**
2. **Situational Awareness and Size Up.** Analyze the felling job by considering:

- a. Location of people, structures, powerlines, other obstacles.
- b. Roads and travel in the cutting area.
- c. Topography and steepness of ground.
- d. Nearby hazards such as trees, low-hanging and dead limbs, rocks, and brush.
- e. **Primary and secondary escape routes, safety zones, and alternates.**
- f. **Wind direction and velocity such as steady versus gusting and/or changing directions.**
- g. Tree species, both live and dead.
- h. Diameter and height of trees.
- i. **Soundness of tree: split, lightning struck, broken-off top, rot, deterioration or physical damage to the root system, trunk, stem, limbs, or bark.**
- j. Lean direction.
- k. Limb distribution.
- l. **Widowmakers.**
- m. **Spiked top and/or schoolmarm.**
- n. **Burning top.**
- o. Moisture in the form of rain, snow, or ice.

3. **Primary and Secondary Escape Routes, Safety Zones, and Alternates.** Escape routes are predetermined paths along which the sawyer proceeds once the tree is committed to the fall or to the bucking cut. Sawyers must select and prepare the work area by clearing a primary escape path and an alternate path before starting the cut.

- a. ***In tree felling operations, the quadrant opposite the planned fall of the tree is one of the most dangerous. Choose an escape path that extends diagonally away from the expected felling line and always have an alternate retreat path to a safety zone.***
- b. ***Walk out and thoroughly check the intended lay or bed of the tree. Look for dead tree tops, missing tree tops, widowmakers, snags, and ground debris that may cause kickbacks, rolling, or result in another tree or limb becoming a hazard.***
- c. ***Plan the route from the stump to the safety zone, generally not less than 20 feet (6 m) away; the farther the distance the better (ex. 01).***

22.48e – Exhibit 01 – Primary and Secondary Escape Routes, Safety Zones, and Alternates

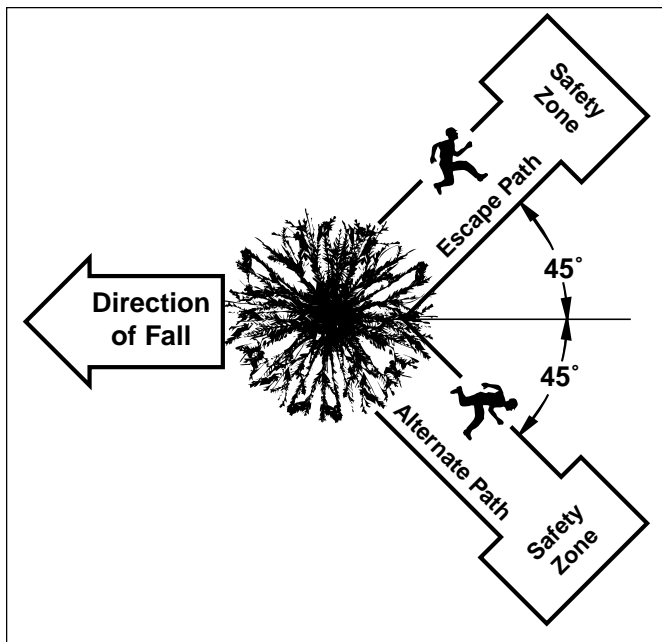

- d. *If possible, stand behind another tree, preferably quartering back from the planned direction of fall. Wait and watch for at least 30 seconds after the tree hits the ground for the whiplash branches and other broken tree parts. The shielding tree should be sound and of sufficient size to give protection.*

22.48f – Saw Handling Techniques. General saw handling techniques include:

1. **Carrying Saw:**
 - a. Carry the saw in a way to prevent contact with the chain, muffler, or bucking spikes.

- b. Point the bar forward when going downhill with the saw at your side.
- c. Point the bar backward when going uphill with the saw at your side.
- d. When carrying a saw on your shoulder, take extra care due to the sharpness of the chain and “dogs” (refer to the Glossary). Wear a long-sleeved shirt, gloves, and a shoulder pad. Cover the bar and chain. Use of a manufactured bar and chain guard is recommended.
 - (1) Set the saw at idle speed and activate the chain brake when carrying a saw for short distances.
 - (2) Shut off the saw when carrying it for a distance greater than from tree to tree or in hazardous conditions, such as slippery surfaces or heavy underbrush, and, in all cases, when carrying it more than 50 feet (15 m).

2. **Starting/Operating Saw.** The methods to safely start and operate a saw can vary with the model and size. The following basic precautions generally apply regardless of the saw model:

- a. ***Maintain a secure grip on the saw at all times.***
- b. Always start the saw with the chain brake engaged.
- c. Start the saw on the ground or where otherwise firmly supported.
- d. Do not “drop start” a chain saw.
- e. In general, throttle up to full speed before letting the chain contact the wood.
- f. In general, do not throttle down before the cut has been completed.
- g. Avoid cutting with the power head positioned between the waist and shoulders, which is considered a danger zone.
- h. ***Do not cut with the power head positioned above shoulder height.***

3. **Fueling Saw.** Select an area with bare ground for storing fuel and oil.

- a. Allow the saw to cool at least 5 minutes before refueling.
 - (1) Fill the tank on bare ground or other noncombustible surface.
 - (2) Immediately clean up spilled fuel.

- b. Refuel outdoors and at least 20 feet (6 m) from an open flame or other sources of ignition.
- c. Start the saw at least 10 feet (3 m) from the fueling area.

22.48g – Felling, Bucking, and Limbing Techniques. Use the following techniques to help ensure safety:

1. **Observers and Spotters.**

- a. The project supervisor and the sawyer shall determine jointly if spotters are needed during tree felling operations.
- b. ***No employee shall approach a faller closer than 2-1/2 tree lengths of trees being felled until the faller has acknowledged that it is safe to do so, unless it is demonstrated that a team of employees is necessary to manually fell a particular tree.***

2. **Obscured Vision. *Felling trees or snags is prohibited if the tops and surrounding area (the distance of 2-1/2 times the height of the tree to be felled in a viewing radius of 360°) are obscured by darkness, fog, smoke, or other condition.*** Do not allow felling, wedging, or hand pushing standing or leaning trees or snags when inadequate light impairs visual inspection of the hazard and the immediate work area.

3. **Weather.** Never start or continue to work during high winds, electrical storms, or in other hazardous weather.

4. **Escape Paths. *Before felling or bucking any tree or snag, always provide for escape in emergencies. Establish firm footing.***

- a. Determine the lean of the tree using equipment, such as a straight handled hatchet, axe, or plumb bob, and recheck the primary and secondary escape routes and alternates.
- b. ***As tree lift begins, check the direction the tree is falling. Proceed along the predetermined escape path to your safety zone. Keep alert for falling debris and kickback.***

5. **Roadways, Trails, and Firelines.** Ensure that adequate traffic control measures, such as signs, vehicles, or personnel, are taken when felling or bucking across or alongside any traveled

route. Maintain 2-1/2 tree lengths of distance between faller and all of the above.

6. **Powerlines.** If a tree to be cut is near a powerline, have the electrical utility authorities de-energize the line. Keep personnel clear until electrical utility authorities advise it is safe to proceed (sec. 36.13).

7. **Other Workers.** *Make sure the felling never endangers nearby workers. Space employees and organize the duties of each employee so that the actions of one employee do not create a hazard for any other employee.*

- a. *Do not allow workers not in the felling crew to get closer than 2-1/2 tree lengths of the trees being felled.*
- b. *Have workers and felling crews working on the same contour, rather than some working above others on steep hillsides.*
- c. Always watch the top of the tree throughout the felling operation.
- d. Before starting a back cut, shut the saw off and shout a warning to nearby crews.
- e. Before completing a cut, stop cutting, idle the saw, and shout warnings twice (or use a mechanical signal device, whistles, or horns) to warn nearby crews that a tree is about to fall.
 - (1) Make sure everyone is clear.
 - (2) Complete the cut in the prescribed manner.

8. **Felling.** Follow these basic steps when felling:

- a. Fell problem trees or snags first.
- b. Undercut all trees exceeding 5 inches (127 mm) diameter at breast height (dbh) before making a backcut.
- c. Inspect your tree for a dead top, loose bark, limbs, and other debris leaning or hanging into it. Using a hatchet or axe, sound completely around the trunk of any large trees to check for rot (refer to the Glossary).
- d. *Watch out for other trees and tops that may fall in an undetermined direction when hit by a falling tree.*
- e. Undercut and backcut all trees at a safe standing height.
- f. Never trust holding wood in partly rotted trees.

- g. Do not make any side cuts or corner cuts in hollow trees or trees with heartrot unless an adequate hinge can be maintained.
 - h. Make the proper face/undercut with the opening large enough to control the tree nearly to the ground.
 - (1) Make the downhill or off cut first.
 - i. **Begin the backcut by inserting wedges into the kerf as soon as practical** (refer to the Glossary).
 - (1) **Continue cutting until the desired amount of wood holds the tree.**
 - (2) **Ensure that sloping/horizontal cuts do not cross one another.**
 - j. Never leave a tree partially cut. Always finish the felling job before leaving for break, lunch, or at the end of the day or shift, with the exception that where hazards are unusually significant, leave trees standing, ribbon the area with hazard tree or danger area tape, or a suitable substitute, and notify your immediate supervisor.
 - k. **Never climb a lodged tree. Notify nearby workers and your immediate supervisor of the hazard.**
 - (1) **Whenever possible, pull the lodged tree down by tractor, winch, or other mechanical means.**
 - (2) **Consider all options—including marking the hazard and walking away from it.**
 - l. Before returning to work on the felled tree, check all snags and adjacent trees for broken limbs, log chunks, loose bark, and overhead hazards.
9. **Bucking, Brushing, and Limbing.** Follow these basic steps:
- a. Never buck a tree that is considered unusually dangerous.
 - b. Consider bucking hazards, including overhead hazards.
 - c. Anticipate the log's reaction when it is severed.
 - d. Select the bucking cut location very carefully.
 - e. Beware of other logs, branches, or rocks immediately behind the area where you are bucking, brushing, or limbing for possible kickback potential or rocking of the chain.
 - (1) Remember that touching any object with the tip of the chain and bar can cause a kickback.
 - (2) Know where the tip of the bar is at all times.

- f. Remove limbs and brush before bucking.
- g. When topping, brushing, or limbing, be cautious about any tree held off the ground by its branches.
- h. To prevent rolling, do not cut limbs or branches that support the tree off the ground.
- i. Walk on top of large downed logs while limbing (if possible) to prevent a log from rolling onto the operator.
- j. Be aware of side, top, bottom, and internal bind due to natural unevenness of the ground and objects, such as stumps, windfalls, and rocks. Initiate bucking slowly. Observe kerf closely to determine the bind.
- k. Cut a sapling or branch that is bound down only when it is necessary for safety. Make a series of small cuts on the decompressed side of the sapling or branch to release the bind.
- l. Use wedges to prevent pinching bar.
- m. Completely saw off log chunks.
- n. ***When trees on sloping ground are bucked, use blocking devices that prevent bucked sections from rolling or sliding. Always work from the uphill side.***
- o. Buck windfalls only after examining each tree to be cut for strains, breaks, binds, and the chance of root wads falling, rolling, or setting upright when the weight of the tree is removed. Be aware of trees that are underneath the one you are bucking as they may be under pressure and could move in any direction when the overhead weight is cut or removed.

22.48h – Crosscut Saws. Crosscut saw operation has historically been part of Forest Service work projects and activities. The qualifications stated in section 22.48b shall also apply for crosscut operators.

1. **Personal Protective Equipment.** The following PPE is required for crosscut saw operations:
 - a. First aid kit (refer to the Glossary).
 - b. Forest Service-approved hardhat.
 - c. Eye protection.
 - d. Heavy-duty, cut-resistant or leather, waterproof or water-repellent, 8 inch high (204 mm) laced boots with nonskid soles (hard toes are optional). For further direction, refer

to FSM 6716.03, Personal Protective Equipment (Condition of Hire) Policy.

- e. Appropriate gloves.
- f. Chain saw chaps (optional). If chain saw chaps are worn, they shall meet the requirements of Forest Service Specification 6170-4.

2. **Safety Practices.**

- a. **Storage.** For storage of crosscut saws, provide an area specifically designed for easy access. Store crosscut saws straight, sheathed if possible, with teeth guarded.
- b. **Ground Transport.** For ground transport of crosscut saws, comply with the following:
 - (1) **Vehicle.** Guard teeth (sheath or box) and secure them from movement. Do not carry a crosscut saw in the passenger compartment of a vehicle.
 - (2) **Livestock.** When transporting a crosscut saw on a pack animal, take extra care. Adequately guard and secure the saw.
 - (a) Select the most gentle animal to carry the saw and place that animal at the front of the pack string.
 - (b) Ensure that short saws are carried sheathed, guarded, or in a scabbard, and are positioned in a manner so that the action of removing the saw is away from the animal's head.
 - (c) Ensure that long saws are sheathed. Bend a saw into a horseshoe shape over an adequate sized load. Secure the saw to the center of the pack saddle with teeth facing the rear of the animal (ex. 01).
 - (d) Ensure screws are tightened in the handle of the saw.
 - (e) Monitor the pack animal to ensure the saw and load remain secured in place.
- c. **Air Transport.** For air transport of cross cut saws, comply with the following:
 - (1) **Fixed Wing Aircraft.**
 - (a) Properly sheathe the saw.

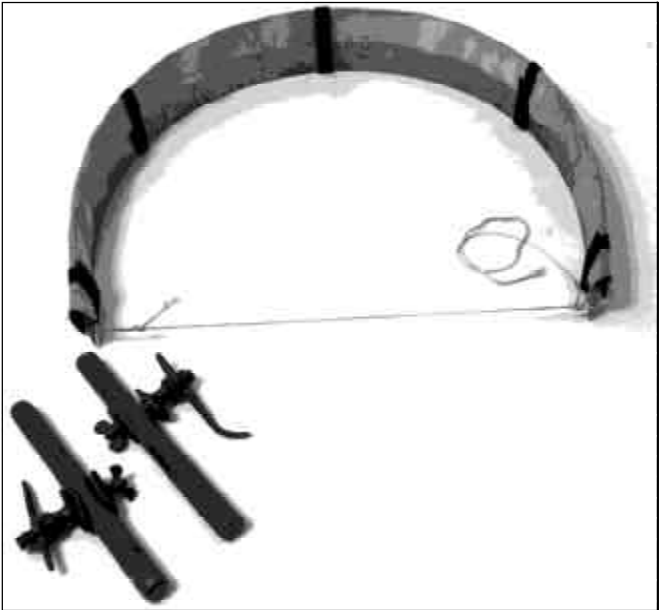
22.48h – Exhibit 01 – Bent Saw With Handles Removed

- (b) Secure the saw from movement in a separate compartment, cargo bay behind net, or on the floor with tie-down straps.
- (2) **Rotor Wing Aircraft.**
 - (a) Properly sheathe the saw.
 - (b) Secure the saw to the floor or in a net compartment.
 - (c) In an external cargo sling net, keep the saw straight and secured to a larger object.
 - (d) In an external basket, keep the saw properly secured with appropriate tie straps.
- d. **Personal Transport.** For personal transport of crosscut saws, comply with the following:
 - (1) Guard and balance the saw on your shoulder.
 - (2) Remove the rear handle.

- (3) Rest the saw over your shoulder with the teeth facing away from your neck.
 - (4) Carry the saw on the downhill side.
 - (5) Walk last in line if you are the person carrying the saw.
- e. **Use of Crosscut Saws.** In using crosscut saws, comply with the following:
- (1) Always inspect the saw before use.
 - (2) Use only saws that are properly set and sharpened.
 - (3) Wear cut-resistant gloves when handling a saw. Carefully sheathe and unsheathe the saw with the teeth facing away from your body (ex. 02).
 - (4) Pick up the saw with teeth away from your body. Rotate the teeth toward your body before handing the saw to another employee.
 - (5) When attaching handles, keep the teeth away from your body and secure a firm grip on the saw.
 - (6) Assess the work site (sec. 22.48e).

22.48h – Exhibit 02 – Unsheathing Saw



- (7) Establish primary and secondary escape routes, safety zones, and alternates.
- (8) Prior to cutting, remove vegetation. Ensure firm, stable footing.
- (9) When using a two-employee crosscut saw for bucking, ensure that any employee placed downhill is in a safe position. If it is not certain that the downhill partner would be in a safe position, always single buck.
- (10) When using a two-employee crosscut saw for falling, always predetermine who will remove the saw.
- (11) When beginning to cut, ensure hands are in proper position. Do not push the saw.
- (12) Do not reach across a moving saw.
- (13) Maintain control and safe body position while sawing.
- (14) Keep in communication with your partner at all times about holding wood, binds, limbs, and knots that might affect safety.
- (15) When situations are deemed unsafe, use alternate methods or cancel the task.

22.49 – Tree Climbing.

22.49a – Standards. The standards for tree climbing safety equipment are in 29 CFR 1910.268, 1926.104, and 1926.107, and American National Standards Institute (ANSI) A10.14 and Z133.1 Standards.

22.49b – Qualifications. The Regions, Stations, Area, and Institute shall develop a training and certification program for employees who climb trees in support of project work and activities (sec. 22.06, para. 7).

1. Tree climbing performed in support of smokejumper wildland fire suppression operations and activities shall be in accordance with FSH 5709.14, Smokejumper and Paracargo Handbook and the Interagency Smokejumper Training Guide.

2. Smokejumpers who engage in tree climbing in support of project work and activities shall comply with the requirements in sections 22.49 – 22.49e.

3. The program must include the following annual components:
 - a. Review the manufacturer's specifications on the use, care, and storage of climbing equipment and systems, including serviceability and retirement of worn or defective equipment and components.
 - b. Perform practice sessions on the use of basic climbing equipment and techniques.
 - c. Conduct training sessions on care, use, and storage of climbing equipment and systems with emphasis on climbing techniques, practices, and procedures.
 - d. Conduct training sessions on rescue operations and activities. Training should include a practicum on proper rescue techniques.

22.49c – Personal Protective Equipment. Climbing equipment must comply with the requirements of 29 CFR 1926.104 and 1926.107 and ANSI A10.14. The following PPE is required for tree climbing:

1. Climbing helmet with a 3 point (minimum) chin strap (UIAA approved).
2. Harness with a breaking strength of at least 5,400 pounds (24 kN).
3. Lanyard with a breaking strength of at least 5,400 pounds (24 kN).
4. Long-sleeved shirt and sturdy pants or coveralls.
5. Eye protection meeting the requirements of ANSI Z87.1.
6. Gloves during rappelling.
7. Appropriate footwear as identified by the JHA. Examples are soft-soled hiking boots, high-top tennis shoes, and crepe-soled work boots. When working with climbing spurs, wear boots with suitable heels to keep the spurs in place.
8. Other PPE as identified by the JHA.
9. An appropriate 10-person (minimum) first aid kit shall be available to each climbing team (refer to the Glossary).

22.49d – Procedures. Prepare a JHA and discuss it with the climbing team before the climbing assignment (sec. 22.08). Discuss how to accomplish the project on a day-to-day basis. Hold periodic tailgate safety and health sessions. Tree climbing operations and activities shall be conducted by climbing teams only.

1. **Preparing for Climb.**

- a. Determine from where radio contact can be made. When direct radio contact cannot be maintained from the job site, establish procedures to obtain help without leaving the injured climbers alone.
- b. Team inexperienced climbers with an experienced climber to monitor the new climbers' technique and equipment use and provide advice.
- c. Have rescue equipment ready for use at the tree.
- d. Inspect equipment for excessive wear or breakage.
- e. Determine which safety systems will be utilized for a specific climb.
- f. Be aware of changes in the weather throughout the day.

2. **During Climb.**

- a. ***Once you are in the tree, observe the different characteristics of the tree that were not evident from the ground. Adjust procedures and techniques as necessary to maintain safety. If safety cannot be maintained, the climber shall immediately descend.***
- b. Use a haul line for securing, supporting, and transporting equipment and tools that could hinder climbing activities. Keep protective coverings over sharp edges and pointed tips while not in use. Keep hands free of materials and tools while climbing.
- c. When climbing, secure equipment and tools to yourself or to the tree. Always secure large tools to the tree. When using cutting tools, secure yourself to the tree with a steel cored lanyard or other cut-resistant lines.
- d. Ensure that the ground person is certified for the level of work being performed. The ground person shall remain on the ground except when it is necessary to assist the climber.

22.49e – Safety Practices. Refer to the National Tree Climbing Field Guide (sec. 22.06, para. 7) for guidelines on safe tree climbing practices.

22.5 – Watershed and Air Management. Prepare a separate JHA and discuss it with employees for each water, snow, or soil survey work project or activity (sec. 22.08).

22.51 – Water Surveys. *Poor footing and changing conditions are an inherent part of streamflow measurement work. Other hazards include high flow velocities, poor weather, deep, turbid waters, and floating debris.*

22.51a – Qualifications. In addition to training and certifications listed in section 22.07, employees shall receive training in or be familiar with the following topics when applicable:

1. Prevention, detection, and treatment of hypothermia as part of first aid training (sec. 54.22b).
2. Swimming competency as demonstrated by their ability to pass a Red Cross or equivalent swimmer's test.

22.51b – Personal Protective Equipment.

1. PPE required for water surveys:
 - a. First aid kit (refer to the Glossary).
 - b. Personal communications device.
 - c. Tractionized footwear (felt or nylon soles, lace-on oversoles, or bonded carpeting).
 - d. Hip boots or belted waders. Never wear hip boots or waders while working from boats in swift water or in any water deeper than 3 feet (1 m).
 - e. 10- to 12-foot (3- to 4-m) wading pole for balance and exploring for drop offs.
2. PPE recommended for water surveys:
 - a. Safety sunglasses and sunscreen.
 - b. Coast Guard approved personal flotation device (PFD).
 - c. International orange or yellow lifeline.
 - d. Backpack with quick-release harness.
 - e. Additional PPE as identified in the JHA.

22.51c – Procedures. Work hazards, as identified in the JHA, may require extra precautions. Base work hazards on factors such as water depth, flow velocity (ft/sec), and turbidity. Employees shall:

1. Obtain reliable weather reports and suspend measurements during lightning storms or when a storm is approaching.
2. Wear Coast Guard approved PFD when needed.
3. Work in teams of two or more and within sight of one another.
4. Use the safest access to sample a site.
5. Exercise caution when the travel route becomes muddy and slippery.
6. Avoid crossing streams on logs. If necessary, cross by straddling rather than walking on a log.
7. Use lifelines securely anchored on the bank for hazardous water crossings.
8. Wear backpacks that have quick-release harnesses or slip off the upstream shoulder strap so the pack can be discarded in an emergency.
9. Secure a quick-release belt or rope around the top of chest waders to keep out water and prevent a loss of buoyancy.
10. If the stream proves too dangerous when wading, back out using a wading pole for balance. Turning around exposes a broader body surface to the current and increases the chances of losing footing.

22.51d – Safety Practices. Basic safety and health practices are:

1. Under supervision, practice emergency procedures with swamped boats, boots, and waders.
2. Follow the Rule of 10:
 - a. If a stream is 1 foot (1/3 m) deep and flowing at 10 ft/sec, it is too hazardous to wade.
 - b. If a stream is 2 feet (1/2 m) deep and flowing at 5 ft/sec, it is too hazardous to wade.

22.52 – Snow Surveys. Employees shall review and understand the direction on winter travel (sec. 11.3).

22.52a – Qualifications. In addition to having the training and certifications listed in section 22.07, employees shall receive training in or be familiar with the following topics when applicable:

1. Prevention, detection, and treatment of hypothermia as part of first aid training (sec. 54.22b).
2. Emergency survival.
3. Use of snowshoes and skis.
4. Avalanche hazard recognition.
5. Oversnow vehicle operation.

22.52b – Personal Protective Equipment. The PPE required for snow surveys includes:

1. Personal communications device.
2. First aid kit (refer to the Glossary).
3. Other PPE as identified in the JHA, which may include collapsible (sectional) probes, avalanche rescue transceivers, and other winter survival gear such as safety sunglasses, sunscreen, snowshoes, and cross-country skis.

22.52c – Safety Practices. Basic safety and health practices are:

1. Never work alone unless the specific circumstances are expressly planned for in the JHA (sec. 11.2 and 21.14).
2. Select travel routes that avoid areas of known or suspected snowslide or avalanche hazard. Reroute snow courses if unusual hazards such as deep snow under a powerline are found, or if a safe approach is not available.
3. Carefully plan and pre-arrange any oversnow trip that is long or tiring. Include emergency shelter and supplies.
4. Follow the precautions for travel on ice (sec. 11.32) whenever the expected route is on ice.

22.53 – Soil Surveys.

22.53a – Standards. The standards for excavating are in 29 CFR 1926.650 – 1926.652.

22.53b – Qualifications. Besides having the training and certifications listed in section 22.07, employees shall receive training in or be familiar with the following topics when applicable:

1. Use and care of hand and power tools (sec. 41 and 43).
2. Back-country travel/camping techniques (sec. 11.2 and 18).
3. ATV/motorcycle use (sec. 13.2 and 13.3).

22.53c – Personal Protective Equipment.

1. PPE required for soil surveys:
 - a. First aid kit (refer to the Glossary).
 - b. Personal communications device.
2. PPE recommended for soil surveys:
 - a. Forest Service-approved hardhat.
 - b. Eye protection and sunscreen.
 - c. Padded gloves and wrist guards (ergonomic concerns).
 - d. Additional PPE as identified in the JHA.

22.53d – Safety Practices. Basic safety and health practices are:

1. Use the JHA to identify and assess site-specific safety and health concerns.
2. Conduct tailgate safety and health sessions. Emphasize correct work methods to reduce risks of cumulative trauma disorders. Refer to section 52.4 for ergonomic concerns.
3. When backhoe pits are developed, adhere to all OSHA excavation regulations. Refer to section 31.2 for further direction.

22.6 – Wildlife, Fish, and Sensitive Plant Management.

22.61 – Electrofishing. All electrofishing operations shall be conducted by trained crew members. All equipment must be constructed, maintained, and operated according to approved guidelines.

22.61a – Qualifications.

1. Crew leaders (first-line supervisors) shall receive formal training in water safety, electrofishing theory, equipment use, and specific electrical safety.
2. Crew members shall receive training in water safety and equipment use.
 - a. The crew leader shall instruct employees in electrofishing safety techniques for the expected electrofishing type and water conditions.
 - b. At least two members of an electrofishing crew must have current first aid and CPR certification.

22.61b – Personal Protective Equipment.

1. When electrofishing, employees shall wear:
 - a. Belted chest-high waders or hipboots with nonskid soles. Never wear either waders or hip boots, however, while working from a boat in swift water or in any water deeper than 3 feet (1 m).
 - b. Rubber insulating gloves. Test gloves for voltage resistance each year (ANSI J6.6-1967).
 - c. Coast Guard approved personal flotation devices. The crew leader may designate them as optional on a particular stretch of water.
2. Polarized sunglasses and hearing protection (85 dB and above) are recommended.
3. Electrofishing boats shall be equipped with a first aid kit and a fire extinguisher, which is mounted in an accessible location (sec. 15.13b). Spare clothing and fire-starter supplies packed in a water-proof storage bag are recommended.

22.61c – Safety Practices. The crew leader shall have knowledge of water hazards at each worksite (shocking location). The JHA shall identify these hazards, as well as guidelines associated with specific work projects and activities.

1. General safety practices include:
 - a. Select equipment suitable for the work project or activity, such as a proper boat for the water you are on.

- b. Thoroughly inspect equipment before use. In the event of electric shock, shut down equipment until repaired. Report the incident to the supervisor.
 - c. Check the weather forecast before electrofishing. Suspend operations if weather or water conditions change and pose safety problems.
2. Specific safety practices include:
- a. Never touch the conductive end of a probe when operating the electrofishing unit. The anode should never touch the cathode or other metal.
 - b. Adjust the controls when the rectifying unit is not in operation. (For battery-powered units, ensure the cathode is in contact with the water when the unit is operating.)
 - c. Ensure that the equipment has both automatic and manual safety circuit breakers. Locate at least one employee near the unit to break the circuit in emergencies.
 - d. Never use a breaker electrofisher unit in a boat unless it is dismantled and secured to the boat. Never operate an electrofisher unit alone.
 - e. Never have backpack operators responsible for capturing fish unless one of the electrodes is in a net.
 - f. When working in areas of heavy public use, make maximum use of buoys to warn away swimmers, divers, and boaters.

22.62 – Diving.

22.62a – Standards. The standards for diving operations are in 29 CFR Part 1910, Subpart T and Part 1926, Subpart Y.

22.62b – Qualifications. In addition to having the applicable training listed in section 22.07, all divers shall hold a valid Forest Service certificate issued pursuant to the Diving Management and Safety Manual (sec. 22.06, para. 5). They shall be currently certified, trained, and qualified for the diving mode being used. Other required training includes:

1. Each diving team member shall be trained and certified in first aid and CPR.

2. Divers shall demonstrate competency or receive training in diving-related physics and physiology, recognition of pressure-related (hyperbaric) injuries, and appropriate emergency treatments.

3. Divers shall demonstrate competency or receive training in the use of instruments and equipment appropriate to the diving activity.

22.62c – Procedures. Forest Service diving operations that are not classified as scientific diving by definition shall comply with all diving requirements contained in 29 CFR Part 1910, Subpart T and Part 1926, Subpart Y.

All Forest Service scuba diving operations and scientific diving shall be under the direction of a diving program, which shall include a Diving Safety Control Board and shall be in compliance with the Diving Management and Safety Manual (sec. 22.06, para. 5):

1. **Diving Safety Control Board.** Membership shall consist primarily of active divers. Duties of the board shall include:
 - a. Reviewing and revising instructions in the Diving Management and Safety Manual.
 - b. Approving and monitoring diving projects for compliance with the manual.
 - c. Certifying the depths to which a diver has been trained.
 - d. Recommending disciplinary action for unsafe practices.

2. **Diving Management and Safety Manual.** All diving projects shall be in compliance with the Diving Management and Safety Manual direction. The diving officer, lead diver, and individual divers are responsible for ensuring compliance with the Diving Management and Safety Manual.
 - a. The lead diver shall submit a diving plan and JHA for each project or diving activity.
 - b. A first aid handbook, resuscitator, and phone numbers for emergency transportation shall be available at the dive site.
 - c. All pre-dive, during-dive, and post-dive procedures shall be followed.
 - d. Each individual diver makes the decision to dive or to terminate the dive.

- e. Solo diving is prohibited.
- f. Divers shall not exceed their certified depth.

22.62d – Scientific Diving in Fisheries. Scientific divers shall meet all the qualifications in section 22.62b. Their duties are to observe, collect, and record data for scientific purposes in the sub-surface, fisheries environment.

1. **Procedures.** Scientific diving does not include performing any tasks usually associated with commercial diving. Divers do not:
 - a. Place or remove heavy objects underwater.
 - b. Inspect pipelines or similar objects.
 - c. Engage in construction, demolition, cutting, welding, or the use of explosives.

22.63 – Cavity Nesting Bird Work Projects and Activities. Cavity nesting bird work projects and activities are complex and require skills in the use of chain saws, power drills, power blowers, ladders, climbing equipment, and handtools.

22.63a – Qualifications. The first-line supervisor shall ensure that employees possess all other required training, certifications, and skills in addition to the applicable training listed in section 22.07.

22.63b – Personal Protective Equipment. The JHA shall identify PPE required for cavity nesting bird work projects and activities (sec. 22.08).

22.63c – Safety Practices. The first-line supervisor shall conduct tailgate safety and health sessions to ensure that employees are thoroughly briefed before beginning work projects and activities. Employees shall follow up with periodic tailgate safety sessions. Refer to the appropriate sections of this Handbook for specific direction, such as sections 22.48, Chain Saw Operations; 22.49, Tree Climbing; and 41, Handtools. Basic safety and health practices for cavity nesting bird work projects and activities are:

1. Identify in the JHA the number of employees required to safely perform the specific work project or activity; for example, a minimum of 2 employees are required when using chain saws and ladders.
2. Before climbing, inspect trees for hazards such as bees in the cavity, dead limbs, and excessive structural weakening around

the cavity. Refer to the National Tree Climbing Field Guide for hazard tree identification standards (sec. 22.06, para. 7).

- a. Remove limbs when identified as hazardous.
- b. Do not climb unsound trees.

3. Inspect safety belts, safety straps, climbing ropes, and hardware before and after each climb.

4. Inspect climbing ladders for defects.

- a. Clearly identify defective equipment for removal from service, repair, or replacement (sec. 33.1).
- b. Place a safety strap around the tree whenever climbers are on ladders.

5. Instruct the ground crew not to stand near the base of a tree. Make sure no one walks beneath the tree until the climber gives specific verbal permission to do so.

6. **Weather Hazards.** Be alert to changing climatic conditions, especially lightning and high wind.

- a. Do not climb during lightning storms.
- b. Do not climb when wind excessively sways the tree to be climbed.
- c. When storms are threatening, stay away from trees rigged with climbing ladders. Give yourself plenty of time to get out of the tree.

22.7 – Special Uses. [Reserved].

22.8 – Minerals and Geology.

22.81 – Mine and Mineral Surveys.

22.81a – Standards. The standards for first aid are in 29 CFR 1910.151. The authority for air contaminant protection is 29 CFR 1926.55.

22.81b – Qualifications. In addition to meeting the applicable training and certifications listed in section 22.07, employees shall comply with the following requirements:

1. **Abandoned and Inactive Operations.**

- a. Employees who conduct mine safety assessments and mineral surveys shall be certified as mineral examiners

in accordance with FSM 2807. A Certified Review Mineral Examiner (RME) or Certified Mineral Examiner (ME), appointed by the Regional Director responsible for the Regional Minerals program, shall determine which RME/ME's are qualified to conduct mine safety assessments and mineral surveys for abandoned/inactive underground mine workings and deep cuts. If an appointed RME/ME is not available or if there are no RME/ME's in the Region, then an RME/ME from an adjacent region may be appointed.

- b. Employees who are not RME/ME's, but may need to enter abandoned/inactive underground mine workings and/or deep cuts to perform their jobs, shall obtain permission from the appropriate line officer in charge. The line officer shall consider the need to enter hazardous work areas, the training, and the work experience of the employee.

2. **Active Operations.**

- a. The prescribed safety practices of those companies that have a designated safety officer and a formal safety training plan shall be recognized.
- b. Active underground operations that do not have a designated safety officer and a formal safety training plan shall be given the same consideration as abandoned/inactive workings.

3. **All Operations.**

- a. Each field crew and office group shall have at least one person currently certified by a nationally recognized organization to render first aid and perform CPR (29 CFR 1910.151, 1910.1030, and 1926.50).
- b. Any Federal or State employee who enters underground mine workings or deep cuts at the request of the Forest Service must have valid first aid and CPR cards.

22.81c – Personal Protective Equipment. Before employees or mineral examiners enter underground mine workings, they shall be trained in the use of PPE and must ensure equipment is in working order and suited for the work project or activity.

1. PPE required includes:
 - a. Forest Service-approved hardhat.
 - b. Nonskid safety-toed boots.
 - c. Safety glasses, goggles, or face shield.
 - d. Headlamp (battery operated only).
 - e. Safety belt with ring for securing lifelines.
 - f. Multi-gas meter.
 - (1) Capable of detecting at least oxygen. Contact the Mine Safety and Health Administration, the state mine inspector, and/or local mining companies to determine additional gases to be detected based on regional geology and mineralogy.
 - (2) Audible and visual display alarm indicators.
 - (3) Calibrated for the gases to be detected (high/low alarm limits for toxic and combustible gases; and depletion/enrichment alarm limits for oxygen).
 - g. First aid kit (refer to the Glossary).
 - h. Two-way radio for check-in (for use outside the underground workings).
 - i. Specific items for conditions requiring extra protective measures as identified in JHA.
2. Optional PPE includes a self-rescuer.

22.81d – Procedures. Basic procedures are:

1. Complete the JHA and discuss it with involved employees prior to the work project or activity (sec. 22.08).
2. Complete an itinerary that includes at least the following items and leave the itinerary with the radio dispatcher on duty.
 - a. List of personnel going to the field.
 - b. Addresses, home telephone numbers, emergency telephone numbers, and whom to contact in case of an emergency.
 - c. Predetermined check-in schedule.
 - d. A map showing the approximate location of entrances to the underground workings and/or the location of the deep cuts.

3. At a minimum, consider the following potential safety hazards the JHA:
 - a. Slip, trip, and fall hazards around shaft collars, winzes, or other vertical mine openings.
 - b. Rock falls and collapse of unstable rock in mines and around mine openings.
 - c. Snakes, bats, spiders, and other insects and animals.
 - d. Rotten mine timbers and other unsafe mine support features.
 - e. Oxygen deficient atmosphere and/or an atmosphere containing toxic or combustible gases.
 - f. Abandoned explosive devices.
 - g. Chemicals/hazardous materials.
4. Ensure that a qualified RME/ME or State or Federal mine inspector determines that the underground mine workings or deep cuts are safe before other employees are allowed to enter such workings. This determination includes examining and testing the back (roof) and rib (walls) of the underground mine workings for loose rock and shall scale as appropriate to ensure the safety of personnel.
5. Ensure that noncertified employees allowed to enter abandoned/inactive underground mine workings or deep cuts enter such hazardous work areas only when accompanied by a qualified RME/ME or State or Federal mine inspector.
6. Consider all underground coal mine atmospheres explosive and keep open flames away.
7. Consider all underground atmospheres oxygen-deficient and containing toxic gases until testing and continuous monitoring prove otherwise.
8. Use a lifeline when working around hazardous openings and areas (sec. 32.2 and 33.3).
9. Display the Abandoned Mine Hazards Poster in a conspicuous place near the entrance of known abandoned/inactive underground mine openings (ex. 01).

22.81d – Exhibit 01 – Abandoned Mine Hazards Poster

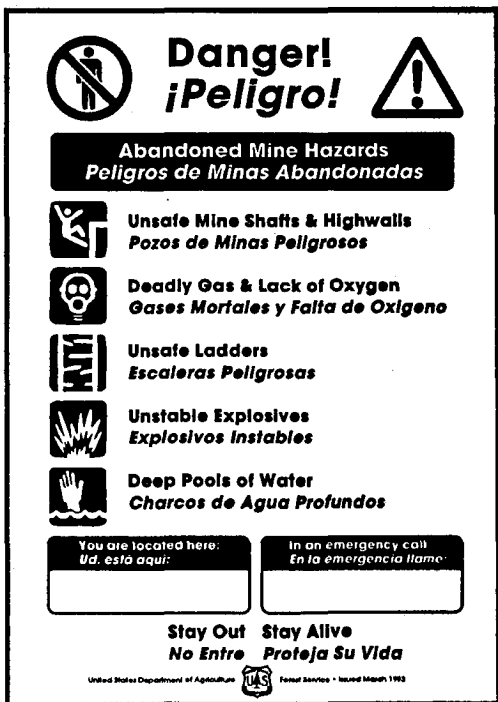

22.82 – Oil and Gas Operations.

22.82a – Qualifications. Any employee working on or near exploration or production operations shall have hydrogen sulfide (H₂S) awareness training.

22.82b – Personal Protective Equipment.

1. Before any employees are allowed to work on or near any oil and gas exploration or production operation in a known H₂S area, ensure that all employees are trained in the use of PPE and

that equipment is in working order and is appropriate for the work project or activity.

2. In the JHA, identify specific items for conditions requiring extra protective measures.

22.82c – Procedures. Complete the JHA and discuss it with involved employees prior to the work project or activity. The JHA shall include the potential safety hazards associated with H₂S on or near oil and gas operations.

23 – STATE AND PRIVATE FORESTRY. [Reserved].

24 – RESEARCH. [Reserved].

25 – PROTECTION AND DEVELOPMENT.

25.01 – Authority.

1. The authority for PPE, fire extinguishers, and fire detection systems is in Title 29, Code of Federal Regulations (29 CFR), sections 1910.132 – 1910.138 and 1910.157 – 1910.165.

2. The authority for PPE, fire protection and prevention, flammable and combustible liquids, liquefied petroleum gas, temporary heating devices, and rollover protective structures (ROPS) is in 29 CFR 1926.100 – 1926.103, 1926.150 – 1926.155, and 1926.1000.

3. FSM 1500, External Relations, contains memorandums of understanding and agreements between the Forest Service and other Federal and State agencies and other organizations including those related to fire protection and law enforcement.

4. FSM 5130 contains direction on Structure and Vehicle Fires.

5. FSM 5140 contains direction on Prescribed Fire.

6. FSH 5109.32a, Fireline Handbook, issued by the National Wildfire Coordinating Group, is the interagency authority for wildland fire agencies that use the Incident Command System. PMS 410-1, NFES 0065. National Interagency Fire Center. Boise, ID. (See sec. 01 for further information on obtaining copies.)

7. FSM 5300 and FSH 5309.11 contain direction on Law Enforcement.

25.06 – References.

1. National Fire Protection Association. NFPA 10: Portable Fire Extinguishers (1990); NFPA 30: Flammable and Combustible Liquids Code (1996); NFPA 101: Life Safety Code (1994). Quincy, MA.

2. National Wildfire Coordinating Group. 1995. Your Fire Shelter. PMS 409-2, NFES 1570. National Interagency Fire Center. Boise, ID.

3. National Wildfire Coordinating Group. 1996. Your Fire Shelter Beyond the Basics. PMS 409-1, NFES 2179. National Interagency Fire Center. Boise, ID.

4. National Wildfire Coordinating Group. 1999. Wildland and Prescribed Fire Qualifications System Guide. PMS 310-1, NFES 1414. National Interagency Fire Center. Boise, ID.

5. U.S. Department of Agriculture, Forest Service. 1993. Ground Ignition Systems: An Equipment Guide for Prescribed and Wild Fires. 9351-2806-MTDC. Missoula Technology and Development Center, Forest Service. Missoula, MT.

25.07 – Qualifications. In addition to meeting the applicable training and certification listed in section 21.11, employees involved in fire management protection and law enforcement activities should consider training in bloodborne pathogens protection (sec. 52.3), hantavirus awareness (sec. 53.73a), and hazardous materials communications (sec. 61).

25.08 – Procedures. Prepare a JHA and discuss it with employees for specific fire management and law enforcement activities (sec. 21.1). The JHA should include:

1. An itinerary of planned travel route(s), date(s) of travel, destination(s), and estimated time of departure/arrival.
2. Check-out/check-in system.
3. Name of employees.

4. Emergency phone numbers/communication system and contact points.

5. Other information pertinent to the project or activity, such as required training. (Some items required for the JHA are available in other documents, such as a district or project safety and health plan, and may be included by reference.)

If employees fail to call in or return on schedule, the supervisor shall take actions as required by the JHA.

25.1 – Fire. *There are many hazards inherent in wildland fire suppression and fire use activities. Work must be planned and conducted in a manner to prevent accidents and illnesses. Inform personnel of the hazards they face on a wildfire, especially local conditions that they may confront daily that could present hazards. This type of briefing is particularly important for those assigned to fires away from their local units.*

Personnel subject to a fire assignment shall be familiar with and use the safety and health information and guidelines contained in sections 13.7, 25.14, and 55.

25.11 – Qualifications. Forest Service fire management personnel, including temporary employees, shall meet training, experience, and physical fitness requirements of the National Fire Qualifications System. In addition, fire management personnel shall have the applicable training and certification listed in section 25.07.

Do not assign to fireline duty a worker who has any injury, illness, or emotional problem, or who is fatigued or otherwise not fit for duty.

25.12 – Personal Protective Equipment. Do not modify PPE. The following PPE is required for fire duty.

1. **Fire Shelter. *A serviceable Forest Service-approved fire shelter is mandatory equipment on the fireline.*** Fire shelter training is also mandatory for all firefighters, as well as support personnel whose duties take them to or adjacent to the fireline. All persons required to carry fire shelters shall be trained in their use prior to assignment and shall receive annual refresher training.

- a. Always inspect a fire shelter when it is issued to you.
Follow the inspection guidelines in the latest issue of

25.12 – Exhibit 01 – Wildland Fire/Prescribed Fire PPE

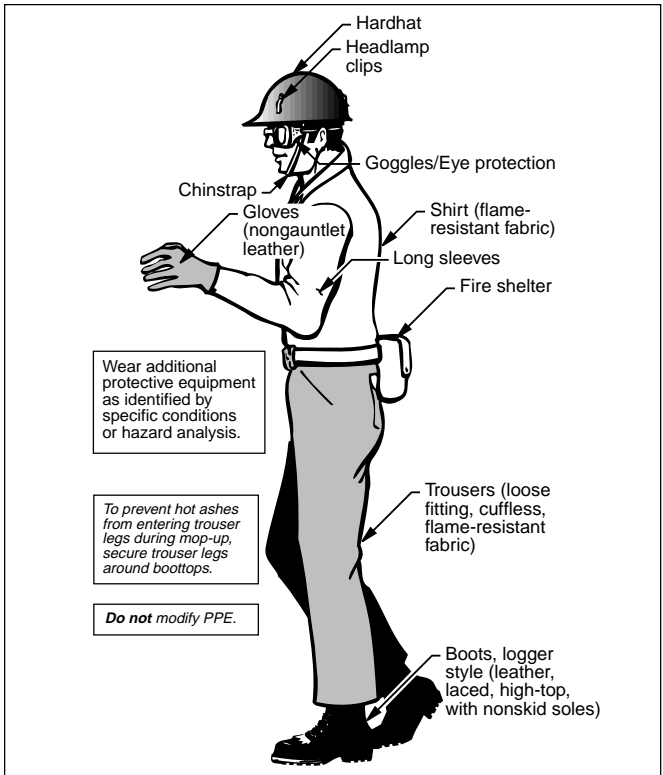

“Your Fire Shelter” to determine shelter serviceability (sec. 25.06).

- b. Inspect shelters at the beginning and end of each fire season.
- c. During fire season inspect your personal shelter every 14 days when carrying it on your person, in a vehicle, or on heavy equipment.

- d. Carry the fire shelter in its original case or in an external pocket of a pack. Ensure that removal can be accomplished with one hand while wearing gloves and while walking at a brisk pace.
2. **Hardhat. All personnel shall wear Forest Service-approved hardhats on the fireline.** They must be (sec. 21.13b, para. 4):
 - a. Constructed of material with a melting point greater than 350°F (177°C).
 - b. Equipped with a chinstrap.
 3. **Eye Protection.** Wear approved eye protection on the fireline.
 4. **Hearing Protection.** Use hearing protection whenever sound levels exceed 85 dB.
 5. **First Aid Kit** (refer to the Glossary).
 6. **Clothing. Wear loose-fitting long-sleeved shirts of Forest Service-approved flame-resistant (FR) fabric on the fireline. Keep sleeves rolled down. Wear loose-fitting, cuffless pants. Shirt and pant designs shall be Forest Service-approved fabrics.**

Avoid undergarments and socks made of 100 percent, or a high percentage of, polyester, nylon, or acrylic.

It is recommended that employees wear a short sleeved t-shirt, underwear, and socks under fire clothing and boots. T-shirts and underwear should be 100 percent cotton or a 100 percent flame-resistant blend of these fibers. Socks should be cotton, wool, or a blend of flame-resistant fibers.
 7. **Gloves.** Wear nongauntlet heavy-duty leather gloves that are Forest Service-approved on the fireline.
 8. **Boots. Wear heavy-duty, leather, laced boots with non-skid soles and tops at least 8 inches (204 mm) high.** Steel-toed (metal cup) footwear is not recommended for fire suppression.
 9. **Specialized PPE.** Wear additional PPE as identified by local conditions, material safety data sheet (MSDS), or JHA. Refer

to section 21.13b, paragraph 3, for direction on respiratory protection.

10. **PPE for Mixing Fire Retardant Chemicals.** Take necessary precautions to avoid direct contact with or inhalation of fire retardant chemicals. Ensure that MSDSs are available and have been discussed with all employees involved in the handling and mixing process.

Install engineering controls that minimize and control dust at the mixing station. The recommended or required PPE is prescribed in the retardant chemical product MSDS.

25.13 – Wildland Firefighting.

25.13a – Safety Practices. Conduct risk assessments on an ongoing basis and take measures to mitigate risks to prevent accidents. Basic safety and health practices for wildland firefighting are:

1. **The 10 Standard Fire Orders.** *Ensure that all firefighters understand and know how to implement the 10 Standard Fire Orders and understand their implications.*

- F – Fight fire aggressively but provide for safety first.
- I – Initiate all action based on current and expected fire behavior.
- R – Recognize current weather conditions and obtain forecasts.
- E – Ensure instructions are given and understood.
- O – Obtain current information on fire status.
- R – Remain in contact with crew members/your supervisor/ adjoining forces.
- D – Determine safety zones and escape routes.
- E – Establish lookouts in potentially hazardous situations.
- R – Retain control at all times.
- S – Stay alert, keep calm, think clearly, act decisively.

2. **Watchout Situations.** Ensure that all firefighters can recognize the 18 situations that shout “Watchout” and are aware of ways to mitigate the situation(s).

1. Fire not scouted and sized up.
2. Located in country not previously seen in daylight.
3. Safety zones and escape routes not identified.
4. Unfamiliar with weather/local factors influencing fire behavior.

5. Uninformed on strategy, tactics, and hazards.
6. Instructions and assignments not clear.
7. No communication link with crew members/supervisors.
8. Constructing line without a safe anchor point.
9. Building fireline downhill with fire below.
10. Attempting frontal assault on the fire.
11. Unburned fuel between you and the fire.
12. Cannot see main fire, not in contact with anyone who can.
13. On a hillside where rolling material can ignite fuel below.
14. Weather becoming hotter and drier.
15. Wind increases and/or changes direction.
16. Getting frequent spot fires across line.
17. Terrain and fuels make escape to safety zones difficult.
18. Taking a nap near the fireline.

3. **LCES.** Lookout(s), Communication(s), Escape Route(s), and Safety Zone(s) are elements of a safety system routinely used by firefighters. LCES has a broader application than just fire and should be considered as a valuable, useful tool for all field project work and activities. Examples include chain saw operations, work in confined spaces, hazardous materials, blasting, and driving.

4. **Escape Routes.** A pre-planned and understood route firefighters take to move to a safety zone or other low-risk area before the fire reaches their location. ***Have escape routes and make them known. Evaluate escape routes continually as fire conditions change and communicate those changes to all employees involved.***

5. **Safety Zone.** A pre-planned area of sufficient size and suitable location that is expected to protect fire personnel from known hazards without using fire shelters.

- a. Do not consider the fire shelter an alternative to a safety zone.
- b. As a crew boss, safety officer, task force/strike team leader, or division group supervisor, establish and continually inspect escape routes and safety zones and make them known.
- c. Give specific instructions and make sure everyone hears and understands. ***Have a fail-safe, instantly under-***

stood method of notifying personnel when to evacuate.

- d. Maintain control of the crew during evacuation.
- e. Be sure no one is left behind.

6. **Survival Zone.** A natural or cleared area of sufficient size and location to protect fire personnel from expected hazards while inside a fire shelter.

7. **Fire Situation Assessment.**

- a. Conduct continual situation assessment and follow-up, which is essential.
- b. When structures are involved, remember that structural fire suppression demands training, equipment, and PPE different from that needed in wildland fire suppression. Structures exposed to wildland fire in the urban interface can and should be considered as another fuel type. Forest Service employees shall limit structural fire suppression actions to exterior attack to prevent structure fires from spreading to the wildland. Refer to section 35.1 and FSM 5130 for further direction.
- c. ***Ensure that firefighter safety is not compromised. Do not deviate from established safety practices, such as the 10 Standard Fire Orders, the 18 Watchout Situations, and LCES.***
- d. Post qualified lookouts with adequate communication for crews and in position to see danger points.
 - (1) Establish prearranged warning signals and make them known to all crew members.
 - (2) Focus attention on high-risk situations first.

8. **Firefighter Welfare Guidelines.**

- a. Plan for and ensure a 2 to 1 work-to-rest ratio schedule; 1 hour of rest/sleep for every 2 hours of work/travel.
- b. Do not assign fatigued firefighters. Provide a minimum of 24 consecutive hours of rest in every 14-day assignment or 48 consecutive hours of rest in every 21-day assignment to continuous suppression activity.
- c. Following a 21-day assignment, provide a minimum of 24 consecutive hours of rest before any new assignment.

- d. Monitor fluid replacement. Adequate fluid intake depends upon weather conditions and workload. The suggested replacement rate is at least 1 quart (1 liter) of fluid per hour.
- e. Minimize worker exposure to smoke concentrations. Periodically rotate workers from worksites and camp locations with moderate to high smoke levels to relatively smoke-free areas.
- f. Monitor conditions for possible concentrations of carbon monoxide (CO) and take appropriate action. Heavy concentrations can exist with smoke. The body absorbs CO at a rapid rate for the first hour of exposure, after which the rate drops slightly for the next 4 to 8 hours. It takes 8 hours in an uncontaminated environment to purge CO from the body. Refer to section 39.22b, paragraph 3, for further information.
 - (1) Monitor personnel for symptoms and behavior associated with CO exposure and take appropriate action when necessary. Refer to exhibit 01.

25.13a – Exhibit 01 – Symptoms of Carbon Monoxide (CO) Exposure

| <i>Blood CO Level</i> | <i>Symptoms</i> | <i>Behavior</i> |
|---------------------------|--|--|
| Moderate | Possible headache, nausea, and increasing fatigue. | Increasing impairment of alertness, vision discrimination, judgment of time, physical coordination. Becomes increasingly complacent. |
| High | Headache, fatigue, drowsiness, nausea, vomiting, dizziness, convulsions, cardiorespiratory difficulty. | Above behavior becomes more acute to extreme. |

- (2) Expect higher CO concentrations in the following:
 - (a) Near an active flame front.
 - (b) In heavy smoke concentrations (inversions, downwind of the fire).
 - (c) During mop-up (prolonged exposure to low-moderate smoke level).
 - (d) In topographic features that concentrate smoke, such as the head of a canyon, ravines, saddles or passes, depressions, or basins.

25.13b – Fatigue Factors. Accident rates increase sharply with fatigue. Be alert for signs of fatigue. Some methods to combat fatigue include:

1. Ensure a high level of fitness by doing job-specific tasks and training before the season begins.
2. Acclimate to temperature and altitude extremes.
3. Limit shifts.
4. Alternate tools/tasks.
5. Set a reasonable work pace and allow adequate rest breaks while on the fireline.
6. Supply sufficient nutrition and water on the line and in camp.
7. Provide showers and comfortable eating areas.
8. Provide quiet, shaded sleeping areas away from smoke, noise, and dust.
9. Post signs and rope off sleeping areas.
10. Practice relaxation and meditation techniques.

25.13c – After Work Activities Involving Swimming. *Organized swimming activities must be approved by the Incident Commander.* If organized swimming is allowed:

1. ***Prepare a plan for water rescue to respond and deal immediately with accidents; a JHA or equivalent may serve as documentation.***

2. Ensure that a competent person inspects swimming areas for treacherous currents, deep holes, or other hazards. Keep them free of debris and rocks.
3. Designate a person, qualified in water safety, to supervise the activity.
 - a. Assign lifeguards whenever there are swimmers in the water. Have a lookout observing all swimmers all the time. Use a buddy system; no one shall enter the water alone. The swimming area must be equipped with strategically placed life saving equipment, such as reaching-poles, lines, and ring-buoys.
 - b. Do not swim if you are overheated.
 - c. Recognize the symptoms of exhaustion and know what to do.
 - d. Know what to do for cramps, which can be caused by cold water.
 - e. Never dive until water depth and temperature have been checked. Check the location of others before diving.
 - f. Do not swim after dark.
 - g. Monitor the weather.

25.14 – Prescribed Fire. Prepare a prescribed fire burn plan for all prescribed fire projects or activities.

25.14a – Qualifications. All personnel working on prescribed fire projects or activities shall meet the requirements in the Wildland and Prescribed Fire Qualifications System Guide (sec. 25.06).

25.14b – Personal Protective Equipment. The JHA shall specify PPE. Refer to section 25.12 for further direction on PPE.

25.14c – Procedures.

1. Conduct tailgate safety and health sessions to brief employees about equipment and firing devices to be used, as well as:
 - a. Organization, lines of authority, and responsibility.
 - b. Contingency plans.
 - c. Potential hazards associated with burn area.
 - d. Following instructions and maintaining communications.
 - e. Appropriate MSDS.

2. Select the best fuel mixture ratio for each burning job. Authorized mixtures are:

- a. 1 gallon (4 L) of gasoline to 3 gallons (11 L) of diesel.
- b. 1 gallon of gasoline to 4 gallons (15 L) of diesel.
- c. 1 gallon of gasoline to 5 gallons (19 L) of diesel.

Caution: 1 gallon of gasoline to 3 gallons of diesel fuel produces a very volatile mixture. This mix should be used only in appropriate fuel types and during periods of high humidity.

3. Provide water, soap, and towels at all burn sites. Wash smoke residue from face and hands.

25.14d – Safety Practices. Basic safety and health practices are:

1. Have the power company turn off power when prescribed burning is near electrical lines.

- a. Do not put people in the burn area until the power is off.
- b. Always treat powerlines as “hot.”

2. Keep fuel off clothes.

- a. Change fuel-saturated clothing immediately.
- b. Wear plastic impregnated cotton gloves to handle fuel.
Wearing a rubber apron is recommended to protect skin from splashes and spills during drip torch refueling.

3. Transport fuel in approved, labeled containers secured in vehicle beds. Never dispose of fuel by throwing fuel on the ground, into flames, or on the material to be burned.

4. Properly mark all vehicles transporting ignition fuel for hazard identification.

5. Park and secure vehicles hauling flammables/combustibles in a separate, predetermined, safe area.

6. Warn personnel of the hazards of smoke inhalation. Allow personnel to remain in hot corners/smoky areas no more than 10 to 15 minutes.

7. Ensure public safety by providing signs, notices (radio, television, newspaper), and traffic control for hazards, such as restricted visibility and falling or rolling debris. Involve responsible local or State authorities for traffic control if applicable.

25.14e – Tractor Plow Use in Prescribed Fire.

1. **Qualifications.** Operators of Government-owned or leased equipment must be trained, tested, and, where required, have appropriate Forest Service endorsement/authorization.
2. **Personal Protective Equipment.** The JHA shall specify PPE. Refer to section 25.16 for further direction.
3. **Procedures.** The JHA shall define and emphasize machine safety practices.
4. **Safety Practices.** Basic safety and health practices for building control line include:
 - a. Be alert to maintaining machine stability, especially in steep terrain.
 - (1) Follow the manufacturer's recommendations for machine limitations.
 - (2) Use care in prying and lifting operations.
 - b. Use other hand or machine tools as necessary so as not to overextend machine capability.
 - c. As in all fire situations, be alert to the fire's path and progress, hazardous snags, rolling debris, and other people.
 - d. Designate and make clear the escape route(s).
 - e. Equip helper(s) with a radio to maintain contact with the operator and project supervisor.
 - f. Instruct machine operators to be alert to hand signals.
 - g. Use only approved properly labeled safety containers for fuel.

25.14f – All-Terrain Vehicle Use in Prescribed Fire.

1. **Qualifications.** Operators of all-terrain vehicles (ATVs) shall be qualified and able to meet national standards for the type and complexity of the project (sec. 13.21).
 - a. Operators shall be trained in first aid/CPR, hazardous communications, and receive other training as identified in the JHA.
 - b. Personnel shall be trained and certified to use the ignition devices specified in the JHA.
2. **Personal Protective Equipment.** Refer to section 25.12 for direction on PPE.

3. **Procedures.** The JHA shall include a communication plan for operators. Follow all procedures for use of ATVs and prescribed fire (sec. 25.14).

4. **Safety Practices.** A line officer or other competent person shall approve all ATV use for prescribed fires. ATV operators shall be familiar with the specific worksite before ignition and shall not exceed manufacturer's recommendations for safe machine use. In addition, follow these practices:

- a. Identify escape routes and alternates.
- b. Keep the operator and machine in view at all times. Post lookouts with direct communication to operators. Follow the communication plan.
- c. Before ignition, identify brush, snags, obstructions, overhead hazards, rocks, rough terrain, and water hazards.
- d. Clean fuel spills on equipment. If fuel is spilled on clothing, change clothing immediately.

25.14g – Burning Out and Backfiring Operations.

1. **Standards.** The standards for flammable and combustible liquids and hazard communication are in 29 CFR 1910.106 and 1910.1200. The authority for hazardous materials is in 49 CFR Parts 171-179. The approved fuel mixture ratios for ground torch devices are in the Forest Service Ground Ignition Systems Guide available from the Missoula Technology Center in Missoula, Montana (sec. 25.06).

2. **Training.** Employees assigned to burning out and backfiring operations shall be trained to use the ignition devices identified in the JHA.

3. **Personal Protective Equipment.** The JHA shall specify PPE (sec. 25.12).

4. **Procedures.**

- a. Label or placard all containers, devices, and vehicles so employees and emergency response personnel can readily determine the contents. Refer to 29 CFR 1910.1200 and 49 CFR Part 172 for further information.
- b. Provide and discuss the MSDS with employees prior to all burning projects.

5. **Safety Practices.** Follow these basic safety practices for bonding and grounding to prevent static electricity discharges:

- a. When transferring fuel:
 - (1) Make sure the delivery hose/tank and fill spout/receiving container are connected with a bonding wire; or
 - (2) Ground both the fill spout and container before making the fuel connection.
- b. Remove ungrounded containers from vehicles and place them on the ground before filling.
- c. Have at least one fire extinguisher with a rating of at least 10 BC.
- d. Do not use wool, nylon, or other static-generating materials to wipe up spilled fuels.

25.14h – Backfiring Equipment. When handling, transporting, and storing backfiring equipment, comply with hazardous materials rules and laws (sec. 61). Modifications to backfiring equipment or devices shall not be permitted without the written approval of the manufacturer. Only trained, qualified employees are authorized to operate backfiring equipment. Ignition devices include:

1. **Hand-Held Devices.** Matches and electric lighters.
 - a. Use such devices only under the direction and approval of the firing boss.
 - b. Store and carry safety matches in a container that prevents accidental ignition.

2. **Hand-Thrown Devices.** Firing devices include solid-fuel fire starter, fusees, drip torches, plastic bags of gelled fuel, and canister backfiring devices. The firing boss is responsible for issuing devices to trained crew members.

- a. **Fusees.**
 - (1) Carry fusees in the hand, backpack, or manufacturer's shipping carton. Do not carry them in clothing.
 - (2) Strike fusees by holding them at arm's length and pushing outward.
 - (3) Avoid breathing fumes.
 - (4) Do not place burning fusees near explosives or flammable fuels.

- (5) Do not use fusees as safety flares around vehicle accidents.
- b. **Drip torches.** Fill torches away from open flame.
 - (1) Transport drip torches in a container that holds them upright.
 - (2) Use one of the approved fuel mixture ratios stated in section 25.14c.
 - (3) Hold drip torches away from your body when carrying or using them.
 - (4) Saturate the wick; then turn the drip torch upright to light. Extinguish the torch by setting it upright and letting the wick burn dry.
 - (5) Keep fuel off clothes. Change fuel-saturated clothing immediately.
 - (6) Wear plastic impregnated cotton gloves to handle fuel. Wearing a rubber apron is recommended to protect skin from splashes and spills during drip torch refueling.
- c. **Plastic bags of gelled fuel.** The JHA shall include instructions for mixing and use of gelled fuel devices. Follow bonding/grounding safety practices (sec. 25.14g, para. 5).
 - (1) Make sure employees wear an organic vapor respirator, cotton coveralls, and fuel-resistant gloves, eye protection, and apron when mixing gelled fuel.
 - (2) Fill the plastic bags with gelled fuel in a well-ventilated outdoor area.
 - (3) Do not throw plastic bags of gelled fuel by hand. To minimize contact with flammable fuel, put the bag on a shovel blade, light the igniter cord, then throw the bag using the shovel before the bag ignites.
 - (4) Do not stockpile (store) large quantities of pre-made plastic bags of gelled fuel.
- d. **Canisters.** Burnol or other cap and fuse devices.
 - (1) Make fuses at least 3 feet (1 m) long.
 - (2) Always light the fuse with a pull-wire igniter, not matches.
 - (3) Always store, arm, or distribute canisters or other explosive devices in compliance with explosives regulations (sec. 62).

3. **Ground Torch Devices.** These devices include pneumatic torches, power flamethrowers, and propane torches. Follow bonding/grounding safety practices (sec. 25.14g, para. 5).
- a. Make sure the only people in the burn area are those involved in the operation.
 - b. Watch the fire's path to ensure it does not creep back to endanger the operator or the dispensing equipment.
 - c. Watch for leaks around the trigger; repair them immediately if found.
 - d. Provide soap and water for immediate clean up.
 - e. Never operate ground torches from a vehicle.
 - f. **Power flamethrowers.** Keep all fittings tight and in good repair.
 - (1) Use approved fuel mixture ratios (no more than 1 part gasoline to 4 parts diesel) as listed in Forest Service Ground Ignition Systems Guide (sec. 25.14g, para. 5).
 - (2) Carry torch fuel in a Department of Transportation-approved container. Clearly identify the container by painting it red with a yellow band around it. Stencil or paint the name of the contents in yellow on the container.
 - (3) Check fittings and hoses before using.
 - (4) Do not open fuel tanks when equipment is hot or near flames or sparks.
 - (5) Point the torch nozzle in a safe direction before using.
 - g. Propane torches. These devices burn with a very hot flame. Be alert to possible operator fatigue due to radiant heat exposure.
 - (1) Conduct a safety inspection of all propane torches for leakage, tightness of fittings, and integrity of hoses; test the torches prior to use.
 - (2) Use a two-person crew if required by the JHA.
4. **Hand-Held Launchers.** This type of backfiring equipment includes flare pens, signal pistols, fusee and flare launchers, and remote ground ignition launchers. Store pyrotechnic ammunition in a locked cabinet.

5. **Explosive Components and Other Ignition Devices.** This equipment includes slingshot launchers, laser-initiated systems, and other types of complex explosive initiating devices. Comply with requirements in the JHA for using this equipment.

6. **Helitorch and Sphere Dispensers.** These types of backfiring equipment are used with a helicopter.

- a. Store spheres of oxidizer (potassium permanganate) in a cabinet separate from all other reactive chemicals and label or placard the cabinet as instructed by the MSDS.
- b. Store ethylene glycol in a separate cabinet and label or placard the cabinet as instructed by the MSDS.
- c. Do not transport spheres of oxidizer in the same compartment with ethylene glycol.

25.15 – Brushing and Brush Piling.

25.15a – Standards. The standards for PPE and hand tools are in 29 CFR 1910.132 and 1926.301, respectively.

25.15b – Personal Protective Equipment. The following PPE is required for brushing and brush piling:

1. Hardhat.
2. Eye protection.
3. Hearing protection (85 dB and above).
4. Long-sleeved shirt.
5. Gloves.
6. Leather lace-up boots with 8-inch (204 mm) minimum tops and nonskid soles. The JHA may address appropriate footwear for wet weather brush piling projects and activities.
7. Clothing and equipment for chain saw use as set out in section 22.48c.

25.15c – Procedures. Standard procedures for brushing and brush piling are:

1. Keep cutting tools sharp. Guard or sheath tools when carrying them.

2. Exercise caution when:
 - a. Climbing or descending cut banks along roadways.
 - b. Moving across steep side slopes, wet grass, downed brush, snow cover, and downed timber.
 - c. Moving through heavy brush or low branches. Walk single file. Maintain enough distance to avoid being hit by branches.

3. At the worksite, space employees at least 10 feet (3 m) apart to minimize the hazard of being struck by tools or branches.

25.16 – Vehicle Fires. Prepare a JHA to determine if suppression action shall be taken on vehicle fires. If suppression action is authorized by the line officer, adequate PPE, such as self-contained breathing apparatus (SCBA) and turn-out gear, is mandatory. Appropriate training is required. Rely on local fire departments that have the skills and equipment for rescuing occupants and extinguishing vehicle fires. When local assistance is not available, the first priority is safety of personnel.

25.16a – Procedures. In responding to vehicle fires, do not undertake direct attack on vehicle fires unless such action is absolutely necessary to protect life. Only trained employees with appropriate equipment shall engage in the suppression of vehicle fires. Do not attempt to take any action beyond your level of training.

Secure the scene. Isolate the area and ensure the safety of people and the environment. Ask law enforcement personnel to provide traffic control to prevent accidents and interference with firefighting.

When monitoring vehicle fires during non-suppression actions, stay up wind out of the smoke.

Refer to section 12.7 for additional direction.

25.17 – Boat Fires. Refer to section 15.13 for direction.

25.2 – Smokejumping. Refer to section 14 for additional direction on aviation safety.

1. **Qualifications.** Employees involved in smokejumping must meet applicable standards of the smokejumping program and must meet physical requirements.

2. **Personal Protective Equipment.** The JHA shall list required PPE.

3. **Procedures.** Smokejumpers shall have and follow their own Regionally approved JHA. Smokejumping operations and activities shall comply with the following:

- a. FSM 5700, Aviation Management.
- b. FSH 5709.14, Smokejumper and Paracargo Handbook.
- c. Interagency Smokejumper Training Guide.

25.21 – Helicopter Rappelling. Refer to section 14 for additional direction on aviation safety.

1. **Qualifications.** Employees involved in rappelling must meet applicable standards of the rappelling program and must meet physical requirements.

2. **Personal Protective Equipment.** The JHA shall list required PPE.

3. **Procedures.** Rappellers shall have and follow their own Regionally approved JHA. Rappelling operations and activities shall comply with the following:

- a. FSM 5700, Aviation Management.
- b. Interagency Helicopter Operations Guide (IHOG).
- c. Interagency Helicopter Rappel Guide.

25.3 – Law Enforcement. Those employees who have graduated from the Federal Law Enforcement Training Center (FLETC) and who meet the related requirements in FSM 5300 and FSH 5309.11 are authorized to contact disorderly individuals or to enforce laws and regulations when members of the public are involved in violent criminal activity or civil disobedience.

25.31 – Standards. The standards for prohibitions on Forest Service lands are in 36 CFR Part 261. Forest Service law enforcement direction standards are in FSM 5300 and FSH 5309.11.

25.32 – Qualifications. In addition to applicable training and certification listed in section 25.07, written proof is required of certification/recertification of special agents, law enforcement officers, and forest protection officers in accordance with the training identified in FSM 5370, Training Standards and Suitability Requirements.

25.33 – Personal Protective Equipment. The JHA shall identify the PPE required for law enforcement activities (refer to direction in FSM 5300).

25.34 – Safety Practices.

1. **Bloodborne Pathogens.** Refer to direction in section 52.3.
 - a. In any emergency situation involving traumatic injury, take precautions to prevent exposure to bloodborne pathogens.
 - b. Be alert to situations that could create exposure to hepatitis B; for example, abandoned drug lab sites may contain a variety of hazards such as syringes, broken glass, hazardous chemicals, or explosives.
2. **Aerosol Defensive Sprays.** Supervisors of Law Enforcement and Investigations Staff employees certified to carry aerosol defensive spray shall verify that their certification is current and that the employees understand the limitations of the spray agent's use.

25.35 – Firearms. The Chief has the sole authority to issue permission for use of firearms by law enforcement personnel. Regional Foresters, Forest Supervisors, or Station Directors may authorize non-law enforcement personnel to carry firearms when necessitated by functions or circumstances related to official duties (sec. 51.21).

25.36 – Search and Rescue.

25.36a – Authority and Responsibility. Usually the County Sheriff or State Police are responsible for search and rescue (SAR) operations on National Forest System lands. Forest Service employees may provide assistance when requested by the local SAR agency.

1. A memorandum of understanding or interagency agreement may be established with the local SAR agency (FSM 1500 and FSH 1509.11).
2. Forest Service employees should receive instruction from the local SAR agency on recommended emergency procedures.
3. Forest Service employees are authorized to take the temporary lead in the initial stage of a SAR operation only in situations

where personnel from the local SAR agency are not immediately available (FSM 1599.03).

If it becomes apparent that the incident will be extended or that it would benefit from resources available through other agencies, the SAR operation shall be turned over to the responsible SAR agency.

25.36b – Procedures. Basic procedures for SAR are:

1. ***Ensure that rescuers follow safe procedures. Employees must recognize that there are situations where a rescue cannot be accomplished in a safe manner. Employees shall not put their lives in jeopardy, even if the victims are unable to help themselves.***

2. Ensure that a clear command structure is in place. Unless otherwise requested by the local SAR agency, use the Incident Command System for managing emergency operations.

3. Establish and maintain clear communications.

4. Involve only competent, trained personnel.

5. Use proven techniques and equipment.

26 – MANAGEMENT SERVICES. Refer to sections 52.4 and 54 for direction on ergonomic concerns and environmental hazards.

26.07 – Qualifications. In addition to having the applicable training and certification listed in section 21.11, employees shall receive training in the following areas, as warranted:

1. Hantavirus awareness.

2. Use of body fluids protection kits.

3. Hazard communication.

4. Use of chemical agents for self-defense.

5. Requirements for signing.

26.08 – Procedures. Prepare and discuss a JHA (sec. 21.1). Depending on the work project or activity, such as a field trip, include the following:

1. An itinerary listing planned travel route(s), travel dates, destination, and estimated time of departure/arrival.
2. Check-out/check-in system.
3. Name of employees.
4. Emergency phone numbers/communication system and contact points.
5. Other information pertinent to the project or activity. Some items required for the JHA are listed in other documents, such as a district or project safety and health plan, and may be included by reference.

If employees fail to call in or return on schedule, the supervisor shall take actions as required by the JHA.

26.1 – Personnel. [Reserved].

26.2 – Office Safety and Health. Refer to direction in sections 39 and 39.5.

26.3 – Procurement. [Reserved].

26.4 – Recycling.

26.41 – Qualifications. In addition to having the applicable training listed in section 26.07, employees shall be trained in safe lifting/handling techniques (sec. 39.64, para. 2) and operation of trash compactors.

26.42 – Personal Protective Equipment. The JHA shall identify required PPE for recycling activities. Appropriate PPE may include:

1. First aid kit (refer to the Glossary).
2. Gloves that are cut/puncture-resistant, have a good grip, and are impervious to chemicals.
3. Puncture-resistant safety shoes with deep-treaded soles.
4. Eye protection: safety glasses with wrap around or side shields.
5. Hearing protection (85 dB and above).

6. Other equipment, such as coveralls, hardhat with chin strap, or ratchet suspension, and high-visibility outerwear, such as yellow or orange raincoats or safety vests.

26.43 – Safety Practices. Basic safety and health practices for recycling are:

1. Report to the supervisor injuries and potential exposures to the human immunodeficiency virus (HIV), hepatitis B, and hantavirus.

2. Limit bundles, bags, or boxes of recycling materials to not more than 45 pounds (21 kg).

26.5 – Finance and Accounting. [Reserved].

26.6 – Telecommunications.

26.61 – Standards. The safety and health standards for telecommunications are in 29 CFR 1910.29, 1910.66, 1910.67, and 1910.268.

The authorities for fall protection equipment are 29 CFR 1926.104 – 1926.107, 1926.500 – 1926.502, and 1926.959; American National Standards Institute (ANSI) Standards Z10.14-1991 and Z133.1-1994; and American Society for Testing and Materials (ASTM) Standard B117-64.

26.62 – Tower/Pole Climbing.

26.62a – Qualifications.

1. In addition to completing the applicable training listed in section 26.07, employees shall be experienced in climbing techniques before being assigned tower or pole climbing duties.

2. Forest Service employees, other Federal employees, and contract personnel who climb telecommunications towers and poles for the Forest Service must be certified as qualified to climb. To be certified, the individual must successfully complete an approved training course in which the individual has demonstrated proficiency in climbing and has learned about the equipment and hazards associated with telecommunications tower and pole climbing. The trainer must confirm that the individual has met these requirements, and the trainer and the individual's supervisor must concur.

3. Employees shall also be trained in the various precautions and safe practices specific to the work project or activity to be performed. Such specific training shall include, but not be limited to:

- a. Recognition and avoidance of dangers relating to harmful substances and to animal, insect, or plant life.
- b. Procedures to be followed in emergency situations.
- c. First aid/CPR.

4. A qualified climber who has not climbed for 1 year must be recertified to maintain a qualified status. Refresher training courses are recommended every 2 years, mandatory every 3 years.

26.62b – Personal Protective Equipment. The JHA shall identify the specific PPE required, including but not limited to the following:

1. Forest Service-approved utility service high voltage helmet/hardhat.
2. Appropriate ASTM approved hardware for anchors and protection (body harnesses, safety straps, lanyards, D-rings, snap hooks, and buckles).
3. Appropriate footwear (FSM 6716.03, Condition of Hire).
4. Gloves and/or chalk for hand protection.

26.62c – Procedures.

1. Basic procedures for tower/pole climbing include:
 - a. Maintain a written history for each climbing lanyard. The history shall include: date purchased, type, date placed in service, and a usage record (where, when, exposure, inspection date, and comments).
 - b. When provided, always follow manufacturer's guidelines for inspection and replacement of climbing equipment.
 - c. Hold a daily tailgate safety and health session before climbing.
2. The work supervisor shall ensure that:
 - a. A competent person inspects all climbing equipment prior to each day's use to determine that it is in safe, working condition.

- b. Personal fall arrest systems are provided and used when work is performed:
 - (1) At positions more than 6 feet (2 m) above ground, on poles, and on towers.
 - (2) On elevated work platforms, such as aerial, pole, or ladder platforms, and balconies, which do not have adequate railings.
 - (3) At elevated positions, such as poles, towers, or similar structures, which do not have adequately guarded work areas.

3. Tower/Pole Inspections. A competent Forest Service employee or other competent individual must conduct a safety inspection of telecommunications towers and poles and must certify them as "safe to climb" before any further climbing takes place. A competent individual is defined as one who, because of training, experience, and authority, is capable of identifying and correcting hazardous conditions in telecommunications towers and poles, fall arrest systems, or any component thereof (refer to the Glossary).

- a. At a minimum, base a decision that a telecommunication tower or pole is safe to climb, on the condition of the tower or pole and the adequacy of its fall arrest system.
- b. Prior to a climb, prepare and discuss a site-specific JHA for telecommunications towers and poles that have not been inspected and certified as "safe to climb," but which require emergency repairs, to determine if an experienced certified climber can safely climb and accomplish needed emergency repairs. If it is determined that a safe climb cannot be accomplished, do not allow personnel or contractors to ascend the tower or pole. Take alternative measures to meet the telecommunication requirements until the tower or pole is repaired or modified to allow for safe climbing.

26.62d – Safety Practices. Undertake work activity on a tower or climbing poles only with adequate planning and knowledge of safety practices. Some basic safety practices are:

- 1. Prearrange and test a communication system before climbing.

2. Ensure that the climbing party consists of a minimum of two qualified employees. Solo climbing and free soloing (climbing alone and climbing without safety equipment) shall not be permitted without written approval from the line officer or other authorized person.

3. Ensure that a competent person inspects the pole "climbers" (refer to the Glossary) before each day's use for the following conditions:

- a. Fractured or cracked gaffs or leg irons.
- b. Loose or dull gaffs.
- c. Broken straps or buckles.

If any of these conditions exist the defect must be corrected before the pole climbers are used.

4. Do not use pole climbers if the gaffs are less than 1-1/4 inches (32 mm) in length, measured on the underside of the gaff.

5. When gaffs are used on a day-to-day basis, perform a gaff cut-out test at least weekly.

6. Do not wear pole climbers when:

- a. Working in trees (specifically designed tree "climbers" shall be used for tree climbing).
- b. Working on ladders.
- c. Working in an aerial lift.
- d. Driving a vehicle.
- e. Walking on a rocky, hard, frozen, brushy, or steep terrain.

7. Always cover the gaffs of pole climbers with safety caps when not being used.

27 – ENGINEERING.

27.01 – Authority.

1. Forest Service direction regarding health and safety requirements in the engineering program is in FSM 7100, Engineering Operations; FSM 7160, Signs and Posters; FSM 7400, Public Health and Pollution Control; FSM 7500, Water Storage; FSM 7510, Project Administration; FSM 7700, Transportation System; FSM 7730, Operation and Maintenance; and FSM 7731.2, Structures.

2. American Welding Society, American Standard Safety in Electric and Gas Welding and Cutting Operations (available at trade vocational schools).
3. American National Standards Institute (ANSI), Z49.1: Safety in Welding and Cutting.
4. National Fire Protection Association. NFPA 33: Spray Application Using Flammable or Combustible Materials; NFPA 70: National Electrical Code. Quincy, MA.
5. U.S. Department of Agriculture, Forest Service. Guidelines for Forest Signs and Posters. EM 7100-15. U.S. Government Printing Office, Washington, DC.
6. U.S. Department of Transportation, Federal Highway Administration. Manual on Uniform Traffic Control Devices. U.S. Government Printing Office, Washington, DC.
7. Water Pollution Control Federation. Safety and Health in Wastewater Systems. Manual of Practice 1. MO2001GB. Water Environment Federation, Alexandria, VA.

27.1 – Engineering Operations.

27.11 – Qualifications. Employees shall receive appropriate training for the specific work project or activities. Use the Engineering Certification Program to evaluate employee competency before assigning specific duties.

In addition to having the applicable training and certification listed in section 21.11, employees shall receive training in:

1. First aid/CPR.
2. Hazard communication.

27.12 – Procedures. Engineering projects involve a variety of work skills and knowledge. Worksites can include roadsides, bridges, and other places where there is traffic. Follow these basic safety and health practices:

1. Set temporary traffic controls. Methods include signs, flag persons, and traffic control devices. Wear high-visibility vests when required by the JHA.

2. Refer to sections 52.4 and 54 for information on ergonomic concerns and environmental hazards.

Prepare and discuss a JHA for specific work projects and activities (sec. 21.1). Include the following:

1. An itinerary listing planned route(s) of travel, date of travel, destination, and estimated time of departure/arrival.
2. Check-out/check-in system.
3. Names of employees.
4. Emergency phone numbers/communication system and contact points.
5. Other information pertinent to the project or activity.

If employees fail to call in or return on schedule, the supervisor shall take those actions required in the JHA.

27.13 – Surveying. The full range of surveying services includes land surveys, preconstruction and construction surveys, and geodetic and control surveys.

27.13a – Qualifications. In addition to having the applicable training and certifications listed in section 22.07, employees shall be trained in the use of small handtools such as sandviks and hammers. Refer to sections 61.11 and 61.14 for emergency response training requirements.

27.13b – Personal Protective Equipment. The following PPE is required for surveying.

1. First aid kit (refer to the Glossary).
2. Eye protection and sunscreen.
3. Appropriate footwear.
4. High-visibility vest when on public roadways and during hunting season.
5. Warning signs to alert motorists and hunters.
6. Additional PPE as identified in the JHA such as gloves and hardhats.

27.13c – Safety Practices.

1. **Local Practices.** Inquire locally for specific safety and health concerns and practices.

2. **Clearing.** Clear the survey line of brush and debris. Remove all cut and loose material. Cut down logs or notch 10 inches (255 mm) minimum width horizontally. Cut stumps as close to the ground as possible.

3. **Surveying.**

- a. When walking, keep at least one hand free for protection against falls or obstructions.
- b. Continually look and listen for snakes and other animal/insect hazards.
- c. Use extreme caution when using metallic tapes or chain in the vicinity of electrical lines. If possible, use nonmetallic cloth tapes or automatic distance measuring methods. Do not use metallic tapes or chain during lightning storms.
- d. When crossing a railroad track, do not allow a metal chain to contact both rails. Cover rails with lengths of split firehose or similar material.
- e. Make sure survey crews wear safety harnesses and lifelines when working on cliffs, rock bluffs, or high steep roadbanks. Ensure all crewmembers are appropriately trained for such exposed work (sec. 33).
- f. When working near electrical lines and hazardous areas, consider additional safety precautions such as avoiding long measurements across canyons and using the offsetting method.

27.14 – Sign Installation/Maintenance. The Forest Service uses signs and posters to provide a variety of information for visitors, users, cooperators, and employees, and to support management programs.

27.14a – Qualifications. In addition to having the applicable training listed in section 22.07, employees involved in sign installation/maintenance shall be skilled in the use of hand and power tools (sec. 41 and 43).

27.14b – Personal Protective Equipment. The following PPE is required for sign installation and maintenance.

1. First aid kit (refer to the Glossary).
2. Gloves.
3. Hardhat.
4. Eye protection.
5. Additional PPE as identified in the JHA.

27.14c – Procedures. All recreational, construction/reconstruction sign use, including traffic control devices, shall conform to standards and guidelines as specified in section 27.01.

27.14d – Safety Practices. Basic safety and health practices include:

1. Post warning signs and/or traffic control devices when Forest Service employees or contractors are working in areas exposed to motorized traffic.
2. When posting restricted-area signs, such as for “Administrative Use Only,” be aware of the potential for confrontations with some members of the public.

27.15 – Gravel Pit and Rock Quarry Operations.

27.15a – Standards. The standards for PPE and excavation are in 29 CFR 1910.132, 1926.28, and 1926.650.

The standard for training of miners and mine safety is in 30 CFR Parts 48 and 56.

27.15b – Qualifications. In addition to having the applicable training and certification listed in section 22.07, employees shall be familiar with Federal safety requirements.

27.15c – Personal Protective Equipment. The following PPE is required for all pit/quarry operations.

1. First aid kit (refer to the Glossary).
2. Hardhat.

3. Eye protection.
4. Hearing protection (85 dB and above).
5. Additional PPE identified in the JHA.

27.15d – Procedures. Before beginning any pit/quarry operations, prepare a Pit/Quarry Plan.

27.15e – Safety Practices. Basic safety and health practices for gravel pit and rock quarry activities are:

1. Eliminate or minimize the hazards for operating activities, such as maintaining wall, bank, and slope stability, by using proper equipment and methods.
2. Identify in the JHA a competent person to examine the work area after rain/freeze/thaw before work resumes. Require a blaster to inspect after a blast; however, another person may be designated in the JHA to assist the blaster after the blast. Check surfaces for cracks that could result in rocks' breaking free and falling.
3. When conditions exist that present imminent danger, evacuate all employees from the area affected until the danger is abated.
4. Remove overhanging banks immediately. Begin at the side and progress toward the middle. Always face the point of danger. Have a competent person determine if fall protection and training are needed (sec. 33).
 - a. Pry boulders from upslope to prevent them from falling on you or others. Allow no workers below boulders being loosened.
 - b. Remove loose rock on pit/quarry faces frequently. Do not work below such dangerous areas until hazards have been removed.
5. Do not allow employees to perform work alone in any pit or quarry unless effective communication is in place.
6. Do not permit employees to work between equipment and the pit/quarry wall.
7. Never operate equipment on or near the rim of a pit/quarry.

8. Fence and use signs around pits/quarries when hazards exist such as slope instability or blasting.

27.2 – Buildings and Related Activities.

27.21 – Carpentry. Carpentry activities include constructing, finishing, and repairing wooden objects and structures.

27.21a – Standards. The standards for occupational safety and health standards and safety and health regulations for construction are in 29 CFR Parts 1910 and 1926 (refer to specific project standards).

27.21b – Qualifications. In addition to having the applicable training listed in section 22.07, employees shall be experienced in or trained to use all tools and machinery required for specific projects (sec. 41, 42, and 43).

27.21c – Personal Protective Equipment. The JHA shall identify the PPE required for the specific work project or activity (29 CFR 1910.132 and 1926.100 – 1926.107).

27.21d – Procedures. Prepare a JHA and project work plan and ensure that they are discussed with all employees involved in a work project or activity.

27.21e – Safety Practices. All carpentry work projects and activities must conform to specific safety and health practices for tools and techniques outlined in this chapter, chapters 30 and 40, and CFR 29 Parts 1910 and 1926.

27.22 – Painting.

27.22a – Standards. The standards for general requirements, ventilation, flammable and combustible liquids, and electrical requirements are in 29 CFR 1910.22, 1910.94, 1910.106, 1910.107, and 1910.303.

The authority for housekeeping is in 29 CFR 1926.25.

27.22b – Qualifications. Employees shall receive applicable training listed in section 22.07, in addition to other training warranted by the work project or activity.

27.22c – Personal Protective Equipment. Employees shall wear appropriate PPE as identified in the JHA and specified in the MSDS for the particular product.

27.22d – Procedures. Prepare a JHA for the storage, preparation, application, and clean-up of paint for all painting work projects and activities.

27.22e – Safety Practices. Basic safety and health practices for work projects and activities using paint and associated products are:

1. **Paint Storage.**

- a. Follow MSDS instructions for storage and disposal.
- b. Store flammable or combustible paint materials in well-ventilated buildings or fireproof cabinets designed for that purpose.
- c. Store volatile painting materials in approved containers which are clearly marked to identify contents. Do not keep more materials on a work project than is required for one day's use.

2. **Housekeeping.** Spontaneous combustion may ignite oil- and paint-soaked rags, paper, and sponges. Store them in approved, covered metal receptacles and dispose of them daily.

- a. Store paint-soiled clothing and drop cloths in well-ventilated metal cabinets; launder soiled cloths and clothing periodically.
- b. Before removing any paint, test for lead content. Construction activities where an employee may be exposed to lead, are subject to OSHA regulations (sec. 27.22a). Refer to section 61.9 for further direction concerning lead.
- c. Remove paint scrapings and debris from the premises daily.
- d. When scraping or using liquid paint remover, protect eyes and skin. Follow the manufacturer's instructions on the containers of all products and MSDS safety guidelines.
- e. When working with oil-based paint wear NIOSH-approved respirators.

3. Ventilation.

- a. Ventilate the area when mixing or using oil-based paints or materials.
- b. When removing paint with heat or chemicals, provide appropriate breathing apparatus. Ventilation for spray painting must comply with OSHA standards. Refer to 29 CFR 1910.134.

4. Spray Painting. Open flames, exposed heating elements, or any other ignition sources are not permitted in spray painting areas.

- a. The supervisor shall ensure that spray paint booths and equipment meet the requirements in 29 CFR 1910.107 and NFPA 70 National Electrical Code (sec. 27.01).
- b. When painting indoors, provide positive ventilation. Provide respirators as needed to protect employee health. The nature of the work being performed shall dictate the type of respirators to be provided (ex. 01).

27.22e – Exhibit 01 – Spray Painting

Eye protection

Correct respirator
clean and serviceable

Respirators should be:

- Snug fitting
- Sterilized and inspected before each job
- Renewed as manufacturer recommends
- Stored in a clean, dry box
- NIOSH approved

Management shall establish and maintain a respiratory protection program that includes the requirements outlined in 29 CFR 1910.134 and section 21.13.

- c. Sterilize and inspect the respirator before each new job begins or at least weekly.
- d. Replace filters or chemical cartridges as recommended by the manufacturer.
- e. Store respirators in a convenient, clean location.

5. **Sandblasting.** The first-line supervisor will ensure the competency of employees before sandblasting.

- a. When sandblasting, air-supplied sandblasting hoods are required. Refer to 29 CFR 1910.134 and 1926.103.
- b. Test the purity of the breathing air inside the hoods before the start of each work shift.

27.23 – Welding and Cutting. Principal hazards are shock and burns from the electric current, eye and skin injury from ultraviolet and infrared radiation, and internal injury from fumes. Hot metals or sparks can also burn skin.

27.23a – Standards. The standards for welding requirements are in 29 CFR 1910.251, 1910.252 and 1926.350 – 1926.354; 42 CFR Part 84; American Welding Society, American Standard Safety in Electric and Gas Welding and Cutting Operations (sec. 27.01); American National Standards Institute (ANSI), Z49.1: Safety in Welding and Cutting; and NFPA 51 and 51B.

27.23b – Qualifications. In addition to ensuring that employees have the applicable training listed in section 22.07, use only accomplished welders. Determine competency by:

1. Standards of the American Welding Society, State and local vocational training courses, and trade unions.
2. Practical work experience.

Prior to beginning welding projects, supervisors shall assess employee competency.

27.23c – Personal Protective Equipment. The JHA shall specify the type of PPE required for the work project or activity. Normally this PPE includes:

1. Welder's face shield or goggles with a proper shade for eye protection. Exhibit 01 is a guide for the selection of proper shade number. These recommendations may be varied to suit the individual's needs.
2. Head protection such as a leather skull cap and/or hardhat.
3. Flameproof gauntlet welding gloves, vest, apron, cape, shoulder covers, and flame-resistant clothing.
4. Steel-toed boots.
5. Hearing protection (85 dB and above).
6. Respiratory protection as identified by the JHA or MSDS.

27.23d – Procedures. Prepare a JHA for each type of material to be welded and cut. Specify the welding and cutting procedures to be used (sec. 22.08).

27.23e – Safety Practices. Follow these basic safety and health practices for welding.

1. **Ventilation.** Provide adequate ventilation when welding and cutting in confined places. When adequate ventilation is not possible, provide welders with air-line respirators. Refer to exhibit 01 and section 38.2 for further direction.
2. **Toxicity.** The JHA and MSDS shall identify the toxicity of materials used. Common materials that may give off hazardous substances include:
 - a. Fluoride compounds: often found in cleaning materials.
 - b. Zinc: found in culverts and other galvanized materials.
 - c. Lead: found in lead-based metals, plumbing lead, and lead-based paints.
 - d. Cadmium: found in certain alloys used in making bolts and other fasteners and present in silver solder and other fluxes.
 - e. Stainless steel: found in stainless steel rod and materials.
3. **Equipment.** Inspect hose lines, connections, and welding cables.
 - a. Test for gas leaks with soapy water only; never use an open flame.

27.23c – Exhibit 01 – Filter Lens Shade Number For Protection Against Radiant Energy

| <i>Welding operation</i> | <i>Shade no.</i> |
|--|------------------|
| Shielded metal-arc welding 1/16-, 3/32-, 1/8-, 5/32-inch (1-1/2-, 2-1/2-, 3-1/4-, 4-mm) electrodes | 10 |
| Gas-shielded arc welding (nonferrous) 1/16-, 3/32-, 1/8-, 5/32-inch electrodes | 11 |
| Gas-shielded arc welding (ferrous) 1/16-, 3/32-, 1/8-, 5/32-inch electrodes | 12 |
| Shielded metal-arc welding 3/16-, 7/32-, 1/4-inch (5-, 5-1/2-, 6-1/2-mm) electrodes | 12 |
| 5/16-, 3/8-inch (8-, 9-1/2-mm) electrodes | 14 |
| Atomic hydrogen welding | 10 to 14 |
| Carbon-arc welding | 14 |
| Soldering | 2 |
| Torch Blazing | 3 or 4 |
| Light cutting, up to 1 inch (25-1/2 mm) | 3 or 4 |
| Medium cutting, 1 to 6 inches (25-1/2 to 153 mm) | 4 or 5 |
| Heavy cutting, over 6 inches (153 mm) | 5 or 6 |
| Gas welding (light), up to 1/8 inch (3-1/4 mm) | 4 or 5 |
| Gas welding (medium), 1/8 inch to 1/2 inch (3-1/4 mm to 12-3/4 mm) | 5 or 6 |
| Gas welding (heavy), over 1/2 inch (12-3/4 mm) | 6 or 8 |

Note: In gas welding or oxygen cutting where the torch produces a high yellow light, it is desirable to use a filter or lens that absorbs the yellow or sodium line in the visible light of the operation.

27.23e – Exhibit 01 – Minimum Airflow To Maintain Velocity of 100 Linear Feet Toward Hood

| <i>Welding zone in inches (millimeters)</i> | ¹ <i>Minimum airflow in cubic feet/minute (cubic meters/minute)</i> | ² <i>Duct diameter in inches (millimeters)</i> |
|---|--|---|
| 4 to 6 from arc (102-153 mm) | 150 (4-14 cmm) | 3 (76-1/2 mm) |
| 6 to 8 from arc (153-204 mm) | 275 (7-4/5 cmm) | 3-1/2 (89-1/4 mm) |
| 8 to 10 from arc (204-255 mm) | 425 (12 cmm) | 4-1/2 (114-3/4 mm) |
| 10 to 12 from arc (255-306 mm) | 600 (17 cmm) | 5-1/2 (140-1/4 mm) |

¹ When brazing with cadmium bearing materials or when cutting on such materials, increased rates of ventilation may be required.

² Nearest half-inch duct diameter based on 4,000 feet per minute velocity in pipe.

- b. Use acetylene at 15 psi (103 kilopascals) pressure or less.
- c. Never directly inhale the gas from either acetylene or oxygen cylinders.
- d. Do not connect cylinders to pipes or manifolds.
- e. Do not transfer gases from one cylinder to another.

4. **General Welding.** Never weld near wood scraps, shavings, sawdust, paper, grease-soaked rags, or volatile materials such as gasoline or solvents.

- a. Provide shielding when welding near wood planking, scaffolds, or other combustibles.
- b. Provide appropriate eye protection, shades, shields, or barriers during welding operations for employees and other bystanders in area.

5. **Arc Welding.** Provide sufficient electrical circuiting for the welding machine. Check electrical connections before starting work. Do not use cables needing repair.
- a. ***Do NOT arc weld within 200 feet (60 m) of flammable solvents unless you are shielded. Poisonous gas or explosion can result from heated solvents.***
 - b. Ensure that insulation, protective coverings, and electrode holders are in good condition and safe. Only rubber-covered cable, without splices, is permitted within 10 feet (3 m) of the electrode holder.
 - c. Insulate exposed cables on metal lead connection lugs. Keep cable out of the way and off the floor, especially across aisles or crosswalks. Make sure equipment never passes over cables. Protect leads so workers do not trip over them.
 - d. Keep welding leads clear of the primary leads of electric motor-operated welders. Electric motors may blow toxic materials into employee work area.
 - (1) Ground material being welded as close as possible to the weld.
 - (2) Use insulated platforms in wet places.
 - (3) Do not weld near batteries.
 - (4) Turn off a welding machine whenever work is stopped.
6. **Storage.**
- a. Store equipment and supplies in dry, protected areas.
 - b. Do not leave rods and stingers out when not in use.
 - c. Ensure labels and operating instructions are legible.
7. **Oxygen-Fuel Cutting and Welding.**
- a. Always read the manufacturer's operating instructions prior to using equipment. Follow the manufacturer's operating instructions at all times.
 - b. Inspect the torch before use. Connections must be tight to avoid ignition inside the tip and possible explosion. Inspect the filter in the inlet nipple of oxygen regulators to ensure that the filter is in place and is clean. If the filter is missing, have the regulator inspected and cleaned, and have the filter replaced by a qualified repair shop.

- c. Keep oxygen cylinders, cylinder valves, couplings, regulators, hoses, and apparatus free from oil, grease, and other flammables or explosive substances. Do not handle oxygen cylinders or apparatus with oily hands or gloves.
- d. Have at least one special cylinder wrench available for immediate use. Cylinders not having fixed hand wheels shall have keys, handles, or nonadjustable wrenched-on valve stems while in service so that the gas flow can be turned off quickly in case of emergency.
- e. Always close the cylinder valves whenever the equipment is unattended.
- f. Always drain the regulator. Before a regulator is removed from a cylinder, close and release the cylinder valve and release the gas from the regulator.
- g. Always slightly open the cylinder valve. Before removing a regulator from a cylinder, close the cylinder valve and release the gas from the regulator.
- h. Perform these steps after the regulator is attached to oxygen cylinders:
 - (1) Engage the adjusting screw and open the downstream line to drain the regulator of gas.
 - (2) Disengage the adjusting screw and open the cylinder valve slightly so that the regulator cylinder pressure gauge moves up slowly before opening the valve all the way.
 - (3) Stand to one side of the regulator and not in front of the gauge face when opening the cylinder valve.
- i. Always leak-test the connection after assembly and before lighting the torch. Do not use flames.
- j. Follow the manufacturer's instructions for lighting, adjusting, and extinguishing torch flames. Use a friction lighter, stationary pilot flame, or other suitable source of ignition. Never use matches, cigarette lighters, or welding arcs.
- k. Use pressure reducing regulators only for the gas and pressure for which they are labeled.
- l. Always ascertain that gauges used for oxygen service are marked "USE NO OIL."

- m. Have repair maintenance for regulators or parts of regulators (including gauges) performed by qualified technicians.
- n. Do not use acetylene pressure above 15 pounds per square inch gauged (psig) or 103 kPa.
- o. Do not leave pressure on a regulator when not in use.

8. **Cylinder Handling.** Handle cylinders carefully to avoid damage and prevent leaks.

- a. Before moving cylinders, close valves and secure the valve protection cap. Do not lift cylinders by valves or caps.
- b. Move cylinders by tilting and rolling them on the bottom edge. Never drag or slide them.
- c. If a gas cylinder was temporarily placed in a horizontal position when being transported, make sure it is positioned upright for at least 2 hours before use.

9. **Cylinder Storage.** Place acetylene and oxygen cylinders upright for storage and use.

- a. Provide a cylinder truck or rack to prevent cylinders from being upset. Chain or otherwise secure them to prevent tipping.
- b. Store oxygen cylinders in a dry location away from heat sources and flammable/combustible materials and at least 20 feet (6 m) from acetylene.

27.24 – Demolition.

27.24a – Standards. The standards for demolition operations are in 29 CFR 1926.850 – 1926.860.

27.24b – Qualifications. Employees shall receive the applicable training listed in section 22.07 in addition to other training, as warranted.

27.24c – Personal Protective Equipment.

- 1. Hardhat.
- 2. Gloves.
- 3. Eye protection.

4. Safety-toed or equally effective footwear (metatarsal-ANSI Z41) (sec. 21.13).

27.24d – Procedures. Before permitting work, conduct an engineering survey of the structure to determine the condition of framing, floors, and walls, and the possibility of collapse of any portion of structure. Ensure that this survey is performed and documented by a competent person. ***Map out a definite procedure, and follow it closely throughout the entire course of the job.***

1. Secure the area from public exposure.
2. Protect adjacent buildings and property against damage.
3. Shut off, cap, or reroute utility services before starting work.
4. Ensure that suitable fire protection is available.

27.24e – Safety Practices. Conduct activities in such a manner as to avoid hazards encountered in demolition work. Such hazards include:

1. Material carelessly thrown aside or escaping from a material chute.
2. Accumulation of loose debris at the site.
3. Chimneys left in unstable positions or toppled as a whole.
4. Inadequate fire protection.
5. Falling objects.
6. Special hazards present during removal of beams that may be embedded in the wall.
7. Hazardous chemicals, asbestos, or other dangerous substances.

27.25 – Trams. Trams include hand-operated devices for stream crossings and gaging.

27.25a – Qualifications. In addition to having applicable training listed in section 22.07, employees shall be trained in tram use and safety.

27.25b – Personal Protective Equipment. The JHA shall identify the specific PPE required for tram operation.

27.25c – Safety Practices. Ensure that inspections are conducted by a competent person. Basic safety practices for tram operation include:

1. Inspect cable system before use.
2. Ensure ample clearance exists between tram and ground or water.
3. Tie down loose equipment with safety straps to prevent loss.
4. Do not overload tram.
5. Permit personnel to put their hands on the main cable while a tram is moving only when it is necessary to pull the tram.
6. Stop tram operations during high winds.
7. Lock up trams when finished to prevent unauthorized use.

27.3 – Public Health and Pollution Control.

27.31 – Wastewater Treatment. Wastewater treatment systems, such as disposal facilities at recreation and administration sites, present special hazards for employees. Examples of such systems include septic tanks, toilet vaults, composting toilet basements, drainfields, and lagoons.

27.31a – Standards. The standard for respiratory protection, sanitation, and confined spaces is in 29 CFR 1910.134, 1910.141, and 1910.146.

The standard for safety training and housekeeping is in 29 CFR 1926.21 and 1926.25.

27.31b – Qualifications. In addition to having the applicable training listed in section 22.07, operators and operation/maintenance technicians shall be familiar with permits and standards of the system. Operators shall be State-certified in wastewater treatment where required. Employees working in wastewater treatment shall implement all safety/health requirements.

Employees must possess knowledge of rescue equipment and techniques, dangers of waterborne disease, electrical hazards,

lock-out/tag-out procedures, air-monitoring equipment, and proper use of respiratory protective equipment.

Supervisors shall ensure employees keep immunizations current for diphtheria, tetanus, and, as warranted, other diseases. Maintain current records of immunizations.

27.31c – Personal Protective Equipment. After considering all factors, such as specific activity and work project location, identify required PPE in the JHA.

27.31d – Procedures. As part of a safe, healthy, and efficient operation and maintenance program, all wastewater treatment systems shall be operated in conjunction with an operation and maintenance manual written specifically for the treatment facility.

27.31e – Safety Practices. Basic safety and health practices are:

1. **Confined Space.** When working in or around an area that has been identified as a confined space, employees shall follow additional regulations and guidelines listed in section 38.2.
 - a. **Manhole covers.** Remove manhole covers with a hook lifter; never use a pick or shovel. Lay covers flat on the ground at least 3 feet (1 m) from the opening.
 - (1) Never leave a cover partially over a shaft.
 - (2) Provide barriers and warning devices if the cover is removed.
 - (3) Use a lip ring to keep rocks, tools, and other materials from being dropped or kicked into the shaft.
 - (4) Take precautions to avoid rats, as well as spiders, ants, and other stinging and biting insects that may be found inside and outside sewers and manholes (sec. 53).
 - b. **Entry ladder.** Inspect ladder rungs for soundness before using.
 - (1) Expect rungs to be slippery.
 - (2) Wear skid-resistant boots.
 - c. **Deep shafts.**
 - (1) Determine the presence of oxygen and gases and continuously monitor conditions. These areas are usually considered permit-required confined spaces. Refer to section 38.2 for further direction.

- (2) Station two employees outside the hole at all times. They must be trained in worker extraction techniques in case of accident.
 - d. **Open flame.** Do not use open flames until adequate ventilation is established.
2. **Chlorine Gas.** The supervisor in charge shall prepare an emergency procedure plan for any wastewater treatment system using chlorine gas. Review the plan at least quarterly.
 - a. Make sure chlorine gas storage rooms are ventilated.
 - b. Post a chlorine gas detector badge near storage entrances to aid in leak detection.
 - c. Have an approved self-contained breathing apparatus (SCBA) and a repair kit for the gas cylinder available outside of chlorine storage room(s). Limit use of this equipment to those trained in its use.
3. **Personal Hygiene.** Provide employee with training and refresher courses regarding the dangers of waterborne diseases.
 - a. Wear rubber or vinyl gloves to prevent direct contact with raw sewage.
 - b. Wash hands before eating.
4. **First Aid.** Treat even minor cuts and wounds immediately.
5. **Electrical Hazards.** In front of electrical switchboards, install permanent rubber mats that meet the latest ANSI J6-7-1935 standards (sec. 36.13).
 - a. Before working on electrical equipment, unplug it and use the lockout/tag-out procedure (sec. 38.3).
 - b. Use electrical ground fault interrupters (GFI).
6. **Bloodborne Pathogens.** See section 52.3 for direction on bloodborne pathogens.
7. **Traffic Control.** Post warning signs, traffic control devices, or both when employees or contractors must work near motorized traffic.

27.4 – Water Storage and Transmission.

27.41 – Dam Inspections.

27.41a – Standards. The standards for permit-required confined spaces are in 29 CFR 1910.146.

27.41b – Qualifications. In addition to having the applicable training listed in section 22.07, employees conducting inspections shall be specifically trained for and regularly assigned to work involving similar types of inspections (FSM 7531.1).

1. Inspectors conducting underwater inspections shall be certified scuba divers (sec. 22.62b).

2. Inspectors operating watercraft as part of underwater or surface inspections shall meet the qualifications pertaining to the specific watercraft (sec. 15).

27.41c – Personal Protective Equipment. The type of dam and the method of inspection shall determine the required PPE. Identify PPE in the JHA.

27.41d – Procedures. In accordance with FSM 7513, qualified engineers are required for:

1. Supervising site investigation work.
2. Designing all dams and water transmission systems.
3. Supervising or monitoring the inspection of construction activities.
4. Supervising or monitoring safety inspections, emergency action plans, and operation and maintenance plans.
 - a. Develop an emergency action plan and keep the current plan on file for all high hazard dams and for new or proposed dams during the design stage (FSM 7521.03).
 - b. If an emergency action plan is required (FSM 7517), ensure the plan is available to key personnel listed in the plan.

27.41e – Safety Practices.

1. **Informal Inspections.** When any employees are in the vicinity of a Forest Service dam (or special use dam), they should

observe the overall condition and function of the structure. Immediately report to the forest officer responsible for dams any unusual conditions that seem critical or dangerous. Pay particular attention to evidence of (or changes in) leakage, erosion, sinkholes, boils, seepage, slope instability, undue settlement, displacement, tilting, cracking, deterioration, improper functioning of drains, and relief wells (FSM 7516.11).

2. **Special Inspections.** An experienced and qualified engineer may be required to make a special inspection if significant problems are noted during an informal inspection. Special inspections are also recommended after floods, earthquakes, or other unusual events that may have resulted in significant damage.

3. **Operation and Maintenance Inspections.** Qualified personnel shall conduct periodic inspections of dams and maintain records of inspections and follow-up activities and take actions necessary to document inspections and document actions taken to correct deficiencies. A qualified engineer shall periodically review operation, maintenance, and inspection records and shall make a thorough inspection of each structure located on National Forest System lands (FSH 7509.11, ch. 30).

4. **Safety Inspection and Hazard Assessment.** Safety inspections of Forest Service owned dams are made by teams of Forest Service engineers, engineering geologists, and allied technical people, and should include personnel who were involved in recent operation and maintenance inspections. Safety inspections performed by other responsible agencies or licensed engineers by contract are acceptable (FSH 7509.11, ch. 40).

Ensure that high hazard dams undergo an inspection and evaluation for the purpose of protecting human life and property at periodic intervals not to exceed 5 years. Perform and document hazard classification reviews at least every 5 years for moderate and low hazard dams.

5. **Walking Surfaces.** Walking surfaces shall be carefully inspected before use. Surfaces may be slippery due to water, moss or algae growth. Winter conditions increase walking surface hazards.

6. **Water Depth.** Where water depths warrant, the JHA may require wearing an approved PFD.

7. **Burrow Holes.** Employees working at embankment dams shall be alert for animal burrow holes on the up or down stream slope of such dams.

8. **Sink Holes.** Employees shall be alert for sink holes on or in the vicinity of embankment dams. Sink holes are visible as circular depressions in the ground. They can create hazardous, unstable ground conditions and walking areas.

9. **Animals/Insects.** Employees shall be alert for vegetation, inspection shafts, machinery tunnels, and spaces that provide cover for poisonous snakes, stinging and biting insects, and rodents (sec. 53).

10. **Electrical/Mechanical Hazards.** Dam operating machinery shall be activated only by competent persons.

11. **Confined Spaces.** In confined spaces, such as mechanical inspection shafts, conduit tunnels, or water conveyance structures, employees shall follow all safety and health procedures for working in confined spaces (sec. 38.2).

12. **Beaver Dams.** When work projects and activities require employees to work around beaver dams, the JHA shall address the associated hazards.

27.5 – Electrical. [Reserved].

27.6 – Transportation.

27.61 – Bridge Inspections.

27.61a – Qualifications. Bridge inspectors shall meet the specific qualifications identified in FSM 7731.24b. Employees shall receive applicable training listed in section 22.07 and other training as warranted.

27.61b – Personal Protective Equipment. The JHA shall identify site-specific PPE. Items to consider are:

1. First aid kit (refer to the Glossary).

2. Hardhat.
3. High-visibility vest.
4. Eye protection.
5. Dust mask or NIOSH approved respirator.
6. Gloves.
7. Appropriate footwear.
8. Lifelines.
9. Coast Guard approved PFD.

27.61c – Procedures. General procedures are:

1. Do not conduct inspections alone on a bridge over swift or deep water.
2. Ensure that inspectors working over swift or deep water have appropriate training and wear lifelines and a Coast Guard approved PFD.

27.62 – Road Maintenance. A maintenance standard that addresses public safety concerns is required for road maintenance projects; this standard may be part of the JHA.

27.62a – Qualifications. In addition to having the applicable training listed in section 22.07, employees shall have the appropriate operator's license(s) and any endorsements required for the type of vehicle/equipment that they are assigned to operate.

27.62b – Personal Protective Equipment. Because location and weather can affect road maintenance activities, individual work projects or activities should dictate the specific PPE recommended or required. The JHA shall identify appropriate PPE. Such PPE includes:

1. First aid kit (refer to the Glossary).
2. Hardhat.
3. Eye protection.
4. Hearing protection (85 dB and above).

5. High-visibility vest.
6. Dust mask.
7. Appropriate footwear.

27.62c – Procedures. Perform specific road maintenance activities in accordance with procedures listed in FSM 7730 and chapter 40 in this Handbook.

27.62d – Safety Practices. Basic safety and health practices are:

1. Post signs on the road about the work being performed and the type and volume of traffic expected. Post warning signs before slide and slump areas.
2. Keep brush back to provide adequate sight distances.
3. From upper roadbanks, remove snags, overhanging down logs, and large rocks that may fall onto the road.
4. Prevent excessive berm buildup on the center and sides of regularly used roads.
5. Repair undercut roads to prevent cave-ins. Maintain roads to assigned levels at all times.

27.63 – Clearing (Roadside and Land).

27.63a – Standards. The standards for site clearing are in 29 CFR 1926.604.

27.63b – Personal Protective Equipment. PPE required for roadside and land clearing includes:

1. Hardhat.
2. Gloves.
3. Eye protection.
4. Hearing protection (85 dB and above).
5. Face and respiratory protection when/where appropriate as determined by the JHA.

6. High-visibility vest to be determined when/where appropriate by JHA.

7. Leather lace-up boots with 8-inch (204 mm) minimum tops and nonskid soles (FSM 6716.03, Personal Protective Equipment (Condition of Hire) policy). The JHA may address appropriate footwear for wet weather roadside clearing work projects or activities.

27.63c – Safety Practices.

1. Follow the manufacturer's recommendations for machine use.
2. Comply with direction in section 22.48 for chain saw operation.
3. Post traffic warning signs in each direction.
4. Inspect equipment before use.
5. Monitor equipment during use.
6. Turn off machines before inspecting them.
7. Provide guard(s) to protect equipment operators from cut or flying debris.
8. Make sure employees and the operator agree on an appropriate distance to be maintained during the cutting operation.

27.63d – Backpack Power Units. These machines are used for planting and brush cutting. Identify required/recommended PPE in the JHA.

27.63e – Safety Practices. Basic safety and health practices for use of backpack power units include:

1. **Operation and Maintenance.** Follow the manufacturer's operation and maintenance recommendations and hazardous material handling requirements.
2. **Assistants.**
 - a. Have an assistant put the power unit on the operator's shoulders, change attachments, and start engine.
 - b. Make sure employees stay at least 10 feet (3 m) away from the cutting head. Increase this distance to 50 feet

(15 m) if the blade retainer nut does not tighten in the opposite direction of blade rotation.

3. **Safety Attachments.**

- a. Equip power units with a quick cut-off switch, automatic clutch, or both, which disengages power when cutting head pinches or jams.
- b. Provide a harness quick release on the operator's pack.

4. **Holding Power Unit.** Hold the cutting bar and control lever firmly, and handle the power unit carefully while it is running.

5. **Proper Operating Position.** Maintain a balanced stance with feet separated and well anchored.

- a. Do not move from operation to operation with the attachment turning.
- b. Keep the cutting head under observation at all times while the unit is cutting.

6. **Repairs.** Stop the engine when making repairs or adjustments.

CHAPTER 30 – FACILITIES

Contents

31 FACILITIES CONSTRUCTION WORK

- 31.01 Authority
- 31.06 References
- 31.1 Qualifications
- 31.11 Procedures
- 31.12 Safety Practices
- 31.2 Excavation
- 31.21 Qualifications
- 31.22 Personal Protective Equipment
- 31.23 Procedures
- 31.24 Safety Practices
- 31.3 Concrete and Masonry
- 31.31 Qualifications
- 31.32 Personal Protective Equipment
- 31.33 Procedures
- 31.34 Safety Practices
- 31.34a General
- 31.34b Concrete Mixer Use
- 31.34c Associated Hazards

32 WALKING AND WORKING SURFACES

- 32.01 Authority
- 32.06 References
- 32.1 Qualifications
- 32.11 Procedures
- 32.12 Safety Practices
- 32.2 Guarding Openings
- 32.21 Qualifications
- 32.22 Procedures
- 32.23 Safety Practices

33 FALL PROTECTION

- 33.01 Authority
- 33.06 Qualifications
- 33.07 Personal Protective Equipment
- 33.1 Ladders
- 33.11 Safety Practices
- 33.11a Prior to Use

- 33.11b Use
- 33.11c Climbing
- 33.11d Storage
- 33.2 Scaffolding
- 33.21 Procedures
- 33.22 Safety Practices
- 33.3 Body Harnesses, Lifelines, and Lanyards
- 33.31 Definitions
- 33.32 General
- 33.33 Use

34 MEANS OF EGRESS AND FIRE PREVENTION

- 34.01 Authority
- 34.1 Fire Prevention and Emergency Evacuation Planning
- 34.11 Procedures
- 34.2 Fire Prevention
- 34.3 Chimneys and Vent Stacks
- 34.31 Qualifications
- 34.32 Procedures
- 34.33 Safety Practices

35 FIRE PROTECTION

- 35.01 Authority
- 35.06 References
- 35.1 Structural Fire Suppression
- 35.11 Safety Practices
- 35.11a Fire Extinguishers

36 ELECTRICAL STANDARDS

- 36.01 Authority
- 36.1 Qualifications
- 36.11 Personal Protective Equipment
- 36.12 Procedures
- 36.13 Safety Practices

37 OCCUPATIONAL HEALTH AND ENVIRONMENTAL CONTROLS

- 37.01 Authority
- 37.1 Heating, Ventilating, and Air Conditioning Equipment
- 37.11 Qualifications
- 37.12 Procedures
- 37.13 Safety Practices

- 37.2 Lighting
- 37.21 Personal Protective Equipment
- 37.22 Procedures
- 37.23 Safety Practices
- 37.23a Interior
- 37.23b Exterior
- 37.3 Pressure Vessels
- 37.31 Qualifications
- 37.32 Personal Protective Equipment
- 37.33 Procedures
- 37.34 Safety Practices

38 GENERAL ENVIRONMENTAL CONTROLS

- 38.01 Authority
- 38.1 Safety Color(s) for Marking Physical Hazards
- 38.11 Procedures
- 38.12 Safety Practices
- 38.12a Vehicle Marking
- 38.12b Piping Systems
- 38.12c Safety Signs
- 38.2 Confined Spaces
- 38.21 Definitions
- 38.22 Qualifications
- 38.23 Personal Protective Equipment
- 38.24 Procedures
- 38.25 Safety Practices
- 38.3 Control of Hazardous Energy (Lockout/Tag-out)

39 FACILITIES

- 39.01 Authority
- 39.06 Reference
- 39.1 Qualifications
- 39.11 Personal Protective Equipment
- 39.12 Procedures
- 39.13 Safety Practices
- 39.2 Living Quarters
- 39.21 Procedures
- 39.22 Safety Practices
- 39.22a Permanent Crew Quarters
- 39.22b Residences
- 39.3 Lookouts

- 39.31 Personal Protective Equipment
- 39.32 Procedures
- 39.33 Safety Practices
- 39.33a General
- 39.33b Structure Safety
- 39.33c Personal Safety and Health
- 39.34 Lightning Protection
- 39.34a Inspections and Maintenance of Lightning Protection System
- 39.4 Mobile Homes and House/Office Trailers
- 39.41 Qualifications
- 39.42 Safety Practices
- 39.43 Trailer Utility Connections
- 39.44 Trailer Heating Systems
- 39.45 Entrances and Exits
- 39.5 Offices
- 39.51 Safety Practices
- 39.51a Furniture and Equipment Use
- 39.6 Storage and Warehousing
- 39.61 Qualifications
- 39.62 Personal Protective Equipment
- 39.63 Procedures
- 39.64 Safety Practices
- 39.7 Shops
- 39.71 Qualifications
- 39.72 Personal Protective Equipment
- 39.73 Procedures
- 39.74 Safety Practices
- 39.74a Automotive and Equipment Repair
- 39.74b Woodworking
- 39.74c Metal Working
- 39.8 Grounds Maintenance
- 39.81 Qualifications
- 39.82 Personal Protective Equipment
- 39.83 Safety Practices
- 39.9 Exhibits

CHAPTER 30 – FACILITIES

31 – FACILITIES CONSTRUCTION WORK. “Construction work” in this Handbook refers to work projects and activities for general construction, maintenance, alteration, and repair.

31.01 – Authority. The authority for personal protective equipment (PPE) is in Title 29, Code of Federal Regulations (29 CFR), section 1910.132.

The authority for material handling equipment, excavations, concrete and masonry construction, and rollover protective structures (ROPS) is in 29 CFR 1926.602, 1926.650-1926.652, 1926.700-1926.706, and 1926.1000-1926.1001.

31.06 – References.

1. U.S. Department of Agriculture, Forest Service. Guidelines for Forest Signs and Posters. EM-7100-15. U.S. Government Printing Office, Washington, DC.
2. U.S. Department of Transportation, Federal Highway Administration. Manual on Uniform Traffic Control Devices. U.S. Government Printing Office, Washington, DC.

31.1 – Qualifications. Besides having the applicable training and certification listed in section 21.11, employees shall be competent in the necessary construction and maintenance skills before beginning work.

31.11 – Procedures. The first-line supervisor and employees shall prepare a job hazard analysis (JHA) and discuss it before beginning any construction or maintenance work projects or activities (sec. 21.1). The JHA shall include:

1. Name of employees and emergency phone numbers.
2. Emergency evacuation procedures and communications plan.
3. Other information pertinent to the project. (Some items required for the JHA are available in other documents, such as a district or project safety and health plan, and may be included by reference.)

If employees fail to report or return on schedule, the supervisor shall take those actions required by the JHA.

31.12 – Safety Practices.

1. Ensure contract and force-account construction adjacent to a highway or street is marked with signs and barricades that comply with Forest Service standards (sec. 31.06). Make sure construction is well lit when adjacent to roads with nighttime traffic.

2. Read and follow manufacturer's recommendations, including use of PPE, ventilation, preparation of surfaces and materials, application of materials and components, and use of flammables/combustibles.

3. Clean up the area after each work shift.

4. Mark with signs and barricade all work that may be potentially hazardous to the public and employees in the area.

5. Obtain the material safety data sheet (MSDS) and discuss it with employees. Apply the MSDS information and direction as required.

31.2 – Excavation.

31.21 – Qualifications. Shoring and soil stability are key points of concern in excavation work. Because of variable soil conditions, load pressure, vibrations, and other factors, excavation is difficult to cover with absolute requirements that fit all excavation situations. After consultation with competent engineering personnel, the first-line supervisor, work leader, or both shall complete the project design and work plan.

Instruct workers to report at once any signs of weakness in excavations and shoring. Make available the necessary training and certification for employees to reach competency in this area (sec. 21.11).

31.22 – Personal Protective Equipment. Required PPE for excavation includes:

1. First aid kit (refer to the Glossary).
2. Hardhat.
3. Safety-toed or equally effective footwear (ANSI Z41 1991).

4. Gloves.
5. Eye protection.
6. Hearing protection (85 dB and above).
7. Other PPE as identified in the JHA.

31.23 – Procedures. Before excavation begins, a competent person shall inspect the site for conditions requiring special precautions. This is especially important in unstable soils and in the vicinity of roadways or utility structures. Conduct daily inspections of excavations, adjacent areas, and protective systems for evidence of potential hazards.

31.24 – Safety Practices. Employees working in excavations shall be observed at all times by a competent person who is not in the excavation. Be aware of the following hazards:

1. Variable soil conditions and the effect of ground water.
Inspect banks hourly or more often if it rains or freezes.
 - a. Comply with mandatory requirements that sides of excavations in unstable or soft material 5 feet (1-1/2 m) or more in depth be shored, sheeted, braced, sloped, or otherwise supported by means of sufficient strength.
 - b. Locate a stairway, ladder, ramp, or other safe means of egress in trench excavations 4 feet (1-1/4 m) or deeper so employees have to travel laterally no more than 25 feet (7-1/2 m).
2. Work in the area of excavating equipment.
 - a. Keep employees clear of all equipment working in the area.
 - b. Where vehicles are required to back up to open pits, provide an 8-inch (200-mm) wheel stop and anchor it on a firm bearing.
3. Improper storage of excavation materials and equipment.
 - a. Remove surface material that may fall into an excavation.
 - b. Place excavation materials and equipment at least 2 feet (1/2 m) from the edge of excavations, or use retaining devices or a combination of both methods if necessary.

4. Failure to erect guardrails, barricades, or fences to prevent accidents and injuries.
 - a. When employees or equipment are required to cross over excavations, provide walkways or bridges with standard guardrails.
 - b. Provide physical barrier protection at all remote excavations.
5. Powerlines in the work area (sec. 36.13, para.13).

31.3 – Concrete and Masonry. Concrete, masonry, and steel construction requires accomplished, professional skills. Safety and health must be a prime consideration when planning these work projects and activities.

31.31 – Qualifications. In addition to having the applicable training and certification listed in section 31.1, employees shall be trained and possess the skills necessary to perform concrete/masonry work.

31.32 – Personal Protective Equipment. No employee shall be permitted to place or tie reinforcing steel more than 6 feet (1-4/5 m) above any adjacent working surface unless the employee is using a safety belt or equivalent fall protection.

Required PPE for concrete and masonry work includes:

1. First aid kit (refer to the Glossary).
2. Hardhat.
3. Gloves.
4. Eye protection.
5. Respirator for cement and lime dust (NIOSH-approved).
6. Appropriate footwear.
7. Other PPE as identified in the JHA.

31.33 – Procedures. A competent engineer, such as a structural engineer, shall prepare the design, work plan, and, with the involved employees, the JHA for concrete construction projects.

31.34 – Safety Practices.

31.34a – General.

1. Assign enough people to the job to accomplish the heavy work safely.
2. Have ample supplies of wash water, soap, towels, protective creams, and first aid supplies available.
3. Have the project engineer or other competent person inspect the forms before pouring the concrete.
4. Do not change or remove forms without engineering approval.

31.34b – Concrete Mixer Use.

1. Keep the working area around mixers free of waste material or slippery surfaces caused by water spillage.
2. Inspect belts, belt guards, cables, electrical cord and connections, hoist, and brake mechanisms daily. Belts and pulleys shall have guards.
3. Wear eye and/or face protection and appropriate gloves when loading mixer.
4. Block and level all mixing equipment before operating.

31.34c – Associated Hazards.

1. Working on and around forms and scaffolds.
2. Elevated runways and ramps.
3. Lifting and working with heavy loads.
4. Protruding reinforcement steel.
5. Large, bulky, heavy concrete forms.
6. Protruding nails, wire ties, and form accessories.
7. Slippery walking and working surfaces.
8. Lime burns to the skin and eye exposure.

9. Poor or inadequate design without regard to safe concrete load factors.
10. Fire danger from stored lime if it is allowed to become moist.
11. Working close to materials handling equipment.

32 – WALKING AND WORKING SURFACES.

32.01 – Authority. The authority for walking and working surfaces is in Title 29, Code of Federal Regulations (29 CFR), sections 1910.21 – 1910.24.

The authority for signs, signals, and barricades and fall protection is in 29 CFR 1926.200 – 1926.203 and 1926.500.

32.06 – References.

1. National Fire Protection Association. NFPA 70: National Electrical Code. Quincy, MA.
2. U.S. Department of Agriculture, Forest Service. Guidelines for Forest Signs and Posters. EM-7100-15. U.S. Government Printing Office, Washington, DC.
3. U.S. Department of Transportation, Federal Highway Administration. Manual on Uniform Traffic Control Devices. U.S. Government Printing Office, Washington, DC.

32.1 – Qualifications. Besides having the applicable training and certification listed in section 21.11, employees shall be trained to recognize and correct or abate hazards associated with walking/working surfaces. Supervisor training should stress housekeeping and the need to monitor the work area for improper use of equipment and to inspect work surfaces for damage.

32.11 – Procedures. Prepare and discuss the JHA with employees (sec. 31.11). The JHA shall address all associated hazards pertaining to walking/working surface and corrective action or abatement (sec. 39.13, para.2).

32.12 – Safety Practices.

1. Use properly secured ladders, scaffolding, or lifts for activities above floor or ground level.

2. Lockout and tag all electrical panel boards when inspecting components of electrical-driven motors, appliances, and circuitry (sec. 38.3).

3. Provide the proper clearances in front of all electrical service panels and disconnects as required by the National Electrical Code (sec. 32.06).

4. Always follow the equipment manufacturer's recommendations.

5. Provide ample lighting and ensure that ingress/egress are available at all times (sec. 37.2 and 34).

6. Keep workrooms and storerooms clean and orderly and free of tripping hazards. Keep aisles and passageways clear of materials and well lit for safe access by employees and equipment. Clearly mark permanent aisles and passageways.

7. Wipe up spills immediately.

a. Never leave wet floors unmarked and unattended.

b. Maintain drainage in areas where wet processes are used. If a dry standing work station cannot be provided, supply appropriate waterproof footwear.

32.2 – Guarding Openings.

32.21 – Qualifications. Employees shall be trained to recognize and deal with hazards associated with working near floor openings and excavations.

32.22 – Procedures. The JHA shall address hazards associated with guarding floor openings and excavations.

32.23 – Safety Practices.

1. Guard every wall and floor opening from which there is a drop of more than 4 feet (1-1/4 m) with a standard railing, toeboard, or equivalent barrier.

2. Equip flights of stairs with four or more risers with hand railings. Consider flights with less than four risers on a case-by-case basis.
3. Provide covers and/or guardrails to protect employees from open pits, tanks, vats, and ditches.
4. When excavations or unguarded openings must be left between work shifts, fence them off with standard construction fencing.

33 – FALL PROTECTION.

33.01 – Authority. The authority for walking and working surfaces, ladders, and electrical work practices is in Title 29, Code of Federal Regulations (29 CFR), sections 1910.21 – 1910.23, 1910.25 – 1910.29, and 1910.333.

The authority for fall protection equipment, rigging equipment for material handling, scaffolding, and ladders is in 29 CFR 1926.104 – 1926.107, 1926.251, 1926.451, 1926.500 – 1926.503, and 1926.1053.

The authority for safety requirements for portable wood, metal, and reinforced plastic ladders is the American National Standards Institute (ANSI) Standards A14.1, A14.2, and A14.5.

33.06 – Qualifications. Employees shall be trained in hazard recognition and procedures on how to use, inspect, and maintain fall protection equipment, including ladders, scaffolding, fall arrest systems, safety net systems, and guardrail systems. Fall protection training requirements can be found in 29 CFR 1926.503.

33.07 – Personal Protective Equipment. The JHA shall identify specific PPE for utilizing equipment.

33.1 – Ladders. Improper use of ladders may result in serious accidents. Accident analysis reveals four principal causes:

1. Ascending or descending improperly.
2. Failing to secure the ladder at the top, bottom, or both.
3. Holding objects while ascending or descending.

4. Structural failing of the ladder.

33.11 – Safety Practices. Ladders are for temporary use only. Replace ladders with stairways, proper guardrails, and landings whenever possible. Select a ladder that meets applicable OSHA/ANSI standards and is right for the job.

33.11a – Prior to Use. Inspect ladders for defects before use each day and after any occurrence that could damage the ladder. Inspect and test any ladder that has been accidentally dropped, exposed to heat, or otherwise damaged. Consider designating a qualified inspector to check all ladders at a centralized storage area on a regular basis. The following are examples of what to look for:

1. Evidence of makeshift repairs, such as tape or wire.
2. Grease, oil, or burns from welding on the rungs and rails. Never paint a ladder; painting covers structural defects.
3. Condition of ladder feet and all hardware needed for coupling extensions. Carefully check all metal fittings.
4. Ladders that have developed defects. Defective ladders must be withdrawn from service for repair or destruction and marked as “DANGEROUS, DO NOT USE.”
5. Loose or cracked rungs and split rails on wood ladders. Wood ladders must be free of splinters and must have smooth edges. Periodically treat wood ladders with clear preservative, such as varnish, shellac, or linseed oil. Never treat rungs with a preservative that becomes slippery when wet.
6. Wear, corrosion, and structural failure on metal ladders. Metal ladders are electrical conductors and shall not be used around electrical circuits or for electrical arc welding operations.

33.11b – Use.

1. Ladders are meant for one person only.
 - a. Never overload ladders.
 - b. Never apply a side load or push or pull anything while on a ladder.
 - c. Never drop or apply an impact load to ladder.

2. Avoid dangerous overreaching. Move the ladder to a new location when you must lean more than 1 foot (1/3 m) to the side.
3. Never "walk" a ladder (stilt fashion) while standing on it.
4. Set the ladder on firm, level ground. Use nonskid ladder feet for added safety, especially when working on ice or snow. For proper set up:
 - a. **Step Type.**
 - (1) Ensure that the ladder is fully opened and locked, with the pail shelf in position.
 - (2) Make sure nuts and bolts are tight, steps and rungs are secure and clear of slippery material or loose items, and lock braces and pail workshelf properly.
 - b. **Extension Type.** Make sure ladder extension locks work as intended. Ensure that rope and other accessories are properly affixed and in good condition.
 - (1) Ensure that the distance from the ladder base to the vertical support equals one-quarter of the ladder's working length.
 - (2) Erect the ladder at about a 75° angle from the ground line, with a minimum of 3 feet (1 m) extending above the roofline.
 - (3) Raise the ladder to vertical and stand to one side. Hold the rope with one hand and the far rail with the other hand. Raise two or three rungs at a time until the proper height is acquired. Adjust the ladder length only when it is unoccupied. Never use temporary supports to increase length or to adjust for uneven surfaces. Do not fasten different ladders together to increase length. Apply these rules for overlap (ex. 01).
 - (4) If repeated climbing or long use is planned or if the ladder is leaned against a pole, tree trunk, or post, secure the top of the ladder to a support point with rope, chain, or angle brace.
5. Never:
 - a. Step, stand, or sit on the ladder top, braces, or back section.
 - b. Straddle the top or stand on the top two steps of ladders.

33.11b – Exhibit 01 – Two-Section Extension Ladder Minimum Overlap

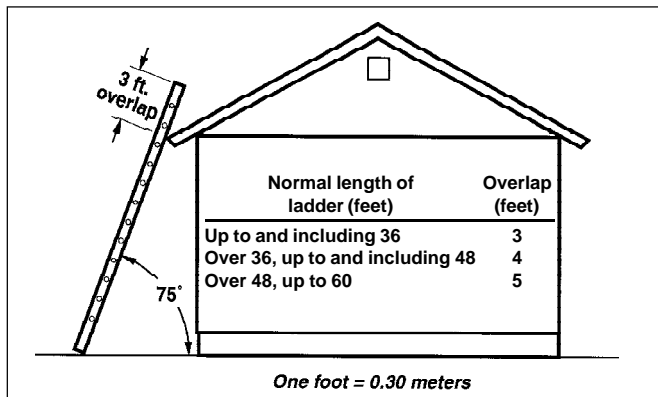

- c. Use a ladder where strenuous action by the worker is required.
 - d. Use a ladder as a platform, plank, hoist, or scaffold.
 - e. Use a ladder on a scaffold or during high winds.
 - f. Place a ladder in front of door openings.
6. Keep rungs free of grease, oil, and other materials that might destroy nonslip surfaces.
 7. Discourage use of makeshift ladders unless they clearly meet the requirements of 29 CFR 1926.450.

33.11c – Climbing.

1. Securely engage ladder locks; spread braces before climbing.
2. Ensure that ladder feet are firmly supported. Have a person on the ground firmly hold the ladder to prevent slipping, or secure a board to the floor against which the foot of the ladder can rest.
3. Always face the ladder when ascending or descending; use both hands.

4. Do not step from one ladder to another.
5. Do not climb above the third rung from the top of an extension ladder or above the upper support point.

33.11d – Storage.

1. Protect ladders from inclement weather. Store them in a dry location, away from excessive heat and possible physical damage.
2. Store ladders vertically. Wooden ladders stored horizontally should be supported at both ends and in the middle to prevent sagging. Sagging tends to loosen the rungs and warp rails.
3. Never store materials on ladders.
4. Properly secure ladders while in transit.
5. For information related to fixed ladders, refer to 29 CFR 1910.27, which includes design requirements, specific features, clearance, special requirements, pitch, and maintenance.

33.2 – Scaffolding.

33.21 – Procedures. Wood scaffolds and supports shall be designed by a structural engineer. The structural engineer shall also prepare the work plan. Complete a JHA and discuss it with all employees before using the scaffolding.

33.22 – Safety Practices.

1. Ensure that a competent person supervises the building, installing, moving, dismantling, and altering of any scaffolding.
2. Have an engineer or other designated, competent person inspect all scaffolds before each work day. Do not allow a scaffold built by one crew to be used by another crew until it has been inspected and pronounced safe by a competent person.
3. Prohibit the use of shore or lean-to scaffolds.
4. Prohibit work on scaffolds during storms or high winds.
5. Install guardrails and toeboards at all open sides on all scaffolds more than 10 feet (3 m) above the ground or floor, except needlebeam scaffolds and floats.

6. Where persons are required to work or pass under the scaffold, provide a screen, consisting of no. 18 gauge U.S. Standard wire 1/2 inch (12-3/4 mm) mesh or equivalent, between the toeboard and the guardrail that extends along the entire opening.

33.3 – Body Harnesses, Lifelines, and Lanyards.

33.31 – Definitions.

Body harness. A safety strap device which may be secured about a person in a manner that distributes the fall arrest forces over at least the thighs, pelvis, waist, chest, and shoulders and that, by reason of its attachment to a lanyard and lifeline or a structure, prevents the wearer from falling to the ground or lower level.

Lanyard. A flexible line of rope or webbing strap made from synthetic fibers which generally has a connector at each end for connecting a body harness to a deceleration device, lifeline, or anchorage.

Lifeline. A component consisting of a flexible line of rope for connection to an anchorage at one end to hang vertically (vertical lifeline), or for connection to anchorages at both ends to stretch horizontally (horizontal lifeline), and which serves as a means for connecting other components of a personal fall arrest system to the anchorage.

Personal fall arrest system. A system used to arrest a person in a fall from a working level. The system consists of an anchorage, connectors, and a body harness, and may include a lanyard, deceleration device, lifeline, or suitable combinations of these; use of body belts for fall arrest is prohibited (sec. 33.32).

33.32 – General.

1. Provide employees with personal fall arrest systems, safety net systems, or guardrail systems as standard fall protection when working 6 feet (1-3/4 m) or more above the ground and 6 feet (1-3/4 m) or more above lower levels, moving machinery, or when working over water. Also use this equipment on steep slopes or other areas as warranted. Select the system that matches the particular work situation. As of January 1, 1998, the use of a body belt for fall arrest is prohibited.

2. Provide safety net systems when workplaces are more than 25 feet (7-1/2 m) above the ground, water surface, or other surfaces where the use of ladders, scaffolds, catch platforms, temporary floors, safety lines, or body harnesses is impractical. Refer to section 22.49 for direction on tree climbing and section 26.6 for direction on telecommunications.

33.33 – Use.

1. Personal fall arrest systems.

- a. Thorough employee training in the selection and use of personal fall arrest systems is imperative. Careless or improper use of the equipment can result in serious injury or death.
- b. Inspect personal fall arrest system components prior to each use for wear, damage, and other deterioration. Defective components shall be removed from service and tagged unusable, or destroyed.
- c. Personal fall arrest system components subjected to impact loading shall be immediately removed from service and shall not be used again for employee protection until inspected and determined by a competent person to be undamaged and suitable for reuse.

2. Safety Ropes.

- a. Inspect safety ropes before and after every use and carefully store them. Check ropes daily during periods of use for broken fibers. To check, twist the strands back. Immediately destroy any rope that shows signs of damage or wear.
- b. Secure lifeline and climbing ropes above the point of operation to a structural member able to support 5,400 pounds (2,449 kg) or more.
- c. Make sure lifelines used for rock climbing or which are subject to abrasion are, at a minimum, 7/8-inch (23-mm) wire core manila rope or 3/4-inch (19-mm) wire core manila rope with a minimum breaking strength of 5,400 pounds (2,449 kg).

3. Safety Nets. Ensure that safety nets:

- a. Extend 8 feet (2-1/2 m) beyond the edge of the work.
- b. Are never lower than 25 feet (7-1/2 m) below the level of work.

- c. Are hung to prevent the user's contact with surface below.
- d. Are impact-load tested before use.

34 – MEANS OF EGRESS AND FIRE PREVENTION.

34.01 – Authority. The authority for means of egress is in Title 29, Code of Federal Regulations (29 CFR), sections 1910.35 – 1910.37; National Fire Protection Association (NFPA) 101: Life Safety Code; and Uniform Federal Accessibility Standards (UFAS) 1984.

34.1 – Fire Prevention and Emergency Evacuation Planning.

34.11 – Procedures. Prepare fire prevention/evacuation plans for all buildings and administrative sites as part of an Emergency Action Plan.

Post a scale (or near-scale) plan of the buildings or administrative sites in conspicuous location(s) at the installation.

1. Make sure plans are correctly oriented and identify:
 - a. Fire safety features at a glance, such as building exits, hydrants, extinguishers, and other fire equipment. Also include:
 - (1) Electrical power shutoff switches.
 - (2) Escape routes.
 - (3) Individual responsibilities.
 - (4) Chain of command.
 - b. Safety areas for evacuation. Such areas may include parking lots, open fields, or streets that are located away from the emergency. Instruct employees to avoid congregating close to the building where they may hamper emergency operations.
2. Ensure that all personnel, including families in Government-furnished quarters, are familiar with the plan and participate in fire drills at least twice a year.
3. Ensure that every Forest Service installation has a "system" in its fire prevention/evacuation plan to accommodate physically disabled persons.

4. Ensure that fire alarms are audible and/or visible in dead-end rooms.
5. Have at least two identified emergency escape routes for all dwellings, crew quarters, offices, and basements.
6. Clearly mark exits so that they are conspicuous from all directions.
 - a. Post doors, stairways, or any passageway that could be confused as an exit with "Not an Exit" or similar designation indicating its actual character, such as "To Basement" or "Storeroom."
 - b. Ensure that exits, other than in residences, are not through rooms subject to locking. Ensure that all identified and required exits can be opened from the inside.
 - c. Remove snow and ice regularly so that exits are always clear.
 - d. Where a fire exit is through double-leaf doors, equip each leaf with a quick-release bar lever that is kept unlocked and operable when the building is occupied.
 - e. Ensure that fire exits and other traffic ways have a minimum ceiling height of 7 feet 6 inches (2-1/3 m) with no projection lowering clearance to less than 6 feet 8 inches (2 m). Fire exits must comply with the Uniform Federal Accessibility Standards (UFAS) 1984 (sec. 34.01).

34.2 – Fire Prevention. Safe work habits and compliance with safety procedures are critical in preventing fires. Be especially careful around heat sources, such as chimneys, stoves, and appliances.

1. **Fire/Smoke Detection Equipment.** In every building or structure of such size, arrangement, or occupancy that a fire may go undetected, fire alarms and/or smoke detectors shall be provided. Post and enforce smoking restrictions.
 - a. Ensure that:
 - (1) Electrical smoke detection systems are backed up with a battery-operated detection system.
 - (2) Smoke detector batteries are replaced at least annually (if battery type).

- (3) Detection equipment is tested at least monthly, is clean and serviceable, and is maintained to operate reliably.

2. **Electrical Systems.** Have a licensed journeyman-level electrician inspect electrical systems in Forest Service buildings periodically (sec. 36.1).

- a. Ensure that all electrical systems comply with local, State, and National electrical codes.
- b. Do not overload circuits. Maintain circuits in good repair and protect them from damage. Overheating before circuit breakers trip off causes conductor insulation to deteriorate. Inspect ceiling light wiring annually.
- c. Check for damaged plugs and frayed wires. Do not use extension cords as substitutes for permanent wiring circuits.
- d. Investigate all "hot" smells and odors from fluorescent ballasts and oversized light bulbs. Heated metal and heated paint surfaces can be sources of possible trouble. When disposing of fluorescent tubes, take extra precaution to prevent accidental breakage. Wear gloves and eye protection and be aware that tubes may contain toxic substances.

3. **Appliances.** Do not locate appliances where heat buildup may occur. Provide annual preventive maintenance for all electrical equipment and fuel-fired appliances.

- a. Inspect appliance cords and plugs regularly for defects that may cause electrical shock and/or fire.
- b. Be aware of friction buildup in machines and electric motors; provide manufacturer's recommended lubricants to reduce wear and heat.
- c. Do not enclose coffee pots and other electrical appliances in cabinets.
- d. Provide adequate air circulation around electrical appliances.
- e. Ensure that portable electric heaters are grounded and are provided with automatic tip over shut-off safety devices.

4. **Flammables/Combustibles.** Use such materials only in ventilated and fire-safe areas. Never start fires with flammable liquids. Store flammables and combustibles only in containers, cabinets, and buildings specifically approved for this purpose (sec. 38.12c). Refer to section 61.5 for further direction.

5. **Heating Systems.**

- a. Inspect and clean fire boxes, chimneys, and stove pipes at least annually.
- b. Use approved lighting procedures (sec. 37.2).
- c. Do not allow curtains, furniture, or other materials to cover or block the discharge from baseboard heaters, wall heaters, or registers. Provide for adequate air circulation.

6. **Design Review.**

- a. Review the original design, purpose, and personnel limits of buildings each year to ensure that uses have not reduced or compromised employee safety or health by increasing the fire hazard.
- b. Ensure that engineers and architects review modifications to buildings and their use. Minor changes can make subtle but important impacts on fire safety.

7. **Furnishings.** Evaluate building furnishings, finished surfaces, and decorative materials for flame-spread and smoke toxicity.

8. **Storage.** Do not allow materials that create fire and explosion hazards to accumulate in storage areas.

34.3 – Chimneys and Vent Stacks. Soot and carbon deposit are common in all furnaces. Pitch and creosote deposits from wood can cause flue fires. Regularly scheduled maintenance is important to prevent poor ventilation and fire.

34.31 – Qualifications. Employees shall be trained in proper use and maintenance techniques before working on chimneys and vent stacks.

34.32 – Procedures.

1. Ensure that any chimney flue is of adequate size and complies with the manufacturer's installation instructions where provided.

2. Ensure that a qualified engineer approves any connections added to chimney flues. Never connect more than one appliance (stove, furnace) to each flue. Add another flue if a second appliance is installed.

34.33 – Safety Practices. Basic safety practices for the care of chimney flues and vent stacks include:

1. Clean and inspect chimneys and vents annually.
2. Check metal flues twice yearly for cracks, clearances, soundness, support, and freedom from deposits.
3. Maintain tight mortar joints on masonry chimney flues.
4. Maintain chimney flues at regular intervals and always keep combustible materials a safe distance away.
5. Maintain rotating vents and chimney caps to keep them free turning.

35 – FIRE PROTECTION.

35.01 – Authority. The authority for portable fire extinguishers is in Title 29, Code of Federal Regulations (29 CFR), section 1910.157; the authority for fire protection is in 29 CFR 1926.150.

35.06 – Reference. National Fire Protection Association. NFPA 10: Standard for Portable Fire Extinguishers. Quincy, MA.

35.1 – Structural Fire Suppression. At Forest Service administrative sites outside the jurisdiction of State and local fire departments, limit fire protection measures to:



1. Prevention;
2. Use of fire extinguishers on incipient stage fires;
3. Safe evacuation of personnel;
4. Containment by exterior attack; and
5. Protection of exposed improvements.

35.11 – Safety Practices. Basic safety and health practices to follow in case of fire:

1. Turn in an alarm at once. Have persons designated by fire prevention/evacuation plan check the building and account for all occupants. Conduct rescue procedures and give first aid.
2. Shut off electricity and gas.
3. Use the fire extinguisher closest to your location.
4. Never delay. If fire cannot be controlled, get out of the building immediately and go to a predetermined safety area.
5. If the fire is controlled, make certain it is completely extinguished.
6. Be sure equipment is quickly made ready for reuse.

35.11a – Fire Extinguishers. Fire extinguishers are designed for use in emergencies; therefore it is vital that they operate effectively. Only fire extinguishers that are tested in accordance with ANSI standards (8, 154, 299, 626, 711, 1093, 1803) should be purchased. Forest Service employees shall be familiar with different types of fire extinguishers and trained to use them based on the Emergency Action Plan (ex. 01).

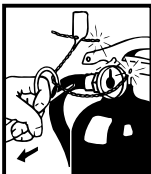
35.11a – Exhibit 01 – Extinguisher Operation

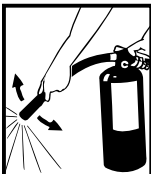
| TO OPERATE EXTINGUISHER | | | |
|--|---|---|---|
| Hold | Start | Squeeze | Sweep |
| Hold upright. Pull the pin. | Start back 20 ft. Aim the nozzle at the base of the fire. Move within 10 ft. | Squeeze the operating handle to release the extinguishing agent | Sweep from side to side at the base of the fire until it goes out. |
|  |  |  |  |



All types of fire extinguishers are rated for the class or classes of fires on which they can be used and the amount of fire that they can be expected to control. Selecting the proper extinguisher for the anticipated fire is of primary importance. There is not a single extinguisher that is equally suitable and desirable for all classes of fire (ex. 02).

36 – ELECTRICAL STANDARDS. Maintaining the strictest electrical safety standards pays dividends in reduced property loss due to fire and, more importantly, preventing employee injury and death from electrical hazards.

36.01 – Authority. The authority for the control of hazardous energy (lockout/tag-out), welding, and electrical requirements is in Title 29, Code of Federal Regulations (29 CFR), sections 1910.147, 1910.253, and 1910.301 – 1910.399.

The authority for electrical safety and power transmission/distribution standards is in 29 CFR 1926.400, 1926.402 – 1926.408, 1926.416, 1926.417, 1926.431, 1926.432, 1926.441, 1926.449, and 1926.950 – 1926.957.

35.11a – Exhibit 02 – Fire Classification

| FIRE CLASSIFICATION | | |
|----------------------------|---|---|
| Letter Symbol | Picture Symbol | Description |
| A |  | Type A: Ordinary Combustibles: wood, cloth, paper, rubber, many plastics and other common materials that burn easily. |
| B |  | Type B: Flammable Liquids: gasoline and other flammable liquids, oil, grease, tar, oil-based paint, lacquer and flammable gas. |
| C |  | Type C: Electrical Equipment: energized electrical equipment, including wiring fuse boxes, circuit breakers, machinery and appliances. |
| D | No Current Symbol | Type D: Combustible Metals |

36.1 – Qualifications. Employees shall receive the applicable training listed in section 21.11 and additional training as warranted.

Only a State-licensed electrician, a qualified Forest Service electrical inspector, or a State-licensed contractor shall be permitted to perform or inspect electrical wiring and maintenance work.

1. Prohibit employees from working in areas where an electrical hazard exists unless they are trained or qualified.
2. Ensure that employees engaged in electrical work are trained to administer CPR and first aid treatment for burns and traumatic shock to victims of electrical shock.

36.11 – Personal Protective Equipment.

1. Rubber insulating gloves for specific tasks as identified in the JHA.
2. The appropriate Forest Service-approved hardhat (impact and penetration-resistant, and also providing electrical protection from high-voltage conductors).

36.12 – Procedures. All installations and maintenance involving wiring, fixtures, equipment, appliances, techniques, and practices shall comply with:

1. National electrical codes (NEC).
 - a. Building wiring installed according to the NEC at the time of construction does not have to be brought up to current NEC standards unless it has been modified.
 - b. If a wiring system is deteriorated, overloaded, or modified, or if usage has changed, wiring shall be upgraded to comply with the current NEC and other applicable standards.
2. State and local electrical codes.
3. Regional, Station, Area, or Institute standards and policies.

36.13 – Safety Practices. Follow these basic safety practices for activities involving electrical circuitry and appliances:

1. **Electrical Shock.** Electrical shock is an indicator of an electrical hazard.

- a. Report and promptly investigate electrical shock incidents.
- b. Unplug or disconnect the equipment or appliance and put it out of service until it has been repaired.
- c. Inspect electrical extension cords, tools, and appliances at least twice a year for wear or damage.

2. **Ground-Fault Circuit Interrupter (GFCI or GFI).**

- a. Equip with GFI circuit protection:
 - (1) All 15- and 20-ampere receptacle outlets for single-phase circuits located outside of buildings and in damp areas (such as kitchens serving countertop surfaces, bathrooms, unfinished basements, shops, and garages).
 - (2) All electrical devices and handtools used outside or in construction areas.
- b. Where GFI protection has not been provided, ground motor frames and portable electrical tools before using them or use double-insulated electrical equipment.
- c. Ensure that GFIs are used as required for all field (portable) generators not specifically grounded and bonded by positive means. Exception: receptacles on a 2-wire, single-phase portable or vehicle-mounted generator rated not more than 5 kW, where the circuit conductors of the generator are insulated from the generator frame and all other grounded surfaces.

3. **Wet Hands.** Never touch electrical appliances or electrical tools with wet hands while grounded or while touching plumbing pipes or faucets.

4. **Defective Components.** Promptly repair or replace defective switches, outlets, and light fixtures.

5. **Exposed Circuitry.** Cover exposed electrical circuitry, open light sockets, and junction boxes properly. Replace broken cover plates to eliminate accidental contact.

6. **Extension Cords.** Locate extension cords away from heat sources and protect them from abrasion, crushing, kinking, and pulling.

- a. Do not use extension cords as a substitute for permanently installed wiring for lighting and stationary electrical appliances.
 - b. Do not enclose extension and appliance cords inside walls or otherwise install them in a manner that prevents inspection.
 - c. Disconnect cords only by grasping the plug; do not jerk or pull them.
 - d. Connect flexible cords to devices and fittings to provide strain relief, which prevents pull from being directly transmitted to joints or terminal screws.
 - e. Never permit splices in flexible electrical cords (ex. 01).
7. **Current Test.** Conduct periodic current leakage tests on electrical tools and maintain a record of the test results.
8. **Repairs.** Perform scheduled preventive maintenance on motor or generator windings, brushes, bushings, and switches according to manufacturers' recommendations. Ensure that electrical safety is not compromised by unsealed appliances, improper wiring methods, or unauthorized operations.
9. **Motorized Equipment.**
- a. Ensure that small tools, fans, blowers, and appliances driven by an electric motor are provided with a grounding-type connection plug, or that they have approved double-insulated construction.
 - b. Never remove ground connections on appliance or extension cord plugs.

36.13 – Exhibit 01 – Extension Cord Safety

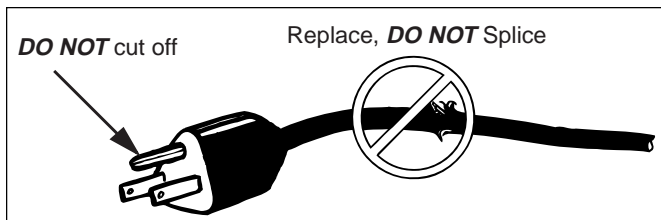

- c. Never use an appliance, tool, or cord from which the ground connection has been removed.

10. **Power Supply.**

- a. Shut off power before working on electrical circuits. Exception: An authorized electrician, in an emergency, may work on a live line not exceeding 220 volts.
- b. Switches supplying current to lines being repaired must be locked in the “off” position. Attach a warning tag indicating that work is in progress.

11. **Circuit Breakers.** Ensure that circuit breakers and disconnecting means are legibly marked to indicate their purpose.

12. **Accessible Work Area.**

- a. Provide easy access and working clearances around all electrical power panels and safety switches.
- b. Ensure that building modifications and equipment and fixture installation and operations do not interfere with required access and clearances (ex. 02).

13. **Work Near Powerlines. *Do not touch loose or downed wires hanging from buildings or poles until it is certain they are not “hot.” Never assume any wire is de-energized. Treat all wires and guy wires as if they are hot.***

- a. Have the power company make all changes or repairs to power company-owned lines leading to the master service switch.
- b. Before handling a telephone line that passes in the vicinity of a powerline, ensure that it is not in contact with the powerline.
- c. Notify the power company before using machinery in and around powerlines or any high-voltage installation.
- d. Always inspect proposed excavation work areas for underground powerlines. Check with the power company and review site plans for underground lines.
- e. Never use metal poles for pruning, window washing, or other activities near electrical lines. A metal pole or piece of equipment does not need to touch a powerline to become energized; coming in proximity can cause the conductor to become energized.

36.13 – Exhibit 02 – Working Clearances

| <i>Nominal Voltage to Ground</i> | <i>Minimum Clear Distance (feet)</i> | | |
|----------------------------------|--------------------------------------|----------|----------|
| | <i>1</i> | <i>2</i> | <i>3</i> |
| 0-150 | 3 | 3 | 3 |
| 151-600 | 3 | 3-1/2 | 4 |

For SI units: 1 ft = 0.3048 m

Where the conditions are as follows:

1. Exposed live parts on one side and no live or grounded parts on the other side of the working space, or exposed live parts on both sides effectively guarded by suitable wood or other insulating materials. Insulated wire or insulated busbars operating at not over 300 volts shall not be considered live parts.
2. Exposed live parts on one side and grounded parts on the other side.
3. Exposed live parts on both sides of the work space (not guarded as provided in Condition 1) with the operator between.

Exception No. 1: Working space shall not be required in back of assemblies such as dead-front switchboards or motor control centers where there are no renewable or adjustable parts such as fuses or switches on the back and where all connections are accessible from locations other than the back. Where rear access is required to work on de-energized parts on the back of enclosed equipment, a minimum working space of 30 in. (762 mm) horizontally shall be provided.

Source: *National Electrical Code Handbook*. 1996.

- f. When near powerlines, move power shovels, booms, telephone wire, pipe, drills, well casing, and other such machinery and materials with extreme care. Clearance should be at least 1-1/2 times the length of the boom plus the materials being handled or as required by State law.
- g. Ensure that any felling in the vicinity of a high-voltage line is done by professional certified fallers under the direction of a power company representative.
- h. Thoroughly plan and coordinate with the power company any brush burning close to powerlines. Flame is a conductor of electricity.
- i. Never direct a stream of water at or near an electrical line.
- j. **Low hanging powerlines.** Identify low hanging powerlines that may contact radio antennas or equipment and have the power company raise them.
- k. **Bare powerline conductors.** Ensure that powerline conductors are handled only by power company employees.

14. **Low and High Voltage Rescue.** Ensure that only personnel from the power company or other emergency services with the necessary training and equipment shall attempt such rescue operations.

15. **Lockout/tag-out** (sec. 38.3).

37 – OCCUPATIONAL HEALTH AND ENVIRONMENTAL CONTROLS.

37.01 – Authority. The authority for means of egress, flammable/combustible liquids, air receivers, welding, and electrical requirements is in Title 29, Code of Federal Regulations (29 CFR), sections 1910.37, 1910.106, 1910.169, 1910.253, 1910.301, and 1910.303.

The authority for illumination is in 29 CFR 1926.26 and 1926.404.

The authority for hazardous materials is in 49 CFR Parts 171-173 and 176-178. Additional direction is in FSM 2160 and 6740.

37.1 – Heating, Ventilating, and Air Conditioning Equipment.

Improper operation of such equipment can cause health and safety problems. Give high priority to maintaining this equipment.

37.11 – Qualifications. In addition to having the applicable training listed in section 21.11, only individuals trained for such work shall repair, adjust, and operate heating, ventilating, and air conditioning equipment. A competent person shall inspect equipment at least annually.

37.12 – Procedures. Follow these basic requirements and procedures for installation and maintenance work.

1. Verify that all heating equipment is approved by a nationally recognized laboratory and is being used according to the condition of approval.

2. Refer to local fire codes and manufacturers' recommendations before installing heating appliances.

3. Perform preventive maintenance as recommended by the manufacturer. Keep maintenance records with the equipment.

4. Where liquid petroleum (LP) gas is used in mobile (or stationary) homes, install LP gas detectors.

5. Ensure that automatic gas appliances have a 100 percent automatic shutoff valve should the pilot light go out or auto ignition system fail.

6. Provide accessible manual shutoff valves for all gas- and oil-fired furnaces and appliances.

7. Inspect air filters monthly and change as needed or as recommended by the manufacturer.

8. Inspect air conditioning blower fans, shafts, and motors as recommended by the manufacturer to prevent damage due to loosening by vibration.

37.13 – Safety Practices. Basic safety and health practices include:

1. **Heaters and Furnaces.** Type of work and location determine the selection of heaters and furnaces.
 - a. Provide all heaters with adequate ventilation.
 - (1) Do not use heaters in areas involving flammables/combustibles, woodworking dust, or any potentially explosive atmosphere.
 - (2) Never use catalytic heaters in airtight locations.
 - (3) Never use nonvented kerosene, LP, or natural gas furnaces/space heaters in Forest Service-owned residences, sleeping trailers, or dormitories.
 - b. Be aware of existing ventilation needs before altering an area by insulating, sealing, caulking, or installing storm windows.
 - (1) Check and ensure ventilation is adequate before lighting LP gas appliances.
 - (2) Investigate gas odors promptly.
 - (3) Shut off gas lines at the tank and notify the local LP gas distributor.
2. **Air Conditioning Equipment.**
 - a. Ground window air conditioners either through an electrical ground in the wiring system or by grounding the frame with a separate ground wire.
 - b. Make sure fan blade guards/shields have openings no larger than 1/2 inch (12-3/4 mm).
3. **Fuel Oil and Solid Fuels.**
 - a. Make sure fuel oil tanks are adequately vented. Do not allow vents to become blocked by snow, ice, or vegetation.
 - b. Mount above-ground tanks on sturdy stands or frames, on a firm base secured from tipping.
 - c. Do not use gravity systems on oil-fire furnaces. Remove empty underground fuel oil tanks or fill them with sand or other suitable material as required by Environmental Protection Agency (EPA) or State regulations.
 - d. Do not install solid fuel burning appliances where gasoline or any other flammable vapors or gases are likely to be present.
 - e. Use gloves for handling solid fuel.
 - f. Be alert for insects, snakes, and rodents in wood piles.

- g. Store solid fuels in a well-ventilated area in a neat, orderly fashion. Stack wood to prevent collapse, at least 6 inches (153 mm) away from all building walls.
- h. Locate coal piles in a manner to prevent spontaneous combustion.

37.2 – Lighting. When using lighting to enhance safety and security, consider these factors: light quality, contrast, glare, shadow effects, and eye perception.

37.21 – Personal Protective Equipment. The following PPE is required for installing and maintaining lighting:

1. Gloves and eye protection, as needed.
2. Other PPE as identified in the JHA.

37.22 – Procedures. Have engineers or architects determine lighting requirements.

37.23 – Safety Practices. Eliminate glare and deceptive shadows on walking and working surfaces. Follow basic safety methods when installing and maintaining light fixtures:

37.23a – Interior.

1. Provide overhead light fixtures within 7 feet (2-1/2 m) of the floor with shields or lens covers to prevent accidental breakage, shock, or fire hazard. This requirement does not include portable, table, or floor lamps.
2. Make sure replacement bulbs do not exceed the fixture's watt rating.
3. Provide emergency exit signs and fire exits with both normal and emergency lighting along the entire travel route. Install exit signs so they are visible from point to point leading out of the building to safety.

37.23b – Exterior. Ensure that all administrative sites have sufficient night lighting in:

1. Building entrances.
2. Parking lots and garages.

3. Loading docks.
4. Fueling areas.
5. Designated stairways.

37.3 – Pressure Vessels. Pressure vessels include air, nitrogen, hot water, oxygen, and acetylene tanks. They may be categorized as low pressure if rated below 60 pounds per square inch (PSI) (409 kPa) and high pressure if rated above 60 PSI. Pressure vessels have highly explosive capabilities and can become extremely dangerous. Refer to 29 CFR 1910.253 for further requirements.

37.31 – Qualifications.

1. Employees shall be experienced and competent to operate and perform maintenance on pressure vessels. For example, in the operation of Class A and B boilers, individuals shall be State certified and licensed.

2. Employees shall be familiar with reference material concerning all aspects of pressure vessels.

37.32 – Personal Protective Equipment. The JHA shall identify required PPE for employees working with and around pressure vessels.

37.33 – Procedures.

1. Use only ASME-approved vessels and materials stamped and designated for the purpose.

2. When preparing the JHA, take into consideration vessel location and associated hazards.

3. Follow the manufacturer's or inspector's guidelines concerning maintenance of vessels, tubes, gauges, hoses, and valves. Post inspection certificates and other required records and test results near the pressure vessel. Required inspections and maintenance include:

- a. Hydrostatically test pressure vessels every 5 years.
- b. Have boilers inspected annually by a certified licensed boiler inspector.
- c. At a minimum, drain hot water heaters annually.

- d. Drain condensation from air compressor tanks often enough to prevent excessive amounts of liquid accumulation in the receiver.
- e. Inspect steam-cleaning vessels before each use. Repair or replace damaged hoses, fittings, connections, gauges, and valves.

37.34 – Safety Practices. Basic safety practices related to pressure vessels include:

1. Make sure all pressure vessels are stamped with maximum allowable pressure or have an allowable pressure rating plate permanently attached.
2. Never exceed the stamped allowable pressure.
3. Equip all pressure vessels with pressure relief valves. Inspect valves regularly and ensure that they are functional and operational. Verify that relief valves show correct pressure settings and capacity for the specific gas or fluid being used.
4. Locate pressure vessels where physical damage is avoided. Regularly inspect pressure cylinders and containers for damage, and replace them when damaged.
5. Protect valves with cover caps when the vessel is not in use.

38 – GENERAL ENVIRONMENTAL CONTROLS.

38.01 – Authority. The authority for scaffolding, flammable and combustible liquids, hazardous waste procedures, PPE, safety color coding, specifications for accident prevention signs and tags, confined spaces, lockout/tag-out, and hazard communication is in Title 29, Code of Federal Regulations (29 CFR), sections 1910.28, 1910.106, 1910.120, 1910.132 – 1910.134, 1910.144 – 1910.147, and 1910.1200.

The authority for safety training, signs/signals/barricades, and environmental deterioration of equipment is in 29 CFR 1926.21, 1926.200 – 1926.202, and 1926.432.

38.1 – Safety Color(s) for Marking Physical Hazards. Signs and tags draw attention to safety equipment and identify relative de-

grees and types of hazards. Employees shall be trained in the identification of accident prevention signs and tags.

38.11 – Procedures. The unit sign coordinator shall approve all signing.

38.12 – Safety Practices. Use specific colors and signs for identification as set out in sections 38.12a to 38.12c.

38.12a – Vehicle Marking. Use the slow-moving vehicle emblem only on vehicles designed to move at 25 mph (40-1/4 km) or less on public roads (ex. 01).

38.12b – Piping Systems. Use proper pipe identification to inform employees of potential hazards in accordance with the latest edition of ANSI A13.1-1981.

38.12a – Exhibit 01 – Slow Moving Vehicle

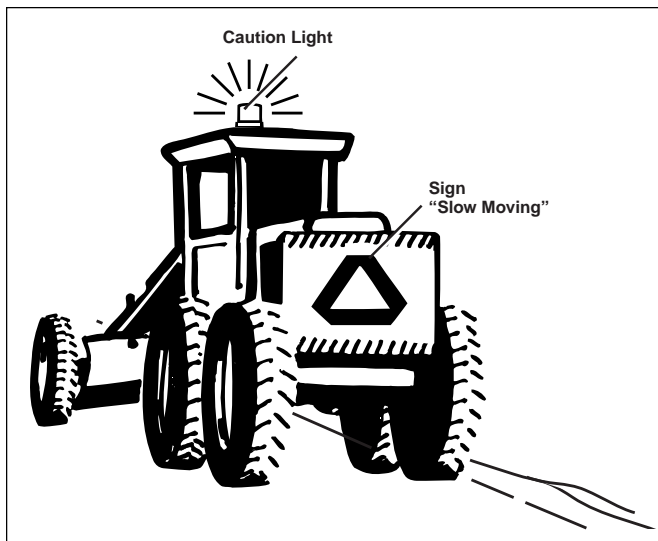

38.12c – Safety Signs.

1. **Red.** Use red as the basic color to identify:
 - a. Fire protection equipment and apparatus, including fire alarm stations, hydrants, standpipe valves, fire extinguishers or boards on which they are mounted, hose boxes, pumps, fire-tool and ladder markings, buckets, pails, and water barrels.
 - b. Safety cans and other portable containers of flammable liquids. Use additional visible identification in yellow, such as a yellow band around the can or the name of the contents clearly painted or stenciled on the can in yellow.
 - c. Emergency stop bars, stop buttons, and electrical stop switches.

2. **Yellow.** Use yellow as the basic color to designate caution and for marking physical hazards. Parallel diagonal bars of yellow and black have strong attention-getting values. Examples include:
 - a. Physical hazards, such as striking against, stumbling, falling, tripping, slipping, and caught between.
 - b. Edges of unguarded platforms, wells, open pits, and aisle markings around hazards.
 - c. Projections, protruding parts, low beams and pipes, low or impaired clearances, and coverings or guards for guy wires.
 - d. Conveyor parts or other fixtures suspended at hazardous levels from the ceiling or walls and extending into normal operating areas.
 - e. Elevation changes, such as stairway approaches, top and bottom steps, risers on nonstandard steps, raised doorsills, and curbing.
 - f. Pillars, posts, columns, and aisle obstructions that may be hazards if located in or near passageways.
 - g. Frames of elevator doors and gates; lips of horizontally closing doors.
 - h. Handrails and guardrails in storage areas.

38.2 – Confined Spaces. A competent person shall evaluate the workplace to determine confined spaces as defined in 29 CFR 1910.146 and 29 CFR 1910.147, The Control of Hazardous Energy. Employees working in or around confined spaces shall be aware of

the associated hazards. These include dangerous atmospheric conditions, existing mechanical or structural conditions, and work-zone safety and health hazards.

Examples of confined spaces are sewers, storage tanks, utility vaults, tunnels, pipelines, cisterns, underground wellheads, man-hole shafts, and lift stations. In some rare cases, attics and crawlspaces may have characteristics warranting treatment as confined spaces.

38.21 – Definitions.

Attendants. Employees stationed outside one or more permit-required spaces who monitor the authorized entrants and who perform all duties assigned in the confined space entry program.

Entrants. Authorized employees who may enter a permit-required space.

Entry. The point at which any part of the entrant's body breaks the plane of an opening into the permit-required confined space.

Entry Supervisor. The competent person (such as a crew supervisor) responsible for determining if acceptable entry conditions are present, for authorizing entry, for overseeing entry operations, and for terminating entry at a permit-required confined space where entry is planned.

Confined Space. Any space having a limited or restricted means of egress that is large enough for an employee to enter and perform assigned work and is not designed for continuous occupancy. Confined spaces can be further defined as permit-required or nonpermit-required.

Nonpermit Required Confined Space. A confined space that does not contain (or with respect to atmospheric hazards, does not have the potential to contain) any hazard capable of causing death or serious physical harm.

Permit-Required Confined Space. A confined space that has one or more of the following characteristics and that requires a written entry permit (including a pre-entry checklist) before entering: a hazardous atmosphere or the potential to contain a hazardous

atmosphere; potential for engulfment; internal configuration hazard; and other recognized serious safety or health hazard.

Rescuers. Personnel designated to rescue employees from permit-required confined spaces.

38.22 – Qualifications.

1. Through training, employees shall acquire the understanding, knowledge, and skills necessary for the safe performance of the duties assigned. Training shall include use of safety equipment, hazard communication, rescue operations, traffic control, and lockout/tag-out methods.

2. Upon completion of training for permit-required confined spaces, employees shall receive a certificate that includes their name, signature or initials of trainer, and dates of training. Certification must be current and available for inspection.

3. Additional training is necessary when there are changes in assigned duties, operations, or procedures, and when an employee's job performance shows deficiencies.

4. Rescue-service personnel are required to have annual refresher training, including hands-on practice rescues.

38.23 – Personal Protective Equipment. After considering all factors, such as specific activity and project location, identify required PPE in the JHA.

38.24 – Procedures. Prohibit entry into confined spaces where the hazardous atmosphere cannot be controlled by forced ventilation. Use the isolation process to remove a permit-required confined space from service by various means described in 29 CFR 1910.146. Lock-out/tag-out is one method (sec. 38.3).

Prepare a JHA and discuss it with employees and other personnel working in the immediate area before beginning work in any confined space. Procedures include:

1. Evaluating the work area to determine if confined spaces are present and if they are permit-required or nonpermit required.

2. Reevaluating nonpermit-required confined spaces when there are changes in their use or configuration and reclassifying them to permit-required, if necessary.

3. Setting up and maintaining records for all confined spaces that identify the uses of each confined space and the hazards it contains.

4. Notifying employees of the location of confined spaces and the dangers they pose.

5. Posting MSDSs or similar written information for existing hazardous chemicals at the work site.

6. Following OSHA regulations in developing and implementing a written permit-required confined-space program. The program shall include policies, procedures, and employee training needs.

7. Developing and implementing an alternative entry program for nonpermit-required confined spaces as specified in 29 CFR 1910.146.

38.25 – Safety Practices. Basic safety practices for confined space entry are:

1. Ensure that qualified personnel conduct all planning sessions.

2. Follow requirements of written entry permit for permit-required confined spaces, 29 CFR 1910.146(f), or follow alternative entry procedures for nonpermit-required confined spaces, 29 CFR 1910.146(c) (5)(ii) as determined by a written alternative entry program.

3. Identify hazards.

- a. The quality of the atmosphere is questionable. Growth of bacteria, fungi, and other microorganisms can result in the buildup of toxic gases.
- b. Unexpected electrical or mechanical energy releases. Wet or damp conditions can cause electrical problems.
- c. A high chance of slips, trips, and falls; for example, due to rusted and deteriorated or slippery metal surfaces.

4. Apply safeguards.

- a. Always assume a safety and health hazard exists.
- b. Ensure that a second person is present to act as an attendant who does not enter the space under any circumstances.

- c. Always sample the atmosphere before entering or allowing entry into the confined space.
- d. Isolate sources of energy before entry.
- e. Do not use incompatible chemicals or flammable/com-bustible chemicals for disinfecting and cleaning in the confined space.

38.3 – Control of Hazardous Energy (Lockout/Tag-out). Where applicable, units shall establish a hazardous energy control program. The purpose of the program is to communicate a basic awareness of the procedures and skills that employees are required to possess, including those employees who may work near affected machines but not directly with them (29 CFR 1910.147).

1. Provide training to ensure that employees understand the purpose and function of the energy control program and that they acquire the knowledge and skills required for safe application, usage, and removal of the energy controls.
 - a. Provide training for each authorized employee in the recognition of applicable hazardous energy sources, the type and magnitude of the energy available in the workplace, and the methods and means necessary for energy isolation control.
 - b. Instruct each affected employee in the purpose and use of the energy control procedure.
 - c. Instruct all other employees, whose jobs are or may be in the area where energy control procedures may be used, about the procedures and the prohibition against attempts to restart or re-energize machines or equipment that are locked or tagged out.
2. Use lockout/tag-out devices for isolating, securing, or blocking machines or equipment from energy sources. Such devices shall be durable, standardized, substantial, and identifiable. The placement of a lockout device on an energy-isolating device indicates that the device and the equipment being controlled may not be operated until the lockout device is removed.
 - a. When an energy-isolating device cannot be locked out, securely fasten a prominent warning tag to it.
 - b. Where a tag cannot be affixed directly to the energy-isolating device, locate the tag as close as safely pos-

sible to the device, in a position that will be immediately obvious to anyone attempting to operate the device (29 CFR 1910.147(d) (4) (iii) (B)).

For more direction on “Application of Control” refer to 29 CFR 1910.147(d).

39 – FACILITIES. In this Handbook, “facilities” refers to the operation and maintenance of buildings and their associated grounds. As such, this chapter provides direction on a variety of specific practices and potential hazards concerning structures.

39.01 – Authority. The authority for walking and working surfaces, means of egress, emergency and fire prevention plans, flammable/combustible liquids, blasting, storage and handling of liquefied petroleum gases (LPG), PPE, sanitation, temporary labor camps, safety color coding, fire protection, handling materials, hoists, machine guarding, hand tools, guarding of portable powered tools, electrical requirements, and asbestos is in Title 29, Code of Federal Regulations (29 CFR), sections 1910.21 – 1910.27, 1910.35 – 1910.38, 1910.106, 1910.109 and 1910.110, 1910.132, 1910.134, 1910.141 and 1910.142, 1910.144, 1910.151, 1910.155, 1910.157, 1910.164 and 1910.165, 1910.176 and 1910.177, 1910.179, 1910.212, 1910.242 and 1910.243, 1910.301 – 1910.303, and 1910.1001.

The authority for housekeeping, illumination, jacks, electrical requirements, batteries and battery charging, motor vehicles and mechanized equipment, and ladders is in 29 CFR 1926.25, 1926.26, 1926.305, 1926.403, 1926.441, 1926.600 and 1926.601, and 1926.1053.

39.06 – Reference. Manufactured Housing Institute Standards (MHI).

39.1 – Qualifications. In addition to having the applicable training and certification listed in section 21.11, employees must be given the training required to safely and efficiently perform specific work projects or activities.

39.11 – Personal Protective Equipment. The JHA shall identify PPE for the specific work project or activity.

39.12 – Procedures. The work supervisor and employee(s) shall prepare and discuss a JHA for facility and office work projects or activities before beginning any work project or activity. The JHA shall include:

1. **Emergency Evacuation Plan.**
 - a. Name of employees and emergency phone numbers.
 - b. Other information pertinent to the work project or activity.
2. **Procedures for Bomb Threats and Other Security Issues.**
 - a. Receptionists shall be briefed on the specific procedures to follow in the event of a bomb threat.
 - b. The facility security checklist shall include procedures to guard against theft and assaults against employees.
3. **Availability of First Aid Supplies.**
 - a. In the absence of an infirmary, clinic, or hospital in near proximity to the workplace, a person or persons shall be trained to render first aid, including CPR.
 - b. A competent person shall check first aid supplies and equipment at regular intervals and restock as needed, paying particular attention to those items with expiration dates.
 - c. The remoteness from medical facilities and chances of severe injury shall dictate the type and quantity of first aid supplies available at the worksite.
 - d. Where employees may be exposed to injurious corrosive materials, facilities for quick drenching or flushing of the eyes shall be provided at the work area.
4. **Safety and Health Sessions.** Conduct and document facility/office safety and health “tailgate” sessions to increase the safety and health awareness of office employees.

39.13 – Safety Practices. The Occupational Safety and Health Act of 1970 promises job safety and health protection for workers by providing safe and healthful working conditions.

1. **Smoking.** Environmental tobacco smoke, also termed second-hand smoke, is classified as a known human carcinogen by the Environmental Protection Agency. To protect employees, con-

tractors, and visitors, smoking is prohibited inside all USDA facilities and motor vehicles.

Follow these basic practices for maintaining safe and healthful facilities.

2. Walking and Working Surfaces.

- a. Keep walking and working surfaces free of obstacles that create tripping and slipping hazards (sec. 32).
- b. Repair or replace as soon as possible any damaged floor surfaces, such as splintered wood, broken tile, or pitted concrete. Mark hazards that are not readily repairable.
- c. Maintain floors of every facility in a clean, well-lighted, and as far as possible, dry condition. Provide rubber, nonskid mats at entrances to buildings, especially during winter months. Use cones or other warning devices if repairs are delayed or cleaning is in progress (ex. 01).

39.13 – Exhibit 01 – Walking and Working Surfaces



- d. Coat highly polished surfaces, like linoleum or tile, with a slip-resistant finish.
 - e. Examine floor coverings, such as carpets and rugs, periodically for loose cords and other surface irregularities. Repair or replace them promptly.
 2. **Aisles, Passageways, and Storerooms.** Keep work areas, living space, storerooms, and other buildings clean and neat, with all materials properly stored.
 - a. Appropriately mark permanent aisles and passageways.
 - b. Keep aisles and passageways between cabinets, desks, and work benches free of obstructions that could create a hazard.
 - c. Keep passageways to electrical service equipment, switches, fire extinguishers, fire hydrants, stairways, and exits clear of obstructions at all times.
 - d. Avoid collisions by installing convex mirrors in blind spot areas.
 3. **Movable Equipment and Materials.** Store and secure movable equipment in an assigned location when not in use.
 - a. Prevent back injury by using correct lifting and carrying techniques (sec. 39.64). When the load is too big, bulky, or heavy, do not move it alone. Ask for help or use mechanical aids.
 - b. Clean debris from service/equipment repair areas before beginning a work project or activity. Clean up the work area after completing the job.
 4. **Floor Elevation.** Where possible, eliminate abrupt changes in floor elevation. Identify abrupt changes by marking, blocking, or barriers.
 5. **Openings.** Guard openings in floors, porches, and abrupt edges of loading docks with guardrails, mid-rails, and toeboards (sec. 32.2).
 6. **Stairways.**
 - a. Install nonskid treads on stairs.
 - b. Keep stairways free of defects, rubbish, slippery substances, loose materials, or obstructions that may cause slips, trips, or falls.

- c. Equip stairways having four or more risers with standard stair railings or handrails.
- d. Ensure that stair risers are uniform and well lit. Provide adequate lighting in and around work areas, passage-ways, ladders, stairways, and other areas used by employees.

39.2 – Living Quarters. Require employees to keep Government-provided quarters clean, sanitary, and free of hazards.

39.21 – Procedures.

1. Have unit managers review occupancy rules and the operation of all heating and cooling appliances with new occupants.

2. Inspect all Government-owned or -leased quarters annually to ensure occupant health and safety. Require each occupant of Forest Service quarters to report any unsanitary, hazardous, or unsafe conditions to the appropriate line officer. Ensure immediate action is taken to correct any such condition. The sample Facilities Safety Inspection Checklist form can be used to document unsafe facility conditions and corrective actions (sec. 39.9, ex. 01).

3. Authorize no structural modifications, plumbing, or electrical alterations (or additions) to Government facilities, except as approved through the administrative process. Allow only qualified persons to perform these modifications (sec. 34.2, para. 6).

4. Equip all facilities serving as quarters, such as family residences, trailers, sleeping areas (including hallways), crew quarters, and other dwellings, with photo cell or ionization-type smoke detectors/alarms.

- a. Provide fire extinguishers and locate them in conspicuous areas where they are readily accessible (sec. 55.1). Ensure extinguishers receive annual maintenance inspection.
- b. Provide a fire prevention/evacuation plan and make sure it is understood by occupants.
- c. Conduct fire drills at least twice annually and more often if the local line officer or other competent person(s) deems it necessary (sec. 34.11).

39.22 – Safety Practices.

39.22a – Permanent Crew Quarters. Employees are responsible for keeping their living areas clean and sanitary. Floors are to be swept, beds made, and personal articles organized or stored in an orderly manner. Horseplay is not permitted in crew quarters.

1. Inform employees that bunkhouse quarters are subject to inspections by appropriate Forest Service officers. The employees' privacy shall be honored.
2. Clean and sanitize washroom and shower areas and, when provided, refrigeration units, cook stoves, and other appliances.
3. Unless specially provided for, never keep perishable food in living quarters. Cooking is not permitted unless proper equipment is provided.

39.22b – Residences. Residents of Government-owned or -leased housing are responsible for minor maintenance of quarters and grounds (FSM 6445.3).

1. Conduct safety and health surveys at least annually to identify potential hazards or safety concerns. Basic surveys should include but are not limited to:
 - a. Stoves, furnaces, and fireplaces, to detect obstructed stovepipes and chimneys and improperly functioning heating systems. If malfunctioning equipment is suspected, have a qualified person examine the suspected problem area and make the necessary repairs.
 - b. Electrical wiring. If outlets require multiple plug-in adapters to provide enough receptacles, assess the residence for wiring inadequacy. Fuses blowing frequently or circuit breakers being thrown are indicators of electrical deficiencies.
 - c. Appliances. Ensure all appliances are vented to prevent overheating and fire. Follow the manufacturers' recommended venting procedures.
 - d. Incidental storage of flammable/combustible materials. Keep paints and petroleum products in closed, approved containers (sec. 61.51) and identify their contents (sec. 38.12). Dispose of cleaning rags after use in approved waste cans.

2. Keep walkways and roof areas over entries free from accumulation of ice, snow, and leaves.

3. Take steps to prevent carbon monoxide buildup. Carbon monoxide is a poisonous gas that is odorless, tasteless, textureless, and undetectable by human senses. Carbon monoxide results from incomplete combustion and can be produced by any flame-fueled device, including gas ranges; ovens with pilot lights; clothes dryers; gas or oil furnaces; fireplaces; coal stoves; wood-burning stoves; charcoal grills; hot water heaters; and space heaters fueled by propane, natural gas, or oil. Carbon monoxide can also be produced by all gasoline-powered equipment, such as generators, engines, chain saws, power boats, cars, and trucks. Carbon monoxide is also emitted from combustion of forest and range fuels (sec. 25.13a, para. 8).

a. To prevent carbon monoxide poisoning:

- (1) Install carbon monoxide detectors near the door that leads out to the garage and in the workplace, lookouts, mobile homes, house/office trailers, and especially sleeping areas, such as the sleeping cabin of boats.
- (2) Do not run gasoline or propane engines inside closed garages.
- (3) Operate charcoal grills outdoors only.
- (4) Keep stoves and furnaces properly adjusted.
- (5) Do not use space heaters without proper venting.

b. Symptoms of carbon monoxide poisoning include:

- (1) Initially, the symptoms are flu-like: headache, fatigue, nausea, dizzy spells, and irritability.
- (2) As carbon monoxide blood-levels rise, symptoms such as confusion occur, followed by unconsciousness, brain damage, and ultimately death.

39.3 – Lookouts. Employees working in lookouts are often isolated for long periods of time under primitive conditions. Supervisors shall ensure that the employees' overall health and welfare is not being compromised.

39.31 – Personal Protective Equipment. The JHA shall identify PPE for specific work projects or activities associated with lookout duties.

39.32 – Procedures. Prepare and discuss a JHA with employees (sec. 31.11 and 39.12). In the JHA, emphasize check-in procedures and identify specific hazards related to the duties of lookout personnel. Address safe work practices and emergency evacuation procedures, as well as public safety and health considerations.

39.33 – Safety Practices.

39.33a – General.

1. Have a competent person inspect lookout structures and take any necessary corrective action before occupancy.
2. Conspicuously post occupancy load limits on lookout structures. The lookout occupant is responsible for ensuring load limits are not exceeded.

39.33b – Structure Safety.

1. Keep walking areas free of obstructions. Walking surfaces exposed to the weather must have nonskid surfaces.
2. Keep trap doors closed when not in use. Guard open trap doors. Check trap doors frequently for soundness.
3. Maintain railings in safe condition, free of splinters and protruding nails. Ensure that railings are 42 inches (1 m) from the upper surface of top rail to floor, platform, runway, or ramp level. Install nonclimbable wire mesh between railings and cat walks. Wire mesh shall be grounded.
4. Have a sag chart for each tower with structural guy wires. Consult engineering personnel for the chart and additional specific direction.
 - a. Tighten guy wires during occupancy and loosen them when the tower is not occupied.
 - b. Use proper guy wire hardware and keep guy wires clean and lubricated to prevent corrosion.

39.33c – Personal Safety and Health.

1. Store food to prevent spoilage and protect against contamination and pests.

2. Consider all natural water sources as contaminated. Regularly test natural water supplies. If water is brought in, mark the containers as "Drinking Water." Keep water containers securely closed when not in use (sec. 55.11a).
3. Inspect outdoor toilet facilities annually and maintain them in a sanitary and structurally sound condition.
4. Provide lookouts with:
 - a. AC-line powered or battery type ionization smoke detectors.
 - b. Carbon monoxide detectors (sec. 39.22b), if the lookout contains a fuel burning stove, heater, or lights.
 - c. First aid kit (refer to the Glossary).
 - d. Fire extinguisher(s).
5. When using flammable fuel lanterns, always:
 - a. Shut off lanterns and allow them to cool before fueling.
 - b. Fuel them outside the building and only during daylight hours.
6. Do not start wood stove fires with flammable/combustible liquids.
7. When a liquefied petroleum (LP) gas system or equipment is used in a lookout, ensure that a qualified person completes and certifies all testing, adjustment, repairs, or alterations. Document the servicing and post the documentation near the appliance in plain view of users.
 - a. Pressure and leak test all fuel gas systems that have not been used for more than a month.
 - b. Make sure each system has containers, valve(s), connectors, manifold valve assemblies, and regulators of an approved type.
 - c. Mount containers upright on firm foundations. Secure them to prevent tipping or falling. Do not attach container(s) directly to the lookout structure.
 - d. Protect connections and containers from physical damage.
 - e. Test connections with a soapy water or bubble solution.
 - f. Vent stove and refrigeration units according to manufacturer's recommendations.

- g. Do not store LP gas containers inside buildings. Locate containers at least 25 feet (7-1/2 m) from structures or lightning grounding systems.
 - h. Locate gas lines away from downleads of lightning protection systems.
8. Provide radio or telephone communication at all times. Consider a backup system, such as a personal portable radio or portable phone.

39.34 – Lightning Protection. Do not occupy a lookout until the required lightning protection system is in place, all connections are tight, and downleads are continuous. Post the following instructions for telephones and radio use during electrical storms in exposed structures:

1. When the storm is 1 mile (1-1/2 km) or more away, and it is necessary to use the telephone:
 - a. Sit or stand on an insulated stool; keep feet off the floor.
 - b. Do not hold the receiver tightly against ear.
 - c. Do not touch any metal part of the telephone or building.
2. When the storm is less than 1 mile (1-1/2 km) away:
 - a. Stay away from the telephone. Remain in the building, as far as possible from windows, doors, metal objects, or electrical conductors.
 - b. Shut off the radio and telephone during storms. Reestablish communications only after the storm has passed.
3. Avoid entering or leaving lookout towers during high winds.
 - a. If the lookout tower entry way is exposed to prevailing winds, consider installing a wind shield or screen to allow the doors to be opened and closed without difficulty.
 - b. Shut off electrical appliances and extinguish all open flames, such as lanterns and LP gas stoves, during lightning storms.

39.34a – Inspections and Maintenance of Lightning Protection System.

1. Determine the frequency of inspections by such factors as:
 - a. Classification of the structure or area protected.

- b. Level of protection afforded by the system.
- c. Immediate environment (corrosive atmospheres).
- d. Materials from which components are made.
- e. The type of surface to which the lightning protection system components are attached.

39.4 – Mobile Homes and House/Office Trailers. This section includes safety standards for vehicular units used for residences, crew quarters, offices, and similar activities. Examples of these are mobile homes, trailers, and recreational vehicles.

39.41 – Qualifications. Trailers and storage of materials must comply with Manufactured Housing Institute (MHI) Standards (sec. 39.06).

39.42 – Safety Practices.

1. Provide mobile homes and house/office trailers with:
 - a. First aid kits (refer to the Glossary).
 - b. Ionization-type smoke detectors.
 - c. Carbon monoxide detectors, if fuel-burning furnaces or appliances are used in the structure (sec. 39.22b, para. 3).
 - d. LP gas detectors, where LP gas is used.
 - e. Mounted fire extinguishers (minimum 10 BC) that are located and identified so that they are readily accessible (sec. 35.11a).
2. Because trailer framing and roofs have limited load-bearing capacity, before beginning repair work, have a competent person determine the safe working loads.
3. Provide trailers in heavy snow country with separate sloped roofs or remove snow accumulation daily.
4. Before moving, blocking, and anchoring trailers, thoroughly inspect tires, lug nuts, hitches, lights, and frames.
 - a. Check carefully for tire deterioration and frame damage.
 - b. Lubricate wheel bearings.
5. Ensure trailer pads are as level as possible to provide uniform support for blocking.

6. Anchor trailers that will remain in one location for more than 2 months:
 - a. Use standard trailer tie down anchors or utility company screw augers.
 - b. If no anchor straps are provided on the trailer frame, use nylon straps or another approved strapping system that extends over the trailer body in a continuous piece to the anchor points.
 - c. Install a minimum of three anchor sets per trailer. (Nylon tends to deteriorate when exposed to the sun, so periodic inspections are necessary.)

39.43 – Trailer Utility Connections.

1. **Water.** Use National Sanitation Foundation approved piping for water supply connections. Never use garden hoses.
2. **Sewer.** Tightly fit sewer connections to reduce or eliminate fumes and odors. Protect sewer connections from damage.
3. **Electrical.** Use the trailer manufacturer's service cord or other Underwriters Laboratory (UL)-approved cord from a weather-tight, grounded receptacle that is mounted on a post or stand, and has a rain-tight breaker panel (ground-fault circuit interrupter protected).
 - a. Ensure the disconnect is accessible at all times.
 - b. Install service masts on adjacent poles, when feasible. They may be installed on trailers.
 - c. Have a licensed electrician inspect electrical wiring modifications or additions.
 - d. Ground the metal frame and skin of trailers through the electrical service panel only.
 - e. Require that each 120-volt, single-phase, 15- or 20-ampere receptacle outlet have a ground fault circuit interrupter in the following locations:
 - (1) Adjacent to a bathroom lavatory.
 - (2) Within 6 feet (1-3/4 m) of any lavatory or sink.
 - (3) In the area occupied by a toilet, shower, tub, or any combination.
 - (4) On the exterior of the vehicle.

4. **Liquid Petroleum (LP) Gas.** Make LP gas connections with blacksteel or hard copper piping designed specifically for this purpose.

- a. Leak test the fuel piping system and appliances of all trailers used to house and shelter employees.
- b. Pressure and leak test all trailer fuel gas systems that have not been used for more than a month.
- c. Do not deliver fuel to the system unless the system and appliances are leak-free and the LP gas regulator provides correct pressure control.
- d. Test the regulator for correct pressure regulation immediately before use.
- e. Have all testing, adjustment, repairs, or alterations of these facilities completed and certified by a qualified person.
- f. Use bubble soap for leak testing fuel piping.
- g. Electrically bond gas connections before disconnecting appliances or moving gas lines (ex. 01).

39.44 – Trailer Heating Systems. Refer to section 61.62 for inspection of LP gas fuel systems.

39.43 – Exhibit 01

If You Smell Gas:

- Extinguish any open flames, pilot lights, and all smoking materials.
- Do not touch electrical switches.
- Shut off the gas supplies at the tank valve(s) or gas supply connection.
- Open doors and other sources of ventilation.
- Leave the area until the odor clears.
- Have the gas system checked and leakage source corrected before using again.

1. **Ventilation.** Unit heating systems normally found in trailers use inside air for combustion. Additional ventilation may be needed to ensure proper combustion; open windows if necessary.

2. **Oil-Fired Furnaces.**

- a. Remove soot build-up in oil-fired flues at least every 2 months.
- b. Prohibit the use of gravity-fuel-feed systems with oil-fired furnaces.
- c. Provide shut-off valves at the heating appliance and the fuel storage tank.

39.45 – Entrances and Exits. Exits for trailers, mobile homes, recreation vehicles, and other similar units used as offices, crew quarters, and similar occupancy shall meet the following standards:

1. **Exterior Exit Doors.** All units 32 feet (9-3/4 m) and longer shall have two exterior exit doors.

- a. The doors shall not be located in the same room or less than 12 feet (3-1/2 m) apart in single-wide units or 20 feet (6 m) in double wide units.
- b. Two exits are required for all units less than 32 feet (9-3/4 m) in length, and one exit may be an approved exit window.
- c. All rooms used for sleeping purposes shall have at least one exit, either a door or approved window exit.
- d. Use of external padlocks on the outside of exit doors is prohibited.

2. **Window Exits.** Window exits shall open to the outside.

- a. The bottom of the window opening shall be 3 feet (3/4 m) or less above the floor.
- b. Locks, latches, operating handles, and other devices required to permit exiting shall be located 5 feet (1 1/2 m) or less from the finished floor.

3. **Entry Structures.** Doorways shall be provided with substantially constructed landings, stairs, and handrails.

39.5 – Offices. To ensure work safety, employee health, and productivity, design or adapt offices to meet the needs of employees.

39.51 – Safety Practices. Each office supervisor is responsible for the development of a job hazard analysis (JHA). The JHA shall

include information pertinent to specific office duties and responsibilities. Refer to section 39.12 for direction on the JHA information, section 39.13 for safety and health practices, and 29 CFR 1910.22 for housekeeping regulations.

39.51a – Furniture and Equipment Use. Provide employees with instructions to ensure that they understand the tools, machines, and equipment they will be working with and that they understand any associated hazards.

1. **Bookcases and file cabinets.**

- a. Do not allow materials and debris to accumulate on top of bookcases and file cabinets.
- b. Store heavier items in the lower drawers of file cabinets. Poor distribution of materials can cause cabinets to tip over if they are not secured to a wall. Open one drawer at a time and never leave an open drawer unattended. Adequately brace any free-standing book shelves over four shelves high. Fasten file cabinets and steel shelves together and to the wall.

2. **Chairs and Desks.** Avoid injuries when turning in swivel chairs. Keep all legs of the chair on the floor. Inspect chairs and desks frequently. Replace or repair defective parts. Do not stand on chairs or desks.

3. **Ladders.** Ladders present a major work hazard. Always follow the manufacturer's recommendations when using ladders (sec. 33.1). The JHA shall address procedures for the care and use of ladders.

4. **Video display terminals (VDT).** Use of a VDT may cause musculoskeletal disorders. Symptoms can include back pain; muscle fatigue; soreness in arms, wrists, or hands; stiffness in the neck or shoulders; tingling in the fingers; and loss of gripping control in extreme cases. Workstations should be designed to adjust to meet the needs of all employees (sec. 52.4).

- a. Position the screen, key board, and computer accessories to fit the employee.
- b. To maintain correct seated posture, position the top of the display screen at or just below eye level. The screen should tilt up slightly and be approximately 1-1/2 to 1-3/4

feet (1/2 m) from your face. Adjust the VDT controls (brightness, contrast) for more comfortable viewing.

- c. The National Institute of Occupational Safety and Health (NIOSH) recommends that pregnant women spend no more than 4 hours per day working at a VDT.

5. **Office machines.** The JHA shall include the use of office machines and where applicable, the use, storage, and disposal of flammables, combustibles, hazardous chemicals, material safety data sheets (MSDS), and other similar products.

- a. Only trained experienced people shall clear paper jams from office machines. Follow the manufacturer's recommendations for clearing paper jams.
- b. Manual paper cutters are provided with finger guards that shall not be removed. After use, return the cutting knife to the closed position and lock.

39.6 – Storage and Warehousing.

39.61 – Qualifications. In addition to having the applicable training and certification listed in section 21.11, employees shall be competent or receive training in the necessary skills to become competent before beginning work activities.

39.62 – Personal Protective Equipment. The variety of materials associated with storage and warehousing activities are too detailed to address individually. Supervisors are to ensure that a hazard assessment and PPE selection are conducted and identified in the JHA for the site-specific storage and/or warehousing activity. The general and specific requirements for PPE are in 29 CFR 1910.132 – 1910.138.

39.63 – Procedures.

1. Ensure workers understand and use proper lifting techniques (sec. 39.64).

2. Use mechanical assist devices, such as handtrucks, for moving equipment and supplies.

39.64 – Safety Practices. Basic safety and health practices for storage and warehousing activities include:

1. **Housekeeping** (sec. 39.13).
2. **Lifting Techniques.**
 - a. Bend and gently stretch to warm muscles.
 - b. Check the intended route and the point of placement before moving load.
 - c. ***Ask for help if the load is heavy. Do not try to lift or otherwise move material beyond your ability.***
 - d. If the load blocks your vision, get help.
 - e. Evaluate the load. Before lifting, check for nails, splinters, rough strapping, and sharp edges. Test the load by tipping it to one side. Use a handtruck or other mechanical aid whenever possible.
 - f. Stand close to the load with feet apart to lift.
 - g. To improve balance, keep your heels down and turn your feet slightly out.
 - h. Bend your knees, keeping your back as straight as possible.
 - i. Center your body over your feet, get a firm grip under the load, and pull it close to you. Test the load.
 - j. Lift gradually and smoothly. Lift with legs, arms, and shoulders. Keep the load close to your body. Rise slowly, straighten knees, and stand.
 - k. Avoid quick, jerky, and twisting motions. Do not change the position of your feet before the load is fully raised.
 - l. Face the spot where the load is to be placed. Point your feet in the direction of the move or turn; don't twist.
 - m. Bend your knees, keep load close to your body, and slowly lower the load to waist level. Keep your back straight. Support the load with your legs, arms, and shoulders (ex. 01).
 - n. Protect your fingers and hands from pinching and scraping.
 - o. In tight places, set the load down close to the final location and slide it into place.
 - p. When lifting a load from a table, shelf, or similar elevated surface, slide the load toward the edge. Support the load with the edge of the elevated surface and lift it as previously described. In placing the load on a raised surface, reverse this procedure.

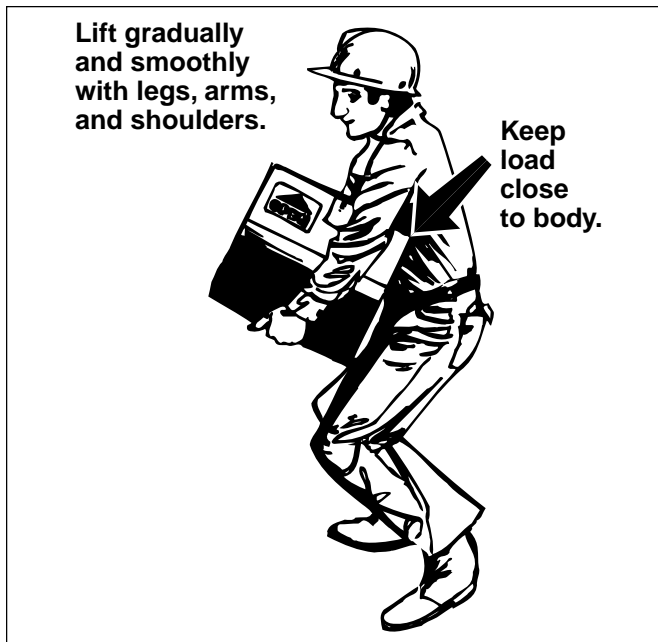
39.64 – Exhibit 01 – Safe Lifting Practices

- q. Avoid lifting above shoulder height. Use a step stool or platform to reach areas above the shoulders.
- r. Do not take "short cuts" or engage in "show-off" demonstrations of strength.

3. **General Storage Practices.** Calculate the maximum allowable load limits of shelves, bins, and racks for storage within buildings. Post limits conspicuously.

- a. Never store materials on supports not designed for such loading. This applies especially to the bottom boards of light-framed trusses.
- b. Always store tools or materials away from:
 - (1) Unguarded windows or scaffolds.

- (2) Heat sources, if flammable.
- (3) Aisles, fire exits, fire equipment, electric switches, panels, stairways, floor openings, and hoistways.
- c. When differences in road or working levels exist, use ramps, blocking, or grading to ensure safe movement of vehicles between the two levels. Guard other changes in level by railings, barriers, or painted markings.
- d. Ensure materials in compounds or storage areas are secured, display proper signage, and are adequately lit.
- e. Segregate materials by kind, size, and length. Stack them neatly.
- f. Secure all materials stored in tiers by stacking, blocking, interlocking, cross-piling, or cross-tying.
 - (1) Limit the height of the tiers so that they are stable and secure against sliding or collapse.
 - (2) Stack bagged materials by stepping back the layers and cross-keying the bags at least every 10 layers.
- g. Post the outside of buildings to warn fire personnel of open shafts, lofts, drying towers, windows, blocked doorways, and hazardous materials.

4. **Specific Storage Practices.** Store grass, seed, hay, straw, and baled excelsior in separate buildings that are well-ventilated.

5. **General Practices for Handling Materials.**

- a. Use appropriate PPE when handling heavy or sharp-edged objects and rough lumber.
- b. When unpacking materials, immediately pull or clinch protruding nails and staples in boards and boxes. Remove nails and staples from opened boxes and kegs used for storage or material carrying.
- c. Clearly label contents and special handling requirements on all containers.
- d. To avoid injury while stacking materials, use mechanical or ergonomically designed devices, such as skids, rollers, handtrucks, lift trucks, hoists, wheelbarrows, tongs, cant hooks, peaveys, haypoles, and hand spikes.
- e. Ensure that lift trucks and other mechanical lifting devices are operated only by trained (certified where applicable) and authorized workers (sec. 44.62).

6. Specific Practices for Handling Materials.

- a. **Steel products.** Stack and block structural steel, poles, pipes, bar stock, culverts and other cylindrical materials, unless they are racked or banded.
- b. **Bricks.** Never stack bricks more than 7 feet (2 m) high. Taper back stacks 2 inches (51 mm) for every 1 foot of height above the 4-foot (1-1/4-m) level.
- c. **Masonry Blocks.** Taper masonry blocks stacked higher than 6 feet (1-4/5 m) back one-half block per tier above the 6-foot level.
- d. **Short tiles.** Stack in a vertical position to keep tiles dry for ease of handling.
- e. **Lumber.**
 - (1) Remove nails from used lumber before stacking.
 - (2) Stack lumber on level and solid supports. Use cross strips or piling where the pile is more than 4 feet (1-1/4 m) high.
 - (3) Ensure that stacks are stable and self-supporting.
 - (4) Keep the top of lumber stacks as level as possible when lumber is removed.
- f. **Glass.**
 - (1) Carry glass on the outside of your arm, with the palm of your hand facing outward and the other hand reaching across the body and grasping the glass top.
 - (2) Keep your shirt sleeves buttoned around your wrists.
 - (3) Protect your wrists by gloves with gauntlets.
 - (4) Wear eye protection.
 - (5) Handle large panes one at a time.
 - (6) Store glass on edge in protected areas.
 - (7) Place cross tape on the surface to make the glass pane visible and mark "Glass" on it with felt pen.

39.7 – Shops.

39.71 – Qualifications. In addition to having the applicable training and certification listed in section 21.11, employees shall receive training in the use of power tools, machines, welders, and other hazardous equipment before operating them.

39.72 – Personal Protective Equipment. Wear PPE appropriate for the specific work project or activity. Identify PPE not routinely provided for in shop operations in the JHA.

Provide, use, and maintain protective equipment (including PPE for eyes, face, head, and extremities, protective clothing, respiratory devices, and protective shields and barriers) in a sanitary and reliable condition.

39.73 – Procedures.

1. Prepare and discuss a JHA with employees involved in work projects and activities.
2. Operate power tools and machines according to the manufacturer's instructions. Keep instructions where they are readily available to the operator.
3. Post or tag an "Out of Order" warning sign, identifying when the tool or machine became inoperative and your name, until repairs are completed.

39.74 – Safety Practices.

1. Ensure that all PPE is available, is in good condition, and is in use before starting any power-driven machines.
2. Inspect tools before each use to assure optimum working condition or proper adjustment.
3. Ensure that extension cords have adequate current-carrying capacity. Inspect extension cords regularly for damage and remove damaged cords from service when appropriate.
4. Anchor machines securely to the floor or other appropriate surface such as a workbench or table if they are not designated as portable.
5. Clear working surfaces of obstructions or unnecessary articles to allow for safe operations.
6. Ensure that guards and safety devices are functional, adjusted, and in place.

7. Ensure that all parts, such as cutting tools, tool holders, chucks, centers, guides, and clamps, are firmly adjusted for the work and are set to clear all moving parts.

8. Always stop a machine before servicing, adjusting, oiling, or repairing. Remove chuck wrenches and adjustment tools from machines immediately.

9. Exercise particular care that shop ventilation is adequate when running engines, welding, or working with chemicals.

39.74a – Automotive and Equipment Repair. Install a carbon monoxide detector(s) in garage areas where internal combustion engines are repaired (sec. 39.22).

1. Ensure that ventilation systems are specifically designed for the purpose.

- a. Vent engine exhaust to the outside.
- b. Construct battery charging areas so fumes are vented to the outside. Wiring switches, lights, and exhaust fans must be explosion-proof.
- c. When applying body putty, sanding, and finishing, keep the work area well ventilated. Some operations may require explosion-proof wiring.

2. When working on brakes and clutches that may create exposure to asbestos (sec. 61.8), follow these procedures:

- a. Always vacuum dust from the brake or clutch assembly when first opened. Vacuum around the worksite when the work is finished. Use vacuum cleaners specifically designed to collect and retain asbestos dust/fibers. Employees involved with brake or clutch assemblies, where asbestos is present, must be trained in respirator and vacuum use. Refer to section 61.8 for further direction on asbestos.
- b. Never blow dust from the assemblies or worksite with compressed air.

3. For further direction on welding operations, see section 27.23.

4. Do not leave creepers on the working or walking surface when not in use. Store them on end or hang them on a wall.

5. Allow catalytic converters to cool before working on them or in their proximity. Keep flammables/combustibles and cleaning materials away from the converter.

6. Legibly mark the manufacturer's rated load capacity on support stands and jacks and do not exceed them. Never work on or under a raised vehicle unless it is properly supported (sec. 42.1).

- a. When using jacks, block and secure the vehicle from movement.
- b. Use bumper jacks with extreme caution.
- c. Never use cement blocks or bricks as blocking material.
- d. Keep the area under jacks, support stands, and hoists clean and free of oil and grease.

7. *Before starting any work or adjusting the chassis of a dump truck with the bed in an elevated position, secure the bed by a permanently attached positive means of support in the locked position. Place a sign drawing attention to this requirement at eye level near both rear corners of the cab.*

8. Do not permit employees to service tires mounted on split-rim wheels unless they have been trained and instructed in the correct procedures (CFR 1910.177(c)).

9. Never use gasoline for cleaning. Cleaning solvents must have a flashpoint of 140 °F (60 °C) or higher. When possible, substitute organic nontoxic cleaning solvents.

10. Never park vehicles containing dangerous or flammable materials in repair shops, or perform maintenance work while a vehicle is loaded.

39.74b – Woodworking. Inspect woodworking shops regularly to ensure that:

1. Workers are not exposed to excessive amounts of dust;
2. PPE is available and is being used;
3. Guards and safety devices are adjusted and in place;
4. Employees are trained and understand the hazards associated with different pieces of machinery, and they know proper operating procedures; and

5. The work area is clean and free of debris or of any materials that could prove to be hazardous to those working there. For additional direction, refer to section 43.5.

The JHA shall identify the required PPE.

39.74c – Metal Working. Make sure supervisors and managers regularly inspect metal shops to ensure that appropriate PPE (including goggles or safety glasses, leather gloves, safety-toed boots, leather aprons, and specialized equipment associated with welding) is provided and used (sec. 27.23). The JHA shall identify the required PPE for the specific work project or activity.

Before starting any power-driven machine, check to see that:

1. The working surface is clear.
2. Guards and safety devices are in place and correctly adjusted.
3. The machine or tool is in safe operating condition, with all parts operating freely.

39.8 – Grounds Maintenance. Work duties include activities such as installing and maintaining traffic control devices, pruning, lawn mowing, weed/grass trimming, removing snow, and collecting garbage.

39.81 – Qualifications. In addition to having the applicable training listed in section 21.11, employees involved in sign installation and maintenance shall be skilled in using hand and power tools, such as motorized pruning, mowing, and snow removal equipment. The JHA shall identify the specific training required.

39.82 – Personal Protective Equipment. The following PPE is recommended for grounds maintenance:

1. Eye protection.
2. Hearing protection (85 dB and above).
3. Appropriate footwear.
4. Gloves.
5. Dust mask (when applicable).

6. Other PPE as identified in the JHA and/or MSDS.

39.83 – Safety Practices. Basic safety and health practices for grounds maintenance include:

1. After a site review and/or engineering study to determine needs, display a sign or identify the following situations accordingly:
 - a. One-way roads; road restrictions.
 - b. Public and employee hazard areas.
 - c. Speed limits.
 - d. Work zone (workers).
 - e. Non-potable water.
 - f. Legal and off-limits parking, crosswalks, children playing, and firewalks. Provide parking space delineators, striping, arrows, gates, central refuse bins, physical barriers, stanchions, or cones.
2. Follow these suggested safety steps for pruning, mowing, and snow removal:
 - a. Prune brush and trees for best visibility near access roads, intersections, and buildings. Refer to section 22.42 for further direction.
 - (1) Have the power company do all tree pruning for powerline clearances. Inspection of trees and landscaping is generally a Forest Service responsibility.
 - (2) Trim around pipes, markers, and monuments.
 - (3) Never leave lawn tools and work materials lying about.
 - b. Keep LP gas bottles or tanks and connecting pipes free of grass or other vegetation and guarded to prevent physical damage.
 - c. Follow the manufacturer's safety recommendations for the operation of rotary mowers/tractors and snow blowers. Keep walkways, roads, and parking areas free of ice/snow buildup.
 - (1) Inspect the work area before beginning a work project or activity. Remove objects that may be run over, thrown by, or cause damage or injury to people, equipment, or property.
 - (2) Remove ice/snow as it accumulates on eaves and roofs.

- (3) Maintain equipment in top mechanical condition. Inspect equipment before and after use to ensure safe operating conditions.
- (4) Start and refuel mowers/tractors and other fuel-burning engines outdoors. Cool the engine for 5 minutes before refueling. Move at least 10 feet (3 m) from the fueling point before restarting.
- (5) Restrict vehicles from parking in the work area. Clear the area of all people and pets for 100 feet (30-1/2 m). While people are passing, stop. Start only after people are out of the hazard zone.
- (6) The center of gravity for equipment varies greatly. Be familiar with the machine's capabilities and limitations. Follow the manufacturer's recommendations.
- (7) Turn off the motor when making adjustments or repairs.

3. In the JHA, address the hazards associated with performing garbage and debris collection tasks. Address personal hygiene and engineering controls for prevention and protection against personal injury and illness. Use the following methods in collecting garbage and debris:

- a. Use appropriate PPE, such as a litter/sanitation picker and gloves, when picking up trash.
 - (1) Wear disposable gloves for protection, even under leather gloves.
 - (2) Practice universal precautions when encountering suspected infectious or hazardous waste (refer to the Glossary).
 - (3) Be familiar with established unit procedures for handling and disposing of known or suspected infectious or hazardous waste.
- b. Store garbage in tight containers and secure them against upset or access by animals/insects.
- c. Use caution when disposing of razor blades, broken glass, and other sharps.
- d. Place central refuse bins on a hard surface. Ensure that refuse bins are stable and secure.

39.9 – Exhibits. A sample of the suggested format for a facilities safety inspection checklist is set out in exhibit 01.

39.9 – Exhibit 01 – Suggested Format for Facilities Safety Inspection Checklist

| | |
|---|---|
| District: <u>Missoula</u> Inspector: <u>C. Enstruom</u> Date: _____ | |
| Site: <u>Shop</u> Building Name: <u>N/A</u> Number: _____ | |
| Official in Charge of Facility <u>Duane Lumpry</u> | Present During Inspection Yes <u>X</u> No <u> </u> |
| Employees' Representative _____ | Yes <u> </u> No <u>X</u> |

| | A ¹ | U ¹ | N/A ¹ | Remarks |
|---|----------------|----------------|------------------|---------|
| 1. Housekeeping | | | | |
| a. Clean and free of hazards | — | — | — | |
| b. Grounds free of weeds and debris | — | — | — | |
| c. Equipment/furnace/electrical panel rooms | — | — | — | |
| d. Material storage | — | — | — | |
| e. Other _____ | — | — | — | |
| 2. Walking and Working Surfaces | | | | |
| a. Railings and toeboards | — | — | — | |
| b. Stairs | — | — | — | |
| c. Ladders | — | — | — | |
| d. Safe loadings of shelves, lofts | — | — | — | |
| e. Free of tripping hazards | — | — | — | |
| f. Other _____ | — | — | — | |
| 3. Exits and Related Features | | | | |
| a. Exit construction, width, number | — | — | — | |
| b. Exits unobstructed-UFAS ² compliant | — | — | — | |
| c. Exit signing and emergency lighting | — | — | — | |
| d. Interior finishes | — | — | — | |
| e. Evacuation plan posting and adequacy | — | — | — | |
| f. Furnishings | — | — | — | |
| g. Other _____ | — | — | — | |
| 4. Fire Protection | | | | |
| a. Fire extinguisher types | — | — | — | |
| b. Fire extinguisher spacing | — | — | — | |
| c. Fire extinguisher annual check | — | — | — | |
| d. Fire ladders | — | — | — | |
| e. Smoke detectors | — | — | — | |
| f. Other _____ | — | — | — | |
| 5. Machine Guarding | | | | |
| a. Saws, grinders, and other machinery | — | — | — | |
| b. Eye and face protective devices | — | — | — | |
| c. Other _____ | — | — | — | |

(continued)

39.9 – Exhibit 01 – Suggested Format for Facilities Safety Inspection Checklist (contd.)

| | |
|---|-------|
| 6. Electrical | |
| a. Service/building main disconnect | — — — |
| b. Circuit breaker identification and size | — — — |
| c. Working space adequate | — — — |
| d. Live parts guarded | — — — |
| e. System grounded | — — — |
| f. Receptacles and polarity | — — — |
| g. Cords, cord connectors, and caps | — — — |
| h. Lighting fixtures, lampholders, lamps | — — — |
| i. Conduit system intact/supported | — — — |
| j. Boxes/cover plates | — — — |
| k. Appliances, motors | — — — |
| l. GFCI ³ protection in proper locations | — — — |
| m. Other _____ | — — — |
| 7. Gas Appliances | |
| a. Gas appliances not used where flammable vapors likely to be present (minimum 18" or 0.46 m above garage floor) | — — — |
| b. Appliances and connectors protected from physical damage | — — — |
| c. Appliances accessible for service | — — — |
| d. Clearance from combustibles | — — — |
| e. Combustion air openings unobstructed | — — — |
| f. Appliance connectors | — — — |
| g. Appliance shut-off valves accessible | — — — |
| h. Vents and vent connectors | — — — |
| i. Return air filters | — — — |
| j. Other _____ | — — — |
| 8. LP⁴ Gas | |
| a. Location of containers | — — — |
| b. Clearance from combustibles | — — — |
| c. Protection from vehicles | — — — |
| d. "No Smoking" signs | — — — |
| e. Condition of regulator and pig tail | — — — |
| f. Regulator placement | — — — |
| g. Tank valving | — — — |
| h. Rain cap on pressure relief | — — — |
| i. Tank condition | — — — |
| j. Painting of the tank | — — — |
| k. Other _____ | — — — |
| 9. Water Heaters | |
| a. Pressure and temperature relief valve | — — — |
| b. Water heater anchored or strapped | — — — |
| c. Full way shut off valve | — — — |
| d. 18" (0.46 m) above floor if in garage | — — — |
| e. Appliance and connectors protected from physical damage | — — — |
| f. Clearance from combustibles | — — — |
| g. Combustion air | — — — |
| h. Appliance connector | — — — |
| i. Appliance shut off valve accessible | — — — |
| j. Draft hood in place | — — — |
| k. Vents and vent connectors | — — — |
| l. Other _____ | — — — |

(continued)

39.9 – Exhibit 01 – Suggested Format for Facilities Safety Inspection Checklist (contd.)

| | |
|--|-------------|
| 10. <u>Compressed Gases</u> | |
| a. Cylinder condition | ___ ___ ___ |
| b. Cylinders secured | ___ ___ ___ |
| c. Other _____ | ___ ___ ___ |
| 11. <u>Flammable and Combustible Liquids</u> | |
| a. Storage containers | ___ ___ ___ |
| b. Storage cabinets | ___ ___ ___ |
| c. Emergency power cutoff (for dispenser) | ___ ___ ___ |
| d. Ignition sources out of hazardous areas | ___ ___ ___ |
| e. Other _____ | ___ ___ ___ |
| 12. <u>Roads, Walkways, and Grounds</u> | |
| a. Sight distance at intersections | ___ ___ ___ |
| b. Vegetation encroachment | ___ ___ ___ |
| c. Signing | ___ ___ ___ |
| d. Hazards in parking areas | ___ ___ ___ |
| e. Speed bumps and water diverters | ___ ___ ___ |
| f. Walkways, ramps and stairs hazard free | ___ ___ ___ |
| g. Drainage around buildings | ___ ___ ___ |
| h. Garbage and trash storage areas | ___ ___ ___ |
| i. Other _____ | ___ ___ ___ |
| 13. <u>Plumbing and Water Systems</u> | |
| a. Cross connections: | |
| (1) Irrigation systems | ___ ___ ___ |
| (2) Other _____ | ___ ___ ___ |
| b. Chlorination | ___ ___ ___ |
| c. Signing and fencing around tanks | ___ ___ ___ |
| d. Toilet ballcocks | ___ ___ ___ |
| e. Other _____ | ___ ___ ___ |
| 14. <u>Miscellaneous</u> | |
| a. First aid supplies readily available | ___ ___ ___ |
| b. Woodstove chimneys properly maintained | ___ ___ ___ |
| c. Woodstove clearance from combustibles | ___ ___ ___ |
| d. OSHA posters | ___ ___ ___ |
| e. Personal protective equipment | ___ ___ ___ |
| f. "Caution, Danger" signs | ___ ___ ___ |
| g. Bookcases, tall cabinets anchored | ___ ___ ___ |
| h. Noise levels | ___ ___ ___ |
| i. Hazardous materials | ___ ___ ___ |
| j. Other _____ | ___ ___ ___ |
| | |
| ¹ A = Acceptable; U = Unacceptable (provide explanation); N/A = Not Applicable. | |
| ² UFAS: Uniform Federal Accessibility Standards | |
| ³ GFCI: Ground-fault circuit interrupter | |
| ⁴ LP: Liquid petroleum | |

CHAPTER 40 – EQUIPMENT AND MACHINERY

Contents

41 HANDTOOLS

- 41.01 Authority
- 41.04 Responsibility
 - 41.04a Supervisors
 - 41.04b Employees
- 41.1 Qualifications
 - 41.11 Personal Protective Equipment
 - 41.12 Procedures
 - 41.13 Safety Practices
- 41.2 Chopping Tools
 - 41.21 Safety Practices
- 41.3 Cutting Tools
 - 41.31 Safety Practices
- 41.4 Storage
 - 41.41 Safety Practices

42 OTHER TOOLS AND EQUIPMENT

- 42.01 Authority
 - 42.1 Safety Practices
 - 42.2 Rigging Equipment for Material Handling
 - 42.21 Safety Practices
 - 42.3 Chains
 - 42.31 Safety Practices
 - 42.4 Slings
 - 42.41 Safety Practices

43 POWER-OPERATED TOOLS

- 43.01 Authority
- 43.04 Responsibility
 - 43.04a Supervisor
 - 43.04b Employees
- 43.1 Qualifications
 - 43.11 Personal Protective Equipment
 - 43.12 Safety Practices
- 43.2 Air Receivers
 - 43.21 Safety Practices
- 43.3 Pneumatic Power Tools
 - 43.31 Safety Practices

- 43.4 Powder/Explosive-Actuated Tools
- 43.41 Safety Practices
- 43.5 Woodworking Equipment
- 43.51 Safety Practices
- 43.51a Portable Saws, Jointers, and Sanders
- 43.6 Drills
- 43.61 Safety Practices
- 43.7 Grinders
- 43.71 Personal Protective Equipment
- 43.72 Safety Practices

44 HEAVY EQUIPMENT

- 44.01 Authority
- 44.04 Responsibility
- 44.04a Supervisor
- 44.04b Employees
- 44.06 Reference
- 44.1 Qualifications
- 44.11 Personal Protective Equipment
- 44.12 Safety Practices
- 44.2 Crawler-Tractors
- 44.21 Safety Practices
- 44.22 Scrapers
- 44.22a Safety Practices
- 44.23 End Loaders/Backhoes
- 44.23a Safety Practices
- 44.24 Motor Graders
- 44.24a Safety Practices
- 44.25 Shovels and Cranes
- 44.25a Safety Practices
- 44.3 Chippers
- 44.31 Safety Practices
- 44.4 Mulch Spreaders
- 44.41 Safety Practices
- 44.5 Trail Rock Crushers [Reserved]
- 44.6 Trucks/Forklifts
- 44.61 Standards
- 44.62 Powered Industrial Trucks (Forklifts)
- 44.62a Safety Practices
- 44.63 Dump Trucks

- 44.63a Safety Practices
- 44.7 Drill Rig Operations
- 44.71 Standards
- 44.72 Qualifications
- 44.73 Personal Protective Equipment
- 44.74 Safety Practices

45 EQUIPMENT DEVELOPMENT

- 45.01 Authority
- 45.03 Policy
- 45.1 Procedures

CHAPTER 40 – EQUIPMENT AND MACHINERY

41 – HANDTOOLS

41.01 – Authority. The authority for safeguards for personnel protection (relevant to electrical hazards) is in Title 29, Code of Federal Regulations (29 CFR), section 1910.335.

The authority for eye and face protection, storage, and use of handtools is in 29 CFR 1926.102, 1926.250, 1926.300, and 1926.301.

41.04 – Responsibility.

41.04a – Supervisors. Supervisors have the responsibility to:

1. Ensure that tools are not modified or used in any manner that increases the risk of injury.
2. Ensure that tools remain in a safe condition through periodic inspection and repair. This includes tools furnished by employees.
3. Monitor employee performance periodically to ensure proper methods are followed.

41.04b – Employees. Employees are responsible for using handtools in the prescribed manner. Employees assigned to tool rooms are responsible for inspecting and for repairing or replacing handtools as necessary.

41.1 – Qualifications. Supervisors shall ensure that employees are trained in the proper use and care of the handtools required by the work project or activity. Only employees who have demonstrated their ability to handle a tool safely shall be permitted to work alone with that tool. Basic training may include:

1. Appropriate use of tools and personal protective equipment (PPE).
2. Operating limitations of tools.
3. Inspections.
4. Adjustments and maintenance (changing heads, bits, blades, handles).

5. Safety features.

6. Care and cleaning.

7. Other items included in the job hazard analysis (JHA) (Form FS-6700-7 or equivalent).

41.11 – Personal Protective Equipment. In the JHA, identify the PPE necessary to protect employees from specific hazards of the work assignment.

41.12 – Procedures. The work supervisor and employees shall prepare a JHA for work projects and activities that involve handtools.

41.13 – Safety Practices. Because handtools seem easy to use, people often expect them to do more than they were designed to do and frequently use the wrong tool for the job. Using wrenches as hammers and hammers for striking wrenches when working with particularly stubborn nuts are two typical examples. Observe the following guidelines when selecting and using a tool:

1. Select ergonomically designed tools (weight, size, and type) and consider buying several versions or sizes of the same tool. Use each tool only for the job it was designed to do.

2. Keep jaw teeth, cutters, and blades sharp for better results. Sharp tools improve accuracy, lower fatigue, and lessen the risk of accident and injury. Inspect handtools for distortion, cracks, chips, wear, or mushrooming.

3. Keep all tools clean and in working order. Protect them against corrosion damage. Wipe off accumulated grease and dirt. Lubricate moving and adjustable parts to prevent wear and misalignment.

4. Keep handles tight; secure them with wedges when necessary. Inspect wood handles for splitting, cracking, checking, warping, and splinters. Do not use a tool with a loose or damaged handle.

5. Before using a tool near electricity, shut off the current in near-by circuits.

6. In the presence of flammable materials or explosive dusts and vapors, use nonsparking tools. Do not expose tools to excessive heat or use urethane-coated tools in excessive temperatures.
7. Never throw tools under any circumstances.
 - a. When a tool is not in use, shield any sharp edges and place the tool in a predetermined location, away from personnel. When transporting tools to and from the job site, ensure that sharp edges are guarded.
 - b. Never transport loose tools inside the same compartment with employees unless the vehicle is equipped with a protective screen, net, or secured stationary toolbox.
8. Discard or repair damaged or abused tools promptly. Temporary and makeshift repairs are prohibited. If tools cannot be repaired on site, return them to the tool room for repairs or replacement. Separate tools needing repair from broken or worn out tools.
9. Discard a tool instead of repairing it by welding or brazing.
10. Provide suitable storage racks and bins for tools needing repair or maintenance.

41.2 – Chopping Tools. Chopping tools include axes, adzes, brush hooks, hatchets, machetes, and pulaskis.

41.21 – Safety Practices. Follow these basic safety practices for maintenance and use.

1. Instruct employees in proper chopping techniques and tool sharpening.
 - a. When grinding, grind slowly toward the cutting edge, taper properly, avoid overheating, and use a file and stone to remove burrs or rough spots.
 - b. When filing, secure work in a clamp or vise. Stroke the file across the edge. Finish the edge with a hand stone. Wear gloves and use a file equipped with a handle and knuckle guard (ex. 01).
 - c. Replace and discard axes, pulaskis, and hatchets that are excessively round-cornered. Check against standard templates. Inspect for loose or cracked heads and split, crooked, warped, or splintered handles.

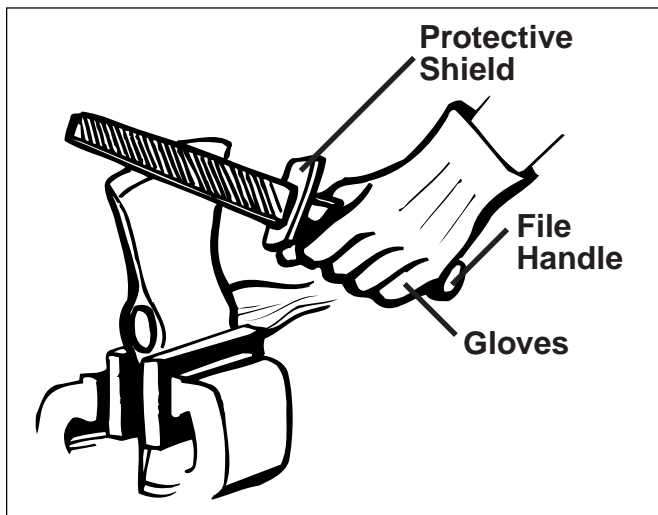
41.21 – Exhibit 01 – Tool Sharpening

2. Carry a chopping tool by grasping around the shoulder of the handle close to the tool head. Hold the tool so that the flat surface of the blade is vertical (parallel to your leg), with the arm hanging naturally at one's side. Never carry a chopping tool on your shoulder. Carry the tool on the downhill side so that it can be more easily discarded in case of a fall.

3. Always remove branches, underbrush, or debris that might interfere with chopping. Follow these general rules:

- a. Do not allow people to stand in the chopping area, and alert other workers of the distance chopped materials may fly.
- b. Protect all workers against flying chips and other chopping hazards by wearing appropriate PPE.
- c. Remove all overhead obstructions the tool might strike or hang up in. Always position your body securely while working with a tool.

- d. Never chop cross-handed; always use a natural striking action.
- e. Be alert when working on hillsides or uneven ground.
- f. Be especially watchful for spring loading, if cutting a sapling that is bound down. Be alert for sudden breakage. If there is not a need to cut it, leave it.
- g. Standing on a log to chop is not recommended. There are exceptions, exercise caution in such situations.
- h. Never use chopping tools as wedges or mauls.
- i. Do not allow two people to chop together on the same tree.
- j. When chopping limbs from a felled tree, stand on the opposite side of the log from the limb being chopped and swing toward the top of the tree or branch.
- k. Do not allow the tool handle to drop below a plane that is parallel with the ground unless chopping on the opposite side of a tree from where your body is positioned.
- l. If the cutting edge picks up a wood chip, stop. Remove the chip before continuing.
- m. To prevent glancing, keep the striking angle of the tool head almost perpendicular to the tree trunk.
- n. Use special foot and shin/leg protection if needed.

41.3 – Cutting Tools. Cutting tools include saws, knives, chisels, files, shears, and snips.

41.31 – Safety Practices. Follow these basic guidelines for maintenance and use:

1. **General Guidelines.** Cutting tools must be handled with extra care. Do not store them with other tools in a drawer where someone could be cut accidentally by inadvertently grabbing a sharp edge.

Wear safety goggles or other appropriate eye/face protection and gloves when working with cutting tools. Always select the right size and type of tool for the work project or activity.

The nuts and bolts on tools, such as shears and snips, require frequent adjustment. Wipe the edges of cutting tools frequently with a lightly oiled rag. Never hit a cutting tool with a striking tool.

2. **Handsaws.** Keep saw teeth sharp and properly set. Protect saw teeth with a sheath/guard when not in use. Consider the shape and correct teeth for the material to be cut.

Examine materials being cut for nails, knots, and other objects that may damage the saw or cause the saw to buckle. Hold pieces being cut firmly in place. If long pieces are being cut, use a supporting bench to prevent pinching at the cut.

Hold the saw firmly and begin slowly to avoid jumping the blade. Pull upward until the blade bites. Start with a partial cut; then set the saw at the proper angle.

a. **Bow Saws.** Specific techniques include:

- (1) When inserting a blade in a bow-saw frame, keep your hands and fingers in the clear when the tension lever snaps into or against the saw frame.
- (2) When removing a bow-saw blade from the frame, ensure that the blade guard is in place.
- (3) Carry a bow saw over your shoulder with the guarded blade to the rear and on the downhill side when applicable. Ensure the cutting edge faces away from your body, even when the guard is in place.
- (4) Do not push or force the saw. Begin with light gentle strokes until the teeth begin forming a kerf.

b. **Crosscut Saws.** Refer to section 22.48h for direction.

c. **Hacksaws.** Specific techniques include:

- (1) Select the proper blade for the material being cut.
- (2) Point the blade teeth forward. Always keep the blade taut and the frame properly aligned.
- (3) Use strong, steady strokes, directed away from your body. Use the entire length of the blade in a stroke. Cut hard materials more slowly than soft materials.
- (4) Do not cut thin, flat pieces from edge to edge, always clamp them securely and cut so that several teeth are cutting at all times.

3. **Knives.** Specific techniques include:

- a. Keep handles in place and cutting edges sharp and free of nicks.

- b. When using drawknives, place material at working height, firmly anchor it, and hold it steady. Do not use a drawknife on material being braced by a worker's knees.
 - (1) When possible, use pocket knives that lock open.
 - (2) Keep your fingers away from the knife's edge as you close it.
4. **Chisels/Punches.** Specific techniques include:
- a. Select the proper hammer for striking. When striking a chisel, punch, or wedge, the hammer's striking face should have a diameter approximately 3/8 inch (9-1/2 mm) larger than the face of the tool being struck.
 - b. Select a wood chisel large enough for the job and drive it with a wooden or rubber maul of sufficient weight. Use the proper chisel for the material being cut.
 - c. For striking metal chisels and punches, select a ball peen hammer of the proper size.
 - d. Hold chisels near the top with a steady but relaxed grip. Keep your eyes on cutting edge of the chisel.
 - e. Wear goggles when chipping. Always chip away from yourself, and inform others in the work area of the hazards associated with chipping. Provide bystanders with eye protection with side shields.
 - f. Repair or replace mushroomed chisels, and discard broken or cracked chisel handles. When sharpening a chisel, maintain its original shape and angle.
 - g. Never use a brick chisel on metal.
 - h. Never use a screwdriver as a cold chisel or punch.
 - i. Punches must be straight and heavy enough for the work. Keep them accurately ground at all times.
 - j. Start punches with light taps. Hold them securely, especially on rounded surfaces. When knocking out rivets and pins, begin with a starting punch; finish with a pin punch.
 - k. Never use a punch with a mushroomed face or a chipped or deformed point.
5. **Files.** Specific techniques include:
- a. Equip files with properly sized handles and knuckle guards, and wear cut-resistant (or leather) gloves when using files.

- b. Tap the file into the handle by striking the handle end on a flat surface. Do not drive the handle onto the file with a hammer.
- c. Keep the file free of oil, grease, and shavings. Discard dull files or files with hard spots.
- d. Use the correct type of file for the work. Cut on the forward pass of the file only; do not file backwards. When filing small objects, clamp the material securely in a vise or clamp with sufficient pressure.

41.4 – Storage. Toolboxes, chests, and cabinets may seem safe, but improper use can lead to serious accidents resulting in injuries.

Always ensure that all drawers are closed. Overhead drawers are unsafe and can cause the unit to suddenly tumble over onto the user.

41.41 – Safety Practices. Toolbox guidelines include:

1. Select a toolbox that is compatible with the intended use.
 - a. The design of the toolbox shall:
 - (1) Allow for storage, removal, and transportation of tools efficiently and without damage.
 - (2) Include carrying handles for easy moving.
2. Limit the size of a portable toolbox so that it can be easily handled and secured in position on a vehicle.
3. Keep toolbox lids and edges free of rough, sharp edges and surfaces.
4. Never use a toolbox as a ladder or as an anvil.
5. Never walk backward while pulling a toolbox with wheels.

42 – OTHER TOOLS AND EQUIPMENT. To eliminate accidents and injuries resulting from careless and improper handtool use, train employees in tool use and enforce safety rules.

42.01 – Authority. The authority for handling materials, slings, and portable tools and equipment is in Title 29, Code of Federal Regulations (29 CFR), sections 1910.176, 1910.184, and 1910.244.

The authority for storage, rigging equipment for material handling, wedges, jacks, and hoists is in 29 CFR 1926.250 - 1926.252, 1926.305, and 1926.552 - 1926.554.

42.1 – Safety Practices. Follow these basic guidelines for maintenance and use:

1. **Pry, Digging, and Tamping Bars.**
 - a. Wear appropriate PPE, such as eye/face protection, foot protection, gloves, and hardhat.
 - b. Transport bars separated from people and secured from movement.
 - c. Secure fulcrums and toeholds. When prying, push with your palms. When applying leverage, keep your feet and other parts of your body out of line with the bar.
 - d. When breaking, chipping, or prying rock or similar materials, ensure that other people are not within the striking distance of flying particles.
 - e. Carry bars at their balance point and on the downhill side.
 - f. Lay the bar flat and in the clear when not in use.
 - g. Maintain bars by keeping them straight. Sharpen the tip to retain the factory bevel.
 - h. Replace bent or twisted bars. Bent or twisted bars can rotate during use and strike the user.
 - i. Store bars so that they do not present a tip-over or falling hazard.

2. **Grubbing Tools.** Such tools include grub hoes, mattocks, picks, pulaskis, combination tools, McLeods, and various types of hoes.
 - a. Instruct employees in the use and maintenance of grubbing tools.
 - b. Keep the blade eye tight-fitting and secured. Repair or replace defective or excessively worn tools immediately.
 - c. When working, ensure secure footing. Maintain a tight grip on the handle, and keep legs and feet in the clear when swinging. Avoid directing the tool toward the body. Keep the tool out in front. Use gentle but deliberate swinging or hoeing action.
 - d. Do not allow people to stand in the chopping, grubbing, or hoeing area. Alert other workers of the distance that

debris may fly. Watch for rocks or objects that will cause the tool to glance, rebound, or create excessive flying material.

- e. Maintain 10 feet (3 m) minimum between people when they are walking or working.
- f. Remove all overhead obstructions the tool might strike or hang up in.

3. **Wrenches.** Generally, the safest wrench is a box or socket type. Open end, flare nut, and adjustable wrenches are not as strong as the corresponding sizes of box or socket wrenches and are not intended for heavy loads, such as breaking loose frozen fasteners or final tightening. If the wrench is not the correct size for the fastener, it is likely to damage the corners of the fastener, slip or break and cause an injury.

- a. Use tools with insulated handles for electrical work.
- b. Select the correct size and type of wrench for each job. Do not extend the wrench handle with pipe or other "cheater bar" to add leverage.
- c. Never use a wrench as a hammer. Never use pipe or Stilson wrenches as monkey wrenches.
- d. Whenever possible, pull rather than push a wrench handle. Pull it toward you at right angles. Adjustable wrenches should be tightly adjusted to the nut and pulled in such a manner that the force is on the side of the fixed jaw.
- e. Never use a wrench on material or machinery in motion. Do not position hands so that they can be jammed against other objects if a wrench slips.
- f. Replace and discard wrenches when the jaws are sprung.
- g. Keep jaw corrugations on Stilson wrenches sharp and clean.
- h. Keep handles and adjusting screws on all wrenches in good condition.

4. **Hammers.** Hammers are one of the most widely used type of handtool and one of the most often abused. More than two dozen styles of hammers are manufactured in various types, sizes, and configurations for very specific purposes. It is essential for

safety and efficiency to select the proper hammer for the specific work project or activity.

- a. Ball peen hammers of the proper size are designed for striking metal chisels and punches and for riveting, shaping, and striking unhardened metal.
- b. Always use a wood or rubber maul of sufficient weight with wood-handle chisels. Ensure that handles are not cracked.
- c. Hold nails being driven just under the head and not at the base.
- d. Never use a nail hammer to strike a nail-puller bar.
- e. When driving a large bar or post requiring assistance, have the helper hold the object with tongs.
- f. Use a maul tempered harder than the object being struck.

5. **Pliers.** Pliers are designed and manufactured to perform specific functions; pliers are not wrenches, and they should not be used to turn nuts or bolts.

- a. Do not use pliers in place of a wrench.
- b. Discard pliers if they have chipped or dulled cutting edges.
- c. Use specifically manufactured pliers to cut hardened wire.
- d. Always cut at right angles.
- e. Do not rock pliers from side to side or bend the wire back and forth against the cutting edges.
- f. Do not use pliers as a substitute for a hammer.
- g. Pliers with plastic coated handles are not designed to provide electrical protection.

6. **Screwdrivers.** Screwdrivers come in many sizes and shapes and are to be used only for driving and withdrawing threaded fasteners. Suggested safety practices include:

- a. Have a proper assortment of screwdrivers on hand.
- b. Select a properly fitted screwdriver; the blade will make a snug fit.
- c. Select a handle design that provides both comfort and proper leverage. Plastic and other handle coatings are for comfort only. They do not provide protection when working around electricity.

- d. Use the appropriate PPE for the work to be performed.
- e. Do not use a screwdriver at eye level when directing pressure upward.
- f. Always be prepared to respond should the screwdriver slip.
- g. Exercise caution when working overhead and/or on a ladder.

7. **Vises.** Vises come in many sizes and shapes and are manufactured to hold specific types of work. A vise with bolt holes must be bolted, not screwed, to a bench. A vise that is loose at its base, or with its jaws clamped too loosely on the work, can cause accidents and injury. A vise with overtightened jaws can crush or damage the work. Proper pressure must be applied.

- a. Use arm power only to close the jaws of a vise. Do not use an extension or a “cheater” over the handle to tighten jaws.
- b. Do not use a hammer to force the handle tighter.
- c. For a safe, secure hold, do the work as close to the vise jaws as possible.
- d. Support long overhanging work at the far end with a saw horse or similar device.
- e. When possible, clamp work centrally in the jaws instead of the corners. Use special jaw inserts for contoured or soft work pieces.

8. **Jacks.** Employees use various types of jacks, such as lever, ratchet, screw, and hydraulic jacks.

- a. Select jacks strong enough to hold the load safely and securely.
- b. See that the manufacturer's rated capacity is legibly marked on all jacks. Never exceed the rated capacity.
- c. Use only jacks that have a positive stop to prevent over travel. The operator must watch the stop indicator, which has to be kept clean in order to determine the limit of travel.
- d. Inspect jacks before using. Tag jacks if they are inoperable, and do not use them until repairs are made. Follow this inspection timetable and inspect each jack thoroughly:

- (1) For constant or intermittent use at one locality: at least once every 6 months.
 - (2) For jacks sent out of the shop for special work: when sent out and when returned.
 - (3) For a jack subjected to abnormal load or shock: immediately before and immediately after use.
- e. Lubricate jacks at regular intervals according to manufacturer's specifications or at least twice a year. Store them away from moisture.
 - f. Supply hydraulic jacks exposed to freezing temperatures with an adequate antifreeze liquid.
 - g. Always place the base of the jack on a level, firm foundation. When using cup-provided jacks, if there is a possibility of cup slippage, place a block between the cup and the load. Center the load to prevent tipping.
 - h. Chock or block and secure vehicles before raising them.
 - i. After the load has been raised, crib, block, or otherwise secure it at once.
 - j. Shore any load that must remain raised in a position for any length of time.
 - k. ***Securely block the load up on jack stands before someone gets under an object supported by a jack or hoist.***
 - l. ***Never get under a load supported by a jack unless the object is securely blocked on jack stands or on other approved support that's designed for the load.***
 - m. Tag any jack that is out of order. Do not use it until it is repaired. Replace jacks not easily repaired.

9. **High-lift Jacks.** High-lift jacks, such as the "handyman" jack, if misused or not maintained correctly, are potentially hazardous (refer to the Glossary).

- a. Always follow the manufacturer's suggested operation, safety, and maintenance instructions.
- b. Conduct training sessions to demonstrate the safe use of jacks.
- c. Review the conditions under which specific jacks may be used and ensure that operators are trained to use them properly.
- d. Never stand directly in front of a high-lift jack.

10. **Handtrucks.** It is extremely important to select the appropriate handtrucks for the specific load to be moved or for the work project to be performed. Consider the following:

- a. Load-carrying capacity, strength of frame, leverage, and nose plate for stability.
- b. Handle configuration and type (single, double, continuous, integral, or a combination).
- c. Ergonomic design to allow the load balance point to move easily over the wheels, reducing break-over effort.
- d. Rear casters that support the weight of the load to help keep the load balanced; also casters that swivel to reduce the effort of maneuvering.
- e. Specially designed heavy-duty appliance handtrucks with auto-rewind ratchet tighteners and retractable molded casters (ex. 01).

42.1 – Exhibit 01 – Handtruck

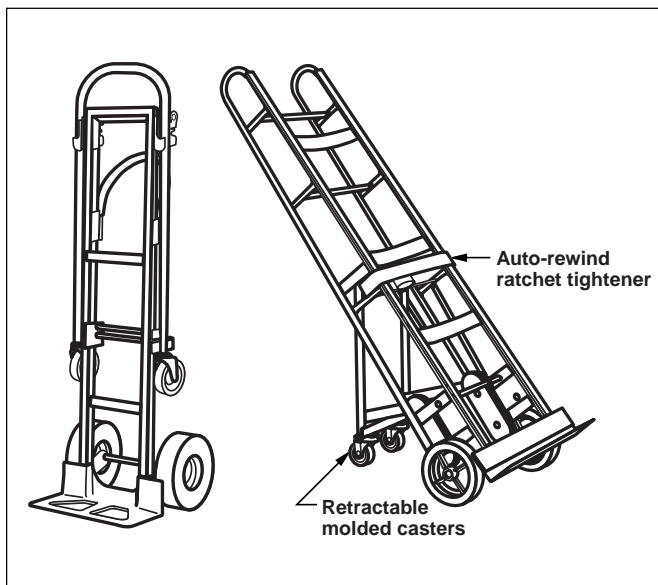

- f. Proper handtruck operation:
- (1) Follow the manufacturer's operating instructions and do not exceed load-carrying capacities.
 - (2) Before moving forward, make sure the path is smooth and clear. Bumps or obstacles can cause the load to fall.
 - (3) Make sure that the load does not block your vision. Keep the load secure and well-balanced.
 - (4) When moving a single large object, strap it securely to the frame.
 - (5) Ensure that wheels are secured to the frame and that the frame is straight and in good repair.
 - (6) Do not allow riding on a handtruck or any other horseplay involving a handtruck.
 - (7) Keep your feet away from moving handtruck wheels; position your hands and fingers away from pinch points.
 - (8) When possible, push instead of pull.
 - (9) Slow down at blind corners and intersections.
 - (10) Where provided, use wide-angle convex and/or panoramic dome mirrors at intersections and corners for increased visibility.
 - (11) Store handtrucks clear of aisles, passageways, stairways, general traffic, and exits.

11. **Hoists.** Hoists shall meet the applicable requirements for construction, design, installation, testing, inspection, maintenance, and operation, as prescribed by the manufacturer.

- a. Select the appropriate hoist for the load by referring to the manufacturer's determined workload capacity as indicated on the hoist. Mark the hoist body or hook with the rated load capacity, recommended speed, and special hazard warnings.
- b. Never let the hoist capacities exceed structure or building capacities. Use overhead support and rigging strong enough to carry maximum loads with a safety factor of 2-1/2 to 1 (that is 2-1/2 times stronger than the maximum load they are rated to carry).
- c. Inspect running gear, hooks, straps, and chains for cracks and other signs of fatigue to make sure they will not slip or give way under stress.

- d. Ensure that hook openings do not exceed 15 percent of the original hook gap throat (opening) or more than a 10-degree twist from the plane of the unbent hook.
 - f. Ensure that hoists are securely anchored.
 - g. Guide heavy loads with ropes rather than by hand.
 - h. Side-pull the chain hoist only when the superstructure is braced to withstand lateral stress.
 - i. Engage the ratchet pawl when lifting or suspending loads. Remove the crank when the load is suspended.
 - j. Use only crank handles with a free-floating grip.
 - k. Ensure that all hooks meet the manufacturer's recommendations and are not overloaded.
 - l. Whenever possible, use safety latch type hooks.
12. **Peaveys, Cant Hooks, and Pike Poles.**
- a. Handles must be free of splinters, splits, and cracks.
 - b. Keep points sharp.
 - c. Keep your body balanced when pushing/pulling the pole.
 - d. Grip the handle firmly. Do not overstress the handle.
 - e. Place guards on points when the tool is not in use or is being transported.
13. **Shovels.**
- a. Keep shovels sharp and replace them if they show cracks, ragged edges, or splits. Follow sharpening guides carefully. Never sharpen cutting edges all the way to the foot plate.
 - b. Never use a shovel as a pry bar.
 - c. When shoveling, support your upper body by bracing the forearm closest to your body against your thigh as you pivot the blade sideways.
 - d. Check handles for splits, cracks, and splinters before using. Replace defective handles.
14. **Wheelbarrows.**
- a. Select the appropriate wheelbarrow for the job, with a strong, straight frame and strong wheels that are well secured to the frame.
 - b. Keep your back straight and use your legs when lifting the handles of a loaded wheelbarrow. Never overload a wheelbarrow; keep the load evenly balanced, with weight

well forward to avoid lifting strain. Push, do not pull, wheelbarrows.

- c. Keep handles free of splinters, jagged edges, and burrs. Remove cracked or broken handles from service.
- d. Watch for obstacles that will stop or tip a wheelbarrow. Do not run with a wheelbarrow. Check the route before moving the wheelbarrow.
 - (1) Allow enough clearance to avoid injuring fingers and hands.
 - (2) Exercise caution when ascending or descending ramps that may be wet, frosted, or snow covered.

15. **Wedges.**

- a. Select the correct wedge(s) for the job. The proper type, size, length, and combination are essential for efficiency and safety.
- b. Check wedges daily or before each job, and do not use cracked or flawed wedges.
- c. Wear a hardhat, eye or face protection, and gloves when driving wedges.
- d. Carry wedges in an appropriate belt or other container, not in pockets of clothing.
- e. Always drive wedges by striking them squarely on the head and driving them carefully into the cut to prevent them from flying out of the cut or kerf.
- f. Repair or remove from service any shock-driven or driving tool when the head begins to chip or mushroom.
- g. Recondition heads and the tapered ends of wedges to the manufacturer's original shape and angle. Wear eye protection and a dust mask when grinding to recondition wedges.

42.2 – Rigging Equipment for Material Handling. This section covers the use of fiber, synthetic, and wire ropes for lifting and structural support.

42.21 – Safety Practices. Follow these basic guidelines:

1. **General Guidelines.**

- a. Inspect ropes and related equipment before each shift. Replace cracked hubs, spokes, flanges or sheaves, winches, and blocks. Discard hooks, shackles, rings,

and slings that are bent, spread, or otherwise damaged. Continue to monitor ropes during use for broken strands, cuts, and worn or frayed spots. Immediately remove from service any defective rigging equipment.

- b. Ensure that only a qualified splicer makes splices. Never use knots in lieu of splices. Ensure only qualified persons tie knots for tie-downs and loads. Match the type of knot to the purpose.
- c. Carefully match the rope and the job:
 - (1) Use manila ropes preferably on rigging and other jobs where tight bends and sharp corners occur.
 - (2) Never use synthetic ropes where stretching causes problems.
 - (3) Use wire ropes for running or working ropes under heavy loads; for hoisting where slings and hardware are provided; and for permanent guy wires and structured tension members. (Use chains when hooks, ratchets, and other holding devices are used.)
 - (4) Never exceed the rigging equipment's recommended safe working load. Refer to 29 CFR 1910.184 and 29 CFR 1926.251 for specific rated capacities of rigging equipment.
 - (5) Always remove rigging equipment in the immediate work area when it is not in use so as not to present a hazard to workers.

2. **Natural Rope and Synthetic Fiber.**

- a. Never overload rope.
- b. Uncoil new natural fiber rope from the inside of the spool. Uncoil new synthetic rope by rolling the rope off the spool as it spins on an axle or spindle.
- c. Never drag rope over rough or sharp surfaces.
- d. Keep acids and acid fumes away from ropes.
- e. Thoroughly dry rope after use. Coil and pile or suspend rope so air can circulate through the coils. Never pile frozen or wet rope against heat sources. When wet, natural fiber ropes are never as strong as dry ones, and wet synthetic ropes are slippery and may not hold knots well.

- f. Store synthetic ropes away from sunlight, oil, and any other petroleum products that may cause deterioration.

3. **Wire Rope.** Consult the unit engineer and/or tables for wire rope strength; requirements for proper use of wire rope are in 29 CFR 1910.184 and 29 CFR 1926.251. Serious accidents have resulted from improper handling of wire ropes and installation of wire rope clamps.

- a. Wear cotton gloves while handling wire ropes.
- b. Apply a safety factor of not less than 5, and never let the working load of a wire rope exceed 1/5 of its breaking strength.
- c. Do not let wire rope kink when unwinding it from shipping reels. A common cause of wire rope failure is kinking, which usually occurs when it is unwound from shipping reels.
- d. Never allow wire rope to overwrap unevenly on drums.
- e. Always use the proper size clamps. Inspect clamp nuts daily when rope is in use and tighten them often. Retighten newly installed nuts or slips after 1 hour of use.
- f. When used for eye splices, apply the U-bolt so that the U section is in contact with the dead end of the wire rope (ex. 01).
- g. Remove wire rope from service when the total number of visible broken wires exceeds 10 percent of the total number of wires, or if the rope shows other signs of excessive wear, corrosion, or defect.

42.21 – Exhibit 01 – Proper Installation of Wire Rope Clamp

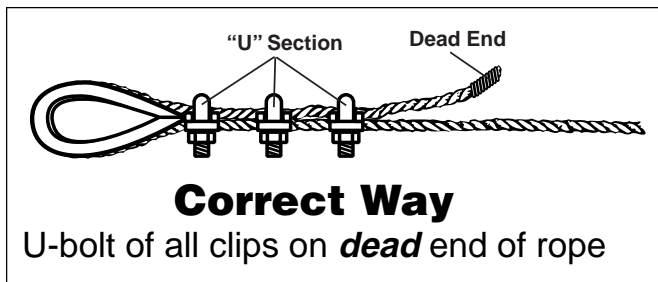

- h. Maintain the safety of wire rope by lubricating it regularly to protect against corrosion and excessive wear. Be sure the lubricant penetrates to inner wires.

42.3 – Chains.

42.31 – Safety Practices.

1. Consult an engineer when selecting chains.
2. Inspect chains for small cracks, corrosion, and pits, and for deformed, stretched, weak, or gouged links. If a chain is defective, repair or replace it. Dispose of unserviceable chain.
3. Do not splice broken chain with clamps or bolts.
4. Do not use shop hooks and links or makeshift fasteners formed from bolts, rods, or other such attachments.
5. Ensure that hooks, rings, oblong links, pear-shaped links, welded or mechanical coupling links, or other attachments, when used with alloy steel chains, have a rated capacity at least equal to that of the chain.
6. Do not subject chains to impact loads or jerking.
7. When hooking chain, ensure that the hook is completely over the link, so the chain cannot slip and the hook will not bend. The hook must be as far from the load as possible, so the pull is on the back of the hook. Ensure that a straight pull is made. The hook opening must be away from the object being pulled or lifted.
8. After hitching or hooking chains to a load, stand far enough away to avoid being hit by a broken chain, the load, or flying parts or pieces.

42.4 – Slings.

42.41 – Safety Practices.

1. Each day before use have a competent person inspect the sling and all fastenings and attachments for damage or defects. Perform additional inspections during sling use, where service conditions warrant. Immediately remove from service any damaged or defective slings.

2. Follow manufacturer's recommendations to determine safe working loads of the various sizes and types of slings, ropes, hooks, chains, and other such rigging equipment.

3. Do not shorten slings with knots, bolts, or other makeshift devices.

4. Do not allow sling legs to be kinked.

5. Do not exceed rated load capacities.

6. Pad or otherwise protect a sling from the sharp edges of a load.

7. Always ensure that suspended loads are clear of all obstructions.

8. Ensure that all workers are clear of loads about to be lifted and of suspended loads.

9. Never place hands or fingers between the sling and its load while the sling is being tightened around the load.

10. Do not permit shock loading.

11. Do not pull a sling out from under a load when the load is resting on the sling.

43 – POWER-OPERATED TOOLS. Generally, power tool accidents are caused by improper handling and poor maintenance. Most mistakes can be avoided with proper training.

43.01 – Authority. The authority for general requirements on machines, abrasive wheel machinery, mechanical power-transmission apparatus, and guarding of portable powered tools is in Title 29, Code of Federal Regulations (29 CFR), sections 1910.212-1920.213, 1910.215, 1910.219, and 1910.242-1910.243.

The authority for general tool and equipment requirements is in 29 CFR 1926.300 - 1926.304, 1926.306, and 1926.702.

43.04 – Responsibility.

43.04a – Supervisor. The supervisor has the responsibility to:

1. Ensure that tools are not modified or allowed to be used in any manner that increases the risk of injury.
2. Ensure that tools are maintained in a safe condition through periodic inspection and repair, including tools furnished by employees.
3. Monitor employee performance periodically to ensure that proper methods and workplace practices are followed.

43.04b – Employees. Employees are responsible for operating power tools in a safe, prescribed manner, including using all protective equipment provided by the tool manufacturer. Employees are responsible for wearing all required and provided PPE.

43.1 – Qualifications. Supervisors shall ensure that employees are trained in the proper use and care of power-operated tools. Do not allow employees to work alone with a tool until they have thoroughly demonstrated their ability to handle it safely. Basic training may include:

1. Appropriate use of tools and PPE.
2. Operating limitations of tools.
3. Inspections.
4. Adjustments and maintenance.
5. Safety features.
6. Care and cleaning.
7. Other items included in the JHA.

43.11 – Personal Protective Equipment. Employees using power-operated tools who are exposed to the hazard of falling, flying, abrasive, moving, rotating, and sharp objects or are exposed to harmful chemical dusts, fumes, mists, vapors, or gases shall be provided with PPE necessary to protect them from the specific hazard(s).

43.12 – Safety Practices. The following apply to all types of power tools:

1. Proper Handling.

- a. Permit only trained and authorized personnel to operate or repair power tools.
- b. Select the correct tool for the specific work project or activity.
- c. Use each tool only for the job it is designed to do.
- d. Use cord connected power-operated handtools in accordance with the manufacturer's operating, safety, and maintenance instructions.
- e. When possible, select ergonomically designed tools that may lower fatigue and lessen the risk of accident or injury.
- f. Safety inspect and maintain power tools on a regular basis.
- g. Replace or repair worn or damaged tools, equipment, and cords immediately. Temporary and make-shift repairs are prohibited.
- h. Tag all tools in need of repair with a "do not use" tag and provide suitable storage bins for tools needing repair or maintenance.
- i. Check power cords frequently for cracks, cuts, abrasions, and broken insulation.
- j. Keep power cords clean and free of kinks. Never carry a portable tool by the cord.
- k. Provide electric tools with a grounding connection or provide double-insulated tools.
- l. Use only 3-wire extension cords. When making a connection, first connect the tool to the extension cord, then the extension cord to the power source.
- m. Always unplug the power cord from the outlet before changing parts, making adjustments, and after the project is finished.
- n. Place power tools in designated storage areas when not in use.

2. Proper Maintenance.

- a. Do not nullify or alter manufacturer's guards and safety equipment on power tools unless the manufacturer identifies specific uses.
- b. Inspect, maintain, and adjust all guards and safety equipment based on the manufacturer's recommendations or otherwise at regular intervals.
- c. Never allow overconfidence to lead you into taking unnecessary risks.
- d. Keep the work area clean, well lit, and dry. Good house-keeping is essential to good workmanship.
- e. Do not wear clothing or jewelry that could become entangled in power tools.

43.2 – Air Receivers. Air receivers are used in many different kinds of activities, including drilling, chipping, painting, hoisting, inflating, and abrasive blast cleaning.

43.21 – Safety Practices. Do not exceed the manufacturer's recommended safe operating pressure.

1. Locate air receivers so safety inspections, maintenance drains, and handholds are easily accessible and so that the pressure indicator gauge is readily visible.
2. Ensure that the drain valve is opened and drained frequently to prevent the accumulation of liquid in the receiver.
3. Test all safety valves (pressure relief) at regular intervals to ensure that they are in good operating condition. Maintain a record of tank draining and safety valve tests at the air receiver.
4. Follow the manufacturer's instructions specifically related to safe operation and maintenance.
5. Observe fire and explosion precautions related to air receiver operation.

43.3 – Pneumatic Power Tools. Generally, follow the same precautions for the use and care of pneumatic tools as for electric and gasoline engine-driven equipment.

43.31 – Safety Practices.

1. **General Guidelines.** Observe fire and explosion precautions related to pneumatic tool operation. Do not exceed the manufacturer's safe operating pressure for hoses, pipes, valves, filters, and other fittings.

- a. Ensure that hose and hose connections are designed for the pressure and service needed. Use the air hose only for the purposes for which it was designed.
- b. Inspect air supply lines, hoses, and connections regularly and maintain them in optimum condition.
- c. Protect air supply lines, hoses, and connections from vehicle, handtruck traffic, and other physical damage.
- d. All hoses that exceed 1/2 inch (12-3/4 mm) inside diameter must have a safety device at the source of the supply or the branch line to reduce pressure in case of hose failure.
- e. Do not use hoses for hoisting or lowering tools.
- f. Secure hose connection to pneumatic power tools by a positive means to prevent accidental disconnection.
- g. Ensure that safety clips or retainers are securely installed and maintained on pneumatic impact (percussion) tools to prevent attachments from being accidentally expelled.
- h. If an airhose becomes entangled, snagged, or crimped, do not jerk or pull excessively to free it.
- i. Do not use compressed air for cleaning purposes except where the pressure is reduced to less than 30 psi (214 kPa) and then only with a chip guard and appropriate PPE.
- j. Ensure that others are not in the line of airflow, and never aim an airhose at anyone.
- k. Do not use compressed air for cleaning off clothing or parts of the body.

2. **Airhammers.** Airhammer operators shall:

- a. Be qualified to use air tools or be trained and have demonstrated the ability to use the equipment.
- b. Be especially careful when laying an airhammer down so that the trigger cannot be pulled accidentally.

- c. Loosen a tool that is stuck by rocking it back and forth, instead of trying to pull it out.
- d. Never leave an airhammer standing when not in use.
- e. Let the airhammer do the work; there is no need to push down on the tool.

43.4 – Powder/Explosive-Actuated Tools. A variety of tools using powder/explosive charges to propel a stud, pin, or fasteners for the purpose of affixing an object to another surface are available and widely used.

43.41 – Safety Practices. All powder/explosive actuated tools must be treated with professionalism and respect.

1. Train employees to operate the particular powder/explosive actuated tool to be used.
2. Inspect the tool each day before use. Follow the manufacturer's recommended procedures for testing the tool.
3. Remove any defective tool. Tag the defective tool "do not use" and replace or properly repair it following the manufacturer's specifications.
4. Safeguard operators, assistants, and other workers with appropriate PPE. PPE may include: eye, face, head, and extremities protection, and protective clothing, shields, barriers, and other means as identified in the JHA or by the manufacturer.
5. Ensure that all tools are used with the correct shield, guard, or attachment recommended by the manufacturer.
6. Do not load tools until just before the intended firing time.
7. Do not load a tool unless it is being prepared for immediate use. Never point an empty or loaded tool at any person.
8. Never leave a loaded tool unattended.
9. Do not use tools in an explosive or flammable atmosphere.
10. Use only fasteners specifically manufactured for the tool. Do not drive fasteners into very hard or brittle materials, such as cast iron, surface-hardened steel, line rock, face brick, and glazed or hollow tile.

11. Avoid driving into materials that are easily penetrated unless the material is backed by a substance that prevents the fastener or pin from passing completely through.

12. Provide suitable and secure storage for munitions and cartridges.

43.5 – Woodworking Equipment. Power-driven woodworking equipment includes portable saws, circular saws, radial arm saws, bandsaws, jointers, sanders, and others. Refer to section 22.48 for direction on chain saw operations. This equipment may provide for more efficient, productive work; however, it requires individual operator training, skill, and caution.

43.51 – Safety Practices. When operating such equipment the following applies:

1. Permit only trained and authorized personnel to operate power-driven woodworking equipment.
2. Ensure that the work area is kept free of debris that creates tripping or fire hazards.
3. Inspect all power-driven woodworking machines and associated equipment at regular intervals to ensure that they are in safe operating condition.
4. Remove from service any woodworking machine, tool, or machine equipment not in proper working order. Tag it “do not use”; replace or repair it.
5. Prohibit temporary or makeshift repairs.
6. Remove immediately from service dull, cracked, badly set, tensioned, or improperly filed saws.
7. Ensure that guards are in place on belts, pulleys, gears, shafts, and moving parts.
8. Secure and anchor woodworking machines designed for a fixed location to prevent moving or walking.
9. Ground all power-driven woodworking machines.

10. Equip each machine with a mechanical or electrical power control so that the operator can cut off the power without leaving the work position.
11. Provide all fixed power-driven woodworking tools with a disconnect switch that can be locked or tagged in the off position.
12. Provide automatic shut-offs to prevent the machine from restarting when power is restored after failures.
13. Lock out the power source when leaving at night.
14. Immediately clean saws that have gum adhering to the sides.
15. Keep all knives and cutting heads sharp, properly adjusted, and firmly secured.
16. Adjust bearings to eliminate play and keep them well lubricated.
17. Have only a trained person sharpen and tension saw blades or cutting heads.
18. Ensure arbors of all circular saws are kept free from play.
19. Maintain good housekeeping and cleanliness around woodworking machinery. It is particularly important to clean switch enclosures, bearings, and motors to reduce fire and explosion hazards.
20. Provide push sticks or push blocks at the worksite in several sizes and types suitable for the work to be done.
21. Make adjustments and accessory changes only when machinery is turned off and unplugged.
22. When operating machinery, do not wear loose fitting clothing or jewelry that could become caught in the machinery.
23. Take breaks when you are tired. When using equipment, do not take your eyes off your work or talk to anyone.

43.51a – Portable Saws, Jointers, and Sanders.

1. General Safety Practices.

- a. Ensure that saws are equipped with a fixed guard over the upper half of the blade and a movable guard covering the lower half of the blade. Leave both of these guards in place. Blocking the lower guard is prohibited.
- b. Secure small pieces being cut with bench clamps or by some other means.
- c. Check saw blades regularly and keep them in good condition. Use the blade recommended for the material being cut and never use a dull blade or cutting edge.
- d. Never jam or crowd a saw into the work. Cut green or wet material slowly and with extra caution.
- e. Require approved respiratory and eye protection for operators cutting concrete, tile, or stone.

2. Circular Table Saws.

- a. Ensure that guards include:
 - (1) Hood covering the saw at least to the depth of the teeth and giving a clear view of the line of cut.
 - (2) Spreader and anti-kickback device that are part of the guard.
 - (3) Safe undertable protection.
- b. Use a saw only for the work it is designed to do.
- c. Use the correct type of cutting blade for the material to be cut.
- d. Each day check to ensure that saw teeth are set and sharp, and that the arbor nut is tight.
- e. Never use the ripping fence as a guide for crosscutting material.
- f. Kickback is one of the greatest hazards in running a table saw. To avoid it:
 - (1) Use the splitter guard.
 - (2) Never use a dull blade.
 - (3) Do not cut freehand or attempt to rip badly warped wood.
 - (4) Do not drop wood on an unguarded saw.
 - (5) Always stand slightly to one side, not in line with the saw.
 - (6) Do not reach over the saw to push stock that has been sawed (ex. 01).

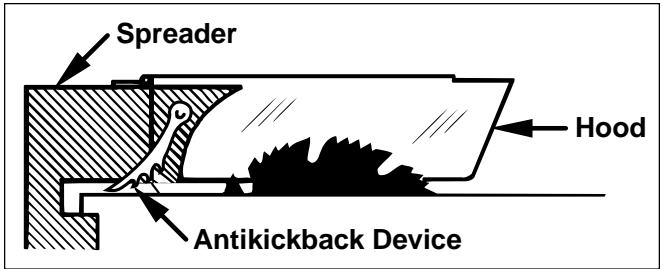
43.51a – Exhibit 01 – Spreader and Antikickback Device

- g. Ensure that circular table saws have magnetic switches.
3. **Radial Arm Saws.**
- a. Keep the machine in proper alignment and adjustment to prevent excessive vibration.
 - b. Use the appropriate load and speed for the saw. If the motor slows while cutting, it may mean that it is overloaded or that the material is being fed too fast.
 - c. Provide and use upper and lower blade guards.
 - d. Ensure that anti-kickback fingers or dogs contact material when ripping, and that the guard just clears the work.
 - e. Make sure that saw rotation is conspicuously marked on the hood. In addition, affix a sign to the rear of the guard that reads: "Danger - Do Not Rip or Plough From This End." It is imperative that work be fed into radial arm saws from the proper direction.
 - f. Ensure that radial arm saws:
 - (1) Are equipped with an adjustable stop to prevent the saw blade from traveling beyond the front of the table.
 - (2) Are installed so the front end of the unit is slightly higher than the rear. This allows the cutting head to return to the starting position when released by the operator.
 - (3) Have the direction of rip posted on the saw.
 - (4) Are equipped with a floating lower blade guard.
 - (5) Are equipped with magnetic switches.

4. **Bandsaws.**

- a. Ensure that bandsaws have:
 - (1) Wheels that are fully encased or guarded.
 - (2) Effective brakes to stop the wheels in case of blade breakage.
 - (3) A self-adjusting guard for that portion of the blade between the sliding guide and the upper saw wheel guard.
 - (4) A tension control device.
 - (5) Guard-powered feed rolls.
 - (6) Magnetic switches.
- b. With power disconnected, turn the upper wheel manually before starting to ensure that the saw band travels smoothly on both upper and lower wheels and through the band guide.
- c. Use a saw band as wide as the work permits.

5. **Jointers.**

- a. Ensure that each hand-fed jointer has an automatic guard that covers all of the cutting head on the working side of the fence or gauge, and a guard on the exposed portion of cutting head in back of the gauge or fence.
- b. Ensure that jointers with a vertical head either have an exhaust hood or have guards so arranged as to completely enclose the revolving head.
- c. Ensure that jointers have magnetic switches.
- d. Use push sticks or blocks to push stock over cutting heads.

6. **Sanders.**

- a. Provide belt sanders with guards at each nip point where the sanding belt runs onto a pulley.
- b. Use particulate (dust) masks or respirators for intermittent or occasional dust.
- c. Where sander use is frequent, ensure that dust is exhausted and collected; otherwise, dust may create an explosion hazard. These measures are in addition to dust collection systems installed directly on sanders. Avoid open flame and sparks.

- d. Arrange the power cord so that it cannot be damaged by the abrasive belt.
- e. Keep both hands on the sander for good control.
- f. Clean dust and chips from the motor and vent holes regularly.
- g. Follow the manufacturer's recommended maintenance and service schedule.

43.6 – Drills. Drills are available in a variety of sizes, configurations, and power ratings, and they may be corded or cordless. These drills also offer features such as variable-speed, high torque, and reversible, and there are special drills for hammering and drilling.

43.61 – Safety Practices. Follow these basic guidelines:

1. Select the right size and type of drill for the work project.
2. Select the correct bit for the material to be drilled.
3. Where necessary, provide a prick punch or pilot hole for the drill point. Some bits, such as zirconium, may not require center punching.
4. Before drilling, ensure that the material to be drilled is secured to prevent movement or rotation.
5. If the bit may penetrate through the material to be drilled, protect it against damage or injury.
6. Do not straddle a drill or position your body to apply pressure that may exceed the drill's capability or capacity.
7. Always securely anchor drill presses to prevent them from moving or walking.
8. Locate the power control so that it allows the operator to cut off the power without leaving the work position.
9. Equip drill presses with guards to protect the operator from contacting hazards created by rotating parts and nip points.
10. Use the appropriate drill speed for the material being drilled.

43.7 – Grinders. Bench grinders are used for sharpening, shaping, and smoothing metal, wood, plastic, or stone. For additional safety requirements, refer to 29 CFR 1910.212, 1910.215, 1910.303, and 1926.300.

43.71 – Personal Protective Equipment.

1. First aid kit (refer to the Glossary).
2. Eye/face protection.
3. Hearing protection (85 dB and above).

43.72 – Safety Practices. Basic safety practices for grinder use include:

1. Inspect all abrasive wheels closely before mounting to ensure that they are free from cracks or defects. Follow up with regular inspections.
2. Always match the abrasive wheel rotation per minute (rpm) rating with the rpm rating of the grinding machine.
3. When using hand-held grinding machines, always use work rests to support the work.
4. Always keep work rests on the floor and bench-mounted grinders adjusted closely to the wheel with a maximum opening of 1/8 inch (3-1/4 mm). This prevents the work from being jammed between the wheel and the rest, and possibly causing breakage (ex. 01).
5. Always securely clamp the rest after each adjustment.
6. Adjust the tongue guard (when equipped) so that it is 1/4 inch (6-1/2 mm) from wheel.
7. Never make adjustments with the wheel in motion.
8. Keep all machine guards in place and functional. Wear eye and/or face protection.
9. Securely attach bench and floor model grinders and buffers to the floor or work bench before use.
10. Keep abrasive wheels free from oil and properly dressed.

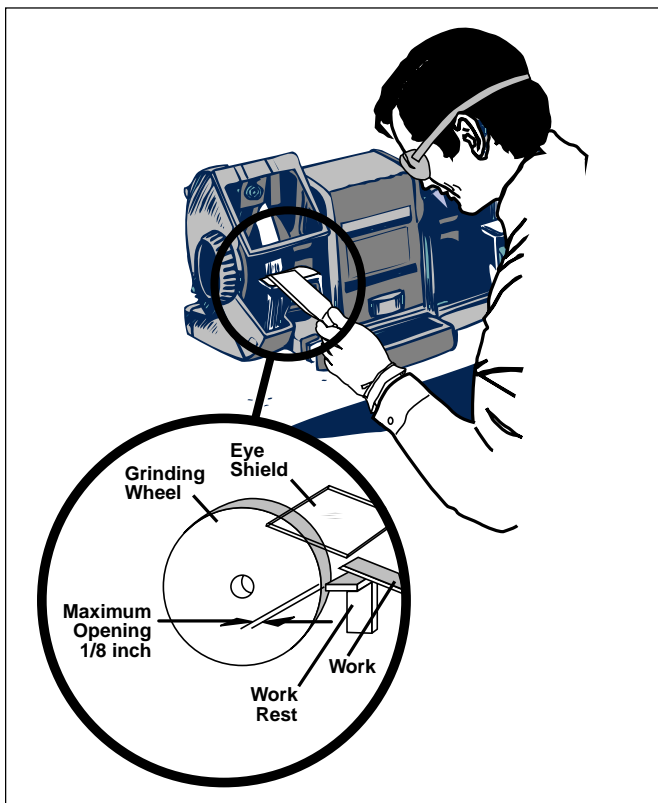
43.72 – Exhibit 01 – Work Rest Adjustment

11. Do not leave a running machine unattended.
12. Always stand to one side of the machine while starting the motor until the operating speed is reached to prevent injury if a defective wheel should break and fly apart.
13. Use light pressure when starting to grind. Too much pressure may cause a cold wheel to fail.

14. Always conduct a visual inspection to detect defects before installing parts on a grinder.

44 – HEAVY EQUIPMENT.

44.01 – Authority. The authority for working surfaces, storage and handling of liquefied petroleum gases, specifications for accident prevention signs and tags, powered industrial trucks, cranes, falling object protective structures (FOPS), safe work practices, and hazard communication is in Title 29, Code of Federal Regulations (29 CFR), sections 1910.30, 1910.110, 1910.145, 1910.178 - 1910.180, 1910.266, 1910.333, and 1910.1200.

The authority for fire protection and prevention, flammable/combustible liquids, rigging equipment for machine handling, cranes, heavy equipment and motor vehicle requirements, material handling equipment, underground lines, rollover protective structures (ROPS), and overhead protection for tractor operators is in 29 CFR 1926.24, 1926.150 - 1926.152, 1926.251, 1926.550, 1926.600 - 1926.602, 1926.956, 1926.1000, and 1926.1003.

44.04 – Responsibility.

1. Supervisors jointly with employees have the responsibility to complete and review a JHA before operating heavy equipment on work projects or activities. The JHA shall specifically address safe work practices of employees who work in proximity to heavy equipment.

2. Before starting or moving any machine, the operator has the responsibility to determine that no other person is in the path of the machine.

3. Supervisors and operators of heavy equipment have the responsibility to ensure that machines are not operated on any slope greater than the maximum slope recommended by the manufacturer, JHA, or Driver-Operator Guide (sec. 44.06).

44.04a – Supervisor. The supervisor has the responsibility to provide supervision until the employee has demonstrated the ability to operate heavy equipment alone.

44.04b – Employees.

1. Equipment operators have the responsibility to demonstrate their ability to handle the equipment and be licensed to operate it.
2. Transport operators have the responsibility to be familiar with the laws and local ordinances of States in which they drive.
3. Equipment operators have the responsibility to implement the instructions provided in the JHA and to use the PPE identified for the specific work project or activity.
4. Equipment operators have the responsibility to be thoroughly familiar with the capabilities and limitations of the equipment and to operate within those limits. Operators must also consider their individual experience and skill level and operate within their personal limits.
5. Operators have the responsibility to ensure that all safety equipment provided by the manufacturer and the Government is in place, functional, and, where required, current, such as first aid supplies, fire extinguisher(s), and fire shelter.
6. Operators have the responsibility to perform preventive maintenance checks before, during, and after operating the equipment.

44.06 – Reference. U.S. Department of Agriculture, Forest Service. Driver-Operator Guide. EM-7130-2. Engineering Staff, 201 14th Street S.W., Washington, DC.

44.1 – Qualifications. Employees shall be trained in safe work procedures and hazard recognition. Only qualified operators shall be permitted to operate heavy equipment. Where required, heavy equipment operators shall have a valid State driver's license with the applicable endorsements for the types of vehicles they are authorized to operate.

Operators must also have a U.S. Government Motor Vehicle Operator's ID Card (Form OF-346) or equivalent upon which the specific equipment, such as grader, end loader, backhoe, or forklift, shall be noted.

44.11 – Personal Protective Equipment.

1. **General.**
 - a. First aid kit (refer to the Glossary).
 - b. Hardhat.
 - c. Eye protection.
 - d. Hearing protection (85 dB and above).
 - e. Appropriate footwear.
 - f. Appropriate respiratory protection identified by JHA and/or MSDS.
 - g. Appropriate PPE as identified by JHA and/or Material Safety Data Sheet (MSDS).
2. **Operator's Helper/Signal Person.**
 - a. High-visibility vest (night operation-reflectORIZED vest).
 - b. Signal lights for low-visibility and night operation.
 - c. Radio communication with operator for low-visibility and night operation.
3. **Repair and Maintenance Personnel.** Safety-toed boots.

44.12 – Safety Practices. *Because of the specialized work that heavy equipment is designed to perform, if accidents/injuries do occur, they are usually serious and often fatal.* Practice

defensive operation at all times. This means understanding:

- a. The machine capacity and its stability limitations.
 - b. Operating techniques and procedures.
 - c. Special rules of use.
 - e. Manufacturer's recommended operator safety and maintenance practices, and how to implement them.
 - f. The work assignment, including exercising professional skill and applying sound judgment.
1. **General.**
 - a. Follow the manufacturer's recommendations for machine operation, safety, and maintenance. If operating manuals are not available, contact a dealer or the manufacturer.
 - b. Permit only trained and authorized personnel to make adjustments or repairs on heavy equipment.
 - c. Allow adjustments or repairs to heavy equipment while the engine is running only where the manufacturer or JHA identify it is safe or permissible to do so.

- d. Shut down defective machinery until repairs are made. Inspect and test the machinery before returning it to service.
- e. Allow trainees to operate heavy equipment only under the supervision of a certified operator.
- f. Do not permit passengers to ride on heavy equipment or machines unless the equipment/machine is specifically designed for that purpose. (Exception: Mechanic and operator trainee.)
- g. Provide an audible alarm on all bidirectional machines, such as road graders, front-end loaders, dozers, powered industrial trucks (forklifts), and similar equipment.
- h. Install rollover protective structures (ROPS) on rubber-tired self-propelled scrapers, front-end loaders, dozers, crawler tractors/loaders, and graders.
- i. Ensure that all heavy self-propelled equipment provided with rollover protective structures has an operator seatbelt. (Exception: seatbelts need not be provided for equipment designed only for stand-up operations.)
- j. Make sure windshields and windows of enclosed cabs are made of safety glass. Keep the safety glass clean for maximum operator visibility. Replace glass when cracked, broken, scratched, or when other defects create a hazard for the operator.
- k. Walk around the equipment before starting to ensure that personnel are clear. ***Never be directly in front of, between the wheels, along side of, on the tracks, or behind a self-propelled machine being started or operated.*** Do not operate equipment until ample clearance has been provided for personnel between any solid material and the tail swing of a dragline, shovel, crane, or the swing of a backhoe or similar equipment. Provide barriers preventing access to the pinch point.
- l. When motor graders, rubber-tired end loaders, wheel-type agricultural and industrial tractors, and other such equipment must travel public roadways, display a slow-moving vehicle emblem on the vehicle. In addition, display the appropriate flashing caution lights.
- m. Investigate worksites for unsafe conditions before moving machines and people into operating and work

positions. Do not locate or operate equipment where operators will be endangered by hazards such as blasts and cave-ins. Do not move machines or workers into a blasting area until the blaster-in-charge states it is safe to do so. When the work project or activity requires digging, assess the area for underground utilities and be especially aware of overhead hazards before starting work.

- n. When changing operators, discuss the plan of work with the new operator and crew. Also, discuss any fixed hazards or hazards encountered or identified during the shift.
- o. Ensure that machines with parts or accessories lowered by gravity or hydraulic levers (such as shovels, dump bodies, buckets, dozer blades, and rippers) are lowered onto the frame or ground, and that the controls are in neutral with the brakes set, when the machine is shut down or unattended (ex. 01).
- p. Provide and properly secure fire extinguishers, and ensure that they are readily accessible and maintained in a fully charged, operable condition on heavy equipment, such as motor graders, end loaders, tractors, and similar equipment. Train operators in the general principles of fire extinguisher use.
- q. Ensure that equipment left unattended at night adjacent to a roadway has appropriate warning lights, reflectors, or barricades equipped with lights or reflectors.
- r. If in doubt about the safety of an operation, stop and reassess. Avoid operations where safety could be compromised.

44.12 – Exhibit 01 – Parking Heavy Equipment

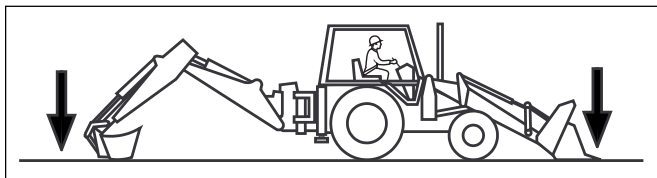

- s. ***Be aware of changing conditions and avoid hazardous situations created by terrain and environmental conditions that may endanger employees in the performance of their job, such as electrical storms, high winds, fire, mudslides, and avalanches.***
 - t. Shut off engines during fueling operations. When fueling a tank, keep the funnel or container in contact with the tank to avoid the possibility of a static spark igniting the fuel.
 - u. ***Provide adequate ventilation if there is a chance of carbon monoxide entering enclosed cab areas. Take out of service any equipment with faulty exhaust systems until the equipment is repaired or replaced.***
 - v. Operate heavy equipment at night only during fires or in emergencies. Provide lights, both front and rear, on the equipment. Equip any helper or assistant with a headlamp, and/or hand-held signal light(s), a reflective strobe-light vest, and other required PPE. Provide the operator and helper with radio communication.
2. **Transportation.** Before moving heavy equipment:
- a. Check the route of travel for overhead and side clearance; culverts and bridges for width and load weight limits; and overhead high-tension lines and similar hazards. Provide a pilot car when required.
 - b. ***Block heavy equipment sidewise and lengthwise on truck beds. Securely bind the load to the truck or trailer bed, both front and rear, or on each side, with chain or cable tightened with load binders.*** The total static breaking strength of the load binders securing the equipment against movement in any direction must be as strong as or stronger than the tiedown straps, cables, and chains. All tiedown materials must be consistent with the equipment weight that they are securing.
 - c. Angle or remove a tractor blade or obtain a special permit to comply with State laws pertaining to the width of clearance.
 - d. Remove loose tires, planks, or other heavy material from the path of equipment being loaded. Ensure that unnecessary personnel are away from the tractor transport when heavy equipment is loaded or unloaded.

3. **Guards and Safety Devices.** Properly guard exposed gears, shafts, sprockets, drive belts, chains, pulleys, drums, fans, or other hazardous moving parts. Include safety labeling on guards as necessary.

- a. Remove guards only when making repairs. Shut off and lock out power to the machine until repairs are made and guards are replaced.
- b. Ensure that all personnel who mount and dismount heavy equipment are aware of safe work procedures for the specific machine. To avoid slipping, tripping, or falling, utilize the “three-point facing-the-machine” method (two hands-one foot) for mount and dismount. Be aware of snagging clothing or jewelry on control levers or other obstacles.
- c. Install nonskid material on all operating platforms, such as footwalks and steps. Install handholds to assist the operator in mounting and dismounting.
- d. Use safety glass, plastic, or expanded steel-mesh shields in cabs or enclosures on machines. Also provide suitable protection against falling/flying objects, swinging loads, and similar hazards.

4. **Signaling.** When the work project or activity dictates, provide each operator with a signal person.

- a. Ensure that the operator and signal person establish a form of communication (hand signals/radio) prior to beginning the work project or activity.
- b. Ensure that, when using hand signals, both the signal person and operator clearly understand and observe the established signals.
- c. When signaling an operator, always be in position to be clearly seen.
- d. Coordinate signals with each new signal person before work begins.
- e. Require the signal person to wear a high-visibility vest. Make sure that warning garments worn at night are reflectorized.
- f. Provide the signal person with a signal flag for daylight operations and signal light(s) for low-visibility and night operations.

- g. Provide the signal person and operator with radio communications for low-visibility and night operations (ex. 02).

44.2 – Crawler-Tractors.

44.21 – Safety Practices.

1. General.

- Ensure operators and all employees involved with the work project are thoroughly briefed on safe work practices before starting operation.
- Perform a preventive maintenance and walk-around safety inspection of machines and attachments before each day's work or shift change.

44.12 – Exhibit 02 – Signaling

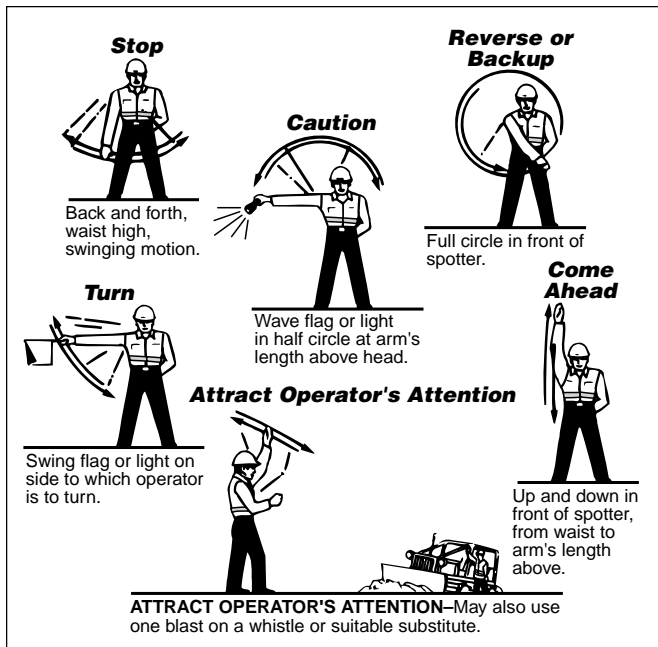

- c. Test brake systems daily to ensure that they are fully functional and properly adjusted.
- d. Keep battery fluids at the manufacturer's specified levels. Do not expose batteries to excessive heat or cold or store them in direct sunlight.
- e. Do not operate tractors if any part of the control, hoist, or hydraulic system, including steering, brakes, and safety equipment, is not functional.
- f. If a tractor is determined unsafe, take it out of service until repairs are completed.
- g. Make proper blade or other machine accessory adjustments before starting operation. Check the condition of cutting edges regularly.
- h. If the noise level of the machine is 85 dB or above, provide the operator (and trainee when on the machine) with hearing protection in addition to other required PPE.
- i. Wear seatbelts on equipment that has rollover protection.
- j. Do not operate a crawler-tractor on any cross- or down-slope that is greater than the maximum slope recommended by the manufacturer, JHA, Driver-Operator Guide, or this Handbook.
- k. ***To operate on a maximum slope, maintain full control of the machine, recognizing the following conditions that may upset tractor stability:***
 - (1) Speed of travel.
 - (2) Roughness of terrain.
 - (3) Attachments.
 - (4) Characteristics and nature of the ground.
- l. ***If danger exists from trees or snags because of the specific task, position helps at least 2-1/2 times the distance of the height of the tallest tree(s) from the tractor.***
- m. Maintain a distance of greater than 2-1/2 tree lengths between adjacent occupied work areas on any slope where rolling or sliding of trees or snags is reasonably foreseeable.
- n. Consider any overhead wire energized unless the power company verifies otherwise.

- o. Block or crib any parts held by a hoist or jacks, to prevent falling or shifting, before employees are permitted to work under or between them.
 - p. ***Never get under an unblocked, raised blade for any purpose.***
 - q. When the machine is shut down or unattended, always set the brakes and lower dozer blades, buckets, rippers, or similar accessories to the ground.
 - r. Have a journeyman-level mechanic inspect all equipment annually.
 - s. When operating a tractor:
 - (1) ***Look over the ground to be traveled. If it cannot be clearly seen from the driver's seat, dismount and examine it before proceeding, unless you have a qualified spotter.***
 - (2) Use caution around overhanging rocks, on rock slides, and near dead trees and materials that may be dislodged from the slope above.
 - (3) ***Use extreme caution in going over obstacles when headed downhill.***
 - (4) Reduce speed before making a turn or applying brakes. If the speed of a tractor is doubled, the danger of overturning is increased four times.
 - (5) Make turns on the uphill side if possible.
 - (6) On steep sideslopes, avoid running over hazards, such as rocks, stumps, and logs, with a single track or wheel. Beware of wet or frozen downed logs and debris.
 - (7) When operating a towing winch, keep your hands free from the cable and moving/working parts.
 - (8) Guard against slough and settling at the edge of new fills.
2. **Hitching and Towing.**
- a. Never put your hands into drawbar jaws when hitching or coupling. Use a bar to steer the coupler into position before dropping the pin into place.
 - b. When coupling a tractor to other units, make sure workers stand clear of the area between units until all movement has stopped.

- c. Look behind you before backing up to slack the chain or cable. Take up slack gently, never with a jerk.
- d. Make sure everyone stands clear of all chains and lines and remains at least the length of the towline from the tractor.
- e. Do not ride on the drawbar, dozer blade, frame, or materials being pulled by a tractor.
- f. When towing near a powerline, ensure that the cable is at least 10 feet (3 m) shorter than the distance from the tractor to the powerline.
- g. ***Operate the tractor so that it does not nose-up or tip when pulling a heavy load or slide sideways when pulling side-hill.***
- h. Before releasing the load, release the tension on the cables or chains, stop the tractor, take the transmission out of gear, and set the brake.
- i. After each work shift or after each hard haul, ensure that the tractor operator and towline setter inspect the equipment, including the wire rope and eye splices on the winch, chokers, and ferrules.

3. **Skidding:**

- a. Equip crawler-tractors used in timbered country or in places where there is a danger of falling objects with protective canopies, approved roll-over protective structures (ROPS), falling-object protective structures (FOPS), and mesh screens.
- b. Always assess the work area for hazards, such as danger trees and snags, green trees, hung trees, broken tops, widow makers, stumps, and uprooted trees. Also, consider the tree species.
- c. Have the operator and towline/choker setters specifically address safe work practices and work in proximity to the heavy equipment.
- d. Have the machine operator and towline/choker setters establish a communication system that identifies when the setter is clear of the immediate hazards and the load is to be moved.
- e. In addition to the required PPE, ensure that towline/choker setters wear high-visibility vests and appropriate

- hand protection (such as cotton or leather-faced gloves) for handling wire rope.
- f. Require operators and towline/choker setters to inspect equipment, including main tow winch, main line, wire ropes, chokers, splices, and ferrules, each morning and during the day as necessary.
 - g. Use hand signals or audible signals, such as whistles, horns, and radios, whenever noise, distance, restricted visibility, or other factors prevent clear understanding of normal voice communications between employees.
 - h. Space employees and organize their duties so the action of one employee does not create a hazard for others.

44.22 – Scrapers.

44.22a – Safety Practices. Follow these general safety guidelines:

1. Before each work shift, safety inspect all equipment.
2. In addition to wearing the required PPE, wear cotton or leather-faced gloves to handle wire rope. Use waterproof, nonslip gloves in wet conditions.
3. Keep hands away from wire rope, sheaves, and linkage while the unit is operating.
4. To prevent a scraper from slipping off the edge of a fill, keep the center of the fill low and the outside edges high.
5. Leave the machine in gear and use the brakes to control speed. Provide a service braking system capable of stopping and holding the equipment when fully loaded.
6. When traveling down a steep hill, be ready to drop the cutting edge to the ground to serve as a brake if the scraper should jackknife or otherwise become out of control.
7. Avoid sharp downhill turns and never turn while the scraper is top heavy with the apron in the air.
8. When changing the cutting edges or working underneath a scraper, block up the bowl to prevent falling or shifting.
9. Before working under the apron, place blocks between the apron arms and scraper side, and wedge them securely.

44.23 – End Loaders/Backhoes. *End loaders/backhoes tip over easily because of their high center of gravity. Operators must be completely familiar with weight distribution and the effects that it has on the center of gravity and machine stability.*

44.23a – Safety Practices. Always perform a preventative maintenance and walk-around safety inspection of the machine and attachments before each day's work or shift change. Follow these general safety guidelines:

1. Operate machine controls only from the operator's seat.
2. ***Equip all loaders with bucket-supported arms pivoted behind the operator with a suitable cage canopy. The cage canopy must make it impossible for the operator to be exposed to injury when the bucket is lowered*** (ex. 01).
3. Fasten seatbelts before starting the engine.
4. Make sure everyone is clear before starting the machine. Keep persons away from the backhoe's swing arc by warning and barricading the area.

44.23a – Exhibit 01 – Safety Cage and Canopy

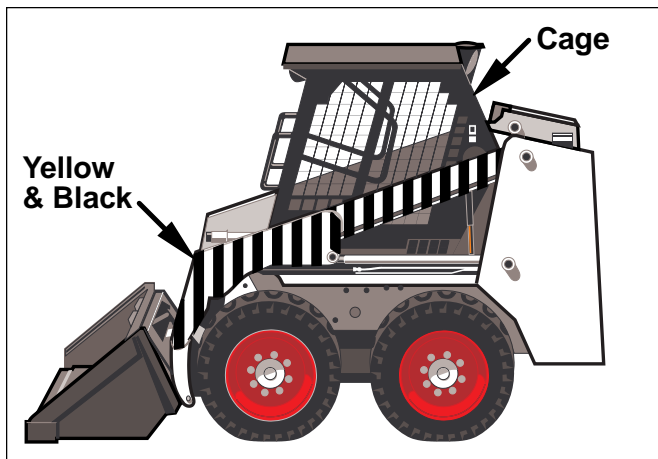

5. Permit no one on the excavator/end loader/backhoe except the operator, operator-trainee, or mechanic.
6. Always have wheels or tracks on firm ground. Do not extend a load over the fill slope(s) or bank(s) beyond the counter-balance and/or center of gravity limits. Remind operators that they should work only at right angles to banks or fills.
7. Pick up loads under the center of their weight and take extra care when working an excavator/end loader downhill.
8. Do not move a machine until it is completely loaded. Start and stop slowly when raising and lowering the bucket and when traveling.
9. When transporting material in the bucket over rough ground or on a hillside, keep the bucket close to ground level. Do not swing a loaded bucket over the cab of a truck.
10. Do not allow anyone to ride in the bucket of any equipment.
11. When an end loader is being repaired or not in use, fully lower or block the end loader buckets and attachments, such as a backhoe.
12. Before dismounting an excavator/end loader/backhoe, ensure that the operator turns off the engine, sets the brakes, pulls the transmission safety latch, and grounds the buckets. Shut off the engine before cleaning, adjusting, or lubricating.
13. Before lubricating, cleaning, adjusting, repairing, or tightening hoses, stop the engine, lower the boom, and release the pressure.
14. Put the machine in low gear, block the machine wheels securely, and lower the bucket to the ground when the equipment is parked on a grade.
15. When parked on inclines, chock the wheels and set the parking brake.
16. Periodically check support pins and other bearing and wear points for fatigue and position.
17. Guard scissor points on all front-end loaders that constitute a hazard to the operator during normal operation.

18. When roading a rubber-tired end loader/backhoe, regulate the speed to avoid bouncing and loss of control.

19. When transporting excavators/end loaders/backhoes, measure the load height to ensure that clearance at underpasses and height limits are not exceeded. Use transportation locks when transporting such equipment.

20. Check the clearance carefully before driving into buildings or working under powerlines or bridges. It is not necessary to actually contact a powerline for electricity to ground through the machine.

21. Make every effort to determine the location of underground facilities before the excavating or trenching operations.

22. When underground facilities are exposed, such as electric, gas, water, and telephone, protect them from damage.

23. Know the local terrain. Be extremely cautious when operating close to ditches, fences, and powerlines, or on banks and hillsides. When working on a hillside, never swing a loaded backhoe bucket to the downhill side.

24. Never leave the machine unattended with the engine running. Lower the bucket(s) to the ground before leaving the machine.

25. Note that hydrostatic braking occurs only when the engine is running. Engage the parking brake before shutting off the engine or leaving the machine. Make sure the parking brake is functional and properly adjusted.

26. Use extreme caution when disconnecting hydraulic lines.

44.24 – Motor Graders.

44.24a – Safety Practices. Follow these general safety guidelines:

1. Investigate the worksite for unsafe conditions before moving machines and people into operating and work positions.

2. Ensure that operators and all employees involved with the work projects or activity are thoroughly briefed on safe work practices before starting the operation.

3. Post "Road Work Ahead" signs and flags on sections of the road being worked to alert and advise forest users (ex. 01).
4. Correct and clean up oil leaks on cab floors, controls, steps, and handles before operating equipment.
5. Always block under the blade before checking blade bolts.
6. ***Ensure that operators keep alert to the danger of fatigue caused by monotony, complacency, and repetition of some types of grader work.***
7. ***In general, allow only the operator on a moving machine. Exceptions include:***
 - a. ***A certified operator or examiner instructing a trainee,***

44.24a – Exhibit 01 – Equipment Working Signs

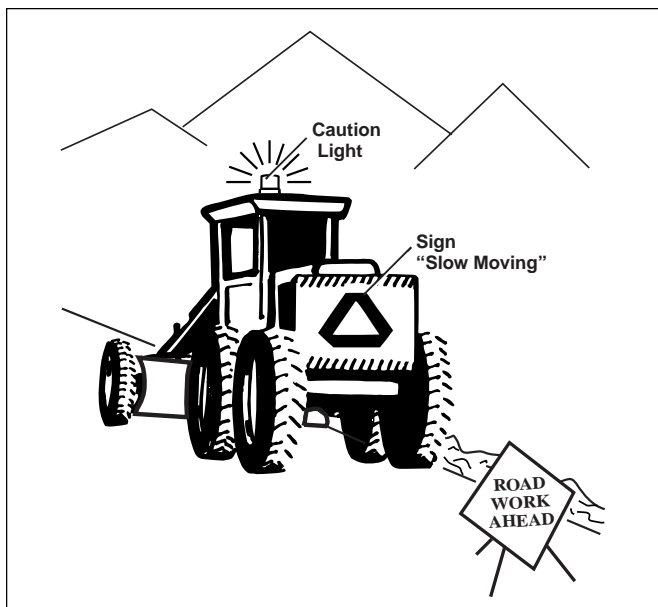

- b. ***A supervisor directing work, and***
- c. ***A certified mechanic for repair purposes.***

These exceptions are allowed only if the machine has adequate handholds.

8. Keep the cab ventilated to avoid exhaust fumes. Set the exhaust tail pipe at an angle of 45 degrees to the rear and to the right or left of the line of travel.

9. Immediately repair or replace defective exhaust systems.

10. Before refueling, inspecting the machine, or performing maintenance, set the brakes; lower the blade, scarifiers, or rippers to the ground or onto a block; and stop the engine.

11. Stop the engine and ground the fuel container or pump nozzle when filling a fuel tank.

12. Before backing, ensure the way is clear and that the entire crew is in full view. Do not allow anyone close to the machine while it is in motion. Point the front wheels toward the fill slope and back toward the cut slope when turning around.

13. Do not reach through the steering wheel to adjust levers or controls.

14. ***Adjust the speed to match road, traffic, and weather conditions.***

15. Grade slowly to prevent the machine from being thrown out of control if the blade strikes roots, rocks, or stumps.

16. Watch the road for hazards. Dismount and look things over carefully if you cannot see clearly.

17. Keep graders away from the edge of fills with soft shoulders. Be especially watchful during and after rain or snow storms.

18. Watch above the cut bank for rocks, logs, and trees that blade action could loosen during bank or back sloping.

19. Maintain control on hills by keeping the machine in gear; never coast out of gear. Do not depend entirely on brakes to hold the grader while traveling or working, or when the machine is parked.

20. Pull, do not push, logs and windfall off the road where there is a danger of sliding or rolling on to the machine.

21. Point the end of the blade on the traffic side to the rear and away from the direction of travel when possible.

22. Carry the blade so it can stop the machine if the brakes fail.

23. Sufficiently angle the moldboard so that the ends are within the width limits of the tires.

24. On narrow roads, stop and let oncoming traffic pass.

25. Plan blading so that a section is completed each day. Where a windrow must be left overnight, place signs or lights to warn motorists.

26. When operating an articulated machine, always keep the motor end of the machine on the road.

44.25 – Shovels and Cranes.

44.25a – Safety Practices. Follow these general safety guidelines:

1. Ensure that only qualified, tested, and certified persons operate shovels and cranes. Have trainees under the supervision of a certified operator.

2. Permit only a mechanic, inspector, or operator trainee in the cab while the machine is in operation, and ensure that adequate handholds are provided.

3. ***In addition to wearing the required PPE, wear close-fitting clothing (such as coveralls) and nonskid boots.***

4. Ensure that supervisors and operators comply with the manufacturer's specifications and limitations concerning shovel and crane operation. Never exceed the rated capacity of the boom at the operating angle.

5. Never use attachments that exceed the manufacturer's capacity rating or recommended scope. Hoist only loads well within the rated capacity. When lifting heavy loads, use a two-, three-, or four-part line to keep within the rated capacity of the hoisting cable.

6. Make sure that rated load capacities and recommended operating speeds, special hazard warnings, or instructions are conspicuously posted on all equipment. Instructions or warnings shall be visible to the operator while at the central station.

7. Have a competent person inspect all machinery and equipment before and during use to ensure that it is in safe operating condition. Repair any deficiencies and replace defective parts before continuing use.

8. Have a competent person thoroughly inspect the hoisting machinery annually. File a copy of the inspection report signed by the inspector. The report should include the date of inspection and the serial number of the machine inspected. Keep this record of inspection readily available.

9. Guard all belts, gears, shafts, pulleys, sprockets, spindles, drums, fly wheels, chains, or other reciprocating, rotating, or moving parts or equipment to which employees are exposed. After equipment has been adjusted or repaired, do not operate it again until all guards are reinstalled, safety devices are reactivated, and maintenance equipment is removed.

10. Barricade accessible areas within the swing radius of the rear of a crane's rotating super structure to prevent anyone from being struck or crushed.

11. Always guard or insulate exhaust pipes when people must work close to them.

12. On internal combustion engine-powered equipment with enclosed cabs, conduct tests to ensure employees are not exposed to unsafe concentrations of toxic exhaust gases or oxygen deficient atmospheres.

13. Ensure that all windows in cabs are made of safety glass or the equivalent and are free of distortions that could affect the operator's ability to see clearly and safely run the machine.

14. Where necessary for rigging or service requirements, provide a ladder or steps for access to the cab roof.

15. Ensure that platforms and walkways have nonskid surfaces.

16. At a minimum, provide a fire extinguisher of 5 BC rating at all operator stations or properly secured in cabs of equipment.
17. If possible, perform all greasing, oiling, repairs, and cleaning when the engine is turned off; the suspended load is blocked or cribbed; and movable parts are secure.
18. Keep metal plates, walkways, and ladders used for maintenance or repairs free of ice, snow, mud, oil, or grease and in safe condition.
19. Promptly repair leaking hydraulic cylinders, feedlines, and fuel lines, and clean up or clear walking/working surfaces of slipping and tripping hazards.
20. Conduct a visual safety walk inspection around the machine before beginning each day's operation.
21. Check all control mechanisms daily to correct maladjustments that interfere with proper operation.
22. Check air or hydraulic systems daily for deterioration or leakage.
23. Inspect wire ropes, guys, hoists, trolley cables, jib and counter weight, jib guy lines, and hoist ropes/straps monthly.
24. Inspect critical items, such as brakes and crane hooks, monthly or more often.
25. Place the machine on the most level ground possible. If cribbing or shims are needed, make sure they are sturdy and secure from overturning or shifting. Block the machine to prevent rolling or sinking after positioning.
26. If a machine is placed near an excavation, install shoring and bracing to prevent a cave-in. Otherwise, keep the machine back from the edge at a distance at least equal to the depth of the excavation.
27. Never leave cranes parked near the edge of an excavation or in an area that rain or a flash flood may make impassable or unstable.

28. When operating a pneumatic-tired, self-propelled machine, stabilize the unit outriggers as necessary.

29. Suspend operations if environmental conditions, such as lightning or high winds, compromise operator/employee safety.

30. When handling, attaching, and moving the load, ensure that:

- a. The load is attached to the hook by means of slings or other approved devices.
- b. The hoist rope is not kinked or wrapped around the load.
- c. The crane is level and, where necessary, blocked properly.
- d. The load is well secured and properly balanced in the sling or lifting device before it is lifted.
- e. The hook is brought over the load to prevent swinging.
- f. There is no sudden acceleration or deceleration of the moving load.
- g. The load does not contact any obstructions.

31. ***Do not allow anyone to go under the raised dipper, boom, or equipment, and do not move the machine until everyone is in the clear.***

32. Load trucks only when they are safely placed and when the driver is out of the cab and visible to the loader operator.

33. Swing the load over the rear of a truck, not over the cab.

34. Disengage the master clutch before temporarily leaving the cab. Never leave a dipper or other load suspended.

35. Shut off the motor, set the brakes, lock the controls in neutral, and secure movable parts before leaving the cab for the day.

36. Consider all overhead wires to be energized until power company authorities indicate otherwise and the lines have been visibly grounded.

37. The distance between operations and overhead powerlines must be 1-1/2 times the length of the boom plus the length of the material being carried.

38. Use known routes of travel whenever possible. Inspect new routes for turning radius, width, height, load limits, and traffic conditions.

39. Use a flag person whenever there may be hazards to the operator or other persons. Provide radio communications between the transport operator and flag person or pilot car.

40. Use lead/following vehicles equipped with "Wide Load" signs and flashing caution lights. Provide the tractor/trailer operator and lead/following vehicle operators with radio communications.

41. Be aware of overhead obstructions, such as underpasses, low-hanging limbs, or wires.

42. Designate a person to observe clearance of the equipment and to give timely warning for all operations where it is difficult for the operator to maintain the desired clearance by visual means.

43. When a signal person is utilized, review and use standard hand signals.

44. Ensure that only one person signals to the operator unless the load is being transferred out of sight of the signal person.

45. Ensure that the signal person(s) is provided with and wears a high-visibility vest and gloves.

46. Ensure that all employees are in the clear before hoisting loads.

44.3 – Chippers.

44.31 – Safety Practices.

1. General.

- a. Post "Road Work Ahead" signs and flags on sections of road work to alert and advise forest users.
- b. Ensure that all employees involved with the chipping operation are thoroughly briefed on the safe work practices and required PPE before starting the operation.
- c. Always follow the manufacturer's recommendations for machine safety, operation, and maintenance.
- d. Make sure all manufacturer safety devices and guards are in place and functional and are checked daily.

- e. Check cutter-blade bolts daily before starting a machine and again midway through the shift. Always tighten the wedge and adjusting bolts to manufacturer's specifications. Check the wedge and adjusting bolts before starting in the morning, after the lunch break, and as deemed necessary.
- f. Check material being fed into chippers for embedded rocks before the material is put into the hopper.
- g. If a chipper is disconnected from the towing vehicle for operation, ensure that all legs are fully extended and that the wheels are blocked before operation.
- h. Always clean accumulations of sawdust and pitch from the cutterhead seating surfaces and wedge blocks when changing blades.
- i. Follow the manufacturer's recommended procedures and specifications when adjusting blades.
- j. After changing the blade, always have workers stand a safe distance away from the machine until the operator brings the cutterhead to operating speed and all working components are secured.

2. **Brush Chipper.**

- a. Allow only one person at a time to feed the chipper, and always feed the material from the side by inserting material butt end first into the hopper.
- b. Never reach into the throat of an operating chipper.
- c. To avoid dangerous throw/kickback, leave out excessively dry, crooked, or pitchy pieces.
- d. Feed short pieces into the hopper with a long push stick and use the push stick or another limb to clear the hopper.
- e. Do not exceed the chipper's maximum material diameter limits.
- f. Avoid overloading the chipper.

3. **Tree Chippers.**

- a. Ensure that the material discharge area is clear before starting the blower.
- b. Direct chipper-blower discharge downwind when possible.

- c. Provide, at a minimum, a 6-foot (1-4/5 m) buffer zone both ahead and behind the blower.
- d. Block the chipper hood securely when it is in an elevated position.
- e. Take precautions to prevent rocks or metal from entering the chipper conveyor. Dislodge limbs and debris that hang up in the conveyor mechanism with a pike pole or other suitable device.
- f. Do not permit anyone to climb on or enter the conveyor while it is moving or when the main engine is running.

4. **Tree Chipper Loader.**

- a. Permit only the operator to be on the chipper unit while it is in operation.
- b. Permit only employees who have documented "hands on" training to work within the immediate area of the loader and the chipper conveyor.
- c. When working as the operator, ensure that workers are clear of moving equipment and parts, such as grapple hooks and swinging trees.
- d. When working as the operator, establish a communication/signal system with the employees that identifies the safe positioning of all crewmembers. If audible signals are used, follow this system:
 - (1) One blast of the airhorn: "STOP"
 - (2) Two blasts: "MOVE EQUIPMENT AHEAD."
 - (3) Three blasts: "BACK UP"
 - (4) Repeated short blasts: "DANGER."
- e. Do not allow crewmembers to enter the working radius of the loader until the operator gives a clear visual or verbal okay to do so.
- f. Direct crewmembers to notify the operator immediately when a hazard is recognized so that work can be stopped promptly and the situation can be corrected.

44.4 – Mulch Spreaders.

44.41 – Safety Practices.

1. Ensure that the work crew thoroughly understands the safe work practices and their specific duties concerning operation of the spreader, tank-trailer, and towing vehicles.

2. Conduct pre-use trials to ensure that the equipment is operating properly and that crews are adequately trained.
3. Always perform a pre-use safety inspection of the machine and follow-up inspections during and after use.
4. Before adjusting or repairing the machine, stop the engine and disengage the clutch.
5. Always exercise caution when disconnecting hydraulic lines.
6. As a minimum, provide one or more multi-purpose 10-pound (4-1/2 kg) ABC fire extinguishers on the mulch spreader. Include extinguishers in any machine inspection to ensure that they are charged and operable.
7. As part of training, ensure that all project personnel know how to use the fire extinguishers.
8. Take precautions to prevent fire when using nitrate fertilizer or other flammable or explosive chemicals.
9. Store all flammables and combustibles in approved, grounded/bonded safety containers when necessary to prevent generation of static electrical sparks.
10. Do not permit open flame or fire on or near the mulching machine.
11. Do not attempt to extinguish a fertilizer fire.
12. Use only mulch material designed specifically for the mulcher being used.
13. Use only mulch material baled with twine. Do not feed wire or metal strapping into mixing chambers.
14. In addition to the required PPE, require workers to wear appropriate respirators when:
 - a. They are using powdered fertilizer, chemicals, or straw that may become airborne.
 - b. They are exposed to vapors (hydrocarbon) or are cleaning asphalt tanks.
 - c. Respirators are identified by the JHA or product MSDS.

15. When mounting an asphalt barrel on the side of the mulcher, attach an appropriate warning device to indicate clearance limits.

16. Post "Road Work Ahead" signs on sections of road being worked to alert and advise forest users.

17. Do not operate a mulch spreader if winds may blow material and decrease the operator's visibility or may blow material onto passing traffic.

18. Always maintain a ground strap in contact with the ground during spreader operation to prevent build up and generation of a static electrical charge.

19. Secure the blower tub and hoses, and remove loose articles from the machine before moving.

20. Tow an asphalt tank-trailer behind the spreader only when mulching, and always keep safety chains fastened when hitches are engaged.

21. Lower jacks and block wheels securely before disconnecting a trailer.

44.6 – Trucks/Forklifts. This section addresses the safe use of powered industrial trucks (forklifts) and dump trucks.

44.61 – Standards. The standards for powered industrial trucks and hazard communication are in 29 CFR 1910.178 and 1910.1200.

The standard for general equipment and material handling equipment is in 29 CFR 1926.600 and 1926.602.

44.62 – Powered Industrial Trucks (Forklifts). Only employees who have completed training in the safe operation of lift trucks shall operate them as part of work projects and activities. (Exception: A specific work project or activity may be used for training where the trainee is under the direct supervision of a qualified operator. The JHA shall indicate that such training is acceptable.)

44.62a – Safety Practices.

1. Conduct a daily walk-around safety inspection of lift trucks before operation, and inspect lift trucks used around-the-clock after each shift. Take out of service any truck that could present a safety hazard to the operator or other workers.

2. Do not handle loads that exceed a truck's rated capacity.

3. Require authorized personnel to make all repairs.

4. Remove from service and repair any truck that emits sparks or flames from the exhaust system.

5. If the temperature of any part of the lift truck exceeds the normal operating temperature, remove the truck from service and repair it.

6. If storage warehouses and outside storage locations are considered hazardous, use only the type of lift truck specified for the hazard involved. For specific designations refer to 29 CFR 1910.178(b).

7. Monitor carbon monoxide levels where lift trucks operate in enclosed, nonventilated areas.

8. Charge batteries in locations designated for that purpose.

9. Make sure ventilation is adequate to disperse fumes from gassing batteries.

10. Provide facilities for:

a. Flushing and neutralizing spilled electrolyte to prevent fire.

b. Protecting the charging apparatus from damage by other trucks or equipment.

11. Always take precautions to prevent open flames, sparks, or electrical arcs in battery charging areas.

12. Always keep tools and other metallic objects away from the tops of uncovered batteries.

13. Never check the electrolyte level in storage batteries, or the gasoline level in fuel tanks, with an open flame.

14. Always keep lift trucks in clean condition, free of oil and grease.

15. Do not drive a truck up to anyone standing in front of a bench or other fixed object.

16. Do not allow anyone to stand beneath or pass under any elevated portion of a truck, whether loaded or empty.

17. When a lift truck is left unattended, fully lower the load engaging means, put the controls in neutral, set the brakes, and shut off the power. A lift truck is considered unattended when the operator is 25 feet (7-1/2 m) or more away from the vehicle and it remains in view, or whenever the operator leaves the vehicle and it is not in view regardless of distance.

18. Always maintain a safe distance from the edge of ramps or platforms while on any elevated dock.

19. When unloading a truck or semi-trailer, always ensure that the brakes are set and the wheel chock blocks are in place to prevent any movement.

20. Fixed jacks may be necessary to support a semi-trailer during loading or unloading when the trailer is not coupled to a tractor. Before driving a lift truck into a truck or trailer, check the flooring for breaks or weakness.

21. When ascending or descending grades in excess of 10 percent, position the truck so that the load is always upgrade. Split the load when it impairs the view in the direction of travel.

22. On all grades, tilt the load back. Raise the load only as far as needed to clear the surface.

23. Always operate the lift truck at a speed that permits stopping in a safe manner.

24. Prohibit horseplay.

25. Always proceed with caution when the driving surface is wet or slippery.

26. Slow down and sound the horn at cross aisles and other locations where vision is obstructed. If the load being carried obstructs the forward view, travel with the load trailing.

27. Sound an audible back-up alarm any time the machine is going in reverse.

28. Do not pass other lift trucks traveling in the same direction at intersections, blind spots, or other dangerous locations.

29. Always keep fire aisles, exits, and access to stairways clear of obstructions.

30. Permit only specifically authorized persons to ride on lift trucks and provide a safe place to do so.

31. Whenever a lift truck is equipped with controls attached to the lifting carriage or forks that make it possible to lift people, take these precautions to ensure the safety of those lifted:

- a. Use a safety platform firmly secured to the lifting carriage, forks, or both.
- b. Provide a means for those on the platform to shut off power to the truck.
- c. Provide protection from falling objects when conditions warrant.

44.63 – Dump Trucks. Perform a walk-around safety inspection daily before driving. Check the brakes to ensure that they are fully functional.

44.63a – Safety Practices.

1. **General.**

- a. Check the tires for proper inflation, cuts, brakes, and excessive or uneven wear.
- b. Always inspect for and remove any rocks, limbs, and other debris lodged between dual tires.
- c. Check lug nuts daily for proper tightness.

2. **Vehicles Provided With Air Brakes.**

- a. Check:
 - (1) Slack adjustment on S-Cam brakes.
 - (2) Brake drums, linings, and hoses.
 - (3) Spring brakes, which should come on automatically.
 - (4) The rate of air pressure buildup.
 - (5) The air compressor governor cut-out pressure.

- (6) The safety relief valve; bleed off condensation from the air tanks (unless the system has automatic drain valves).
 - (7) Manufacturer's and commercial driver's license (CDL) brake test requirements and specifications.
- b. Test:
 - (1) The low-air-pressure warning signal.
 - (2) The air leakage rate.
 - (3) The parking brake and service brakes.
3. Dump Truck Drivers. Drivers shall ensure that:
 - a. A positive means of support is locked or blocked into position to prevent accidental lowering of the dump bed during maintenance or inspection.
 - b. Vehicles parked on an incline have the wheels chocked and the parking brake set.
 - c. The hoist control mechanism cannot be accidentally engaged when transporting loads.
 - d. The cab and floor are free of obstacles that may interfere with controls and driving.
 - e. The power take off is disengaged when not in use.
 - f. The load is secure and does not exceed rated load capacity.
 - g. A latch or other locking device that prevents accidental tripping of the tailgate is in place when the truck is not in use.
 - h. Only the driver or dump boss trips the tailgate.

Drivers shall leave the truck while the dump bed is being filled by a swing boom loader or if requested to do so by the operator of any type of loader.

Dump truck drivers shall always lower dump beds when not in use.

44.7 – Drill Rig Operations. Complete a JHA for each drilling work project or activity (sec. 22.08).

44.71 – Standards. The standards for PPE for geological investigations are in 29 CFR 1910.132. The authority for surface metal or nonmetal mining is in 30 CFR Part 56.

44.72 – Qualifications.

1. All employees involved in drill rig operations should have the applicable training and certifications listed in section 22.07.
2. A qualified drill rig operator shall be assigned and have total responsibility for the drill rig and operators in training.
3. At least two members of each crew shall be first aid/CPR certified.

44.73 – Personal Protective Equipment. The following PPE is required for geological investigation:

1. Hardhat.
2. Eye protection (goggles or safety glasses with wrap around or side shields).
3. Approved respirator (sec. 21.13).
4. Hearing protection (85 dB and above).
5. High-visibility vest.
6. Leather nongauntlet gloves.
7. Nonskid safety-toed boots.
8. First aid kit (refer to the Glossary).
9. Specific items for conditions requiring extra protective measures as identified in the JHA.

44.74 – Safety Practices. Unqualified employees shall not operate drills except under the supervision of a master driller.

Basic safety and health practices are:

1. Wear suitable clothing. Avoid loose fitting or baggy clothes.
2. Immediately change clothing saturated with oil or fuel.
3. Require that visitors wear the same PPE as field workers.
4. If the drilling rig mast is left in the upright position when moving the drill rig truck, walk the length of the route to determine

the presence of electrical hazards or other obstructions. This is a joint responsibility of the immediate supervisor and the driller.

- a. Do not permit the mast within 10 feet (3 m) of powerlines.
 - b. Use proximity warning devices on drill rigs.
5. Check bridges, road conditions, grade, and overhead clearance before moving the drill rig truck over unfamiliar roads.
6. Disengage the winch and drill power-takeoff before putting the truck in motion.
- a. Secure loose equipment.
 - b. Stay clear of the mast when raising or lowering.
 - c. Chock rig wheels when drilling.
7. Use threaded swivel hoisting plugs. Keep the threads clean and lubricated, and ensure that the air-vent hole is completely into the rod box when used.
8. When using slips, have the right size for the drill rods and keep them clean to ensure a firm grip.
- a. Replace or repair worn slips; never shim them.
 - b. Never set slips until rods are completely stopped.
9. Keep tool joints clean and lubricated. Replace and repair those showing wear.
10. When picking up or laying down drill rods, have the helper stand clear. When manually rotating a stuck drill rod, set the controls on the drill so there is no possibility of the rods' suddenly raising or lowering when they are freed.
11. Never allow mud to accumulate in the working area. Use a rubber rod wiper to clean the drill stem as it comes from the hole. Spread dry soil over the working area if necessary, or provide a portable wooden or steel work platform to provide safe footing.
12. Keep clutches, brakes, and hydraulic valves and lines in proper adjustment so they cannot inadvertently become engaged.
13. Equip mud pumps with pressure relief valves set to open at not more than the maximum pressure recommended by the manufacturer.

- a. Use guards on shear-pin type valves to prevent possible injury by the flying pin.
- b. Direct discharge from these valves toward the ground.
- c. Before working on the mud pump to replace liners, for example, be sure the pressure is released.

14. Never hold the pipe wrench on the drill rod while using rig down-pressure to force a pipe into the hole. Use a push bar that does not have to be held for this operation.

15. Use deflectors to direct the cuttings away from the drill crew. Cuttings blown from the hole in air drilling can be a hazard. Goggles and respirators are required if dust and cuttings cannot be controlled.

- a. Never direct the air stream at your body. Gages are required to accurately show the air pressure. Do not test the pressure on your hands or feet.
- b. Completely release air pressure before breaking any connections.

16. Secure the rotary hose by safety chains attached to the hose by metal clamps, independent of the hose connection clamps. Fasten the lower safety chain to the mast.

17. Ensure that at the source of supply every air drill with hoses exceeding 1/2-inch (1.27-cm) diameter is equipped with a safety device.

45 – EQUIPMENT DEVELOPMENT.

45.01 – Authority. The authority for general equipment development is contained in FSM 7120, Equipment Development.

45.03 – Policy. Utilize the Technology and Development Centers in a program of development efforts to benefit resource management on the national forests and grasslands.

45.1 – Procedures. Equipment development requires a structured approach from planning and design through implementation and support. A structured approach involves a proven series of steps and tasks that a project team can follow to build or modify quality equipment safely, faster, and at lower costs.

A project team should use the following steps of the Structured Systems Development Life-Cycle Methodology for a systems development effort. The methodology outlined in the following sections describes key steps and tasks of a systems development effort. The exact methodology used to develop or maintain a system should be appropriate to the size, type, and scope of the project.

The five basic phases of the Structured Systems Development Life-Cycle Methodology include:

1. **Conceptual Design.** In the concept design phase, management identifies the need for a system that will enhance the ability of the Forest Service to achieve its business objectives. This phase determines the appropriate systems solution, defines the basic goals of the system, and defines a project work plan. The project plan outlines the scope, policies, philosophies, responsibilities, guidelines, major milestones, assumptions, and constraints.

2. **Planning.** The planning phase consists of formulating and formalizing the new system's safety, functionality, quality, and architectural requirements; designing (or modifying) the system to meet those requirements; and planning for safe development and implementation. Management must identify and assess the critical system specification issues before actual system development begins.

3. **Development.** The development phase occurs after the initial planning phase ends. This phase includes resolving any user design issues and developing the technical, detailed design of each specific program. Once the design is complete, system developers code individual programs, create conversion files, and thoroughly test the system. In addition, the system is documented and the users are trained. This phase demands constant monitoring from management to control the scope of the project.

4. **Implementation.** The implementation phase begins during the system test component of the development phase. This phase includes preparing the system for implementation, testing user acceptance, and then implementing the new system. Preparations for implementing the new system can occur at the same time as the system test. Once the users are trained, they can begin the user acceptance test component of this phase. When the system

has been completely tested and accepted, actual implementation can take place. The objective of this phase is to ensure that the system satisfies the stated requirements, and then to provide an environment that will ensure the system's continued success. Review of system objectives, requirements, plans, user acceptance, and sign-off are crucial throughout the implementation phase.

5. **Post Implementation/System Support.** The post implementation/system support phase occurs after the system has been implemented and continues for the life of the system. This phase includes continuous monitoring, maintaining, and modifying of the system to ensure that the system performs as expected, and that it continues to meet the user's dynamic needs.

CHAPTER 50 – EMPLOYEE SAFETY, SECURITY, AND HEALTH

Contents

51 EMPLOYEE SAFETY AND SECURITY

- 51.01 Authority
- 51.04 Responsibility
- 51.06 References
- 51.1 Procedures
- 51.11 Safety Practices
- 51.2 Firearms for Non-Law Enforcement Personnel
- 51.21 Authorization for Firearms
- 51.21a Expiration of Firearms Authorization
- 51.21b Employees With Occasional Need To Carry Firearms
- 51.22 Firearms Training
- 51.22a Firearms Training Course
- 51.22b Shooting Proficiency
- 51.23 Use of Firearms
- 51.23a Privately Owned Firearms
- 51.23b Firearms in Camp
- 51.24 Firearms and Ammunition Storage
- 51.3 Aerosol Defensive Sprays
- 51.31 Authorization for Aerosol Defensive Sprays
- 51.32 Training
- 51.33 Transportation and Storage
- 51.34 Reporting Procedures
- 51.35 Restrictions on Aerosol Defensive Sprays

52 EMPLOYEE HEALTH AND WELLNESS

- 52.01 Authority
- 52.06 Reference
- 52.1 Health Practices
- 52.2 Fitness
- 52.3 Bloodborne Pathogen Program
- 52.31 Scope of Employee Coverage
- 52.32 Exposure Control Plan
- 52.33 Training
- 52.34 Hepatitis B Vaccination
- 52.34a Post-Exposure Incident Evaluation
- 52.4 Ergonomics

- 52.41 Cumulative Trauma Disorders
- 52.42 Back Injury
- 52.43 Neck and Eye Strain

53 PLANT, ANIMAL, AND INSECT HAZARDS

- 53.01 Authority
- 53.1 Poison Ivy/Oak/Sumac and Noxious Weeds
- 53.2 Ticks and Chiggers
- 53.21 Ticks – General Safety Practices
- 53.22 Chiggers – General Safety Practices
- 53.3 Poisonous Snakes, Spiders, and Scorpions
- 53.31 Precautions for Working in Snake Country
- 53.31a First Aid for Snake Bites
- 53.4 Spiders
- 53.5 Scorpions
- 53.6 Insect Stings and Bites
- 53.61 Honey Bees
- 53.61a Safety Guidelines
- 53.61b Africanized Honey Bees
- 53.62 Mosquitoes
- 53.7 Bears, Mountain Lions, and Other Animals
- 53.71 Bears
- 53.72 Mountain Lions
- 53.73 Other Animals and Hazards
- 53.73a Hantavirus
- 53.73b Rabies

54 ENVIRONMENTAL HAZARDS

- 54.01 References
- 54.1 Radiation
- 54.11 Solar Ultraviolet Radiation
- 54.2 Extreme Weather Conditions
- 54.21 Working in Hot Conditions
- 54.22 Working in Cold Conditions
- 54.22a Frostbite
- 54.22b Hypothermia
- 54.23 Lightning and Thunderstorms
- 54.24 Tornadoes
- 54.25 Flash Floods
- 54.3 Altitude-Related Problems

55 TEMPORARY CAMPS

- 55.01 Authority
- 55.06 Reference
- 55.1 Procedures
- 55.11 Temporary Camp Requirements
 - 55.11a Water Supply
 - 55.11b Other Requirements
 - 55.11c Camp Sanitation
 - 55.11d Food and Food Service Operations
- 55.12 Spike Camps/Remote-sites General Campout
 - 55.12a Preparations
 - 55.12b Other Concerns
 - 55.12c Cooking Operations
 - 55.12d Food Rations
 - 55.12e Water Purification of Undeveloped Sources
 - 55.12f After-Work Organized Swimming Activities

CHAPTER 50 – EMPLOYEE SAFETY, SECURITY, AND HEALTH

51 – EMPLOYEE SAFETY AND SECURITY. Violence or the threat of violence by or against any employee is unacceptable. The agency procedures and programs set out in this section are designed to provide for employee safety and security.

51.01 – Authority. The authority for agency responsibilities in employee safety and security is in Title 5, Code of Federal Regulations (5 CFR), section 301.01.

The authorities regarding the protection of government employees and their families are in Title 18, United States Code (18 U.S.C.), Parts 111 and 115, and 36 CFR 261.3.

Further agency direction is in FSM 6700 and FSH 6709.12.

51.04 – Responsibility. Management and employees share the responsibility to provide for safety in the work place.

1. **First-Line Supervisors.** First-line supervisors are responsible for implementing programs and procedures on how to prevent violence at worksites, and on how to provide appropriate response should violence occur (sec. 51.1).

2. **All Employees.** All employees have the responsibility to report all acts of workplace violence promptly to supervisors and managers and, in case of an emergency, directly to law enforcement officials.

51.06 – References. Defense Personnel Security Research Center. Combating Workplace Violence: Guidelines for Employers and Law Enforcement. Private Sector Liaison Committee of the International Association of Chiefs of Police (IACP). 515 North Washington Street, Alexandria, VA 22314-2357.

51.1 – Procedures.

1. Each unit shall develop and keep current an Occupant Emergency Plan. The Occupant Emergency Plan should contain as a minimum the following elements:
 - a. Building evacuation procedures.

- b. Accident/incident reporting procedures and guidelines.
 - c. Emergency telephone numbers.
 - d. Bomb threat checklist. Ensure that all employees have copies of the bomb threat checklist.
2. Each unit shall develop a site-specific Job Hazard Analysis (JHA), Form FS-6700-7 or equivalent, for all facilities and tasks that involve employees' working alone or with the public. Ensure that the JHA is reviewed by agency law enforcement personnel and/or by local and Federal law enforcement agencies. Minimum components of the plan include:
 - a. Check-out/check-in systems (such as a sign out board), which shall be located and utilized for internal use only.
 - b. Provisions for the safety of employees who collect and transport funds.
 - c. Provisions for the safety of employees working alone in public contact centers and facilities.
3. Field units shall maintain current field emergency evacuation plans, which include the following pertinent information:
 - a. Field evacuation procedures.
 - b. Accident/incident reporting procedures and guidelines.
 - c. Emergency telephone numbers.
4. Employees on travel status should utilize accommodations in the most current list published in the Federal Register by the Federal Emergency Management Agency (FEMA) that meet the requirements of the Hotel Motel Fire Safety Act of 1990 (Pub. L. 101-390).

51.11 – Safety Practices.

1. Be aware of your immediate area and be suspicious of unusual or abnormal activity or objects, such as packages or boxes. Do not attempt to open or handle such objects. If you think a situation may be dangerous, leave the area and report it to a supervisor, local authority, or the nearest law enforcement agency.
2. Advise the appropriate person(s) from your home unit of travel plans with expected times of arrival and return when traveling to and from remote or isolated locations (sec. 22.33d). Ensure vehicles are operating properly and are equipped for the specific task. Travel in pairs where warranted.

3. Avoid areas and situations of known or potential natural or human-caused conflict. Analyze the hazard and use alternative methods and/or routes where possible.
4. Ensure that communications equipment is operating properly.
5. Consider the implications for personal safety when deciding whether to wear the Forest Service uniform and/or drive a Forest Service marked vehicle.

51.2 – Firearms for Non-Law Enforcement Personnel. (For direction on use of firearms by law enforcement personnel, see FSM 5300 and FSH 5309.11.) This section describes authorized use of firearms by non-law enforcement employees. Use of firearms for non-law enforcement purposes is prohibited for non-law enforcement employees on Forest Service work projects and activities, or in crew quarters, camps, or vehicles, unless approval is documented in a JHA (sec. 51.21).

51.21 – Authorization for Firearms.

1. Regional Foresters, Forest Supervisors, Station Directors, the Area Director, or the Institute Director may authorize non-law enforcement employees to carry firearms when functions or circumstances related to official duties necessitate such permission.
 - a. Firearm use while on official business shall be limited to employees who have been authorized to carry firearms, have successfully completed a firearms safety course, and are included in the Executive Order 12564, Drug-Free Federal Workplace (drug testing) Program.
 - b. Authorizations shall be in writing and the training must be documented.
2. The reason for approval to use firearms for administrative activities, such as protection from animals and cone collection, shall be identified in the JHA, as well as the specific type of firearm. Loaded firearms shall not be permitted in buildings, vehicles, boats, camps, or on horseback, except as defined in the JHA.
3. All units shall prepare an annual report on the use, storage, inspection, and safekeeping of weapons and ammunition. All Forest Service firearms shall be inspected at the end of each field season

by an inspector designated by a line officer. Results of these inspections shall be included in the annual report. All repair work shall be accomplished by a qualified gunsmith.

51.21a – Expiration of Firearms Authorization. The employee's authorization to carry a firearm shall expire:

1. At the end of the calendar year; or
2. Upon completion of the work project or activity; or
3. If there is a change of duty station, status, or transfer; or
4. Upon failure to demonstrate shooting proficiency as required, or if rescinded by an authorizing officer for any other reason.

51.21b – Employees With Occasional Need To Carry Firearms. Seasonal or part-time non-law enforcement employees, or full-time employees who have only an occasional need to carry firearms, must demonstrate proficiency once at the beginning of each term of employment or the beginning of each field season requiring the use of firearms.

51.22 – Firearms Training. Only those persons who are competent and qualified in firearms use and who have completed a firearms safety course may be authorized to use or carry firearms. Such a course must be of at least 4 hours duration; conducted by firearms instructors who are certified according to standards established and approved by the Federal Law Enforcement Training Center, Federal Bureau of Investigation, or National Rifle Association; and developed under the direction of and approval of a Regional Forester, Forest Supervisor, Station Director, Area Director, or Institute Director, and the Special Agent-in-Charge.

51.22a – Firearms Training Course. A firearms training course shall include:

1. Firearms safety and handling.
2. Proper firing techniques, including the demonstration of weapons proficiency on a firing range.
3. Legal and ethical aspects of firearms use.

4. Animal behavior (when applicable).

51.22b – Shooting Proficiency. Full-time employees authorized to carry firearms in the course of employment must demonstrate their shooting proficiency (70 percent or better) for each type of firearm carried, and they must shoot for the record at least twice each year under the direction of an approved instructor. Seasonal or part-time employees are required to demonstrate proficiency once at the beginning of each term of employment.

51.23 – Use of Firearms. Employees must observe all Federal and State laws and local ordinances concerning the licensing, use, and transportation of firearms and ammunition. Employees are prohibited at all times from using Government vehicles or equipment for the express or incidental purpose of hunting, shooting, or transporting of game, hunters, firearms, or ammunition. Violators are subject to disciplinary action and/or prosecution under the law.

51.23a – Privately Owned Firearms. The voluntary use of privately owned firearms may be permitted in accordance with Federal and Forest Service property management regulations and the safety requirements of this Handbook.

51.23b – Firearms in Camp. The use of firearms is prohibited in camp areas or during work hours except when required for employee safety or if in the best interests of the Forest Service.

51.24 – Firearms and Ammunition Storage. Ensure that all firearms not in active use are unloaded before storage and stored in a secure place, under lock and key. Whenever possible, store weapons and ammunition separately. Do not store firearms in crew quarters.

1. Persons residing in family housing at administrative sites may keep firearms, but they shall be in locked storage.

2. Forest Supervisors or Station Directors may establish policies to authorize locked storage of personal firearms at Government facilities. Such authorization shall require that firearms be kept unloaded at all times while on the administrative site and shall be kept in suitable secure storage.

3. Management or supervisory personnel must retain responsibility for access to such locked storage. A check-out/check-in system shall also be part of this storage arrangement.

51.3 – Aerosol Defensive Sprays. This section describes the authorized use of aerosol defensive sprays (ADS) by designated and trained non-law enforcement personnel for protection from physical harm or personal injury, primarily by threatening wild or domestic animals.

51.31 – Authorization for Aerosol Defensive Sprays.

1. Regional Foresters, Forest Supervisors, Station Directors, Area Director, and Institute Director may authorize employees to carry aerosol defensive sprays when:
 - a. Circumstances or functions related to official duties warrant added personal protective measures;
 - b. Employees operate within the scope of their employment on National Forest System lands or other lands and properties under the control of the Forest Service; and
 - c. Designated employees successfully complete aerosol defensive sprays training (sec. 51.32).
2. Approval for employees to carry and use aerosol defensive sprays shall be identified in a Job Hazard Analysis signed by the line officer.
3. Employee authorization to carry and use aerosol defensive sprays shall expire:
 - a. At the end of the calendar year; or
 - b. Upon completion of the work project or activity; or
 - c. If there is a change of duty station, status, or transfer; or
 - d. Upon failure to demonstrate competent and prudent use of aerosol defensive sprays.

51.32 – Aerosol Defensive Sprays Training. Only those employees who have successfully completed an aerosol defensive sprays safety course and demonstrated ability in its use may be authorized to carry and use aerosol defensive sprays.

1. Each unit shall develop an aerosol defensive sprays safety course with a field practicum for employees designated to carry

and use aerosol defensive sprays. The course shall include, at a minimum:

- a. Direction contained in sections 51.3 through 51.35.
- b. Definition of the active ingredient(s) in aerosol defensive sprays, such as oleoresin capsicum.
- c. Effects of aerosol defensive sprays on wild animals, domestic animals, and human beings.
- d. Storage and transportation requirements, including shelf life (sec. 51.33).
- e. Procedures for readying, carrying, and using aerosol defensive sprays.
- f. Medical considerations.
- g. Animal behavior and habitat (as applicable).
- h. Reporting procedures (sec. 51.34).
- i. Instructor demonstration in the use of aerosol defensive sprays.

2. Persons designated to provide aerosol defensive sprays safety course instruction shall successfully complete a course sponsored by an aerosol defensive sprays manufacturer or a recognized trainer in the use of aerosol defensive sprays, or an equivalent training course, or shall be appointed by a line officer based on their demonstrated knowledge and experience before convening training. Instructors shall also possess knowledge in animal behavior and habitat (as applicable).

3. Designated employees successfully completing an aerosol defensive sprays safety course shall be given documented evidence of completion, such as a certificate or equivalent, and training records shall be maintained in the employee's Employee Development File.

4. A refresher training course is required every two years for those employees whose authorization to carry and use aerosol defensive sprays will extend beyond a two-year timeframe. Refresher training shall include the minimum requirements prescribed in section 51.32.

51.33 – Transportation and Storage. Aerosol defensive sprays:

1. Shall not be carried or transported aboard commercial aircraft at any time.

2. May be transported internally or externally aboard U. S. Department of Agriculture owned, leased, or contracted aircraft provided they are securely stored in an approved safety container. (Additional information can be found in the project report, Safety Containers for Transporting Bear Repellant Spray Canisters in Vehicles (9667-2823-MTDC), published by the Missoula Technology and Development Center.)

3. May be transported in U. S. Department of Agriculture owned, leased, or contracted motor vehicles provided they are securely stored in an approved safety container (see the preceding para. 2).

4. Shall be stored in a manner to limit access to authorized individuals only.

5. Should not be stored above room temperature, near heat sources, or open flames, or placed in areas which subject aerosol defensive sprays to extreme temperatures, such as vehicle trunks, glove boxes, or on dashboards.

51.34 – Reporting Procedures. Reporting procedures involving the use of aerosol defensive sprays are:

1. Any employee who discharges aerosol defensive sprays in the commission of official duties shall notify the immediate supervisor as soon as possible. The immediate supervisor may request a brief narrative of the incident by the employee as a follow-up to the initial notification.

2. The employee's immediate supervisor shall report the incident to the appropriate line officer as soon as possible.

3. The line officer shall determine if additional actions need to be taken to ensure a safe workplace environment for their employees.

51.35 – Restrictions on Aerosol Defensive Sprays.

1. Authorized employees shall carry only those aerosol defensive sprays issued by the Forest Service.

2. Aerosol defensive sprays issued by the Forest Service shall not be carried and used at any time by authorized employees off duty without written approval by the line officer.

52 – EMPLOYEE HEALTH AND WELLNESS. Most measures that promote health and wellness involve life-style choices that are a result of personal decisions by individual employees.

52.01 – Authority. The authority for health requirements related to temporary labor camps and bloodborne pathogens is in Title 29, Code of Federal Regulations (29 CFR), sections 1910.141 – 1910.142 and 1910.1030. FSH 6709.12, Safety and Health Program Handbook, and FSM 6740 also provide direction in these areas.

52.06 – Reference. Sharkey, Brian J. 1997. Fitness and Work Capacity, Second Edition. 9651-2812-MTDC. Missoula Technology and Development Center, Forest Service, Missoula, MT.

52.1 – Health Practices. It is agency policy to encourage employees to follow positive health practices in an effort to:

1. Maintain a high level of physical fitness through a regular physical fitness program that improves aerobic fitness (endurance) and muscular fitness (strength and muscular endurance).
2. Achieve and maintain a desirable body weight through healthful eating habits and exercise.
3. Avoid alcoholic beverages or limit consumption to one or two drinks a day.
4. Avoid smoking and breathing secondhand smoke.
5. Avoid smokeless tobacco products.
6. Use over-the-counter and prescription drugs only as prescribed.
7. Have complete annual medical, dental, and eye examinations and take advantage of community health and wellness program services.
8. Promote health by scheduling annual leave and arranging job schedules to limit fatigue and job-related stress.
9. Get 7 to 8 hours of sleep daily.

52.2 – Fitness. A high level of physical fitness is essential for enjoying life to the fullest on and off the job. Regular, moderate physical activity permits an active life-style that enhances health, work capacity, and quality of life. **Exercise can also minimize problems associated with being overweight, such as heart disease, diabetes, high blood pressure, and a host of physiological and sociological problems.** Being overweight affects work capacity by placing added stress on the heart and restricting heat loss.

1. Aerobic and muscular exercises that improve endurance and strength have the following benefits to:
 - a. Reduce the risk of heart disease.
 - b. Improve circulation and respiration.
 - c. Minimize fatigue.
 - d. Strengthen bones, ligaments, tendons, and muscles.
 - e. Reduce physical tension and psychological stress.
 - f. Reduce anxiety and depression.
 - g. Enhance self-image and morale.
2. Exercise programs greatly enhance productivity and morale. Supervisors are encouraged to set up such programs in the following situations:
 - a. For field work crews during the first few weeks of the season.
 - b. For employees who are being required to accomplish new physical tasks.
 - c. For people hired at mid-season to help them better contribute to crew production.
 - d. For employees with past injuries who may be prone to re-injury.
 - e. For all personnel who are or will be involved in wildfire suppression activities.
3. **Before assigning field project work or activities to employees who are not normally field personnel, supervisors should consider individual physical fitness, general health, and personal limitations.**
4. Warm up exercises and stretching are recommended prior to daily work activity or project.

52.3 – Bloodborne Pathogens Program.

52.31 – Scope of Employee Coverage. The Occupational Safety and Health Administration (OSHA) standard at 29 CFR 1910.1030 covers all employees who could be “reasonably anticipated,” as the result of performing their job duties, to come in contact with blood, or any body fluid visibly contaminated with blood, and all body fluids in situations where it is difficult or impossible to differentiate between body fluids. (For additional direction, see FSM 6740).

52.32 – Exposure Control Plan. The Forest Service exposure control plan (FSH 6709.12) is designed to protect employees from occupational exposure to bloodborne pathogens, such as the hepatitis B virus (HBV), human immunodeficiency virus (HIV), and other potentially infectious materials, including human body fluids. As part of this plan, managers and supervisors shall determine those employees and those job classifications with occupational exposure to bloodborne pathogens. Occupational exposure is defined as reasonably anticipated skin, eye, mucous membrane, or parenteral (a piercing of mucous membrane or skin barrier by needle sticks, human bites, cuts, and abrasions) contact with blood or other potentially infectious materials that may result from the performance of an employee's duties.

To further minimize employee risk, all employees, regardless of job classification or duties, shall observe Universal Precautions at all times. Universal Precautions is an approach to infection control in which human blood and human body fluids are treated as if known to be infectious for HIV, HBV, or other bloodborne pathogens.

52.33 – Training. All employees shall receive HIV/AIDS education training. For employees whose jobs put them at risk for an occupational exposure, training shall cover the major elements of the OSHA bloodborne pathogens regulation (29 CFR 1910.1030).

52.34 – Hepatitis B Vaccination. This vaccination shall be made available, at no cost, to all employees who have the potential for occupational exposure to blood or other potentially infectious material. The vaccine should be administered within 10 working days of assignment. Employees must sign a declination form if they choose not to be vaccinated. The employee may later opt to receive the vaccine at no cost.

52.34a – Post-Exposure Incident Evaluation. Make this evaluation available to any exposed employee and include a confidential medical evaluation and the follow-up required by OSHA.

52.4 – Ergonomics. Ergonomic assessments in the workplace can reduce fatigue, discomfort, and potential injury. Minimizing stress, strain, and repetitive motion can prevent injuries and illnesses, such as cumulative trauma disorder (CTD), back injury, and neck and eye strain.

52.41 – Cumulative Trauma Disorders. OSHA defines CTDs as a group of illnesses associated with ongoing damage to soft tissues (muscles, tendons, and nerves) and joints. CTDs include repetitive motion injuries, such as carpal tunnel syndrome, repetitive strain injuries, and musculoskeletal disorders.

Three risk factors that can lead to CTDs are repetition, awkward posture/position, and force (excessive pressure on muscles and joints).

52.42 – Back Injury. Suggested preventive measures include maintaining:

1. A high level of physical fitness.
2. Abdominal tone.
3. Flexibility in the lower back and hamstring muscles.
4. Regular, moderate aerobic activity.
5. Good posture and proper mechanics while lifting and carrying (sec. 39.64).
6. A routine warm-up schedule of five or ten minutes of stretching and loosening the muscles to reduce muscle tension, improve range of motion, and reduce the chance of muscle strains or other injuries.

52.43 – Neck and Eye Strain. Steps to avoid neck and eye strain are:

1. Provide good general illumination and specific task lighting.

2. Maintain the proper distance between the operator and the computer screen. Occasionally focus your eyes off screen on a distant object (sec. 39.51a).
3. Provide video display terminal (VDT) operators periodic breaks of at least 10 minutes per hour away from the terminal.

53 – PLANT, ANIMAL, AND INSECT HAZARDS. Provide seasonal alerts about plant, animal, and insect hazards prevalent locally. Ensure employees know preventive measures and how to render first aid for related local hazards.

The JHA required for all work projects and activities shall identify the necessary PPE, such as gloves, goggles, lightweight disposable clothing, shoe covers, respirators, or bear spray/firearms. Employees shall be trained in the use of all required PPE.

53.01 – Authority. The authority for general safety and health provisions, training, and education related to plant, animal, and insect hazards is in Title 29, Code of Federal Regulations (29 CFR), sections 1926.20 and 1926.21. The authority for handling biohazardous material is in the Missoula Technology and Development Center Tech Tip 9451-2353, Handling Bio-Hazard Material.

53.1 – Poison Ivy/Oak/Sumac and Noxious Weeds. Instruct all employees who are subject to exposure, especially those known to be highly sensitive, in plant identification. When possible, do not assign allergic employees to jobs that expose them to those plants and weeds (ex. 01).

1. Brief employees about poisonous plants and noxious weeds that are present in the work area. Even those who have no history of reactions may become sensitized after contact and have a serious reaction.
2. When working in areas where poisonous plants or noxious weeds may be present:
 - a. Wear proper field attire.
 - b. Provide and apply a skin protectant or barrier cream. Fasten pant legs securely over boot tops (adhesive tape may be necessary).

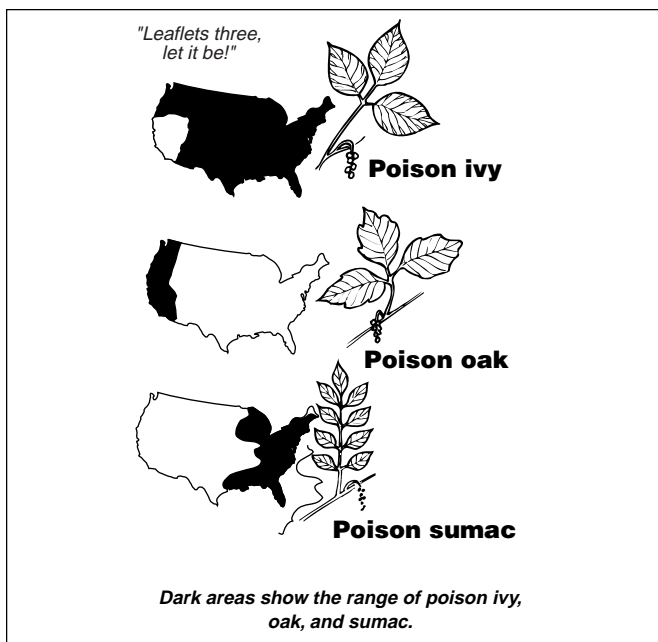
53.1 – Exhibit 01 – Poisonous Plants

- c. Wear gloves and keep them away from the face and other exposed parts of the body. Do not touch skin with hands, clothes, or equipment that may have contacted poisonous plants or noxious weeds.
3. Whenever the skin contacts a poisonous plant or noxious weed, wash the area with **cold** water within 1 to 3 minutes or as soon as possible. Use liberal amounts of water to ensure that all poisonous oils are washed off. While working in the poisonous plant or noxious weed environment, do not use soap and/or hot water because they can remove the natural protective oils from your skin.
4. Destroy poisonous plants and noxious weeds around improved areas.

5. Avoid the smoke of burning poisonous plants. Inhaling this smoke can cause fever, malaise, tracheitis, bronchitis, and severe rash.

6. Upon returning from the field, use rubbing alcohol to cleanse skin that contacted poisonous plants.

7. Clean tools with citric-based solvent before storing (use appropriate gloves and adequate ventilation).

8. Avoid exposure through mishandling of contaminated clothes. Wash contaminated clothing separately from other clothes in hot water and detergent.

53.2 – Ticks and Chiggers. Ticks are carriers of biological agents that cause Rocky Mountain spotted fever, Colorado tick fever, tick paralysis, lyme disease, tularemia, and relapsing fever.

53.21 – Ticks – General Safety Procedures. When working in an area likely to have infected ticks:

1. Spray clothes with an insect repellent, which may provide an additional barrier against ticks. Repellents, such as diethyl metatoloamide (DEET), do not kill ticks. Some sprays do contain permethrin, which kill ticks on contact. Always follow the manufacturer's application instructions for insect repellents and treatments.

2. Wear light-colored clothing that fits tightly at the wrists, ankles, and waist. Each outer garment should overlap the one above it. Cover trouser legs with high socks or boots and tuck shirttails inside trousers.

3. Search the body repeatedly (such as during rest periods and lunch), especially hairy regions and inside clothing, as ticks seldom attach themselves within the first few hours.

4. Remove ticks with fine-tipped tweezers or fingers. Grasp the tick as close as possible to the point of attachment and pull straight up, applying gentle pressure. Wash the skin with soap and water; then cleanse with rubbing alcohol. Do not try to remove the tick by burning it with a match or covering it with chemical agents. If the head detaches during the removal procedure or the tick cannot be removed, seek medical attention.

5. Once the tick has been removed, place it in an empty container so it can be given to a physician should the victim experience a reaction. Record the dates of tick exposure and removal. An early warning sign to watch for is a large red spot on a tick bite. Reactions within 2 weeks include fever, chills, headache, joint and muscle ache, significant fatigue, and facial paralysis.

6. If you observe any of the following symptoms, seek prompt medical attention:

- a. **Rocky Mountain Spotted Fever.** Within 2 to 14 days, sudden onset of headache, chills, fever, and general aches, reddish-purple-black spots appearing on the extremities and spreading to the trunk, neck, and face (80 percent of cases).
- b. **Colorado Tick Fever.** Sudden high fever, chills, fatigue, severe headache, and muscle aches.
- c. **Tick Paralysis.** Within 4 to 6 days, rapid paralysis starting in the extremities and extending to the face area.
- d. **Lyme Disease.** Within 3 days to several weeks, a ring-like rash develops in 60-80 percent of cases, along with flu-like symptoms that disappear even if not treated. Within weeks to months, neurologic abnormalities, including meningitis, encephalitis, and cardiac abnormalities, may become chronic. Within 6 months to several years, joint and muscle pain and arthritis may occur in one or several joints.
- e. **Tularemia.** Chills, fever, loss of appetite, swollen lymph nodes, and ulcer at the wound site.
- f. **Relapsing Fever.** High fever, chills, and abdominal pain; these symptoms subside, only to reoccur at a later date.

53.22 – Chiggers – General Safety Procedures. In chigger-infested areas:

1. Apply insect spray according to the manufacturer's application instructions.
2. Do not sit on the ground or on logs and avoid walking through low vegetation, when possible.
3. Bathe in hot, soapy water after spending time in these areas.

53.3 – Poisonous Snakes, Spiders, and Scorpions. Rattlesnakes, copperheads, and water moccasins (cottonmouths) are poisonous snakes known as pit vipers. They have vertically elliptical (egg-shaped) pupils and a heat-sensing pit midway between the eyes and nostrils on each side of a triangularly shaped head.

The coral snake (also poisonous) may be identified by this rule of thumb: Red bands bordered by yellow (or white) indicate a venomous animal; thus, "Red on yellow, kill a fellow; red on black, venom lack." This rule applies to all coral snakes native to the United States.

1. Learn what poisonous snakes (if any) are native to the area you will be working in.
2. Learn how to identify whether or not a snake is poisonous. If unsure, treat all snakes as poisonous. Study field guides or text book illustrations of indigenous venomous snakes (ex. 01).
3. Do not assume a young snake is not poisonous, because venomous snakes are capable of inflicting a fatal bite from birth.

53.31 – Precautions for Working in Snake Country. When working in snake-infested areas:

1. ***Wear high top boots (just below the knee is preferred) and/or protective snake-proof leggings.*** Use a hiking stick.
2. Although snakes are deaf, they have a good sense of smell and vision and are very sensitive to ground-conducted vibrations. Since they are defensive animals and rarely attack, they remain immobile or attempt to retreat if given the opportunity. When going through thick underbrush, be alert. Walk slowly and give snakes ample time to move out of the way.
3. Be particularly watchful in areas obscured by foliage or near ledges when walking or climbing in rocky country. Snakes have excellent camouflage ability so train your eyes to see their shape and coloration.
4. Walk on clear paths as much as possible. Be careful where placing your feet and hands at all times.

53.3 – Exhibit 01 – Snakes

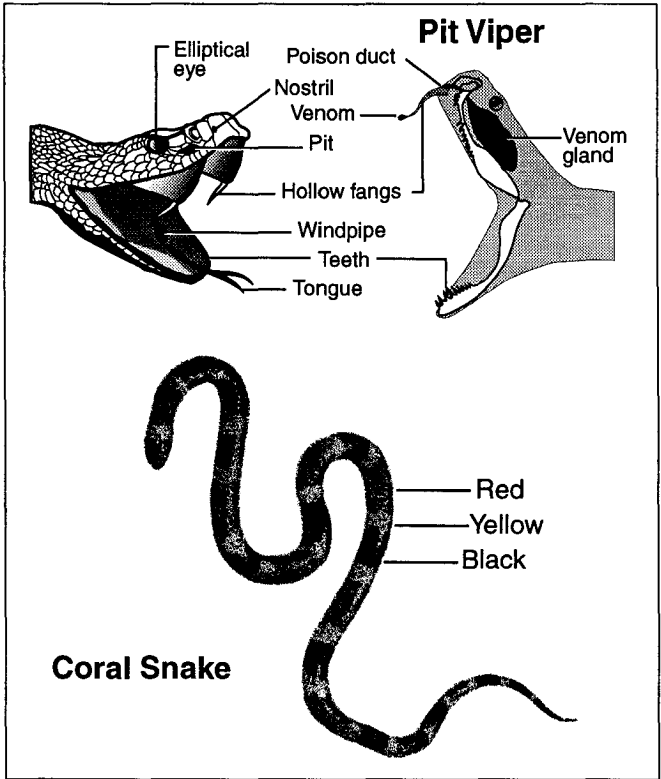

5. Probe areas with a hiking stick or long-handled tool before stepping over logs or piles of brush or debris.

6. Use a long bar or pole for moving material and timbers that have been stacked or piled. Never put your hands under any stored material and be especially cautious when moving rocks.

53.31a – First Aid for Snake Bites. Snake bites in the United States are rarely fatal when medical care is sought early and appropriate antivenin is readily available.

1. Avoid panic.
2. Immobilize the bitten extremity and obtain medical assistance.
3. If you are alone when bitten, walk slowly, resting periodically and using a makeshift crutch if the lower extremity is involved. Again, keep activity to a minimum.

53.4 – Spiders. Few spiders in the United States have venom that cause death. But the bites of the black widow and the brown recluse spiders can be fatal. Both spiders are found in most areas of the United States. The bite of the black widow is the more painful and often the more deadly of the two. Both prefer dark, out-of-the-way places where they are seldom disturbed. Be alert for these spiders in basements, garages, barns and other outbuildings, woodpiles and gardens, and under stones, logs, and vegetation.

1. **Aggressive House Spider.** Another dangerous spider is the aggressive house spider. The spider got its name because it readily bites when cornered or threatened. Its bite is not fatal but is serious and requires immediate medical attention. The light brown spider's body is in two segments that together are about half an inch (12-3/4 mm) long, excluding its hairy legs. This spider is among the most common spiders found in buildings. It rarely climbs vertical surfaces and is usually found on the ground or lower floors, especially in cool moist window wells and basements.

2. **Female Black Widow Spider.** The female black widow is shiny black with a red hourglass mark on the stomach. The female's body is about half an inch (12-3/4 mm) long, and the male is less than half this size. The initial bite may be sharply painful, but many bites are not recognized initially.

3. **Brown Recluse Spider.** The brown recluse is light brown with a darker brown violin shaped marking on the top of its 1/3 inch to 2/3 inch (8-15 mm) body. Brown recluse spiders are most active at night from spring through fall, emerging from woodpiles, rat nests, and other dark, dry environments. The bite can vary from a

mild and transient skin irritation to more complicated kidney and other disorders, and even death. Refer to exhibit 01 for identification.

4. **Spider Bites.** The aggressive house spider has a bite often confused with that of a brown recluse spider. At first the bite produces a very slight sensation. A small hard area appears within 30 minutes or less and is surrounded by an expanding reddened area of 2 to 6 inches (51-153 mm) in diameter. The area will blister and eventually break and ooze serum. Although the ulcer scabs over, tissue beneath the scab may continue to die. The loss of tissue

53.4 – Exhibit 01 – Spiders

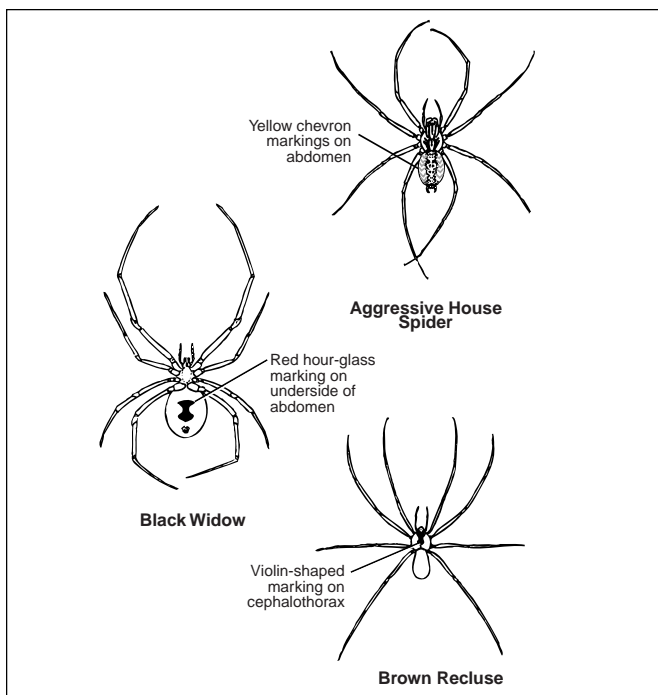

may become so severe that surgical repair is needed. Similar to the necrotic bite of a brown recluse spider (a necrotic bite causes tissue to die), the resulting lesion heals slowly, frequently leaving a permanent scar.

The most common spider bite symptom is a severe migraine headache, sometimes occurring within 30 minutes, usually within 10 hours. The headache may persist for 2 to 7 days and is sometimes accompanied by nausea, weakness, tiredness, temporary loss of memory, and vision impairment.

Signals of a spider bite include:

- a. Nausea and vomiting.
- b. Difficulty breathing and swallowing.
- c. Sweating and salivating profusely.
- d. Irregular heart rhythms
- e. Severe pain and swelling in the bite area.
- f. A mark indicating a possible bite.

5. **First Aid for Spider Bites.**

- a. Wash the area with soap and water.
- b. Apply a cold pack.
- c. Seek medical care as soon as possible to receive an antivenin.

53.5 – Scorpions. Scorpions in the United States are divided into two groups based on the severity of their sting. Scorpions whose venom can be lethal are found in the desert areas of Arizona, New Mexico, California, and Texas, as well as along the northern shore of Lake Mead in Nevada. The venom of these scorpions contains neurotoxins that produce systemic effects, as well as local burning and pain, which can be accentuated by tapping over the envenomed area (tap test). All other scorpions in the United States produce a local reaction that consists of painful swelling and burning with a discoloring of the skin.

Today, death from the sting of a “lethal” scorpion is preventable. Proper care includes washing the wound, applying a cold pack, and getting medical help as soon as possible to receive antivenin.

Scorpions are nocturnal feeders and most live above ground and hide in old stumps, lumber piles, firewood, loose bark on fallen trees, ground debris, or crevices during the daytime.

When working in scorpion and spider areas, be aware and take these precautions:

1. When camping, always inspect in and under sleeping pads, sleeping bags, tarps, or other ground covers before use.
2. Always inspect and shake out clothing before wearing.
3. Do not leave work gloves, boots, jackets, or hats on the ground.
5. Always inspect outdoor toilets before use.
6. Never walk around in the dark without wearing shoes or boots.
7. Always have a flashlight for inspecting outhouses, clothing, and bedding.
8. Always inspect logs, stumps, rocks, and any other areas before sitting down.
9. When working in hot, dry areas, be especially watchful when using shady spots for rest breaks.
10. Before use, inspect those items that have been stored in the shade while working.
11. Always wear gloves (leather preferred) when moving or handling lumber, firewood, trash, or debris that could hide or contain spiders or scorpions.

If an area that was stung or bitten shows rapid inflammation and pain, or the person bitten or stung develops other symptoms, such as chills, fever, joint pains, nausea, or vomiting, seek medical attention immediately.

53.6 – Insect Stings and Bites.

53.61 – Honey Bees. The honey bee is one of the few domesticated insects that is maintained in hives. Numerous species of honey bee exist. The Italian honey bee, a common strain of Europe, is also widespread in the United States. Wild honey bee colonies usually nest in hollow trees or crevices in rocks but may nest in walls of occupied buildings.

An event of considerable health concern has been the spread of the Africanized honey bee. This strain is characterized by large populations (one queen may lay tens of thousands of eggs), frequent swarming, nonstop flights of at least 12 miles (19 km), and a tendency toward mass attack following minimal provocation.

1. Single stings from any of these insects generally do not require medical attention. There may be an immediate sharp pain followed by redness and swelling. For mild bee stings, application of ice packs often gives relief. Honey bees and yellow jackets occasionally leave their stinger in the wound. Stingers should be scraped or brushed off with a sharp-edged instrument. Do not remove stingers with tweezers, which may squeeze the attached venom sac and worsen the injury.

2. Some individuals are sensitized to bee and wasps stings and may react with a widespread rash, asthmatic breathing, tissue swelling, a fall in blood pressure, or sometimes unconsciousness. Employees with a history of allergic reactions to insect stings should carry an appropriate emergency kit prescribed by a physician and wear medical identification tags. Such employees should also inform supervisors and co-workers of their situation and what assistance, if any, is appropriate for an allergic reaction.

53.61a – Safety Guidelines.

1. For outdoor field work, always wear appropriate field attire – long sleeved shirts, long trousers, and appropriate boots (identified in the JHA). It is recommended to tuck trouser legs into socks.

2. Wear appropriate light-colored clothing, including socks. Avoid wearing leather. When defending their nests, bees target objects that resemble their natural predators (such as bears and skunks). They tend to go after dark, leather, or furry objects. Bees see the color red as black so fluorescent orange is a better work clothing choice than red.

3. Avoid wearing scents of any kind. Bees communicate by scent and tend to be very sensitive to odors. Avoid strongly scented shampoo, soaps, perfumes, after-shaves, and heavily scented gum. If riding, avoid the use of lemony or citrus-smelling fly control products on your horse.

4. Avoid identified nests and never poke or throw objects at nests. If a nest location could affect people, inform your supervisor or local authorities even if the bees appear to be docile.

5. If attacked, shield your face with your arms and leave the area.

53.61b – Africanized Honey Bees. These bees are docile when seeking out a new nestsite and establishing a nest. In the field, European honey bees and Africanized honey bees are visually indistinguishable, but the following are behavioral patterns typical of the Africanized honey bees:

1. Africanized honey bees display random nest selection. They may nest in areas not normally selected by European honey bees; however, they have been known to take over European honey bee nests.

2. After developing brood and honey stores, Africanized honey bees become extremely defensive and easily agitated.

3. When in established hives, Africanized honey bees quickly respond in large numbers to nearby stimuli, such as a loud noise created by chain saws or working machinery.

4. Africanized honey bees are attracted mainly to the face and neck area. If attacked, get away quickly while covering the head and neck area. Do not stand still, swat, or try to hide underwater. Seek inside shelter, such as buildings or vehicles.

5. If stung, remove stinger(s) by scraping sideways, not pulling. Seek medical attention if an employee has:

- Allergic reaction.
- Systemic reaction.
- Multiple stings (15 or more).

53.62 – Mosquitoes. When massive flooding occurs, a significant increase in mosquito populations also increases the chances of an outbreak of encephalitis. Ticks that ingest mosquitoes may also transmit encephalitis to humans. Encephalitis produces influenza-like symptoms, including headaches, lethargy, fever, double vision, extreme muscle weakness, confusion, tremors, or seizures.

Use of repellents containing DEET or brand name products, such as Duranon, is recommended. Note: Duranon is applied to clothing only, not directly to the skin.

53.7 – Bears, Mountain Lions, and Other Animals.

53.71 – Bears.

1. **Black Bear.** The most common bear encountered by field-going Forest Service employees is the black bear. Black bears are the most numerous and widely distributed of all North American bears. They occur in more than 30 of the lower 48 states, from Maine to Florida and from California to Washington. They also occur throughout Canada and Alaska, extending up to treeline below the Arctic Circle.

Injuries as a result of close encounters with black bears are extremely rare and if they occur, usually are not life threatening. In a survey of 500 people injured by black bears, at least 90 percent resulted in minor scratches or bites inflicted by bears that were either conditioned to human foods or habituated to human presence.

2. **Grizzly Bear.** The grizzly (brown) bear ranges from Alaska through western Canada, with remnant populations located in relatively undeveloped lands, primarily in the northern Rocky Mountains. Attacks by grizzly bears are rare and sporadic. Female grizzly (brown) bears are extremely aggressive in defense of their young.

3. **Training on Bear Behavior and Safety.** Because of the unpredictable disposition of all bears, field-going employees should receive training to the extent they will be exposed.

Bear-behavior training should, as a minimum, include these elements:

- a. Differences between black and grizzly (brown) bears.
- b. Identification of bear signs (tracks, scat, scrapes, kills, and claw marks).
- c. Bear behavior and body language.
- d. Precautions to keep a field camp safe from bears. Ensure food and food containers are stored in an acceptable manner.

- e. Techniques to avoid bear encounters while hiking, working, camping, or other outdoor activities.
- f. How to respond if attacked by a bear (sec. 51.21 and 51.3).
- g. Aerosol defensive sprays use, storage, and transportation (refer to sec. 51.3 for the requirements).

4. **Safety Practices.** Employees must understand the importance of keeping their distance from any animal that is eating or mating, appears to be sick or injured, or is with its young. If an animal seems unafraid, abnormally aggressive, or drunk, it may be a sign of rabies (sec. 53.73b). Leave the scene and report the incident to the appropriate authority.

Most bears prefer to stay away from humans. Given the chance, bears avoid people and go about their business.

53.72 – Mountain Lions. Generally, mountain lions are solitary, quiet, elusive animals. They are most active from dusk to dawn, although they travel and hunt in daylight. Working with other employees and making noise, reduces the chance of surprising a lion. In the event of a confrontation, employees should:

1. Give the lion a way to escape.
2. Talk calmly, yet firmly.
3. Stop or back away slowly. Never crouch, try to hide, turn away, or run away.
4. Try to appear larger by raising arms or an object over the head.
5. If the lion behaves aggressively, throw stones, branches, or whatever can be reached without crouching down or turning away.
6. Fight back if attacked. Shout loudly. Try to remain standing. If down, try to get up. Protect the head and neck with hands and arms.

53.73 – Other Animals and Hazards.

53.73a – Hantavirus. Hantavirus is a cause of acute pulmonary disease and death in many regions of the United States. The primary carrier is the deer mouse. Other rodents that may be carriers include squirrels, rats, chipmunks, and other kinds of mice.

Transmission occurs by inhalation of the aerosolized virus when dried materials contaminated by rodent excreta are disturbed; introduction into broken skin, eyes, nose, mouth; or ingestion of contaminated food or water. People have also become infected after being bitten by an infected animal.

1. **Unit Planning and Safety Procedures.** Each unit shall develop a Hantavirus Prevention Action Plan and make it available as a resource for writing site-specific JHAs. Contact State and county public health agencies for local recommendations. The Center for Disease Control and Prevention (CDC) has issued guidelines for dealing with hantavirus.

2. **Training.** Ensure that employees receive training in hantavirus awareness.

3. **General Employee Safety Practices.** In most cases, employees shall:

- a. Treat all rodents as if they carry the virus.
- b. Seek early treatment if there was possible contact with carriers and signs of potential symptoms. Symptoms may appear 1 to 6 weeks (usually 2 to 3) after contact and include fever, nausea, headache, muscle aches, cough, and increasing acute respiratory trouble.
- c. Avoid direct contact with rodents (live or dead), their droppings, urine, saliva, nests, or items that may be contaminated. Do not feed mice, chipmunks, or other rodents.
- d. Remove aerosolized virus. Ventilate closed buildings or areas inside buildings by opening doors and windows for at least 30 minutes. Use an exhaust fan or cross ventilation, if possible. Leave the area until the airing-out period is finished.
- e. Always wear rubber or disposable gloves when cleaning areas where rodents have been.

- f. Do not sweep or vacuum until the area has been soaked with disinfectant (bleach solution). Carpets and furniture should be disinfected or shampooed. Launder bedding and clothing with detergent and warm/hot water. Dry the clothing and bedding in a dryer to aid in disinfection.
- g. Where there is heavy rodent infestation, wear high efficiency National Institute of Safety and Health (NIOSH) certified particulate air respirators (sec. 21.13), disposable coveralls, rubber boots or disposable shoe covers, disposable head cover, two pairs of latex gloves, and eye protection, such as goggles.

4. **Specific Employee Safety Practices.** Ensure that employees involved in live trapping for research studies are competent in wild animal capture techniques developed to abate hantavirus exposure, and that they comply with the following:

- a. Wear required PPE: high efficiency particulate air respirators (sec. 21.13), disposable coveralls, disposable shoe covers, suitable eye protection, and two pair of latex gloves.
- b. Decontaminate live traps by soaking in a virucide. Follow precautions for accidental exposure listed on the virucide label and the Material Safety Data Sheet (MSDS).
- c. Treat as biohazardous material waste and properly dispose of items (such as capture bags and gloves) that cannot be completely disinfected. Except in remote areas, burying and incineration are not appropriate means of disposal (sec. 53.01).

53.73b – Rabies. The rabies virus is an acute, often fatal, viral disease most commonly transmitted through the saliva of an infected mammal and, less commonly, by aerosols (para. 3).

1. Employees should avoid any wild animal (especially raccoons, skunks, foxes, and bats) that appears to have lost its fear of humans or is behaving abnormally. Abnormal and aggressive behavior in domestic animals is also a warning sign to exercise caution.

2. Early treatment is crucial. Physical symptoms include pain at the wound site, fever, headache, malaise, apprehension, difficulty swallowing, muscle spasms, and paralysis. As the disease

progresses, victims may become disoriented and agitated and begin hallucinating.

3. Transmission of the rabies virus by inhalation of aerosols (created from saliva, secretions, and excretions of bats in a dark, humid environment) has also occurred. Employees involved in investigation of bat-roost sites (caves, mines, and buildings) or who have other work projects/activities in locations where bats are commonly found shall:

- a. Obtain a pre-exposure rabies vaccination and a tetanus shot.
- b. Wear appropriate PPE, such as light cut-resistant gloves, depending on the bat species.
- c. If bitten, cleanse the wound with soap, water, and disinfectant; seek medical attention; and record the date and location of exposure.

54 – ENVIRONMENTAL HAZARDS.

54.01 – References.

1. Sharkey, Brian J. 1997. Fitness and Work Capacity, Second Edition. 9651-2812-MTDC. Missoula Technology and Development Center, Forest Service, Missoula, MT.

2. National Fire Protection Association. Lightning Protection Code 780. Quincy, MA.

54.1 – Radiation. (FSM 6740). Any activity that involves radioactive materials or x-rays, whether or not under license from the Nuclear Regulatory Commission, shall be performed by competent persons specially trained in the proper operation of such equipment.

For materials used under commission license, only licensed persons or competent persons under the direction and supervision of the licensee shall perform such work. The standards are in 10 CFR Part 20.

When the workplace contains potential exposures to radioactive material, a radiation safety program shall be established. The program shall as a minimum consist of:

1. Personal monitoring equipment.
2. Radiation detection instruments.
3. Leak testing.
4. Maintenance.
5. Transportation of spray to field locations.
6. Appropriate PPE.
7. Operating and emergency procedures.

Only qualified and trained employees shall be assigned to install, adjust, and operate laser equipment. Proof of qualification shall be in the operator's possession at all times.

54.11 – Solar Ultraviolet Radiation. Radiation intensity varies with numerous factors, including time of day, altitude, latitude, and season. About 80 percent of the ultraviolet (UV) rays reaching the Earth's surface do so between 9 a.m. and 3 p.m., with peak hours of exposure generally between 10 a.m. and 2 p.m. Employees who spend much of their workday outside should be cautioned about the short- and long-term risks of UV exposure.

To minimize UV exposure:

1. Keep exposed skin covered by wearing a hat, a bandanna, and a long-sleeved shirt (with sleeves rolled down and collar turned up).
2. Wear sun glasses that filter out 100 percent of the UV rays. The use of non-UV protected sunglasses or photogrey glasses can increase the chance of UV damage to the retina and are not recommended.
3. Provide and use protective sunscreen lotion, cream, oil, and lip balm as identified in the JHA.
4. When possible, stay indoors during the peak exposure time in the summer or find worksites that are shady.
5. Alter work schedules, where appropriate, to avoid peak summer exposure.

6. Where appropriate, alternate workers during the summer months to reduce exposure.

54.2 – Extreme Weather Conditions. Use the buddy system while training and working in extreme weather conditions.

54.21 – Working in Hot Conditions. Individual differences in heat tolerance are related to fitness, hydration, illness, drugs and medication, and fatigue (sec. 54.01).

Heat stress occurs when the body's core temperature rises beyond safe limits. Evaporation of sweat is the body's main line of defense against heat. As sweat evaporates, it cools the body. When water lost by sweating is not replaced, the body's heat controls break down and body temperature climbs dangerously. Three factors that can contribute to heat stress are low or poor physical fitness, excess weight, and hypertension (ex. 01).

1. Fit workers adjust or acclimate to work in the heat twice as fast as unfit workers (4 days compared to 8). Be especially careful the first 2 to 3 days.
2. Schedule the hardest work during the cooler hours of the day. Set a moderate work pace. As the temperature increases, stop

54.21 – Exhibit 01 – Heat Stress Chart

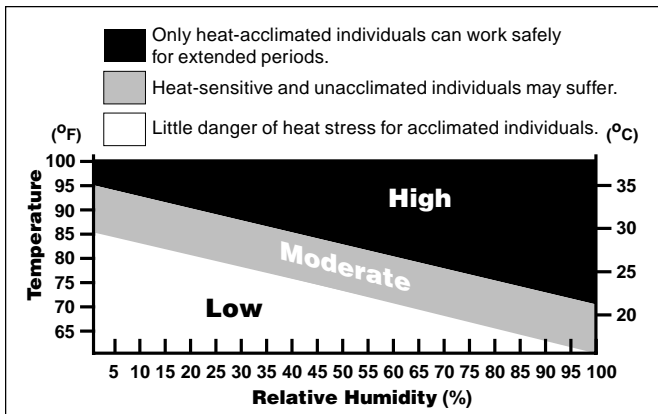

for frequent rest periods of at least 15 minutes. Relax in cool locations, where possible.

3. Always have an adequate supply of water available and ensure that employees are getting their needed liquids. Plan ahead for drinking water; don't allow water to run out before resupplying (ex. 02).

To prevent dehydration:

- a. Drink 8 to 16 ounces (200 to 400 milliliters) of water before work.
- b. Take frequent drinks during each hour of work (1 quart or 1 liter per hour).
- c. Drink as much as possible at lunch and the evening meal.
- d. Continue replacing fluids throughout the evening.
- e. Limit caffeine drinks, such as coffee or cola.
- f. Avoid alcoholic drinks.

4. Provide well-planned meals and healthy snacks, which are vital to maintain work capacity and to avoid heat disorders through adequate replacement of water, salt, and potassium. Employees

54.21 – Exhibit 02 – Guidelines for Water Requirements

| <i>Activity</i> | <i>Typical Duties</i> | <i>Quarts (Liters) Per Day at Temperatures:</i> | |
|-----------------|---|---|--|
| | | <i>Less Than 80 °F (26 °C)</i> | <i>More Than 80 °F (26 °C)</i> |
| Light | Desk work, fire camp-related activities | 6 | 9 |
| Moderate | Hiking, receiving and distributing supplies in fire camps | 9 | 12 |
| Heavy | Strenuous work, digging fire line, prescribed burning | 12 | 15 |

may want to eat less. Carbohydrate/electrolyte beverages can help maintain energy and work output during long periods without food or snacks. Salt in foods and ample use of the salt shaker provide sodium. Do not use salt tablets. Include potassium-rich foods, such as bananas and citrus fruits. High-protein foods (such as meat) increase metabolic heat production and water loss, and are not recommended.

5. Wear hardhats, as they provide a very effective air conditioning system.

6. Prevent sunburn by wearing lightweight, light-colored loose clothing, which allows air to circulate and sweat to evaporate and offers protection from direct sun. Bare skin absorbs the sun's radiant heat and raises body temperature.

7. Bathe or wash thoroughly each day to keep pores and hair clean. Dirty, clogged skin and matted hair restrict heat dissipation.

8. ***During periods of continued extreme temperatures (90 °F/32 °C or above), ensure that supervisors monitor employees and that employees watch each other for signs of heat-stress disorders, including heat cramps, heat exhaustion, and heatstroke.***

- a. Heat cramps are identified by muscular pains and cramps, with leg and abdominal muscles usually affected first. Remedies include stretching and gently massaging cramped muscles and applying a heating pad or hot water bottle to help relieve muscle spasms.
- b. Heat exhaustion is characterized by fatigue, weakness, and collapse. The skin becomes pale, cool, and clammy, accompanied by nausea, dizziness, a throbbing headache, breathing problems, and diarrhea. Recommended actions include moving to a cool, shady place, lying with the feet raised 8 to 12 inches (204 to 306 mm) above the head, and loosening clothing and applying cool compresses to the skin. If there is no improvement quickly, seek medical attention at once.
- c. Heatstroke is a medical emergency. Unacclimatized employees are especially prone to heatstroke. Symptoms are confusion, high body temperature, hot (often dry) skin, rapid pulse, convulsions, loss of conscious-

ness, and coma. Lack of sweating is one sign of imminent heatstroke. Do not delay treatment, it must be immediate. Cool the body down quickly. Administer fluids and transport the victim to a medical facility as quickly as possible.

54.22 – Working in Cold Conditions. The best defense against frostbite and hypothermia is to avoid exposure. Recognize hypothermia-producing weather and prepare for it. Prevention is the best tool. Always check weather conditions and be familiar with the area before trips. Be prepared and pack a survival kit to be carried by each person.

Exposure to hazards associated with the cold can occur when employees are inside (such as cold storage areas and tree coolers), as well as outside. Factors that put employees more at risk include being older or overweight, having allergies or poor circulation, smoking, drinking, and taking medications, such as sedatives.

All persons who work outdoors in cold climates are encouraged to have cold weather survival training (sec. 11.3). Where work or activities are planned during extremely cold weather the JHA shall address the specific conditions anticipated, including essential PPE. Key items for winter survival are:

1. Get adequate rest.
2. Always anticipate bad weather. Carry additional warm clothing with you. Dress for the conditions in layers of loose, dry clothes; polypropylene or wool underneath, with windproof and waterproof material on top. Ensure that your hands, feet, face, neck, and head are covered and well protected.
3. Keep active to maintain the body's metabolism and keep your body temperature high.
4. Prevent dehydration by drinking warm water. Avoid drinking cold water, snow, or ice. Avoid caffeinated beverages.
5. Set up camp early and prepare for dropping night temperatures. Find shelter and firewood before dark.
6. Eat balanced meals and high energy snacks.

7. Travel in pairs as a minimum. Never travel alone in isolated areas (sec. 11.1). A line officer or other competent person must approve and document the assignment of employees to work alone in undeveloped areas (sec. 21.14).

54.22a – Frostbite. Frostbite is generally brought on by direct contact with a cold object or exposure of a body part to cold air. Body parts most often affected are the nose, ears, cheeks, fingers, and toes. Test for circulation and sensation regularly by wiggling fingers and toes. Watch for signs of frostbite in yourself and co-workers. Major factors causing frostbite are wind and water chill.

1. Frostbite may develop slowly and go undetected until the affected part or parts become white. As the cooling process continues, numbness replaces any sensation of cold or discomfort.

2. If the early stages of frostbite go untreated, the affected part or parts take on a waxy appearance and feel frozen to a gentle touch; however, when the skin is pressed firmly, it feels soft and pliable beneath the frozen area. At this stage of frostbite, the affected person must be moved to a dry covered area, and the affected part or parts gently handled. If transportation to a hospital is delayed, apply steady warmth by submerging the body part or parts in warm water. Always follow up with medical care.

3. The next step is referred to as deep frostbite. Muscles, bones, deep blood vessels, and organ membranes can become frozen. The affected part becomes blotchy blue or gray, and the tissue feels frozen on the surface and when pressed firmly. For this stage of frostbite follow these steps:

- a. Transport the victim immediately to a hospital for medical care.
- b. Gently cover the affected part or parts with dry blankets or clothing.
- c. Do not rub or chaff the frostbitten part or parts.
- d. If the tissue is frozen, keep it frozen until care can be initiated.
- e. Do not initiate thawing procedures if there is any danger of refreezing. Keeping the tissue frozen is less dangerous than submitting it to refreezing.

54.22b – Hypothermia. Another cold hazard is hypothermia, a condition of subnormal body temperature. Lowering the internal core temperature of the body leads to mental and physical collapse. Hypothermia is a medical emergency. The three components of weather that affect cooling of the body core are temperature, wind, and moisture. Other factors that can cause or aggravate hypothermia include injuries, immobilization, immersion in water, lack of proper clothing or shelter, low blood sugar, and fatigue.

Hypothermia usually occurs on a cold, wet windy day with temperatures at or above freezing. Most hypothermia cases develop between 30 °F (-1 °C) and 50 °F (10 °C). Refer to exhibit 01 for a wind chill index.

Hypothermia symptoms begin with feeling cold, experiencing pain in the extremities, and shivering as the body tries to raise its temperature. Other symptoms include numbness, muscle stiffness (especially in the neck, arms, and legs), poor coordination, drowsiness, slow or irregular breathing and heart rate, cool skin, and puffiness in the face. Thinking processes slow and victims become apathetic and disagreeable.

As the body core cools further, mental function is impaired to a far greater extent, leading to confusion, disorientation, and lethargy. Slurred speech and loss of vision occur just prior to terminal coma. Hypothermia is a medical emergency.

1. Call for medical help. Transport the victim to a hospital for care as soon as possible.
2. Give artificial respiration when necessary.
3. Move the victim into a warm area. If shelter is not available, build a fire. Prevent further heat loss.
4. Get the victim out of frozen, wet, or tight clothes.
5. Bundle the victim in warm clothes, blankets, or sleeping bag.
6. If the victim is mildly impaired, give the victim warm liquids (no caffeine or alcohol).
7. If the victim is semiconscious, try and keep the person awake. Remove the victim's clothing and put the victim in a sleep-

54.22b – Exhibit 01 – Wind Chill Index

| | | Actual thermometer reading (°F) | | | | | | | | | | | |
|---|----|---|-------------------|-----|-----|-----|-----|--------------|------|------|------|-----|-----|
| | | 50 | 40 | 30 | 20 | 10 | 0 | -10 | -20 | -30 | -40 | -50 | -60 |
| <i>Wind speed (mph)</i> | | <i>Equivalent temperature (°F)</i> | | | | | | | | | | | |
| Calm | 50 | 30 | 20 | 10 | 0 | -10 | -20 | -30 | -40 | -50 | -60 | | |
| 5 | 48 | 27 | 16 | 6 | -5 | -15 | -26 | -36 | -47 | -57 | -68 | | |
| 10 | 40 | 16 | 4 | -9 | -21 | -33 | -46 | -58 | -70 | -83 | -95 | | |
| 15 | 36 | 9 | -5 | -18 | -36 | -45 | -58 | -72 | -85 | -99 | -112 | | |
| 20 | 32 | 4 | -10 | -25 | -39 | -53 | -67 | -82 | -96 | -110 | -124 | | |
| 25 | 30 | 0 | -15 | -29 | -44 | -59 | -74 | -88 | -104 | -118 | -133 | | |
| 30 | 28 | 13 | -2 | -33 | -48 | -63 | -79 | -94 | -109 | -125 | -140 | | |
| 35 | 27 | 11 | -4 | -35 | -49 | -67 | -82 | -98 | -113 | -129 | -145 | | |
| 40 | 26 | 10 | -6 | -37 | -53 | -69 | -85 | -100 | -116 | -132 | -148 | | |
| (Wind speeds greater than 40 mph have little additional effect) | | Little danger (for properly clothed person) | Increasing danger | | | | | Great danger | | | | | |
| | | <i>Danger of freezing exposed flesh</i> | | | | | | | | | | | |

ing bag with another person, allowing the body heat to warm the victim. Do not give liquids until fully conscious.

8. Transport the victim to the nearest hospital. Keep the person lying down and as still as possible.

9. Do not assume the hypothermia victim is dead even though the person may appear to be. There may be no detectable heart-beat, breathing, or other signs of life. CPR can be given en route to a hospital.

54.23 – Lightning and Thunderstorms. The most dangerous period for thunderstorms with cloud-to-ground lightning is from March through August. The mature stage of the storm may be marked on the ground by a sudden reversal of wind direction, a noticeable rise in wind speed, and a sharp drop in temperature. Heavy rain, hail, and lightning occur only in the mature stage of a thunderstorm. Keep informed; know what the storm is doing. During a thunder storm:

1. Do not use radios, telephones, plug-in electrical equipment, or plumbing fixtures.
2. Turn off generators and electrical equipment.
3. Put down all tools. Caulk boots are particularly good grounding agents and should be removed.
4. Do not handle flammable materials in open containers.
5. Stay in your vehicle unless it is metal-tracked, has a non-metal top, or is open.
6. If you are on a metal-tracked vehicle, dismount and seek appropriate shelter. Get away from water tanks, ponds, streams, lakes, and swimming pools. Avoid parking lots, tennis courts, athletic fields, and golf courses.
7. Get under a steel bridge, but never touch the steel and never sit or stand on damp ground.
8. If boats are in use, have them docked. Get out of boats and away from the water.
9. Ground and anchor all aircraft.

10. Take shelter in a building, if one is available. Choose a building with lightning protection in preference to a small, unprotected building. Close the doors and windows, if possible. If that is not possible, stay away from open doors and windows, and areas on top of buildings. Stay away from fireplaces, radiators, stoves, metal pipes, and sinks.

11. If no buildings are available, your best protection is a cave, ditch, tunnel, canyon, or head-high clumps or trees in open forest areas.

12. When there is no shelter, avoid tall objects such as lone trees. If only isolated trees are nearby or if you are in open country, the best protection is to make yourself as small a target as possible. Drop to your knees, bend forward with your hands resting on your knees, and keep a distance of twice the height of the nearest tree between you and the tree. To minimize the flow of the current, keep your feet together. Keep away from wire fences, telephone lines, electrically conductive objects, and railroad tracks.

13. ***Avoid the tops of ridges, hilltops, wide-open spaces, ledges, out-crops of rocks, and sheds or shelters in exposed locations.*** Avoid grouping people together.

14. ***Move away from horses and stock.***

15. Advise crew members that if they feel an electrical charge, if their hair stands on end, or their skin tingles, a lightning strike may be imminent.

Persons struck by lightning may receive a severe electrical shock and burns, including entry and exit wounds. These individuals carry no electrical charge after exposure to lightning and can be touched safely. Victims of a lightning strike may suffer respiratory and/or cardiac arrest. Therefore, administer CPR immediately if needed and first aid, as required.

Note that an individual in full-cardiac arrest is a medical emergency and must be transported to an advanced life-support medical facility as quickly as possible.

Where there are multiple lightning strike victims, render emergency medical treatment first to individuals who are unresponsive and

next to those with vital signs who exhibit the most life threatening injuries.

54.24 – Tornadoes. A severe thunderstorm may spawn a tornado, which is a violently rotating column of air that descends from a cloud system. Most tornadoes occur during the mid-afternoon or early evening (3 p.m. – 7 p.m.) and move from the southwest to the northeast at speeds ranging from stationary to 70 miles an hour.

While hail may or may not precede a tornado, the area adjacent to large hail is often where strong to violent tornadoes are most likely to occur. When large hail begins to fall, a tornado may be nearby. Seek appropriate shelter. Once the hail has stopped, remain in a protected area until the storm has moved away, usually 15 to 30 minutes after the hail ceases. During a tornado:

1. Do not attempt to flee to safety by vehicle. Seek sturdy shelter, such as a building; a ditch or ravine offers better protection than a vehicle.
2. Stay away from windows, exterior doors, and outside walls.
3. Go to storm cellars or well constructed basements, which offer the greatest protection from tornadoes, or to small interior rooms, such as a closet or bathroom, which provide safety from flying debris and are less likely to experience roof collapse.
4. If caught in a timbered area during periods of high winds or immediately after a windstorm, get into a natural opening large enough to give protection from falling trees and limbs.

54.25 – Flash Floods. Flooding occurs seasonally when rains, coupled with melting snows or torrential rains associated with tropical storms, drain into small tributaries and fill river basins with too much water, too quickly. Flash flood waves can roll boulders, tear out trees, destroy buildings and bridges, and create new channels. When a flash flood is imminent, act quickly:

1. Do not camp or park your vehicle along streams and washes, particularly during threatening conditions.
2. Avoid areas subject to flooding. This includes dips, low-lying areas, canyons, and washes.

3. Avoid already flooded and high velocity flow areas. Do not attempt to cross a swift flowing stream on foot where water is above your knees.

4. Do not attempt to drive over a flooded road where you do not know the depth of water before crossing. The road bed may not be intact under the water.

5. If your vehicle stalls, abandon it immediately and seek higher ground.

6. Be especially cautious at night when it is harder to recognize flood dangers.

54.3 – Altitude-Related Problems. High altitude (8,000 feet or 2,438 meters and higher above sea level) affects a person's ability to take in, transport, and utilize oxygen, thus affecting work capacity. During acclimation, employees working in high altitudes should work slower and take frequent breaks to avoid excessive fatigue. Eat a high-carbohydrate diet for added energy and take special care to maintain hydration since altitude hastens fluid loss.

Individuals vary in their ability to acclimatize; some adjust quickly, without discomfort, while acute mountain sickness (AMS) develops in others.

AMS is most commonly misdiagnosed as a viral flu-like illness, hangover, exhaustion, or dehydration. The incidence and severity of AMS depend on the rate of ascent, altitude attained (especially the sleeping altitude), length of exposure, level of exertion, and inherent physiologic susceptibility. AMS can be classified as mild, moderate, or severe on the basis of symptoms (ex. 01). Treatment for AMS includes descending to a lower altitude and the administration of oxygen, if available.

Other problems related to altitude include decrease in temperature and the effects of cold (sec. 54.22), ultraviolet penetration increasing the risk of sunburn and skin cancer, and snowblindness (sec. 54.11).

55 – TEMPORARY CAMPS. The requirements for health and safety in temporary labor camps, which accommodate large numbers of

54.3 – Exhibit 01 – Acute Mountain Sickness

| <i>Severity</i> | <i>Symptoms</i> |
|-----------------|---|
| Mild | Headache, anorexia, nausea, fatigue. |
| Moderate | Unrelieved headache, vomiting, irritability, apathy. |
| Severe | Disorientation, impaired judgment, altered consciousness, difficulty breathing at rest, bluish discoloration of the skin, ataxia (inability to coordinate muscular movements). Coma may ensue within 24 hours of the onset of ataxia. |

workers and can be reached by highway or forest road, differ from those for remote-site camps, which serve only a few employees and typically cannot be reached by road.

The following direction in sections 55.01 to 55.11 concerning water supply, sanitation, and food service operations applies to a large temporary labor camp. Safety hygiene and other concerns of remote camps are addressed in section 55.12.

55.01 – Authority. The authority for sanitation and temporary camps is in Title 29, Code of Federal Regulations, section 1910.141 and 1910.142.

55.06 – Reference. Red Cross – Youth Camp Director's Safety Guide. Swimming and Water Safety. Stock No. 321147 and Stock No. 321215. National Safety Council, 425 N. Michigan Ave., Chicago, IL 60611.

55.1 – Procedures. The JHA shall identify fire prevention/suppression and emergency evacuation procedures.

1. Fire extinguishers shall be provided, located, identified, and readily accessible to employees.
2. Smoke detectors shall be provided as determined in the JHA.

55.11 – Temporary Camp Requirements.

55.11a – Water Supply.

1. Provide an adequate and convenient water supply, approved by the appropriate health authority, for drinking, cooking, bathing, and laundry purposes.
2. Never assume water is safe. As a general policy, use only potable water from a tested and approved source.
3. Store water in safe containers and label them.
4. Ensure that drinking water is dispensed in individual sanitary containers, such as paper cups, if fountains are not available. One-for-all canteens or drinking cups and other common utensils are prohibited (29 CFR 1910.142). Where single-service cups are supplied, provide both a sanitary container for unused cups and a receptacle for used cups.

55.11b – Other Requirements.

1. Install all heating, cooking, and water heating equipment in accordance with State and local ordinances, codes, and regulations governing such installations.
2. If a camp is used during cold weather, provide adequate heating equipment.
3. Provide beds, cots, bunks, and suitable storage facilities, such as wall lockers, for clothing and personal effects.
 - a. Ensure that each room for sleeping contains at least 50 square feet (15-1/4 m²) of floor space per occupant and that shelters have at least 7-foot (2 m) ceilings.
 - b. Place beds no closer than 36 inches (1 m), both laterally and end-to-end, and at least 12 inches (1/3 m) off the floor.
 - c. Space double-deck bunks no closer than 48 inches (1-1/5 m), both laterally and end-to-end. The minimum amount of clear space required between the upper and lower bunk is 27 inches (1/2 m). Triple-deck bunks are prohibited.

4. Ensure that living quarters have windows. The window area must total at least one-tenth of the floor area. Half of the windows must open for ventilation.

- a. Doors and windows must be screened with 16-mesh material.
- b. Doors shall be equipped with self-closing devices.

5. Where personnel cook, live, and sleep in the same area, provide 100 square feet (30-1/2 m) per person.

6. Provide sanitary facilities for storing and preparing food.

7. Ensure that floors are level and constructed of wood, asphalt, or concrete. Wooden floors shall be smooth and tight and kept in good repair.

- a. Wooden floors must be elevated at least 1 foot (1/3 m) above the ground. Back filling around outer walls is permissible in areas subject to extreme temperatures.
- b. Steps shall have no more than an 8 inch (204 mm) rise and nonslip treads. Where four or more steps are present, handrails are required.

8. Ensure that each camp has a first aid kit(s) available (refer to the Glossary). At least one person must be certified in first aid/CPR.

9. Provide for communications systems. Radio or telephone communications with the field-crew headquarters or other links with the outside are mandatory. Have a daily contact schedule for every camp. Include measures that will be taken in case a reporting schedule is missed.

10. Where camps are near roads, provide a vehicle for emergency use.

55.11c – Camp Sanitation. Construct, operate, and maintain temporary camps according to national and local public health standards (29 CFR 1910.141 and 1910.142).

When living in Government camps or quarters, maintain reasonable standards of personal hygiene and housekeeping. Take effective measures to prevent flies, rodents, and other insects and animals from infesting camps. Keep all places clean to the extent that the nature of the work allows.

1. Place central refuse bins on a hard surface. The refuse bins must meet safety requirements for stability as outlined in American National Standards Institute (ANSI) Z245.3. The refuse bins should display a sign prohibiting children from climbing on units.

2. Collection must be frequent enough to prevent overflow, fly breeding, and odors. Open burning of rubbish and debris is discouraged and is subject to local ordinance.

3. Clean and sanitize cabins and tents weekly or more often as needed.

4. Clean and sanitize kitchens and restrooms daily.

a. Always maintain a supply of soap, hot water, clean towels, and toilet paper.

b. Keep showers, including mats, clean; disinfect them daily.

5. Keep subsistence supplies carefully and properly stored and protected from weather, flies, and rodents.

6. Where toilet facilities are provided for employees:

a. Maintain natural or artificial lighting at all hours of the day and night.

b. Keep toilet rooms sanitary, and clean them daily.

c. Where a sewer is available, connect all camp sewer lines and floor drains from buildings to the sewer.

d. Keep toilet facilities supplied with toilet paper, and ensure that the number of toilets complies with OSHA standards (29 CFR 1910.142 (d)). As a general rule, provide one toilet for every 15 people, but never less than two per camp.

55.11d – Food and Food Service Operations. A properly constructed kitchen and dining hall must be adequate in size and separate from sleeping quarters and lavatories, with no openings leading from living or sleeping quarters into the kitchen or dining hall.

1. Operate food service facilities in accordance with sound hygienic principles. When all or part of the food service is provided, ensure the food dispensed is wholesome and free from spoilage,

and is processed, prepared, handled, and stored to protect from contamination.

2. Ensure that cooks meet State and local health requirements.
 - a. Do not permit any person with a communicable disease, including colds, to prepare, cook, serve, or otherwise handle food, foodstuffs, or materials in any kitchen or dining room. Food handlers shall have clean hands and fingernails and be free from open sores.
 - b. Ensure that persons wash hands thoroughly with soap and water for a minimum of 20 seconds before handling food and engaging in food preparation.
 - c. To prevent food contamination, ensure that persons working in kitchens and dining halls wear hair nets (or caps) and clean clothes.
3. Keep kitchen areas and food storage facilities free of insects, rodents, and pests. Windows, door screens, and rodent-proof food storage facilities are basic requirements.
 - a. Ensure that floors and food preparation surfaces are cleaned daily.
 - b. Use different cutting boards for raw and cooked foods. Plastic ones are easier to clean.
 - c. Scrub containers and utensils used in handling uncooked foods with hot, soapy water before using them with ready-to-serve foods.
4. Inspect cooking facilities frequently for general sanitary conditions and individual housekeeping standards.
 - a. Inspect food storage facilities, including refrigerators, freezers, coolers, cabinets, and vaults, for cleanliness, spoilage, rodent/insect infestation, and food shelf life. Conduct and document food storage inspections weekly.
 - b. Provide filters above grills. Clean the hoods over grills at least weekly to remove grease deposits, and equip them with an automatic fire extinguishing system or grease extractors (Uniform Fire Code Article 13, Section 13.315).
5. Store all perishable food at temperatures that retard spoilage.

- a. Refrigerate or freeze leftovers in small, covered shallow containers within 2 hours after cooking; the quicker the better. Leave airspace around containers to help assure rapid, even cooling. Individual food portions, once served, may be served again only if they are safe and uncontaminated.
- b. Thaw foods in the refrigerator.
- c. Dispose of all moldy, spoiled, or contaminated foods immediately. Throw out all leftovers after 3 days.
- d. Maintain all potentially hazardous food at safe temperatures (ex. 01), except during necessary periods of preparation and service.
- e. Place thermometers in each refrigeration unit and post the proper temperature levels near the thermometer.
 - Keep cold foods cold (below 40 °F/4 °C for refrigerated foods, 0 °F/-17 °C for freezer foods.)
 - Keep hot foods hot (140 °F/60 °C or above until ready to serve).
 - Heat foods thoroughly; a rolling boil for sauces, soups, gravies, and other moist foods; 165 °F/74 °C for all other foods.
- f. Limit food preparation to areas specifically designated for this purpose. Eat prepared food in specified dining areas, not in sleeping areas.
- g. Unless arrangements are made and mutually agreed to, require each employee preparing personal meals to be responsible for cleaning cooking facilities, appliances, and personal cooking and eating utensils after the meal.
- h. In cooking facilities, use or store only such toxic materials as are required to maintain sanitary conditions. Toxic materials shall be identified, stored, and used only in such a manner and under such conditions that do not contaminate food or constitute a hazard to employees. Material safety data sheets shall be available and utilized for their intended purposes.

55.12 – Spike Camps/Remote-sites General Campout. When work projects or activities require camping out, it is important to be well prepared.

55.11d – Exhibit 01 – Safe Food Temperatures

SAFE♥ Food Handling Tips

Safe Temperatures*



Place thermometer in the center of the dish or the thickest part of meat away from bone

Liquid leftovers: soups, gravies, sauces -- a rapid boil

Poultry -- until juices run clear [minimum 165°F (74°C)]

Pork; ground poultry and poultry mixtures

Leftover casseroles and other dishes

Ground red meats [minimum 160°F (71°C)]; egg dishes, eggs -- until whites are solid and yolks are beginning to set

160°F (71°C) to 140°F (60°C): holding range for hot foods

Do NOT leave food in this range for more than 2 hours

Do NOT thaw foods in this range

40°F (4°C) to 32°F (0°C): holding or refrigerator range for cold foods [maximum 45°F (7°C)]

Thawing range -- defrost frozen foods

0°F (-18°C) to -10°F (-23°C): freezer setting

**Local requirements may vary. Check with local health authority.*

55.12a – Preparations.

1. Talk to coworkers who are familiar with the area. Study maps and aerial photos of the worksites and camp locations.
2. Ensure that the crew has reliable communications and a schedule for regular check in.
3. Prepare a travel itinerary and time schedule for the return to the trailhead and the trip back.
4. Procure foodstuffs carefully: Avoid glassware; consider freeze-dried foods and other nonperishables; label everything; take along sealable plastic boxes, bottles, and bags for perishables; and purchase perishables just prior to departure.
5. Train personnel in the use of specific camp equipment, such as stoves and lanterns, handtools, maps, compass, GPS, and first aid kits, camp sanitation, survival techniques, and radio operations.

55.12b – Other Concerns. Take appropriate steps to address the following:

1. Transportation of people and equipment.
2. Anticipated hazards of the specific work or activity.
3. Personal health needs.
4. Disposal of waste material.
5. Choice and layout of camp.
6. Impact of weather and seasons.
7. Natural hazards such as overhanging cliffs, areas subject to flash flooding, rock slides, tree snags, widowmakers, tall grass, and low marshy areas.
8. Adequate drainage. Choose campsites:
 - a. Not within 200 feet (61 m) of swamps, pools, sink holes, or other surface water collection areas unless mosquito control is in effect.
 - b. Free of depressions that collect water.
9. Sufficient space to prevent overcrowding.

10. Food preparation areas and sleeping quarters located at least 500 feet (152-1/2 m) from livestock areas.

11. Bear precautions for food storage and preparation.

12. Animal hazards, such as poisonous insects and snakes.

13. The presence of poison ivy, oak, and sumac.

55.12c – Cooking Operations. Crew leaders should ensure that well-balanced meals are prepared. Because of the unique problems associated with transportation and storage of perishable foods at field camp locations, use freeze-dried, dehydrated, and other specially prepared food when possible.

1. **Cooking Area.** Choose a clean and reasonably flat spot for food preparation and cooking.

Do not place cooking stoves inside tents. Use tarps or flies for protection from the weather.

If using charcoal, have regular starter fuel available. Never use gasoline or camp stove fuel.

2. **Meal Preparation.** Provide a wash area for cooks and kitchen helpers, complete with hot water, soap, and towels. Spread plastic sheets over food preparation areas and keep them clean. Personal cleanliness of both food handlers and helpers is essential. Contamination under field conditions can quickly become a serious health threat.

Open only the quantities of canned or sealed foods needed for each meal. Use up perishables as soon as possible. Cook all foods thoroughly to kill bacteria. Serve food hot.

3. **Cooking Utensils.** Keep utensils clean. Store utensils in closed contamination-free containers until used. Never set dirty pots or containers on the food preparation surface. Use tongs or gloves when handling hot pots.

4. **Food Storage and Serving.** Store all unopened containers in the kitchen storage area. Store all nonperishable foods in resealable plastic containers.

Keep the food serving area clean at all times. Never serve food with your fingers. Use disposable plates, cups, and eating utensils whenever possible.

55.12d – Food Rations. A wide variety of freeze-dried foods eliminate the concern for spoilage and should be considered for supplementing food supplies.

1. Inspect canned foods and emergency rations annually and before use. Open and inspect (10 percent random sample) rations held in dry storage (40 °F to 65 °F or 4 °C to 18 °C) that are 3 years old. If storage conditions are unknown or dry storage is not within the 40 °F to 65 °F range, inspect rations more often. Rations exposed to temperatures above 90 °F (32 °C) can spoil in a few weeks or within 1 year, depending on storage conditions. Destroy rations after the fourth year. Destroy canned food stored in an unheated building that has been subject to freezing and thawing.

2. Destroy any canned food showing evidence of damage or spoilage, regardless of the expiration date.

- a. Leaky, rusted, swollen, weakened, or dented cans.
- b. Contents with a flat, sour taste, or mold growth.

3. If there is any doubt about the wholesomeness and safety of canned rations or other foods, destroy them. Always check the packing date and advise users to closely examine the contents before eating. Destroy food that is abnormal in appearance, taste, or odor.

55.12e – Water Purification of Undeveloped Sources. All undeveloped sources must be considered contaminated and unsafe for drinking water.

For field situations, provide or obtain safe drinking water by:

1. Hauling water from a source that complies with public water system standards (refer to FSM 7422 for proper hauling containers, handling, and testing).

2. Using bottled water.

3. Using a point-of-use (POU) device that removes particles one micron or less in diameter that is labeled as certified by NSF International per NSF Standard 53 or labeled as an absolute one-micrometer filter.

4. Boiling as follows:

- a. Strain water through a clean cloth to remove sediment or floating matter.
 - b. Boil water vigorously for at least 3 to 5 minutes.
 - c. Aerate to improve taste by pouring water back and forth from one clean container to another several times.
5. Sterilizing canteens before each refilling in the following manner (unless each person has one for personal use):
- a. Submerge canteens in a solution of liquid laundry bleach and water ratio 1:100 (1 capful per gallon of water).
 - b. Keep canteens submerged for a minimum of 1 hour (canteens must be completely filled with solution).
 - c. Rinse thoroughly with clean water.

55.12f – After-Work Organized Swimming Activities. *Organized swimming activities must be approved by a line officer. If organized swimming is approved:*

1. ***Ensure that the JHA includes a plan for water rescue, to respond and deal immediately with accidents.***
2. Designate a person, qualified in water safety, to supervise the activity.
 - a. Have a competent person inspect potential swimming areas for treacherous currents, deep holes, or other hazards. Keep swimming areas free of debris and rocks.
 - b. Do not permit anyone to enter the water alone. Equip the area with strategically placed life-saving equipment such as reaching-poles, lines, and ring-buoys.
 - c. Assign lifeguards whenever there are swimmers in the water. Have a lookout observing all swimmers all the time. Use a buddy system.
 - d. Prohibit swimming after dark.
 - e. Monitor the weather.
 - f. Ensure that employees:
 - (1) Do not swim if overheated.
 - (2) Are able to recognize the symptoms of exhaustion and know what to do.
 - (3) Know what to do for cramps, which can be caused by cold water.
 - (4) Never dive into water until the depth and water temperature have been checked. Check the location of others before diving.

CHAPTER 60 – HAZARDOUS MATERIALS

Contents

- 61 HAZARDOUS MATERIALS**
- 61.01 Authority
- 61.05 Definitions
- 61.06 References
- 61.1 General Safety Requirements
- 61.11 Personnel Qualifications
- 61.12 Personal Protective Equipment
- 61.13 Procedures
- 61.14 Safety Practices
- 61.15 Use
- 61.15a Marking and Labeling
- 61.16 Storage
- 61.17 Transportation
- 61.18 Disposal
- 61.2 Laboratory Safety
- 61.21 Qualifications
- 61.22 Personal Protective Equipment
- 61.23 Procedures
- 61.24 Chemical Hygiene Plan
- 61.25 Emergency Planning
- 61.25a Emergency Evacuation Procedures and Communications Plan
- 61.25b Emergency Guidelines
- 61.26 Safety Practices
- 61.3 Greenhouse Safety
- 61.31 Procedures
- 61.32 Safety Practices
- 61.32a Operations
- 61.32b Pesticides
- 61.32c Equipment
- 61.32d Electrical
- 61.4 Incompatible Chemicals
- 61.41 Area 1 – Solvents
- 61.42 Area 2 – Corrosive Materials
- 61.43 Area 3 – Strong Oxidizing Agents
- 61.44 Area 4 – Remaining Chemicals
- 61.5 Flammable/Combustible Liquids

- 61.51 Special Concerns
 - 61.51a Density
 - 61.51b Vapor Density
 - 61.51c Toxicity
 - 61.51d Storage
 - 61.51e Dispensing
- 61.6 Flammable Gases
 - 61.61 General Safety
 - 61.62 Liquefied Petroleum Gas
- 61.7 Pesticides
 - 61.71 Safety Practices
 - 61.71a Storage
 - 61.71b Transportation of Pesticides
 - 61.71c Disposal
- 61.8 Asbestos
 - 61.81 Procedures
- 61.9 Lead

62 EXPLOSIVES AND BLASTING AGENTS

- 62.01 Authority
- 62.06 Reference
- 62.1 Personnel Qualifications

CHAPTER 60 – HAZARDOUS MATERIALS

61 – HAZARDOUS MATERIALS. Hazardous materials consist of a wide variety of substances that may be solid, liquid, or gas. Characteristically, they may be corrosive, explosive, flammable, radioactive, reactive, toxic, or a combination, and they require specific cautionary procedures to permit their safe use, transport, and storage. The unique properties of hazardous materials require that all employees who work with these materials have a general awareness of the dangers they present to life, safety, and health.

61.01 – Authority.

1. The authority for flammable/combustible liquids, hazardous waste operations, respiratory protection, specifications for accident prevention signs and tags, and toxic and hazardous substances is in Title 29, Code of Federal Regulations (29 CFR), sections 1910.106, 1910.120, 1910.134, 1910.145, 1910.1000 – 1910.1450.

2. The authority for ventilation, lead, and OSHA safety standards is in 29 CFR 1926.57 and 1926.62 and Part 1960, Subpart C.

3. The authority for hazardous waste management is in 40 CFR Subchapter C.

4. The authority for pesticides programs is in 40 CFR Subchapter E. Additional agency direction is in FSM 2150 and FSH 2109.14.

5. The authority for underground storage tank standards is in 40 CFR Subchapter I, Part 280.

6. The authority for general and specific information on hazardous materials, commercial driver's license standards, and hazardous materials transportation is in 49 CFR Parts 171, 173, 175-177, 383, and 397.

7. Agency direction on hazardous materials, in addition to this chapter, is in FSM 2160 and 6740. For management of asbestos-containing materials refer to FSM 2167.13; for radon, FSM 2167.14a; for polychlorinated biphenyls (PCBs) and restricted wood

preservatives commonly used in buildings and structures, FSM 2167.16; and for lead, FSM 2167.17.

8. The Interagency Aviation Transport of Hazardous Materials document (January 1999) establishes the USDA Forest Service and the Department of the Interior interagency aviation transport of hazardous materials program, as authorized in FSM 5700, Aviation Management. This document can be ordered from the National Interagency Fire Center, Great Basin Cache Supply Office, 3833 South Development Avenue, Boise, Idaho 83705. Order NFES no. 1068.

61.05 – Definitions.

Chemical. Any element, chemical compound, or mixture of elements and/or compounds.

Combustible Liquids. Any liquids having a flash point at or above 100 °F (38 °C). Kerosene is an example.

Compressed Gas. A gas stored under pressure, that has the potential for explosive action if suddenly released and may irritate eyes, skin, and lungs.

Corrosive Material. Material that burns on contact, causing visible damage and/or irreversible changes to body tissues and also burns through inert materials. Hydrochloric acid is an example.

Cryogenic Material. Material that has the potential for explosion and also freezes body tissues on contact.

Etiologic Agent. A microorganism that causes a disease or disorder as determined by medical diagnosis.

Explosive. Chemical material that can undergo a sudden and violent release of pressure and heat causing injuries, death, and damage.

Explosive Material. Material with the potential for explosion.

Exposure Routes. Ways that chemicals enter a person's body. There are four main routes of exposure: inhalation, skin/eye contact, skin absorption, and ingestion.

Flammable Liquids. Any liquid having a flash point below 100 °F (38 °C). Alcohol is one example.

Flammable Compressed Gas. A very highly flammable or explosive material when mixed in air at ambient temperature and pressure. Ignition of even a small leak may cause the material to ignite.

Flammable Solid. Solid material that ignites easily and burns vigorously.

Flash Point. Lowest temperature at which a liquid gives off enough vapor to ignite in the presence of an ignition source.

Hazardous Chemical. Any chemical having either a physical or health hazard associated with its use.

Hazardous Waste. Any solid, liquid, or contained gaseous material that because of its quantity, concentration, or physical, chemical, or infectious characteristics may:

- a. Cause or significantly contribute to an increase in mortality or an increase in serious irreversible, or incapacitating reversible, illness; or
- b. Pose a substantial present or potential hazard to human health or the environment when improperly treated, stored, transported, disposed of, or otherwise managed.

Incompatible Materials. Materials that could cause dangerous reactions when in direct contact with each other.

Irritating Materials. Materials that release dangerous fumes on contact with water, fire, or air, and that react with body tissues at the point of contact causing reddening, itching, tearing, irritation, and/or minor inflammation.

Oxidizing Material. Any material that yields oxygen to stimulate combustion.

Poison. A material that adversely affects systems of the body.

Pyrophoric Liquid. Liquid that ignites spontaneously in air at 130 °F (54 °C) or lower temperatures.

Radioactive Material. A substance containing an element that emits ionizing radiation upon decay.

Toxic Material. Material that may cause systemic damage when taken into the body.

61.06 – References.

1. National Fire Protection Association. NFPA issues standards for use and management of various hazardous materials and related topics as follows: NFPA 30, Flammable and Combustible Liquids Code; NFPA 43A, Storage of Liquid and Solid Oxidizers; NFPA 43B, Storage of Organic Peroxide Formulations; NFPA 43C, Storage of Gaseous Oxidizing Materials; NFPA 43D, Storage of Pesticides; NFPA 58, Storage and Handling of Liquefied Petroleum Gases; NFPA 70, National Electrical Code; NFPA 80, Fire Doors and Windows; NFPA 251, Building Construction and Materials; NFPA 325M, Fire Hazard Properties of Flammable Liquids, Gases, and Volatile Solids; NFPA 395, Storage of Flammable and Combustible Liquids at Farms and Isolated Sites; NFPA 491M, Hazardous Chemical Reactions; and NFPA 704, Identification of the Fire Hazards of Materials for Emergency Response. Quincy, MA.

2. U.S. Department of Transportation, Research and Special Programs Administration. 1993. Emergency Response Guidebook. U.S. Government Printing Office, Washington, DC.

61.1 – General Safety Requirements.

61.11 – Personnel Qualifications. Line officers shall ensure that all employees involved in the use, storage, transportation, and disposal of hazardous materials receive training specified in 29 CFR 1910.120, 29 CFR 1910.1200, and 49 CFR Part 172. At a minimum, this shall be general awareness training for handling hazardous materials and shall extend to function-specific, safety, and driver training, when warranted.

In accordance with FSM 2161.41a, line officers shall ensure that all employees, including seasonal workers and volunteers who are likely to discover a hazardous material release, receive Emergency Response Awareness Training.

Operators of Government vehicles transporting hazardous materials for noncommercial purposes in quantities that require placarding, shall obtain a commercial driver's license with a hazardous materials endorsement. Refer to 49 CFR Part 383 for re-

quirements. Drivers shall receive general awareness, safety, driving, and function-specific training.

61.12 – Personal Protective Equipment. Appropriate personal protective equipment (PPE) shall be provided and used to protect employees from exposure to chemicals. For specific information, refer to the material safety data sheet (MSDS), job hazard analysis (JHA) (FS 6700-7), and specific product labels.

61.13 – Procedures. The Occupational Safety and Health Administration (OSHA) hazard communication standard (29 CFR 1910.1200) requires manufacturers to provide on their chemical product labels specific guidelines on its hazards, uses, PPE, and disposal techniques. Provide this information to employees by means of a written hazard communication program, JHA, other forms of warning, MSDS, and training. Maintain employee exposure and medical records in accordance with 29 CFR 1910.20.

The JHA shall address site-specific hazards associated with drug dumps, methamphetamine labs, and so forth, that employees may discover on National Forest System Lands.

61.14 – Safety Practices. A hazard communication training program provides information related to general awareness, hazard chemical inventory, and MSDSs.

1. A hazardous chemical inventory shall be maintained and shall be readily accessible to all employees.
2. Employees shall not handle hazardous chemicals that do not have an MSDS. An MSDS is required from the manufacturer/supplier of each chemical used on site. MSDS's shall be readily accessible to employees at all times.
3. Emergency response awareness training shall address:
 - a. Hazardous material releases by third parties on National Forest System lands and lands leased by the Forest Service; and
 - b. Releases from Forest Service facilities or operations that are beyond the ability of the employees in the immediate work area to clean up.

Response to these situations should be limited to collecting as much information as possible from a safe distance and to notifying

the appropriate Environmental Protection Agency, State, and local emergency response authorities.

61.15 – Use. Research and identify the hazards and properties of chemicals before purchase. Order only enough of each chemical to meet current needs. Chemical-specific information shall be available through labels and the MSDS.

61.15a – Marking and Labeling. The Forest Service uses two primary labeling systems:

1. National Fire Protection Association (NFPA) Hazard Rating System (ex. 01). This system identifies the hazards of a material in terms of four categories: Health Hazard, Flammability, Reactivity, and Special Hazard, using the following hazard signal marking arrangement:

2. Department of Transportation (DOT) labeling/placarding system (ex. 02). International regulations require that packages (all quantities) to be transported shall carry content labels unless otherwise provided by 49 CFR. Marine, highway, rail, and air transportation labeling may differ. Labels are 4 inches (102 mm) square, with lettering across the face. DOT requires these labels for interstate shipment via rail or highway carrier, and a label must appear on at least two opposing sides or two opposing ends of a package (excluding the bottom).

Except as otherwise provided by 49 CFR, each bulk package, freight container, unit load device, and transport vehicle shall be placarded on each side and each end. Placards are at least 10-3/4 inch (273 mm) square, with lettering across the face. Refer to 49 CFR 172.400 through 172.560 for additional requirements on labeling/placarding.

Except for size, required labels and placards have similar physical characteristics. Individual differences are identified in exhibit 02.







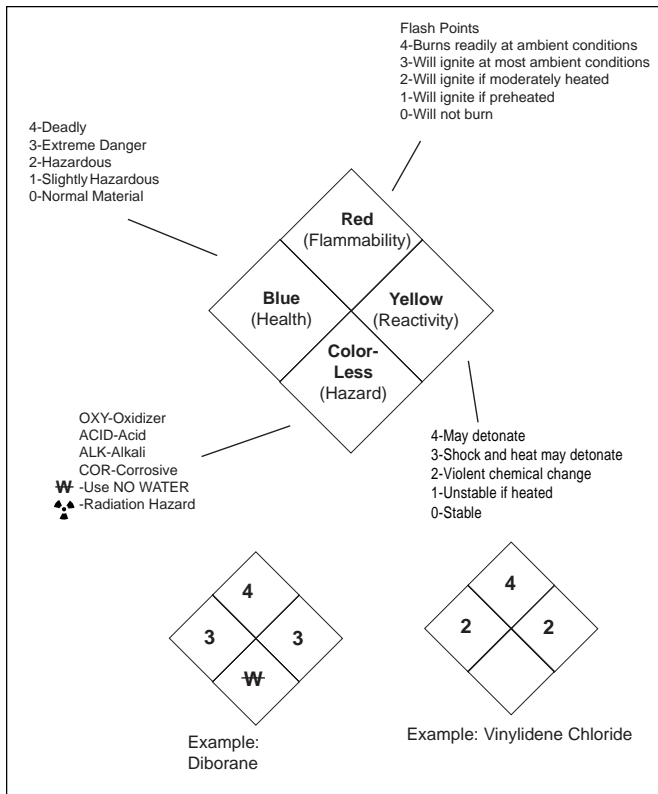

61.16 – Storage. Plan the storage area with personnel safety and health in mind, so that:

1. All personnel know how to and are able to get out of the storage area in case of accident or fire.

61.15a – Exhibit 01 – NFPA Hazard Rating System









61.15a – Exhibit 02 – DOT Labeling/Placarding System

| Contents | Color | Description | Label/ Placard |
|--------------------------------|--|--|---|
| Explosives 1.1, 1.2, 1.3 | Orange: background Black: text, border, numerals, symbol | Class 1. Placard all quantities. |  |
| Explosives 1.4 | Orange: background Black: text, border, numerals, symbol | Class 1. Placard 1001 pounds (454 kg) or more. |  |
| Explosives 1.5 | Orange: background Black: text, border, numerals, symbol | Class 1. Placard 1001 pounds (454 kg) or more. |  |
| Explosives 1.6 | Orange: background Black: text, border, numerals, symbol | Class 1. Placard 1001 pounds (454 kg) or more |  |
| Oxygen | Yellow: background Black: text, border, numerals, symbol | Class 2. Placard 1001 pounds (454 kg) or more. |  |
| Flammable gas | Red: background White: text, border, numerals, symbol | Class 2. Division 2.1. Placard 1001 pounds (454 kg) or more. See DANGEROUS. |  |
| Nonflammable gas | Green: background White: text, border, numerals, symbol | Class 2. Division 2.2. Placard 1001 pounds (454 kg) or more. See DANGEROUS. |  |
| Poison gas | White: background Black: text, border, numerals, symbol | Class 2. Division 2.3. Placard all quantities. Text "Toxic Gas" may be used instead of "Poison Gas." |  |







(continued)

61.15a – Exhibit 02 – DOT Labeling/Placarding System (contd.)

| Contents | Color | Description | Label/ Placard |
|-----------------------------|--|--|---|
| Flammable liquid | Red: background White: text, border, numerals, symbol | Class 3. (Label Only) |  |
| Flammable | Same as label above Placard 1001 pounds (454 kg) or more. Text "Gasoline," "Combustible," or "Fuel oil" may be used instead of "Flammable." | Class 3. (Placard Only) See DANGEROUS. |  |
| Flammable solid | White: background with vertical red stripes Black: text, border, numerals, symbol | Class 4 Division 4.1 Placard 1001 pounds (454 kg) or more. See DANGEROUS. |  |
| Spontaneously combustible | Red: background with white upper half Black: text, border, numerals, symbol | Class 4. Division 4.2. Placard 1001 pounds (454 kg) or more. See DANGEROUS. |  |
| Dangerous when wet material | Blue: background White: text, border, numerals, symbol | Class 4. Division 4.3. Placard all quantities. |  |
| Oxidizer | Yellow: background Black: text, border, numerals, symbol | Class 5. Division 5.1. Placard 1001 pounds (454 kg) or more. See DANGEROUS. |  |
| Organic peroxide | Yellow: background Black: text, border, numerals, symbol | Class 5. Division 5.2. Placard 1001 pounds (454 kg) or more. See DANGEROUS. |  |







(continued)

61.15a – Exhibit 02 – DOT Labeling/Placarding System (contd.)

| Contents | Color | Description | Label/ Placard |
|-------------------------|---|--|---|
| Poison | White: background Black: text, border, numerals, symbol | Class 6. Division 6.1. Placard 1001 pounds (454 kg) or more. See DANGEROUS. |  |
| Poisonous Material | White: background Black: text, border, numerals, symbol | Class 6. Division 6.1. Placard 1001 pounds (454 kg) or more. A Poison placard may be substituted. See DANGEROUS. |  |
| Infectious Substance | White: background Black: text, border, numerals, symbol | Class 6. Division 6.2. Placard 1001 pounds (454 kg) or more. (Label Only) See DANGEROUS. |  |
| Radioactive | White: background Black: text, border, numerals (except for the "I" which must be red), symbol | Class 7. (Label Only) |  |
| Radioactive | White: background with yellow triangle in the upper portion Black: text, border, numerals (except for the "II" which must be red), symbol | Class 7. (Label Only) |  |
| Radioactive | White: background with yellow triangle in the upper portion- Black: text, border, numerals (except for the "III" which must be red), symbol | Class 7. (Label Only) |  |

(continued)

61.15a – Exhibit 02 – DOT Labeling/Placarding System (contd.)

| Contents | Color | Description | Label/ Placard |
|-----------------------------------|---|--|---|
| Radioactive | White: background with yellow triangle in the upper portion Black: text, border, numerals, symbol | Class 7. (Placard Only) Placard all quantities. |  |
| Corrosive | Black: background with white triangle in the upper portion White: text, numerals Black: border and symbol | Class 8. Placard 1001 pounds (454 kg) or more. See DANGEROUS. |  |
| Miscellaneous Hazardous Materials | White: background with vertical black stripes in upper portion Black: numerals | Class 9. Placarding is not required but may be used for material not included in any other hazard class. See DANGEROUS. |  |
| Dangerous | Red: background with horizontal white stripe in middle portion, border Black: text | Placard 1001 pounds (454 kg) of hazardous material mixed loads. (Placard Only) |  |
| Cargo aircraft only | Orange: background Black: text, border, symbol | (Label Only) |  |
| Empty | White: background Black: text, border | Each side 6 inches (152 mm) long with each letter at least 1 inch (25-1/2 mm) high. (Label Only) |  |

2. There are no obstructions preventing ready access to exits or to emergency equipment, such as fire extinguishers, safety showers, and eyewash stations.

3. Emergency materials for dealing with spillages are readily available.

4. Work area storage for excess chemicals is adequate.

5. Employees know about the hazardous chemical inventory, where it is kept, who is responsible for maintaining it, and how they can add to the inventory.

61.17 – Transportation. All containers (safety cans, drums, tanks, or tank trucks) used for transporting hazardous materials must be correctly labeled or placarded to ensure quick identification of the materials in an emergency. Refer to FSM 5714.2 for agency direction; 49 CFR Parts 71-173, 175, and 177-178 for further requirements; 49 CFR Part 383 for vehicle operation requirements; and 49 CFR Part 397 for hazardous materials driving and parking rules.

At an accident scene involving hazardous materials, exercise caution to prevent being injured and initiate measures without delay to protect life. Consult the Emergency Response Guidebook (sec. 61.06), if necessary.

61.18 – Disposal. Disposal of many hazardous waste products is controlled by the Environmental Protection Agency (EPA) and/or a State agency. To assure proper disposal procedures, a competent person, knowledgeable in EPA and State guidelines, shall be appointed as the unit hazardous materials coordinator to oversee the hazardous waste disposal program.

1. All disposal methods shall comply with Federal, State, and local laws and regulations. Never flush hazardous waste products into drains and sewers.

2. Mercury spills or waste must be collected in a special receptacle and recycled.

3. Containers previously used for toxic chemicals shall not be used for trash barrels, water storage tanks, or feed troughs.

61.2 – Laboratory Safety. This section applies to any room, building, or area used for scientific or technical research, testing, and analysis, or small-scale preparation or storage of toxic or hazardous materials.

61.21 – Qualifications. Employees shall receive OSHA Hazardous Communications (Right-to-Know) Standard initial training and refresher courses. They shall be familiar with the chemicals, equipment, and procedures for an assigned task, demonstrate the ability to recognize potential hazards, know how to prevent accidents, and know what steps to take in the event of an accident, spill, exposure, or other emergency.

61.22 – Personal Protective Equipment. To reduce the spread of contaminants to offices, lunchrooms, meeting rooms, and homes, never wear PPE outside the laboratory.

1. The JHA shall identify appropriate PPE to be provided and used in the laboratory (ex. 01). Some examples are gloves, footwear, and body protection (aprons, coveralls, or air-supplied suits).

2. When the JHA identifies a respiratory hazard (sec. 21.13), approved and appropriate respiratory protective equipment shall be provided (ex. 02). Maintain a written respiratory protection program in accordance with OSHA Respiratory Standard (29 CFR 1934).

For certain hazardous chemicals, such as perchloric acid or hydrogen fluoride, specially designed fume hoods must be used. Do not store or use organic materials in the perchloric hood. (Exception: store or use organic materials in the perchloric hood only when needed for prescribed reactions. Label perchloric fume hoods, "Perchloric Acid Fume Hood—Use Only Prescribed Organic Materials.")

Provide an auxiliary power supply for fume hoods for toxic gases or volatile chemicals to maintain ventilation in case of utility failure.

3. The laboratory safety and health officer shall identify and post excessive noise areas (85 dB or above). When possible, use engineering controls to reduce noise or relocate the process.

4. Safety eyewear that meets or exceeds the ANSI Standard Z87.1-1989 is the minimum eye protection required for laboratory work.

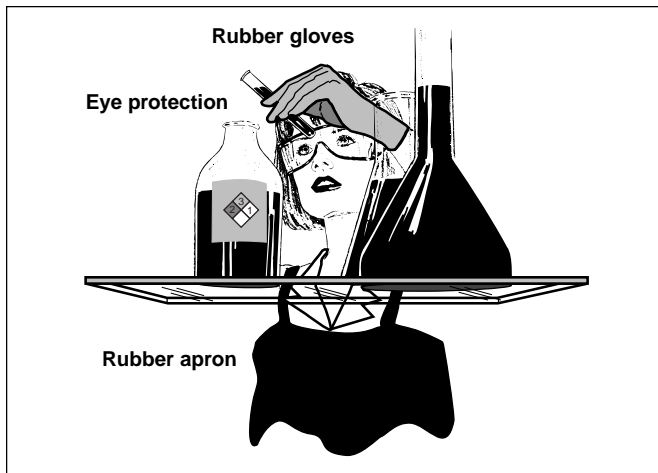
61.22 – Exhibit 01 – Lab Safety PPE**61.22 – Exhibit 02 – Respirator**

- a. Always use goggles and a face shield when there is increased risk of eye damage, such as when handling corrosives.
- b. Clean lenses often. Always flush abrasive dirt from lenses with running water; do not clean with abrasive soap.
- c. Inspect lenses for chips or scratches that weaken hardened lenses. Replace damaged lenses immediately.
- d. Use special lenses for work with nonionizing radiation sources, such as lasers, welding and burning equipment, and ultraviolet/infrared light (ex. 03).

61.22 – Exhibit 03 – Special Lenses



61.23 – Procedures. JHAs developed for laboratory activities shall include potential hazardous procedures from time of purchase to disposal. Discuss each procedure thoroughly with all involved personnel and plan how to prevent accidents. In addition, the JHA shall identify specific PPE for each functional area or task.

Activities involving high-risk procedures, hazardous materials, or toxic substances shall be reviewed by a laboratory director or Forest Supervisor representative. Correct all problems before the work begins. All potential hazards shall be addressed and preventive measures taken before work begins.

Basic procedures alone do not ensure a safe and healthful workplace. Application of the rules must be accompanied by careful consideration of every action. Maintain current references on laboratory safety. Consult them and apply their guidelines.

1. Prohibit unnecessary ignition sources within 50 feet (15-1/4 m) of flammable storage or work areas.
2. When transferring flammable liquids from metal containers, ground and bond the containers to prevent static charges.
3. Ensure that refrigerators for flammable chemical storage are explosion proof (NFPA 70 – article 500). Tight-fitting covers for containers must be used for storing flammable liquids in refrigerators.
4. Mark compressed cylinders with DOT labels (sec. 61.15a, ex. 02).
 - a. Move cylinders by handtrucks. Secure the cylinder in an upright position with a safety chain.
 - b. Ensure that cylinders are equipped with an approved pressure regulator for the specific gas being used.

61.24 – Chemical Hygiene Plan. Every research laboratory shall have a written Chemical Hygiene Plan (CHP) as required by 29 CFR 1910.1450 (OSHA Standard on Occupational Exposure to Hazardous Chemicals in Laboratories). Training and education of employees should be a regular, continuing activity, not simply an annual presentation.

The JHA must contain the following information concerning each chemical to be used:

1. Chemical name (common and International Union of Chemists name).
2. MSDS.
3. Quantity on hand, stored, and to be handled at any one time.
4. Shelf-life (useful time frame for storage).
5. Frequency of use (exposure in terms of calendar days or months).
6. People designated to handle and dispose of materials. Include personal qualifications for disposal.
7. Emergency procedures and equipment, such as for spills.
8. Storage facilities (main building, in transit, in the field).
9. Handling procedures (main building, in transit, in the field).

It is vital that employees inspect their equipment and work areas for hazards and defects every work day and that they correct or repair hazards and defects as they occur.

In any area where personnel may be exposed to hazardous levels of chemicals, it is the duty of supervisors to monitor the environment at regular intervals consistent with 29 CFR 1910.1001.

61.25 – Emergency Planning.

1. Conspicuously post telephone numbers for emergency assistance near each phone in laboratory work areas. Include names and telephone numbers of employees trained in first aid.
2. Make an appropriate first aid kit readily available for each laboratory. Maintain emergency equipment and locate it along normal paths of travel where it is readily accessible.
3. Locate emergency showers in or near all laboratory rooms with access unobstructed. Shower valves shall be easily activated, and the shower head shall be the deluge type that delivers 30 to 60 gallons per minute at pressures of 20 to 50 pounds per square inch (psi) at the head. Every laboratory room or area shall have ready access to low pressure, aerated water for removing contaminants

from the eyes and, where possible, with the eyewash fountain co-located with the emergency shower.

4. Maintain all eyewash stations (ex. 01) in accordance with ANSI Z358.1 and inspect them per the manufacturer's instructions. Squeeze bottles also require frequent inspection and maintenance since they lose water to evaporation, become contaminated, and are easily misplaced (sec. 21.22).

61.25a – Emergency Evacuation Procedures and Communications Plan. Employees shall be familiar with the Emergency Evacuation Procedures and Communications Plan, and of their duties in:

1. Sounding the alarm.
2. Operating emergency equipment.
3. Evacuating to shelters or assembly points.
4. Notifying emergency response crews.
5. Having skills in rescue and first aid.

Include provisions for advising emergency response crews of potential dangers when such crews are summoned.

61.25 – Exhibit 01 – Emergency Eyewash Station

**Keep emergency equipment
in good working order.**

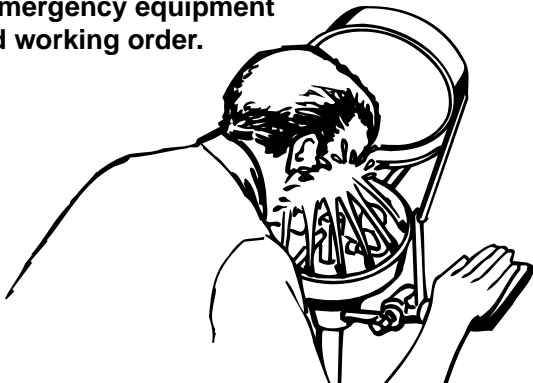

61.25b – Emergency Guidelines.

1. Provide guidelines for all conceivable emergencies during which laboratory activities might be interrupted and for utility failures. Include provisions for:

- a. Emergency ventilation and lighting.
- b. Cooling of chemical reactions.
- c. Personnel evacuation.
- d. Advising emergency response crews of potential dangers when such crews are summoned.

2. Conduct emergency drills at least twice a year. Ensure that the drills do not create hazards themselves.

61.26 – Safety Practices. Management shall ensure the safety and health of employees and the visiting public.

Some chemical combinations are very reactive and can produce heat, generate gas, or detonate. Such reactivity generally can be predicted. Sometimes chemicals must be combined in specific sequences. Before working with chemicals, laboratory employees shall review the applicable MSDS to know and recognize the potential reactions of the chemicals being used and to know how to control these reactions.

The toxicity of many chemicals has not been completely investigated. Lethal doses of some chemicals can be absorbed through the skin, inhaled into the lungs, and ingested through the mouth.

The inhalation of toxic vapors and gases, skin contact, and poor housekeeping pose some of the greatest hazards when working with chemicals. PPE and safety devices do not provide complete protection. Care in handling chemicals is essential.

Follow these safety practices.

1. **Chemical Spills.** Clean up chemical spills immediately, using approved procedures for disposal.

2. **Removal of Stored Toxic Liquid Chemicals.** Remove toxic liquid chemicals from large storage containers by a pump or siphon, or by a pipette equipped with a rubber suction bulb. Do not start siphons by mouth to remove liquid chemicals. ***Do not allow mouth pipetting.***

3. **Food Safety.** Do not eat or drink in any room or area where there is danger of contamination by toxic or radioactive substances. Do not store food and beverages in laboratory refrigerators. Do not use laboratory glassware for food or beverages.

4. **Laboratory Glassware.** Inspect glassware before and after use. If damaged, repair or discard. Do not pick up large glass containers by their necks or rims. Hands must be dry when handling chemical containers. Do not stress any glass part when setting up an apparatus. Rinse or purge flammable or toxic residue from glassware after use.

5. **Mechanical Hazards.** Operate equipment according to the manufacturer's recommendations. Secure appropriate guards and shields. Do not operate instruments or leave equipment unattended unless adequate safety measures are taken. All warning signs shall be clearly visible. Employees shall be familiar with all safety features.

6. **Nonionizing Radiation.** Mount appropriate eye protection or shields on instruments emitting nonionizing radiation. Post warnings. It is imperative that equipment or materials emitting high energy radiation be handled according to established radiation and radioisotope policy (FSM 6741).

7. **Pressure and Vacuum Systems.** Store compressed gases and handle them in a safe manner. Use safety shields to protect personnel from equipment that may explode or implode. Regulatory and safety valves or controls must be maintained and regularly inspected as prescribed by the manufacturer.

8. **Thermal Hazards.** Wherever there are high or low temperature areas in the laboratory, install suitable insulation and warning signs. Employees working with high or low temperatures shall use adequate safety clothing. Never leave high temperature ovens or furnaces unattended unless they are equipped with temperature control and warning signs.

9. **Electrical Hazards.** Ensure that wiring meets National Electrical Code standards as required in classified areas where hazardous materials are stored and used.

All electrical equipment, wiring, switches, controls, and posted signs shall comply with NFPA 70 (ex. 01).

10. **Infectious Hazards.** Ensure that personnel using potentially hazardous microorganisms are trained in safety and health measures, and that they conduct their laboratory activities in accordance with the level of risk.

- a. Keep laboratories clean. Disinfectants identified as effective against organisms being handled shall be

61.26 – Exhibit 01 – Electrical Hazard Signs

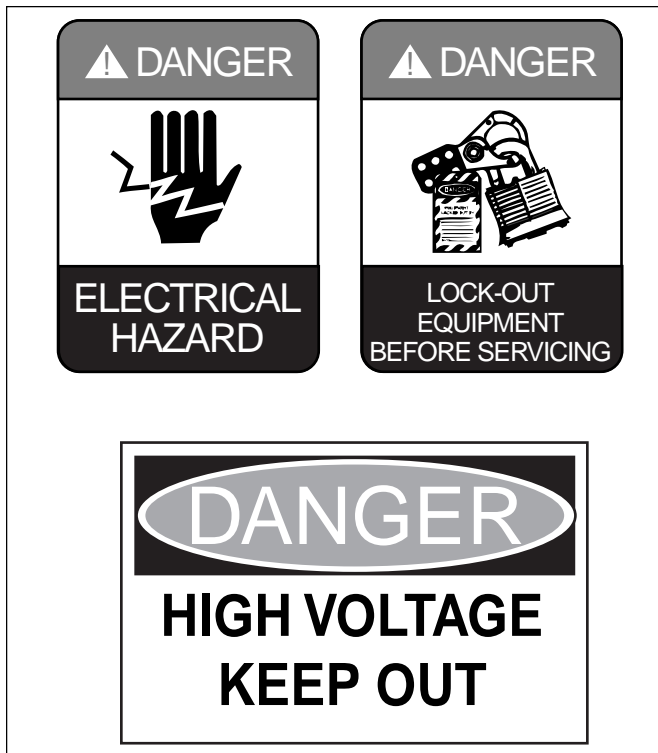

- available in each laboratory and used routinely on work surfaces. Disinfect equipment for handling hazardous biological materials before it is discarded or reused.
- b. Do not eat or drink in laboratories where biohazardous materials are used or stored. Always wash hands after working with microorganisms.
 - c. Label all pathogens properly for ready identification (29 CFR 1910.1030).
 - d. Pipetting of hazardous microorganisms or toxic fluids shall be done only by bulb or other nonmouth devices. Do not blow infectious fluids out of pipettes.
 - e. Perform all work with hazardous microorganisms or toxic fluids on plastic-backed absorbent material.

11. **Animal Hazards.** Practice good personal hygiene and housekeeping techniques when caring for and working with animals. Use PPE to reduce the possibility of infection through a skin break, the respiratory tract, or through contact with excreta.

61.3 – Greenhouse Safety.

61.31 – Procedures. Develop a safety and health plan that includes:

1. Supervision responsibility.
2. Periodic inspection.
3. Use of hazardous materials.
4. Emergency evacuation procedures and communication plan.
5. Equipment use.
6. Accident investigation and reporting.

61.32 – Safety Practices. JHAs are required for all greenhouse work projects and activities.

61.32a – Operations.

1. Do not use soil amendments containing pathogenic microorganisms (such as *Sporotrichum schenckii*, the cause of sporotrichosis) as a potting medium or for packing nursery stock. This

prohibition applies especially to fresh, nondecomposed sphagnum moss that is often infested with *S. schenckii*. The prohibition does not apply to decomposed sphagnum peat moss sold commercially.

2. Wear a respirator when working with dry soil amendments like peat moss, vermiculite, and perlite (sec. 21.13).
3. Keep aisles and passageways clear. Do not obstruct exits with stored materials.
4. Consider fire characteristics when storing materials.

61.32b – Pesticides. Only licensed or certified persons are permitted to apply restricted-use pesticides. Refer to sections 22.11 and 61.7 for additional information.

1. Use only registered pest control chemicals. Apply all pesticides according to label instructions and use required PPE.
2. When using smoke fumigators, post warning signs on all greenhouse doors to indicate:
 - a. What fumigants will be used.
 - b. When fumigation will be done.
 - c. Who will be allowed access.

61.32c – Equipment. Safety equipment, first aid kits, safety showers, and fire extinguishers must be readily available for emergencies. Employees shall be trained in the use of such equipment.

61.32d – Electrical. All electrical work shall be done in compliance with the NFPA 70 and State or local safety codes.

1. Because greenhouses are often damp, use double insulation and ground-fault circuit breakers to prevent shocks.
2. Schedule routine inspection of all electrical cords. Do not use worn or frayed extension cords.

61.4 – Incompatible Chemicals. Organize storage so there are separate areas for solvents, corrosive liquids, strongly oxidizing agents, and the remaining chemicals.

Partial List of Incompatible Chemicals

| <i>Chemical</i> | <i>Incompatibles</i> |
|--|--|
| Acetic acid | Chromic acid, ethylene glycol, hydroxyl-containing compounds, nitric acid, perchloric acid, permanganates, and peroxides |
| Acetone | Bromine, chlorine, nitric acid, and sulfuric acid |
| Acetylene | Bromine, chlorine, copper tubing, mercury, silver, fluorine, and iodine |
| Alkaline and alkaline earth metals, such as calcium, cesium, lithium, magnesium, potassium, and sodium | Carbon dioxide, chlorinated hydrocarbons, and water |
| Aluminum and its alloys (particularly powders) | Acid or alkaline solutions, ammonium persulfate and water, chlorates, chlorinated compounds, nitrates, and organic compounds in nitrate/nitrate salt baths |
| Ammonia (anhydrous) | Bromine, calcium hypochlorite, chlorine, hydrofluoric acid, iodine, mercury, and silver |
| Ammonium nitrate | Acids, chlorates, chlorides, lead, metallic nitrates, metal powders, finely divided organics or combustibles, sulfur, and zinc |
| Ammonium perchlorate permanganate, or persulfate | Combustible materials; oxidizing materials, such as acids, chlorates, and nitrates |

(continued)

Partial List of Incompatible Chemicals (contd.)

| <i>Chemical</i> | <i>Incompatibles</i> |
|---------------------------|--|
| Aniline | Hydrogen peroxide or nitric acid |
| Barium peroxide | Combustible organics, oxidizable materials, and water |
| Barium rhodanide | Sodium nitrate |
| Bismuth and its alloys | Perchloric acid |
| Bromine | Acetone, acetylene, ammonia, benzene, butadiene, butane and other petroleum gases, hydrogen, finely divided metals, sodium carbide, and turpentine |
| Calcium or sodium carbide | Moisture (in air) or water |
| Calcium hypochlorite | (Activated) ammonia or carbon |
| Chlorates or perchlorates | Acids, aluminum, ammonium salts, cyanides, phosphorous, metal powders, oxidizable organics or other combustibles, sugar, sulfides, and sulfur |
| Chlorine | Acetone, acetylene, ammonia, benzene, butadiene, butane and other petroleum gases, hydrogen, metal powders, sodium carbide, and turpentine |
| Chlorine dioxide | Ammonia, hydrogen sulfide, methane, and phosphine |

(continued)

Partial List of Incompatible Chemicals (contd.)

| <i>Chemical</i> | <i>Incompatibles</i> |
|--|--|
| Chromic acid | Acetic acid (glacial), acetic anhydride, alcohols, combustible materials, flammable liquids, glycerine, naphthalene, nitric acid, sulfur, and turpentine |
| Cumene hydroperoxide | Acids (mineral or organic) |
| Cyanides | Acids or alkalies |
| Fluorine | Most materials |
| Hydrocarbons, such as benzene, butane, gasoline, propane, turpentine | Bromine, chlorine, chromic acid, fluorine, hydrogen peroxide, and sodium peroxide |
| Hydrocyanic acid or hydrogen cyanide | Alkalies and nitric acid |
| Hydrofluoric acid or anhydrous | Ammonia (anhydrous or aqueous) |
| Hydrogen peroxide 3% | Chromium, copper, iron, most metals or their salts |
| Hydrogen peroxide 30% or 90% | Same as 3% hydrogen peroxide plus aniline, any flammable liquids, combustible materials, nitromethane, and all other organic matter |
| Hydrogen sulfide | Fuming nitric acid or oxidizing gases |
| Iodine | Acetylene, ammonia (anhydrous or aqueous), and hydrogen |
| Lithium | Acids, moisture in air, and water |
| <i>(continued)</i> | |

Partial List of Incompatible Chemicals (contd.)

| <i>Chemical</i> | <i>Incompatibles</i> |
|---------------------------------|---|
| Lithium, aluminum hydride | Air, chlorinated hydrocarbons, carbon dioxide, ethyl acetate, and water |
| Magnesium (particularly powder) | Carbonates, chlorates, heavy metal oxalates or oxides, nitrates, perchlorates, peroxides, phosphates, and sulfates |
| Mercuric oxide | Sulfur |
| Mercury | Acetylene, alkali metals, ammonia, hydrogen, nitric acid with ethanol, and oxalic acid |
| Nitrates | Combustible materials, esters, phosphorous, sodium acetate, stannous chloride, water, and zinc powder |
| Nitric acid (concentrated) | Acetic acid, aniline, carbon, chromic acid, flammable gases and liquids, hydrocyanic acid, hydrogen sulfide, and nitratable substances |
| Nitric acid | Alcohols and other oxidizable organic material, hydriodic acid (hydrogen iodide), magnesium or other metals, phosphorous, and thiophene |
| Nitrites | Potassium or sodium cyanide |
| Nitro paraffins | Inorganic alkalies |
| Oxalic acid | Mercury or silver |
| Oxygen (liquid or enriched air) | Flammable gases, liquids, or solids such as acetone, acetylene, grease, hydrogen, oils, and phosphorous |

(continued)

Partial List of Incompatible Chemicals (contd.)

| <i>Chemical</i> | <i>Incompatibles</i> |
|-----------------------------------|--|
| Perchloric acid | Acetic anhydride, alcohols, bismuth and its alloys, grease, oils or any organic materials, and reducing agents |
| Peroxides (organic) | Acids (mineral or organic) |
| Phosphorous | Chlorates and perchlorates, nitrates, and nitric acid |
| Phosphorous (red) | Oxidizing materials |
| Phosphorous (white) | Air (oxygen) or other oxidizing materials |
| Phosphorous pentoxide | Organic compounds or water |
| Picric Acid | Ammonia heated with oxides or salts of heavy metals and friction with oxidizing agents |
| Potassium | Air (moisture and/or oxygen) or water |
| Potassium chlorate or perchlorate | Acids or their vapors, combustible materials, especially organic solvents, phosphorous, and sulfur |
| Potassium permanganate | Benzaldehyde, ethylene glycol, glycerin, and sulfuric acid |
| Silver | Acetylene, ammonium compounds, nitric acid with ethanol, oxalic acid, and tartaric acid |
| Sodium amide | Air (moisture and oxygen) or water |
| Sodium chlorate | Acids, ammonium salts, oxidizable materials, and sulfur |

(continued)

Partial List of Incompatible Chemicals (contd.)

| <i>Chemical</i> | <i>Incompatibles</i> |
|---|---|
| Sodium hydrosulfite | Air (moisture) or combustible materials |
| Sodium nitrite | Ammonia compounds, ammonium nitrate, or other ammonium salts |
| Sodium peroxide | Acetic acid (glacial), acetic anhydride, alcohols, benzaldehyde, carbon disulfide, ethyl acetate, ethylene glycol, furfural, glycerine, methylacetate, and other oxidizable substances |
| Sulfur | Any oxidizing materials |
| Sulfuric acid | Chlorates, perchlorates, permanganates, and water |
| Water | Acetyl chlorides, alkaline and alkaline earth metals, their hydrides and oxides, barium peroxide, carbides, chromic acid, phosphorous oxychloride, phosphorous pentachloride, phosphorous pentoxide, sulfuric acid, and sulfur trioxide |
| Zinc (particularly powder) | Acids or water |
| Zinc chlorate | Acids or organic materials |
| Zirconium (particularly in powder form) | Carbon tetrachloride, other halo generated hydrocarbons, peroxides, sodium bicarbonate, and water |

61.41 – Area 1 – Solvents. This area for solvents should be close to the floor with adequate ventilation to carry off any vapors. Store flammables only in the cabinets designed for flammable storage.

61.42 – Area 2 – Corrosive Materials. Corrosive materials react with other substances causing erosion and destruction of structural efficacy. Besides acids, such materials include acid anhydrides and alkalis. These materials often destroy their containers and therefore the *integrity of the container and its label must be checked often*. Acids are corrosive and produce hydrogen gas when they contact metals in the storage area. Alkalis in contact with aluminum liberate hydrogen.

Keep these materials close to, but not on, the floor. Do not store them in cabinets that contain gas pipes. Separate acids and strong bases by placing them at opposite ends of the cabinet or shelf. Also, organic acids react violently with strongly oxidizing mineral acids. Use spill trays under containers; use separate spill trays for incompatible chemicals. After using a chemical, return the container to its proper storage location.

Segregate acids away from substances that react with them or their mists to evolve heat, hydrogen, or explosive gases. Reactive materials in this category include those listed in exhibit 01.

61.42 – Exhibit 01 – Reactive Corrosive Materials

| | | |
|---|------------|----------------------|
| lithium | nitrides | cyanides |
| sodium | sulfides | concentrated alkalis |
| potassium | carbides | arsenic metal |
| calcium | borides | selenium metal |
| rubidium | silicides | tellurium metal |
| cesium | tellurides | common metals |
| alloys, amalgams, and hydrides of the materials above | selenides | arsenides |
| | phosphides | |

61.43 – Area 3 – Strong Oxidizing Agents. Oxidizing agents are solids, liquids, or gases that yield oxygen or other oxidizing gas during the course of a chemical reaction or that readily react to oxidize combustible materials. When containers of oxidizing materials are damaged and then allowed to mix with other chemicals, such as flammables, a fire or explosion may occur.

1. Common strong oxidizing agents include:
 - chlorates
 - nitrates and nitrites
 - nitric acid
 - permanganates
 - perchlorates
 - bromates
 - peroxides (ethyl ether, ethylene, dichloride, acetaldehyde, and many other chemicals)
 - halogens (fluorine, chlorine, bromine, iodine)
2. Separate the agents listed in paragraph 1 from:
 - combustible materials
 - organic solvents (even high flashpoint)
 - metal powders
 - metal hydrides
 - phosphorus

Take special precautions if highly hazardous compounds are to be stored, such as fluorine, chlorine, and bromine. For example, secure small cylinders of halogen gases in a fume hood.

3. Store the following materials in a manner that prevents reaction with moisture, which creates hydrogen gas:
 - lithium
 - rubidium
 - sodium
 - potassium
 - calcium
 - cesium
 - alloys, amalgams and hydrides of the above

4. Similarly, the following materials can react with moisture to produce flammable and sometimes spontaneously explosive hydrides:

- nitrides
- carbides
- silicides
- selenides
- phosphides
- sulfides
- borides
- tellurides
- arsenides

5. Certain materials react with moisture to evolve heat, including:
- concentrated acids
 - concentrated alkalies
 - acid anhydrides

6. Be careful in the storage of materials that ignite easily under normal conditions, such as:

- finely divided metals
- phosphorus
- hydrides of boron
- flammable gases
- sodium
- solvents with flash points below 20 °F (6-1/2 °C)

Take special precautions in the storage of peroxidizable compounds. The degree of danger varies considerably with the structure of the peroxide. In some cases they may undergo an accelerating self-reaction that can be violent. Organic peroxides have combined oxidizing and combustible properties. Incompatible materials can initiate, catalyze, or accelerate the decomposition of organic peroxides. Refer to NFPA 43B for further information.

61.44 – Area 4 – Remaining Chemicals. Store chemicals on lipped shelves or in cabinets based on their compatibility (ex. 01, sec. 61.4). Store them within easy reach of the people using them.

61.5 – Flammable/Combustible Liquids. Flammable liquids are dangerous when they are in open containers, when they leak or spill, or when they are heated. The degree of danger is determined

by the flash point, whether the vapor-air mixture is in an explosive range, and the possibility of a source of ignition.

Identifying the hazard class of flammable liquids is often difficult. Smell is not a reliable indication, but a strong odor is a signal that investigation is needed.

The distinction between a flammable liquid and a combustible liquid lies in the ease with which the liquid gives off flammable vapors (ex. 01). For example, gasoline, alcohol, and acetone are flammable. Lubricating, vegetable, or fish oils, and glycerin are combustible. Any combustible liquid, heated sufficiently or dispersed in a fine spray where small particles are mixed with air, becomes flammable (ex. 02).

61.5 – Exhibit 01 – Flashpoint and Boiling Point of Flammable and Combustible Liquids

| <i>Liquid Class</i> | <i>Flash Point °F (°C)</i> | <i>Boiling Point °F (°C)</i> | <i>Example</i> |
|----------------------------|---------------------------------|------------------------------|-----------------|
| <i>Flammable Liquids</i> | | | |
| 1 A | Below 73°F (23°C) | Below 100°F (38°C) | Ethyl Ether |
| 1 B | Below 73°F (23°C) | 100°F and above | Gasoline |
| 1 C | 73°F and below 100°F (38°C) | Turpentine | |
| <i>Combustible Liquids</i> | | | |
| II | 100°F and below 140°F (60°C) | | Fuel Oil #1 |
| III A | 140°F and below 200°F (93°C) | | Pine Oil |
| III B | 200°F (93.3°C) and above | | Transformer Oil |

**61.5 – Exhibit 02 – Fire Hazard Properties of Flammable/Combustible Liquids, Gases, and Volatile Solids
(Condensed from NFPA 325M)**

| Flammable/ Combustible Liquid | Flash Point °F (°C) | Ignition Temperature °F (°C) | Flammable Limits | | Hazard Class | | |
|-------------------------------------|---------------------------|------------------------------------|-------------------|-------|---|----------|----------|
| | | | Percent by Volume | Upper | (<i>H</i> = Health, <i>F</i> = Flammability <i>R</i> = Reactivity) | | |
| | | | | | Lower | <i>H</i> | <i>F</i> |
| Acetic acid (Glacial) | 103 (39) | 867 (463) | 4.0 | 19.9 | 2 | 2 | 1 |
| Acetone | -4 (-20) | 869 (465) | 2.5 | 12.8 | 1 | 3 | 0 |
| Amyl acetate | 60 (16) | 680 (360) | 1.1 | 7.5 | 1 | 3 | 0 |
| Amyl alcohol | 91 (33) | 572 (300) | 1.2 | 10.0 | 1 | 3 | 0 |
| Aniline | 158 (70) | 1139 (615) | 1.3 | 3 | 2 | 0 | |
| Benzene (Benzol) | 12 (-11) | 928 (498) | 1.2 | 7.8 | 2 | 3 | 0 |
| Butyl alcohol (Butanol) | 98 (37) | 650 (343) | 1.4 | 11.2 | 1 | 3 | 0 |
| Carbon disulfide | -22 (-30) | 194 (90) | 1.3 | 50.0 | 2 | 3 | 0 |
| Corn oil | 490 (254) | 740 (393) | 0 | 1 | 0 | | |
| Creosote oil | 165 (74) | 637 (336) | 2 | 2 | 0 | | |
| Ethyl acetate | 24 (-4) | 800 (426) | 2.0 | 11.5 | 1 | 3 | 0 |
| Ethyl alcohol | 55 (13) | 685 (363) | 3.3 | 19.0 | 0 | 3 | 0 |
| Ethyl chloride (continued) | -58 (-50) | 966 (519) | 3.8 | 15.4 | 2 | 4 | 0 |

**61.5 – Exhibit 02 – Fire Hazard Properties of Flammable/Combustible Liquids, Gases, and Volatile Solids
(Condensed from NFPA 325M) (contd.)**

| Flammable/ Combustible Liquid | Flash Point °F (°C) | Ignition Temperature °F (°C) | Flammable Limits | | Hazard Class | | |
|-------------------------------------|---------------------------|------------------------------------|------------------|-------|------------------|---|---|
| | | | Lower | Upper | F = Flammability | | |
| | | | | | H | F | R |
| Ethylene dichloride | 56 (13) | 775 (413) | 6.2 | 16.0 | 2 | 3 | 0 |
| Ethyl ether | -49 (-45) | 356 (180) | 1.9 | 36.0 | 2 | 4 | 1 |
| Ethylene oxide | -20 (-29) | 1058 (570) | 3.0 | 100.0 | 2 | 4 | 3 |
| Gasoline (low octane) | -45 (-43) | 536 (280) | 1.4 | 7.6 | 1 | 3 | 0 |
| Hexane | -7 (-22) | 437 (225) | 1.1 | 7.5 | 1 | 3 | 0 |
| Hydrocyanic acid | 0 (-18) | 1000 (538) | 5.6 | 40.0 | 4 | 4 | 2 |
| Kerosene | 100 (43) | 410 (210) | 0.7 | 5.0 | 0 | 2 | 0 |
| Lard oil | 395 (202) | 833 (445) | 0 | 1 | 0 | | |
| Methyl acetate | 14 (-10) | 850 (454) | 3.1 | 16.0 | 1 | 3 | 0 |
| Methyl alcohol | 52 (11) | 867 (464) | 6.0 | 36.0 | 1 | 3 | 0 |
| Methyl ethyl ketone | 16 (-9) | 759 (404) | 1.4 | 11.4 | 1 | 3 | 0 |
| Naphtha, coal tar (continued) | 107 (42) | 531 (277) | 2 | 2 | 0 | | |

61.5 – Exhibit 02 – Fire Hazard Properties of Flammable/Combustible Liquids, Gases, and Volatile Solids (Condensed from NFPA 325M) (contd.)

| Flammable/ Combustible Liquid | Flash Point °F (°C) | Ignition Temperature °F (°C) | Flammable Limits | | Hazard Class | | |
|--|---------------------------|------------------------------------|-------------------|-------|---|---|---|
| | | | Percent by Volume | | (H = Health, F = Flammability R = Reactivity) | | |
| | | | Lower | Upper | H | F | R |
| Naphtha, varnish markers' and painters' | 28 (-2) | 450 (232) | 0.9 | 6.0 | 1 | 3 | 0 |
| Petroleum ether (Benzin) | 0 (-18) | 550 (288) | 1.1 | 5.9 | 1 | 4 | 0 |
| Phenol (Carbolic acid) | 175 (79) | 1319 (715) | 1.8 | 8.6 | 3 | 2 | 0 |
| Pine oil | 172 (78) | 0 | 2 | 0 | | | |
| Propyl alcohol (Propanol) | 74 (23) | 775 (412) | 2.2 | 13.7 | 1 | 3 | 0 |
| Quenching oil | 365 (185) | 0 | 1 | 0 | | | |
| Toluene | 40 (4) | 896 (480) | 1.1 | 7.1 | 2 | 3 | 0 |
| Transformer oil | 295 (146) | 0 | 1 | 0 | | | |
| Turpentine | 95 (35) | 488 (253) | 0.8 | 1 | 3 | 0 | 0 |

The flammability hazard depends to a certain extent on the liquid exposed and the volume of the room or building. In a large, open room, a small quantity of flammable liquid may not produce sufficient vapors to make the atmosphere flammable except in the immediate vicinity. If the quantity is sufficient to make the entire atmosphere flammable, a further increase in quantity may not increase the hazard, but does provide more fuel for continuing fire.

Minimum flash points for fuel oils of various grades are: No. 1 and 2, 100 °F (38 °C); No. 4, 110 °F (43 °C); No. 5, 130 °F (54 °C); No. 6, 150 °F (65-1/2 °C) or higher (ex. 02). Actual flash points are commonly higher and are required to be higher by some State laws. No. 1 fuel oil is often sold as kerosene, range oil, or coal oil.

61.51 – Special Concerns.

61.51a – Density. With few exceptions (carbon disulfide is one), flammable liquids are lighter than water and can float on the water's surface. Some flammable liquids, such as acetone and alcohol, however, can dissolve in and completely mix with water.

61.51b – Vapor Density. Vapor density is the volume weight of pure gas compared to an equal volume weight of dry air. A figure greater than 1 indicates that a gas is heavier than air. This means that any escaped vapors settle downward onto floors and flow with air currents around corners and down stairs or shafts to pool in low spots.

If the source liquid is open and a continuous supply of vapor is flowing, a spark anywhere along the vapor trail (perhaps hundreds of feet or several floors away) can set off an explosion and a fire that may envelop an entire building almost instantly.

61.51c – Toxicity. Trichloroethylene, perchloroethylene, and similar nonflammable solvents are more toxic than gasoline or naphtha. Nontoxic, noncorrosive, nonflammable, nonacidic, noncaustic solvents that are biodegradable are recommended for substitution when possible (FSM 2160, 2162.2, and 2163.5).

61.51d – Storage. Specific standards for storing flammable/combustible liquids are in NFPA 30 and 395, 29 CFR 1910.106 and 1910.144, and ANSI Z5351-91. Refer to section 38.12 for further direction.

Do not allow sources of ignition where flammable liquids are stored or used, or where there is a possibility of leaks from piping or storage containers. One common precautionary measure is to ensure that there is no open-flame heating. Provide explosion-proof electrical wiring and equipment for hazardous (classified) locations (NFPA 70). Treat unmarked containers of liquid as flammable.

1. **Outside Above-ground Tanks.** Such tanks are used for large quantity storage. Approved tanks must be vented, protected from physical damage, and signed. Tank design, construction, and location shall be in compliance with regulations in 29 CFR 1910.106.

2. **Containers and Portable Tanks.** Generally, the quantity of flammable or combustible liquids to be stored in individual drums or other containers shall not exceed 60 gallons (227 L); individual portable tanks shall not exceed 660 gallons (2498 L). For specific requirements, refer to 29 CFR 1910.106(d).

3. **Inside Storage.** All doors must open outward from flammable/combustible liquid storage areas. Post appropriate signs inside and outside buildings and locations storing flammables. Prohibit open flames or sparks within 50 feet (15-1/2 m) of flammables. Provide positive ventilation to prevent accumulation of vapors. Protect electric light bulbs to avoid accidental breakage. Fixtures and switches must be vapor- and spark-proof or explosion-proof where explosion hazards exist.

4. **Incidental Storage or Use of Flammable/Combustible Liquids.** Adequate precautions must be taken to prevent the ignition of flammable vapors. Sources of ignition include, but are not limited to, open flames; lightning; smoking; cutting and welding; electrical and mechanical sparks; spontaneous ignition, including heat producing chemical reactions; and radiant heat.

- a. Store such liquids in an NFPA-approved storage cabinet and label it "Flammable – Keep Fire Away."
- b. Do not store more than 60 gallons (227 L) of Class I or Class II liquids in a storage cabinet.
- c. Use an NFPA-approved safety container for storing and dispensing small quantities of flammable liquids. The approved container for this purpose shall have not more than a 5-gallon capacity, shall have a spring-closing lid

and a spout cover, and shall be designed so it safely relieves internal pressure when subjected to fire exposure (ex. 01, sec. 61.5).

- d. Do not use a safety container that leaks when upright or leaks more than 4 drops per minute when inverted. **Do not weld or solder these containers.** Destroy defective safety containers.
- e. Always place a portable fuel container on the ground prior to filling to dissipate static electricity. Bed liners create excellent insulation, preventing static electricity from bleeding off the gas can to the truck body, through the tires, and to the ground. Static is generated from the flow of gasoline through the hose, and when the nozzle is removed from the gas can, a spark can cause the vapors to ignite.
- f. Do not store more than one day's supply of gasoline or other flammable liquid on equipment, unless the vehicle is a fuel supply truck that is properly placarded, labeled, and designed for that purpose.
- g. Keep gasoline in warehouses with assembled fire-suppression units only if not more than one 5-gallon (19 L) can is assigned to each unit. Such storage must also conform with local laws and not exceed 25 gallons (94-1/2 L). When the fire season is over, remove gasoline cans from the units and store them in approved flammable storage buildings or cabinets.
- h. Never store flammable/combustible liquids in office areas, except those required for maintenance and operation of building and equipment. Such storage must be in closed metal containers in a storage cabinet or in safety containers.
- i. Store kerosene in dwellings in 2-gallon (7-1/2 L) closed safety containers. Storage shall be away from flames and sparks and in locations where the temperature is below 100 °F (38 °C).
- j. **Do not store or transport flammables and radio equipment in the same truck compartment or storage building.**

Do not dispose of flammable/combustible liquids in sewer drains, storm drains, or floor drains.

- k. Provide portable fire extinguisher(s), and control equipment in such quantities and types as are needed for the special hazards of operation and storage.
- l. Ensure that all fire protection equipment and supplies are adequately maintained and periodically inspected and tested by a competent person to ensure they are in satisfactory operating condition and will serve their purpose in time of emergency.
- m. Always maintain unobstructed aisles, stairways, passageways, and exits for movement of personnel.
- n. Ensure that maintenance and operating practices are in accordance with established procedures that tend to control leakage and prevent accidental escape of flammable or combustible liquids.

61.51e – Dispensing.

1. **General Safety.** Ensure that all handling and dispensing of flammable liquids is done in a well-ventilated area free of sources of ignition, and provide bonding between the dispensing equipment and the container being filled.
 - a. Use dispensing pumps approved by the Underwriters' Laboratories (UL) or Factory Mutual Liability Insurance Company of America. Pumps generally are the best means of withdrawing flammable liquids from tanks or drums because the flow can be controlled.
 - b. Where faucets are used on tanks or drums, provide the spring-closing type that flow only while manually held open. Blocking such faucets open is not permitted.
 - c. Ground and bond gravity flow dispensing units to prevent a build up of static electricity (ex. 01).
2. **Cleanliness.** Cleanliness is essential where combustible or flammable liquids are handled.
 - a. Wipe up spilled gasoline, kerosene, or oil at once.
 - b. Use sand, dry earth, or special oil-absorbent compound, not sawdust, to soak up spills. Wash off any part of the body that has been exposed to petroleum products immediately.
 - c. Keep combustible waste material and residues to a minimum. Store them in covered metal receptacles, and dispose of them daily.

61.51e – Exhibit 01 – Grounding and Bonding



Grounding and Bonding

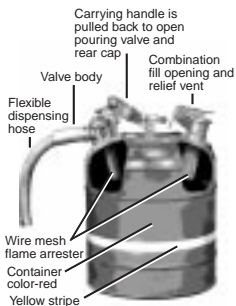

Type II Safety Can



Grounding and Bonding Spill Containment

- d. Use nontoxic cleaners to remove oil from metal parts.
 - e. Replace gas- and oil-soaked wood floors with a nonabsorbent surface, or remove old flooring from inside the building or platform.
3. **Gasoline Dispensing Units and Associated Buildings.**
- a. Do not dispense gasoline in enclosed buildings.
 - b. Post flammable material signs on the outside of gasoline storage buildings. Prohibit all flammable material within 50 feet (15-1/2 m) of the dispensing station and buildings.
 - c. When filling tanks, leave vapor above the liquid level to permit expansion with rising temperatures.
 - d. Shut engines off and set the parking brake before filling fuel tanks on vehicles or equipment.
 - e. Ground the delivery hose or gasoline container before contacting the hose nozzle or can spout against the container being filled.
 - f. Do not fill portable containers while they are located inside the trunk, in the passenger compartment of a vehicle, or in a pickup truck with a bed liner.
 - g. Do not use static-generating materials to wipe up spilled gasoline or flammables.
 - h. Provide gasoline dispensing units and buildings with explosion-proof wiring, switched, outlets, and lights. Ensure that electrical maintenance does not compromise explosion-proof wiring or fixtures.
 - i. Use dispensing hoses of the retractable type and protect them from physical damage.

61.6 – Flammable Gases.

61.61 – General Safety. Flammable gases generally present hazards similar to flammable liquids. Gases that mix with air burn rapidly and explode if there is an ignition source. Refer to NFPA 58 for specific information on storage and handling (ex. 01).

The density of a gas affects its behavior when it escapes and consequently affects its hazard. Heavier gases have a greater probability of coming in contact with sources of ignition (ex. 02).

Some gases are odorized to assist in detecting their presence, but smell is only a rough estimator of the hazard.

61.61 – Exhibit 01 – Characteristics of Gases in Common Use

| Gas | Color Compared to Air | Odor When Breathed | Weight When Shipped | Flammable State | Effect | Physical | Remarks |
|----------------|-----------------------|--------------------|---------------------|-----------------|------------|-----------|--|
| Acetylene | None | Garlic-like | Lighter | Yes | Anesthetic | Dissolved | Wide explosive range when mixed with air or oxygen |
| Compressed Air | None | None | Same | No | None | Gas | Supports combustion |
| Ammonia | None | Pungent | Lighter | Yes | Irritant | Liquid | Does not support combustion |
| Argon | None | None | Heavier | No | None | Gas | Does not support combustion |
| Carbon Dioxide | None | Faint | Much heavier | No | None | Liquid | Does not support combustion |

(continued)

61.61 – Exhibit 01 – Characteristics of Gases in Common Use (contd.)

| Gas | Color Compared to Air | Odor When Breathed | Weight When Shipped | Flammable State | Effect | Physical | Remarks |
|-----------------|-----------------------|--------------------|---------------------|-----------------|------------|----------|--|
| Carbon Monoxide | None | Faint | Lighter | Yes | Asphyxiant | Gas | Supports combustion |
| Chlorine | Greenish-Yellow | Disagreeable | Much heavier | No | Irritant | Liquid | Not explosive/flammable; will support combustion |
| Freon-12 | None | None | Heavier | No | None | Liquid | Does not support combustion |
| Helium | None | None | Much lighter | No | None | Gas | Does not support combustion |
| Hydrogen | None | None | Much lighter | Yes | None | Gas | Wide explosive range when mixed with air or oxygen |

(continued)

61.61 – Exhibit 01 – Characteristics of Gases in Common Use (contd.)

| Gas | Color Compared to Air | Odor When Breathed | Weight When Shipped | Flammable State | Effect | Physical | Remarks |
|-----------------|-----------------------|-------------------------------|---------------------|-----------------|--------------------------------------|----------|---|
| Methyl Bromide | None | Pungent | Heavier | No | Irritation Intoxication Nausea | Liquid | Does not support combustion |
| Methyl Chloride | None | Ether-like | Heavier | Yes | Anesthetic | Liquid | Explosive when mixed with air or oxygen |
| Nitrogen | None | None | Slightly lighter | No | None | Gas | Does not support combustion |
| Oxygen | None | None | Slightly heavier | No | None | Gas | Supports combustion |
| Propane | None | None or artificially odorized | Heavier | Yes | Intoxicant | Liquid | Flammable |
| Sulphur Dioxide | None | Disagreeable | Much heavier | No | Irritant | Liquid | Does not support combustion |

61.61 – Exhibit 02 – Vapor Densities of Certain Nonflammable Gases

| <i>Air=1</i> | | | |
|----------------|------|-----------------|------|
| Carbon dioxide | 1.52 | Nitrogen | 0.97 |
| Chlorine | 2.40 | Nitrous oxide | 1.53 |
| Helium | 0.13 | Propane | 1.52 |
| Hydrogen | 0.07 | Oxygen | 1.10 |
| Neon | 0.67 | Sulphur dioxide | 2.20 |

61.62 – Liquefied Petroleum Gas.

1. Store liquefied petroleum (LP) gas containers, including portable tanks, outside in a well-ventilated area that is protected from physical damage. Store all portable LP gas bottles upright and restrained. Never drop tanks. Install tanks in accordance with the placement shown in exhibit 01.

2. Mount tanks on level, durable pads. Design pads with sufficient support for the weight of the tank. Each LP gas installation must be inspected and approved by a competent person.

3. Inspect tanks for corrosion and damage at the beginning of each work season. Containers showing serious dents, bulging, gouging, or excessive corrosion shall be removed from service and destroyed.

4. Use only DOT-approved tanks. Clearly label tanks and containers to identify contents and capacity. Approved tanks have specifications stamped into tank body. Use only a container furnished by a distributor for bottled gas.

5. Paint tanks only with the permission of the owner. Use heat-reflective paint.

6. Protect tanks and lines from environmental conditions, such as snow, to prevent broken connections. Install tanks on firm foundations, with nonmetallic straps for holding tanks upright and pipes

61.62 – Exhibit 01 – LP Gas Storage Tank Installation

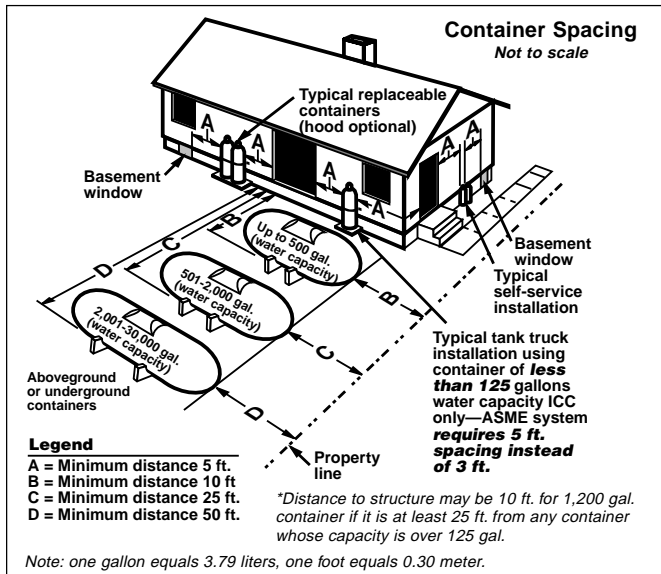

in position. Where below-freezing temperatures occur, use only bottled gas that does not freeze. Protect distribution lines from freezing up.

7. Distribute gas with wrought iron or steel (black or galvanized), brass, copper, or polyethylene pipe. Pipe shall comply with applicable ASTM and ANSI standards. Piping should enter sides of buildings. Never place pipe in a crawl space or pit. Cavities formed by drifting snow have the potential of trapping gas vapors around tanks. Protect supply lines from damage. Keep weeds, brush, and other foliage away from tanks.

8. Prohibit open flames within 25 feet (7-1/2 m) of storage tanks.

9. Ensure that all gas containers are transported, stored, and secured with the safety valve protected by a ventilated cap or collar.

10. Inspect gas regulators periodically using recognized dealers and/or their maintenance personnel.

11. Tightly close the cylinder valve when the tank is not in use or when it is empty.

12. Never allow LP gas to contact skin or clothing.

61.7 – Pesticides. The field of pesticide use and management is extremely complex, constantly changing, and subject to many laws and regulations. Before using or disposing of any pesticide, check with the responsible Forest Service Pesticide Coordinator. The project planner, handler, user, and applicator are responsible for safety in use of pesticides.

Direction on the specific hazards encountered by exposure through handling, mixing, and application and preventive measures is in FSM 2167.12. Follow the direction in FSM 2150; chapter 40 of FSH 2109.14; and sections 22.1 and 61.32b of this Handbook to ensure proper storage, transportation, disposal, and handling of pesticides.

61.71 – Safety Practices. Do not use a pesticide without following the information on the label or MSDS.

Apply pesticides so that they do not endanger humans, livestock, crops, beneficial insects, fish, or wildlife. Avoid inhaling pesticide sprays or dusts. Do not apply pesticides when there is danger of drift that may contaminate water or leave illegal residues. Wear PPE as identified by the MSDS, JHA, or manufacturer.

61.71a – Storage. Store pesticides that are flammable/combustible liquids in accordance with NFPA 30 and 395. Store pesticides that are oxidizing agents in accordance with NFPA 43A.

1. Do not store pesticide quantities exceeding 200 gallons (757 L) with other flammable materials.

2. Store all pesticides in the original labeled container. Never store unused pesticides in a food, feed, medicine, or beverage container.

3. Frequently check containers for leaks, tears, or loose lids. If containers are in poor condition, put contents in a suitable con-

tainer and label properly. Protect the labels of pesticide containers so that they remain legible.

4. Always store pesticides in rooms away from food, feed, or water. Segregate and store each pesticide formulation under a sign containing the name of the formulation.

5. Never store combustible materials in direct sunlight. Excessive heat or extreme cold adversely affect some chemicals, so check the MSDS and the label for special storage requirements.

6. Store herbicides away from other pesticides or fertilizers.

61.71b – Transportation of Pesticides. Pesticides labeled with the signal words “Danger Poison” (skull and cross bones) or “Warning” are considered highly or moderately toxic, respectively. Transport these pesticides to and from the worksite, with any related equipment, outside the passenger-carrying portion of vehicles, such as in trailers and pickup beds.

Pesticides labeled “Caution” are considered slightly toxic and, when necessary, may be transported inside the passenger-carrying portion of vehicles.

In all transportation situations, the following apply:

1. All pesticide drums, cans, bottles, and jugs shall be securely capped and protected from breakage or spillage. Ripped or punctured bags or cardboard containers will be put into plastic bags, or otherwise contained, to prevent leakage.

2. Pesticide containers and application equipment, such as a hypo-hatchet or tree injectors, shall be stored in the vehicle in a locked, leakproof case or enclosure. Label the case or enclosure to identify the contents and potential hazard. Separate the case or enclosure from people, and securely anchor it to the vehicle to minimize damage or spillage in the event of an accident. Pesticides shall not be transported in application equipment.

3. Original pesticide containers shall display the EPA approved label.

4. Service containers (any container used to hold, store, or transport a pesticide concentrate or diluted preparation, other than

the original labeled container) shall be labeled as follows:

a. **Pesticide Concentrate:**

- (1) Product name.
- (2) EPA registration number.
- (3) Name and percentage of active ingredient.
- (4) Signal word(s) from registered label.

b. **Diluted Preparation:**

- (1) Product name preceded by the word "Diluted."
- (2) EPA registration number preceded by the words "Derived From."
- (3) Name and percent of active ingredient as diluted.
- (4) Signal word(s) from registered label.

61.71c – Disposal. When transporting or shipping pesticides or pesticide containers for the purpose of disposal (FSM 2167.12), the following apply:

1. The containers must be clearly marked "This product is for disposal only" in addition to the registered product label.
2. When the registered label is unreadable, an ingredient statement is required. When the ingredients are not known, a statement to that effect must appear on the containers.
3. Each container must bear the name, address, and telephone number of the person to be contacted in case of an accident or emergency.
4. If the container contains a highly toxic substance, a warning of the potential hazard (such as a skull and crossbones label) shall be prominently displayed in red.

Some States may have unique requirements regarding the transportation of pesticides for disposal. Contact lead State agencies before transporting the material.

61.8 – Asbestos. Asbestos is used in the manufacture of heat-resistant clothing, automotive brake and clutch linings, and a variety of building materials. Exposure occurs when the asbestos containing material is abraded or otherwise disturbed.

Forest Service employees may be exposed to asbestos when working with brake drums in motor vehicle repair shops

(sec. 39.74a) or when working in buildings with asbestos insulation or pipe coverings. Activities involving friable asbestos-containing materials shall be performed by individuals accredited through the Environmental Protection Agency's (EPA) Asbestos Model Accreditation Plan (MAP) or an EPA-approved State accredited training program. The accreditation and training requirements are applicable to all Forest Service employees, volunteers, SCSEP personnel, and contractors. Forest Service employees shall not remove friable asbestos products (FSM 6743.2).

No employee shall be exposed to asbestos above the permissible exposure limits (PELs).

61.81 – Procedures.

1. Before beginning remodeling work on facilities, a competent person shall check for the presence of asbestos containing materials.

- a. If asbestos exposure is suspected, take air samples to determine the extent of contamination, if any.
- b. If air samples identify asbestos in the air, notify and provide protection for workers. Engineering controls that remove or enclose the asbestos are the best methods. Administrative controls, such as decreasing or eliminating employee exposure by moving employees or changing work schedules, are acceptable.

2. Refer to 29 CFR 1910.1001 and 29 CFR 1926.58 for specific requirements related to exposure monitoring; regulated areas; methods of compliance; respiratory protection; protective work clothing and equipment; hygiene facilities and practices; communications of hazards to employees (training); housekeeping; and medical surveillance, record keeping, and observation of monitoring.

61.9 – Lead. Employees occupationally exposed to lead during construction work projects and activities shall comply with the requirements in 29 CFR 1926.62. Refer to FSM 2167.17 and 29 CFR 1910.1025 for additional direction and requirements.

62 – EXPLOSIVES AND BLASTING AGENTS. All Forest Service employees who work with, monitor work, or inspect work involving explosives and blasting agents must be trained to recognize unsafe work practices and to ensure the safety of the public, Government employees, property, and natural resources.

All work with explosives and blasting agents shall be under the direct supervision of a qualified blaster, who by virtue of certification and experience, shall be designated the blaster-in-charge.

All work shall comply with Federal, State, and local laws in accordance with FSM 6745 and the “Guide for Using, Storing, and Transporting Explosives and Blasting Materials” (sec. 62.06).

Only those explosives and blasting agents approved by the Washington Office, Human Resources Management Staff, Branch Chief for Safety and Health shall be permitted for use on Forest Service land.

62.01 – Authority. The requirements and constraints for the use of explosives and avalanche ammunition are in:

1. Title 27, Code of Federal Regulations (27 CFR) Part 55, Storage.
2. 29 CFR 1910.109, Explosives and blasting agents; and Part 1926, Subpart U, Blasting and the use of explosives.
3. 30 CFR Parts 56 and 57, Subpart E, Explosives.
4. 33 CFR Parts 125 and 126, Identification credential for persons requiring access to waterfront facilities or vessels and handling of Class I (explosive) materials or other dangerous cargoes within or contiguous to waterfront facilities.
5. 49 CFR Parts 100-177 and 300-399, The authority for transportation of explosives and hazardous materials.
6. FSM 6745, Explosives and Blasting Agents.

62.06 – Reference. U.S. Department of Agriculture, Forest Service. Guide for Using, Storing, and Transporting Explosives and Blasting Materials. 9271-2815. Missoula, Montana: Missoula Technology and Development Center, Forest Service.

62.1 – Personnel Qualifications. Storing, transporting, and using explosives and blasting agents is complex and requires specialized training. Employees engaged in these activities should consult their local Blaster/Examiner for specific regulations and direction on qualifications.

**CHAPTER 70 – JOB HAZARD ANALYSIS
(FORM FS-6700-7) AND
PERSONAL PROTECTIVE EQUIPMENT**

Contents

- 71 JOB HAZARD ANALYSIS (FORM FS-6700-7)**
- 72 PERSONAL PROTECTIVE EQUIPMENT**

CHAPTER 70 – JOB HAZARD ANALYSIS (FORM FS-6700-7) AND PERSONAL PROTECTIVE EQUIPMENT

71 – JOB HAZARD ANALYSIS (Form FS-6700-7). Exhibit 01 contains a sample of a completed Job Hazard Analysis (JHA) (Form FS-6700-7).

71 – Exhibit 01 – Job Hazard Analysis (Form FS-6700-7)

| | | | |
|---|---|---|---|
| | | FS-6700-7 (3/98) | |
| U.S. Department of Agriculture Forest Service | 1. WORK PROJECT/ACTIVITY | 2. LOCATION | 3. UNIT |
| | 4. NAME OF ANALYST MTDC Safety/Health Group | Missoula Technology and Development Center (MTDC) 5. JOB TITLE Safety/Health Management | MTDC 6. DATE PREPARED 1/14/99 |
| 7. TASKS/PROCEDURES | 8. HAZARDS | 9. ABATEMENT ACTIONS | |
| OFFICE WORK: Administrative Work Activities - Extensive sitting at work station and alternate work stations, such as meetings, training, and others. | | Engineering Controls * Substitution * Administrative Controls * PPE Qualifications: For field crews and office personnel include the following: 1. Each field crew and office group shall be trained in First Aid/CPR or have at least one person certified to render First Aid/CPR. 2. Prior to using a global positioning system (GPS), employees shall be trained and familiar with the advantages and disadvantages of GPS. 3. Employees and their supervisors shall utilize tailgate safety sessions to address safety concerns. Required Training : Haz-mat Communications First Aid/CPR Defensive Driving (every 3 years) | |

71 – Exhibit 01 – continued

| | | |
|-------------------------|--|---|
| Ergonomics | <p><u>Physical</u> : Preventing fatigue and muscular or skeletal injuries resulting from extensive sitting and similar sedentary types of work. Back, Hand, and Eye Injury</p> | <p>Follow safe sitting and workstation practices. Maintain recommended workstation setup and alignment with adequate illumination and furnishings. Recommend Personal Protective Equipment: Use chairs with arm rests and adjustable height, supplemented with adjustable foot rest (if needed) to ensure healthful work posture. Training through available videos and other commercial materials should be part of employee's safety orientation.</p> |
| Walking Surfaces | <p><u>Physical</u>: Slips, Trips, and Falls</p> <p><u>Environmental</u>:</p> | <p>Take frequent breaks. Practice stretching exercises and relaxing techniques.</p> <p>Keep individual work areas and storage rooms clean, orderly, and free of tripping/slipping hazards. Ensure that the means of ingress/egress are available and sufficiently lighted at all times. Use hand rails when going up or down stairways.</p> |
| Lifting | <p><u>Physical</u>: Back Injury</p> | <p>Use sand or equivalent on icy surfaces such as the porch and on the outside stairways.</p> <p>Ask for help if load is heavy. Do not try to lift or otherwise move material beyond ability; reduce weight of object by packing smaller parcels instead of one large one. Use mechanical devices to help lift and move materials.</p> |
| Material Storage | <p><u>Physical</u>: Falling Objects</p> | <p>Remove materials from top of file cabinets, bookcases, any location above shoulder height. Use suitable step stool or ladder to avoid lifting above shoulder height.</p> |

71 – Exhibit 01 – continued

| | |
|-------------------|--|
| Electrical Shock | Do not use extension cords in place of permanent wiring circuits. Locate cords away from heat sources and protect from abrasion, crushing, and kinking. Disconnect cords only by pulling on the plug. Never knot a cord. Inspect and replace damaged or frayed electrical cords. Do not overload circuits. Shut off power before working on any machines. Never touch appliances, tools, or machines with wet hands while grounded or touching plumbing pipes or faucets. |
| Chemical Storage | <p><u>Physical/Chemical:</u> Fire, Chemical fumes.</p> <p>Incidental storage of flammables/combustibles must be in an NFPA approved storage cabinet and labeled "Flammable - Keep Fire Away." Never store flammable/combustible liquids in office areas except those required for maintenance and operation of building and equipment. Such storage must be in closed metal containers in a storage cabinet or in safety containers. Refer to the MTDC Hazardous Materials Management Plan (hard copy in permanent files and posted in coffee room).</p> |
| Personal Security | <p><u>Physical:</u> Violence</p> <p>If you plan to work after office hours, let someone know your intentions. Give this person an idea of the time you plan to spend at the office. Park your vehicle where you can take advantage of the shortest route of travel to and from the building.</p> <p>Refer to Occupant Emergency and Self-protection Plan.</p> |
| Bldg. Evacuation | <p>Refer to Occupant Emergency and Self-protection Plan.</p> |

71 – Exhibit 01 – continued

TRAVEL ON OFFICIAL BUSINESS:

Physical:
Stress/Fatigue

Follow established work/rest guidelines, a 12-hour work day is the maximum allowed for any Center activity (non-emergency), of which only 10 hours may be spent driving. When driving, stop for a break at least every 2 hours.

Driving

Physical:
Type of Vehicles

Select appropriate vehicle for work needs and location to be traveled. Familiarize yourself with the vehicle and know where the controls are, especially when using rental vehicles.

Review maps and plan route of travel prior to beginning trip.

Drive defensively. A 4-hour driver refresher training course is required every 3 years. All motor vehicles on official business (government, leased or privately owned) involved in an accident must be reported regardless of the dollar amount.

Environmental:
Weather

Sudden changes in climatic conditions require adjusting to different driving situations. Do not drive in adverse weather conditions if trip can be delayed. Avoid being rushed, you will need more time to prepare the vehicle and get to your destination. In fall and winter, remove all frost, ice, and snow before driving. Make sure vents are clear of snow to provide adequate airflow for defrosting.

Physical:
Off Highway Driving

Prior to driving on mountain roads, check with local unit or district regarding logging traffic and other concerns (construction, washouts, blow downs, closures, etc.). Proceed slowly around corners and drive on the right side. Be able to stop within 1/2 your viewing distance.

71 – Exhibit 01 – continued

Aircraft Flights Commercial and Contract

Physical:
Personal injury from turbulent air. Hearing loss

The pilot in command is responsible for the safety of the aircraft, occupants, and cargo. Pilots have complete authority to postpone, change, or cancel flights when they believe existing or impending conditions make them unsafe.

Hearing protection is required for aircraft with dba 85 and above.

Make sure you receive a briefing on operational and emergency procedures. Ensure that passengers observe safety requirements and understand and obey instructions from aviation personnel and pilots. Inform pilot if you observe a hazard. Only fly in commercial aircraft and carded contract Forest Service approved aircraft with certified pilots.

Always wear seat belts during take off and landings and as requested by the pilot.

Required PPE for field work projects and activities include: hardhat; gloves; long-sleeved shirt; 8" leather, lace-up boots with nonskid soles; personal communications device. JHA may identify specific or additional PPE.

Always have communications, i.e., radio or cell phone for field work. Get a hand-held radio from the communication shop and have it programmed for the location of your project work. When you arrive on the unit that you will be working on notify dispatch that you have radio communications and that if you have problems you will be contacting them for assistance.

Field Work

Physical:
Falling Objects, Slips, Trips, and Falls

71 – Exhibit 01 – continued

| | | |
|---|---|---|
| <p>Personal Security</p> <p>Emergency Evacuation Procedures</p> | <p><u>Environmental:</u> Wind, Rain, Snow, and Intense Sun</p> <p><u>Biological:</u> Insects, Poisonous Plants, and Animals</p> <p><u>Physical:</u></p> <p>Accident/Injury</p> | <p>Always carry PPE for changing weather conditions. Listen to weather forecasts and plan field work projects and activities accordingly. Use adequate UV protection, such as sun glasses and sunscreen.</p> <p>Be alert to hazards associated with insects, animals, and poisonous plants. First aid/body fluids barrier kits shall be readily accessible.</p> <p>Line officer or competent person must approve and document the assignment of employees to work alone. If it is determined that there is significant potential hazard to a lone worker, additional personnel shall be assigned. When in travel status, leave an itinerary at the front desk. Include destination, departure/return times, and a point of contact, such as a phone number, where your family and the Center can reach you in case of an emergency. Refer to Occupant Emergency and Self-protection Plan.</p> <p>Refer to Emergency Evacuation Instructions on the JHA Instruction Sheet.</p> |
| <p>10. LINE OFFICER SIGNATURE /s/ John E. Steward</p> | <p>11. TITLE Manager</p> | <p>12. DATE 1/14/99</p> |

Previous edition is obsolete

(over)

71 – Exhibit 01 – continued

| JHA Instructions (References-FSH 6709.11 and 6709.12) | Emergency Evacuation Instructions (Reference FSH 6709.11) |
|---|---|
| <p>The JHA shall identify the location of the work project or activity, the name of employee(s) involved in the process, the date(s) of acknowledgment, and the name of the appropriate line officer approving the JHA. The line officer acknowledges that employees have read and understand the contents, have received the required training, and are qualified to perform the work project or activity.</p> <p>Blocks 1, 2, 3, 4, 5, and 6: Self-explanatory.</p> <p>Block 7: Identify all tasks and procedures associated with the work project or activity that have potential to cause injury or illness to personnel and damage to property or material. Include emergency evacuation procedures (EEP).</p> <p>Block 8: Identify all known or suspect hazards associated with each respective task/procedure listed in block 7. For example:</p> <ul style="list-style-type: none"> a. Research past accidents/incidents. b. Research the Health and Safety Code, FSH 6709.11 or other appropriate literature. c. Discuss the work project/activity with participants. d. Observe the work project/activity. e. A combination of the above. | <p>Work supervisors and crew members are responsible for developing and discussing field emergency evacuation procedures (EEP) and alternatives in the event a person(s) becomes seriously ill or injured at the worksite.</p> <ul style="list-style-type: none"> a. Be prepared to provide the following information: b. Nature of the accident or injury (avoid using victim's name). c. Type of assistance needed, if any (ground, air, or water evacuation). d. Location of accident or injury, best access route into the worksite (road name/number). e. Identifiable ground/air landmarks. f. Radio frequencies. g. Contact person. h. Local hazards to ground vehicles or aviation. i. Weather conditions (wind speed & direction, visibility, temperature). j. Topography. k. Number of individuals to be transported. l. Estimated weight of individuals for air/water evacuation. <p>The items listed above serve only as guidelines for the development of emergency evacuation procedures.</p> |

71 – Exhibit 01 – continued

| | |
|---|---|
| <p>Block 9: Identify appropriate actions to reduce or eliminate the hazards identified in block 8. Abatement measures listed below are in the order of the preferred abatement method:</p> <ul style="list-style-type: none"> a. Engineering Controls (the most desirable method of abatement). For example, ergonomically designed tools, equipment, and furniture. b. Substitution. For example, switching to high flash point, non-toxic solvents. c. Administrative Controls. For example, limiting exposure by reducing the work schedule; establishing appropriate procedures and practices. d. PPE (least desirable method of abatement). For example, using hearing protection when working with or close to portable machines (chain saws, rock drills, and portable water pumps). e. A combination of the above. <p>Block 10: The JHA must be reviewed and approved by a line officer. Attach a copy of the JHA as justification for purchase orders when procuring PPE.</p> <p>Blocks 11 and 12: Self-explanatory.</p> | <p style="text-align: center;">JHA and Emergency Evacuation Procedures Acknowledgment</p> <p>We, the undersigned work leader and crew members, acknowledge participation in the development of this JHA (as applicable) and accompanying emergency evacuation procedures. We have thoroughly discussed and understand the provisions of each of these documents:</p> <p>_____</p> <p style="text-align: center;">Supervisor's Signature</p> <p style="text-align: center;">Supervisor's Name</p> <p>_____</p> <p style="text-align: center;">Crew Work Leader</p> <p>_____</p> <p>_____</p> <p>_____</p> <p>_____</p> <p>_____</p> <p>_____</p> <p>_____</p> |
|---|---|

72 – PERSONAL PROTECTIVE EQUIPMENT. Exhibit 01 lists the personal protective equipment (PPE) required for work projects and activities and includes cross-references to related direction in this Handbook. Additional PPE may be justified in the JHA.

**72 – Exhibit 01 – Personal Protective Equipment (PPE)
Required for Specific Work Projects and Activities**

| FSH 6709.11 Reference | Work Project/Activity | PPE |
|--------------------------------------|--|---|
| 21.22 14 | All Work Projects/Activities Air Operations – General | <ul style="list-style-type: none"> –Appropriate first aid kit –Hearing protection (85 dB and above) –Fire extinguisher(s) |
| 14 | Air Travel (Fixed Wing) | <ul style="list-style-type: none"> –Survival kit (when required by JHA) –Maps of operating area |
| 14 | Air Travel (Rotor Wing) | <ul style="list-style-type: none"> –Tool kit to be identified by local personnel –Forest Service-approved hardhat with chin strap –Forest Service-approved flame-resistant clothing –Gloves (flame-resistant fabric or leather, Forest Service-approved) –Eye protection |
| 14 | Aerial Photography | <ul style="list-style-type: none"> –Appropriate clothing for varying altitudes/climatic conditions –Specialized equipment identified in JHA for “door off” operations |
| 13.22 | All-Terrain Vehicle (ATV) | <ul style="list-style-type: none"> –Fire extinguisher –Personal communications device –Motorcycle helmet – full face or three-quarter face (mouth guard recommended when using three-quarter face helmet, goggles, or face shield) that meets Department of Transportation (DOT), American National Standards Institute (ANSI 90.1), or Snell Memorial Foundation (SMF) standards –Long pants, long-sleeved shirts or jacket, leather gloves –Appropriate footwear |

72 – Exhibit 01 – continued

| FSH 6709.11 Reference | Work Project/Activity | PPE |
|--------------------------------------|------------------------------|---|
| 22.35c | Archaeological Work | <ul style="list-style-type: none"> -Gloves and eye protection -Personal communications device |
| 11.21 | Back Country Travel | <ul style="list-style-type: none"> -Map and compass -Matches/fire starter (waterproof container) -Water or water purifier -Supply of food for one to three days -Flashlight (extra batteries and bulb) -Personal communication device -Lightweight shelter and appropriate clothing for climatic conditions -Eye protection and sunscreen -Helmet (ANSI Z90.1 Standard, Snell, or ASME approved) -Gloves and eye protection |
| 17.3 | Bicycle Safety | <ul style="list-style-type: none"> -Rear-facing red reflector and/or red lamp on back of bicycle -Colorless or amber reflector in spokes of front wheel -Amber or red reflector in spokes of rear wheel -Forest Service-approved hardhat -High-visibility vest -Eye protection |
| 62 | Blasting | <ul style="list-style-type: none"> -Hearing protection (85 dB and above) -Forest Service-approved hardhat -High-visibility vest -Eye protection, gloves |
| 27.61b | Bridge Inspection | <ul style="list-style-type: none"> -Forest Service-approved hardhat -High-visibility vest -Eye protection, gloves |

72 – Exhibit 01 – continued

| FSH | 6709.11 | Reference | Work Project/Activity | PPE |
|--------|---------|-----------|---|---|
| 25.15b | | | Brushing and Brush Piling | <ul style="list-style-type: none"> –Appropriate footwear as identified in JHA for specific inspections –Lifelines –Dust mask or respirator –Personal flotation device (USCG approved) –Forest Service-approved hardhat –Eye protection –Hearing protection (85 dB and above) –Gloves, long-sleeved shirt –Heavy-duty, cut-resistant or leather, waterproof or water-repellent, 8-inch high laced boots with nonskid soles (Condition of Hire Policy – FSM 6716.03) |
| 22.48c | | | Brushing and Brush Piling – When Using Chain Saw | <ul style="list-style-type: none"> –Refer to PPE for Chain Saw Operations (sec. 72, ex. 01) |
| 22.37c | | | Caving | <ul style="list-style-type: none"> –Climbing helmet with non-elastic chin strap –Electric or carbide head lamp –Three light sources (extra batteries/bulbs) –Gloves, appropriate boots –Food and drinking water –Pack with no external protrusions –Appropriate communication system –Appropriate clothing for specific cave environment |

72 – Exhibit 01 – continued

| FSH 6709.11 Reference | Work Project/Activity | PPE |
|--------------------------------------|------------------------------|--|
| 22.48c | Chain Saw Operations | <ul style="list-style-type: none"> -Forest Service-approved hardhat -Eye protection -Hearing protection (85 dB and above) -Gloves (cut-resistant for chain filing) -Long-sleeved shirt -Chain saw chaps (2-inch boot overlap) that meet the requirements of Forest Service Specification 6170-4 -Heavy-duty, cut-resistant or leather, waterproof or water-repellent, 8-inch high laced boots with nonskid soles (Condition of Hire Policy – FSM 6716.03) |
| 61.22 | Chemicals | <ul style="list-style-type: none"> -Fire shelter (wildfire and prescribed burn assignments) -JHA and MSDS to identify specific PPE, such as eye/face protection, respirators, rubber aprons, rubberized gloves, protective cream, stationary or portable eyewash |
| 27.63b | Clearing (Roadside and Land) | <ul style="list-style-type: none"> -Forest Service-approved hardhat -Gloves, eye protection -Hearing protection (85 dB and above) -High-visibility vest when/where identified by the JHA -Heavy-duty, cut-resistant or leather, waterproof or water-repellent, 8-inch high laced boots with nonskid soles (Condition of Hire Policy – FSM 6716.03) |

72 – Exhibit 01 – continued

| FSH | 6709.11 | Reference | Work Project/Activity | PPE |
|--------|---------|--|-----------------------|---|
| 22.48c | | Clearing (Roadside and Land) – When Using Chain Saw | Concrete and Masonry | –Refer to PPE for Chain Saw Operations (sec. 72, ex. 01) |
| 31.32 | | | | –Forest Service-approved hardhat –Gloves, eye protection –Appropriate footwear –Respirator for cement and lime dust (NIOSH approved) |
| 22.48h | | Crosscut Saw Operations | | –Forest Service-approved hardhat –Gloves, eye protection –Heavy-duty, cut-resistant or leather, waterproof or water-repellent, 8-inch high laced boots with nonskid soles (Condition of Hire Policy – FSM 6716.03) |
| 27.24c | | Demolition | | –Forest Service-approved hardhat –Gloves, eye protection –Safety-toed footwear or equally effective (such as metatarsal – ANSI Z441, 1991) |
| 44.73 | | Drill Rig Operations | | –Forest Service-approved hardhat –Eye protection, such as safety goggles or safety glasses (with wrap-around or side shields) –Dust mask or NIOSH approved respirator –Hearing protection (85 dB and above) –High-visibility vest –Leather nongaitlet gloves |

72 – Exhibit 01 – continued

| FSH 6709.11 Reference | Work Project/Activity | PPE |
|--------------------------------------|------------------------------|---|
| 36.11 | Electric Work | <ul style="list-style-type: none"> -Nonskid safety-toed boots -Rubber insulating gloves for specific tasks identified by the JHA -Forest Service-approved hardhat (impact and penetration resistant, providing electrical protection from high-voltage conductors) -Belted chest-high waders or hipboots with nonskid soles -Rubber insulating gloves -Personal flotation device (USCG approved) -Forest Service-approved hardhat -Safety-toed footwear or equally effective (such as metatarsal – ANSI Z441, 1991) -Gloves, eye protection -Hearing protection (85 dB and above) |
| 22.61b | Electrofishing | <ul style="list-style-type: none"> -Forest Service-approved hardhat -Hearing protection (85 dB and above) -Eye/face protection, such as safety goggles, safety glasses (with wrap-around or side shields), or face shield -Heavy-duty, cut-resistant, gauntlet type gloves -Long pants and long-sleeved shirts |
| 31.22 | Excavation | <ul style="list-style-type: none"> -Heavy-duty, cut-resistant or leather, waterproof or water-repellent, -8-inch high laced boots with nonskid soles (Condition of Hire Policy – FSM 6716.03) |
| 22.22a | Fencing Operations | |

72 – Exhibit 01 – continued

| FSH 6709.11 Reference | Work Project/Activity | PPE |
|--------------------------------------|--|--|
| 25.12 | Firefighting and | -Forest Service-approved fire shelter |
| 25.14 | Prescribed Fire | -Forest Service-approved hardhat -Eye protection -Hearing protection (85 dB and above) -Long-sleeved shirt and pants of Forest Service-approved flame-resistant fabric -Forest Service-approved leather nongaitlet gloves -Heavy-duty, cut-resistant or leather, waterproof or water-repellent, 8-inch high laced boots with nonskid soles (Condition of Hire Policy – FSM 6716.03) |
| 25.12 | Fire Retardant (Mixing) | -Other PPE identified by JHA, MSDS, or burn plan for prescribed fire -Recommended or required PPE as prescribed in the retardant chemical product MSDS |
| 27.15c | Gravel Pit and Rock Quarry Operations | -Forest Service-approved hardhat -Eye protection -Hearing protection (85 dB and above) -Eye/face protection |
| 43.71 | Grinding | -Hearing protection (85 dB and above) -Gloves, eye protection |
| 39.82 | Grounds Maintenance | -Appropriate footwear -Hearing protection (85 dB and above) -Dust mask (when applicable) |

72 – Exhibit 01 – continued

| FSH Reference | Work Project/Activity | PPE |
|----------------------|--|---|
| 44.11 | Heavy Equipment Operation | <ul style="list-style-type: none"> -Forest Service-approved hardhat -Eye protection -Hearing protection (85 dB and above) -Appropriate footwear -Appropriate respiratory protection identified by JHA and/or MSDS -Additional PPE identified by JHA and/or MSDS -High-visibility vest (night operation-reflectORIZED vest) -Signal lights for low-visibility and night operation -Radio communication with operator for low-visibility and night operation -Safety-toed boots |
| 25.33 | Heavy Equipment Operation – Operator's Helper/Signal Person Heavy Equipment Operation – Repair/Maintenance Personnel Law Enforcement | <ul style="list-style-type: none"> -Flashlight -Personal portable and mobile radio -Full field uniforms with uniform outerwear -Additional PPE identified in FSM 5300 -Gloves -Eye protection -Riding, field, or work boots (Condition of Hire Policy – FSM 6716.03); appropriate footwear shall be worn for specific work project or activity after arrival -Forest Service-approved hardhat -Eye protection |
| 37.21 | Lighting (Installation/ Maintenance) | |
| 16.3 | Livestock Handling | |
| 22.45b | Mill Studies | |

72 – Exhibit 01 – continued

| FSH 6709.11 Reference | Work Project/Activity | PPE |
|-----------------------------|--------------------------|--|
| 22.81c | Mine and Mineral Surveys | <ul style="list-style-type: none"> -Hearing protection (85 dB and above) -High-visibility vest -Nonskid boots -Forest Service-approved hardhat -Nonskid safety-toed boots -Safety glasses, goggles, or face shield -Multi-gas meter -Appropriate head lamp -Safety belt with ring for securing lifeline -Two-way radio (outside the underground workings) |
| 13.32 | Motorcycle Operation | <ul style="list-style-type: none"> -Personal communications device -Manufacturer's tool kit -Leather gloves -Long pants, long-sleeved shirt or jacket -Motorcycle helmet – full face or three-quarter face (mouth guard recommended when using three-quarter face helmet, goggles, or face shield) that meets Department of Transportation (DOT), American National Standards Institute (ANSI 90.1), or Snell Memorial Foundation (SMF) standards |
| 22.36c | Mountaineering | <ul style="list-style-type: none"> -Appropriate footwear -Appropriate footwear -Climbing helmet (UIAA approved) |

72 – Exhibit 01 – continued

| FSH 6709.11 Reference | Work Project/Activity | PPE |
|-----------------------------|-----------------------|---|
| 27.22c | Painting | <ul style="list-style-type: none"> -Climbing chest and seat harness -Hardware, appropriate for anchoring ascending/descending the rope, belaying protection -Head lamp -Signal flares/mirrors and fire starter -Personal communications device -Clothing for site-specific climatic conditions -PPE when identified by the product label, MSDS, or JHA -NIOSH-approved respirator (when painting with spray gun or using oil-based paint) |
| 22.11b | Pesticide Application | <ul style="list-style-type: none"> -Eye protection (when scraping paint or using liquid paint remover) -Spray paint booths (NFPA 70) -Forest Service-approved hardhat -Eye/face protection -Hearing protection (85 dB and above) -Gloves impervious to pesticides -Respirator as identified by the pesticide/product label, MSDS, or JHA -Rubberized protective equipment when identified by the pesticide/product label, MSDS, or JHA |
| 26.42 | Recycling | <ul style="list-style-type: none"> -Chemical-resistant clothing -Cut/puncture-resistant gloves (impervious to chemicals) -Puncture-resistant safety shoes |

72 – Exhibit 01 – continued

| FSH 6709.11 Reference | Work Project/Activity | PPE |
|-----------------------------|---|---|
| 27.62b | Road Maintenance | <ul style="list-style-type: none"> -Eye protection (with wrap around or side shields) -Hearing protection (85 dB and above) -Forest Service-approved hardhat -Eye protection -Hearing protection (85 dB and above) -High-visibility vests -Dust respirator -Appropriate footwear |
| 27.22e 22.44b | Sandblasting Scaling | <ul style="list-style-type: none"> -Air-supplied sandblasting hoods -Forest Service-approved hardhat -High-visibility vest -Eye protection |
| 39.72 | Shop Activities | <ul style="list-style-type: none"> -Hearing protection (85 dB and above) -Nonskid boots (Condition of Hire Policy – FSM 6716.03) -Calk boots when identified by the JHA -PPE for each shop work project or activity as specified in the JHA -Eye, face, head, and extremities protection -Hearing protection (85 dB and above) -All PPE as stated in section 39.72 |
| 39.74a | Shop Activities – Brake/Clutch Maintenance | <ul style="list-style-type: none"> -All PPE as stated in section 61.8 |

72 – Exhibit 01 – continued

| FSH 6709.11 Reference | Work Project/Activity | PPE |
|--------------------------------------|-------------------------------|---|
| 27.14b | Sign Installation/Maintenance | <ul style="list-style-type: none"> - Forest Service-approved hardhat - Gloves, eye protection - Hearing protection (85 dB and above) - Safety belts for operator and passengers - Skis/snowshoes (travel length dependent) - Emergency equipment/clothing identified in the JHA (PPE from sec. 13.32) |
| 13.52 | Snow Cat Operations | <ul style="list-style-type: none"> - Collapsible (sectional) probes and avalanche rescue transceivers when applicable - Personal communications device - Other PPE identified in the JHA, such as collapsible (sectional) probes, avalanche rescue transceivers, snowshoes/cross-country skis, safety sunglasses, and sunscreen |
| 22.52b | Snow Surveys | <ul style="list-style-type: none"> - Compass - Map of area to be traversed - Global positioning system (GPS) optional |
| 13.42 | Snowmobile Operations | <ul style="list-style-type: none"> - Manufacturer's operator manual - Manufacturer's tool kit - Helmet (DOT, ANSI, or Snell approved) - Clothing adequate for winter travel, including goggles, gloves, and boots - Personal communications device - Flashlight with extra batteries and bulb |

72 – Exhibit 01 – continued

| FSH 6709.11 Reference | Work Project/Activity | PPE |
|-----------------------------|-------------------------|--|
| 22.53c | Soil Surveys | <ul style="list-style-type: none"> –Shovel –Collapsible (sectional) probes and avalanche rescue transceivers –Emergency equipment/clothing identified in the JHA, such as snowshoes –Personal communications device |
| 39.62 | Storage and Warehousing | <ul style="list-style-type: none"> –All PPE as stated in section 39.62 |
| 27.13b | Surveying | <ul style="list-style-type: none"> –Eye protection and sunscreen –Appropriate footwear |
| 22.41b | Thinning and Girdling | <ul style="list-style-type: none"> –High-visibility vest (on public roadways and during hunting season) –Warning signs to alert motorists and hunters |
| 22.47c | Timber Marking | <ul style="list-style-type: none"> –Forest Service-approved hardhat –Eye protection –Hearing protection (85 dB and above) –Forest Service-approved hardhat –Gloves –Eye protection –Long-sleeved shirt –Appropriate respirator (identified by MSDS or JHA) –Vest (high-visibility during hunting season) –Nonskid boots with sufficient ankle support (Condition of Hire Policy – FSM 6716.03) |

72 – Exhibit 01 – continued

| FSH 6709.11 Reference | Work Project/Activity | PPE |
|--------------------------------------|---|---|
| 22.47c | Timber Marking – Solvent Handling | –Apron –Long-sleeved shirt –Eye and face protection –Chemical-resistant rubber gloves –Forest Service-approved hardhat –Nonskid boots |
| 22.46c | Timber Sale Administration | –Forest Service-approved utility service high-voltage hardhat –Appropriate ASTM-approved hardware (body harnesses, safety straps, lanyards, D rings, snap hooks, and buckles) –Appropriate footwear |
| 26.62b | Tower/Pole Climbing | –Hand protection (gloves and/or chalk) –Forest Service-approved hardhat –Gloves, eye protection –Nonskid boots |
| 22.34c | Trail Maintenance | –Hearing protection (85 dB and above) –Refer to PPE for Chain Saw Operations (sec. 72, ex. 01) |
| 22.48c | Trail Maintenance – When Using Chain Saw | |
| 22.49c | Tree Climbing | –Gloves, eye protection –Climbing helmet with chin strap –Long-sleeved shirt, sturdy pants or coveralls –Appropriate footwear identified in JHA –Harness, lanyard |

72 – Exhibit 01 – continued

| <i>FSH Reference</i> | <i>Work Project/Activity</i> | <i>PPE</i> |
|----------------------|--|---|
| 22.43c | Tree Planting – When Wrapping Chemically Treated Trees Tree Planting – When Using Auger | <ul style="list-style-type: none"> –Impervious gloves –Soap, water, and towels –Nonskid boots –Forest Service-approved hardhat –Nonskid boots –Gloves –Safety glasses or goggles –Hearing protection (85 dB and above) –Forest Service-approved hardhat –Gloves, eye protection –Nonskid boots |
| | Tree Planting – When Planting by Hand | <ul style="list-style-type: none"> –Forest Service-approved hardhat –Gloves, eye protection –Nonskid boots |
| | Tree Planting – When Planting by Machine | <ul style="list-style-type: none"> –Forest Service-approved hardhat –Gloves, eye protection –Hearing protection (85 dB and above) –Foot guards –Eye or face protection –Forest Service-approved hardhat –Gloves |
| 22.42b | Tree Pruning | <ul style="list-style-type: none"> –Personal communications device –Wading pole, 10-12 feet –Tractionized footwear –Hip boots or belted waders |
| 22.51b | Water Surveys | |

72 – Exhibit 01 – continued

| FSH 6709.11 Reference | Work Project/Activity | PPE |
|-----------------------------|--|--|
| 15.12 | Watercraft Operations | <ul style="list-style-type: none"> -Area maps and compass -Bailing device -Personal communications device -Personal flotation device (USCG approved) -Flashlight with extra batteries and bulb -Manufacturer's repair kit and spare parts -Marine charts -Signaling device -Carbon monoxide detector (enclosed cabins) -Anchor and anchor line -Emergency flare kit -Spare oar/paddle |
| 27.23c | Watercraft Operations – Powered Watercraft Watercraft Operations – Paddlecraft Welding | <ul style="list-style-type: none"> -Welder's face shield or goggles with proper shade for eye protection <p>Note: Welding helmets should be used only over primary eye protection (glasses or goggles)</p> <ul style="list-style-type: none"> -Hearing protection (85 dB and above) -Head protection such as leather skull cap and/or Forest Service-approved hardhat -Flameproof gauntlet gloves, flameproof vest, apron, cape, Forest Service-approved flame-resistant clothing -Steel-toed boots |

GLOSSARY

Aerosol Defensive Spray (ADS). A spray that deters threatening behavior from human beings or wild and domestic animals that have the potential to cause physical harm or personal injury.

Alternative Fuels. Any type of fuel, other than gasoline and diesel (methanol, ethanol, and propane are examples), that is used as engine fuel.

ANSI. American National Standards Institute.

Anti-lock Brake System (ABS). A computerized vehicle braking system designed to prevent wheel lock up.

ASME. American Society of Mechanical Engineers.

ASTM. American Standards and Testing Methods.

ATV. All-terrain vehicle.

Aviation Operations. Any activity involving the use of aircraft.

BBP. Bloodborne pathogens.

Bonding. Metal-to-metal contact, usually by wire, between two containers to prevent generation of static electrical sparks.

Cave. Any naturally occurring void beneath the surface of the Earth or within a cliff or ledge, including natural subsurface water and drainage systems, which is large enough to allow human entrance. Any natural pit, sinkhole, or other feature that is an extension or component of a cave. Man-made excavations, such as mines, are not considered caves and, as such, require different training and skills to enter.

Caver. A person trained and experienced in cave exploration.

CDC. Centers for Disease Control and Prevention.

CFR. Code of Federal Regulations.

Class ABC Fire Extinguisher. A multipurpose extinguisher that is capable of extinguishing fires resulting from ordinary combustibles,

flammable liquids, and electrical equipment (NFPA and Coast Guard approved).

Class B Fire Extinguisher. An extinguisher capable of extinguishing fires resulting from flammable liquids.

Climber. A metallic climbing device using a pointed gaff attached to a leg iron.

Climbing Team. Two or more certified tree climbers, each of whom is capable of performing the same assignment as the other(s).

Commercial Driver's License (CDL). A license required to drive a commercial motor vehicle with a gross vehicle weight of more than 26,001 pounds (11,794 kg), including towing units that exceed this weight when the towed unit weighs more than 10,000 pounds (4,536 kg). A CDL is also required to drive a vehicle designed to carry 15 or more passengers, or any size vehicle transporting hazardous materials that require vehicle placarding under the hazardous materials regulations (sec. 12.01).

Competent Person. A person capable of identifying existing and predictable hazards in the surroundings or in the working conditions that are unsanitary, hazardous, or dangerous to employees. Having so identified the situation, this person is authorized to take prompt corrective measures to eliminate them (CFR 29 1926.32).

Confined Space. Any space that has a limited or restricted means of egress, is large enough for an employee to enter and perform assigned work, and is not designed for continuous occupancy. Confined spaces can be further defined as permit-required or nonpermit-required.

Consumer Commodity. A material that is packaged and distributed in a form intended or suitable for sale through retail sales agencies for consumption by individuals for personal care or household use.

CPR. Cardiopulmonary resuscitation.

CTD. Cumulative trauma disorder.

Danger Tree. A standing tree that presents a hazard to people due to conditions such as, but not limited to, deterioration or physical

damage to the root system, trunk, stem, or limbs, and the direction and lean of the tree.

Dogs. Chain saw accessory designed for falling and bucking. Medium size saws generally have an inside dog, while larger saws have an inside and an outside set of dogs. Chain saw dogs increase the sawyer's efficiency in falling and bucking operations.

DOT. U.S. Department of Transportation.

EPA. Environmental Protection Agency.

Exploration Party. A group of three or more experienced cavers.

FAR. Federal Aviation Regulations.

FEMA. Federal Emergency Management Agency.

Firearms. Any weapon (including a starter gun) that is designed to or may readily be converted to expel a projectile by the action of an explosive; the frame or receiver of any such weapon; any firearm muffler or firearm silencer; or any destructive device.

Firefighting Missions. Aviation operations involving the use of aircraft to perform leadplane, smokejumper/paracargo, reconnaissance, photography, or survey activities during forest fires.

First Aid Kit. As referenced in this Handbook, a kit including bloodborne pathogen protective equipment (as a minimum, rubber gloves, face masks, eye protection, and CPR clear-mouth barriers) in addition to standard first aid supplies.

Flight Following Plan. A radio communications plan established by each Region requiring call-in by the pilot at a designated interval.

Float-Following Check-in. A check-in procedure required to ensure that boaters reach their destination and/or provide assistance if problems are encountered enroute. Check-in procedures must be established before departure and should include the check-in frequency. If boaters fail to check-in as required/established, search and rescue procedures are activated 30 minutes after the last required check-in.

Forest Service-Approved. An item that meets Forest Service specifications and /or drawings, or is procured under Forest Service authority.

FS. USDA Forest Service.

FSH. Forest Service Handbook.

FSM. Forest Service Manual.

Gaff. The sharp, pointed part of the climbing iron that enters the wood.

GAWR. Gross axle weight rating.

GCWR. Gross combined weight rating.

GFCI or GFI. Ground fault circuit interrupter.

Global Positioning System (GPS). A satellite-based radio navigation and positioning system developed by the Department of Defense (DOD). In its basic form, the satellite constellation consists of 24 satellites, 4 in each of 6 orbital planes. They are located 12,500 miles (20,116 km) above the Earth, and circle the Earth once every 12 hours. Trained employees with GPS receivers can determine their positions anywhere in the world, 24 hours a day, in all weather conditions.

Grounding. Contact between a container and the ground point, usually by wire, to prevent generation of static electrical sparks.

GTW. Gross total weight.

GVW. Gross vehicle weight.

Hands-on Training. Supervised training that includes classroom instruction and practical field exercise or demonstration of proficiency.

Handyman Jack. A lifting or pulling device that lifts on the down stroke of the handle, depending on the size of the jack. It has a minimum of 30 inches continuous lift and approximately 7000 pounds of capacity. Handyman jacks are commonly used for changing flat tires, pulling metal fence posts, and many other uses.

HBV. Hepatitis-B virus.

HIV. Human immunodeficiency virus.

Incipient Stage Fire. A fire that is in the initial or beginning stage and that can be controlled or extinguished by portable fire extinguishers, Class II standpipe, or small hose system without protective clothing or breathing apparatus.

Itinerary. Planned route(s) of travel, date(s) of travel, destination, and estimated time of departure/arrival.

Jackstrawed. Area where multiple trees have been blown or fallen down in crisscross fashion.

JHA. Job hazard analysis.

Kerf. The slot that saw chain cutters make in the wood.

LCES. Lookout(s), Communication(s), Escape Route(s), and Safety Zone(s). Elements of a safety system routinely used by firefighters to assess their current situation with respect to wildland firefighting hazards. LCES has a much broader application than just fire and should be considered as a valuable, useful tool for all field project work and activities. Examples include chain saw operations, work in confined spaces, hazardous materials, and blasting.

Lock-out/Tag-out. The placement of a lockout device on an energy-isolating device to indicate that the device and the equipment being controlled may not be operated until the lockout device is removed. When an electrical energy source is not capable of being locked out, a prominent warning tag is fastened securely to it, in accordance with established procedures (29 CFR 1910.147).

Log Slip. A method of conveying logs during the manufacturing process.

LP Gas. Liquid or liquefied petroleum gas.

MSDS. Material safety data sheet. A compilation of information required under the Occupational Safety and Health Administration Hazard Communication Standard that outlines the identity of hazardous chemicals, health, physical, and fire hazards, exposure limits, and storage and handling precautions.

NEC. National Electrical Code.

NFPA. National Fire Protection Association.

NIOSH. National Institute on Occupational Safety and Health.

Offsetting Method. A method of measuring distances in which actual points on the main line are moved a short distance perpendicularly, and then measurements are recorded for reestablishment purposes.

OSHA. Occupational Safety and Health Administration.

Personal Communication Device. A system for sending and receiving messages, such as a cellular phone or two-way radio.

PFD. Personal flotation device.

Pit/Quarry Plan. A design for excavation of material that includes safety features, such as benches, berms, and reduced slope ratios.

POU. Point of use.

PPE. Personal protective equipment and clothing for eyes, head, and extremities, respiratory devices, and protective shields and barriers.

Pyrotechnic Device. A flare fired from a flare pistol, capable of setting several simultaneous fires.

Safety Container. As defined by NFPA 30, an approved container of not more than a 5-gallon (18.9 L) capacity, having a spring-closing lid and spout cover and designed so that it safely relieves internal pressure when subjected to fire exposure.

SHMD. Safety and Health Management Division.

SMF. Snell Memorial Foundation.

Snag. Any standing dead tree or portion thereof.

Sound. Descriptor used in tree falling, especially snags, in reference to the presence of rot in the standing tree.

TWA. Time-weighted average.

UIAA. Union Internationale des Associations D'Alpinisme.

UL. Underwriters Laboratory.

Universal Precautions. Equipment and procedures that protect a person from the blood and body fluids of a patient.

USCG. U.S. Coast Guard.

USDA. U.S. Department of Agriculture.

VDT. Video display terminal.

VFR. Visual flight rules.

Wild or Undeveloped Cave. Any cave not developed with trails, pathways, or artificial lighting, in which the cavers are completely dependent upon their own equipment.

INDEX

| | Page |
|---|-------|
| A | |
| Accident | 0-7 |
| fatalities, serious injuries, or hospitalization of | |
| three or more persons | 0-7 |
| investigation and reporting | 0-7 |
| Administration of developed sites | 20-25 |
| Administration of undeveloped areas | 20-27 |
| Aerosol defensive sprays | 50-10 |
| Africanized honey bees | 50-26 |
| Air conditioning | 30-33 |
| Air receivers | 40-28 |
| Airhammers | 40-29 |
| All-terrain vehicles | 10-24 |
| loading and hauling | 10-25 |
| All-wheel-drive vehicles | 10-23 |
| Altitude-related problems | 50-45 |
| Animal hazards | 50-29 |
| Archeological work sites | 20-28 |
| Asbestos | 60-52 |
| Aviation | 10-33 |
| | |
| B | |
| Back injury | 50-16 |
| Bandsaws | 40-35 |
| Bars, digging | 40-13 |
| Bars, prying | 40-13 |
| Bars, tamping | 40-13 |
| Bear spray | 50-10 |
| authorization | 50-10 |
| reporting procedures | 50-12 |
| restrictions | 50-12 |
| training | 50-10 |
| transportation and storage | 50-11 |
| Bears | 50-29 |
| Bees, Africanized honey | 50-28 |

| | |
|---|--------|
| Bicycling | 10-46 |
| defensive driving | 10-47 |
| personal protective equipment | 10-47 |
| qualifications | 10-47 |
| Black bears | 50-29 |
| Bloodborne pathogens (BBP) | 50-15 |
| employee coverage | 50-15 |
| exposure control plan | 50-15 |
| hepatitis b vaccination (hbv) | 50-15 |
| post-exposure incident evaluation | 50-16 |
| training | 50-15 |
| Boat fires | 20-96 |
| Body harnesses, lifelines, and lanyards | 30-17 |
| body harness | 30-17 |
| general | 30-17 |
| lanyard | 30-17 |
| lifeline | 30-17 |
| personal fall arrest system | 30-17 |
| safety nets | 30-18 |
| safety ropes | 30-18 |
| use | 30-18 |
| Bow saws | 40-10 |
| Bridge inspections | 20-126 |
| Brushing and brush piling | 20-95 |
| Buildings and related activities | 20-110 |

C

| | |
|--|--------|
| Cardiopulmonary resuscitation (CPR) | 20-15 |
| Carpentry | 20-110 |
| Caving (spelunking) | 20-31 |
| Cavity nesting bird work projects and activities | 20-72 |
| Chain saw | 20-47 |
| carrying saw | 20-53 |
| fueling saw | 20-54 |
| no felling at night | 20-51 |
| personal protective equipment | 20-49 |
| primary and secondary escape routes, safety zones, and alternates | 20-52 |
| procedures | 20-50 |
| qualifications | 20-47 |
| safety practices | 20-51 |

| | |
|---|--------|
| saw handling techniques | 20-53 |
| situational awareness and size up | 20-51 |
| standards | 20-47 |
| starting/operating saw | 20-54 |
| Chains | 40-24 |
| Chemicals, incompatible | 60-25 |
| Chiggers | 50-20 |
| Chimneys and vent stacks | 30-22 |
| Chippers | 40-60 |
| brush | 40-61 |
| tree | 40-61 |
| tree chipper loader | 40-62 |
| Chisels | 40-11 |
| Chopping tools | 40-7 |
| Clearing (Roadside and Land) | 20-128 |
| backpack power units | 20-129 |
| Cold conditions | 50-38 |
| Colorado Tick Fever | 50-20 |
| Concrete and masonry | 30-8 |
| Concrete mixer | 30-9 |
| associated hazards | 30-9 |
| Confined spaces | 30-38 |
| confined space | 30-39 |
| nonpermit required confined space | 30-39 |
| permit-required confined space | 30-39 |
| Control of hazardous energy (Lockout/Tag-out) | 30-42 |
| Cooking operations | 50-54 |
| cooking area | 50-54 |
| cooking utensils | 50-54 |
| food rations | 50-55 |
| food storage and serving | 50-54 |
| meal preparation | 50-54 |
| Crawler-tractors | 40-46 |
| hitching and towing | 40-48 |
| skidding | 40-49 |
| Crosscut saws | 20-58 |
| ground transport | 20-59 |
| personal protective equipment | 20-58 |
| safety practices | 20-59 |
| storage | 20-59 |

| | |
|---|-------|
| use of crosscut saws | 20-61 |
| Cumulative trauma disorders (CTD) | 50-16 |
| Cutting tools | 40-9 |

D

| | |
|---|--------|
| Dam inspections | 20-124 |
| animals/insects | 20-126 |
| beaver dams | 20-126 |
| burrow holes | 20-126 |
| confined spaces | 20-126 |
| electrical/mechanical hazards | 20-126 |
| informal inspections | 20-124 |
| operation and maintenance inspections | 20-125 |
| safety inspection and hazard assessment | 20-125 |
| sink holes | 20-126 |
| special inspections | 20-125 |
| walking surfaces | 20-125 |
| water depth | 20-126 |
| Demolition | 20-119 |
| Diving | 20-70 |
| procedures | 20-71 |
| qualifications | 20-70 |
| scientific diving in fisheries | 20-72 |
| standards | 20-70 |
| Drill rig operations | 40-68 |
| personal protective equipment | 40-69 |
| qualifications | 40-69 |
| safety practices | 40-69 |
| standards | 40-68 |
| Drills | 40-36 |
| Dump trucks | 40-67 |
| air brakes | 40-67 |
| drivers | 40-68 |

E

| | |
|---|-------|
| Egress, means of egress and fire prevention | 30-19 |
| Electrical | 30-25 |
| accessible work area | 30-29 |
| bare powerline conductors | 30-31 |
| circuit breakers | 30-29 |

| | |
|---|--------|
| current test | 30-28 |
| defective components | 30-27 |
| electrical shock | 30-26 |
| exposed circuitry | 30-27 |
| extension cords | 30-27 |
| ground-fault circuit interrupter (gfcı or gfi). | 30-27 |
| lockout/tag-out | 30-31 |
| low and high voltage rescue | 30-31 |
| low hanging powerlines | 30-31 |
| motorized equipment | 30-28 |
| power supply | 30-29 |
| repairs | 30-28 |
| wet hands | 30-27 |
| work near powerlines | 30-29 |
| Electrofishing | 20-68 |
| Emergency evacuation planning | 30-19 |
| Employee safety and security | 50-5 |
| procedures | 50-5 |
| responsibilities | 50-5 |
| safety practices | 50-6 |
| End loaders/backhoes | 40-51 |
| Engineering operations | 20-104 |
| Environmental controls | 30-36 |
| piping systems | 30-37 |
| safety signs | 30-38 |
| vehicle marking | 30-37 |
| Environmental hazards | 50-33 |
| altitude-related problems | 50-45 |
| cold conditions | 50-38 |
| extreme weather conditions | 50-35 |
| flash floods | 50-44 |
| frostbite | 50-39 |
| hot conditions | 50-35 |
| hypothermia | 50-40 |
| lightning | 50-42 |
| radiation | 50-33 |
| solar ultraviolet radiation | 50-34 |
| thunderstorms | 50-42 |
| tornadoes | 50-44 |
| Environmental project activities | 20-18 |

| | |
|--|-------|
| Equipment development | 40-71 |
| Ergonomics | 50-16 |
| Excavation | 30-6 |
| Explosives and blasting agents | 60-54 |
| personnel qualifications | 60-55 |
| Eye strain | 50-16 |
| F | |
| Facilities construction work | 30-5 |
| procedures | 30-5 |
| qualifications | 30-5 |
| safety practices | 30-6 |
| Facilities | 30-43 |
| aisles, passageways, and storerooms | 30-46 |
| bomb threats and other security issues | 30-44 |
| emergency evacuation plan | 30-44 |
| first aid supplies | 30-44 |
| floor elevation | 30-46 |
| movable equipment and materials | 30-46 |
| openings | 30-46 |
| safety and health sessions | 30-44 |
| smoking | 30-44 |
| stairways | 30-46 |
| walking and working surfaces | 30-45 |
| Fall protection | 30-12 |
| Felling, bucking, and limbing techniques | 20-55 |
| observers and spotters | 20-55 |
| Fencing | 20-22 |
| Files | 40-11 |
| Fire prevention | 30-20 |
| appliances | 30-21 |
| design review | 30-22 |
| electrical systems | 30-21 |
| Fire/Smoke Detection Equipment | 30-20 |
| flammables/combustibles | 30-22 |
| furnishings | 30-22 |
| heating systems | 30-22 |
| storage | 30-22 |
| Fire protection | 30-23 |
| fire extinguishers | 30-24 |
| structural fire suppression | 30-23 |

| | |
|--|-------|
| Firearms | 20-98 |
| Firearms, for non-law enforcement personnel | 50-7 |
| authorization for firearms | 50-7 |
| employees with occasional need to carry firearms | 50-8 |
| expiration of firearms authorization | 50-8 |
| firearms and ammunition storage | 50-9 |
| firearms in camp | 50-9 |
| privately owned firearms | 50-9 |
| training | 50-8 |
| use of firearms | 50-9 |
| Firefighting | 20-80 |
| boots | 20-82 |
| clothing | 20-82 |
| eye protection | 20-82 |
| fire shelter | 20-80 |
| first aid kit | 20-82 |
| gloves | 20-82 |
| hardhat | 20-82 |
| hearing protection | 20-82 |
| personal protective equipment | 20-80 |
| ppe for mixing fire retardant chemicals | 20-83 |
| qualifications | 20-80 |
| specialized ppe | 20-82 |
| First aid | 20-15 |
| equipment | 20-15 |
| Flammable/combustible liquids | 60-34 |
| density | 60-39 |
| dispensing | 60-42 |
| flammable gases | 60-44 |
| liquefied petroleum gas | 60-48 |
| storage | 60-39 |
| toxicity | 60-39 |
| vapor density | 60-39 |
| Flash floods | 50-44 |
| Forklifts | 40-64 |
| Four-wheel-drive vehicles | 10-23 |
| Frostbite | 50-39 |
| Fuel oil and solid fuels | 30-33 |

G

| | |
|---|--------|
| Gravel pit and rock quarry operations | 20-108 |
| Greenhouse safety | 60-24 |
| electrical | 60-25 |
| equipment | 60-25 |
| operations | 60-24 |
| pesticides | 60-25 |
| procedures | 60-24 |
| safety practices | 60-24 |
| Grinders | 40-37 |
| Grizzly bear | 50-29 |
| Grounds maintenance | 30-66 |
| Grubbing tools | 40-13 |

H

| | |
|---|-------|
| Hacksaws | 40-10 |
| Hammers | 40-14 |
| Handsaws | 40-10 |
| Handtools | 40-5 |
| personal protective equipment | 40-6 |
| procedures | 40-6 |
| qualifications | 40-5 |
| responsibility | 40-5 |
| safety practices | 40-6 |
| Handtrucks | 40-18 |
| Hantavirus | 50-31 |
| general employee safety practices | 50-31 |
| specific employee safety practices | 50-32 |
| training | 50-31 |
| unit planning and safety procedures | 50-31 |
| Hazardous materials | 60-3 |
| chemical | 60-4 |
| combustible liquids | 60-4 |
| compressed gas | 60-4 |
| corrosive material | 60-4 |
| cryogenic material | 60-4 |
| definitions | 60-4 |
| disposal | 60-14 |
| etiologic agent | 60-4 |
| explosive material | 60-4 |

| | |
|---|-------|
| explosive | 60-4 |
| exposure routes | 60-4 |
| flammable compressed gas | 60-5 |
| flammable liquids | 60-5 |
| flammable solid | 60-5 |
| flash point | 60-5 |
| general requirements | 60-6 |
| hazardous chemical | 60-5 |
| hazardous waste | 60-5 |
| incompatible materials | 60-5 |
| irritating materials | 60-5 |
| marking and labeling | 60-8 |
| oxidizing material | 60-5 |
| personal protective equipment | 60-7 |
| poison | 60-5 |
| procedures | 60-7 |
| pyrophoric liquid | 60-5 |
| qualifications | 60-6 |
| radioactive material | 60-5 |
| safety practices | 60-7 |
| storage | 60-8 |
| toxic material | 60-6 |
| transportation | 60-14 |
| use | 60-8 |
| Health and wellness | 50-13 |
| fitness | 50-14 |
| health practices | 50-13 |
| Heat conditions | 50-35 |
| Heaters and furnaces | 30-33 |
| Heating, Ventilating, and Air Conditioning Equipment (HVAC) | 30-32 |
| Heavy equipment | 40-39 |
| guards and safety devices | 40-45 |
| operator's helper/signal person | 40-41 |
| personal protective equipment | 40-41 |
| qualifications | 40-40 |
| repair and maintenance personnel | 40-41 |
| responsibility | 40-39 |
| safety practices | 40-41 |
| signaling | 40-45 |
| transportation | 40-44 |

| | |
|-----------------------------|-------|
| Helicopter rappelling | 20-97 |
| Hepatitis B (HBV) | 50-15 |
| Hoists | 40-19 |
| Hunting season | 20-16 |
| Hypothermia | 50-40 |

I

| | |
|-------------------------------|-------|
| Incompatible chemicals | 60-25 |
| corrosive materials | 60-32 |
| remaining chemicals | 60-34 |
| solvents | 60-32 |
| strong oxidizing agents | 60-33 |
| Insect hazards | 50-19 |
| Insect stings and bites | 50-26 |
| Ivy, poison | 50-17 |

J

| | |
|---------------------------|-------|
| Jacks | 40-16 |
| Job hazard analysis | 70-3 |
| Jointers | 40-35 |

K

| | |
|--------------|-------|
| Knives | 40-10 |
|--------------|-------|

L

| | |
|--|-------|
| Laboratory safety | 60-15 |
| animal hazards | 60-24 |
| chemical hygiene plan | 60-18 |
| chemical spills | 60-21 |
| electrical hazards | 60-22 |
| emergency evacuation procedures and communications plan | 60-20 |
| emergency guidelines | 60-21 |
| emergency planning | 60-19 |
| food safety | 60-22 |
| glassware | 60-22 |
| infectious hazards | 60-23 |
| mechanical hazards | 60-22 |
| nonionizing radiation | 60-22 |

| | |
|--|-------|
| personal protective equipment | 60-15 |
| pressure and vacuum systems | 60-22 |
| procedures | 60-18 |
| qualifications | 60-15 |
| removal of stored toxic liquid chemicals | 60-21 |
| safety practices | 60-21 |
| thermal hazards | 60-22 |
| Ladders | 30-12 |
| climbing | 30-15 |
| extension | 30-14 |
| step | 30-14 |
| storage | 30-16 |
| use | 30-13 |
| Law enforcement | 20-97 |
| aerosol defensive sprays | 20-98 |
| bloodborne pathogens | 20-98 |
| Lead | 60-53 |
| Lighting | 30-34 |
| exterior | 30-34 |
| interior | 30-34 |
| Lightning | 50-42 |
| Livestock handling | 10-40 |
| draft stock | 10-46 |
| feeding | 10-46 |
| leading | 10-46 |
| loading | 10-41 |
| loading | 10-42 |
| other livestock handling concerns | 10-46 |
| packing | 10-45 |
| private livestock | 10-46 |
| riding practices | 10-44 |
| riding | 10-43 |
| safe driving practices | 10-43 |
| securing | 10-41 |
| securing | 10-45 |
| shoeing | 10-46 |
| trailers | 10-41 |
| transporting | 10-40 |
| trucks | 10-42 |
| unloading | 10-42 |

| | |
|---|-------|
| Living quarters | 30-47 |
| Lockout/Tag-out | 30-42 |
| Log scaling | 20-39 |
| general | 20-39 |
| millyard scaling | 20-41 |
| scaling in woods and landings | 20-40 |
| scaling on trucks | 20-41 |
| Lookouts | 30-49 |
| inspections and maintenance of lightning protection system | 30-52 |
| lightning protection | 30-52 |
| personal safety and health | 30-50 |
| structure safety | 30-50 |
| Lyme Disease | 50-20 |
| M | |
| Metal working | 30-66 |
| Mill studies | 20-42 |
| Mine and mineral surveys | 20-73 |
| abandoned and inactive mines | 20-73 |
| active operations | 20-74 |
| all operations | 20-74 |
| personal protective equipment | 20-74 |
| procedures | 20-75 |
| qualifications | 20-73 |
| standards | 20-73 |
| Minerals and geology | 20-73 |
| Mobile homes and house/office trailers | 30-53 |
| electrical | 30-54 |
| liquid petroleum (lp) gas | 30-55 |
| sewer | 30-54 |
| utility connections | 30-54 |
| water | 30-54 |
| Mosquitoes | 50-28 |
| Motor graders | 40-53 |
| Motor vehicle | 10-8 |
| automatic braking systems | 10-12 |
| battery jump-starting | 10-20 |
| defensive driving | 10-17 |
| drivers/operators | 10-9 |

| | |
|---|-------|
| emergency driving | 10-12 |
| engine compartment fire safety | 10-22 |
| fire in cargo/hazardous materials | 10-23 |
| limited access highways | 10-17 |
| qualifications | 10-10 |
| required vehicle equipment | 10-11 |
| special hazards while driving on forest service roads | 10-17 |
| suspensions | 10-10 |
| training | 10-10 |
| transporting flammable/combustible liquids | 10-19 |
| vehicle fires | 10-22 |
| work/rest guidelines | 10-11 |
| Motorcycles | 10-26 |
| Mountain lions | 50-30 |
| Mountaineering | 20-29 |
| Mulch spreaders | 40-62 |

N

| | |
|----------------------------------|-------|
| Natural rope and synthetic fiber | 40-22 |
| Neck strain | 50-16 |
| Noxious weeds | 50-17 |

O

| | |
|--|--------|
| Oak, poison | 50-17 |
| Occupational health and environmental controls | 30-31 |
| Office safety and health | 20-100 |
| Offices | 30-56 |
| bookcases and file cabinets | 30-57 |
| chairs and desks | 30-57 |
| furniture and equipment | 30-57 |
| ladders | 30-57 |
| office machines | 30-58 |
| video display terminals (vdt) | 30-57 |
| Oil and gas operations | 20-77 |
| Other tools and equipment | 40-12 |

P

| | |
|--|--------|
| Painting | 20-110 |
| housekeeping | 20-111 |
| paint storage | 20-111 |
| sandblasting | 20-113 |
| spray painting | 20-112 |
| ventilation | 20-112 |
| Passengers, transporting | 10-32 |
| Peaveys, cant hooks, and pike poles | 40-20 |
| Permanent crew quarters | 30-48 |
| Personal protective equipment | 20-11 |
| Personal protective equipment | 70-12 |
| Pesticides | 60-50 |
| Pesticide Application | 20-18 |
| aircraft calibration | 20-21 |
| chemical-resistant garments | 20-19 |
| eye/face protection | 20-19 |
| fencing | 20-22 |
| first aid kits | 20-19 |
| general applications | 20-20 |
| hand protection | 20-19 |
| head/hearing protection | 20-19 |
| msds, or jha | 20-19 |
| personal protective equipment | 20-19 |
| procedures | 20-20 |
| respirator | 20-19 |
| rubberized protective equipment | 20-19 |
| safety practices | 20-20 |
| safety practices | 20-21 |
| Plant hazards | 50-17 |
| Pliers | 40-15 |
| Pneumatic power tools | 40-28 |
| Poison ivy | 50-17 |
| Poison oak | 50-17 |
| Poison sumac | 50-17 |
| Poisonous snakes, spiders, and scorpions | 50-21 |
| Portable saws, jointers, and sanders | 40-33 |
| Powder/explosive-actuated tools | 40-30 |
| Powered industrial trucks (forklifts) | 40-64 |

| | |
|--|--------|
| Power-operated tools | 40-25 |
| handling | 40-27 |
| maintenance | 40-28 |
| personal protective equipment | 40-26 |
| qualifications | 40-26 |
| responsibility | 40-26 |
| safety practices | 40-27 |
| Prescribed fire | 20-88 |
| all-terrain vehicle use in prescribed fire | 20-90 |
| backfiring equipment | 20-92 |
| burning out and backfiring operations | 20-91 |
| personal protective equipment | 20-88 |
| procedures | 20-88 |
| qualifications | 20-88 |
| safety practices | 20-89 |
| tractor plow use in prescribed fire | 20-90 |
| Pressure vessels | 30-35 |
| Project planning | 20-9 |
| general | 20-11 |
| job hazard analysis | 20-9 |
| occupational eye and face protection | 20-12 |
| occupational foot protection | 20-14 |
| occupational hand protection | 20-14 |
| occupational head protection | 20-13 |
| occupational noise exposure | 20-12 |
| personal protective equipment | 20-11 |
| qualifications | 20-10 |
| respiratory protection | 20-13 |
| specific requirements | 20-11 |
| training | 20-10 |
| Public health and pollution control | 20-121 |
| Punches | 40-11 |

R

| | |
|---------------------------|--------|
| Rabies | 50-32 |
| Radial arm saws | 40-34 |
| Radiation | 50-33 |
| Range | 20-22 |
| Recreation | 20-24 |
| Recycling | 20-100 |

| | |
|---|--------|
| Relapsing Fever | 50-20 |
| Residences | 30-48 |
| Responsibility | 0-4 |
| all employees | 0-5 |
| first-line supervisor | 0-4 |
| job hazard analysis | 0-6 |
| line officers | 0-4 |
| personal protective equipment | 0-6 |
| tailgate safety and health session | 0-6 |
| work leaders | 0-6 |
| Rigging equipment for material handling | 40-21 |
| Road maintenance | 20-127 |
| Rocky Mountain Spotted Fever | 50-20 |
| Rope | 40-22 |

S

| | |
|--|--------|
| Safety color(s) for marking physical hazards | 30-36 |
| Safety nets | 30-18 |
| Safety ropes | 30-18 |
| Safety signs | 30-38 |
| red | 30-38 |
| yellow | 30-38 |
| Sanders | 40-35 |
| Scaffolding | 30-16 |
| Scorpions | 50-25 |
| Scrapers | 40-50 |
| Screwdrivers | 40-15 |
| Search and rescue | 20-98 |
| Shops | 30-62 |
| automotive and equipment repair | 30-64 |
| personal protective equipment | 30-63 |
| procedures | 30-63 |
| qualifications | 30-62 |
| safety practices | 30-63 |
| Shovels and Cranes | 40-56 |
| Shovels | 40-20 |
| Sign installation/maintenance | 20-107 |
| Slings | 40-24 |
| Smokejumping | 20-96 |

| | |
|---|--------|
| Snakes | 50-21 |
| precautions for working in snake country | 50-21 |
| snake bites | 50-23 |
| Snow cats | 10-28 |
| Snow surveys | 20-67 |
| Snowmobiles | 10-27 |
| Soil surveys | 20-68 |
| Specialized equipment | 10-23 |
| Spelunking (caving) | 20-31 |
| Spiders | 50-23 |
| aggressive house spider | 50-23 |
| brown recluse spider | 50-23 |
| female black widow spider | 50-23 |
| spider bites | 50-24 |
| Storage and warehousing | 30-58 |
| bricks | 30-62 |
| general practices for handling materials | 30-61 |
| general storage practices | 30-60 |
| glass | 30-62 |
| housekeeping | 30-59 |
| lifting techniques | 30-59 |
| lumber | 30-62 |
| masonry blocks | 30-62 |
| personal protective equipment | 30-58 |
| procedures | 30-58 |
| qualifications | 30-58 |
| safety practices | 30-58 |
| short tiles | 30-62 |
| specific practices for handling materials | 30-62 |
| specific storage practices | 30-61 |
| steel products | 30-62 |
| Sumac, poison | 50-17 |
| Surveying | 20-106 |
| T | |
| Table saws | 40-33 |
| Telecommunications | 20-101 |

| | |
|---|--------|
| Temporary camps | 50-45 |
| after-work organized swimming activities | 50-56 |
| camp requirements | 50-47 |
| cooking operations | 50-54 |
| food and food service | 50-49 |
| other concerns | 50-53 |
| other requirements | 50-47 |
| preparations | 50-53 |
| sanitation | 50-48 |
| spike camps/remote-sites | 50-51 |
| water purification of undeveloped sources | 50-55 |
| water supply | 50-47 |
| Thinning and girdling | 20-35 |
| Thunderstorms | 50-42 |
| Ticks | 50-19 |
| Tick Paralysis | 50-20 |
| Timber management | 20-35 |
| Timber sale administration | 20-43 |
| general | 20-44 |
| helicopter logging operations | 20-45 |
| landing safety | 20-44 |
| Tools, chopping | 40-7 |
| Tools, cutting | 40-9 |
| Tools, other | 40-12 |
| Tornadoes | 50-44 |
| Tower/pole climbing | 20-101 |
| personal protective equipment | 20-102 |
| procedures | 20-102 |
| qualifications | 20-101 |
| safety practices | 20-103 |
| Trail maintenance and construction | 20-27 |
| Trailer entrances and exits | 30-56 |
| Trailer heating systems | 30-55 |
| oil-fired furnaces | 30-56 |
| ventilation | 30-56 |
| Trailers | 10-30 |
| equipment | 10-31 |
| operation | 10-30 |
| pre-trip safety inspection | 10-30 |
| qualifications | 10-30 |

| | |
|-------------------------------------|--------|
| Trams | 20-120 |
| Transportation | 20-126 |
| Transporting Passengers | 10-32 |
| Travel | 10-5 |
| air | 10-33 |
| all-terrain vehicle | 10-24 |
| back-country | 10-6 |
| bicycling | 10-46 |
| four-wheel-drive | 10-23 |
| general vehicle | 10-8 |
| job hazard analyses | 10-5 |
| livestock | 10-40 |
| motorcycles | 10-26 |
| motor vehicle | 10-8 |
| qualifications | 10-5 |
| requirements for all travel | 10-5 |
| snow cats | 10-28 |
| snowmobiles | 10-27 |
| specialized equipment | 10-23 |
| walking and hiking | 10-49 |
| watercraft | 10-34 |
| winter | 10-7 |
| Tree climbing | 20-62 |
| during climb | 20-64 |
| personal protective equipment | 20-63 |
| preparing for climb | 20-64 |
| procedures | 20-64 |
| qualifications | 20-62 |
| standards | 20-62 |
| Tree marking | 20-45 |
| personal protective equipment | 20-45 |
| procedures | 20-46 |
| qualifications | 20-45 |
| safety practices | 20-46 |
| solvent-handling activities | 20-47 |
| solvent-handling ppe | 20-47 |
| timber marking operation | 20-46 |
| timber marking ppe | 20-45 |

| | |
|-----------------------------------|-------|
| Tree planting | 20-37 |
| auger | 20-37 |
| hand planting | 20-37 |
| handling chemically treated trees | 20-37 |
| machine planting | 20-39 |
| Tree pruning | 20-36 |
| Trucks | 40-64 |
| Tularemia | 50-20 |

U

| | |
|----------------------------|-------|
| Ultraviolet (UV) radiation | 50-34 |
|----------------------------|-------|

V

| | |
|---------------|-------|
| Vehicle fires | 20-96 |
| Vises | 40-16 |

W

| | |
|---|--------|
| Walking and hiking | 10-49 |
| foot care | 10-50 |
| footwear | 10-50 |
| general requirement | 10-51 |
| specific requirement | 10-51 |
| wildland walking | 10-51 |
| Walking and working surfaces | 30-10 |
| guarding openings | 30-11 |
| Wastewater treatment | 20-121 |
| bloodborne pathogens | 20-123 |
| chlorine gas | 20-123 |
| confined space | 20-122 |
| deep shafts | 20-122 |
| electrical hazards | 20-123 |
| entry ladder | 20-122 |
| first aid | 20-123 |
| manhole covers | 20-122 |
| open flame | 20-123 |
| personal hygiene | 20-123 |
| traffic control | 20-123 |
| Water purification of undeveloped sources | 50-55 |

| | |
|--|--------|
| Water storage and transmission | 20-124 |
| Water surveys | 20-65 |
| Watercraft | 10-34 |
| fire suppression | 10-37 |
| operation | 10-34 |
| paddlecraft | 10-39 |
| personal protective equipment | 10-35 |
| qualifications | 10-34 |
| watercraft 26 feet (8 m) and over | 10-38 |
| watercraft less than 26 feet (8 m) | 10-38 |
| Watershed and air management | 20-65 |
| Weather, extreme conditions | 50-35 |
| Wedges | 40-21 |
| Welding and cutting | 20-113 |
| arc welding | 20-117 |
| cylinder handling | 20-119 |
| cylinder storage | 20-119 |
| equipment | 20-113 |
| general welding | 20-116 |
| oxygen-fuel cutting and welding | 20-117 |
| storage | 20-117 |
| toxicity | 20-114 |
| ventilation | 20-114 |
| Wheelbarrows | 40-20 |
| Wildland firefighting | 20-83 |
| after work activities involving swimming | 20-87 |
| escape routes | 20-84 |
| fatigue factors | 20-87 |
| fire situation assessment | 20-85 |
| firefighter welfare guidelines | 20-85 |
| LCES | 20-84 |
| safety practices | 20-83 |
| safety zone | 20-84 |
| survival zone | 20-85 |
| the 10 standard fire orders | 20-83 |
| watchout situations | 20-83 |
| Wildland walking | 10-51 |
| Wildlife, fish, and sensitive plant management | 20-68 |

| | |
|---------------------------------|-------|
| Winter | 10-7 |
| travel in avalanche areas | 10-7 |
| travel on ice | 10-8 |
| Wire rope | 40-23 |
| Woodworking equipment | 40-31 |
| Woodworking | 30-65 |
| Wrenches | 40-14 |
| | |
| Z | |
| Zero code | 0-3 |