

Appendix D

ARAR Supporting Documents

Appendix D - Appendices

- Appendix D-1 E-Mail Correspondence from the United States Environmental Protection Agency (EPA) to Respondents, Titled “San Jacinto River Waste Pits - Surface Water Quality Standard,” Dated February 18, 2020
- Appendix D-2 Letter Correspondence from GHD to EPA, Titled “San Jacinto River Waste Pits Superfund Site - Northern Impoundment Waste Characterization Evaluation,” Dated October 20, 2020
- Appendix D-3 Letter Correspondence from EPA to Respondents, Titled “Regarding San Jacinto River Waste Pits Superfund Site - Northern Impoundment Waste Characterization Evaluation,” Dated November 19, 2020
- Appendix D-4 Letter Correspondence from GHD to Harris County Flood Control District, Titled “Overview of Floodplain Drainage Impact Analysis,” Dated May 6, 2022
- Appendix D-5 Letter Correspondence from GHD to Texas Department of Transportation, Titled “Velocity and Shear Stress Analysis,” Dated April 11, 2022
- Appendix D-6 Letter Correspondence from GHD to U.S. Army Corps of Engineers, titled “Nationwide Permit 38 Applicability Review,” Dated December 7, 2022

Appendices

Appendix D-1

E-Mail Correspondence from the United States Environmental Protection Agency (EPA) to Respondents, Titled “San Jacinto River Waste Pits - Surface Water Quality Standard,” Dated February 18, 2020

From: [Baumgarten, Gary](#)
To: [Janie Smith](#); [Charles Munce](#); [Philip.Slowiak@ipaper.com](#); [Judy Armour](#); [Paul.R.Schroeder@erdc.dren.mil](#); [Nicholas Casten](#); [Brent Sasser](#); [Gustavson, Kari](#); [Satya.Dwivedula@tceq.texas.gov](#); [Howard, Ashley](#); [Katie Delbecq \(katie.delbecq@tceq.texas.gov\)](#)
Cc: [Meyer, John](#); [Monica Harris \(monica.harris@tceq.texas.gov\)](#); [Foster, Anne](#)
Subject: RE: San Jacinto River Waste Pits - Surface Water Quality Standard
Date: Tuesday, February 18, 2020 1:30:17 PM

Good afternoon,

In my earlier email I identified the TSWQS for Dioxins/Furans as 7.97×10^{-8} µg/L. I inadvertently put the incorrect value for the TSWQS when stated in pg/L. The correct TSWQS for dioxins/furans in pg/L is 0.0797 pg/L.

My apologies for the error. The fully corrected text is included below:

The meeting summary from the December 17, 2019, San Jacinto River Waste Pits Technical Working Group (TWG) meeting acknowledges that the Texas Surface Water Quality Standard (TSWQS) for dioxins is an Applicable or Relevant and Appropriate Requirement (ARAR) for surface water discharge to the San Jacinto River as part of the San Jacinto River Waste Pits Site remedial action. The October 2017 Record of Decision for the Site states that the TSWQS for Dioxins/Furans is 7.97×10^{-8} µg/L [0.0797 pg/L] (as TCDD equivalents) [30 Texas Administrative Code §307.6(d)(a)(A) and (B) and §307.10].

The December 2019 TWG meeting summary noted that there has been no consensus on how compliance with this ARAR will be demonstrated. Pursuant to the Comprehensive Environmental Response, Compensation and Liability Act, as amended, EPA has made a determination on how compliance with the TSWQS ARAR will be demonstrated for this remedial action.

EPA has made this determination based on the substantive requirements of the state's regulation for surface water discharge. EPA has determined that compliance with the TSWQS ARAR will be attained as follows:

- The state surface water quality standard for Dioxins/Furans is 7.97×10^{-8} µg/L [0.0797 pg/L] (as TCDD equivalents);
- Compliance with the TSWQS will be determined using the minimum level^[1] of the EPA approved method (1613B), cited in 40 CFR Part 136 (GUIDELINES ESTABLISHING TEST PROCEDURES FOR THE ANALYSIS OF POLLUTANTS), in sampling of surface water discharges during the site remedial action;
- If an effluent sample analyzed for dioxin is below the minimum level using the EPA approved method, the sample result would be identified as non-detect and the discharge would be determined to be in compliance with the ARAR.

This approach is consistent with the state's guidance and other permits issued by TCEQ. EPA's determination is contingent on the water treatment facility using a 1 micron final filtration step in the water treatment process.

The above approach should be reflected in the appropriate design plans and the plans should include a testing frequency and process controls to ensure compliance.

[1] The Minimum Level (ML) for each analyte is defined as the level at which the entire analytical system must give a recognizable signal and acceptable calibration point. It is equivalent to the concentration of the lowest calibration standard, assuming that all method-specified sample weights, volumes, and cleanup procedures have been employed.

From: Baumgarten, Gary

Sent: Tuesday, February 18, 2020 11:07 AM

To: Janie.Smith@ghd.com; Charles Munce <charles.munce@ghd.com>; Philip.Slowiak@ipaper.com; Judy Armour <jarmour@wm.com>; Paul.R.Schroeder@erdc.dren.mil; nick.casten@ghd.com; Brent Sasser <Brent.Sasser@ipaper.com>; Gustavson, Karl <Gustavson.Karl@epa.gov>; Satya.Dwivedula@tceq.texas.gov; Howard, Ashley <Howard.Ashley@epa.gov>; Katie Delbecq (katie.delbecq@tceq.texas.gov) <katie.delbecq@tceq.texas.gov>

Cc: Meyer, John <Meyer.John@epa.gov>; Monica Harris (monica.harris@tceq.texas.gov) <monica.harris@tceq.texas.gov>; Foster, Anne <Foster.Anne@epa.gov>

Subject: San Jacinto River Waste Pits - Surface Water Quality Standard

Good morning,

The meeting summary from the December 17, 2019, San Jacinto River Waste Pits Technical Working Group (TWG) meeting acknowledges that the Texas Surface Water Quality Standard (TSWQS) for dioxins is an Applicable or Relevant and Appropriate Requirement (ARAR) for surface water discharge to the San Jacinto River as part of the San Jacinto River Waste Pits Site remedial action. The October 2017 Record of Decision for the Site states that the TSWQS for Dioxins/Furans is 7.97×10^{-8} µg/L [0.797 pg/L] (as TCDD equivalents) [30 Texas Administrative Code §307.6(d)(a)(A) and (B) and §307.10].

The December 2019 TWG meeting summary noted that there has been no consensus on how compliance with this ARAR will be demonstrated. Pursuant to the Comprehensive Environmental Response, Compensation and Liability Act, as amended, EPA has made a determination on how compliance with the TSWQS ARAR will be demonstrated for this remedial action.

EPA has made this determination based on the substantive requirements of the state's regulation for surface water discharge. EPA has determined that compliance with the TSWQS ARAR will be attained as follows:

- The state surface water quality standard for Dioxins/Furans is 7.97×10^{-8} µg/L [0.797 pg/L] (as TCDD equivalents);
- Compliance with the TSWQS will be determined using the minimum level^[1] of the EPA approved method (1613B), cited in 40 CFR Part 136 (GUIDELINES ESTABLISHING TEST

PROCEDURES FOR THE ANALYSIS OF POLLUTANTS), in sampling of surface water discharges during the site remedial action;

- If an effluent sample analyzed for dioxin is below the minimum level using the EPA approved method, the sample result would be identified as non-detect and the discharge would be determined to be in compliance with the ARAR.

This approach is consistent with the state's guidance and other permits issued by TCEQ. EPA's determination is contingent on the water treatment facility using a 1 micron final filtration step in the water treatment process.

The above approach should be reflected in the appropriate design plans and the plans should include a testing frequency and process controls to ensure compliance.

[1] The Minimum Level (ML) for each analyte is defined as the level at which the entire analytical system must give a recognizable signal and acceptable calibration point. It is equivalent to the concentration of the lowest calibration standard, assuming that all method-specified sample weights, volumes, and cleanup procedures have been employed.

Gary

[1] The Minimum Level (ML) for each analyte is defined as the level at which the entire analytical system must give a recognizable signal and acceptable calibration point. It is equivalent to the concentration of the lowest calibration standard, assuming that all method-specified sample weights, volumes, and cleanup procedures have been employed.

[1] The Minimum Level (ML) for each analyte is defined as the level at which the entire analytical system must give a recognizable signal and acceptable calibration point. It is equivalent to the concentration of the lowest calibration standard, assuming that all method-specified sample weights, volumes, and cleanup procedures have been employed.

This e-mail has been scanned for viruses

Appendix D-2

**Letter Correspondence from GHD to EPA,
Titled “San Jacinto River Waste Pits
Superfund Site - Northern Impoundment
Waste Characterization Evaluation,” Dated
October 20, 2020**



October 20, 2020

Reference No. 11215702

Mr. Gary Baumgarten, EPA Project Coordinator
United States Environmental Protection Agency, Superfund Division (6SF-RA)
1201 Elm Street, Suite 500
Dallas, Texas 75270

Dear Mr. Baumgarten:

**Re: San Jacinto River Waste Pits Superfund Site - Northern Impoundment
Waste Characterization Evaluation;
EPA Region 6, CERCLA Docket No. 06-02-18 for Remedial Design**

On behalf of International Paper Company (IPC) and McGinnes Industrial Maintenance Corporation (MIMC; collectively referred to as the Respondents), GHD Services Inc. (GHD) submits this letter to the United States Environmental Protection Agency (EPA) in connection with the remedial design (RD) for the Northern Impoundment of the San Jacinto River Waste Pits Site in Harris County, Texas (Site). Its purpose is to describe how pulp and paper mill waste (Waste), proposed to be excavated as part of the Northern Impoundment remedial action (RA), has been characterized and classified in accordance with the Resource Conservation and Recovery Act (RCRA) regulations. Based on the waste characterization process described below, the Waste is not a hazardous waste.

1. Site History

The Site is located in Harris County, Texas, east of the City of Houston, between two unincorporated areas known as Channelview and Highlands. The Northern Impoundment was operated as a monofill for the disposal of Waste for an approximate nine month period from September 1965 to May 1966. The Northern Impoundment is located immediately north of the Interstate Highway 10 (I-10) bridge over the San Jacinto River.

According to the Record of Decision (ROD), the RA for the Northern Impoundment will include, among other things, removal of approximately 162,000 cubic yards (cy) of Waste exceeding the EPA-selected cleanup level of 30 nanograms per kilogram (ng/kg) of 2,3,7,8-tetrachlorodibenzo-p-dioxin (TCDD) toxicity equivalent (TEQ) located beneath an armored cap in the Northern Impoundment. The volume of Waste to be removed, as estimated for purposes of the Northern Impoundment 30% RD, is now understood to be approximately 212,000 cy.

A figure of the Northern Impoundment has been included as Figure 1.

2. Waste Characterization Evaluation

Material excavated for off-site disposal from a Superfund site is not, simply by virtue of the material containing hazardous substances, considered to be a hazardous waste as defined by RCRA. Rather, the



material must be characterized following the requirements in RCRA to determine whether it is a hazardous waste. In accordance with Title 40 of the Code of Federal Regulations (CFR) Part 261 - Identification and Listing of Hazardous Waste, the applicable requirements in the following subparts of Part 261 were evaluated:

Subpart A - Definition of Solid Waste, Hazardous Waste & Exclusions (§§ 261.1-.9)

Subpart B - Criteria for Identifying the Characteristics and Listing of Hazardous Wastes (§§ 261.10-.11)

Subpart C - Characteristics of Hazardous Waste (§§ 261.20-.24)

Subpart D - Lists of Hazardous Wastes (§§ 261.30-.33)

The Waste consists solely of wastewater treatment sludge generated at the Champion Pulp and Paper Mill in Pasadena, Texas in the mid-1960's. The wastewater from the pulp and paper manufacturing process was processed through primary settling basins for suspended solids removal. The slurried solids from the primary basins were pumped sequentially to two secondary basins for further dewatering and accumulation pending disposal. The accumulated solids in these secondary basins were removed and barged to the Northern Impoundment for disposal. The Waste, consisting primarily of cellulose wood pulp and clay binders, contains dioxins and furans which were formed as an unintentional by-product of the pulp bleaching process.

2.1 Is the Waste classified as a Solid Waste under RCRA?

The definition of "solid waste" is any discarded material that is not excluded under § 261.4 (a), by a variance under § 260.31, or by a non-waste determination under § 260.30 and § 260.34.

A "discarded material" is any material that is:

- Abandoned
- Recycled
- Considered inherently waste-like

The Waste meets the definition of a "solid waste" since it is a "discarded material." Further, none of the solid waste exclusions cited above apply to the Waste. Since the Waste is a "solid waste," the next step in the characterization process was to determine whether it is a "hazardous waste." A solid waste is characterized as a hazardous waste either because (1) it is listed on one of the four lists of hazardous wastes developed by EPA, or (2) it exhibits one of the four characteristics of a hazardous waste as defined in EPA's regulations.

2.2 Is the Waste a Listed Hazardous Waste under RCRA?

A solid waste is classified as a hazardous waste if it is on one of the four lists of hazardous wastes contained in 40 CFR §§ 261.31-261.33 and is not otherwise excluded from classification as a hazardous waste. Each list is referred to with reference to a "code" ("F", "K", "P", and "U"). As detailed below, the Waste is not on either the "F" list in 40 CFR § 261.31 or the "K" list in 40 CFR § 261.32. Furthermore, as a



manufacturing process waste, the Waste is not considered a discarded commercial chemical product subject to the listings in § 261.33 which contain the “P” and “U” lists. Thus, the Waste is not a listed hazardous waste.

2.2.1 Listed Hazardous Waste Codes from Non-Specific Sources (“F” Codes)

Under the RCRA program, there are a number of solid wastes that are classified as hazardous wastes because they fall within the listing descriptions in 40 CFR § 261.31 (Hazardous Wastes from Non-Specific Sources). Twenty-eight F-coded wastes are currently identified in § 261.31 by waste codes ranging from F001 through F039. A complete list of the § 261.31 waste code descriptions is provided in Attachment A.

The § 261.31 F-list of hazardous wastes identifies manufacturing process wastes produced by a wide variety of industrial operations. For this reason, these listed wastes are referred to as process wastes generated “from nonspecific sources.” Waste Codes F020 to F023 and F026 to F028 were included in the F-list, at least in part, due to the presence of dioxin or dioxin precursors in the wastes. These wastes are described as follows:

F020 = *Wastes from the production or manufacturing use of tri- or tetrachlorophenol, or of intermediates used to produce their pesticide derivatives.*

F021 = *Wastes from the production or manufacturing use of pentachlorophenol, or of intermediates used to produce its derivatives.*

F022 = *Wastes from the manufacturing use of tetra-, penta-, or hexachlorobenzenes under alkaline conditions.*

F023 = *Wastes from the production of materials on equipment previously used for the production or manufacturing use of tri- and tetrachlorophenols.*

F026 = *Wastes from the production of materials on equipment previously used for the manufacturing use of tetra-, penta-, or hexachlorobenzene under alkaline conditions.*

F027 = *Discarded unused formulations containing tri-, tetra-, or pentachlorophenol or discarded unused formulations containing compounds derived from these chlorophenols.*

F028 = *Residues resulting from the incineration or thermal treatment of soils contaminated with EPA Hazardous Waste Nos. F020, F021, F022, F023, F026, and F027.*

The following F-codes could also contain dioxins:

F032 = *Wastewaters, process residuals, preservative drippage, and spent formulations from wood preserving processes generated at plants that currently use or have used chlorophenolic formulations.*

F039 = *Leachate resulting from the disposal of more than one restricted waste classified as hazardous under subpart D.*

The Waste was compared to the full list of F-coded waste, including those set out above, and it was determined that the Waste does not come within any of these waste descriptions.



2.2.2 Listed Hazardous Waste Codes from Specific Sources (“K” Codes)

Under the RCRA program, there are also a number of solid wastes listed as hazardous wastes under 40 CFR § 261.32 because they are generated from specifically named sources. The complete list of hazardous waste code descriptions from § 261.32 is provided in Attachment A. This list is subdivided into groups of wastes generated from several specific industrial categories, such as inorganic pigments, organic chemicals, pesticides, petroleum refining, and so forth. Since pulp and paper production is not one of these industrial categories, the Waste is not a K-listed waste.

2.2.3 Listed Hazardous Waste Codes from Commercial Chemical Products (“P” and “U” Codes)

The “P” and “U” codes are specific to unused commercial chemical products (CCP), off-specification materials, container and spill residues referenced by name at 40 CFR 261.33 (e) and (f). As noted in the Comment following § 261.33 (d), the CCP lists do not apply to “a material, such as a manufacturing process waste, that contains any of the substances listed in paragraph (e) or (f) [the “P” and “U” lists of CCPs]. Where a manufacturing process waste is deemed to be a hazardous waste because it contains a substance listed in paragraph (e) or (f), such a waste will be listed in either § 261.31 or § 261.32 or will be identified as a hazardous waste by the characteristics set forth in subpart C of this part.”

Since the Waste is a discarded manufacturing process waste, it is not included in the CCP lists in § 261.33. Moreover, as summarized above, the Waste is not listed in either § 261.31 or § 261.32; thus, the Waste is not a listed hazardous waste under the RCRA regulations.

2.3 Does the Waste Exhibit Characteristics of Hazardous Waste under RCRA?

Under RCRA, a solid waste may also be a hazardous waste if it exhibits any of the following four characteristics:

Ignitability (D001)

- Liquid with flash point < 140°F
- Solid capable of causing fire under standard temperature and pressure (STP) and burns vigorously when ignited to create a hazard
- Ignitable compressed gas
- Oxidizer (as defined by US Department of Transportation)

Corrosivity (D002)

- Aqueous with a pH of less than or equal to 2 or greater than or equal to 12.5
- Liquid which corrodes steel at a rate greater than 0.25 inch per year at temperature of 130°F

Reactivity (D003)

- Normally unstable and readily undergoes violent change without detonating.



- Reacts violently with water or forms potentially explosive mixtures with water. When mixed with water, generates toxic gases, vapors or fumes.
- Cyanide or sulfide bearing waste which, when exposed to pH conditions between 2 and 12.5, can generate toxic gases, vapors or fumes.
- Capable of detonation or explosive reaction if it is subjected to a strong initiating source or if heated under confinement.
- Capable of detonation or explosive decomposition or reaction at STP.
- It is a forbidden, Class A or Class B explosive in accordance with US Department of Transportation.

Toxicity (D004-D043)

- Exhibits the characteristic of toxicity, if using Toxicity Characteristic Leaching Procedure (TCLP) test method 1311, the extract from a representative sample of the waste contains any of the constituents listed in Table 1 at a concentration equal to or greater than the value for that constituent. See Table 1 - Maximum Concentration of Contaminants for the Toxicity Characteristic at 40 CFR 261.24.
- Total of 40 regulated constituents: heavy metals, volatile organic compounds (VOCs), semi-volatile organic compounds (SVOCs), pesticides/ herbicides.

During PDI-1 and PDI-2, representative samples of the Waste were collected in accordance with *Test Methods for Evaluating Solid Waste, Physical/Chemical Methods*, EPA publication SW-846 (incorporated by reference in the RCRA regulations at 40 CFR 260.10), and tested to determine whether the Waste exhibits any of the characteristics of hazardous waste as defined in EPA regulations. The samples were collected at various locations across the Northern Impoundment as shown in Figure 1. The EPA defines “representative sample” at 40 CFR 260.10 as “a sample of a universe or whole (e.g., waste pile, lagoon, ground water) which can be expected to exhibit the average properties of the universe or whole”. The material in the Northern Impoundment has previously been determined to consist of a single waste stream deposited into the Northern Impoundment over a brief period in the mid-1960s, where it has remained. During the PDI, a set of seven multi-increment composite waste characterization samples were collected from nine different physical locations at the Northern Impoundment. With the exception of the sample collected from the Pilot Test excavation (Composite 1), samples consisted of multiple 2-ft discrete interval samples composited over the total depth of the boring interval (total sample depths ranged from 9 to 20 feet below ground surface). For Composite 1, material was composited from multiple locations within the approximately 20 ft by 20 ft by 4 ft excavation. See Figure 1 for sample intervals. These samples included material with variable physical (moisture content, grain size, etc.), and chemical characteristics. Samples were also collected from areas in which the highest concentrations of dioxins had been detected in prior sampling. Based on the above, the samples meet the definition of “representative samples” under EPA’s regulations.

Based on waste characterization test data, the Waste in the Northern Impoundment does not exhibit the characteristics of ignitability, corrosivity, reactivity or toxicity as defined by the EPA regulations. This is demonstrated by confirmatory analyses conducted for pH (corrosivity), flash point (ignitability), reactive



cyanide/sulfide (reactivity) and TCLP constituent concentrations (toxicity). The TCLP tests on the Waste showed no exceedances for any of the D004 through D043 regulated constituents. These test results are provided in Attachment B. Therefore, the Waste is not a hazardous waste due to the existence of a characteristic of a hazardous waste.

2.4 How will Contaminated Media from the Northern Impoundment RA that will be Disposed of Off-Site be Classified Under EPA's "Contained-in" Policy?

Under the EPA's "contained-in" policy, contaminated media at a Superfund site is subject to regulation as a hazardous waste only if it "contains" a listed hazardous waste or exhibits a characteristic of a hazardous waste. In this case, any contaminated media to be disposed of off-site during the Northern Impoundment RA would not be a hazardous waste under RCRA because (1) it would not "contain" a listed hazardous waste (because the Waste is not a listed hazardous waste), and (2) the media would not exhibit a characteristic of hazardous waste (because the Waste is not a characteristic hazardous waste).

3. Conclusion

Based on an evaluation of information about the pulp and paper mill waste disposed of in the Northern Impoundment and the results of testing of the Waste that was performed during PDI-1 and PDI-2, the Waste is not a RCRA hazardous waste. GHD requests a concurrence from the EPA regarding the classification of Waste to be disposed of off-site during the Northern Impoundment RA.

Should you have any questions or require additional information regarding this submittal, please contact GHD at (225) 292-9007.

Sincerely,

GHD

A handwritten signature in black ink, appearing to read 'C. Munce'.

Charles W. Munce, P.E.

ETW/kdn/2

Encl.: Figure 1 - Northern Impoundment Waste Characterization Sample Locations
Attachment A - EPA Waste Code Descriptions
Attachment B - Analytical Data Tables

cc: Phil Slowiak, IPC
Brent Sasser, IPC
Judy Armour, MIMC
Katie Delbecq, Texas Commission on Environmental Quality

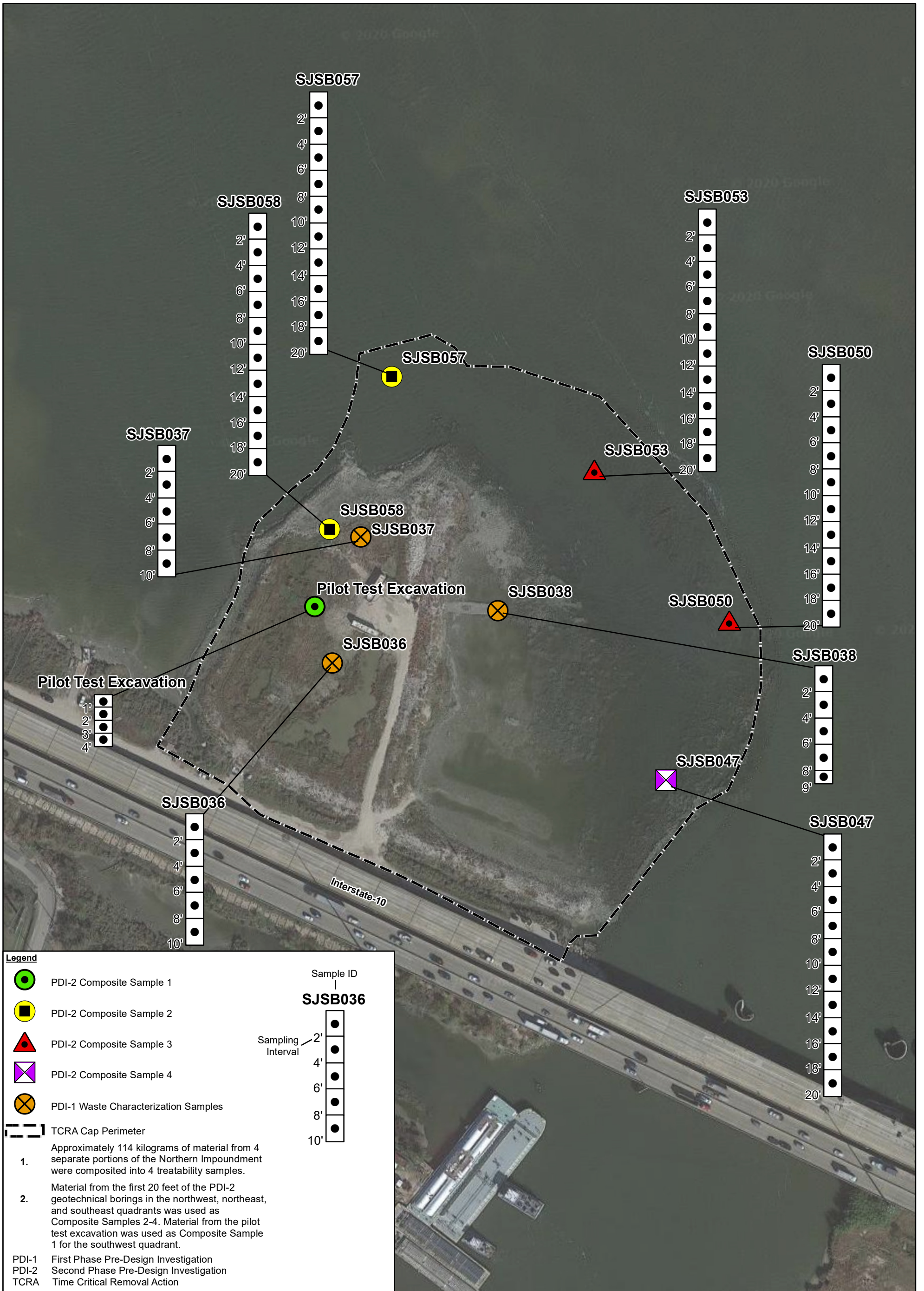

Source: Image ©2020 Google, Imagery date: 10/28/2017

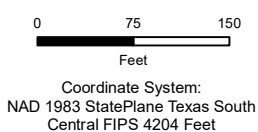

Coordinate System:
NAD 1983 StatePlane Texas South
Central FIPS 4204 Feet



SAN JACINTO RIVER WASTE PITS SITE
HARRIS COUNTY, TEXAS

NORTHERN IMPOUNDMENT WASTE CHARACTERIZATION
SAMPLE LOCATIONS

11215702
Oct 16, 2020

FIGURE 1

Attachment A
EPA Waste Code Descriptions
(Title 40 CFR §261.31 and §261.32)

§ 261.31

40 CFR Ch. I (7–1–11 Edition)

must be used in complying with the notification requirements of Section 3010 of the Act and certain recordkeeping and reporting requirements under parts 262 through 265, 267, 268, and 270 of this chapter.

(d) The following hazardous wastes listed in § 261.31 are subject to the exclusion limits for acutely hazardous wastes established in § 261.5: EPA Hazardous Wastes Nos. F020, F021, F022, F023, F026 and F027.

[45 FR 33119, May 19, 1980, as amended at 48 FR 14294, Apr. 1, 1983; 50 FR 2000, Jan. 14, 1985; 51 FR 40636, Nov. 7, 1986; 55 FR 11863, Mar. 29, 1990; 75 FR 13002, Mar. 18, 2010]

§ 261.31 Hazardous wastes from non-specific sources.

(a) The following solid wastes are listed hazardous wastes from non-specific sources unless they are excluded under §§ 260.20 and 260.22 and listed in appendix IX.

Industry and EPA hazardous waste No.	Hazardous waste	Hazard code
Generic: F001	The following spent halogenated solvents used in degreasing: Tetrachloroethylene, trichloroethylene, methylene chloride, 1,1,1-trichloroethane, carbon tetrachloride, and chlorinated fluorocarbons; all spent solvent mixtures/blends used in degreasing containing, before use, a total of ten percent or more (by volume) of one or more of the above halogenated solvents or those solvents listed in F002, F004, and F005; and still bottoms from the recovery of these spent solvents and spent solvent mixtures.	(T)
F002	The following spent halogenated solvents: Tetrachloroethylene, methylene chloride, trichloroethylene, 1,1,1-trichloroethane, chlorobenzene, 1,1,2-trichloro-1,2,2-trifluoroethane, ortho-dichlorobenzene, trichlorofluoromethane, and 1,1,2-trichloroethane; all spent solvent mixtures/blends containing, before use, a total of ten percent or more (by volume) of one or more of the above halogenated solvents or those listed in F001, F004, or F005; and still bottoms from the recovery of these spent solvents and spent solvent mixtures.	(T)
F003	The following spent non-halogenated solvents: Xylene, acetone, ethyl acetate, ethyl benzene, ethyl ether, methyl isobutyl ketone, n-butyl alcohol, cyclohexanone, and methanol; all spent solvent mixtures/blends containing, before use, only the above spent non-halogenated solvents; and all spent solvent mixtures/blends containing, before use, one or more of the above non-halogenated solvents, and, a total of ten percent or more (by volume) of one or more of those solvents listed in F001, F002, F004, and F005; and still bottoms from the recovery of these spent solvents and spent solvent mixtures.	(I)*
F004	The following spent non-halogenated solvents: Cresols and cresylic acid, and nitrobenzene; all spent solvent mixtures/blends containing, before use, a total of ten percent or more (by volume) of one or more of the above non-halogenated solvents or those solvents listed in F001, F002, and F005; and still bottoms from the recovery of these spent solvents and spent solvent mixtures.	(T)
F005	The following spent non-halogenated solvents: Toluene, methyl ethyl ketone, carbon disulfide, isobutanol, pyridine, benzene, 2-ethoxyethanol, and 2-nitropropane; all spent solvent mixtures/blends containing, before use, a total of ten percent or more (by volume) of one or more of the above non-halogenated solvents or those solvents listed in F001, F002, or F004; and still bottoms from the recovery of these spent solvents and spent solvent mixtures.	(I,T)
F006	Wastewater treatment sludges from electroplating operations except from the following processes: (1) Sulfuric acid anodizing of aluminum; (2) tin plating on carbon steel; (3) zinc plating (segregated basis) on carbon steel; (4) aluminum or zinc-aluminum plating on carbon steel; (5) cleaning/stripping associated with tin, zinc and aluminum plating on carbon steel; and (6) chemical etching and milling of aluminum.	(T)
F007	Spent cyanide plating bath solutions from electroplating operations	(R, T)
F008	Plating bath residues from the bottom of plating baths from electroplating operations where cyanides are used in the process.	(R, T)
F009	Spent stripping and cleaning bath solutions from electroplating operations where cyanides are used in the process.	(R, T)
F010	Quenching bath residues from oil baths from metal heat treating operations where cyanides are used in the process.	(R, T)
F011	Spent cyanide solutions from salt bath pot cleaning from metal heat treating operations.	(R, T)
F012	Quenching waste water treatment sludges from metal heat treating operations where cyanides are used in the process.	(T)

Environmental Protection Agency

§ 261.31

Industry and EPA hazardous waste No.	Hazardous waste	Hazard code
F019	Wastewater treatment sludges from the chemical conversion coating of aluminum except from zirconium phosphating in aluminum can washing when such phosphating is an exclusive conversion coating process. Wastewater treatment sludges from the manufacturing of motor vehicles using a zinc phosphating process will not be subject to this listing at the point of generation if the wastes are not placed outside on the land prior to shipment to a landfill for disposal and are either: disposed in a Subtitle D municipal or industrial landfill unit that is equipped with a single clay liner and is permitted, licensed or otherwise authorized by the state; or disposed in a landfill unit subject to, or otherwise meeting, the landfill requirements in § 258.40, § 264.301 or § 265.301. For the purposes of this listing, motor vehicle manufacturing is defined in paragraph (b)(4)(i) of this section and (b)(4)(ii) of this section describes the recordkeeping requirements for motor vehicle manufacturing facilities.	(T)
F020	Wastes (except wastewater and spent carbon from hydrogen chloride purification) from the production or manufacturing use (as a reactant, chemical intermediate, or component in a formulating process) of tri- or tetrachlorophenol, or of intermediates used to produce their pesticide derivatives. (This listing does not include wastes from the production of Hexachlorophene from highly purified 2,4,5-trichlorophenol.)	(H)
F021	Wastes (except wastewater and spent carbon from hydrogen chloride purification) from the production or manufacturing use (as a reactant, chemical intermediate, or component in a formulating process) of pentachlorophenol, or of intermediates used to produce its derivatives.	(H)
F022	Wastes (except wastewater and spent carbon from hydrogen chloride purification) from the manufacturing use (as a reactant, chemical intermediate, or component in a formulating process) of tetra-, penta-, or hexachlorobenzenes under alkaline conditions.	(H)
F023	Wastes (except wastewater and spent carbon from hydrogen chloride purification) from the production of materials on equipment previously used for the production or manufacturing use (as a reactant, chemical intermediate, or component in a formulating process) of tri- and tetrachlorophenols. (This listing does not include wastes from equipment used only for the production or use of Hexachlorophene from highly purified 2,4,5-trichlorophenol.)	(H)
F024	Process wastes, including but not limited to, distillation residues, heavy ends, tars, and reactor clean-out wastes, from the production of certain chlorinated aliphatic hydrocarbons by free radical catalyzed processes. These chlorinated aliphatic hydrocarbons are those having carbon chain lengths ranging from one to and including five, with varying amounts and positions of chlorine substitution. (This listing does not include wastewaters, wastewater treatment sludges, spent catalysts, and wastes listed in § 261.31 or § 261.32.)	(T)
F025	Condensed light ends, spent filters and filter aids, and spent desiccant wastes from the production of certain chlorinated aliphatic hydrocarbons, by free radical catalyzed processes. These chlorinated aliphatic hydrocarbons are those having carbon chain lengths ranging from one to and including five, with varying amounts and positions of chlorine substitution.	(T)
F026	Wastes (except wastewater and spent carbon from hydrogen chloride purification) from the production of materials on equipment previously used for the manufacturing use (as a reactant, chemical intermediate, or component in a formulating process) of tetra-, penta-, or hexachlorobenzene under alkaline conditions.	(H)
F027	Discarded unused formulations containing tri-, tetra-, or pentachlorophenol or discarded unused formulations containing compounds derived from these chlorophenols. (This listing does not include formulations containing Hexachlorophene synthesized from prepurified 2,4,5-trichlorophenol as the sole component.)	(H)
F028	Residues resulting from the incineration or thermal treatment of soil contaminated with EPA Hazardous Waste Nos. F020, F021, F022, F023, F026, and F027.	(T)
F032	Wastewaters (except those that have not come into contact with process contaminants), process residuals, preservative drippage, and spent formulations from wood preserving processes generated at plants that currently use or have previously used chlorophenolic formulations (except potentially cross-contaminated wastes that have had the F032 waste code deleted in accordance with § 261.35 of this chapter or potentially cross-contaminated wastes that are otherwise currently regulated as hazardous wastes (i.e., F034 or F035), and where the generator does not resume or initiate use of chlorophenolic formulations). This listing does not include K001 bottom sediment sludge from the treatment of wastewater from wood preserving processes that use creosote and/or pentachlorophenol.	(T)
F034	Wastewaters (except those that have not come into contact with process contaminants), process residuals, preservative drippage, and spent formulations from wood preserving processes generated at plants that use creosote formulations. This listing does not include K001 bottom sediment sludge from the treatment of wastewater from wood preserving processes that use creosote and/or pentachlorophenol.	(T)

§ 261.31

40 CFR Ch. I (7–1–11 Edition)

Industry and EPA hazardous waste No.	Hazardous waste	Hazard code
F035	Wastewaters (except those that have not come into contact with process contaminants), process residuals, preservative drippage, and spent formulations from wood preserving processes generated at plants that use inorganic preservatives containing arsenic or chromium. This listing does not include K001 bottom sediment sludge from the treatment of wastewater from wood preserving processes that use creosote and/or pentachlorophenol.	(T)
F037	Petroleum refinery primary oil/water/solids separation sludge—Any sludge generated from the gravitational separation of oil/water/solids during the storage or treatment of process wastewaters and oily cooling wastewaters from petroleum refineries. Such sludges include, but are not limited to, those generated in oil/water/solids separators; tanks and impoundments; ditches and other conveyances; sumps; and stormwater units receiving dry weather flow. Sludge generated in stormwater units that do not receive dry weather flow, sludges generated from non-contact once-through cooling waters segregated for treatment from other process or oily cooling waters, sludges generated in aggressive biological treatment units as defined in §261.31(b)(2) (including sludges generated in one or more additional units after wastewaters have been treated in aggressive biological treatment units) and K051 wastes are not included in this listing. This listing does include residuals generated from processing or recycling oil-bearing hazardous secondary materials excluded under §261.4(a)(12)(i), if those residuals are to be disposed of.	(T)
F038	Petroleum refinery secondary (emulsified) oil/water/solids separation sludge—Any sludge and/or float generated from the physical and/or chemical separation of oil/water/solids in process wastewaters and oily cooling wastewaters from petroleum refineries. Such wastes include, but are not limited to, all sludges and floats generated in: induced air flotation (IAF) units, tanks and impoundments, and all sludges generated in DAF units. Sludges generated in stormwater units that do not receive dry weather flow, sludges generated from non-contact once-through cooling waters segregated for treatment from other process or oily cooling waters, sludges and floats generated in aggressive biological treatment units as defined in §261.31(b)(2) (including sludges and floats generated in one or more additional units after wastewaters have been treated in aggressive biological treatment units) and F037, K048, and K051 wastes are not included in this listing.	(T)
F039	Leachate (liquids that have percolated through land disposed wastes) resulting from the disposal of more than one restricted waste classified as hazardous under subpart D of this part. (Leachate resulting from the disposal of one or more of the following EPA Hazardous Wastes and no other Hazardous Wastes retains its EPA Hazardous Waste Number(s): F020, F021, F022, F026, F027, and/or F028.)	(T)

*(I,T) should be used to specify mixtures that are ignitable and contain toxic constituents.

(b) Listing Specific Definitions: (1) For the purposes of the F037 and F038 listings, oil/water/solids is defined as oil and/or water and/or solids.(2) (i) For the purposes of the F037 and F038 listings, aggressive biological treatment units are defined as units which employ one of the following four treatment methods: activated sludge; trickling filter; rotating biological contactor for the continuous accelerated biological oxidation of wastewaters; or high-rate aeration. High-rate aeration is a system of surface impoundments or tanks, in which intense mechanical aeration is used to completely mix the wastes, enhance biological activity, and (A) the units employ a minimum of 6 hp per million gallons of treatment volume; and either (B) the hydraulic retention time of the unit is no longer than 5 days; or (C) the hydraulic retention time is no longer than 30 days and the unit does not generate a sludge

that is a hazardous waste by the Toxicity Characteristic.

(ii) Generators and treatment, storage and disposal facilities have the burden of proving that their sludges are exempt from listing as F037 and F038 wastes under this definition. Generators and treatment, storage and disposal facilities must maintain, in their operating or other onsite records, documents and data sufficient to prove that: (A) the unit is an aggressive biological treatment unit as defined in this subsection; and (B) the sludges sought to be exempted from the definitions of F037 and/or F038 were actually generated in the aggressive biological treatment unit.

(3) (i) For the purposes of the F037 listing, sludges are considered to be generated at the moment of deposition in the unit, where deposition is defined as at least a temporary cessation of lateral particle movement.

Environmental Protection Agency

§ 261.32

(ii) For the purposes of the F038 listing, (A) sludges are considered to be generated at the moment of deposition in the unit, where deposition is defined as at least a temporary cessation of lateral particle movement and (B) floats are considered to be generated at the moment they are formed in the top of the unit.

(4) For the purposes of the F019 listing, the following apply to wastewater treatment sludges from the manufacturing of motor vehicles using a zinc phosphating process.

(i) Motor vehicle manufacturing is defined to include the manufacture of automobiles and light trucks/utility vehicles (including light duty vans, pick-up trucks, minivans, and sport utility vehicles). Facilities must be engaged in manufacturing complete vehicles (body and chassis or unibody) or chassis only.

(ii) Generators must maintain in their on-site records documentation

and information sufficient to prove that the wastewater treatment sludges to be exempted from the F019 listing meet the conditions of the listing. These records must include: the volume of waste generated and disposed of off site; documentation showing when the waste volumes were generated and sent off site; the name and address of the receiving facility; and documentation confirming receipt of the waste by the receiving facility. Generators must maintain these documents on site for no less than three years. The retention period for the documentation is automatically extended during the course of any enforcement action or as requested by the Regional Administrator or the state regulatory authority.

[46 FR 4617, Jan. 16, 1981]

EDITORIAL NOTE: For FEDERAL REGISTER citations affecting §261.31, see the List of CFR Sections Affected, which appears in the Finding Aids section of the printed volume and at www.fdsys.gov.

§ 261.32 Hazardous wastes from specific sources.

(a) The following solid wastes are listed hazardous wastes from specific sources unless they are excluded under §§ 260.20 and 260.22 and listed in appendix IX.

Industry and EPA hazardous waste No.	Hazardous waste	Hazard code
Wood preservation: K001	Bottom sediment sludge from the treatment of wastewaters from wood preserving processes that use creosote and/or pentachlorophenol.	(T)
Inorganic pigments:		
K002	Wastewater treatment sludge from the production of chrome yellow and orange pigments.	(T)
K003	Wastewater treatment sludge from the production of molybdate orange pigments	(T)
K004	Wastewater treatment sludge from the production of zinc yellow pigments	(T)
K005	Wastewater treatment sludge from the production of chrome green pigments	(T)
K006	Wastewater treatment sludge from the production of chrome oxide green pigments (anhydrous and hydrated).	(T)
K007	Wastewater treatment sludge from the production of iron blue pigments	(T)
K008	Oven residue from the production of chrome oxide green pigments	(T)
Organic chemicals:		
K009	Distillation bottoms from the production of acetaldehyde from ethylene	(T)
K010	Distillation side cuts from the production of acetaldehyde from ethylene	(T)
K011	Bottom stream from the wastewater stripper in the production of acrylonitrile	(R, T)
K013	Bottom stream from the acetonitrile column in the production of acrylonitrile	(R, T)
K014	Bottoms from the acetonitrile purification column in the production of acrylonitrile	(T)
K015	Still bottoms from the distillation of benzyl chloride	(T)
K016	Heavy ends or distillation residues from the production of carbon tetrachloride	(T)
K017	Heavy ends (still bottoms) from the purification column in the production of epichlorohydrin.	(T)
K018	Heavy ends from the fractionation column in ethyl chloride production	(T)
K019	Heavy ends from the distillation of ethylene dichloride in ethylene dichloride production.	(T)
K020	Heavy ends from the distillation of vinyl chloride in vinyl chloride monomer production	(T)
K021	Aqueous spent antimony catalyst waste from fluoromethanes production	(T)
K022	Distillation bottom tars from the production of phenol/acetone from cumene	(T)
K023	Distillation light ends from the production of phthalic anhydride from naphthalene	(T)
K024	Distillation bottoms from the production of phthalic anhydride from naphthalene	(T)
K025	Distillation bottoms from the production of nitrobenzene by the nitration of benzene ...	(T)
K026	Stripping still tails from the production of methy ethyl pyridines	(T)
K027	Centrifuge and distillation residues from toluene diisocyanate production	(R, T)

Industry and EPA hazardous waste No.	Hazardous waste	Hazard code
K028	Spent catalyst from the hydrochlorinator reactor in the production of 1,1,1-trichloroethane.	(T)
K029	Waste from the product steam stripper in the production of 1,1,1-trichloroethane	(T)
K030	Column bottoms or heavy ends from the combined production of trichloroethylene and perchloroethylene.	(T)
K083	Distillation bottoms from aniline production	(T)
K085	Distillation or fractionation column bottoms from the production of chlorobenzenes	(T)
K093	Distillation light ends from the production of phthalic anhydride from ortho-xylene	(T)
K094	Distillation bottoms from the production of phthalic anhydride from ortho-xylene	(T)
K095	Distillation bottoms from the production of 1,1,1-trichloroethane	(T)
K096	Heavy ends from the heavy ends column from the production of 1,1,1-trichloroethane	(T)
K103	Process residues from aniline extraction from the production of aniline	(T)
K104	Combined wastewater streams generated from nitrobenzene/aniline production	(T)
K105	Separated aqueous stream from the reactor product washing step in the production of chlorobenzenes.	(T)
K107	Column bottoms from product separation from the production of 1,1-dimethylhydrazine (UDMH) from carboxylic acid hydrazines.	(C,T)
K108	Condensed column overheads from product separation and condensed reactor vent gases from the production of 1,1-dimethylhydrazine (UDMH) from carboxylic acid hydrazides.	(I,T)
K109	Spent filter cartridges from product purification from the production of 1,1-dimethylhydrazine (UDMH) from carboxylic acid hydrazides.	(T)
K110	Condensed column overheads from intermediate separation from the production of 1,1-dimethylhydrazine (UDMH) from carboxylic acid hydrazides.	(T)
K111	Product washwaters from the production of dinitrotoluene via nitration of toluene	(C,T)
K112	Reaction by-product water from the drying column in the production of toluenediamine via hydrogenation of dinitrotoluene.	(T)
K113	Condensed liquid light ends from the purification of toluenediamine in the production of toluenediamine via hydrogenation of dinitrotoluene.	(T)
K114	Vicinals from the purification of toluenediamine in the production of toluenediamine via hydrogenation of dinitrotoluene.	(T)
K115	Heavy ends from the purification of toluenediamine in the production of toluenediamine via hydrogenation of dinitrotoluene.	(T)
K116	Organic condensate from the solvent recovery column in the production of toluene diisocyanate via phosgenation of toluenediamine.	(T)
K117	Wastewater from the reactor vent gas scrubber in the production of ethylene dibromide via bromination of ethene.	(T)
K118	Spent adsorbent solids from purification of ethylene dibromide in the production of ethylene dibromide via bromination of ethene.	(T)
K136	Still bottoms from the purification of ethylene dibromide in the production of ethylene dibromide via bromination of ethene.	(T)
K149	Distillation bottoms from the production of alpha- (or methyl-) chlorinated toluenes, ring-chlorinated toluenes, benzoyl chlorides, and compounds with mixtures of these functional groups, (This waste does not include still bottoms from the distillation of benzyl chloride.)	(T)
K150	Organic residuals, excluding spent carbon adsorbent, from the spent chlorine gas and hydrochloric acid recovery processes associated with the production of alpha- (or methyl-) chlorinated toluenes, ring-chlorinated toluenes, benzoyl chlorides, and compounds with mixtures of these functional groups.	(T)
K151	Wastewater treatment sludges, excluding neutralization and biological sludges, generated during the treatment of wastewaters from the production of alpha- (or methyl-) chlorinated toluenes, ring-chlorinated toluenes, benzoyl chlorides, and compounds with mixtures of these functional groups.	(T)
K156	Organic waste (including heavy ends, still bottoms, light ends, spent solvents, filtrates, and decantates) from the production of carbamates and carbamoyl oximes. (This listing does not apply to wastes generated from the manufacture of 3-iodo-2-propynyl n-butylcarbamate.)	(T)
K157	Wastewaters (including scrubber waters, condenser waters, washwaters, and separation waters) from the production of carbamates and carbamoyl oximes. (This listing does not apply to wastes generated from the manufacture of 3-iodo-2-propynyl n-butylcarbamate.)	(T)
K158	Bag house dusts and filter/separation solids from the production of carbamates and carbamoyl oximes. (This listing does not apply to wastes generated from the manufacture of 3-iodo-2-propynyl n-butylcarbamate.)	(T)
K159	Organics from the treatment of thiocarbamate wastes	(T)
K161	Purification solids (including filtration, evaporation, and centrifugation solids), bag house dust and floor sweepings from the production of dithiocarbamate acids and their salts. (This listing does not include K125 or K126.)	(R,T)

Environmental Protection Agency

§ 261.32

Industry and EPA hazardous waste No.	Hazardous waste	Hazard code
K174	Wastewater treatment sludges from the production of ethylene dichloride or vinyl chloride monomer (including sludges that result from commingled ethylene dichloride or vinyl chloride monomer wastewater and other wastewater), unless the sludges meet the following conditions: (i) they are disposed of in a subtitle C or non-hazardous landfill licensed or permitted by the state or federal government; (ii) they are not otherwise placed on the land prior to final disposal; and (iii) the generator maintains documentation demonstrating that the waste was either disposed of in an on-site landfill or consigned to a transporter or disposal facility that provided a written commitment to dispose of the waste in an off-site landfill. Respondents in any action brought to enforce the requirements of subtitle C must, upon a showing by the government that the respondent managed wastewater treatment sludges from the production of vinyl chloride monomer or ethylene dichloride, demonstrate that they meet the terms of the exclusion set forth above. In doing so, they must provide appropriate documentation (e.g., contracts between the generator and the landfill owner/operator, invoices documenting delivery of waste to landfill, etc.) that the terms of the exclusion were met.	(T)
K175	Wastewater treatment sludges from the production of vinyl chloride monomer using mercuric chloride catalyst in an acetylene-based process.	(T)
K181	Nonwastewaters from the production of dyes and/or pigments (including nonwastewaters commingled at the point of generation with nonwastewaters from other processes) that, at the point of generation, contain mass loadings of any of the constituents identified in paragraph (c) of this section that are equal to or greater than the corresponding paragraph (c) levels, as determined on a calendar year basis. These wastes will not be hazardous if the nonwastewaters are: (i) disposed in a Subtitle D landfill unit subject to the design criteria in § 258.40, (ii) disposed in a Subtitle C landfill unit subject to either § 264.301 or § 265.301, (iii) disposed in other Subtitle D landfill units that meet the design criteria in § 258.40, § 264.301, or § 265.301, or (iv) treated in a combustion unit that is permitted under Subtitle C, or an onsite combustion unit that is permitted under the Clean Air Act. For the purposes of this listing, dyes and/or pigments production is defined in paragraph (b)(1) of this section. Paragraph (d) of this section describes the process for demonstrating that a facility's nonwastewaters are not K181. This listing does not apply to wastes that are otherwise identified as hazardous under §§ 261.21–261.24 and 261.31–261.33 at the point of generation. Also, the listing does not apply to wastes generated before any annual mass loading limit is met.	(T)
Inorganic chemicals:		
K071	Brine purification muds from the mercury cell process in chlorine production, where separately prepurified brine is not used.	(T)
K073	Chlorinated hydrocarbon waste from the purification step of the diaphragm cell process using graphite anodes in chlorine production.	(T)
K106	Wastewater treatment sludge from the mercury cell process in chlorine production	(T)
K176	Baghouse filters from the production of antimony oxide, including filters from the production of intermediates (e.g., antimony metal or crude antimony oxide).	(E)
K177	Slag from the production of antimony oxide that is speculatively accumulated or disposed, including slag from the production of intermediates (e.g., antimony metal or crude antimony oxide).	(T)
K178	Residues from manufacturing and manufacturing-site storage of ferric chloride from acids formed during the production of titanium dioxide using the chloride-ilmenite process.	(T)
Pesticides:		
K031	By-product salts generated in the production of MSMA and cacodylic acid	(T)
K032	Wastewater treatment sludge from the production of chlordane	(T)
K033	Wastewater and scrub water from the chlorination of cyclopentadiene in the production of chlordane.	(T)
K034	Filter solids from the filtration of hexachlorocyclopentadiene in the production of chlordane.	(T)
K035	Wastewater treatment sludges generated in the production of creosote	(T)
K036	Still bottoms from toluene reclamation distillation in the production of disulfoton	(T)
K037	Wastewater treatment sludges from the production of disulfoton	(T)
K038	Wastewater from the washing and stripping of phorate production	(T)
K039	Filter cake from the filtration of diethylphosphorodithioic acid in the production of phorate.	(T)
K040	Wastewater treatment sludge from the production of phorate	(T)
K041	Wastewater treatment sludge from the production of toxaphene	(T)
K042	Heavy ends or distillation residues from the distillation of tetrachlorobenzene in the production of 2,4,5-T.	(T)
K043	2,6-Dichlorophenol waste from the production of 2,4-D	(T)
K097	Vacuum stripper discharge from the chlordane chlorinator in the production of chlordane.	(T)
K098	Untreated process wastewater from the production of toxaphene	(T)
K099	Untreated wastewater from the production of 2,4-D	(T)
K123	Process wastewater (including supernates, filtrates, and washwaters) from the production of ethylenedisithiocarbamic acid and its salt.	(T)

Industry and EPA hazardous waste No.	Hazardous waste	Hazard code
K124	Reactor vent scrubber water from the production of ethylenebisdithiocarbamic acid and its salts.	(C, T)
K125	Filtration, evaporation, and centrifugation solids from the production of ethylenebisdithiocarbamic acid and its salts.	(T)
K126	Baghouse dust and floor sweepings in milling and packaging operations from the production or formulation of ethylenebisdithiocarbamic acid and its salts.	(T)
K131	Wastewater from the reactor and spent sulfuric acid from the acid dryer from the production of methyl bromide.	(C, T)
K132	Spent absorbent and wastewater separator solids from the production of methyl bromide.	(T)
Explosives:		
K044	Wastewater treatment sludges from the manufacturing and processing of explosives	(R)
K045	Spent carbon from the treatment of wastewater containing explosives	(R)
K046	Wastewater treatment sludges from the manufacturing, formulation and loading of lead-based initiating compounds.	(T)
K047	Pink/red water from TNT operations	(R)
Petroleum refining:		
K048	Dissolved air flotation (DAF) float from the petroleum refining industry	(T)
K049	Slop oil emulsion solids from the petroleum refining industry	(T)
K050	Heat exchanger bundle cleaning sludge from the petroleum refining industry	(T)
K051	API separator sludge from the petroleum refining industry	(T)
K052	Tank bottoms (leaded) from the petroleum refining industry	(T)
K169	Crude oil storage tank sediment from petroleum refining operations	(T)
K170	Clarified slurry oil tank sediment and/or in-line filter/separation solids from petroleum refining operations.	(T)
K171	Spent Hydrotreating catalyst from petroleum refining operations, including guard beds used to desulfurize feeds to other catalytic reactors (this listing does not include inert support media).	(I,T)
K172	Spent Hydrorefining catalyst from petroleum refining operations, including guard beds used to desulfurize feeds to other catalytic reactors (this listing does not include inert support media).	(I,T)
Iron and steel:		
K061	Emission control dust/sludge from the primary production of steel in electric furnaces	(T)
K062	Spent pickle liquor generated by steel finishing operations of facilities within the iron and steel industry (SIC Codes 331 and 332).	(C,T)
Primary aluminum:		
K088	Spent potliners from primary aluminum reduction	(T)
Secondary lead:		
K069	Emission control dust/sludge from secondary lead smelting. (NOTE: This listing is stayed administratively for sludge generated from secondary acid scrubber systems. The stay will remain in effect until further administrative action is taken. If EPA takes further action effecting this stay, EPA will publish a notice of the action in the FEDERAL REGISTER).	(T)
K100	Waste leaching solution from acid leaching of emission control dust/sludge from secondary lead smelting.	(T)
Veterinary pharmaceuticals:		
K084	Wastewater treatment sludges generated during the production of veterinary pharmaceuticals from arsenic or organo-arsenic compounds.	(T)
K101	Distillation tar residues from the distillation of aniline-based compounds in the production of veterinary pharmaceuticals from arsenic or organo-arsenic compounds.	(T)
K102	Residue from the use of activated carbon for decolorization in the production of veterinary pharmaceuticals from arsenic or organo-arsenic compounds.	(T)
Ink formulation:		
K086	Solvent washes and sludges, caustic washes and sludges, or water washes and sludges from cleaning tubs and equipment used in the formulation of ink from pigments, driers, soaps, and stabilizers containing chromium and lead.	(T)
Coking:		
K060	Ammonia still lime sludge from coking operations	(T)
K087	Decanter tank tar sludge from coking operations	(T)
K141	Process residues from the recovery of coal tar, including, but not limited to, collecting sump residues from the production of coke from coal or the recovery of coke by-products produced from coal. This listing does not include K087 (decanter tank tar sludges from coking operations).	(T)
K142	Tar storage tank residues from the production of coke from coal or from the recovery of coke by-products produced from coal.	(T)
K143	Process residues from the recovery of light oil, including, but not limited to, those generated in stills, decanters, and wash oil recovery units from the recovery of coke by-products produced from coal.	(T)
K144	Wastewater sump residues from light oil refining, including, but not limited to, intercepting or contamination sump sludges from the recovery of coke by-products produced from coal.	(T)
K145	Residues from naphthalene collection and recovery operations from the recovery of coke by-products produced from coal.	(T)

Environmental Protection Agency

§ 261.32

Industry and EPA hazardous waste No.	Hazardous waste	Hazard code
K147	Tar storage tank residues from coal tar refining	(T)
K148	Residues from coal tar distillation, including but not limited to, still bottoms	(T)

(b) *Listing Specific Definitions:* (1) For the purposes of the K181 listing, dyes and/or pigments production is defined to include manufacture of the following product classes: dyes, pigments, or FDA certified colors that are classified as azo, triarylmethane, perylene or anthraquinone classes. Azo products include azo, monoazo, diazo, triazo, polyazo, azoic, benzidine, and pyrazolone products. Triarylmethane products include both triarylmethane and triphenylmethane products. Wastes that are not generated at a dyes and/or pigments manufacturing site, such as wastes from the offsite use, formulation, and packaging of dyes and/or pigments, are not included in the K181 listing.

(c) *K181 Listing Levels.* Nonwastewaters containing constituents in amounts equal to or exceeding the following levels during any calendar year are subject to the K181 listing, unless the conditions in the K181 listing are met.

Constituent	Chemical abstracts No.	Mass levels (kg/yr)
Aniline	62-53-3	9,300
o-Anisidine	90-04-0	110
4-Chloroaniline	106-47-8	4,800
p-Cresidine	120-71-8	660
2,4-Dimethylaniline	95-68-1	100
1,2-Phenylenediamine	95-54-5	710
1,3-Phenylenediamine	108-45-2	1,200

(d) *Procedures for demonstrating that dyes and/or pigment nonwastewaters are not K181.* The procedures described in paragraphs (d)(1)–(d)(3) and (d)(5) of this section establish when nonwastewaters from the production of dyes/pigments would not be hazardous (these procedures apply to wastes that are not disposed in landfill units or treated in combustion units as specified in paragraph (a) of this section). If the nonwastewaters are disposed in landfill units or treated in combustion units as described in paragraph (a) of this section, then the nonwastewaters are not hazardous. In order to demonstrate that it is meeting the landfill

disposal or combustion conditions contained in the K181 listing description, the generator must maintain documentation as described in paragraph (d)(4) of this section.

(1) *Determination based on no K181 constituents.* Generators that have knowledge (e.g., knowledge of constituents in wastes based on prior sampling and analysis data and/or information about raw materials used, production processes used, and reaction and degradation products formed) that their wastes contain none of the K181 constituents (see paragraph (c) of this section) can use their knowledge to determine that their waste is not K181. The generator must document the basis for all such determinations on an annual basis and keep each annual documentation for three years.

(2) *Determination for generated quantities of 1,000 MT/yr or less for wastes that contain K181 constituents.* If the total annual quantity of dyes and/or pigment nonwastewaters generated is 1,000 metric tons or less, the generator can use knowledge of the wastes (e.g., knowledge of constituents in wastes based on prior analytical data and/or information about raw materials used, production processes used, and reaction and degradation products formed) to conclude that annual mass loadings for the K181 constituents are below the listing levels of paragraph (c) of this section. To make this determination, the generator must:

(i) Each year document the basis for determining that the annual quantity of nonwastewaters expected to be generated will be less than 1,000 metric tons.

(ii) Track the actual quantity of nonwastewaters generated from January 1 through December 31 of each year. If, at any time within the year, the actual waste quantity exceeds 1,000 metric tons, the generator must comply with the requirements of paragraph (d)(3) of this section for the remainder of the year.

(iii) Keep a running total of the K181 constituent mass loadings over the course of the calendar year.

(iv) Keep the following records on site for the three most recent calendar years in which the hazardous waste determinations are made:

(A) The quantity of dyes and/or pigment nonwastewaters generated.

(B) The relevant process information used.

(C) The calculations performed to determine annual total mass loadings for each K181 constituent in the nonwastewaters during the year.

(3) *Determination for generated quantities greater than 1,000 MT/yr for wastes that contain K181 constituents.* If the total annual quantity of dyes and/or pigment nonwastewaters generated is greater than 1,000 metric tons, the generator must perform all of the steps described in paragraphs ((d)(3)(i)–(d)(3)(xi) of this section) in order to make a determination that its waste is not K181.

(i) Determine which K181 constituents (see paragraph (c) of this section) are reasonably expected to be present in the wastes based on knowledge of the wastes (e.g., based on prior sampling and analysis data and/or information about raw materials used, production processes used, and reaction and degradation products formed).

(ii) If 1,2-phenylenediamine is present in the wastes, the generator can use either knowledge or sampling and analysis procedures to determine the level of this constituent in the wastes. For determinations based on use of knowledge, the generator must comply with the procedures for using knowledge described in paragraph (d)(2) of this section and keep the records described in paragraph (d)(2)(iv) of this section. For determinations based on sampling and analysis, the generator must comply with the sampling and analysis and recordkeeping requirements described below in this section.

(iii) Develop a waste sampling and analysis plan (or modify an existing plan) to collect and analyze representative waste samples for the K181 constituents reasonably expected to be present in the wastes. At a minimum, the plan must include:

(A) A discussion of the number of samples needed to characterize the wastes fully;

(B) The planned sample collection method to obtain representative waste samples;

(C) A discussion of how the sampling plan accounts for potential temporal and spatial variability of the wastes.

(D) A detailed description of the test methods to be used, including sample preparation, clean up (if necessary), and determinative methods.

(iv) Collect and analyze samples in accordance with the waste sampling and analysis plan.

(A) The sampling and analysis must be unbiased, precise, and representative of the wastes.

(B) The analytical measurements must be sufficiently sensitive, accurate and precise to support any claim that the constituent mass loadings are below the listing levels of paragraph (c) of this section.

(v) Record the analytical results.

(vi) Record the waste quantity represented by the sampling and analysis results.

(vii) Calculate constituent-specific mass loadings (product of concentrations and waste quantity).

(viii) Keep a running total of the K181 constituent mass loadings over the course of the calendar year.

(ix) Determine whether the mass of any of the K181 constituents listed in paragraph (c) of this section generated between January 1 and December 31 of any year is below the K181 listing levels.

(x) Keep the following records on site for the three most recent calendar years in which the hazardous waste determinations are made:

(A) The sampling and analysis plan.

(B) The sampling and analysis results (including QA/QC data)

(C) The quantity of dyes and/or pigment nonwastewaters generated.

(D) The calculations performed to determine annual mass loadings.

(xi) Nonhazardous waste determinations must be conducted annually to verify that the wastes remain nonhazardous.

(A) The annual testing requirements are suspended after three consecutive successful annual demonstrations that

Environmental Protection Agency

§ 261.33

the wastes are nonhazardous. The generator can then use knowledge of the wastes to support subsequent annual determinations.

(B) The annual testing requirements are reinstated if the manufacturing or waste treatment processes generating the wastes are significantly altered, resulting in an increase of the potential for the wastes to exceed the listing levels.

(C) If the annual testing requirements are suspended, the generator must keep records of the process knowledge information used to support a nonhazardous determination. If testing is reinstated, a description of the process change must be retained.

(4) *Recordkeeping for the landfill disposal and combustion exemptions.* For the purposes of meeting the landfill disposal and combustion condition set out in the K181 listing description, the generator must maintain on site for three years documentation demonstrating that each shipment of waste was received by a landfill unit that is subject to or meets the landfill design standards set out in the listing description, or was treated in combustion units as specified in the listing description.

(5) *Waste holding and handling.* During the interim period, from the point of generation to completion of the hazardous waste determination, the generator is responsible for storing the wastes appropriately. If the wastes are determined to be hazardous and the generator has not complied with the subtitle C requirements during the interim period, the generator could be subject to an enforcement action for improper management.

[46 FR 4618, Jan. 16, 1981]

EDITORIAL NOTE: For FEDERAL REGISTER citations affecting § 261.32, see the List of CFR Sections Affected, which appears in the Finding Aids section of the printed volume and at www.fdsys.gov.

§ 261.33 Discarded commercial chemical products, off-specification species, container residues, and spill residues thereof.

The following materials or items are hazardous wastes if and when they are discarded or intended to be discarded as described in § 261.2(a)(2)(i), when

they are mixed with waste oil or used oil or other material and applied to the land for dust suppression or road treatment, when they are otherwise applied to the land in lieu of their original intended use or when they are contained in products that are applied to the land in lieu of their original intended use, or when, in lieu of their original intended use, they are produced for use as (or as a component of) a fuel, distributed for use as a fuel, or burned as a fuel.

(a) Any commercial chemical product, or manufacturing chemical intermediate having the generic name listed in paragraph (e) or (f) of this section.

(b) Any off-specification commercial chemical product or manufacturing chemical intermediate which, if it met specifications, would have the generic name listed in paragraph (e) or (f) of this section.

(c) Any residue remaining in a container or in an inner liner removed from a container that has held any commercial chemical product or manufacturing chemical intermediate having the generic name listed in paragraphs (e) or (f) of this section, unless the container is empty as defined in § 261.7(b) of this chapter.

[*Comment:* Unless the residue is being beneficially used or reused, or legitimately recycled or reclaimed; or being accumulated, stored, transported or treated prior to such use, re-use, recycling or reclamation, EPA considers the residue to be intended for discard, and thus, a hazardous waste. An example of a legitimate re-use of the residue would be where the residue remains in the container and the container is used to hold the same commercial chemical product or manufacturing chemical intermediate it previously held. An example of the discard of the residue would be where the drum is sent to a drum reconditioner who reconditions the drum but discards the residue.]

(d) Any residue or contaminated soil, water or other debris resulting from the cleanup of a spill into or on any land or water of any commercial chemical product or manufacturing chemical intermediate having the generic name listed in paragraph (e) or (f) of this section, or any residue or contaminated soil, water or other debris resulting from the cleanup of a spill, into or on any land or water, of any off-specification chemical product and manufacturing chemical intermediate

Attachment B
Analytical Data Tables
(Northern Impoundment Pre-Design Investigations)

**First Phase Pre-Design Investigation Waste Characterization Results
San Jacinto River Waste Pits Site
Harris County, Texas**

Parameters	Area: Sample Location: Sample Identification: Sample Date:			Northern Impoundment - East SJSB038 SL0594 12/18/2018	Northern Impoundment - West SJSB037 SL0547 11/15/18	Northern Impoundment - West SJSB036 SL0554 11/16/18
	Units	TCLP Regulatory Levels ¹	Method Detection Limits ²	-	-	-
TCLP-Volatile Organic Compounds (VOCs)						
1,1-Dichloroethene	mg/L	0.7	0.00008	0.20 U	0.032 U	0.032 U
1,2-Dichloroethane	mg/L	0.5	0.00008	0.20 U	0.032 U	0.032 U
1,4-Dichlorobenzene	mg/L	7.5	0.00032	0.20 U	0.048 U	0.048 U
2-Butanone (Methyl ethyl ketone) (MEK)	mg/L	200.0	0.0019	8.0 U	0.76 U	0.76 U
Benzene	mg/L	0.5	0.000062	0.20 U	0.025 U	0.025 U
Carbon tetrachloride	mg/L	0.5	0.000096	0.20 U	0.039 U	0.039 U
Chlorobenzene	mg/L	100.0	0.00011	0.20 U	0.044 U	0.044 U
Chloroform (Trichloromethane)	mg/L	6.0	0.000072	0.20 U	0.029 U	0.029 U
Tetrachloroethene	mg/L	0.7	0.000099	0.20 U	0.040 U	0.040 U
Trichloroethene	mg/L	0.5	0.0001	0.20 U	0.040 U	0.040 U
Vinyl chloride	mg/L	0.2	0.000075	0.080 U	0.030 U	0.030 U
TCLP-Semi-Volatile Organic Compounds (SVOCs)						
2,4,5-Trichlorophenol	mg/L	400.0	0.000018	0.10 U	0.013 U	0.013 U
2,4,6-Trichlorophenol	mg/L	2.0	0.000014	0.10 U	0.011 U	0.0099 U
2,4-Dinitrotoluene	mg/L	0.13	0.00027	0.10 U	0.020 U	0.019 U
2-Methylphenol	mg/L	200.0	0.00033	0.10 U	0.013 U	0.013 U
4-Methylphenol	mg/L	200.0	0.00048	0.10 U	0.0070 U	0.0067 U
Hexachlorobenzene	mg/L	0.13	0.00063	0.10 U	0.014 U	0.014 U
Hexachlorobutadiene	mg/L	0.5	0.00029	0.10 U	0.0095 U	0.0091 U
Hexachloroethane	mg/L	3.0	0.00029	0.10 U	0.0071 U	0.0068 U
Nitrobenzene	mg/L	2.0	0.00057	0.10 U	0.012 U	0.012 U
Pentachlorophenol	mg/L	100.0	0.0024	0.25 U	0.016 U	0.016 U
Pyridine	mg/L	5.0	0.0075	0.50 U	0.38 U	0.36 U
TCLP-Pesticides						
Chlordane	mg/L	0.03	0.0001	0.0010 U	0.0010 U	0.0010 U
Endrin	mg/L	0.02	0.00000069	0.00010 U	0.00010 U	0.00010 U
gamma-BHC (lindane)	mg/L	0.3	0.00000036	0.00010 U	0.00010 U	0.00010 U
Heptachlor	mg/L	0.008	0.00000068	0.00010 U	0.00010 U	0.00010 U
Heptachlor epoxide	mg/L	0.04	0.00000084	0.00010 U	0.00010 U	0.00010 U
Methoxychlor	mg/L	10.0	0.0000001	0.00010 U	0.00010 U	0.00010 U
Toxaphene	mg/L	0.5	0.0002	0.0020 U	0.0020 U	0.0020 U
TCLP-Metals						
Arsenic	mg/L	5.0	0.005	0.020 U	0.021 J	0.020 U
Barium	mg/L	100.0	0.0006	0.9 J	1.6	1.4
Cadmium	mg/L	1.0	0.0005	0.050 U	0.002 J	0.001 J
Chromium	mg/L	5.0	0.0009	0.050 U	0.010 U	0.010 U
Lead	mg/L	5.0	0.005	0.050 U	0.015 U	0.015 U
Mercury	mg/L	0.2	0.00002	0.0010 U	0.0001 U	0.0001 U
Selenium	mg/L	1.0	0.009	0.10 U	0.02 U	0.02 J
Silver	mg/L	5.0	0.002	0.050 U	0.004 U	0.004 U
TCLP-Herbicides						
2,4,5-TP (Silvex)	mg/L	1.0	0.000036	0.020 U	0.030 U	0.029 U
2,4-Dichlorophenoxyacetic acid (2,4-D)	mg/L	10.0	0.000045	0.100 U	0.150 U	0.150 U
General Chemistry						
Flash point (closed cup)	°C	> 60	NA	> 110	> 110	> 110
Percent solids	%	NA	NA	45.9 J	67.1 J	70.0 J
pH, lab	s.u.	>2 or <12	NA	7.84	8.09 J	8.54 J
Reactive cyanide	mg/kg	NA	17.4	17 U	100 U	100 U
Reactive sulfide	mg/kg	NA	0.2	70 U	48 U	46 U
Sulfur	mg/kg	NA	0.46	---	---	---
Total Petroleum Hydrocarbons (TPH)						
Gasoline Range Organics (GRO)	mg/kg	>1500 ³	0.62	---	---	---
Diesel Range Organics (DRO)	mg/kg	>1500 ³	0.79	---	---	---
Residual Range Organics (RRO)	mg/kg	>1500 ³	2.9	---	---	---
Polychlorinated Biphenyls (PCBs)						
Aroclor 1016	mg/kg	NA	2.1	---	---	---
Aroclor 1221	mg/kg	NA	2.1	---	---	---
Aroclor 1232	mg/kg	NA	2.1	---	---	---
Aroclor 1242	mg/kg	NA	2.1	---	---	---
Aroclor 1248	mg/kg	NA	2.1	---	---	---
Aroclor 1254	mg/kg	NA	2.1	---	---	---
Aroclor 1260	mg/kg	NA	2.1	---	---	---
Aroclor 1262	mg/kg	NA	2.1	---	---	---
Aroclor 1268	mg/kg	NA	2.1	---	---	---

Notes:

TCLP - Toxicity Characteristic Leaching Procedure

mg/L - milligrams per Liter

ug/L - microgram per Liter

mg/kg - milligram per kilogram

Deg C - Degrees in Celsius

TCLP - Toxicity Characteristic Leaching Procedure

NA - Not Applicable

s.u. - standard unit

U - Not detected at the associated reporting limit.

J - Estimated concentration.

UJ - Not detected; associated reporting limit is estimated.

--- - Not analyzed

¹ - TCLP Regulatory Levels from the *Guidelines for the Classification and Coding of Industrial and Hazardous Wastes*, November 2014, and Table 1 - Maximum Concentrations.

² - Method Detection Limits were taken from *Table 9 Analyte, Method Reporting Limits, and Method Detection Limits for Waste Characterization Samples* from the First Phase Pre-Design Investigation Report.

³ - TPH Regulatory Standard is a Total value, not a TCLP.

Table 2

**Second Phase Pre-Design Investigation Composite Sample Results
San Jacinto River Waste Pits Site
Harris County, Texas**

Area: Sample Location: Sample Identification: Sample Date: Report Sample Delivery Group (SDG):	Units	Initial Sample - Southwest Initial 11187072-NORTH-IMPCT-INITIALS 10/15/2019 180-97287-1, 180-97287-2	Composite Sample 2 - Northwest Area 2 11187072-N.TREATMENT AREA #2 12/18/2019 180-100205-1	Composite Sample 3 - Northeast Area 3 11187072-N.TREATMENT AREA #3 12/18/2019 180-100205-1	Composite Sample 4 - Southeast Area 4 11187072-N.TREATMENT AREA #4 12/18/2019 180-100205-1
General Chemistry					
Cyanide (total)	mg/kg	0.43 U	0.37 U	0.40 U	0.40 U
Free liquid	none	U	U	U	U
Ignitability	Deg F	> 140	> 140	> 140	> 140
Percent solids	%	--	71.4	67.4	66.7
pH, lab	s.u.	7.9 J	8.5 J	8.7 J	7.9 J
Sulfide	mg/kg	76 J	72	59	24 J
TCLP-Dioxins/Furans					
1,2,3,4,6,7,8,9-Octachlorodibenzofuran (OCDF)	pg/L	7.6 U	95 J	19 U	16 U
1,2,3,4,6,7,8,9-Octachlorodibenzo-p-dioxin (OCDD)	pg/L	34 U	77 J	11 U	9.9 U
1,2,3,4,6,7,8-Heptachlorodibenzofuran (HpCDF)	pg/L	5.3 U	9.0 U	8.5 U	8.3 U
1,2,3,4,6,7,8-Heptachlorodibenzo-p-dioxin (HpCDD)	pg/L	3.4 U	23 J	7.5 U	5.9 U
1,2,3,4,7,8,9-Heptachlorodibenzofuran (HpCDF)	pg/L	6.2 U	31 J	12 U	11 U
1,2,3,4,7,8-Hexachlorodibenzofuran (HxCDF)	pg/L	2.9 U	15 U	12 U	10 U
1,2,3,4,7,8-Hexachlorodibenzo-p-dioxin (HxCDD)	pg/L	4.5 U	20 J	8.7 U	6.9 U
1,2,3,6,7,8-Hexachlorodibenzofuran (HxCDF)	pg/L	3.1 U	13 U	11 U	11 U
1,2,3,6,7,8-Hexachlorodibenzo-p-dioxin (HxCDD)	pg/L	4.7 U	7.9 U	9.2 U	7.5 U
1,2,3,7,8,9-Hexachlorodibenzofuran (HxCDF)	pg/L	2.2 U	15 J	7.3 U	7.1 U
1,2,3,7,8,9-Hexachlorodibenzo-p-dioxin (HxCDD)	pg/L	4.3 U	6.7 U	7.9 U	6.3 U
1,2,3,7,8-Pentachlorodibenzofuran (PeCDF)	pg/L	4.6 U	10 U	8.4 U	8.3 U
1,2,3,7,8-Pentachlorodibenzo-p-dioxin (PeCDD)	pg/L	8.4 U	19 U	20 U	16 U
2,3,4,6,7,8-Hexachlorodibenzofuran (HxCDF)	pg/L	2.5 U	9.2 U	7.5 U	6.8 U
2,3,4,7,8-Pentachlorodibenzofuran (PeCDF)	pg/L	4.6 U	11 U	9.2 U	9.4 U
2,3,7,8-Tetrachlorodibenzofuran (TCDF)	pg/L	2.8 U	11 J	6.5 U	6.6 U
2,3,7,8-Tetrachlorodibenzo-p-dioxin (TCDD)	pg/L	3.4 U	12 U	12 U	12 U
Total heptachlorodibenzofuran (HpCDF)	pg/L	6.2 U	31 J	12 U	11 U
Total heptachlorodibenzo-p-dioxin (HpCDD)	pg/L	10 U	23 J	7.5 U	5.9 U
Total hexachlorodibenzofuran (HxCDF)	pg/L	3.1 U	15 J	12 U	11 U
Total hexachlorodibenzo-p-dioxin (HxCDD)	pg/L	4.7 U	20 J	9.2 U	7.5 U
Total pentachlorodibenzofuran (PeCDF)	pg/L	4.6 U	11 U	9.2 U	9.4 U
Total pentachlorodibenzo-p-dioxin (PeCDD)	pg/L	8.4 U	19 U	20 U	16 U
Total tetrachlorodibenzofuran (TCDF)	pg/L	2.8 U	11 J	6.5 U	6.6 U
Total tetrachlorodibenzo-p-dioxin (TCDD)	pg/L	4.4 J	12 U	12 U	12 U
TCLP-Glycol					
2-Ethoxyethanol	mg/L	2.5 U	2.5 U	2.5 U	2.5 U
Ethylene glycol	mg/L	1.9 U	1.9 U	1.9 U	1.9 U
Ethylene glycol monomethyl ether (2-methoxyethanol)	mg/L	2.4 U	2.4 U	2.4 U	2.4 U
TCLP-Herbicides					
2,4,5-TP (Silvex)	mg/L	0.0030 U	0.0030 U	0.0030 U	0.0030 U
2,4-Dichlorophenoxyacetic acid (2,4-D)	mg/L	0.020 U	0.020 U	0.020 U	0.020 U
Dinoseb	mg/L	0.038 U	0.038 U	0.038 U	0.038 U
TCLP-Metals					
Arsenic	mg/L	0.041 U	0.041 U	0.041 U	0.041 U
Barium	mg/L	1.1 J	0.53 J	0.44 J	0.48 J
Cadmium	mg/L	0.0028 U	0.0028 U	0.0028 U	0.0028 U
Chromium	mg/L	0.0078 U	0.0078 U	0.011 J	0.0078 U
Lead	mg/L	0.029 U	0.029 U	0.029 U	0.029 U
Mercury	mg/L	0.00010 U	0.00010 U	0.00010 U	0.00010 U
Selenium	mg/L	0.036 U	0.036 U	0.036 U	0.036 U
Silver	mg/L	0.0085 U	0.0085 U	0.0085 U	0.0085 U

**Second Phase Pre-Design Investigation Composite Sample Results
San Jacinto River Waste Pits Site
Harris County, Texas**

Area: Sample Location: Sample Identification: Sample Date: Report Sample Delivery Group (SDG):	Units	Initial Sample - Southwest Initial 11187072-NORTH-IMPCT-INITIALS 10/15/2019 180-97287-1, 180-97287-2	Composite Sample 2 - Northwest Area 2 11187072-N.TREATMENT AREA #2 12/18/2019 180-100205-1	Composite Sample 3 - Northeast Area 3 11187072-N.TREATMENT AREA #3 12/18/2019 180-100205-1	Composite Sample 4 - Southeast Area 4 11187072-N.TREATMENT AREA #4 12/18/2019 180-100205-1
Misc					
Methomyl	ug/L	0.12 U	0.13 U	0.12 U	0.13 U
TCLP-PCBs					
Aroclor-1016 (PCB-1016)	mg/L	0.00018 U	0.00019 U	0.00019 U	0.00019 U
Aroclor-1221 (PCB-1221)	mg/L	0.00022 U	0.00022 U	0.00023 U	0.00023 U
Aroclor-1232 (PCB-1232)	mg/L	0.00020 U	0.00020 U	0.00021 U	0.00021 U
Aroclor-1242 (PCB-1242)	mg/L	0.00035 U	0.00036 U	0.00036 U	0.00036 U
Aroclor-1248 (PCB-1248)	mg/L	0.00012 U	0.00012 U	0.00012 U	0.00012 U
Aroclor-1254 (PCB-1254)	mg/L	0.00037 U	0.00037 U	0.00038 U	0.00038 U
Aroclor-1260 (PCB-1260)	mg/L	0.00015 U	0.00015 U	0.00016 U	0.00016 U
TCLP-Pesticides					
4,4'-DDD	mg/L	0.00021 U	0.00021 U	0.00021 U	0.00021 U
4,4'-DDE	mg/L	0.00012 U	0.00012 U	0.00012 U	0.00012 U
4,4'-DDT	mg/L	0.00012 U	0.00012 U	0.00012 U	0.00012 U
alpha-Chlordane	mg/L	--	0.00015 U	0.00015 U	0.00015 U
Chlordane	mg/L	0.0029 U	0.0029 U	0.0029 U	0.0029 U
Dieldrin	mg/L	0.00011 U	0.00011 U	0.00011 U	0.00011 U
Endosulfan I	mg/L	0.00027 U	0.00027 U	0.00027 U	0.00027 U
Endosulfan II	mg/L	0.00013 U	0.00013 U	0.00013 U	0.00013 U
Endosulfan sulfate	mg/L	0.00026 U	0.00026 U	0.00026 U	0.00026 U
Endrin	mg/L	0.000091 U	0.000091 U	0.000091 U	0.000091 U
gamma-BHC (lindane)	mg/L	0.00012 U	0.00012 U	0.00012 U	0.00012 U
gamma-Chlordane	mg/L	--	0.00016 U	0.00016 U	0.00016 U
Heptachlor	mg/L	0.00018 U	0.00018 U	0.00018 U	0.00018 U
Heptachlor epoxide	mg/L	0.00014 U	0.00014 U	0.00014 U	0.00014 U
Methoxychlor	mg/L	0.00031 U	0.00031 U	0.00031 U	0.00031 U
Mirex	mg/L	0.000084 U	0.000084 U	0.000084 U	0.000084 U
Toxaphene	mg/L	0.020 U	0.020 U	0.020 U	0.020 U
TCLP-Semi-Volatile Organic Compounds (SVOCs)					
1,4-Dichlorobenzene	mg/L	0.0045 U	0.0045 U	0.0045 U	0.0045 U
2,4,5-Trichlorophenol	mg/L	0.0079 U	0.0079 U	0.0079 U	0.0079 U
2,4,6-Trichlorophenol	mg/L	0.0095 U	0.0095 U	0.0095 U	0.0095 U
2,4-Dinitrotoluene	mg/L	0.0079 U	0.0079 U	0.0079 U	0.0079 U
2-Methylphenol	mg/L	0.0040 U	0.0040 U	0.0040 U	0.0040 U
3&4-Methylphenol	mg/L	0.0079 U	0.0079 U	0.0079 U	0.0079 U
Hexachlorobenzene	mg/L	0.0055 U	0.0055 U	0.0055 U	0.0055 U
Hexachlorobutadiene	mg/L	0.0084 U	0.0084 U	0.0084 U	0.0084 U
Hexachloroethane	mg/L	0.0040 U	0.0040 U	0.0040 U	0.0040 U
Nitrobenzene	mg/L	0.012 U	0.012 U	0.012 U	0.012 U
Pentachlorophenol	mg/L	0.0075 U	0.0075 U	0.0075 U	0.0075 U
Pyridine	mg/L	0.0082 U	0.0082 U	0.0082 U	0.0082 U

**Second Phase Pre-Design Investigation Composite Sample Results
San Jacinto River Waste Pits Site
Harris County, Texas**

Area: Sample Location: Sample Identification: Sample Date: Report Sample Delivery Group (SDG):	Units	Initial Sample - Southwest Initial 11187072-NORTH-IMPCT-INITIALS 10/15/2019 180-97287-1, 180-97287-2	Composite Sample 2 - Northwest Area 2 11187072-N.TREATMENT AREA #2 12/18/2019 180-100205-1	Composite Sample 3 - Northeast Area 3 11187072-N.TREATMENT AREA #3 12/18/2019 180-100205-1	Composite Sample 4 - Southeast Area 4 11187072-N.TREATMENT AREA #4 12/18/2019 180-100205-1
TCLP-Volatile Organic Compounds (VOCs)					
1,1,1,2-Tetrachloroethane	mg/L	0.16 U	0.16 U	0.16 U	0.16 U
1,1,1-Trichloroethane	mg/L	0.10 U	0.10 U	0.10 U	0.10 U
1,1,2,2-Tetrachloroethane	mg/L	0.12 U	0.12 U	0.12 U	0.12 U
1,1,2-Trichloroethane	mg/L	0.096 U	0.096 U	0.096 U	0.096 U
1,1-Dichloroethene	mg/L	0.11 U	0.11 U	0.11 U	0.11 U
1,2,3-Trichloropropane	mg/L	0.11 U	0.11 U	0.11 U	0.11 U
1,2-Dibromoethane (Ethylene dibromide)	mg/L	0.11 U	0.11 U	0.11 U	0.11 U
1,2-Dichloroethane	mg/L	0.058 U	0.058 U	0.058 U	0.058 U
1,3-Dichloropropene	mg/L	0.13 U	0.13 U	0.13 U	0.13 U
1,4-Dichlorobenzene	mg/L	0.041 U	0.041 U	0.041 U	0.041 U
2-Butanone (Methyl ethyl ketone) (MEK)	mg/L	0.12 U	0.12 U	0.12 U	0.12 U
4-Methyl-2-pentanone (Methyl isobutyl ketone) (MIBK)	mg/L	0.074 U	0.074 U	0.074 U	0.074 U
Acetone	mg/L	0.13 U	0.13 U	0.13 U	0.13 U
Acetonitrile	mg/L	2.0 U	2.0 U	2.0 U	2.0 U
Acrylonitrile	mg/L	1.3 U	1.3 U	1.3 U	1.3 U
Benzene	mg/L	0.079 U	0.079 U	0.079 U	0.079 U
Bromodichloromethane	mg/L	0.094 U	0.094 U	0.094 U	0.094 U
Bromoform	mg/L	0.10 U	0.10 U	0.10 U	0.10 U
Bromomethane (Methyl bromide)	mg/L	0.18 U	0.18 U	0.18 U	0.18 U
Carbon disulfide	mg/L	0.12 U	0.12 U	0.12 U	0.12 U
Carbon tetrachloride	mg/L	0.13 U	0.13 U	0.13 U	0.13 U
Chlorobenzene	mg/L	0.063 U	0.063 U	0.063 U	0.063 U
Chloroform (Trichloromethane)	mg/L	0.085 U	0.085 U	0.085 U	0.085 U
Dichlorodifluoromethane (CFC-12)	mg/L	0.12 U	0.12 U	0.12 U	0.12 U
Ethylbenzene	mg/L	0.086 U	0.086 U	0.086 U	0.086 U
Hexachlorobutadiene	mg/L	0.073 U	0.073 U	0.073 U	0.073 U
Isobutanol (isobutyl alcohol)	mg/L	3.6 U	3.6 U	3.6 U	3.6 U
Methyl acrylonitrile	mg/L	1.6 U	1.6 U	1.6 U	1.6 U
Methylene chloride	mg/L	0.15 U	0.15 U	0.15 U	0.15 U
Styrene	mg/L	0.053 U	0.053 U	0.053 U	0.053 U
Tetrachloroethene	mg/L	0.080 U	0.080 U	0.080 U	0.080 U
Toluene	mg/L	0.067 U	0.067 U	0.067 U	0.067 U
trans-1,3-Dichloropropene	mg/L	0.069 U	0.069 U	0.069 U	0.069 U
Trichloroethene	mg/L	0.060 U	0.060 U	0.060 U	0.060 U
Trichlorofluoromethane (CFC-11)	mg/L	0.058 U	0.058 U	0.058 U	0.058 U
Vinyl chloride	mg/L	0.15 U	0.15 U	0.15 U	0.15 U
Xylenes (total)	mg/L	0.17 U	0.17 U	0.17 U	0.17 U

Notes:

TCLP - Toxicity Characteristic Leaching Procedure
mg/L - milligrams per Liter
ug/L - microgram per Liter
mg/kg - milligram per kilogram
Deg F - Degrees in Fahrenheit
s.u. - standard unit
U - Not detected at the associated reporting limit.
J - Estimated concentration.

-- Data not available

Appendix D-3

Letter Correspondence from EPA to Respondents, Titled “Regarding San Jacinto River Waste Pits Superfund Site - Northern Impoundment Waste Characterization Evaluation,” Dated November 19, 2020



UNITED STATES ENVIRONMENTAL PROTECTION AGENCY
REGION 6
1201 ELM STREET, SUITE 500
DALLAS, TEXAS 75270

November 19, 2020

Charles W. Munce, P.E.
GHD Services Inc.
5551 Corporate Boulevard, Suite 200
Baton Rouge, Louisiana 70808

RE: San Jacinto River Waste Pits Superfund Site - Northern Impoundment
Waste Characterization Evaluation
EPA Region 6, CERCLA Docket No. 06-02-18 for Remedial Design

Dear Mr. Munce,

In response to a request from EPA, GHD submitted a waste characterization evaluation for the Northern Impoundment to EPA on October 20, 2020. The purpose of the evaluation was to describe how pulp and paper mill waste (Waste), proposed to be excavated as part of the Northern Impoundment remedial action (RA), has been characterized and classified in accordance with the Resource Conservation and Recovery Act (RCRA) regulations.

The following are EPA's findings based on the Agency's review of the October 20, 2020 waste characterization evaluation.

When dealing with hazardous waste characterization of remediation waste, it is vital to understand the initial source of the waste and the timeframe when the waste was initially applied to the ground. As outlined in the site history and in Sections 1 and 2 of the October 20, 2020 evaluation, the waste was initially generated in the mid-1960's and consisted solely of wastewater treatment sludge. In addition to this sludge containing cellulose wood pulp and clay binders, it contained various dioxins and furans which were formed as a by-product of the manufacturing process.

Based upon information provided in the October 20, 2020 evaluation, EPA agrees with GHD's determination that the initially generated waste would not be a listed hazardous waste meeting the current definitions for an F, K, P or U listed waste. Following the listed waste portion of the evaluation, EPA reviewed the description of the sampling and associated analytical test results. From review of the analytical testing results, the samples are all non-hazardous. Additional hazardous waste characterization may be warranted prior to final disposal. When performing this additional evaluation, the facility should follow the guidelines of SW846 chapter 9 with additional guidance being found in RCRA Waste Sampling Draft Technical Guidance.

Please contact me if you have any questions regarding the findings or wish to set up a call to discuss them. You may reach me at 214-665-6749.

Sincerely,

Gary A. Baumgarten
Project Manager

Encl.: Attachment 1 - SW846 Chapter 9
Attachment 2 - RCRA Waste Sampling Draft Technical Guidance

cc: Phil Slowiak, IPC
Brent Sasser, IPC
Judy Armour, MIMC
Katie Delbecq, Texas Commission on Environmental Quality

Attachment 1
SW846 Chapter 9

CHAPTER NINE

SAMPLING PLAN

9.1 DESIGN AND DEVELOPMENT

The initial -- and perhaps most critical -- element in a program designed to evaluate the physical and chemical properties of a solid waste is the plan for sampling the waste. It is understandable that analytical studies, with their sophisticated instrumentation and high cost, are often perceived as the dominant element in a waste characterization program. Yet, despite that sophistication and high cost, analytical data generated by a scientifically defective sampling plan have limited utility, particularly in the case of regulatory proceedings.

This section of the manual addresses the development and implementation of a scientifically credible sampling plan for a solid waste and the documentation of the chain of custody for such a plan. The information presented in this section is relevant to the sampling of any solid waste, which has been defined by the EPA in its regulations for the identification and listing of hazardous wastes to include solid, semisolid, liquid, and contained gaseous materials. However, the physical and chemical diversity of those materials, as well as the dissimilarity of storage facilities (lagoons, open piles, tanks, drums, etc.) and sampling equipment associated with them, preclude a detailed consideration of any specific sampling plan. Consequently, because the burden of responsibility for developing a technically sound sampling plan rests with the waste producer, it is advisable that he/she seek competent advice before designing a plan. This is particularly true in the early developmental stages of a sampling plan, at which time at least a basic understanding of applied statistics is required. Applied statistics is the science of employing techniques that allow the uncertainty of inductive inferences (general conclusions based on partial knowledge) to be evaluated.

9.1.1 Development of Appropriate Sampling Plans

An appropriate sampling plan for a solid waste must be responsive to both regulatory and scientific objectives. Once those objectives have been clearly identified, a suitable sampling strategy, predicated upon fundamental statistical concepts, can be developed. The statistical terminology associated with those concepts is reviewed in Table 9-1; Student's "t" values for use in the statistics of Table 9-1 appear in Table 9-2.

9.1.1.1 Regulatory and Scientific Objectives

The EPA, in its hazardous waste management system, has required that certain solid wastes be analyzed for physical and chemical properties. It is mostly chemical properties that are of concern, and, in the case of a number of chemical contaminants, the EPA has promulgated levels (regulatory thresholds) that cannot be equaled or exceeded. The regulations pertaining to the management of hazardous wastes contain three references regarding the

TABLE 9-1. BASIC STATISTICAL TERMINOLOGY APPLICABLE TO SAMPLING PLANS FOR SOLID WASTES

Terminology	Symbol	Mathematical Equation (Equation)
• Variable (e.g., barium or endrin)	x	—
• Individual measurement of variable	x_i	—
• Mean of possible measurements of variable (population mean)	μ	$\mu = \frac{\sum_{i=1}^N x_i}{N}, \text{ with } N = \text{number of possible measurements} \quad (1)$
• Mean of measurements generated by sample (sample mean)	\bar{x}	<p><u>Simple random sampling and systematic random sampling</u></p> $\bar{x} = \frac{\sum_{i=1}^n x_i}{n}, \text{ with } n = \text{number of sample measurements} \quad (2a)$ <p><u>Stratified random sampling</u></p> $\bar{x} = \sum_{k=1}^r W_k \bar{x}_k, \text{ with } \bar{x}_k = \text{stratum mean and } W_k = \text{fraction of population represented by Stratum } k \text{ (number of strata } [k] \text{ range from 1 to } r) \quad (2b)$
• Variance of sample	s^2	<p><u>Simple random sampling and systematic random sampling</u></p> $s^2 = \frac{\sum_{i=1}^n x_i^2 - (\sum_{i=1}^n x_i)^2/n}{n - 1} \quad (3a)$ <p><u>Stratified random sampling</u></p> $s^2 = \sum_{k=1}^r W_k s_k^2, \text{ with } s_k^2 = \text{stratum variance and } W_k = \text{fraction of population represented by Stratum } k \text{ (number of strata } [k] \text{ ranges from 1 to } r) \quad (3b)$

TABLE 9-1. (continued)

Terminology	Symbol	Mathematical Equation	(Equation)
• Standard deviation of sample	s	$s = \sqrt{s^2}$	(4)
• Standard error (also standard error of mean and standard deviation of mean) of sample	$s_{\bar{x}}$	$s_{\bar{x}} = \frac{s}{\sqrt{n}}$	(5)
• Confidence interval for μ^a	CI	$CI = \bar{x} \pm t_{.20} s_{\bar{x}}$, with $t_{.20}$ obtained from Table 2 for appropriate degrees of freedom	(6)
• Regulatory threshold ^a	RT	Defined by EPA (e.g., 100 ppm for barium in elutriate of EP toxicity)	(7)
• Appropriate number of samples to collect from a solid waste (financial constraints not considered)	n	$n = \frac{t_{.20}^2 s^2}{\Delta^2}$, with $\Delta = RT - \bar{x}$	(8)
• Degrees of freedom	df	$df = n - 1$	(9)
• Square root transformation	---	$X_i + \frac{1}{2}$	(10)
• Arcsin transformation	---	Arcsin p; if necessary, refer to any text on basic statistics; measurements must be converted to percentages (p)	(11)

^aThe upper limit of the CI for μ is compared with the applicable regulatory threshold (RT) to determine if a solid waste contains the variable (chemical contaminant) of concern at a hazardous level. The contaminant of concern is not considered to be present in the waste at a hazardous level if the upper limit of the CI is less than the applicable RT. Otherwise, the opposite conclusion is reached.

TABLE 9-2. TABULATED VALUES OF STUDENT'S "t" FOR EVALUATING
SOLID WASTES

Degrees of freedom (n-1) ^a	Tabulated "t" Value ^b
1	3.078
2	1.886
3	1.638
4	1.533
5	1.476
6	1.440
7	1.415
8	1.397
9	1.393
10	1.372
11	1.363
12	1.356
13	1.350
14	1.345
15	1.341
16	1.337
17	1.333
18	1.330
19	1.328
20	1.325
21	1.323
22	1.321
23	1.319
24	1.318
25	1.316
26	1.315
27	1.314
28	1.313
29	1.311
30	1.310
40	1.303
60	1.296
120	1.289
	1.282

^a Degrees of freedom (df) are equal to the number of samples (n) collected from a solid waste less one.

^b Tabulated "t" values are for a two-tailed confidence interval and a probability of 0.20 (the same values are applicable to a one-tailed confidence interval and a probability of 0.10).

sampling of solid wastes for analytical properties. The first reference, which occurs throughout the regulations, requires that representative samples of waste be collected and defines representative samples as exhibiting average properties of the whole waste. The second reference, which pertains just to petitions to exclude wastes from being listed as hazardous wastes, specifies that enough samples (but in no case less than four samples) be collected over a period of time sufficient to represent the variability of the wastes. The third reference, which applies only to ground water monitoring systems, mandates that four replicates (subsamples) be taken from each ground water sample intended for chemical analysis and that the mean concentration and variance for each chemical constituent be calculated from those four subsamples and compared with background levels for ground water. Even the statistical test to be employed in that comparison is specified (Student's t-test).

The first of the above-described references addresses the issue of sampling accuracy, and the second and third references focus on sampling variability or, conversely, sampling precision (actually the third reference relates to analytical variability, which, in many statistical tests, is indistinguishable from true sampling variability). Sampling accuracy (the closeness of a sample value to its true value) and sampling precision (the closeness of repeated sample values) are also the issues of overriding importance in any scientific assessment of sampling practices. Thus, from both regulatory and scientific perspectives, the primary objectives of a sampling plan for a solid waste are twofold: namely, to collect samples that will allow measurements of the chemical properties of the waste that are both accurate and precise. If the chemical measurements are sufficiently accurate and precise, they will be considered reliable estimates of the chemical properties of the waste.

It is now apparent that a judgment must be made as to the degree of sampling accuracy and precision that is required to estimate reliably the chemical characteristics of a solid waste for the purpose of comparing those characteristics with applicable regulatory thresholds. Generally, high accuracy and high precision are required if one or more chemical contaminants of a solid waste are present at a concentration that is close to the applicable regulatory threshold. Alternatively, relatively low accuracy and low precision can be tolerated if the contaminants of concern occur at levels far below or far above their applicable thresholds. However, a word of caution is in order. Low sampling precision is often associated with considerable savings in analytical, as well as sampling, costs and is clearly recognizable even in the simplest of statistical tests. On the other hand, low sampling accuracy may not entail cost savings and is always obscured in statistical tests (i.e., it cannot be evaluated). Therefore, although it is desirable to design sampling plans for solid wastes to achieve only the minimally required precision (at least two samples of a material are required for any estimate of precision), it is prudent to design the plans to attain the greatest possible accuracy.

The roles that inaccurate and imprecise sampling can play in causing a solid waste to be inappropriately judged hazardous are illustrated in Figure 9-1. When evaluating Figure 9-1, several points are worthy of consideration. Although a sampling plan for a solid waste generates a mean concentration (\bar{x}) and standard deviation (s_x , a measure of the extent to which individual sample concentrations are dispersed around \bar{x}) for each chemical contaminant of concern, it is not the variation of individual sample concentrations that is of ultimate concern, but rather the variation that characterizes \bar{x} itself. That measure of dispersion is termed the standard deviation of the mean (also, the standard error of the mean or standard error) and is designated as $s_{\bar{x}}$. Those two sample values, \bar{x} and $S_{\bar{x}}$, are used to estimate the interval (range) within which the true mean (μ) of the chemical concentration probably occurs, under the assumption that the individual concentrations exhibit a normal (bell-shaped) distribution. For the purposes of evaluating solid wastes, the probability level (confidence interval) of 80% has been selected. That is, for each chemical contaminant of concern, a confidence interval (CI) is described within which μ occurs if the sample is representative, which is expected of about 80 out of 100 samples. The upper limit of the 80% CI is then compared with the appropriate regulatory threshold. If the upper limit is less than the threshold, the chemical contaminant is not considered to be present in the waste at a hazardous level; otherwise, the opposite conclusion is drawn. One last point merits explanation. Even if the upper limit of an estimated 80% CI is only slightly less than the regulatory threshold (the worst case of chemical contamination that would be judged acceptable), there is only a 10% (not 20%) chance that the threshold is equaled or exceeded. That is because values of a normally distributed contaminant that are outside the limits of an 80% CI are equally distributed between the left (lower) and right (upper) tails of the normal curve. Consequently, the CI employed to evaluate solid wastes is, for all practical purposes, a 90% interval.

9.1.1.2 Fundamental Statistical Concepts

The concepts of sampling accuracy and precision have already been introduced, along with some measurements of central tendency (\bar{x}) and dispersion (standard deviation [s] and s_x) for concentrations of a chemical contaminant of a solid waste. The utility of \bar{x} and s_x in estimating a confidence interval that probably contains the true mean (μ) concentration of a contaminant has also been described. However, it was noted that the validity of that estimate is predicated upon the assumption that individual concentrations of the contaminant exhibit a normal distribution.

Statistical techniques for obtaining accurate and precise samples are relatively simple and easy to implement. Sampling accuracy is usually achieved by some form of random sampling. In random sampling, every unit in the population (e.g., every location in a lagoon used to store a solid waste) has a theoretically equal chance of being sampled and measured. Consequently, statistics generated by the sample (e.g., \bar{x} and, to a lesser degree, $S_{\bar{x}}$) are unbiased (accurate) estimators of true population parameters (e.g., the CI for μ). In other words, the sample is representative of the population. One of the commonest methods of selecting a random sample is to divide the

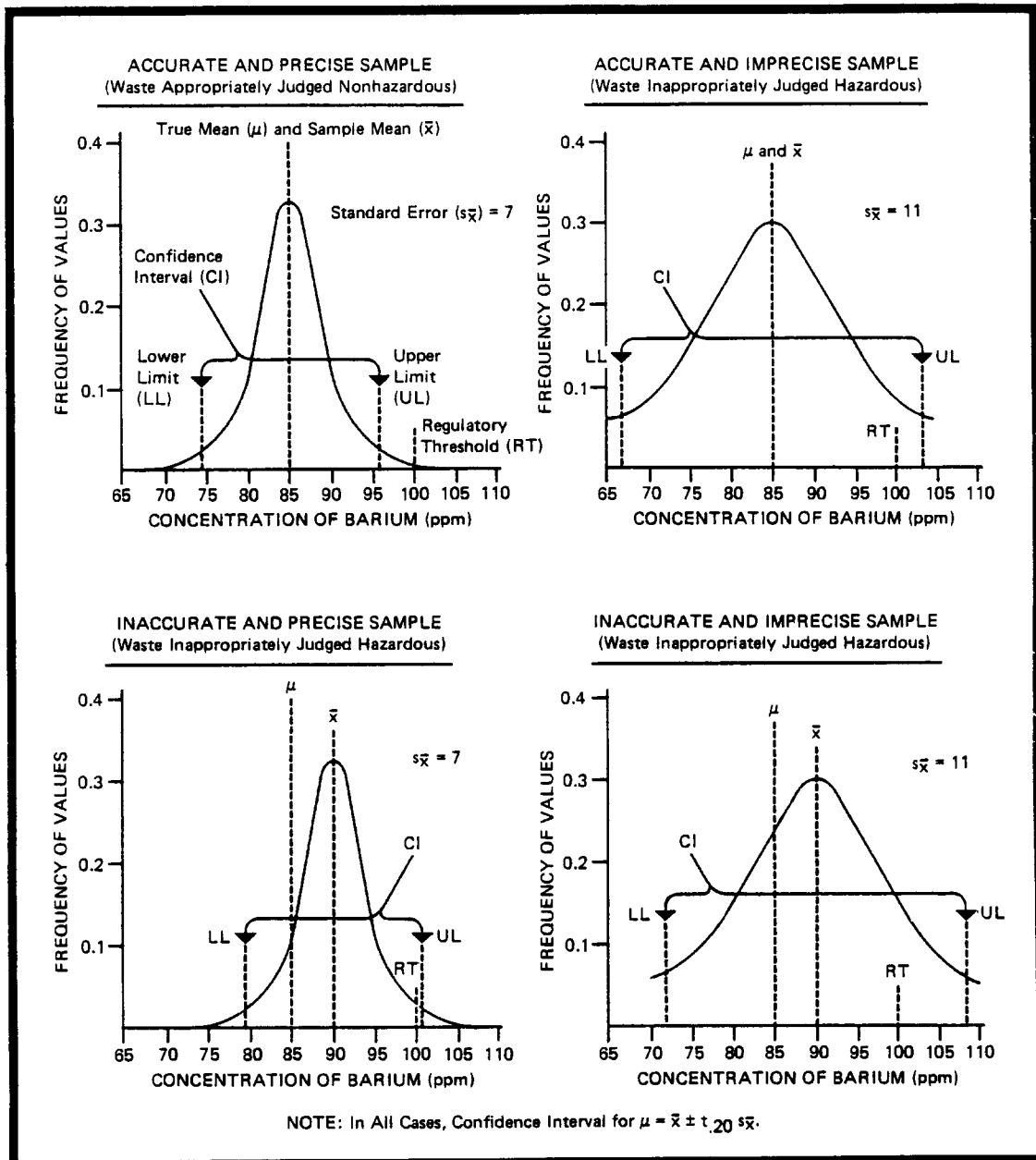

Figure 9-1. - Important theoretical relationships between sampling accuracy and precision and regulatory objectives for a chemical contaminant of a solid waste that occurs at a concentration marginally less than its regulatory threshold. In this example, barium is the chemical contaminant. The true mean concentration of barium in the elutriate of the EP toxicity test is 85 ppm, as compared to a regulatory threshold of 100 ppm. The upper limit of the confidence interval for the true mean concentration, which is estimated from the sample mean and standard error, must be less than the regulatory threshold if barium is judged to be present in the waste at a nonhazardous level.

population by an imaginary grid, assign a series of consecutive numbers to the units of the grid, and select the numbers (units) to be sampled through the use of a random-numbers table (such a table can be found in any text on basic statistics). It is important to emphasize that a haphazardly selected sample is not a suitable substitute for a randomly selected sample. That is because there is no assurance that a person performing undisciplined sampling will not consciously or subconsciously favor the selection of certain units of the population, thus causing the sample to be unrepresentative of the population.

Sampling precision is most commonly achieved by taking an appropriate number of samples from the population. As can be observed from the equation for calculating $S_{\bar{x}}$, precision increases ($S_{\bar{x}}$ and the CI for μ decrease) as the number of samples (n) increases, although not in a 1:1 ratio. For example, a 100% increase in the number of samples from two to four causes the CI to decrease by approximately 62% (about 31% of that decrease is associated with the critical upper tail of the normal curve). However, another 100% increase in sampling effort from four to eight samples results in only an additional 39% decrease in the CI. Another technique for increasing sampling precision is to maximize the physical size (weight or volume) of the samples that are collected. That has the effect of minimizing between-sample variation and, consequently, decreasing $s_{\bar{x}}$. Increasing the number or size of samples taken from a population, in addition to increasing sampling precision, has the secondary effect of increasing sampling accuracy.

In summary, reliable information concerning the chemical properties of a solid waste is needed for the purpose of comparing those properties with applicable regulatory thresholds. If chemical information is to be considered reliable, it must be accurate and sufficiently precise. Accuracy is usually achieved by incorporating some form of randomness into the selection process for the samples that generate the chemical information. Sufficient precision is most often obtained by selecting an appropriate number of samples.

There are a few ramifications of the above-described concepts that merit elaboration. If, for example, as in the case of semiconductor etching solutions, each batch of a waste is completely homogeneous with regard to the chemical properties of concern and that chemical homogeneity is constant (uniform) over time (from batch to batch), a single sample collected from the waste at an arbitrary location and time would theoretically generate an accurate and precise estimate of the chemical properties. However, most wastes are heterogeneous in terms of their chemical properties. If a batch of waste is randomly heterogeneous with regard to its chemical characteristics and that random chemical heterogeneity remains constant from batch to batch, accuracy and appropriate precision can usually be achieved by simple random sampling. In that type of sampling, all units in the population (essentially all locations or points in all batches of waste from which a sample could be collected) are identified, and a suitable number of samples is randomly selected from the population. More complex stratified random sampling is appropriate if a batch of waste is known to be nonrandomly heterogeneous in terms of its chemical properties and/or nonrandom chemical heterogeneity is known to exist from batch to batch. In such cases, the population is stratified to isolate the known sources of nonrandom chemical heterogeneity.

After stratification, which may occur over space (locations or points in a batch of waste) and/or time (each batch of waste), the units in each stratum are numerically identified, and a simple random sample is taken from each stratum. As previously intimated, both simple and stratified random sampling generate accurate estimates of the chemical properties of a solid waste. The advantage of stratified random sampling over simple random sampling is that, for a given number of samples and a given sample size, the former technique often results in a more precise estimate of chemical properties of a waste (a lower value of s_x) than the latter technique. However, greater precision is likely to be realized only if a waste exhibits substantial nonrandom chemical heterogeneity and stratification efficiently "divides" the waste into strata that exhibit maximum between-strata variability and minimum within-strata variability. If that does not occur, stratified random sampling can produce results that are less precise than in the case of simple random sampling. Therefore, it is reasonable to select stratified random sampling over simple random sampling only if the distribution of chemical contaminants in a waste is sufficiently known to allow an intelligent identification of strata and at least two or three samples can be collected in each stratum. If a strategy employing stratified random sampling is selected, a decision must be made regarding the allocation of sampling effort among strata. When chemical variation within each stratum can be estimated with a great degree of detail, samples should be optimally allocated among strata, i.e., the number of samples collected from each stratum should be directly proportional to the chemical variation encountered in the stratum. When detailed information concerning chemical variability within strata is not available, samples should be proportionally allocated among strata, i.e., sampling effort in each stratum should be directly proportional to the size of the stratum.

Simple random sampling and stratified random sampling are types of probability sampling. Which, because of a reliance upon mathematical and statistical theories, allows an evaluation of the effectiveness of sampling procedures. Another type of probability sampling is systematic random sampling, in which the first unit to be collected from a population is randomly selected, but all subsequent units are taken at fixed space or time intervals. An example of systematic random sampling is the sampling of a waste lagoon along a transect in which the first sampling point on the transect is 1 m from a randomly selected location on the shore and subsequent sampling points are located at 2-m intervals along the transect. The advantages of systematic random sampling over simple random sampling and stratified random sampling are the ease with which samples are identified and collected (the selection of the first sampling unit determines the remainder of the units) and, sometimes, an increase in precision. In certain cases, for example, systematic random sampling might be expected to be a little more precise than stratified random sampling with one unit per stratum because samples are distributed more evenly over the population. As will be demonstrated shortly, disadvantages of systematic random sampling are the poor accuracy and precision that can occur when unrecognized trends or cycles occur in the population. For those reasons, systematic random sampling is recommended only when a population is essentially random or contains at most a modest stratification. In such cases, systematic random sampling would be employed for the sake of convenience, with little expectation of an increase in precision over other random sampling techniques.

Probability sampling is contrasted with authoritative sampling, in which an individual who is well acquainted with the solid waste to be sampled selects a sample without regard to randomization. The validity of data gathered in that manner is totally dependent on the knowledge of the sampler and although valid data can sometimes be obtained, authoritative sampling is not recommended for the chemical characterization of most wastes.

It may now be useful to offer a generalization regarding the four sampling strategies that have been identified for solid wastes. If little or no information is available concerning the distribution of chemical contaminants of a waste, simple random sampling is the most appropriate sampling strategy. As more information is accumulated for the contaminants of concern, greater consideration can be given (in order of the additional information required) to stratified random sampling, systematic random sampling, and, perhaps, authoritative sampling.

The validity of a CI for the true mean (μ) concentration of a chemical contaminant of a solid waste is, as previously noted, based on the assumption that individual concentrations of the contaminant exhibit a normal distribution. This is true regardless of the strategy that is employed to sample the waste. Although there are computational procedures for evaluating the correctness of the assumption of normality, those procedures are meaningful only if a large number of samples are collected from a waste. Because sampling plans for most solid wastes entail just a few samples, one can do little more than superficially examine resulting data for obvious departures from normality (this can be done by simple graphical methods), keeping in mind that even if individual measurements of a chemical contaminant of a waste exhibit a considerably abnormal distribution, such abnormality is not likely to be the case for sample means, which are our primary concern. One can also compare the mean of the sample (\bar{x}) with the variance of the sample (s^2). In a normally distributed population, \bar{x} would be expected to be greater than s^2 (assuming that the number of samples [n] is reasonably large). If that is not the case, the chemical contaminant of concern may be characterized by a Poisson distribution (\bar{x} is approximately equal to s^2) or a negative binomial distribution (\bar{x} is less than s^2). In the former circumstance, normality can often be achieved by transforming data according to the square root transformation. In the latter circumstance, normality may be realized through use of the arcsine transformation. If either transformation is required, all subsequent statistical evaluations must be performed on the transformed scale.

Finally, it is necessary to address the appropriate number of samples to be employed in the chemical characterization of a solid waste. As has already been emphasized, the appropriate number of samples is the least number of samples required to generate a sufficiently precise estimate of the true mean (μ) concentration of a chemical contaminant of a waste. From the perspective of most waste producers, that means the minimal number of samples needed to demonstrate that the upper limit of the CI for μ is less than the applicable regulatory threshold (RT). The formula for estimating appropriate sampling effort (Table 9-1, Equation 8) indicates that increased sampling effort is generally justified as s^2 or the " $t_{.20}$ " value (probable error rate) increases

and as $\Delta(RT - \bar{x})$ decreases. In a well-designed sampling plan for a solid waste, an effort is made to estimate the values of \bar{x} and s^2 before sampling is initiated. Such preliminary estimates, which may be derived from information pertaining to similar wastes, process engineering data, or limited analytical studies, are used to identify the approximate number of samples that must be collected from the waste. It is always prudent to collect a somewhat greater number of samples than indicated by preliminary estimates of \bar{x} and s^2 since poor preliminary estimates of those statistics can result in an underestimate of the appropriate number of samples to collect. It is usually possible to process and store the extra samples appropriately until analysis of the initially identified samples is completed and it can be determined if analysis of the additional samples is warranted.

9.1.1.3 Basic Sampling Strategies

It is now appropriate to present general procedures for implementing the three previously introduced sampling strategies (simple random sampling, stratified random sampling, and systematic random sampling) and a hypothetical example of each sampling strategy. The hypothetical examples illustrate the statistical calculations that must be performed in most situations likely to be encountered by a waste producer and, also, provide some insight into the efficiency of the three sampling strategies in meeting regulatory objectives.

The following hypothetical conditions are assumed to exist for all three sampling strategies. First, barium, which has an RT of 100 ppm as measured in the EP elutriate test, is the only chemical contaminant of concern. Second, barium is discharged in particulate form to a waste lagoon and accumulates in the lagoon in the form of a sludge, which has built up to approximately the same thickness throughout the lagoon. Third, concentrations of barium are relatively homogeneous along the vertical gradient (from the water-sludge interface to the sludge-lagoon interface), suggesting a highly controlled manufacturing process (little between-batch variation in barium concentrations). Fourth, the physical size of sludge samples collected from the lagoon is as large as practical, and barium concentrations derived from those samples are normally distributed (note that we do not refer to barium levels in the samples of sludge because barium measurements are actually made on the elutriate from EP toxicity tests performed with the samples). Last, a preliminary study of barium levels in the elutriate of four EP toxicity tests conducted with sludge collected from the lagoon several years ago identified values of 86 and 90 ppm for material collected near the outfall (in the upper third) of the lagoon and values of 98 and 104 ppm for material obtained from the far end (the lower two-thirds) of the lagoon.

For all sampling strategies, it is important to remember that barium will be determined to be present in the sludge at a hazardous level if the upper limit of the CI for μ is equal to or greater than the RT of 100 ppm (Table 9-1, Equations 6 and 7).

9.1.1.3.1 Simple Random Sampling

Simple random sampling (Box 1) is performed by general procedures in which preliminary estimates of \bar{x} and s^2 , as well as a knowledge of the RT, for each chemical contaminant of a solid waste that is of concern are employed to estimate the appropriate number of samples (n) to be collected from the waste. That number of samples is subsequently analyzed for each chemical contaminant of concern. The resulting analytical data are then used to conclude definitively that each contaminant is or is not present in the waste at a hazardous concentration or, alternatively, to suggest a reiterative process, involving increased sampling effort, through which the presence or absence of hazard can be definitively determined.

In the hypothetical example for simple random sampling (Box 1), preliminary estimates of \bar{x} and s^2 indicated a sampling effort consisting of six samples. That number of samples was collected and initially analyzed generating analytical data somewhat different from the preliminary data (s^2 was substantially greater than was preliminarily estimated). Consequently, the upper limit of the CI was unexpectedly greater than the applicable RT, resulting in a tentative conclusion of hazard. However, a reestimation of appropriate sampling effort, based on statistics derived from the six samples, suggested that such a conclusion might be reversed through the collection and analysis of just one more sample. Fortunately, a resampling effort was not required because of the foresight of the waste producer in obtaining three extra samples during the initial sampling effort, which, because of their influence in decreasing the final values of \bar{x} , $S_{\bar{x}}$, $t_{.20}$, and, consequently, the upper limit of the CI -- values obtained from all nine samples -- resulted in a definitive conclusion of nonhazard.

9.1.1.3.2 Stratified Random Sampling

Stratified random sampling (Box 2) is conducted by general procedures that are similar to the procedures described for simple random sampling. The only difference is that, in stratified random sampling, values of \bar{x} and s^2 are calculated for each stratum in the population and then integrated into overall estimates of those statistics, the standard deviation (s), $s_{\bar{x}}$, and the appropriate number of samples (n) for all strata.

The hypothetical example for stratified random sampling (Box 2) is based on the same nine sludge samples previously identified in the example of simple random sampling (Box 1) so that the relative efficiencies of the two sampling strategies can be fully compared. The efficiency generated through the process of stratification is first evident in the preliminary estimate of n (Step 2 in Boxes 1 and 2), which is six for simple random sampling and four for stratified random sampling. (The lesser value for stratified sampling is the consequence of a dramatic decrease in s^2 which more than compensated for a modest increase in Δ .) The most relevant indication of sampling efficiency is the value of $S_{\bar{x}}$, which is directly employed to calculate the CI. In the case of simple random sampling, $S_{\bar{x}}$ is calculated as 2.58 (Step 9 in Box 1), and, for stratified random sampling, $S_{\bar{x}}$ is determined to be 2.35 (Steps 5 and 7 in Box 2). Consequently, the gain in efficiency attributable to stratification is approximately 9% ($0.23/2.58$).

BOX 1. STRATEGY FOR DETERMINING IF CHEMICAL CONTAMINANTS OF SOLID WASTES ARE PRESENT AT HAZARDOUS LEVELS - SIMPLE RANDOM SAMPLING

Step

General Procedures

1. Obtain preliminary estimates of \bar{x} and s^2 for each chemical contaminant of a solid waste that is of concern. The two above-identified statistics are calculated by, respectively, Equations 2a and 3a (Table 9-1).
2. Estimate the appropriate number of samples (n_1) to be collected from the waste through use of Equation 8 (Table 9-1) and Table 9-2. Derive individual values of n_1 for each chemical contaminant of concern. The appropriate number of samples to be taken from the waste is the greatest of the individual n_1 values.
3. Randomly collect at least n_1 (or $n_2 - n_1$, $n_3 - n_2$, etc., as will be indicated later in this box) samples from the waste (collection of a few extra samples will provide protection against poor preliminary estimates of \bar{x} and s^2). Maximize the physical size (weight or volume) of all samples that are collected.
4. Analyze the n_1 (or $n_2 - n_1$, $n_3 - n_2$ etc.) samples for each chemical contaminant of concern. Superficially (graphically) examine each set of analytical data for obvious departures from normality.
5. Calculate \bar{x} , s^2 , the standard deviation (s), and $s_{\bar{x}}$ for each set of analytical data by, respectively, Equations 2a, 3a, 4, and 5 (Table 9-1).
6. If \bar{x} for a chemical contaminant is equal to or greater than the applicable RT (Equation 7, Table 9-1) and is believed to be an accurate estimator of μ , the contaminant is considered to be present in the waste at a hazardous concentration, and the study is completed. Otherwise, continue the study. In the case of a set of analytical data that does not exhibit obvious abnormality and for which \bar{x} is greater than s^2 , perform the following calculations with nontransformed data. Otherwise, consider transforming the data by the square root transformation (if \bar{x} is about equal to s^2) or the arcsine transformation (if \bar{x} is less than s^2) and performing all subsequent calculations with transformed data. Square root and arcsine transformations are defined by, respectively, Equations 10 and 11 (Table 9-1).
7. Determine the CI for each chemical contaminant of concern by Equation 6 (Table 9-1) and Table 9-2. If the upper limit of the CI is less than the applicable RT (Equations 6 and 7, Table 9-1), the chemical contaminant is not considered to be present in the waste at a hazardous concentration and the study is completed. Otherwise, the opposite conclusion is tentatively reached.

8. If a tentative conclusion of hazard is reached, reestimate the total number of samples (n_2) to be collected from the waste by use of Equation 8 (Table 9-1) and Table 9-2. When deriving n_2 , employ the newly calculated (not preliminary) values of \bar{x} and s^2 . If additional $n_2 - n_1$ samples of waste cannot reasonably be collected, the study is completed, and a definitive conclusion of hazard is reached. Otherwise, collect extra $n_2 - n_1$ samples of waste.
9. Repeat the basic operations described in Steps 3 through 8 until the waste is judged to be nonhazardous or, if the opposite conclusion continues to be reached, until increased sampling effort is impractical.

Hypothetical Example

Step

1. The preliminary study of barium levels in the elutriate of four EP toxicity tests, conducted with sludge collected from the lagoon several years ago, generated values of 86 and 90 ppm for sludge obtained from the upper third of the lagoon and values of 98 and 104 ppm for sludge from the lower two-thirds of the lagoon. Those two sets of values are not judged to be indicative of nonrandom chemical heterogeneity (stratification) within the lagoon. Therefore, preliminary estimates of \bar{x} and s^2 are calculated as:

$$\bar{x} = \frac{\sum_{i=1}^n x_i}{n} = \frac{86 + 90 + 98 + 104}{4} = 94.50, \text{ and} \quad (\text{Equation 2a})$$

$$s^2 = \frac{\sum_{i=1}^n x_i^2 - (\sum_{i=1}^n x_i)^2/n}{n - 1} \quad (\text{Equation 3a})$$

$$= \frac{35,916.00 - 35,721.00}{3} = 65.00.$$

2. Based on the preliminary estimates of \bar{x} and s^2 as well as the knowledge that the RT for barium is 100 ppm,

$$n_1 = \frac{t_{.20}^2 s^2}{\Delta^2} = \frac{(1.638^2) (65.00)}{5.50^2} = 5.77. \quad (\text{Equation 8})$$

3. As indicated above, the appropriate number of sludge samples (n_1) to be collected from the lagoon is six. That number of samples (plus three extra samples for protection against poor preliminary estimates of \bar{x} and s^2) is collected from the lagoon by a single randomization process (Figure 9-2). All samples consist of the greatest volume of sludge that can be

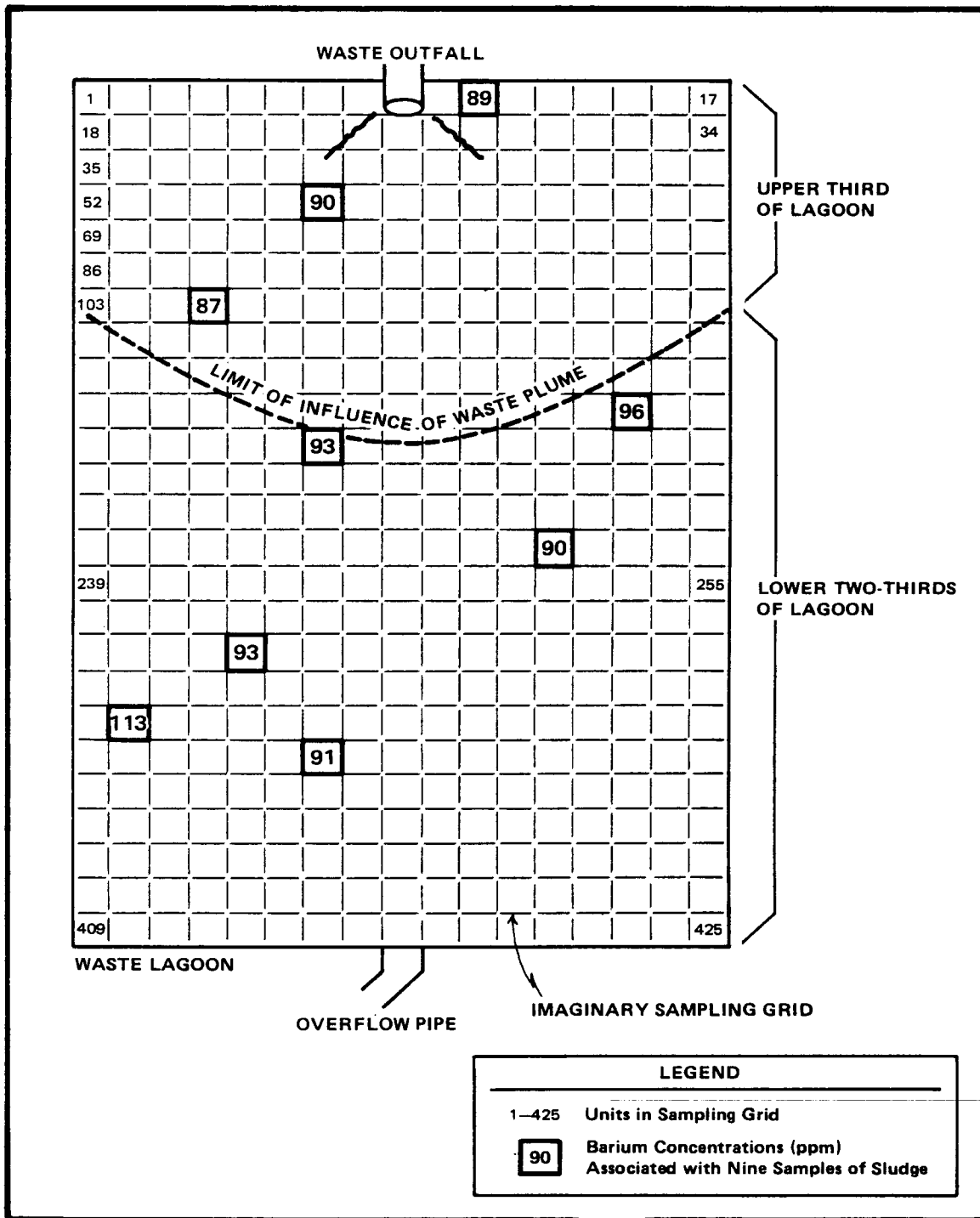

Figure 9-2. Hypothetical sampling conditions in waste lagoon containing sludge contaminated with barium. Barium concentrations associated with samples of sludge refer to levels measured in the elutriate of EP toxicity tests conducted with the samples.

practically collected. The three extra samples are suitably processed and stored for possible later analysis.

4. The six samples of sludge (n_1) designated for immediate analysis generate the following concentrations of barium in the EP toxicity test: 89, 90, 87, 96, 93, and 113 ppm. Although the value of 113 ppm appears unusual as compared with the other data, there is no obvious indication that the data are not normally distributed.
5. New values for \bar{x} and s^2 and associated values for the standard deviation (s) and $s_{\bar{x}}$ are calculated as:

$$\bar{x} = \frac{\sum_{i=1}^n x_i}{n} = \frac{89 + 90 + 87 + 96 + 93 + 113}{6} = 94.67, \quad (\text{Equation 2a})$$

$$s^2 = \frac{\sum_{i=1}^n x_i^2 - (\sum_{i=1}^n x_i)^2/n}{n - 1} \quad (\text{Equation 3a})$$

$$= \frac{54,224.00 - 53,770.67}{5} = 90.67,$$

$$s = \sqrt{s^2} = 9.52, \text{ and} \quad (\text{Equation 4})$$

$$s_{\bar{x}} = s/\sqrt{n} = 9.52/\sqrt{6} = 3.89. \quad (\text{Equation 5})$$

6. The new value for \bar{x} (94.67) is less than the RT (100). In addition, \bar{x} is greater (only slightly) than s^2 (90.67), and, as previously indicated, the raw data are not characterized by obvious abnormality. Consequently, the study is continued, with the following calculations performed with nontransformed data.

$$7. \quad CI = \bar{x} \pm t_{.20} s_{\bar{x}} = 94.67 \pm (1.476)(3.89) \quad (\text{Equation 6})$$

$$= 94.67 \pm 5.74.$$

Because the upper limit of the CI (100.41) is greater than the applicable RT (100), it is tentatively concluded that barium is present in the sludge at a hazardous concentration.

8. n is now reestimated as:

$$n_2 = \frac{t_{.20}^2 s^2}{\Delta^2} = \frac{(1.476^2) (90.67)}{5.33^2} = 6.95. \quad (\text{Equation 8})$$

The value for n_2 (approximately 7) indicates that an additional ($n_2 - n_1 = 1$) sludge sample should be collected from the lagoon.

9. The additional sampling effort is not necessary because of the three extra samples that were initially collected from the lagoon. All extra samples are analyzed, generating the following levels of barium for the EP toxicity test: 93, 90, and 91 ppm. Consequently, \bar{x} , s^2 the standard deviation (s), and $s_{\bar{x}}$ are recalculated as:

$$\bar{x} = \frac{\sum_{i=1}^n X_i}{n} = \frac{86 + 90 + \dots + 91}{9} = 93.56, \quad (\text{Equation 2a})$$

$$s^2 = \frac{\sum_{i=1}^n X_i^2 - (\sum_{i=1}^n X_i)^2/n}{n-1} \quad (\text{Equation 3a})$$

$$= \frac{79,254.00 - 78,773.78}{8} = 60.03,$$

$$s = \sqrt{s^2} = 7.75, \text{ and} \quad (\text{Equation 4})$$

$$s_{\bar{x}} = s/\sqrt{n} = 7.75/\sqrt{9} = 2.58. \quad (\text{Equation 5})$$

The value for \bar{x} (93.56) is again less than the RT (100), and there is no indication that the nine data points, considered collectively, are abnormally distributed (in particular, \bar{x} is now substantially greater than s^2). Consequently, CI, calculated with nontransformed data, is determined to be:

$$CI = \bar{x} \pm t_{.20} s_{\bar{x}} = 93.56 \pm (1.397)(2.58) \quad (\text{Equation 6})$$

$$= 93.56 \pm 3.60.$$

The upper limit of the CI (97.16) is now less than the RT of 100. Consequently, it is definitively concluded that barium is not present in the sludge at a hazardous level.

8. If a tentative conclusion of hazard is reached, reestimate the total number of samples (n_2) to be collected from the waste by use of Equation 8 (Table 9-1) and Table 9-2. When deriving n_2 , employ the newly calculated (not preliminary) values of \bar{x} and s^2 . If additional $n_2 - n_1$ samples of waste cannot reasonably be collected, the study is completed, and a definitive conclusion of hazard is reached. Otherwise, collect extra $n_2 - n_1$ samples of waste.
9. Repeat the basic operations described in steps 3 through 8 until the waste is judged to be nonhazardous or, if the opposite conclusion continues to be reached, until increased sampling effort is impractical.

Hypothetical Example

Step

1. The preliminary study of barium levels in the elutriate of four EP toxicity tests, conducted with sludge collected from the lagoon several years ago, generated values of 86 and 90 ppm for sludge obtained from the upper third of the lagoon and values of 98 and 104 ppm for sludge from the lower two-thirds of the lagoon. Those two sets of values are not judged to be indicative of nonrandom chemical heterogeneity (stratification) within the lagoon. Therefore, preliminary estimates of \bar{x} and s^2 are calculated as:

$$\bar{x} = \sum_{k=1}^r W_k \bar{x}_k = \frac{(1)(88.00)}{3} + \frac{(2)(101.00)}{3} = 96.67, \text{ and} \quad (\text{Equation 2b})$$

$$s^2 = \sum_{k=1}^r W_k s_k^2 = \frac{(1)(8.00)}{3} + \frac{(2)(18.00)}{3} = 14.67. \quad (\text{Equation 3b})$$

2. Based on the preliminary estimates of \bar{x} and s^2 as well as the knowledge that the RT for barium is 100 ppm,

$$n_1 = \frac{t_{.20}^2 s^2}{\Delta^2} = \frac{(1.368^2)(14.67)}{3.33^2} = 3.55. \quad (\text{Equation 8})$$

3. As indicated above, the appropriate number of sludge samples (n_1) to be collected from the lagoon is four. However, for purposes of comparison with simple random sampling (Box 1), six samples (plus three extra samples for protection against poor preliminary estimates of \bar{x} and s^2) are collected from the lagoon by a two-stage randomization process (Figure 2). Because s_k for the upper (2.12 ppm) and lower (5.66 ppm) strata are not believed to be very accurate estimates, the nine samples to be collected from the lagoon are not optimally allocated between the two strata (optimum allocation would require two and seven samples to be

collected from the upper and lower strata, respectively). Alternatively, proportional allocation is employed: three samples are collected from the upper stratum (which represents one-third of the lagoon), and six samples are taken from the lower stratum (two-thirds of the lagoon). All samples consist of the greatest volume of sludge that can be practically collected.

4. The nine samples of sludge generate the following concentrations of barium in the EP toxicity test: upper stratum -- 89, 90, and 87 ppm; lower stratum -- 96, 93, 113, 93, 90, and 91 ppm. Although the value of 113 ppm appears unusual as compared with the other data for the lower stratum, there is no obvious indication that the data are not normally distributed.
5. New values for \bar{x} and s^2 and associated values for the standard deviation (s) and $s_{\bar{x}}$ are calculated as:

$$\bar{x} = \sum_{k=1}^r W_k \bar{x}_k = \frac{(1)(88.67)}{3} + \frac{(2)(96.00)}{3} = 93.56 , \quad (\text{Equation 2b})$$

$$s^2 = \sum_{k=1}^r W_k s_k^2 = \frac{(1)(2.33)}{3} + \frac{(2)(73.60)}{3} = 49.84 , \quad (\text{Equation 3b})$$

$$s = \sqrt{s^2} = 7.06, \text{ and} \quad (\text{Equation 4})$$

$$s_{\bar{x}} = s/\sqrt{n} = 7.06/\sqrt{9} = 2.35. \quad (\text{Equation 5})$$

6. The new value for \bar{x} (93.56) is less than the RT (100). In addition, \bar{x} is greater than s^2 (49.84), and, as previously indicated, the raw data are not characterized by obvious abnormality. Consequently, the study is continued, with the following calculations performed with nontransformed data.

$$\begin{aligned} 7. \quad CI &= \bar{x} \pm t_{.20} s_{\bar{x}} = 93.56 \pm (1.397)(2.35) && (\text{Equation 6}) \\ &= 93.56 \pm 3.28. \end{aligned}$$

The upper limit of the CI (96.84) is less than the applicable RT (100). Therefore, it is concluded that barium is not present in the sludge at a hazardous concentration.

9.1.1.3.3 Systematic Random Sampling

Systematic random sampling (Box 3) is implemented by general procedures that are identical to the procedures identified for simple random sampling. The hypothetical example for systematic random sampling (Box 3) demonstrates the bias and imprecision that are associated with that type of sampling when unrecognized trends or cycles exist in the population.

9.1.1.4 Special Considerations

The preceding discussion has addressed the major issues that are critical to the development of a reliable sampling strategy for a solid waste. The remaining discussion focuses on several "secondary" issues that should be considered when designing an appropriate sampling strategy. These secondary issues are applicable to all three of the basic sampling strategies that have been identified.

9.1.1.4.1 Composite Sampling

In composite sampling, a number of random samples are initially collected from a waste and combined into a single sample, which is then analyzed for the chemical contaminants of concern. The major disadvantage of composite sampling, as compared with noncomposite sampling, is that information concerning the chemical contaminants is lost, i.e., each initial set of samples generates only a single estimate of the concentration of each contaminant. Consequently, because the number of analytical measurements (n) is small, $s_{\bar{x}}$ and $t_{.20}$ are large, thus decreasing the likelihood that a contaminant will be judged to occur in the waste at a nonhazardous level (refer to appropriate equations in Table 9-1 and to Table 9-2). A remedy to that situation is to collect and analyze a relatively large number of composite samples, thereby offsetting the savings in analytical costs that are often associated with composite sampling, but achieving better representation of the waste than would occur with noncomposite sampling.

The appropriate number of composite samples to be collected from a solid waste is estimated by use of Equation 8 (Table 9-1), as previously described for the three basic sampling strategies. In comparison with noncomposite sampling, composite sampling may have the effect of minimizing between-sample variation (the same phenomenon that occurs when the physical size of a sample is maximized), thereby reducing somewhat the number of samples that must be collected from the waste.

9.1.1.4.2 Subsampling

The variance (s^2) associated with a chemical contaminant of a waste consists of two components in that:

$$s^2 = s_s^2 + \frac{s_a^2}{m}, \quad (\text{Equation 12})$$

BOX 3. STRATEGY FOR DETERMINING IF CHEMICAL CONTAMINANTS OF SOLID WASTES
ARE PRESENT AT HAZARDOUS LEVELS - SYSTEMATIC RANDOM SAMPLING

Step

General Procedures

1. Follow general procedures presented for simple random sampling of solid wastes (Box 1).

Step

Hypothetical Example

1. The example presented in Box 1 is applicable to systematic random sampling, with the understanding that the nine sludge samples obtained from the lagoon would be collected at equal intervals along a transect running from a randomly selected location on one bank of the lagoon to the opposite bank. If that randomly selected transect were established between Units 1 and 409 of the sampling grid (Figure 9-2) and sampling were performed at Unit 1 and thereafter at three-unit intervals along the transect (i.e., Unit 1, Unit 52, Unit 103, ... , and Unit 409), it is apparent that only two samples would be collected in the upper third of the lagoon, whereas seven samples would be obtained from the lower two-thirds of the lagoon. If, as suggested by the barium concentrations illustrated in Figure 9-2, the lower part of the lagoon is characterized by greater and more variable barium contamination than the upper part of the lagoon, systematic random sampling along the above-identified transect, by placing undue (disproportionate) emphasis on the lower part of the lagoon, might be expected to result in an inaccurate (overestimated) and imprecise characterization of barium levels in the whole lagoon, as compared with either simple random sampling or stratified random sampling. Such inaccuracy and imprecision, which are typical of systematic random sampling when unrecognized trends or cycles occur in the population, would be magnified if, for example, the randomly selected transect were established solely in the lower part of the lagoon, e.g., between Units 239 and 255 of the sampling grid.

where s_s^2 = a component attributable to sampling (sample) variation, s_a^2 = a component attributable to analytical (subsample) variation, and m = number of subsamples. In general, s_a^2 should not be allowed to exceed one-ninth of s_s^2 . If a preliminary study indicates that s_a^2 exceeds that threshold, a sampling strategy involving subsampling should be considered. In such a strategy, a number of replicate measurements are randomly made on a relatively limited number of randomly collected samples. Consequently, analytical effort is allocated as a function of analytical variability. The efficiency of that general strategy in meeting regulatory objectives has already been demonstrated in the previous discussions of sampling effort.

The appropriate number of samples (n) to be collected from a solid waste for which subsampling will be employed is again estimated by Equation 8 (Table 9-1). In the case of simple random sampling or systematic random sampling with an equal number of subsamples analyzed per sample:

$$\bar{x} = \frac{\sum_{i=1}^n x_i}{n}, \quad (\text{Equation 13})$$

where \bar{x}_i = sample mean (calculated from values for subsamples) and n = number of samples. Also,

$$s^2 = \frac{\sum_{i=1}^n \bar{x}_i^2 - (\sum_{i=1}^n \bar{x}_i)^2/n}{n-1} \quad (\text{Equation 14})$$

The optimum number of subsamples to be taken from each sample ($m_{opt.}$) is estimated as:

$$m_{(opt.)} = \frac{s_a}{s_s} \quad (\text{Equation 15})$$

when cost factors are not considered. The value for s_a is calculated from available data as:

$$s_a = \sqrt{\frac{\sum_{i=1}^n \sum_{j=1}^m x_{ij}^2 - (\sum_{i=1}^n x_{ij})^2/m}{n(m-1)}}, \quad (\text{Equation 16})$$

and s_s , which can have a negative characteristic, is defined as:

$$s_s = \sqrt{s^2 - \frac{s_a^2}{m}}, \quad (\text{Equation 17})$$

with s_2 calculated as indicated in Equation 14.

In the case of stratified random sampling with subsampling, critical formulas for estimating sample size (n) by Equation 8 (Table 9-1) include:

$$\bar{x} = \sum_{k=1}^r W_k \bar{x}_k, \quad (\text{Equation 2b})$$

where \bar{x}_k = stratum mean and W_k = fraction of population represented by Stratum K (number of strata, k, ranges from 1 to r). In Equation 2b, \bar{x}_k for each stratum is calculated as the average of all sample means in the stratum (sample means are calculated from values for subsamples). In addition, s^2 is calculated by:

$$s^2 = \sum_{k=1}^r W_k s_k^2, \quad (\text{Equation 3b})$$

with s_k^2 for each stratum calculated from all sample means in the stratum. The optimum subsampling effort when cost factors are not considered and all replication is symmetrical is again estimated as:

$$m_{(opt.)} = \frac{S_a}{S_s}, \text{ with} \quad (\text{Equation 15})$$

$$S_a = \sqrt{\frac{\sum_{k=1}^r \sum_{i=1}^n \sum_{j=1}^m X_{kij}^2 - (\sum X_{kij})^2 / m}{rn(m-1)}}, \text{ and} \quad (\text{Equation 18})$$

$$S_s = \sqrt{S^2 - \frac{S_a^2}{m}}, \quad (\text{Equation 17})$$

with s^2 derived as shown in Equation 3b.

9.1.1.5 Cost and Loss Functions

The cost of chemically characterizing a waste is dependent on the specific strategy that is employed to sample the waste. For example, in the case of simple random sampling without subsampling, a reasonable cost function might be:

$$C_{(n)} = C_0 + C_1 n, \quad (\text{Equation 19})$$

where $C_{(n)}$ = cost of employing a sample size of n , C_0 = an overhead cost (which is independent of the number of samples that are collected and analyzed), and C_1 = a sample-dependent cost. A consideration of $C_{(n)}$ mandates an evaluation of $L_{(n)}$, which is the sample-size-dependent expected financial loss related to the erroneous conclusion that a waste is hazardous. A simple loss function is:

$$L_{(n)} = \frac{\alpha s^2}{n}, \quad (\text{Equation 20})$$

with α = a constant related to the cost of a waste management program if the waste is judged to be hazardous, s^2 = sample variance, and n = number of samples. A primary objective of any sampling strategy is to minimize $C_{(n)} + L_{(n)}$. Differentiation of Equations 19 and 20 indicates that the number of samples (n) that minimize $C_{(n)} + L_{(n)}$ is:

$$n = \sqrt{\frac{\alpha s^2}{C_1}}. \quad (\text{Equation 21})$$

As is evident from Equation 21, a comparatively large number of samples (n) is justified if the value of α or s^2 is large, whereas a relatively small number of samples is appropriate if the value of C_1 is large. These general conclusions are valid for any sampling strategy for a solid waste.

9.2 IMPLEMENTATION

This section discusses the implementation of a sampling plan for the collection of a "solid waste," as defined by Section 261.2 of the Resource Conservation and Recovery Act (RCRA) regulations. Due to the uniqueness of each sampling effort, the following discussion is in the general form of guidance which, when applied to each sampling effort, should improve and document the quality of the sampling and the representativeness of samples.

The following subsections address elements of a sampling effort in a logical order, from defining objectives through compositing samples prior to analysis.

9.2.1 Definition Of Objectives

After verifying the need for sampling, those personnel directing the sampling effort should define the program's objectives. The need for a sampling effort should not be confused with the objective. When management, a regulation, or a regulatory agency requires sampling, the need for sampling is established but the objectives must be defined.

The primary objective of any waste sampling effort is to obtain information that can be used to evaluate a waste. It is essential that the specific information needed and its uses are defined in detail at this stage. The information needed is usually more complex than just a concentration of a specified parameter; it may be further qualified (e.g., by sampling location or sampling time.) The manner in which the information is to be used can also have a substantial impact on the design of a sampling plan. (Are the data to be used in a qualitative or quantitative manner? If quantitative, what are the accuracy and precision requirements?)

All pertinent information should be gathered. For example, if the primary objective has been roughly defined as "collecting samples of waste which will be analyzed to comply with environmental regulations," then ask the following questions:

1. The sampling is being done to comply with which environmental regulation? Certain regulations detail specific or minimum protocols (e.g., exclusion petitions as defined in §260.22 of the RCRA regulations); the sampling effort must comply with these regulatory requirements.
2. The collected samples are to be analyzed for which parameters? Why those and not others? Should the samples be analyzed for more or fewer parameters?
3. What waste is to be sampled: the waste as generated? The waste prior to or after mixing with other wastes or stabilizing agents? The waste after aging or drying or just prior to disposal? Should waste disposed of 10 years ago be sampled to acquire historical data?
4. What is the end-use of the generated data base? What are the required degrees of accuracy and precision?

By asking such questions, both the primary objective and specific sampling, analytical, and data objectives can be established.

Two sampling efforts could have identical primary objectives but different specific objectives. For example, consider two situations in which the primary objective is to determine if the concentration of barium is less than the regulatory threshold of 100 ppm. The specific objectives will vary and have a substantial effect on sampling. (This situation is presented graphically in Figures 9-3 and 9-4.) In Figure 9-3, under the assumption that the true distribution of barium concentrations throughout the waste of interest is as shown, limited information has indicated that the average concentration is approximately 50 ppm. In Figure 9-4, assume that historical data indicated an average concentration of 90 ppm and the true distribution of barium concentrations is as shown. Therefore, the specific data objective for the latter case is to generate a data base that can discriminate between 90 and 100 ppm, whereas in the former case the data objective is to discriminate between 50 and 100 ppm. Greater accuracy and precision are required to discriminate between 90 and 100 ppm; this fact will affect the number, size, and degree of compositing of samples collected and analyzed.

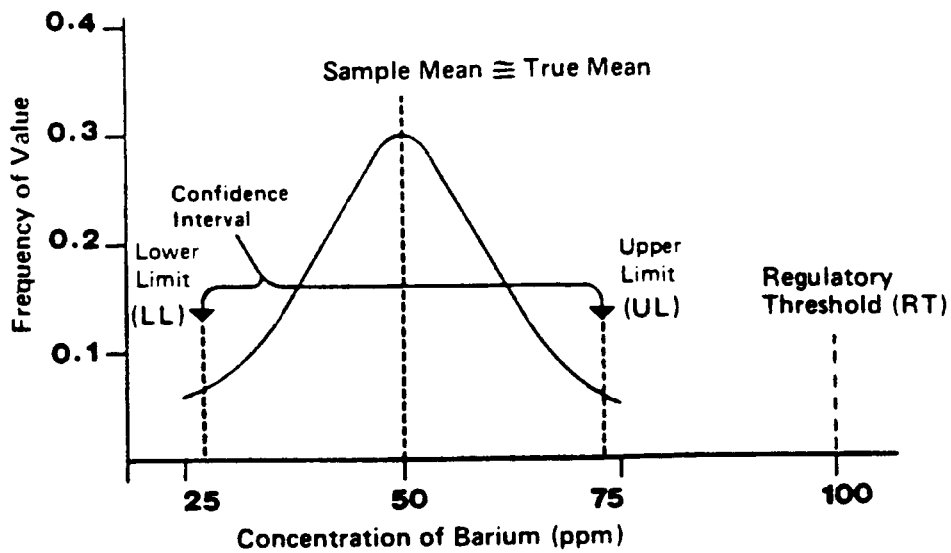

Distance of true value from regulatory threshold requires less accuracy and precision.

Figure 9-3. Distribution of barium concentration removed from a regulatory threshold.

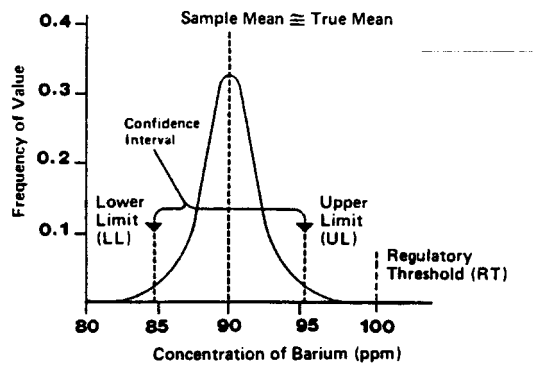

Proximity of true value from regulatory threshold requires more accuracy and precision.

Figure 9-4. Distribution of barium concentration near a regulatory threshold.

The form in Figure 9-5 can be used to document primary and specific objectives prior to development of a sampling plan. Once the objectives of a sampling effort are developed, it is important to adhere to them to ensure that the program maintains its direction.

9.2.2 Sampling Plan Considerations

The sampling plan is usually a written document that describes the objectives and details the individual tasks of a sampling effort and how they will be performed. (Under unusual circumstances, time may not allow for the sampling plan to be documented in writing, e.g., sampling during an emergency spill. When operating under these conditions, it is essential that the person directing the sampling effort be aware of the various elements of a sampling plan.) The more detailed the sampling plan, the less the opportunity for oversight or misunderstanding during sampling, analysis, and data treatment.

To ensure that the sampling plan is designed properly, it is wise to have all aspects of the effort represented. Those designing the sampling plan should include the following personnel:

1. An end-user of the data, who will be using the data to attain program objectives and thus would be best prepared to ensure that the data objectives are understood and incorporated into the sampling plan.
2. An experienced member of the field team who will actually collect samples, who can offer hands-on insight into potential problems and solutions, and who, having acquired a comprehensive understanding of the entire sampling effort during the design phase, will be better prepared to implement the sampling plan.
3. An analytical chemist, because the analytical requirements for sampling, preservation, and holding times will be factors around which the sampling plan will be written. A sampling effort cannot succeed if an improperly collected or preserved sample or an inadequate volume of sample is submitted to the laboratory for chemical, physical, or biological testing. The appropriate analytical chemist should be consulted on these matters.
4. An engineer should be involved if a complex manufacturing process is being sampled. Representation of the appropriate engineering discipline will allow for the optimization of sampling locations and safety during sampling and should ensure that all waste-stream variations are accounted for.
5. A statistician, who will review the sampling approach and verify that the resulting data will be suitable for any required statistical calculations or decisions.
6. A quality assurance representative, who will review the applicability of standard operating procedures and determine the number of blanks, duplicates, spike samples, and other steps required to document the accuracy and precision of the resulting data base.

Sampling Site: _____

Address: _____

Description of Waste to be Sampled: _____

Primary Objective: _____

Specific Sampling Objectives: _____

Specific Analysis Objectives: _____

Specific Data Objectives: _____

Figure 9-5. Form for Documenting Primary and Specific Objectives

At least one person should be familiar with the site to be sampled. If not, then a presampling site visit should be arranged to acquire site-specific information. If no one is familiar with the site and a presampling site visit cannot be arranged, then the sampling plan must be written so that it can address contingencies that may occur.

Even in those cases in which a detailed sampling plan is authored and a comprehensive knowledge of the site exists, it is unusual for a sampling plan to be implemented exactly as written. Waste-stream changes, inappropriate weather, sampling equipment failure, and problems in gaining access to the waste are some reasons why a sampling plan must be altered. Thus it is always necessary to have at least one experienced sampler as a member of a sampling team.

The sampling plan should address the considerations discussed below.

9.2.2.1 Statistics

A discussion of waste sampling often leads to a discussion of statistics. The goals of waste sampling and statistics are identical, i.e., to make inferences about a parent population based upon the information contained in a sample.

Thus it is not surprising that waste sampling relies heavily upon the highly developed science of statistics and that a sampling/analytical effort usually contains the same elements as does a statistical experiment. Analogously, the Harris pollster collects opinions from randomly chosen people, whereas environmental scientists collect waste at randomly chosen locations or times. The pollster analyzes the information into a useable data base; laboratories analyze waste samples and generate data. Then the unbiased data base is used to draw inferences about the entire population, which for the Harris pollster may be the voting population of a large city, whereas for the environmental scientist the population may mean the entire contents of a landfill.

During the implementation of a waste sampling plan or a statistical experiment, an effort is made to minimize the possibility of drawing incorrect inferences by obtaining samples that are representative of a population. In fact, the term "representative sample" is commonly used to denote a sample that (1) has the properties and chemical composition of the population from which it was collected, and (2) has them in the same average proportions as are found in the population.

In regard to waste sampling, the term "representative sample" can be misleading unless one is dealing with a homogeneous waste from which one sample can represent the whole population. In most cases, it would be best to consider a "representative data base" generated by the collection and analysis of more than one sample that defines the average properties or composition of the waste. A "representative data base" is a more realistic term because the evaluation of most wastes requires numerous samples to determine the average properties or concentrations of parameters in a waste. (The additional samples needed to generate a representative data base can also be used to determine the variability of these properties or concentrations throughout the waste population.)

Statisticians have developed a number of strategies to obtain samples that are unbiased and collectively representative of a population. A detailed discussion of these strategies is presented in Section 9.1 of this chapter. The following discussion of statistical considerations is a less technical summary of these strategies. It was written to complement Section 9.1 and will be most useful after Section 9.1 is read and studied.

Section 9.1 describes three basic sampling strategies: simple random, stratified random, and systematic random sampling. It should be noted that the word random has more than one meaning. When used in statistical discussions, it does not mean haphazard: it means that every part of a waste has a theoretically equal chance of being sampled. Random sampling, which entails detailed planning and painstaking implementation, is distinctly different from haphazard sampling, which may introduce bias into the collection of samples and the resulting data.

Systematic random sampling and authoritative sampling strategies require a substantial knowledge of the waste to ensure that: (1) a cycle or trend in waste composition does not coincide with the sampling locations: or (2) in the case of authoritative sampling, all or most of the assumptions regarding waste composition or generation are true. Because the variabilities of waste composition and the waste generation process are often unknown, systematic random and authoritative sampling strategies are usually not applicable to waste evaluation.

Therefore, for waste sampling, the usual options are simple or stratified random sampling. Of these two strategies, simple random sampling is the option of choice unless: (1) there are known distinct strata divisions) in the waste over time or in space: (2) one wants to prove or disprove that there are distinct time and/or space strata in the waste of interest; or (3) one is collecting a minimum number of samples and desires to minimize the size of a hot spot (area of high concentration) that could go unsampled. If any of these three conditions exists, it may be determined that stratified random sampling would be the optimum strategy. To explain how these strategies can be employed, a few examples follow:

Example 1: Simple Random Sampling of Tanks

A batch manufacturing process had been generating a liquid waste over a period of years and storing it in a large open-top tank. As this tank approached capacity, some of the waste was allowed to overflow to a smaller enclosed tank. This smaller tank allowed for limited access through an inspection port on its top.

Because the on-site tank storage was approaching capacity, it was determined that the waste would have to be disposed of off-site.

The operators of the facility had determined that the waste was a nonhazardous solid waste when the RCRA regulations were first promulgated. However, upon recent passage of more stringent state regulations and concerns of potential liability, the operators determined that they should perform a more comprehensive analysis of the waste.

Because the waste was generated in a batch mode over a period of years, the operators were concerned that the waste composition might have varied between batches and that stratification might have occurred in the tank at unknown and random depths. Based on their knowledge, the operators knew that a grab sample would not suffice and that a sampling program would have to be designed to address the heterogeneity of the waste.

Because the operators intended to dispose of the entire contents of the tank and lacked any specific information regarding stratification and variability of the waste, it was decided that a simple random strategy would be employed. (If the operators had treated portions of the waste differently or had been aware of distinct strata, then stratified random sampling might have been more appropriate.)

The large, unenclosed tank had a diameter of 50 ft, a height of 20 ft, and an approximate volume of 295,000 gal allowed. It was encircled and traversed by catwalks (refer to Figure 9-6), which allowed access to the entire waste surface. The smaller tank had a diameter of 10 ft, a height of 10 ft, and an approximate volume of 6,000 gal: an inspection port located on the top allowed limited access. It was determined that the different construction of the two tanks would require different simple random sampling approaches.

In the case of the large tank, it was decided that vertical composite samples would be collected because the operators were interested in the average composition and variability of the waste and not in determining if different vertical strata existed. It was decided to select points randomly along the circumference (157 ft) and along the radius (25 ft). These numbers, which would constitute the coordinates of the sampling locations, were chosen from a random-number table by indiscriminately choosing a page and then a column on that page. The circumference coordinates were then chosen by proceeding down the column and listing the first 15 numbers that are greater than or equal to 0, but less than or equal to 157. The radius coordinates were chosen by continuing down the column and listing the first 15 numbers that are greater than or equal to 0, but less than or equal to 25. These numbers were paired to form the coordinates that determined the location of the 15 randomly chosen sampling points. These coordinates were recorded in the field notebook (refer to Table 9-3). Because no precision data on waste composition existed prior to sampling, the number of samples (15) was chosen as a conservative figure to more than allow for a sound statistical decision.

The actual samples were collected by employing a sampling device, which was constructed on site from available materials, and a weighted bottle. This device, which was used to access more remote areas of the tank, consisted of a weighted bottle, a rope marked off at 1-ft increments, and a discarded spool that originally contained electrical wire (refer to Figure 9-7).

Samples were collected by a three-person team. The person controlling the weighted bottle walked to the first circumference coordinate (149 ft), while the two persons holding the ropes attached to the spool walked along opposing catwalks toward the center of the tank. The person controlling the

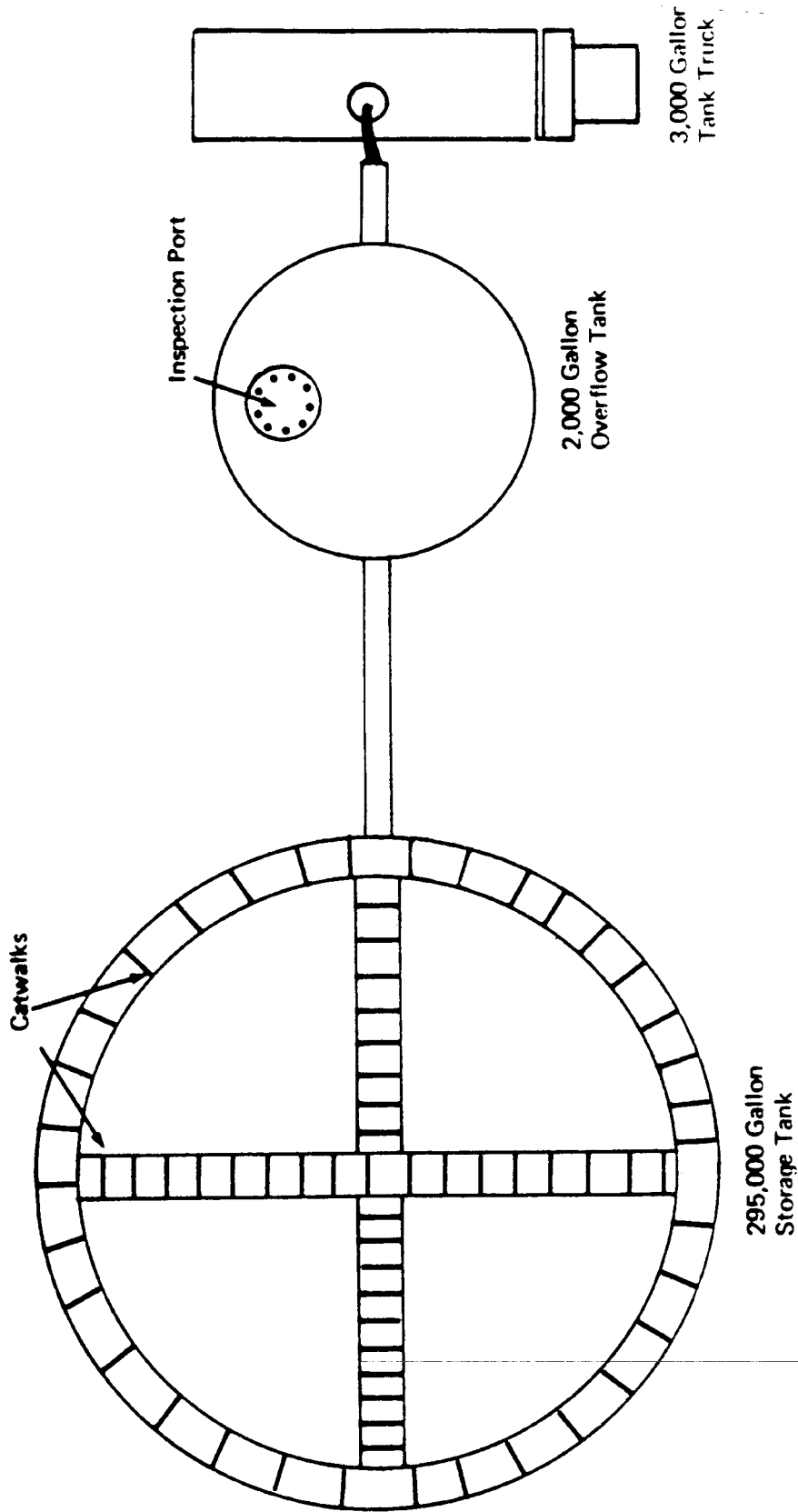

Figure 9-6. Bird's eye view of waste tank, overflow tank, tank truck and connecting plumbing.

TABLE 9-3. RANDOM COORDINATES FOR 295,000-GAL TANK

Sampling Point	Circumference	Radius
1	149	4
2	86	22
3	94	13
4	99	0
5	23	10
6	58	2
7	52	22
8	104	16
9	23	25
10	51	4
11	77	14
12	12	5
13	151	15
14	83	23
15	99	18

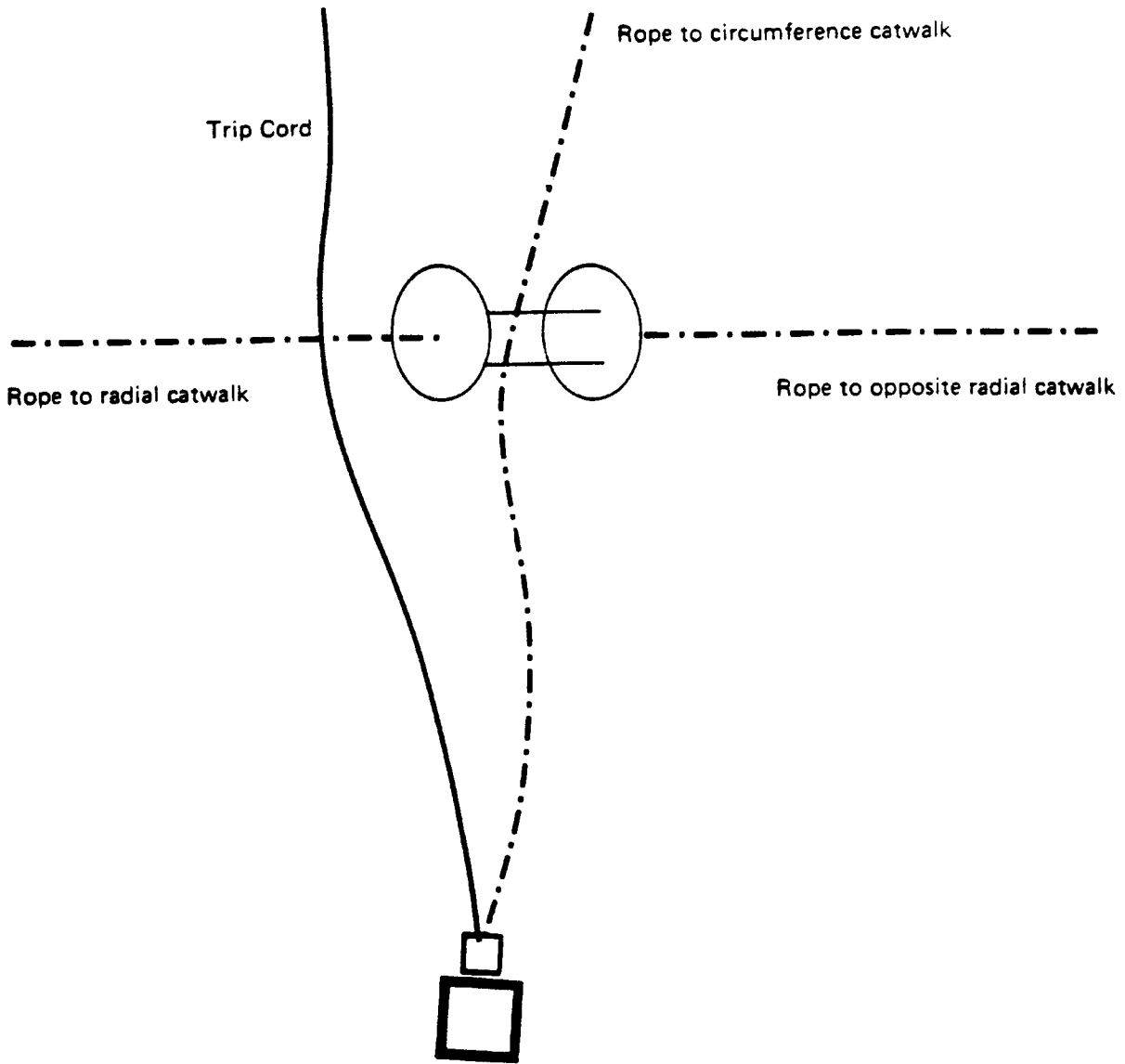

Figure 9-7. Device used to collect sample from the open tank.

weighted bottle measured off the radius coordinate (4 ft). The spool was then centered in the quadrant, the weighted bottle was lowered to the surface, and a sample was collected from the first 2 ft of waste. This sample was then transferred into a large, labeled sample container, which was used for compositing. This same process was repeated nine more times at the same location at different 2-ft depth intervals, resulting in the collection of a total of 10 component depth samples that were compiled in the field into one sample for that sampling point. This process was repeated at the remaining 14 sampling points, resulting in the collection of 15 vertical composite samples. These vertical composite samples were taken to address any vertical stratification that may have occurred.

The samples were properly preserved and stored, chain-of-custody procedures were completed, and the samples were submitted to the laboratory. A cost/benefit decision was made to composite aliquots of the samples into five composite samples that were submitted for analysis. (Following analysis, Equation 8 of Section 9.1 of this chapter was employed to determine if enough samples were analyzed to make a statistically sound decision. If the number of samples analyzed was not sufficient, then the samples would be recomposited to a lesser degree or analyzed individually.)

Because there was no information to prove that the waste in the smaller tank was the same as that in the larger tank, the operators decided that the smaller tank must also be sampled. The different construction of the smaller, enclosed tank mandated that a different sampling plan be designed. The only access to the tank was through a small inspection port on the top of the tank. This port would allow sampling only of a small portion of the tank contents; thus, to make a decision on the entire contents of the tank, one would have to assume that the waste in the vicinity of the inspection port was representative of the remainder of the tank contents. The operators were not willing to make this assumption because they determined that the liability of an incorrect decision overrode the convenience of facilitating the sampling effort.

To randomly sample the entire contents of the tank, a different plan was designed. This plan exploited the relatively small volume (approximately 6,000 gal) of the tank. A decision was made to rent two tank trucks and to sample the waste randomly over time as it drained from the tank into the tank trucks.

It was calculated that at a rate of 20 gal/min, it would take 300 min to drain the tank. From the random-number tables, 15 numbers that were greater than or equal to 0, but less than or equal to 300, were chosen in a manner similar to that employed for the larger tank. These numbers were recorded in the field notebook (refer to Table 9-4) at the time that they were encountered in the random-number table and were then assigned sampling point numbers according to their chronological order.

The 15 samples were collected at the previously chosen random times as the waste exited from a drainage hose into the tank trucks. These samples were collected in separate labeled containers, properly preserved and stored; chain-of-custody procedures were employed for transferral of the samples to the laboratory.

TABLE 9-4. RANDOM TIMES FOR 6,000-GAL TANK

Sampling point	Time (min)
11	153
10	122
8	85
6	55
5	46
15	294
12	195
1	5
13	213
9	99
2	29
4	41
7	74
3	31
14	219

The above example employed simple random sampling to determine the average composition and variance of the waste contained in the two tanks. The contents of the large tank were sampled randomly in space, whereas the contents of the smaller tank were sampled randomly over time.

The following example will involve the use of stratified random sampling, which is used when: (1) distinct strata are known to exist or (2) it is not known whether different strata exist, but an objective of the sampling effort is to discover the existence or nonexistence of strata.

A variation of this second reason for employing stratified random sampling is when cost considerations limit the number of samples that can be collected (e.g., when the budget allows for the collection of only six samples in a 40-acre lagoon). In this situation, where little is known about the composition of the waste, a concern exists that an area of the lagoon may be highly contaminated and yet may not be sampled. The smaller the number of samples, the greater the probability that an area of high contamination (a distinct stratum) could be missed, and the greater the probability that the sampling accuracy will suffer. Under such circumstances, a sampling plan may employ stratified random sampling to minimize the size of a highly contaminated area that could go unsampled.

For example, consider the situation where the budget allows only for the collection of six samples in a 40-acre lagoon. If simple random sampling is employed with such a small number of samples, there is a certain probability that large areas of the lagoon may go unsampled. One approach to minimizing the size of areas that may go unsampled is to divide the lagoon into three strata of equal size and randomly sample each stratum separately. This approach decreases the size of an area that can go unsampled to something less than one-third of the total lagoon area.

The following example details more traditional applications of stratified random sampling.

Example 2: Stratified Random Sampling of Effluents and Lagoons

A pigment manufacturing process has been generating wastes over a number of years. The pigment is generated in large batches that involve a 24-hr cycle. During the first 16 hr of the cycle, an aqueous sludge stream is discharged. This waste contains a high percentage of large-sized black particulate matter. The waste generated during the remaining 8 hr of the manufacturing cycle is an aqueous-based white sludge that consists of much smaller-sized particles than those found in the sludge generated in the first 16 hr of the batch process. This waste has been disposed of over the years into a 40-acre settling lagoon, allowing the particulate matter to settle out of solution while the water phase drains to an NPDES outfall at the opposite end of the lagoon. The smaller white pigment particles released in the last 8 hr of the batch process settle more slowly than the much larger black particles generated in the previous 16 hr. This settling pattern is quite apparent from the distinct colors of the wastes. The sludge in the quadrant closest to the waste influent pipe is black; the next quadrant is a light gray color, resulting from settling of both waste streams. The last two quadrants contain a pure white sludge, resulting from the settling of the small pigment particles.

Eventually, the facility operators decided that the settled particulate matter had to be removed to keep the settling lagoon functioning. In the past, this residual lagoon waste was found to be a hazardous waste due to its leachable barium content. Further studies determined that the source of the barium was a certain raw material that was released during the first 16 hr of batch process.

To minimize present disposal costs, the operators wanted to determine if the white sludge in the last two quadrants and the light gray waste were nonhazardous. Also, the operators had recently changed raw materials, with the intention of removing the source of barium in an attempt to minimize future disposal costs. Thus, the operators were interested in determining whether the currently generated waste was hazardous. If the altered waste stream was not hazardous, future lagoon sludge could be disposed of more economically as a solid waste. If the waste generated during the first 16 hr of the process remained hazardous but the waste generated during the following 8 hr was nonhazardous, the operators were willing to shift this latter waste to a second lagoon reserved for nonhazardous wastes. By sequestering the waste streams in this manner, the operators intended to decrease the amount of hazardous waste by precluding generation of additional amounts of hazardous waste under the "mixture rule."

To decide how the lagoon sludge should be handled, the operators arranged to have the lagoon sludge sampled. The objectives of sampling the lagoon sludge were to determine the average concentration and variance of leachable barium for the sludge in the entire lagoon and for each of the different sludges.

The dimensions of the 40-acre square lagoon were calculated to be 1,320 ft on a side, with the black and the gray sludge each covering a quadrant measuring 1,320 ft by 330 ft, and the white sludge covering the remaining area of the lagoon, which measured 1,320 ft by 660 ft (refer to Figure 9-8). The sludge had settled to a uniform thickness throughout the lagoon and was covered with 2 ft of water.

Because the leachable barium was assumed to be associated with the black sludge, which was concentrated in the first quadrant, a stratified random sampling approach was chosen. (Because of the obvious strata in the lagoon sludge, the stratified sampling strategy was expected to give a more precise estimate of the leachable barium, in addition to giving information specific to each stratum.)

When the actual sampling was being planned, it was decided that the hazards presented by the lagoon waste were minimal, and, that if proper precautions were employed, a stable and unsinkable boat could be used to collect samples. The samples were collected with a core sampler at random locations throughout each stratum. Because the cost of collecting samples was reasonable and no historical data were available to help determine the optimum number of samples, the operators decided to collect a total of 10 samples from each of the smaller strata and a total of 20 samples from the larger strata. They had confidence that this number of samples would allow them to detect a small significant difference between the mean concentration of leachable barium and the applicable regulatory threshold.

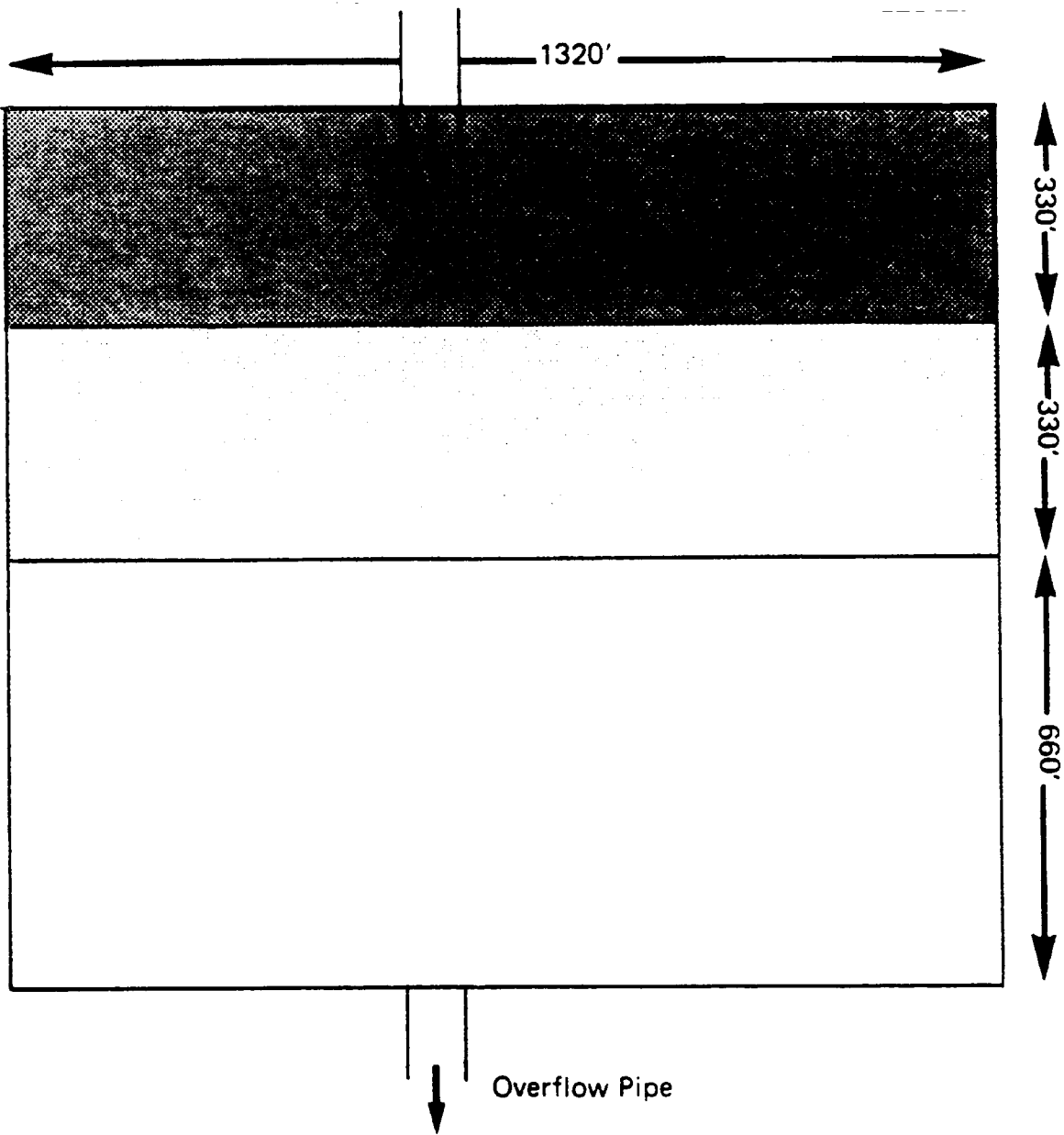

Figure 9-8. Schematic of the 40-acre settling lagoon displaying strata generated by a waste stream.

The locations of the random sampling points were determined by selecting length and width coordinates from a random-number table. This was done by indiscriminately choosing a page from the random-number tables and then a column on that page. The width coordinates of the two smaller quadrants were then chosen by proceeding down the column and listing the first 20 numbers that were greater than or equal to 0, but less than or equal to 330. The width coordinate for the third and largest stratum was chosen by proceeding down the column and selecting the first 20 numbers that were greater than or equal to 0, but less than or equal to 660. Because the lengths of the three quadrants were all 1,320 ft, the length coordinates were chosen by listing the first 40 numbers that were greater than or equal to 0 but less than or equal to 1,320. These coordinates were recorded in the field notebook (refer to table 9-5).

The samples were collected by a four-person team. Two people remained onshore while two maneuvered the boat and collected the samples. The first sample in the first quadrant was collected by launching the boat at a distance of 41 ft from the corner, which was designated the origin, 0 ft. The boat proceeded out into the lagoon perpendicular to the long side of the quadrant. The person onshore released 134 ft of a measured rope, which allowed the boat to stop at the first sampling point (41, 134). The sample was then collected with a core sampler and transferred to a sample container. This process was repeated for all sampling points in the three strata. The samples were properly preserved and stored, and the chain-of-custody records documented the transfer of samples to the laboratory.

Aliquots of the samples were composited into five composite samples for each stratum. The mean and variance of each stratum were calculated by Equations 2(a) and 3(a), respectively. The mean and variance for the total lagoon were calculated by using Equations 2(b) and 3(b), respectively. Equation 6 was used to calculate a confidence interval for the leachable barium concentration, and the upper limit of this interval was compared with the regulatory threshold. (See Table 9-1, Section 9.1 of this chapter, for equations.)

As previously mentioned, the operators had recently changed their raw materials and were also interested in discovering if the currently generated waste was nonhazardous or if portions of this waste stream were nonhazardous. As described above, the waste effluent for the first 16 hr of the day was different from that discharged during the last 8 hr. However, because the same large plumbing system was used for both waste streams, there were two 2-hr periods during which the discharged waste was a mixture of the two different wastes.

With the above objectives in mind, the operators decided to employ stratified random sampling with four strata occurring over time, as opposed to the strata in space that were employed for sampling the lagoon. The four time strata were from 6:00 to 8:00 hr, from 8:00 to 20:00 hr, from 20:00 to 22:00 hr, and from 22:00 to 6:00 hr the following day. The two 2-hr strata were those time periods during which the waste was a mixture of the two different waste streams. The 12-hr stratum was the time period during which the large-sized particulate black waste was being discharged. The smaller particulate white waste was being discharged during the 8-hr stratum.

TABLE 9-5. RANDOM COORDINATES FOR EACH STRATUM
IN THE 40-ACRE SETTLING LAGOON

	Sampling Point	Length (ft)	Width (ft)
<u>Stratum #1</u> (Black)	1	41	134
	2	271	51
	3	968	32
	4	129	228
	5	472	137
	6	1,198	56
	7	700	261
	8	286	8
	9	940	26
	10	151	121
<u>Stratum #2</u> (Gray)	1	1,173	109
	2	277	2
	3	438	302
	4	780	5
	5	525	135
	6	50	37
	7	26	127
	8	1,207	149
	9	1,231	325
	10	840	32
<u>Stratum #3</u> (White)	1	54	374
	2	909	434
	3	1,163	390
	4	1,251	449
	5	1	609
	6	1,126	140
	7	717	235
	8	1,155	148
	9	668	433
	10	66	642
	11	462	455
	12	213	305
	13	1,220	541
	14	1,038	644
	15	508	376
	16	1,293	270
	17	30	38
	18	114	52
	19	1,229	570
	20	392	613

The flow rate was constant throughout the 24-hr period, and there were no precision data available for the waste. Therefore, it was decided that the number of samples collected in the 8- and 12-hr strata would be proportional to time. Because the 2-hr periods were times during which the composition of the waste was changing, it was decided to collect more samples to get a more precise estimate of the average composition of the waste during these time strata. Thus a total of 28 samples was collected.

The samples were collected at randomly chosen times within each time stratum. The random sampling times were chosen by employing a random-number table. After indiscriminately selecting a starting point, the first four numbers greater than or equal to 0, but less than or equal to 120 were selected for the 120-min strata from 6:00 to 8:00 hr. These minutes were then added to the starting time to determine when the four samples would be collected. In similar fashion, the remaining 24 sampling times were chosen. The random-number data were recorded in a laboratory notebook (refer to Table 9-6).

The samples were collected from the waste influent pipe with a wide-mouth bottle at the randomly chosen sampling times. The samples were properly preserved and stored and shipped to the laboratory, along with chain-of-custody records. The samples were subjected to analysis, and the data were evaluated in a manner similar to that employed for the samples of sludge collected in the different strata of the lagoon.

9.2.2.2 Waste

The sampling plan must address a number of factors in addition to statistical considerations. Obviously, one of the most important factors is the waste itself and its properties. The following waste properties are examples of what must be considered when designing a sampling plan:

1. Physical state: The physical state of the waste will affect most aspects of a sampling effort. The sampling device will vary according to whether the sample is liquid, gas, solid, or multiphasic. It will also vary according to whether the liquid is viscous or free-flowing, or whether the solid is hard or soft, powdery, monolithic, or clay-like.

Wide-mouth sample containers will be needed for most solid samples and for sludges or liquids with substantial amounts of suspended matter. Narrow-mouth containers can be used for other wastes, and bottles with air-tight closures will be needed for gas samples or gases adsorbed on solids or dissolved in liquids.

The physical state will also affect how sampling devices are deployed. A different plan will be developed for sampling a soil-like waste that can easily support the weight of a sampling team and its equipment than for a lagoon filled with a viscous sludge or a liquid waste.

TABLE 9-6. RANDOM TIMES FOR THE WASTE EFFLUENT

	Sampling Point	Random Minute	Time
<u>Stratum #1</u> (6:00 to 8:00 hours)	1	28	6:28
	2	62	7:02
	3	99	7:39
	4	112	7:52
<u>Stratum #2</u> (8:00 to 20:00 hours)	1	11	8:11
	2	107	9:47
	3	156	10:36
	4	173	10:53
	5	296	12:56
	6	313	13:13
	7	398	14:38
	8	497	16:17
	9	555	17:15
	10	600	18:00
	11	637	18:37
	12	706	19:46
<u>Stratum #3</u> (20:00 to 22:00 hours)	1	13	20:13
	2	52	20:52
	3	88	21:28
	4	108	21:48
<u>Stratum #4</u> (22:00 to 6:00 hours)	1	48	22:48
	2	113	23:53
	3	153	24:33
	4	189	1:09
	5	227	1:47
	6	290	2:49
	7	314	3:14
	8	474	5:44

The sampling strategy will have to vary if the physical state of the waste allows for stratification (e.g., liquid wastes that vary in density or viscosity or have a suspended solid phase), homogenization or random heterogeneity.

2. Volume: The volume of the waste, which has to be represented by the samples collected, will have an effect upon the choice of sampling equipment and strategies. Sampling a 40-acre lagoon requires a different approach from sampling a 4-sq-ft container. Although a 3-ft depth can be sampled with a Coliwasa or a drum thief, a weighted bottle may be required to sample a 50-ft depth.
3. Hazardous properties: Safety and health precautions and methods of sampling and shipping will vary dramatically with the toxicity, ignitability, corrosivity, and reactivity of the waste.
4. Composition: The chosen sampling strategy will reflect the homogeneity, random heterogeneity, or stratification of the waste in time or over space.

9.2.2.3 Site

Site-specific factors must be considered when designing a sampling plan. A thorough examination of these factors will minimize oversights that can affect the success of sampling and prevent attainment of the program objectives. At least one person involved in the design and implementation of the sampling plan should be familiar with the site, or a presampling site visit should be arranged. If nobody is familiar with the site and a visit cannot be arranged, the sampling plan must be written to account for the possible contingencies. Examples of site-specific factors that should be considered follow:

1. Accessibility: The accessibility of waste can vary substantially. Some wastes are accessed by the simple turning of a valve; others may require that an entire tank be emptied or that heavy equipment be employed. The accessibility of a waste at the chosen sampling location must be determined prior to design of a sampling plan.
2. Waste generation and handling: The waste generation and handling process must be understood to ensure that collected samples are representative of the waste. Factors which must be known and accounted for in the sampling plan include: if the waste is generated in batches; if there is a change in the raw materials used in a manufacturing process; if waste composition can vary substantially as a function of process temperatures or pressures; and if storage time after generation may vary.
3. Transitory events: Start-up, shut-down, slow-down, and maintenance transients can result in the generation of a waste that is not representative of the normal waste stream. If a sample was unknowingly collected at one of these intervals, incorrect conclusions could be drawn.

4. Climate: The sampling plan should specify any clothing needed for personnel to accommodate any extreme heat or cold that may be encountered. Dehydration and extensive exposure to sun, insects, or poisonous snakes must be considered.
5. Hazards: Each site can have hazards -- both expected and unexpected. For example, a general understanding of a process may lead a sampling team to be prepared for dealing with toxic or reactive material, but not for dealing with an electrical hazard or the potential for suffocation in a confined space. A thorough sampling plan will include a health and safety plan that will counsel team members to be alert to potential hazards.

9.2.2.4 Equipment

The choice of sampling equipment and sample containers will depend upon the previously described waste and site considerations. For the following reasons, the analytical chemist will play an important role in the selection of sampling equipment:

1. The analytical chemist is aware of the potential interactions between sampling equipment or container material with analytes of interest. As a result, he/she can suggest a material that minimizes losses by adsorption, volatilization, or contamination caused by leaching from containers or sampling devices.
2. The analytical chemist can specify cleaning procedures for sampling devices and containers that minimize sample contamination and cross contamination between consecutive samples.
3. The analytical chemist's awareness of analyte-specific properties is useful in selecting the optimum equipment (e.g., choice of sampling devices that minimize agitation for those samples that will be subjected to analysis for volatile compounds).

The final choice of containers and sampling devices will be made jointly by the analytical chemist and the group designing the sampling plan. The factors that will be considered when choosing a sampling device are:

1. Negative contamination: The potential for the measured analyte concentration to be artificially low because of losses from volatilization or adsorption.
2. Positive contamination: The potential for the measured analyte to be artificially high because of leaching or the introduction of foreign matter into the sample by particle fallout or gaseous air contaminants.
3. Cross contamination: A type of positive contamination caused by the introduction of part of one sample into a second sample during sampling, shipping, or storage.

4. Required sample volume: For physical and/or chemical analysis.
5. "Ease of use" of the sampling device and containers under the conditions that will be encountered on-site. This includes the ease of shipping to and from the site, ease of deployment, and ease of cleaning.
6. The degree of hazard associated with the deployment of one sampling device versus another.
7. Cost of the sampling device and of the labor for its deployment.

This section describes examples of sampling equipment and suggests potential uses for this equipment. Some of these devices are commercially available, but others will have to be fabricated by the user. The information in this section is general in nature and therefore limited.

Because each sampling situation is unique, the cited equipment and applications may have to be modified to ensure that a representative sample is collected and its physical and chemical integrity are maintained. It is the responsibility of those persons conducting sampling programs to make the appropriate modifications.

Table 9-7 contains examples of sampling equipment and potential applications. It should be noted that these suggested sampling devices may not be applicable to a user's situation due to waste- or site-specific factors. For example, if a waste is highly viscous or if a solid is clay-like, these properties may preclude the use of certain sampling devices. The size and depth of a lagoon or tank, or difficulties associated with accessing the waste, may also preclude use of a given device or require modification of its deployment.

The most important factors to consider when choosing containers for hazardous waste samples are compatibility with the waste, cost, resistance to breakage, and volume. Containers must not distort, rupture, or leak as a result of chemical reactions with constituents of waste samples. Thus, it is important to have some idea of the properties and composition of the waste. The containers must have adequate wall thickness to withstand handling during sample collection and transport to the laboratory. Containers with wide mouths are often desirable to facilitate transfer of samples from samplers to containers. Also, the containers must be large enough to contain the optimum sample volume.

Containers for collecting and storing hazardous waste samples are usually made of plastic or glass. Plastics that are commonly used to make the containers include high-density or linear polyethylene (LPE), conventional polyethylene, polypropylene, polycarbonate, Teflon FEP (fluorinated ethylene propylene), polyvinyl chloride (PVC), or polymethylpentene. Teflon FEP is almost universally usable due to its chemical inertness and resistance to breakage. However, its high cost severely limits its use. LPE, on the other hand, usually offers the best combination of chemical resistance and low cost when samples are to be analyzed for inorganic parameters.

TABLE 9-7. EXAMPLES OF SAMPLING EQUIPMENT FOR PARTICULAR WASTE TYPES

Waste Type	Waste Location or Container								
	Drum	Sacks and Bags	Open-bed Truck	Closed-Bed Truck	Storage Tanks or Bins	Waste Piles	Ponds, Lagoons, & Pits	Convey-or Belt	Pipe
Free-flowing liquids and slurries	Coliwasa	N/A	N/A	Coliwasa	Weighted bottle	N/A	Dipper	N/A	Dipper
Sludges	Trier	N/A	Trier	Trier	Trier	a	a		
Moist powders or granules	Trier	Trier	Trier	Trier	Trier	Trier	Trier	Shovel	Dipper
Dry powders or granules	Thief	Thief	Thief	Thief	a	Thief	Thief	Shovel	Dipper
Sand or packed powders and granules	Auger	Auger	Auger	Auger	Thief	Thief	a	Dipper	Dipper
Large-grained solids	Large Trier	Large Trier	Large Trier	Large Trier	Large Trier	Large Trier	Large Trier	Trier	Dipper

^a This type of sampling situation can present significant logistical sampling problems, and sampling equipment must be specifically selected or designed based on site and waste conditions. No general statement about appropriate sampling equipment can be made.

Glass containers are relatively inert to most chemicals and can be used to collect and store almost all hazardous waste samples, except those that contain strong alkali and hydrofluoric acid. Glass soda bottles are suggested due to their low cost and ready availability. Borosilicate glass containers, such as Pyrex and Corex, are more inert and more resistant to breakage than soda glass, but are expensive and not always readily available. Glass containers are generally more fragile and much heavier than plastic containers. Glass or FEP containers must be used for waste samples that will be analyzed for organic compounds.

The containers must have tight, screw-type lids. Plastic bottles are usually provided with screw caps made of the same material as the bottles. Buttress threads are recommended. Cap liners are not usually required for plastic containers. Teflon cap liners should be used with glass containers supplied with rigid plastic screw caps. (These caps are usually provided with waxed paper liners.) Teflon liners may be purchased from plastic specialty supply houses (e.g., Scientific Specialties Service, Inc., P.O. Box 352, Randallstown, Maryland 21133). Other liners that may be suitable are polyethylene, polypropylene, and neoprene plastics.

If the samples are to be submitted for analysis of volatile compounds, the samples must be sealed in air-tight containers.

Prior to sampling, a detailed equipment list should be compiled. This equipment list should be comprehensive and leave nothing to memory. The categories of materials that should be considered are:

1. Personnel equipment, which will include boots, rain gear, disposable coveralls, face masks and cartridges, gloves, etc.
2. Safety equipment, such as portable eyewash stations and a first-aid kit.
3. Field test equipment, such as pH meters and Draeger tube samplers.
4. An ample supply of containers to address the fact that once in the field, the sampling team may want to collect 50% more samples than originally planned or to collect a liquid sample, although the sampling plan had specified solids only.
5. Additional sampling equipment for use if a problem arises, e.g., a tool kit.
6. Shipping and office supplies, such as tape, labels, shipping forms, chain-of-custody forms and seals, field notebooks, random-number tables, scissors, pens, etc.

Composite Liquid Waste Sampler (Coliwasa)

The Coliwasa is a device employed to sample free-flowing liquids and slurries contained in drums, shallow tanks, pits, and similar containers. It is especially useful for sampling wastes that consist of several immiscible liquid phases.

The Coliwasa consists of a glass, plastic, or metal tube equipped with an end closure that can be opened and closed while the tube is submerged in the material to be sampled (refer to Figure 9-9).

Weighted Bottle

This sampler consists of a glass or plastic bottle, sinker, stopper, and a line that is used to lower, raise, and open the bottle. The weighted bottle samples liquids and free-flowing slurries. A weighted bottle with line is built to the specifications in ASTM Methods D270 and E300. Figure 9-10 shows the configuration of a weighted-bottle sampler.

Dipper

The dipper consists of a glass or plastic beaker clamped to the end of a two- or three-piece telescoping aluminum or fiberglass pole that serves as the handle. A dipper samples liquids and free-flowing slurries. Dippers are not available commercially and must be fabricated (Figure 9-11).

Thief

A thief consists of two slotted concentric tubes, usually made of stainless steel or brass. The outer tube has a conical pointed tip that permits the sampler to penetrate the material being sampled. The inner tube is rotated to open and close the sampler. A thief is used to sample dry granules or powdered wastes whose particle diameter is less than one-third the width of the slots. A thief (Figure 9-12) is available at laboratory supply stores.

Trier

A trier consists of a tube cut in half lengthwise with a sharpened tip that allows the sampler to cut into sticky solids and to loosen soil. A trier samples moist or sticky solids with a particle diameter less than one-half the diameter of the trier. Triers 61 to 100 cm long and 1.27 to 2.54 cm in diameter are available at laboratory supply stores. A large trier can be fabricated (see Figure 9-13).

Auger

An auger consists of sharpened spiral blades attached to a hard metal central shaft. An auger samples hard or packed solid wastes or soil. Augers are available at hardware and laboratory supply stores.

Scoops and Shovels

Scoops and shovels are used to sample granular or powdered material in bins, shallow containers, and conveyor belts. Scoops are available at laboratory supply houses. Flat-nosed shovels are available at hardware stores.

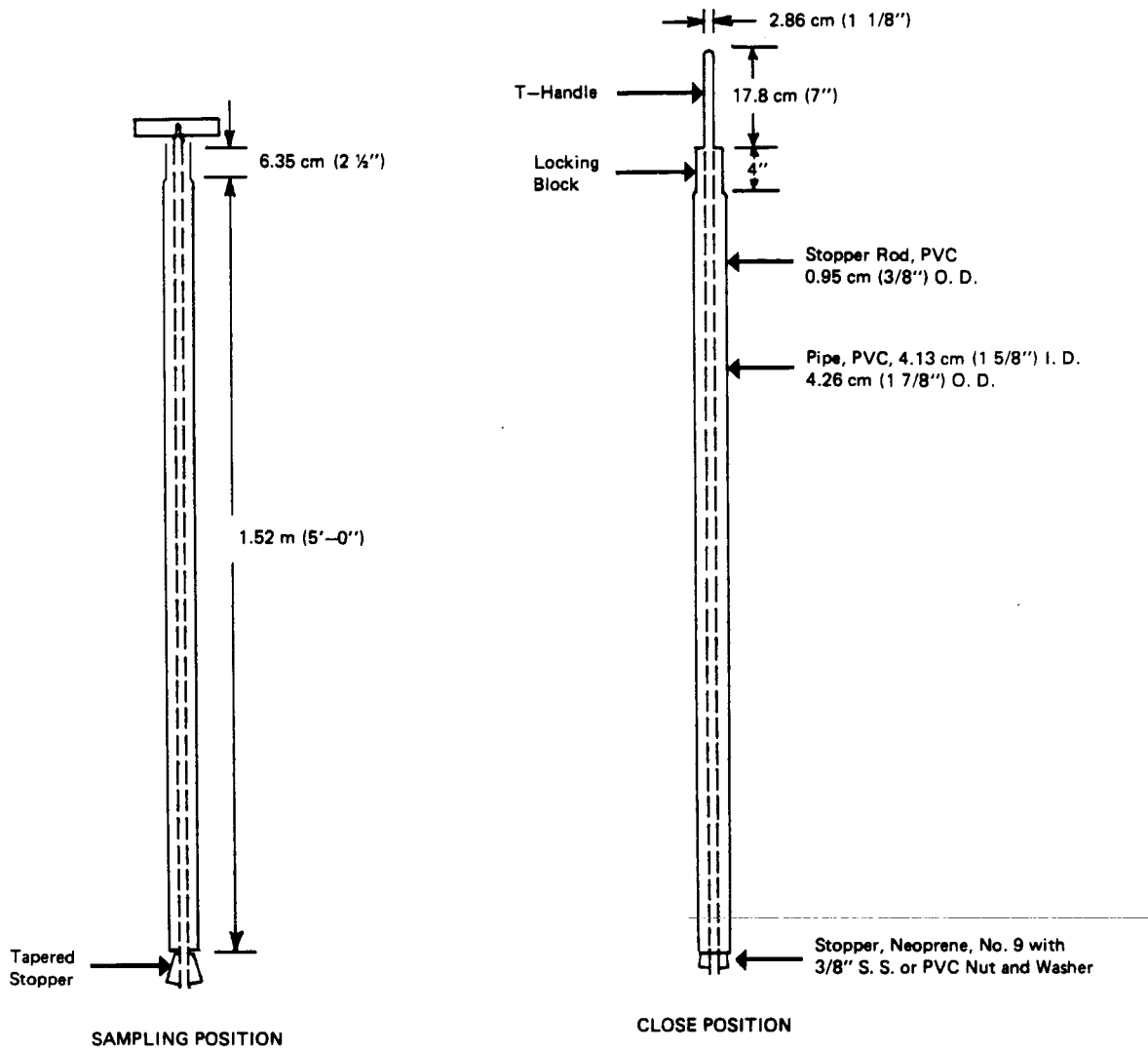

Figure 9-9. Composite liquid waste sampler (Coli-wasa).

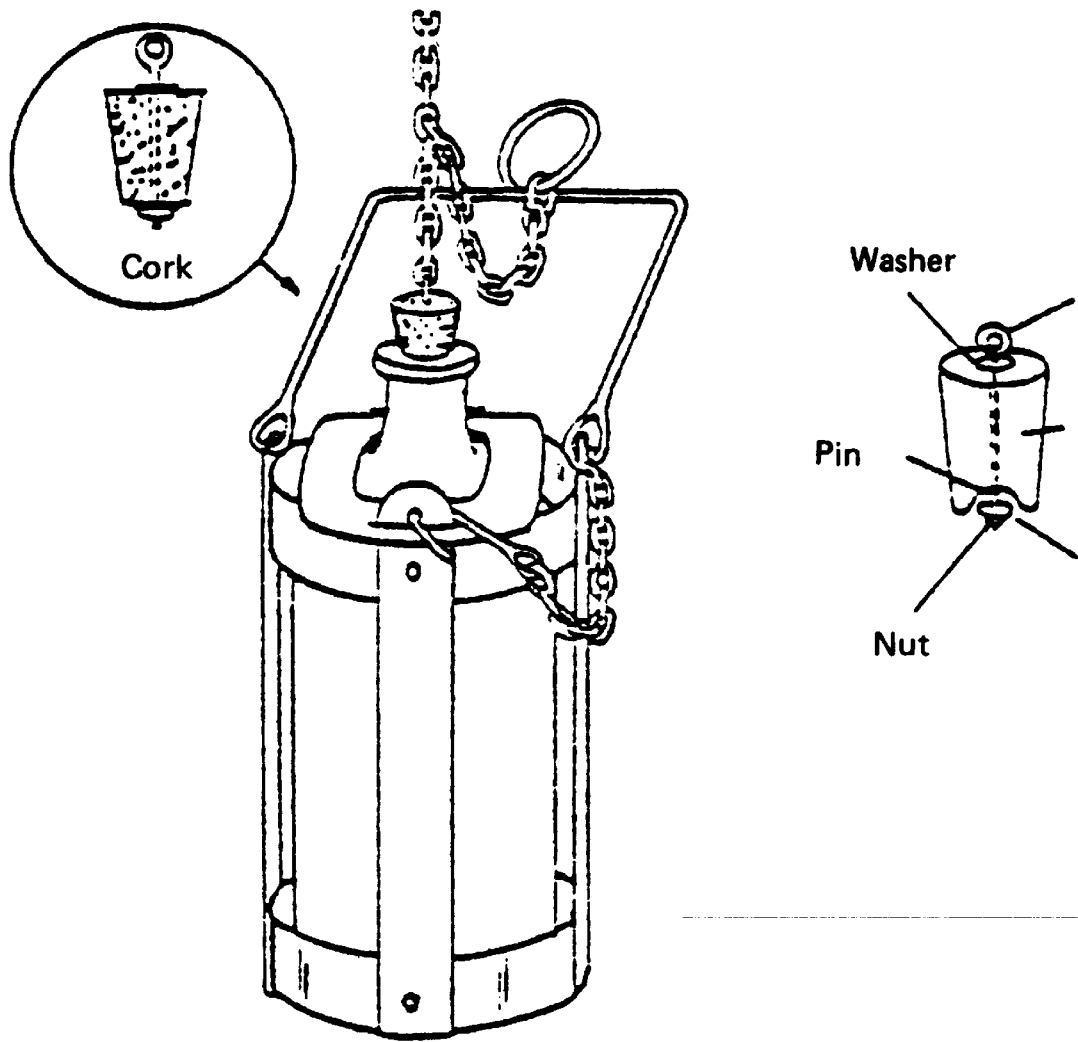

Figure 9-10. Weighted bottle sampler.

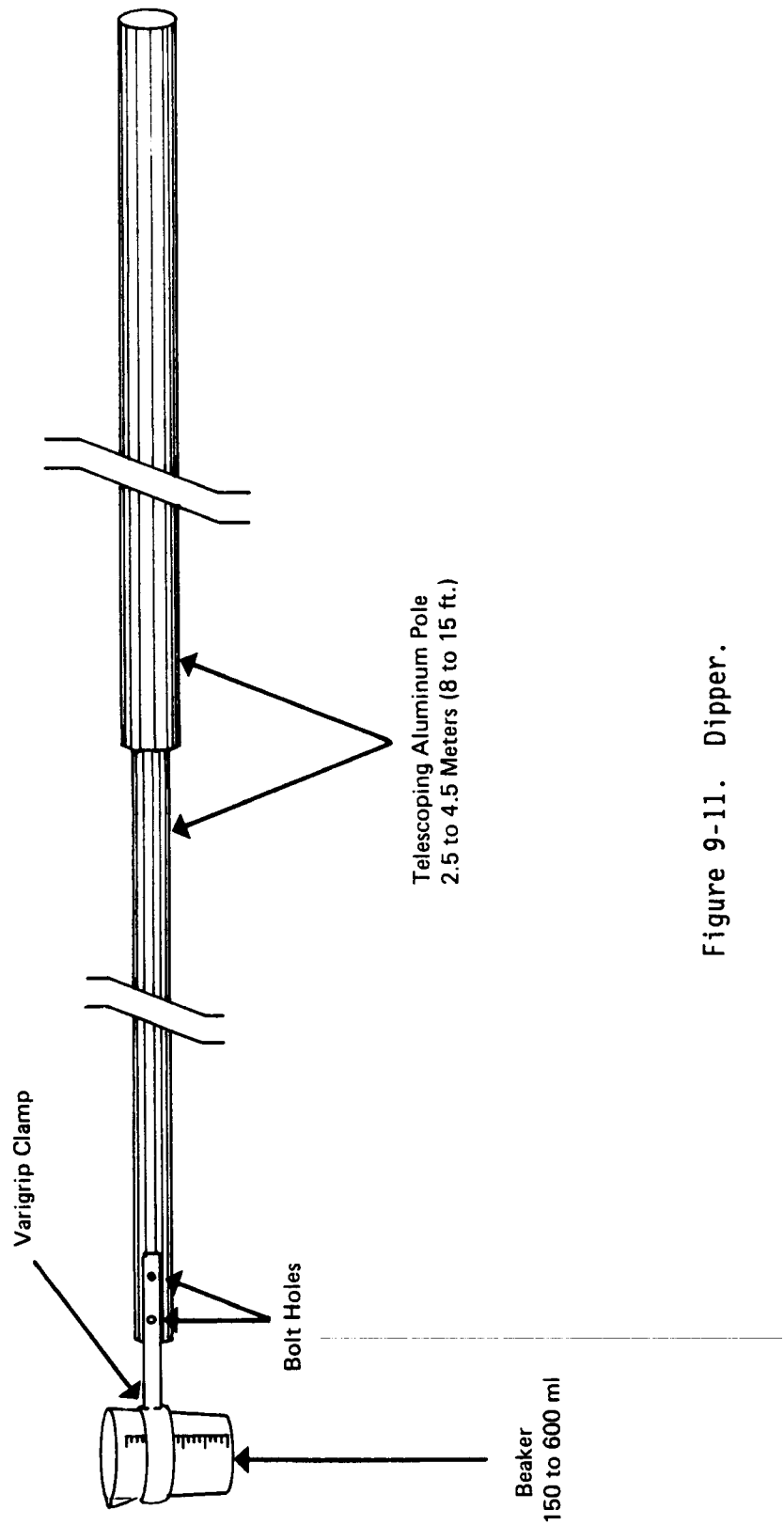

Figure 9-11. Dipper.

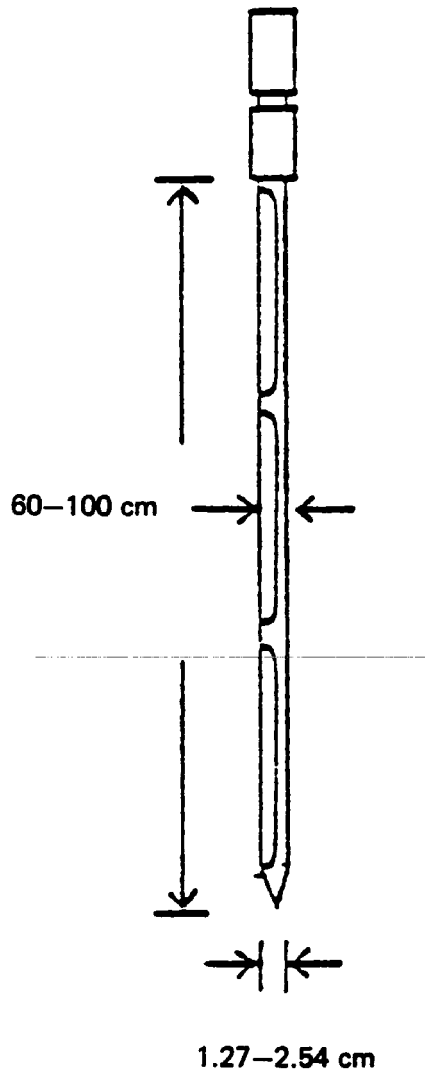

Figure 9-12. Thief sampler.

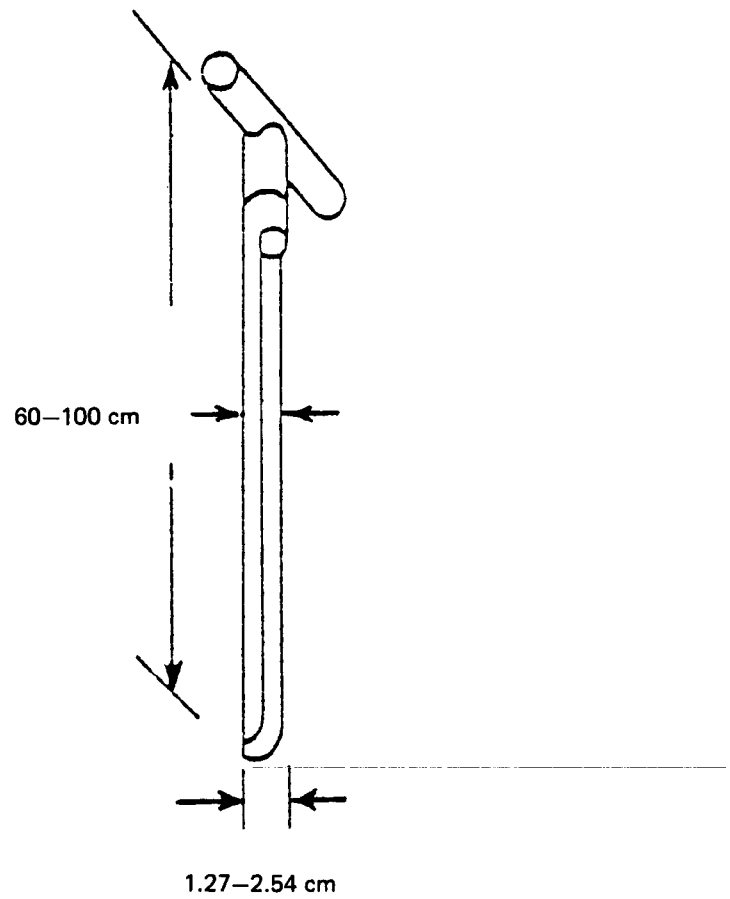
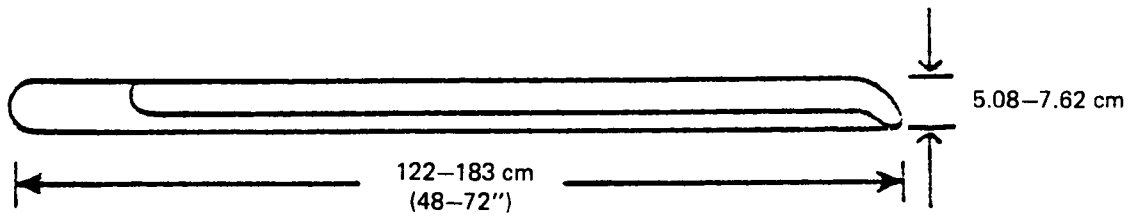

Figure 9-13. Sampling triers.

Bailer

The bailer is employed for sampling well water. It consists of a container attached to a cable that is lowered into the well to retrieve a sample. Bailers can be of various designs. The simplest is a weighted bottle or basally capped length of pipe that fills from the top as it is lowered into the well. Some bailers have a check valve, located at the base, which allows water to enter from the bottom as it is lowered into the well. When the bailer is lifted, the check valve closes, allowing water in the bailer to be brought to the surface. More sophisticated bailers are available that remain open at both ends while being lowered, but can be sealed at both top and bottom by activating a triggering mechanism from the surface. This allows more reliable sampling at discrete depths within a well. Perhaps the best known bailer of this latter design is the Kemmerer sampler.

Bailers generally provide an excellent means for collecting samples from monitoring wells. They can be constructed from a wide variety of materials compatible with the parameter of interest. Because they are relatively inexpensive, bailers can be easily dedicated to an individual well to minimize cross contamination during sampling. If not dedicated to a well, they can be easily cleaned to prevent cross contamination. Unfortunately, bailers are frequently not suited for well evacuation because of their small volume.

Suction Pumps

As the name implies, suction pumps operate by creating a partial vacuum in a sampling tube. This vacuum allows the pressure exerted by the atmosphere on the water in the well to force water up the tube to the surface. Accordingly, these pumps are located at the surface and require only that a transmission tube be lowered into the well. Unfortunately, their use is limited by their reliance on suction to depths of 20 to 25 ft, depending on the pump. In addition, their use may result in out-gassing of dissolved gases or volatile organics and is therefore limited in many sampling applications. In spite of this, suction methods may provide a suitable means for well evacuation because the water remaining in the well is left reasonably undisturbed.

A variety of pumps that operate on this principle are available, but the ones most commonly suggested for monitoring purposes are the centrifugal and peristaltic pumps. In the centrifugal pump, the fluid is displaced by the action of an impeller rotating inside the pump chamber. This discharges water by centrifugal force. The resulting pressure drop in the chamber creates a suction and causes water to enter the intake pipe in the well. These pumps can provide substantial yields and are readily available and inexpensive. The disadvantages are that they require an external power source and may be difficult to clean between sampling events. In addition, the materials with which these pumps are constructed may frequently be incompatible with certain sample constituents. However, their substantial pumping rates make them suitable for well evacuation.

Peristaltic pumps operate in a manner similar to centrifugal pumps but displace the fluid by mechanical peristalsis. A flexible transmission line is mounted around the perimeter of the pump chamber, and rotating rollers compress the tubing, forcing fluid movement ahead (the peristaltic effect) and inducing suction behind each roller. This design isolates the sample from the moving part of the pump and allows for easy cleaning by removal and replacement of the flexible tubing. Unfortunately, peristaltic pumps are generally capable of providing only relatively low yields. They are, therefore, not ideally suited to well evacuation.

Positive Displacement Pumps

A variety of positive displacement pumps are available for use in withdrawing water from wells. These methods utilize some pumping mechanism, placed in the well, that forces water from the bottom of the well to the surface by some means of positive displacement. This minimizes the potential for aerating or stripping volatile organics from the sample during removal from the well.

The submersible centrifugal pump is one common example of a positive displacement pump. It works in a manner similar to the centrifugal suction lift pump previously described, except that, in this case, both the pump and electric motor are lowered into the well. As the impeller rotates and fluid is brought into the pump, fluid is displaced up the transmission line and out of the well. These pumps are capable of providing a high yield. However, they require an external source of power and are frequently constructed with materials and contain lubricants incompatible with certain sample constituents, particularly organics. They also require considerable equipment and effort to move from well to well. Cleaning between sampling events is difficult as well, and, until recently, they have not been available for well diameters smaller than 3 in.

Piston-driven or reciprocating piston pumps are another example of common positive displacement pumps. These pumps consist of a piston in a submerged cylinder operated by a rod connected to the drive mechanism at the surface. A flap valve or ball-check valve is located immediately above or below the piston cylinder. As the piston is lowered in the cylinder, the check valve opens, and water fills the chamber. On the upstroke, the check valve closes, and water is forced out of the cylinder, up into the transmission line, and to the surface. The transmission line or piston contains a second check valve that closes on the downstroke, preventing water from re-entering the cylinder. These pumps are capable of providing high yields. However, moving these pumps from well to well is difficult, and their use in monitoring programs may require that a pump be dedicated to each well. Many of these pumps may not be constructed with materials compatible with monitoring certain constituents.

A special adaptation of this pump has recently become available for use in ground water monitoring. These piston pumps use compressed gas, rather than a rod connected to a driving mechanism at the surface, to drive the pistons. This provides a much more convenient and portable means for collecting samples from monitoring wells. Compressed-gas pumps provide good yields and can be constructed with materials compatible with many sampling programs.

Another positive displacement pump applicable for monitoring purposes is the gas-operated squeeze pump. This pump was originally developed by R. F. Middleburg of the U.S.G.S. and consequently is referred to as the Middleburg pump. It consists principally of a collapsible membrane inside a long, rigid housing, a compressed gas supply, and appropriate control valves. When the pump is submerged, water enters the collapsible membrane through the bottom check valve. After the membrane has filled, gas pressure is applied to the annular space between the rigid housing and membrane, forcing the water upward through a sampling tube. When the pressure is released, the top check valve prevents the sample from flowing back down the discharge line, and water from the well again enters the pump through the bottom check valve.

Gas-operated squeeze pumps offer a number of advantages for use in ground water monitoring programs. They can be constructed in diameters as small as 1 in. and from a wide variety of materials. They are also relatively portable and are capable of providing a fair range of pumping rates. Most important, the driving gas does not contact the water sample, so that possible contamination or gas stripping does not occur. However, they do require a gas source, and withdrawal of water from substantial depths may require large gas volumes and long pumping cycles.

Jet pumps, a common type of submersible pump used in small domestic water wells, may in some cases be suggested for use in monitoring wells. These pumps operate by injecting water through a pipe down into the well. A venturi device is located at the intake portion of the pump. As the water injected from the surface passes through the constricted portion of the venturi, the velocity increases and pressures decrease according to Bernoulli's principle. If the discharge velocity at the nozzle is great enough, the pressure at this point will be lowered sufficiently to draw water into the venturi assembly through the intake and to bring it to the surface with the original water injected into the well. This additional increment of water is then made available at the surface as the pump's output. Because jet pumps require priming with water and because the water taken from the well mixes with water circulating in the system, they are clearly not applicable to collecting samples for monitoring purposes. For similar reasons, their use is not recommended for well evacuation.

Pressure-Vacuum Lysimeters

The basic construction of pressure-vacuum lysimeters (Wood, 1973), shown in Figure 9-14, consists of a porous ceramic cup, with a bubbling pressure of 1 bar or greater, attached to a short piece of PVC pipe of suitable diameter. Two tubes extend down into the device, as illustrated. Data by Silkworth and Grigal (1981) indicate that, of the two commercially available sampler sizes (2.2 and 4.8 cm diameter), the larger ceramic cup sampler is more reliable, influences water quality less, and yields samples of suitable volume for analysis.

Detailed installation instructions for pressure-vacuum lysimeters are given by Parizek and Lane (1970). Significant modification may be necessary to adapt these instruments to field use when heavy equipment is used. To prevent channelling of contaminated surface water directly to the sampling device, the sampler may be installed in the side wall of an access trench. Because random placement procedures may locate a sampler in the middle of an

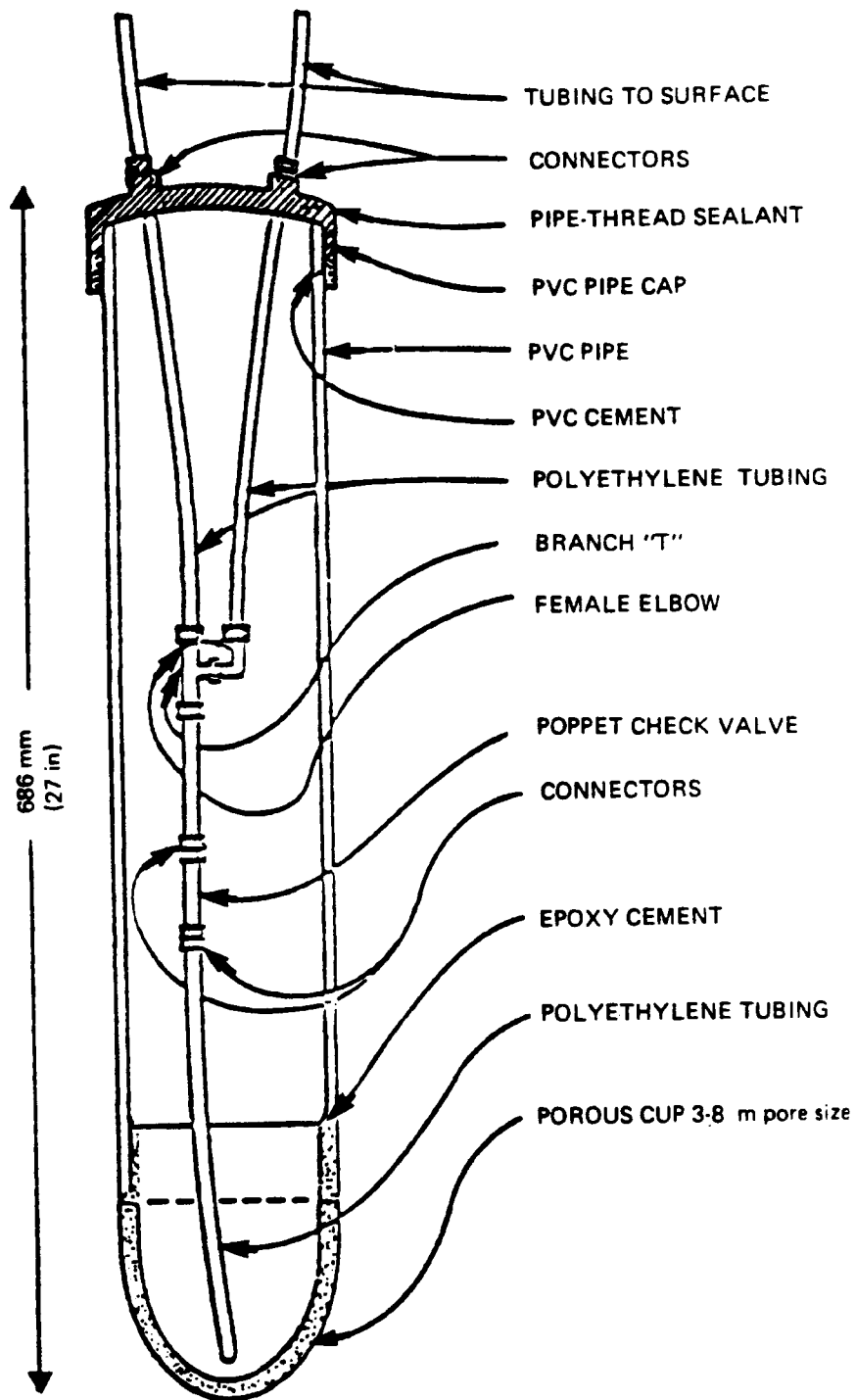

Figure 9-14. One example of a pressure-vacuum lysimeter (Wood, 1973).
 Reprinted by permission of the American Geophysical Union.

active area, the sample collection tube should be protected at the surface from heavy equipment by a manhole cover, brightly painted steel cage, or other structure. Another problem associated with such sampler placement is that its presence may alter waste management activities (i.e., waste applications, tilling, etc., will avoid the location): therefore, the sampler may not yield representative leachate samples. This problem may be avoided by running the collection tube horizontally underground about 10 m before surfacing.

For sampling after the unit is in place, a vacuum is placed on the system and the tubes are clamped off. Surrounding soil water is drawn into the ceramic cup and up the polyethylene tube. To collect the water sample, the vacuum is released, and one tube is placed in a sample container. Air pressure is applied to the other tube, forcing the liquid up the tube and into the sample container. Preliminary testing should ensure that waste products can pass into the ceramic cup. If sampling for organics, an inert tubing, such as one made of Teflon, should be substituted for the polyethylene pipe to prevent organic contamination.

The major advantages of these sampling devices are that they are easily available, relatively inexpensive to purchase and install, and quite reliable. The major disadvantage is the potential for water quality alterations due to the ceramic cup; this possible problem requires further testing. For a given installation, the device chosen should be specifically tested using solutions containing the soluble hazardous constituents of the waste to be land treated. This device is not recommended for volatiles unless a special trap device is used (Hazardous Waste Land Treatment, SW-874).

Vacuum Extractor

Vacuum extractors were developed by Duke and Haise (1973) to extract moisture from soils above the ground water table. The basic device consists of a stainless steel trough that contains ceramic tubes packed in soil. The unit is sized not to interfere with ambient soil water potentials (Corey, 1974); it is installed at a given depth in the soil with a slight slope toward the collection bottle, which is in the bottom of an adjacent access hole. The system is evacuated and moisture is moved from the adjacent soil into the ceramic tubes and into the collection bottle, from which it can be withdrawn as desired. The advantage of this system is that it yields a quantitative estimate of leachate flux as well as provides a water sample for analysis. The volume of collected leachate per unit area per unit time is an estimate of the downward movement of leachate water at that depth. The major disadvantages to this system are: it is delicate; it requires a trained operator; it estimates leachate quantity somewhat lower than actual field drainage; and it disturbs the soil above the sampler. Further details about the use of the vacuum extractor are given by Trout et al. (1975). Performance of this device when installed in clay soils is generally poor.

Trench Lysimeters

Trench lysimeters are named for the large access trench, or caisson, necessary for operation. Basic installation, as described by Parizek and Lane (1970), involves excavating a rather large trench and shoring up the side walls, taking care to leave open areas so that samplers can be placed in the side walls. Sample trays are imbedded in the side walls and connected by tubing to sample collection containers. The entire trench area is then covered to prevent flooding. One significant danger in using this system is the potential for accumulation of hazardous fumes in the trench, possibly endangering the health and safety of the person collecting the samples.

Trench lysimeters function by intercepting downward-moving water and diverting it into a collection device located at a lower elevation. The intercepting agent may be an open-ended pipe, sheet metal trough, pan, or other similar device. Pans 0.9 to 1.2 m in diameter have been successfully used in the field by Tyler and Thomas (1977). Because there is no vacuum applied to the system, only free water in excess of saturation is sampled. Consequently, samples are plentiful during rainy seasons but are nonexistent during the dry season.

Another variation of this system is to use a funnel filled with clean sand inserted into the sidewall of the trench. Free water will drain into a collection chamber, from which a sample is periodically removed by vacuum. A small sample collection device such as this may be preferable to the large trench because the necessary hole is smaller, so that installation is easier (Figure 9-15).

9.2.2.5 Quality Assurance and Quality Control

Quality assurance (QA) can briefly be defined as the process for ensuring that all data and the decisions based on these data are technically sound, statistically valid, and properly documented. Quality control (QC) procedures are the tools employed to measure the degree to which these quality assurance objectives are met.

A data base cannot be properly evaluated for accuracy and precision unless it is accompanied by quality assurance data. In the case of waste evaluation, these quality assurance data result from the implementation of quality control procedures during sampling and analysis. Quality control requirements for specific analytical methods are given in detail in each method in this manual: in this subsection, quality assurance and quality control procedures for sampling will be discussed.

Quality control procedures that are employed to document the accuracy and precision of sampling are:

1. Trip Blanks: Trip blanks should accompany sample containers to and from the field. These samples can be used to detect any contamination or cross-contamination during handling and transportation.
2. Field Blanks: Field blanks should be collected at specified frequencies, which will vary according to the probability of

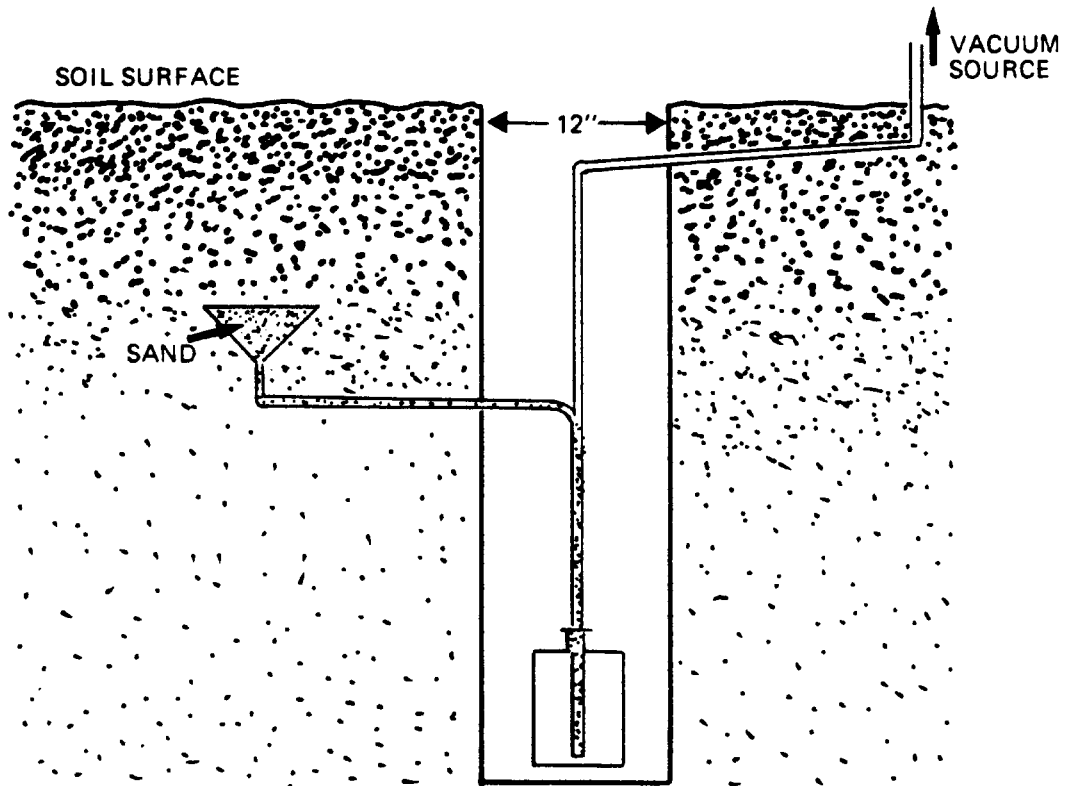

Figure 9-15. Schematic diagram of a sand filled funnel used to collect leachate from the unsaturated zone.

contamination or cross-contamination. Field blanks are often metal- and/or organic-free water aliquots that contact sampling equipment under field conditions and are analyzed to detect any contamination from sampling equipment, cross contamination from previously collected samples, or contamination from conditions during sampling (e.g., airborne contaminants that are not from the waste being sampled).

3. Field Duplicates: Field duplicates are collected at specified frequencies and are employed to document precision. The precision resulting from field duplicates is a function of the variance of waste composition, the variance of the sampling technique, and the variance of the analytical technique.
4. Field Spikes: Field spikes are infrequently used to determine the loss of parameters of interest during sampling and shipment to the laboratories. Because spiking is done in the field, the making of spiked samples or spiked blanks is susceptible to error. In addition, compounds can be lost during spiking, and equipment can be contaminated with spiking solutions. To eliminate these and other problems, some analysts spike blanks or matrices similar to the waste in the laboratory and ship them, along with sample containers, to the field. This approach also has its limitation because the matrix and the handling of the spike are different from those of the actual sample. In all cases, the meaning of a low field-spike recovery is difficult to interpret, and thus, field spikes are not commonly used.

In addition to the above quality control samples, a complete quality assurance program will ensure that standard operating procedures (SOPs) exist for all essential aspects of a sampling effort. SOPs should exist for the following steps in a sampling effort:

1. Definition of objectives (refer to Section 9.2.1).
2. Design of sampling plans (refer to Section 9.2.2).
3. Preparation of containers and equipment (refer to the specific analytical methods).
4. Maintenance, calibration, and cleaning of field equipment (refer to instrument manuals or consult a chemist for cleaning protocols).
5. Sample preservation, packaging, and shipping (refer to the analytical methods and to Section 9.2.2.7).
6. Health and safety protocols (refer to Section 9.2.2.6).
7. Chain-of-custody protocols (refer to Section 9.2.2.7).

In addition to the above protocols, numerous other QA/QC protocols must be employed to document the accuracy of the analytical portion of a waste evaluation program.

9.2.2.6 Health and Safety

Safety and health must also be considered when implementing a sampling plan. A comprehensive health and safety plan has three basic elements: (1) monitoring the health of field personnel; (2) routine safety procedures; and (3) emergency procedures.

Employees who perform field work, as well as those exposed to chemicals in the laboratory, should have a medical examination at the initiation of employment and routinely thereafter. This exam should preferably be performed and evaluated by medical doctors who specialize in industrial medicine. Some examples of parts of a medical examination that ought to be performed are: documentation of medical history; a standard physical exam; pulmonary functions screening; chest X-ray; EKG; urinalysis; and blood chemistry. These procedures are useful to: (1) document the quality of an employee's health at the time of matriculation; (2) ensure the maintenance of good health; and (3) detect early signs of bodily reactions to chemical exposures so they can be treated in a timely fashion. Unscheduled examinations should be performed in the event of an accident, illness, or exposure or suspected exposure to toxic materials.

Regarding safety procedures, personnel should be aware of the common routes of exposure to chemicals (i.e., inhalation, contact, and ingestion) and be instructed in the proper use of safety equipment, such as Draeger tube air samplers to detect air contamination, and in the proper use of protective clothing and respiratory equipment. Protocols should also be defined stating when safety equipment should be employed and designating safe areas where facilities are available for washing, drinking, and eating.

Even when the utmost care is taken, an emergency situation can occur as a result of an unanticipated explosion, electrical hazard, fall, or exposure to a hazardous substance. To minimize the impact of an emergency, field personnel should be aware of basic first aid and have immediate access to a first-aid kit. Phone numbers for both police and the nearest hospital should be obtained and kept by each team member before entering the site. Directions to the nearest hospital should also be obtained so that anyone suffering an injury can be transported quickly for treatment.

9.2.2.7 Chain of Custody

An essential part of any sampling/analytical scheme is ensuring the integrity of the sample from collection to data reporting. The possession and handling of samples should be traceable from the time of collection through analysis and final disposition. This documentation of the history of the sample is referred to as chain of custody.

Chain of custody is necessary if there is any possibility that the analytical data or conclusions based upon analytical data will be used in litigation. In cases where litigation is not involved, many of the chain-of-custody procedures are still useful for routine control of sample flow. The components of chain of custody -- sample seals, a field logbook, chain-of-custody record, and sample analysis request sheet -- and the procedures for their use are described in this section.

A sample is considered is considered to be under a person's custody if it is (1) in a person's physical possession, (2) in view of the person after taking possession, and (3) secured by that person so that no one can tamper with it, or secured by that person in an area that is restricted to authorized personnel. A person who has samples in custody must comply with the following procedures.

(The material presented here briefly summarizes the major aspects of chain of custody. The reader is referred to NEIC Policies and Procedures, EPA-330/9/78/001-R [as revised 1/82], or other manual, as appropriate, for more information.)

Sample labels (Figure 9-16) are necessary to prevent misidentification of samples. Gummed paper labels or tags are adequate and should include at least the following information:

- Sample number.
- Name of collector.
- Date and time of collection.
- Place of collection.

Labels should be affixed to sample containers prior to or at the time of sampling and should be filled out at the time of collection.

Sample seals are used to detect unauthorized tampering of samples following sample collection up to the time of analysis. Gummed paper seals may be used for this purpose. The paper seal should include, minimally, the following information:

- Sample number. (This number must be identical with the number on the sample label.)
- Name of collector.
- Date and time of sampling.
- Place of collection.

The seal must be attached in such a way that it is necessary to break it in order to open the sample container. (An example of an official sample seal is shown in Figure 9-17.) Seals must be affixed to containers before the samples leave the custody of sampling personnel.

All information pertinent to a field survey or sampling must be recorded in a logbook. This should be bound, preferably with consecutively numbered pages that are 21.6 by 27.9 cm (8-1/2 by 11 in.). At a minimum, entries in the logbook must include the following:

- Location of sampling point.
- Name and address of field contact.
- Producer of waste and address, if different from location.
- Type of process producing waste (if known).
- Type of waste (e.g., sludge, wastewater).
- Suspected waste composition, including concentrations.
- Number and volume of sample taken.

Collector _____ Sample No. _____

Place of Collection _____

Date Sampled _____ Time Sampled _____

Field Information _____

Figure 9-16. Example of Sample Label

NAME AND ADDRESS OF ORGANIZATION COLLECTING SAMPLES

Person Collecting Sample _____ Sample No. _____
(signature)

Date Collected _____ Time Collected _____

Place Collected _____

Figure 9-17. Example of Official Sample Seal

Purpose of sampling (e.g., surveillance, contract number).
Description of sampling point and sampling methodology.
Date and time of collection.
Collector's sample identification number(s).
Sample distribution and how transported (e.g., name of laboratory, UPS, Federal Express).
References, such as maps or photographs of the sampling site.
Field observations.
Any field measurements made (e.g., pH, flammability, explosivity).
Signatures of personnel responsible for observations.

Sampling situations vary widely. No general rule can be given as to the extent of information that must be entered in the logbook. A good rule, however, is to record sufficient information so that anyone can reconstruct the sampling without reliance on the collector's memory. The logbook must be stored safely.

To establish the documentation necessary to trace sample possession from the time of collection, a chain-of-custody record should be filled out and should accompany every sample. This record becomes especially important if the sample is to be introduced as evidence in a court litigation. (A chain-of-custody record is illustrated in Figure 9-18.)

The record should contain, minimally, the following information:

Sample number.
Signature of collector.
Date and time of collection.
Place and address of collection.
Waste type.
Signature of persons involved in the chain of possession.
Inclusive dates of possession.

The sample analysis request sheet (Figure 9-19) is intended to accompany the sample on delivery to the laboratory. The field portion of this form is completed by the person collecting the sample and should include most of the pertinent information noted in the logbook. The laboratory portion of this form is intended to be completed by laboratory personnel and to include, minimally:

Name of person receiving the sample.
Laboratory sample number.
Date and time of sample receipt.
Sample allocation.
Analyses to be performed.

The sample should be delivered to the laboratory for analysis as soon as practicable -- usually within 1 or 2 days after sampling. The sample must be accompanied by the chain-of-custody record (Figure 9-18) and by a sample analysis request sheet (Figure 9-19). The sample must be delivered to the person in the laboratory authorized to receive samples (often referred to as the sample custodian).

SAMPLING ANALYSIS REQUEST

Part I: Field Section

Collector _____ Date Sampled _____ Time _____ hours

Affiliation of Sampler _____

Address _____
 number street city state zip

Telephone (____) _____ Company Contact _____

LABORATORY SAMPLE NUMBER	COLLECTOR'S SAMPLE NO.	TYPE OF SAMPLE*	FIELD INFORMATION**
_____	_____	_____	_____
_____	_____	_____	_____
_____	_____	_____	_____
_____	_____	_____	_____

Analysis Requested _____

Special Handling and/or Storage _____

PART II: LABORATORY SECTION**

Received by _____ Title _____ Date _____

Analysis Required _____

* Indicate whether sample is soil, sludge, etc.
** Use back of page for additional information relative to sample location.

Figure 9-19. Example of hazardous waste sample analysis sheet.

Any material that is identified in the DOT Hazardous Material Table (49 CFR 172.101) must be transported as prescribed in the table. All other hazardous waste samples must be transported as follows:

1. Collect sample in a 16-oz or smaller glass or polyethylene container with nonmetallic Teflon-lined screw cap. For liquids, allow sufficient air space, approximately 10% by volume) so that the container is not full at 54°C (130 °F). If collecting a solid material, the container plus contents should not exceed 1 lb net weight. If sampling for volatile organic analysis, fill VOA container to septum but place the VOA container inside a 16-oz or smaller container so that the required air space may be provided. Large quantities, up to 3.785 liters (1 gal), may be collected if the sample's flash point is 23°C (75°F) or higher. In this case, the flash point must be marked on the outside container (e.g., carton or cooler), and shipping paper should state that "Flash point is 73°F or higher."
2. Seal sample and place in a 4-mil-thick polyethylene bag, one sample per bag.
3. Place sealed bag inside a metal can with noncombustible, absorbent cushioning material (e.g., vermiculite or earth) to prevent breakage, one bag per can. Pressure-close the can and use clips, tape, or other positive means to hold the lid securely.
4. Mark the can with:

Name and address of originator.
"Flammable Liquid, N.O.S. UN 1993."
(or, "Flammable Solid, N.O.S. UN 1325".)

NOTE: UN numbers are now required in proper shipping names.

5. Place one or more metal cans in a strong outside container such as a picnic cooler or fiberboard box. Preservatives are not used for hazardous waste site samples.
6. Prepare for shipping: The words "Flammable Liquid, N.O.S. UN 1993" or "Flammable Solid, N.O.S. UN 1325"; "Cargo Aircraft Only" (if more than 1 qt net per outside package); "Limited Quantity" or "Ltd. Qty."; "Laboratory Samples"; "Net Weight ____" or "Net Volume ____" (of hazardous contents) should be indicated on shipping papers and on the outside of the outside shipping container. The words "This Side Up" or "This End Up" should also be on container. Sign the shipper certification.

7. Stand by for possible carrier requests to open outside containers for inspection or to modify packaging. (It is wise to contact carrier before packing to ascertain local packaging requirements.) Remain in the departure area until the carrier vehicle (aircraft, truck, etc.) is on its way.

At the laboratory, a sample custodian should be assigned to receive the samples. Upon receipt of a sample, the custodian should inspect the condition of the sample and the sample seal, reconcile the information on the sample label and seal against that on the chain-of-custody record, assign a laboratory number, log in the sample in the laboratory logbook, and store it in a secured sample storage room or cabinet until it is assigned to an analyst for analysis.

The sample custodian should inspect the sample for any leakage from the container. A leaky container containing a multiphase sample should not be accepted for analysis. This sample will no longer be a representative sample. If the sample is contained in a plastic bottle and the container walls show that the sample is under pressure or releasing gases, the sample should be treated with caution because it may be explosive or release extremely poisonous gases. The custodian should examine whether the sample seal is intact or broken, because a broken seal may mean sample tampering and would make analysis results inadmissible as evidence in court. Any discrepancies between the information on the sample label and seal and the information that is on the chain-of-custody record and the sample analysis request sheet should be resolved before the sample is assigned for analysis. This effort might require communication with the sample collector. Results of the inspection should be noted on the sample analysis request sheet and on the laboratory sample logbook.

Incoming samples usually carry the inspector's or collector's identification numbers. To identify these samples further, the laboratory should assign its own identification numbers, which normally are given consecutively. Each sample should be marked with the assigned laboratory number. This number is correspondingly recorded on a laboratory sample log book along with the information describing the sample. The sample information is copied from the sample analysis request sheet and cross-checked against that on the sample label.

In most cases, the laboratory supervisor assigns the sample for analysis. The supervisor should review the information on the sample analysis request sheet, which now includes inspection notes recorded by the laboratory sample custodian. The technician assigned to analysis should record in the laboratory notebook the identifying information about the sample, the date of receipt, and other pertinent information. This record should also include the subsequent testing data and calculations. The sample may have to be split with other laboratories in order to obtain all the necessary analytical information. In this case, the same type of chain-of-custody procedures must be employed while the sample is being transported and at the other laboratory.

Once the sample has been received in the laboratory, the supervisor or his/her assignee is responsible for its care and custody. That person should be prepared to testify that the sample was in his/her possession or secured in the laboratory at all times, from the moment it was received from the custodian until the analyses were performed.

9.2.3 Sample Plan Implementation

Prior to implementing a sampling plan, it is often strategic to walk through the sampling plan mentally, starting with the preparation of equipment until the time when samples are received at the laboratory. This mental excursion should be in as much detail as can be imagined, because the small details are the ones most frequently overlooked. By employing this technique, items not included on the equipment list may be discovered, as well as any major oversight that could cause the sampling effort to fail. During this review of the sampling plan, an attempt should be made to anticipate what could go wrong. A solution to anticipated problems should be found, and, if necessary, materials needed for solving these problems should be added to the equipment list.

The remainder of this section discusses examples of sampling strategies for different situations that may be encountered.

Containers

Prior to discussing the sampling of containers, the term must be defined. The term container, as used here, refers to receptacles that are designed for transporting materials, e.g., drums and other smaller receptacles, as opposed to stationary tanks. Weighted bottles, Coliwassas, drum thieves, or triers are the sampling devices that are chosen for the sampling of containers. (See Section 9.2.2.4 for a full discussion of sampling equipment.)

The sampling strategy for containers varies according to (1) the number of containers to be sampled and (2) access to the containers. Ideally, if the waste is contained in several containers, every container will be sampled. If this is not possible due to the large number of containers or to cost factors, a subset of individual containers must be randomly selected for sampling. This can be done by assigning each container a number and then randomly choosing a set of numbers for sampling.

Access to a container will affect the number of samples that can be taken from the container and the location within the container from which samples can be taken. Ideally, several samples should be taken from locations displaced both vertically and horizontally throughout the waste. The number of samples required for reliable sampling will vary depending on the distribution of the waste components in the container. At a minimum with an unknown waste, a sufficient number and distribution of samples should be taken to address any possible vertical anomalies in the waste. This is because contained wastes have a much greater tendency to be nonrandomly heterogeneous in a vertical rather than a horizontal direction due to (1) settling of solids and the denser phases of liquids and (2) variation in the content of the waste as it enters the container. Bags, paper drums, and open-headed steel drums (of which the entire top can be removed) generally do not restrict access to the waste and therefore do not limit sampling.

When access to a container is unlimited, a useful strategy for obtaining a representative set of samples is a three-dimensional simple random sampling strategy in which the container is divided by constructing an imaginary three-dimensional grid (see Figure 9-20), as follows. First, the top surface of the waste is divided into a grid whose sections either approximate the size of the sampling device or are larger than the sampling device if the container is large. (Cylindrical containers can be divided into imaginary concentric circles, which are then further divided into grids of equal size.) Each section is assigned a number. The height of the container is then divided into imaginary levels that are at least as large as the vertical space required by the chosen sampling device. These imaginary levels are then assigned numbers. Specific levels and grid locations are then selected for sampling using a random-number table or random-number generator. (an alternative means of choosing random sampling locations using circumference and diameter dimensions is discussed in Section 9.2.2.1.)

Another appropriate sampling approach is the two-dimensional simple random sampling strategy, which can usually yield a more precise sampling when fewer samples are collected. This strategy involves (1) dividing the top surface of the waste into an imaginary grid as in the three-dimensional strategy, (2) selecting grid sections for sampling using random-number tables or random-number generators, and (3) sampling each selected grid point in a vertical manner along the entire length from top to bottom using a sampling device such as a drum thief or Coliwasa.

Some containers, such as drums with bung openings, limit access to the contained waste and restrict sampling to a single vertical plane. Samples taken in this manner can be considered representative of the entire container only if the waste is known to be homogenous or if no horizontal stratification has occurred. Precautions must be taken when sampling any type of steel drum because the drum may explode or expel gases and/or pressurized liquids. An EPA/NEIC manual, "Safety Manual for Hazardous Waste Site Investigation," addresses these safety precautions.

Tanks

Tanks are essentially large containers. The considerations involved in sampling tanks are therefore similar to those for sampling containers. As with containers, the goal of sampling tanks is to acquire a sufficient number of samples from different locations within the waste to provide analytical data that are representative of the entire tank contents.

The accessibility of the tank contents will affect the sampling methodology. If the tank is an open one, allowing unrestricted access, then usually a representative set of samples is best obtained using the three-dimensional simple random sampling strategy, as described for containers (see also Section 9.2.2.1). This strategy involves dividing the tank contents into an imaginary three-dimensional grid. As a first step, the top surface of the waste is divided into a grid whose sections either approximate the size of the sampling device or are larger than the sampling device if the tank is large.

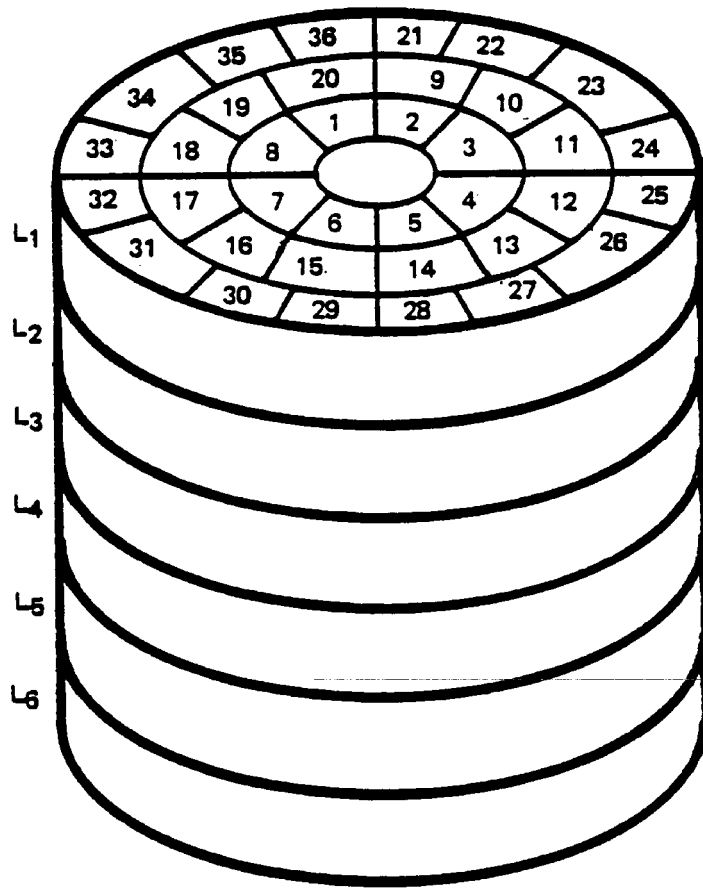

Figure 9-20. Container divided into an imaginary three-dimensional grid.

(Cylindrical tanks can be divided into imaginary concentric circles, which are then further divided into grids of equal size.) Each section is assigned a number. The height of the tank is then divided into imaginary levels that are at least as large as the vertical space required by the chosen sampling device. These imaginary levels are assigned numbers. Specific levels and grid locations are then selected for sampling using a random-number table or random-number generator.

A less comprehensive sampling approach may be appropriate if information regarding the distribution of waste components is known or assumed (e.g., if vertical compositing will yield a representative sample). In such cases, a two-dimensional simple random sampling strategy may be appropriate. In this strategy, the top surface of the waste is divided into an imaginary grid; grid sections are selected using random-number tables or random-number generators; and each selected grid point is then sampled in a vertical manner along the entire length from top to bottom using a sampling device such as a weighted bottle, a drum thief, or Coliwasa. If the waste is known to consist of two or more discrete strata, a more precise representation of the tank contents can be obtained by using a stratified random sampling strategy, i.e., by sampling each stratum separately using the two- or three-dimensional simple random sampling strategy.

Some tanks permit only limited access to their contents, which restricts the locations within the tank from which samples can be taken. If sampling is restricted, the sampling strategy must, at a minimum, take sufficient samples to address the potential vertical anomalies in the waste in order to be considered representative. This is because contained wastes tend to display vertical, rather than horizontal, nonrandom heterogeneity due to settling of suspended solids or denser liquid phases. If access restricts sampling to a portion of the tank contents (e.g., in an open tank, the size of the tank may restrict sampling to the perimeter of the tank; in a closed tank, the only access to the waste may be through inspection ports), then the resulting analytical data will be deemed representative only of the accessed area, not of the entire tank contents unless the tank contents are known to be homogeneous.

If a limited access tank is to be sampled, and little is known about the distribution of components within the waste, a set of samples that is representative of the entire tank contents can be obtained by taking a series of samples as the tank contents are being drained. This should be done in a simple random manner by estimating how long it will take to drain the tank and then randomly selecting times during drainage for sampling.

The most appropriate type of sampling device for tanks depends on the tank parameters. In general, subsurface samples (i.e., pond samplers) are used for shallow tanks, and weighted bottles are usually employed for tanks deeper than 5 ft. Dippers are useful for sampling pipe effluents.

Waste Piles

In waste piles, the accessibility of waste for sampling is usually a function of pile size, a key factor in the design of a sampling strategy for a waste pile. Ideally, piles containing unknown wastes should be sampled using a three-dimensional simple random sampling strategy. This strategy can be employed only if all points within the pile can be accessed. In such cases, the pile should be divided into a three-dimensional grid system, the grid sections assigned numbers, and the sampling points then chosen using random-number tables or random-number generators.

If sampling is limited to certain portions of the pile, then the collected sample will be representative only of those portions, unless the waste is known to be homogenous.

In cases where the size of a pile impedes access to the waste, a set of samples that are representative of the entire pile can be obtained with a minimum of effort by scheduling sampling to coincide with pile removal. The number of truckloads needed to remove the pile should be estimated and the truckloads randomly chosen for sampling.

The sampling devices most commonly used for small piles are thieves, triers, and shovels. Excavation equipment, such as backhoes, can be useful for sampling medium-sized piles.

Landfills and Lagoons

Landfills contain primarily solid waste, whereas lagooned waste may range from liquids to dried sludge residues. Lagooned waste that is either liquid or semisolid is often best sampled using the methods recommended for large tanks. Usually, solid wastes contained in a landfill or lagoon are best sampled using the three-dimensional random sampling strategy.

The three-dimensional random sampling strategy involves establishing an imaginary three-dimensional grid of sampling points in the waste and then using random-number tables or random-number generators to select points for sampling. In the case of landfills and lagoons, the grid is established using a survey or map of the area. The map is divided into two two-dimensional grids with sections of equal size. (An alternative way of choosing random sampling locations is presented in the second example described in Section 9.2.2.1) These sections are then assigned numbers sequentially.

Next, the depth to which sampling will take place is determined and subdivided into equal levels, which are also sequentially numbered. (The lowest sampling depth will vary from landfill to landfill. Usually, sampling extends to the interface of the fill and the natural soils. If soil contamination is suspected, sampling may extend into the natural soil.) The horizontal and vertical sampling coordinates are then selected using random-number tables or random-number generators. If some information is known about the nature of the waste, then a modified three-dimensional strategy may be more appropriate. For example, if the landfill consists of several cells, a more precise measurement may be obtained by considering each cell as a stratum and employing a stratified three-dimensional random sampling strategy (see Section 9.1).

Hollow-stem augers combined with split-spoon samplers are frequently appropriate for sampling landfills. Water-driven or water-rinsed coring equipment should not be used for sampling because the water can rinse chemical components from the sample. Excavation equipment, such as backhoes, may be useful in obtaining samples at various depths; the resulting holes may be useful for viewing and recording the contents of the landfill.

9.2.4 Sample Compositing

The compositing of samples, is usually done for cost-saving reasons, involves the combining of a number of samples or aliquots of a number of samples collected from the same waste. The disadvantage of sample compositing is the loss of concentration variance data, whereas the advantage is that, for a given analytical cost, a more representative (i.e., more accurate) sample is obtained.

It is usually most expedient and cost effective to collect component samples in the field and to composite aliquots of each sample later in the laboratory. Then, if after reviewing the data any questions arise, the samples can be recomposited in a different combination, or each component sample can be analyzed separately to determine better the variation of waste composition over time and space, or to determine better the precision of an average number. The fact that this recompositing of samples can occur without the need to resample often results in a substantial cost savings.

To ensure that recompositing can be done at a later date, it is essential to collect enough sample volume in the field so that, under normal circumstances, enough component sample will remain following compositing to allow for a different compositing scheme or even for an analysis of the component samples themselves.

The actual compositing of samples requires the homogenization of all component samples to ensure that a representative subsample is aliquoted. The homogenization procedure, and the containers and equipment used for compositing, will vary according to the type of waste being composited and the parameters to be measured. Likewise, the composite sample itself will be homogenized prior to the subsampling of analytical aliquots.

9.2.5 References

1. Corey, P.R., Soil Water Monitoring, Unpublished Report to Dept. of Agr. Eng., Colorado State University, Fort Collins, Colorado, 1974.
2. Duke, H.R. and H.R. Haise, Vacuum Extractors to Assess Deep percolation Losses and Chemical Constituents of Soil Water, Soil Sci, Soc, Am. Proc. 37, 963-4 (1973)
3. Parizek, R.R. and B.E. Lane, Soil-Water Sampling Using Pan and Deep Pressure-Vacuum Lysimeters, J.Hydr. 11, 1-21 (1970).

4. Silkworth, D.R. and D.F. Grigal, Field Comparison of Soil Solution Samplers, Soil Sci. Soc. Am. J. 45, 440-442 (1981).
5. Trout, T.J., J.L. Smith, and D.B. McWhorter, Environmental Effects of Land Application of Digested Municipal Sewage Sludge, Report submitted to City of Boulder, Colorado, Dept. of Agr. Engr., Colorado State Univ., For Collins, Colorado, 1975.
6. Tyler, D.D. and G.W. Thomas, Lysimeter Measurements of Nitrate and Chloride Losses and No-tillage Corn, J. Environ. Qual. 6, 63-66 (1977).
7. U.S. Department of Transportation, Hazardous Materials Table, 49 CFR 172.101.
8. U.S. EPA, Office of Solid Waste and Emergency Response, Hazardous Waste Land Treatment, Washington, D.C., SW-874, 1983.
9. U.S. EPA, NEIC Policies and Procedures, 330/9/78/001-R, 1982.
10. Wood, W.W., A Technique Using Porous Cups for Water Sampling at Any Depth in the Unsaturated Zone, Water Resources Research 9, 486-488 (1973).

Attachment 2
RCRA Waste Sampling Draft Technical Guidance



RCRA Waste Sampling Draft Technical Guidance

Planning, Implementation, and Assessment

RCRA Waste Sampling Draft Technical Guidance

Planning, Implementation,
and Assessment

Office of Solid Waste
U.S. Environmental Protection Agency
Washington, DC 20460

DISCLAIMER

The United States Environmental Protection Agency's Office of Solid Waste (EPA or the Agency) has prepared this draft document to provide guidance to project planners, field personnel, data users, and other interested parties regarding sampling for the evaluation of solid waste under the Resource Conservation and Recovery Act (RCRA).

EPA does not make any warranty or representation, expressed or implied, with respect to the accuracy, completeness, or usefulness of the information contained in this report. EPA does not assume any liability with respect to the use of, or for damages resulting from the use of, any information, apparatus, method, or process disclosed in this report. Reference to trade names or specific commercial products, commodities, or services in this report does not represent or constitute an endorsement, recommendation, or favoring by EPA of the specific commercial product, commodity, or service. In addition, the policies set out in this document are not final Agency action, but are intended solely as guidance. They are not intended, nor can they be relied upon, to create any rights enforceable by any party in litigation with the United States. EPA officials may decide to follow the guidance provided in this document, or to act at variance with the guidance, based on an analysis of specific site or facility circumstances. The Agency also reserves the right to change this guidance at any time without public notice.

ACKNOWLEDGMENTS

Development of this document was funded, wholly or in part, by the United States Environmental Protection Agency (U.S. EPA) under Contract No. 68-W6-0068 and 68-W-00-122. It has been reviewed by EPA and approved for publication. It was developed under the direction of Mr. Oliver M. Fordham, Office of Solid Waste (OSW) and Kim Kirkland (OSW) in collaboration with Dr. Brian A. Schumacher, Office of Research and Development (ORD). This document was prepared by Mr. Robert B. Stewart, Science Applications International Corporation (SAIC). Additional writers included Dr. Kirk Cameron (MacStat Consulting, Ltd.), Dr. Larry P. Jackson (Environmental Quality Management), Dr. John Maney (Environmental Measurements Assessment Co.), Ms. Jennifer Bramlett (SAIC), and Mr. Oliver M. Fordham (U.S. EPA).

EPA gratefully acknowledges the contributions of the technical reviewers involved in this effort, including the following:

U.S. EPA Program Offices

Deana Crumbling, TIO
Evan Englund, ORD
George Flatman, ORD
Joan Fisk, OERR
David Friedman, ORD
Chris Gaines, OW
Gail Hansen, OSW
Barnes Johnson, OSW

Joe Lowry, NEIC
John Nocerino, ORD
Brian A. Schumacher, ORD
Jim Thompson, OECA
Jeff Van Ee, ORD
Brad Venner, NEIC
John Warren, OEI

U.S. EPA Regions

Dan Granz, Region I
Bill Cosgrove, Region IV
Mike Neill, Region IV
Judy Sophianopoulos, Region IV
Brian Freeman, Region V
Gene Keeper, Region VI
Gregory Lyssy, Region VI
Bill Gallagher, Region VI
Deanna Lacy, Region VI
Maria Martinez, Region VI

Walt Helmick, Region VI
Charles Ritchey, Region VI
Terry Sykes, Region VI
Stephanie Doolan, Region VII
Dedriel Newsome, Region VII
Tina Diebold, Region VIII
Mike Gansecki, Region VIII
Roberta Hedeem, Region X
Mary Queitzsch, Region X

ASTM Subcommittee D-34

Brian M. Anderson, SCA Services
Eric Chai, Shell
Alan B. Crockett, INEL
Jim Frampton, CA DTSC

Susan Gagner, LLNL
Alan Hewitt, CRREL
Larry Jackson, EQM
John Maney, EMA

Other Organizations

Jeffrey Farrar, U.S. Bureau of Reclamation
Jeff Myers, Westinghouse SMS

Rock Vitale, Environmental Standards
Ann Strahl, Texas NRCC

CONTENTS

1	INTRODUCTION	1
1.1	What Will I Find in This Guidance Document?	1
1.2	Who Can Use This Guidance Document?	1
1.3	Does This Guidance Document Replace Other Guidance?	2
1.4	How Is This Document Organized?	3
2	SUMMARY OF RCRA REGULATORY DRIVERS FOR WASTE SAMPLING AND ANALYSIS	6
2.1	Background	6
2.2	Sampling For Regulatory Compliance	8
2.2.1	Making a Hazardous Waste Determination	8
2.2.2	Land Disposal Restrictions (LDR) Program	9
2.2.3	Other RCRA Regulations and Programs That May Require Sampling and Testing	10
2.2.4	Enforcement Sampling and Analysis	10
3	FUNDAMENTAL STATISTICAL CONCEPTS	13
3.1	Populations, Samples, and Distributions	14
3.1.1	Populations and Decision Units	14
3.1.2	Samples and Measurements	15
3.1.3	Distributions	17
3.2	Measures of Central Tendency, Variability, and Relative Standing	18
3.2.1	Measures of Central Tendency	18
3.2.2	Measures of Variability	19
3.2.3	Measures of Relative Standing	21
3.3	Precision and Bias	21
3.4	Using Sample Analysis Results to Classify a Waste or to Determine Its Status Under RCRA	24
3.4.1	Using an Average To Determine Whether a Waste or Media Meets the Applicable Standard	24
3.4.2	Using a Proportion or Percentile To Determine Whether a Waste or Media Meets an Applicable Standard	26
3.4.2.1	<i>Using a Confidence Limit on a Percentile to Classify a Waste or Media</i>	27
3.4.2.2	<i>Using a Simple Exceedance Rule Method To Classify a Waste</i>	27
3.4.3	Comparing Two Populations	28
3.4.4	Estimating Spatial Patterns	29
4	PLANNING YOUR PROJECT USING THE DQO PROCESS	30
4.1	Step 1: State the Problem	32
4.1.1	Identify Members of the Planning Team	32

4.1.2	Identify the Primary Decision Maker	32
4.1.3	Develop a Concise Description of the Problem	32
4.2	Step 2: Identify the Decision	33
4.2.1	Identify the Principal Study Question	33
4.2.2	Define the Alternative Actions That Could Result from Resolution of the Principal Study Question	34
4.2.3	Develop a Decision Statement	34
4.2.4	Organize Multiple Decisions	34
4.3	Step 3: Identify Inputs to the Decision	34
4.3.1	Identify the Information Required	34
4.3.2	Determine the Sources of Information	35
4.3.3	Identify Information Needed To Establish the Action Level	35
4.3.4	Confirm That Sampling and Analytical Methods Exist That Can Provide the Required Environmental Measurements	36
4.4	Step 4: Define the Study Boundaries	36
4.4.1	Define the Target Population of Interest	36
4.4.2	Define the Spatial Boundaries	37
4.4.3	Define the Temporal Boundary of the Problem	37
4.4.4	Identify Any Practical Constraints on Data Collection	38
4.4.5	Define the Scale of Decision Making	38
4.5	Step 5: Develop a Decision Rule	39
4.5.1	Specify the Parameter of Interest	39
4.5.2	Specify the Action Level for the Study	40
4.5.3	Develop a Decision Rule	41
4.6	Step 6: Specify Limits on Decision Errors	41
4.6.1	Determine the Possible Range on the Parameter of Interest	43
4.6.2	Identify the Decision Errors and Choose the Null Hypothesis	43
4.6.3	Specify a Range of Possible Parameter Values Where the Consequences of a False Acceptance Decision Error are Relatively Minor (Gray Region)	45
4.6.4	Specify an Acceptable Probability of Making a Decision Error	47
4.7	Outputs of the First Six Steps of the DQO Process	48
5	OPTIMIZING THE DESIGN FOR OBTAINING THE DATA	50
5.1	Review the Outputs of the First Six Steps of the DQO Process	50
5.2	Consider Data Collection Design Options	51
5.2.1	Simple Random Sampling	57
5.2.2	Stratified Random Sampling	57
5.2.3	Systematic Sampling	59
5.2.4	Ranked Set Sampling	60
5.2.5	Sequential Sampling	61
5.2.6	Authoritative Sampling	62
	5.2.6.1 <i>Judgmental Sampling</i>	63
	5.2.6.2 <i>Biased Sampling</i>	64
5.3	Composite Sampling	64
5.3.1	Advantages and Limitations of Composite Sampling	65
5.3.2	Basic Approach To Composite Sampling	66
5.3.3	Composite Sampling Designs	67

5.3.3.1	<i>Simple Random Composite Sampling</i>	67
5.3.3.2	<i>Systematic Composite Sampling</i>	68
5.3.4	Practical Considerations for Composite Sampling	69
5.3.5	Using Composite Sampling To Obtain a More Precise Estimate of the Mean	69
5.3.6	Using Composite Sampling To Locate Extreme Values or "Hot Spots"	71
5.4	Determining the Appropriate Number of Samples Needed To Estimate the Mean	73
5.4.1	Number of Samples to Estimate the Mean: Simple Random Sampling	75
5.4.2	Number of Samples to Estimate the Mean: Stratified Random Sampling	77
5.4.2.1	<i>Optimal Allocation</i>	78
5.4.2.2	<i>Proportional Allocation</i>	78
5.4.3	Number of Samples to Estimate the Mean: Systematic Sampling	80
5.4.4	Number of Samples to Estimate the Mean: Composite Sampling	80
5.5	Determining the Appropriate Number of Samples to Estimate A Percentile or Proportion	81
5.5.1	Number of Samples To Test a Proportion: Simple Random or Systematic Sampling	81
5.5.2	Number of Samples When Using a Simple Exceedance Rule	83
5.6	Selecting the Most Resource-Effective Design	84
5.7	Preparing a QAPP or WAP	84
5.7.1	Project Management	85
5.7.2	Measurement/Data Acquisition	86
5.7.3	Assessment/Oversight	86
5.7.4	Data Validation and Usability	86
5.7.5	Data Assessment	87
6	CONTROLLING VARIABILITY AND BIAS IN SAMPLING	88
6.1	Sources of Random Variability and Bias in Sampling	88
6.2	Overview of Sampling Theory	90
6.2.1	Heterogeneity	90
6.2.2	Types of Sampling Error	91
6.2.2.1	<i>Fundamental Error</i>	92
6.2.2.2	<i>Grouping and Segregation Error</i>	93
6.2.2.3	<i>Increment Delimitation Error</i>	94
6.2.2.4	<i>Increment Extraction Error</i>	94
6.2.2.5	<i>Preparation Error</i>	94
6.2.3	The Concept of "Sample Support"	94
6.3	Practical Guidance for Reducing Sampling Error	95
6.3.1	Determining the Optimal Mass of a Sample	96
6.3.2	Obtaining the Correct Shape and Orientation of a Sample	98
6.3.2.1	<i>Sampling of a Moving Stream of Material</i>	98
6.3.2.2	<i>Sampling of a Stationary Batch of Material</i>	99
6.3.3	Selecting Sampling Devices That Minimize Sampling Errors	99
6.3.3.1	<i>General Performance Goals for Sampling Tools and Devices</i>	99

6.3.3.2	<i>Use and Limitations of Common Devices</i>	100
6.3.4	Special Considerations for Sampling Waste and Soils for Volatile Organic Compounds	101
7	IMPLEMENTATION: SELECTING EQUIPMENT AND CONDUCTING SAMPLING	102
7.1	Selecting Sampling Tools and Devices	102
7.1.1	Step 1: Identify the Waste Type or Medium to be Sampled	104
7.1.2	Step 2: Identify the Site or Point of Sample Collection	104
7.1.2.1	<i>Drums and Sacks or Bags</i>	104
7.1.2.2	<i>Surface Impoundments</i>	105
7.1.2.3	<i>Tanks</i>	105
7.1.2.4	<i>Pipes, Point Source Discharges, or Sampling Ports</i>	106
7.1.2.5	<i>Storage Bins, Roll-Off Boxes, or Collection Hoppers</i>	106
7.1.2.6	<i>Waste Piles</i>	106
7.1.2.7	<i>Conveyors</i>	106
7.1.2.8	<i>Structures and Debris</i>	107
7.1.2.9	<i>Surface or Subsurface Soil</i>	107
7.1.3	Step 3: Consider Device-Specific Factors	107
7.1.3.1	<i>Sample Type</i>	108
7.1.3.2	<i>Sample Volume</i>	108
7.1.3.3	<i>Other Device-Specific Considerations</i>	108
7.1.4	Step 4: Select the Sampling Device	108
7.2	Conducting Field Sampling Activities	122
7.2.1	Selecting Sample Containers	122
7.2.2	Sample Preservation and Holding Times	123
7.2.3	Documentation of Field Activities	124
7.2.4	Field Quality Control Samples	124
7.2.5	Sample Identification and Chain-of-Custody Procedures	125
7.2.6	Decontamination of Equipment and Personnel	128
7.2.7	Health and Safety Considerations	130
7.2.8	Sample Packaging and Shipping	131
7.2.8.1	<i>Sample Packaging</i>	131
7.2.8.2	<i>Sample Shipping</i>	133
7.3	Using Sample Homogenization, Splitting, and Subsampling Techniques	134
7.3.1	Homogenization Techniques	134
7.3.2	Sample Splitting	135
7.3.3	Subsampling	135
7.3.3.1	<i>Subsampling Liquids</i>	136
7.3.3.2	<i>Subsampling Mixtures of Liquids and Solids</i>	136
7.3.3.3	<i>Subsampling Soils and Solid Media</i>	136
8	ASSESSMENT: ANALYZING AND INTERPRETING DATA	139
8.1	Data Verification and Validation	139
8.1.1	Sampling Assessment	139
8.1.1.1	<i>Sampling Design</i>	140

8.1.1.2	<i>Sampling Methods</i>	141
8.1.1.3	<i>Sample Handling and Custody Procedures</i>	141
8.1.1.4	<i>Documentation</i>	141
8.1.1.5	<i>Control Samples</i>	142
8.1.2	Analytical Assessment	142
8.1.2.1	<i>Analytical Data Verification</i>	143
8.1.2.2	<i>Analytical Data Validation (Evaluation)</i>	144
8.2	Data Quality Assessment	145
8.2.1	Review the DQOs and the Sampling Design	145
8.2.2	Prepare Data for Statistical Analysis	145
8.2.3	Conduct Preliminary Review of the Data and Check Statistical Assumptions	147
8.2.3.1	<i>Statistical Quantities</i>	147
8.2.3.2	<i>Checking Data for Normality</i>	147
8.2.3.3	<i>How To Assess "Outliers"</i>	148
8.2.4	Select and Perform Statistical Tests	149
8.2.4.1	<i>Data Transformations in Statistical Tests</i>	150
8.2.4.2	<i>Treatment of Nondetects</i>	154
8.2.5	Draw Conclusions and Report Results	154
Appendix A: Glossary of Terms		157
Appendix B: Summary of RCRA Regulatory Drivers for Conducting Waste Sampling and Analysis		171
Appendix C: Strategies for Sampling Heterogeneous Wastes		191
Appendix D: A Quantitative Approach for Controlling Fundamental Error		197
Appendix E: Sampling Devices		201
Appendix F: Statistical Methods		241
Appendix G: Statistical Tables		263
Appendix H: Statistical Software		273
Appendix I: Examples of Planning, Implementation, and Assessment for RCRA Waste Sampling		277
Appendix J: Summary of ASTM Standards		305
References		323
Index		337

LIST OF ACRONYMS

AL	Action Level
ASTM	American Society for Testing and Materials
BDAT	Best Demonstrated Available Technology
BIF	Boiler and Industrial Furnace
CERCLA	Comprehensive, Environmental Response, Compensation & Liability Act
CFR	Code of Federal Regulations
DOT	Department of Transportation
DQA	Data Quality Assessment
DQO	Data Quality Objective
EA	Exposure area
FR	Federal Register
HWIR	Hazardous Waste Identification Rule (waste)
IATA	International Air Transport Association
ICR	Ignitability, Corrosivity, and Reactivity
IDW	Investigation-derived waste
LCL	Lower confidence limit
LDR	Land Disposal Restrictions
ORD	Office of Research and Development
OSHA	Occupational Safety and Health Administration
OSW	Office of Solid Waste
PBMS	Performance-based measurement system
ppm	Parts per million
QAD	Quality Assurance Division
QAPP	Quality Assurance Project Plan
QA/QC	Quality Assurance/Quality Control
RCRA	Resource Conservation and Recovery Act
RT	Regulatory Threshold
SOP	Standard operating procedure
SWMU	Solid waste management unit
TC	Toxicity Characteristic
TCLP	Toxicity Characteristic Leaching Procedure
TSDF	Treatment, storage, or disposal facility
UCL	Upper confidence limit
USEPA	U.S. Environmental Protection Agency (we, us, our, EPA, the Agency)
UTS	Universal Treatment Standard
VOC	Volatile organic compound
WAP	Waste analysis plan

RCRA WASTE SAMPLING DRAFT TECHNICAL GUIDANCE

1 INTRODUCTION

1.1 What Will I Find in This Guidance Document?

You'll find recommended procedures for sampling solid waste under the Resource Conservation and Recovery Act (RCRA). The regulated and regulatory communities can use this guidance to develop sampling plans to determine if (1) a solid waste exhibits any of the characteristics of a hazardous waste¹, (2) a hazardous waste is prohibited from land disposal, and (3) a numeric treatment standard has been met. You also can use information in this document along with that found in other guidance documents to meet other sampling objectives such as site characterization under the RCRA corrective action program.

This guidance document steps you through the three phases of the sampling and analysis process shown in Figure 1: planning, implementation, and assessment. Planning involves "asking the right questions." Using a systematic planning process such as the Data Quality Objectives (DQO) Process helps you do so. DQOs are the specifications you need to develop a plan for your project such as a quality assurance project plan (QAPP) or a waste analysis plan (WAP). Implementation involves using the field sampling procedures and analytical methods specified in the plan and taking measures to control error that might be introduced along the way. Assessment is the final stage in which you evaluate the results of the study in terms of the original objectives and make decisions regarding management or treatment of the waste.

1.2 Who Can Use This Guidance Document?

Any person who generates, treats, stores, or disposes of solid and hazardous waste and conducts sampling and analysis under RCRA can use the information in this guidance document.

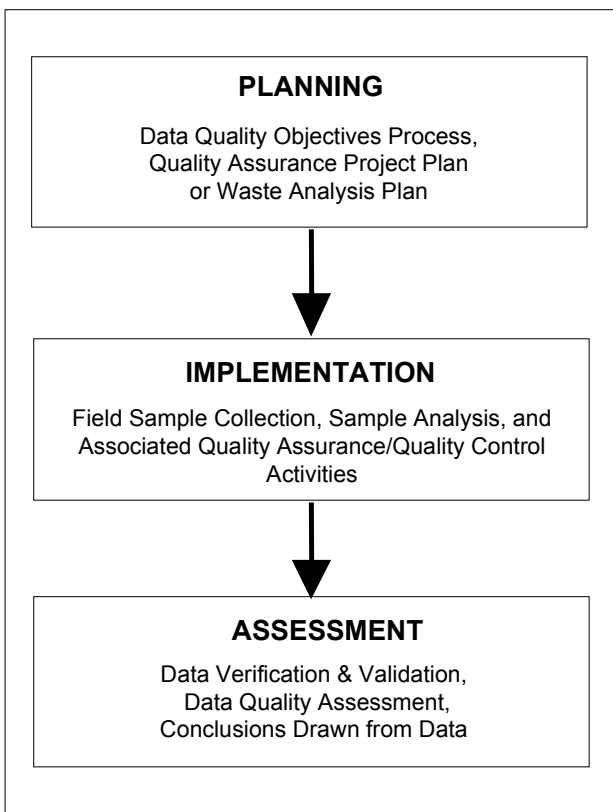

Figure 1. QA Planning and the Data Life Cycle (after USEPA 1998a).

¹ If a solid waste is not excluded from regulation under 40 CFR 261, then a generator must determine whether the waste exhibits any of the characteristics of hazardous waste. A generator may determine if a waste exhibits a characteristic either by testing the waste or applying knowledge of the waste, the raw materials, and the processes used in its generation.

For the development of a technically sound sampling and project plan, seek competent advice during the initial stages of project design. This is particularly true in the early developmental stages of a sampling plan when planners need to understand basic statistical concepts, how to establish objectives, and how the results of the project will be evaluated.

This document is a practical guide, and many examples are included throughout the text to demonstrate how to apply the guidance. In addition, we have included a comprehensive glossary of terms in Appendix A to help you with any unfamiliar terminology. We encourage you to review other documents referenced in the text, especially those related to the areas of sampling theory and practice and the statistical analysis of environmental data.

1.3 Does This Guidance Document Replace Other Guidance?

EPA prepared this guidance document to update technical information contained in other sources of EPA guidance such as Chapter Nine “Sampling Plan” found in *Test Methods for Evaluating Solid Waste, Physical/Chemical Methods*, EPA publication SW-846 (1986a). This draft guidance document does not replace SW-846 Chapter Nine, nor does it create, amend, or otherwise alter any regulation. Since publication of SW-846 Chapter Nine, EPA has published a substantial body of additional sampling and statistical guidance documents that support waste and site characterization under both RCRA and the Comprehensive, Environmental Response, Compensation & Liability Act (CERCLA) or “Superfund.” Most of these guidance documents, which focus on specific Agency regulations or program initiatives, should continue to be used, as appropriate. Relevant EPA guidance documents, other references, and resources are identified in Appendix B and throughout this document.

In addition to RCRA program-specific guidance documents issued by EPA’s Office of Solid Waste (OSW), EPA’s Office of Environmental Information’s Quality Staff has developed policy for quality assurance, guidance documents and software tools, and provides training and outreach. For example, the Quality Staff have issued guidance on the following key topic areas:

- The data quality objectives process (USEPA 2000a, 2000b, and 2001a)
- Preparation of quality assurance project plans (USEPA 1998a and 2001b) and sampling plans (2000c)
- Verification and validation of environmental data (USEPA 2001c)
- Data quality assessment (USEPA 2000d).

Information about EPA’s Quality System and QA procedures and policies can be found on the World Wide Web at <http://www.epa.gov/quality/>.

If you require additional information, you should review these documents and others cited in this document. In the future, EPA may issue additional supplemental guidance supporting other regulatory initiatives.

Finally, other organizations including EPA Regions, States, the American Society for Testing and Materials (ASTM), the Department of Defense (e.g., the Air Force Center for Environmental

Excellence), and the Department of Energy have developed a wide range of relevant guidance and methods. Consult these resources for further assistance, as necessary.

1.4 How Is This Document Organized?

As previously indicated in Figure 1, this guidance document covers the three components of a sampling and analysis program: planning, implementation, and assessment. Even though the process is pictured in a linear format, in practice a sampling program should include feedback between the various components. You should review and analyze data as collected so you can determine whether the data satisfy the objectives of the study and if the approach or objectives need to be revised or refined, and so you can make reasoned and intelligent decisions.

The remaining sections of this guidance document address specific topics pertaining to various components of a sampling program. These sections include the following:

Section 2 - Summary of RCRA Regulatory Drivers for Waste Sampling and Analysis – This section identifies and summarizes the major RCRA programs that specify some sort of sampling and testing to determine if a waste is a hazardous waste, to determine if a hazardous waste treatment standard is attained, and other determinations.

Section 3 - Fundamental Statistical Concepts -- This section provides an overview of fundamental statistical concepts and how the sample analysis results can be used to classify a waste or determine its status under RCRA. The section serves as a refresher to those familiar with basic statistics. In those cases where you require more advanced techniques, seek the assistance of a professional environmental statistician. Detailed guidance on the selection and use of statistical methods is provided in Section 8 and Appendix F.

Section 4 - Planning Your Project Using the DQO Process -- The first phase of sampling involves development of DQOs using the DQO Process or a similar structured systematic planning process. The DQOs provide statements about the expectations and requirements of the data user (such as the decision maker).

Section 5 - Optimizing the Design for Obtaining the Data -- This section describes how to link the results of the DQO Process with the development of the QAPP. You optimize the sampling design to control sampling errors within acceptable limits and minimize costs while continuing to meet the sampling objectives. You document the output of the DQO Process in a QAPP, WAP, or similar planning document. Here is where you translate the data requirements into measurement performance specifications and QA/QC procedures.

Section 6 - Controlling Variability and Bias in Sampling -- In this section, we recognize that random variability and bias (collectively known as “error”) in sampling account for a significant portion of the total error in the sampling and analysis process – far outweighing typical analytical error. To address this concern, the section describes the sources of error in sampling and offers some strategies for minimizing those errors.

Section 7 - Implementation: Selecting Equipment and Conducting Sampling -- In this section, we describe the steps for selecting sampling equipment based on the physical and chemical characteristics of the media to be sampled and the type of RCRA unit or location from which the samples will be obtained. The section provides guidance on field sampling activities, such as documentation, chain-of-custody procedures, decontamination, and sample packaging and shipping. Finally, guidance is provided on sample homogenization (or mixing), splitting, and subsampling.

Section 8 - Assessment: Analyzing and Interpreting Data -- Once you have obtained the data in accordance with the elements of the QAPP or WAP, you should evaluate the data to determine whether you have satisfied the DQOs. Section 8 describes the data quality assessment (DQA) process and the statistical analysis of waste-sampling data.

Appendix A - Glossary of Terms -- This appendix comprises a glossary of terms that are used in this document.

Appendix B - Summary of RCRA Regulatory Drivers for Conducting Waste Sampling and Analysis -- An overview of the RCRA regulatory requirements and other citations related to waste sampling and testing is provided in this appendix.

Appendix C - Strategies for Sampling Heterogeneous Wastes -- The heterogeneity of a waste or media plays an important role in how you collect and handle samples and what type of sampling design you use. This appendix provides a supplemental discussion of large-scale heterogeneity of waste and its impact on waste-sampling strategies. Various types of large-scale heterogeneity are identified and techniques are described for stratifying a waste stream based on heterogeneity. Stratified sampling can be a cost-effective approach for sampling and analysis of heterogeneous wastes.

Appendix D - A Quantitative Approach for Controlling Fundamental Error -- The mass of a sample can influence our ability to obtain reproducible analytical results. This appendix provides an approach for determining the appropriate mass of a sample of particulate material using information about the size and shape of the particles.

Appendix E - Sampling Devices -- This appendix provides descriptions of recommended sampling devices. For each type of sampling device, information is provided in a uniform format that includes a brief description of the device and its use, advantages and limitations of the device, and a figure to indicate the general design of the device. Each summary also identifies sources of other guidance on each device, particularly any relevant ASTM standards.

Appendix F - Statistical Methods -- This appendix provides statistical guidance for the analysis of data generated in support of a waste-testing program under RCRA.

Appendix G - Statistical Tables -- A series of statistical tables needed to perform the statistical tests used in this guidance document are presented here.

Appendix H - Statistical Software -- A list of statistical software and "freeware" (no-cost software) that you might find useful in implementing the statistical methods outlined

in this guidance document is contained in this appendix, as are Internet addresses at which you can download no-cost software.

Appendix I - Examples of Planning, Implementation, and Assessment for RCRA Waste Sampling -- Two hypothetical examples of how to apply the planning, implementation, and assessment guidance provided in this guidance document are provided here.

Appendix J - Summaries of ASTM Standards -- This appendix provides summaries of ASTM standards related to waste sampling and referenced in this document.

2 SUMMARY OF RCRA REGULATORY DRIVERS FOR WASTE SAMPLING AND ANALYSIS

2.1 Background

Through RCRA, Congress provided EPA with the framework to develop regulatory programs for the management of solid and hazardous waste. The provisions of RCRA Subtitle C establish the criteria for identifying hazardous waste and managing it from its point of generation to ultimate disposal. EPA's regulations set out in 40 CFR Parts 260 to 279 are the primary source for the requirements of the hazardous waste program. These regulations were developed over a period of 25 years. While EPA's approach for developing individual regulations may have evolved over this period, the current RCRA statute and codified regulations remain the standard for determining compliance.

Many of the RCRA regulations either *require* the waste handler to conduct sampling and analysis, or they include provisions under which sampling and analysis can be performed at the discretion of the waste handler. If the regulations require sampling and analysis of a waste or environmental media, then any regulatory requirements for conducting the sampling and analysis and for evaluating the results must be followed. Regardless of whether there are regulatory requirements to conduct sampling, some waste handlers may wish to conduct a sampling program that allows them to quantify any uncertainties associated with their waste classification decisions. The information in this document can be used to aid in the planning and implementation of such a sampling program.

Some RCRA regulations *do not* specify sampling and analysis requirements and/or *do not* specify how the sample analysis results should be evaluated. In many cases, this is because EPA realized that the type, quantity, and quality of data needed should be specified on a site-specific basis, such as in the waste analysis plan of a permitted facility. In those situations, you can use the guidance in this document to help you plan and implement the sampling and analysis program, evaluate the sample analysis results against the regulatory standards, and quantify the level of uncertainty associated with the decisions.

This section identifies the major RCRA programs that specify some sort of sampling and testing to determine if a waste is a hazardous waste, to determine if a hazardous waste treatment standard is attained, or to meet other objectives such as site characterization. Table 1 provides a listing of these major RCRA programs that may require waste sampling and testing as part of their implementation. Appendix B provides a more detailed listing of the regulatory citations, the applicable RCRA standards, requirements for demonstrating attainment or compliance with the standards, and relevant USEPA guidance documents.

Prior to conducting a waste sampling and testing program to comply with RCRA, review the specific regulations in detail. Consult the latest 40 CFR, related *Federal Register* notices, and EPA's World Wide Web site (www.epa.gov) for new or revised regulations. In addition, because some states have requirements that differ from EPA regulations and guidance, we recommend that you consult with a representative from your State if your State is authorized to implement the regulation.

Table 1. Major RCRA Program Areas Involving Waste Sampling and Analysis ¹

40 CFR Citation	Program Description
Hazardous Waste Identification	
§ 261.3(a)(2)(v)	Used oil rebuttable presumption (also Part 279, Subparts B, E, F and G standards for the management of used oil)
§ 261.3(c)(2)(ii)(C)	Generic exclusion levels for K061, K062, and F006 nonwastewater HTMR residues
§ 261.21	Characteristic of Ignitability
§ 261.22	Characteristic of Corrosivity
§ 261.23	Characteristic of Reactivity
§ 261.24	Toxicity Characteristic
§ 261.38(c)(8)	Exclusion of Comparable Fuels from the Definition of Solid and Hazardous Waste
Part 261, Appendix I	Representative Sampling Methods
Mixed Hazardous Waste	Joint EPA-NRC sampling guidance. See November 20, 1997 <i>Federal Register</i> (62 FR 62079)
Land Disposal Restriction Program	
§ 268.6	Petitions to Allow Land Disposal of a Waste Prohibited Under Subpart C of Part 268 (No-Migration Petition). Sampling and testing criteria are specified at § 268.6(b)(1) and (2).
§ 268.40	Land Disposal Restriction (LDR) concentration-level standards
§ 268.44	Land Disposal Restriction Treatability Variance
§ 268.49(c)(1)	Alternative LDR Treatment Standards for Contaminated Soil
Other RCRA Programs and References	
§ 260.10	Definitions (for Representative Sample)
Part 260, Subpart C	Rulemaking Petitions
Part 262, Subpart A	Generator Standards - General (including § 262.11 Hazardous Waste Determination)
Part 262, Subpart C	Pre-Transport Requirements
Part 264, Subpart A	Treatment, Storage, and Disposal Facility Standards - General
Parts 264/265, Subpart B	Treatment, Storage, and Disposal Facility Standards - General Facility Standards
Parts 264/265, Subpart F	Releases from Solid Waste Management Units (ground-water monitoring)
Parts 264/265, Subpart G	Closure and Post-Closure
Parts 264, Subpart I	Use and Management of Containers
Parts 264/265 - Subpart J	Tank Systems

1. Expanded descriptions of the programs listed in Table 1 are given in Appendix B.

Table 1. Major RCRA Program Areas Involving Waste Sampling and Analysis (continued)

<i>40 CFR Citation</i>	<i>Program Description</i>
Other RCRA Programs and References (continued)	
Parts 264/265 - Subpart M	Land Treatment
Part 264/265 - Subpart O	Incinerators
Part 264, Subpart S	Corrective Action for Solid Waste Management Units (including § 264.552 Corrective Action Management Units)
Parts 264/265 - Subparts AA/BB/CC	Air Emission Standards
Part 266 - Subpart H	Hazardous Waste Burned in Boiler and Industrial Furnaces (BIFs) (including § 266.112 Regulation of Residues)
Part 270 - Subpart B	Permit Application, Hazardous Waste Permitting
Part 270 - Subpart C	Conditions Applicable to All Permits
Part 270 - Subpart F	Special Forms of Permits
Part 273	Standards for Universal Waste Management
Part 279	Standards for the Management of Used Oil

2.2 Sampling For Regulatory Compliance

Many RCRA programs involve sampling and analysis of waste or environmental media by the regulated community. Sampling and analysis often is employed to make a hazardous waste determination (see Section 2.2.1), to determine if a waste is subject to treatment or, if so, has been adequately treated under the Land Disposal Restrictions program (see Section 2.2.2), or in responding to other RCRA programs that include routine monitoring, unit closure, or cleanup (see Section 2.2.3).

2.2.1 Making a Hazardous Waste Determination

Under RCRA, a hazardous waste is defined as a solid waste, or a combination of solid wastes which, because of its quantity, concentration, or physical, chemical, or infectious characteristics, may cause, or significantly contribute to an increase in mortality or an increase in serious irreversible or incapacitating reversible illness, or pose a substantial present or potential hazard to human health or the environment when improperly treated, stored, transported, disposed, or otherwise managed. The regulatory definition of a hazardous waste is found in 40 CFR § 261.3.

Solid wastes are defined by regulation as hazardous wastes in two ways. First, solid wastes are hazardous wastes if EPA lists them as hazardous wastes. The lists of hazardous wastes are found in 40 CFR Part 261, Subpart D. Second, EPA identifies the characteristics of a hazardous waste based on criteria in 40 CFR § 261.10. Accordingly, solid wastes are hazardous if they exhibit any of the following four characteristics of a hazardous waste: ignitability, corrosivity, reactivity, or toxicity (based on the results of the Toxicity Characteristic Leaching Procedure, or TCLP). Descriptions of the hazardous waste characteristics are found in 40 CFR Part 261, Subpart C.

Generators must conduct a hazardous waste determination according to the hierarchy specified in 40 CFR § 262.11. Persons who generate a solid waste first must determine if the solid waste is excluded from the definition of hazardous waste under the provisions of 40 CFR § 261.4. Once the generator determines that a solid waste is not excluded, then he/she must determine if the waste meets one or more of the hazardous waste listing descriptions and determine whether the waste is mixed with a hazardous waste, is derived from a listed hazardous waste, or contains a hazardous waste.

For purposes of compliance with 40 CFR Part 268, or if the solid waste is not a listed hazardous waste, the generator must determine if the waste exhibits a characteristic of a hazardous waste. This evaluation involves testing the waste *or* using knowledge of the process or materials used to produce the waste.

When a waste handler conducts testing to determine if the waste exhibits any of the four characteristics of a hazardous waste, he or she must obtain a representative sample (within the meaning of a representative sample given at § 260.10) using the applicable sampling method specified in Appendix I of Part 261 or alternative method (per § 261.20(c))¹ and test the waste for the hazardous waste characteristics of interest at § 261.21 through 261.24.

For the purposes of subpart 261, the identification of hazardous waste, the regulations state that a sample obtained using any of the applicable sampling methods specified in Appendix I of Part 261 to be a representative sample within the meaning of the Part 260 definition of representative sample. Since these sampling methods are not officially required, anyone desiring to use a different sampling method may do so without demonstrating the equivalency of that method under the procedures set forth in § 260.21. The user of an alternate sampling method must use a method that yields samples that “meet the definition of representative sample found in Part 260” (45 FR 33084 and 33108, May 18, 1990). Such methods should enable one to obtain samples that are equally representative as those specified in Appendix I of Part 261. The planning process and much of the information described in this guidance document may be helpful to someone regulated under Part 261 wishing to use an alternate sampling method. The guidance should be help full as well for purposes other than Part 261.

Certain states also may have requirements for identifying hazardous wastes in addition to those requirements specified by Federal regulations. States authorized to implement the RCRA or HSWA programs under Section 3006 of RCRA may promulgate regulations that are more stringent or broader in scope than Federal regulations.

2.2.2 Land Disposal Restrictions (LDR) Program

The LDR program regulations found at 40 CFR Part 268 require that a hazardous waste generator determine if the waste has to be treated before it can be land disposed. This is done by determining if the hazardous waste meets the applicable treatment standards at § 268.40, § 268.45, or §268.49. EPA expresses treatment standards either as required treatment technologies that must be applied to the waste or as contaminant concentration levels that must

¹ Since the 40 CFR Part 261 Appendix I sampling methods are not formally adopted by the EPA Administrator, a person who desires to employ an alternative sampling method is not required to demonstrate the equivalency of his or her method under the procedures set forth in §§ 260.20 and 260.21 (see comment at § 261.20(c)).

be met. (Alternative LDR treatments standards have been promulgated for contaminated soil, debris, and lab packs.) Determining the need for waste treatment can be made by either of two ways: testing the waste or using knowledge of the waste (see § 268.7(a)).

If a hazardous waste generator is managing and treating prohibited waste or contaminated soil in tanks, containers, or containment buildings to meet the applicable treatment standard, then the generator must develop and follow a written waste analysis plan (WAP) in accordance with § 268.7(a)(5).

A hazardous waste treater must test their waste according to the frequency specified in their WAP as required by 40 CFR 264.13 (for permitted facilities) or 40 CFR 265.13 (for interim status facilities). See § 268.7(b).

If testing is performed, *no portion of the waste may exceed the applicable treatment standard*, otherwise, there is evidence that the standard is not met (see 63 FR 28567, March 26, 1998). Statistical variability is “built in” to the standards (USEPA 1991c). Wastes that do not meet treatment standards can not be land disposed unless EPA has granted a variance, extension, or exclusion (or the waste is managed in a “no-migration unit”). In addition to the disposal prohibition, there are prohibitions and limits in the LDR program regarding the dilution and storage of wastes. The program also requires tracking and recordkeeping to ensure proper management and safe land disposal of hazardous wastes.

General guidance on the LDR program can be found in *Land Disposal Restrictions: Summary of Requirements* (USEPA 2001d). Detailed guidance on preparing a waste analysis plan (WAP) under the LDR program can be found in *Waste Analysis at Facilities That Generate, Treat, Store, and Dispose of Hazardous Wastes - A Guidance Manual* (USEPA 1994a). Detailed guidance on measuring compliance with the alternative LDR treatment standards for contaminated soil can be found in *Guidance on Demonstrating Compliance With the Land Disposal Restrictions (LDR) Alternative Soil Treatment Standards* (USEPA 2002a).

2.2.3 Other RCRA Regulations and Programs That May Require Sampling and Testing

In addition to the RCRA hazardous waste identification regulations and the LDR regulations, EPA has promulgated other regulations and initiated other programs that may involve sampling and testing of solid waste and environmental media (such as ground water or soil). Program-specific EPA guidance should be consulted prior to implementing a sampling or monitoring program to respond to the requirements of these regulations or programs. For example, EPA has issued separate program-specific guidance on sampling to support preparation of a delisting petition, ground-water and unsaturated zone monitoring at regulated units, unit closure, corrective action for solid waste management units, and other programs. See also Appendix B of this document.

2.2.4 Enforcement Sampling and Analysis

The sampling and analysis conducted by a waste handler during the normal course of operating a waste management operation might be quite different than the sampling and analysis conducted by an enforcement agency. The primary reason is that the data quality objectives (DQOs) of the enforcement agency often may be legitimately different from those of a waste handler. Consider an example to illustrate this potential difference in approach: Many of

RCRA's standards were developed as concentrations that should not be exceeded (or equaled) or as characteristics that should not be exhibited for the waste or environmental media to comply with the standard. In the case of such a standard, the waste handler and enforcement officials might have very different objectives. An enforcement official, when conducting a compliance sampling inspection to evaluate a waste handler's compliance with a "do not exceed" standard, take only one sample. Such a sample may be purposively selected based on professional judgment. This is because all the enforcement official needs to observe – for example to determine that a waste is hazardous – is a single exceedance of the standard.

A waste handler, however, in responding to the same regulatory standard may want to ensure, with a specified level of confidence, that his or her waste concentrations are low enough so that it would be unlikely, for example, that an additional sample drawn from the waste would exceed the regulatory standard. In designing such an evaluation the waste handler could decide to take a sufficient number of samples in a manner that would allow evaluation of the results statistically to show, with the desired level of confidence, that there is a low probability that another randomly selected sample would exceed the standard.

An important component of the enforcement official's DQO is to "prove the positive." In other words, the enforcement official is trying to demonstrate whether the concentration of a specific constituent in some portion of the waste exceeds the "do not exceed" regulatory level. The "prove the positive" objective combined with the "do not exceed" standard only requires a single observation above the regulatory level in order to draw a valid conclusion that at least some of the waste exceeds the level of concern.

The Agency has made it clear that in "proving the positive," the enforcement agency's DQOs may not require low detection limits, high analyte recoveries, or high degrees of precision:

"If a sample possesses the property of interest, or contains the constituent at a high enough level relative to the regulatory threshold, then the population from which the sample was drawn must also possess the property of interest or contain that constituent. Depending on the degree to which the property of interest is exceeded, testing of samples which represent all aspects of the waste or other material may not be necessary to prove that the waste is subject to regulation" (see 55 FR 4440, "Hazardous Waste Management System: Testing and Monitoring Activities," February 8, 1990).

A waste handler may have a different objective when characterizing his or her waste. Instead, the waste handler may wish to "prove the negative." While proving the negative in absolute terms is not realistic, the waste handler may try to demonstrate with a desired level of confidence that the vast majority of his or her waste is well below the standard such that another sample or samples taken from the waste would not likely exceed the regulatory standard. The Agency also has spoken to the need for sound sampling designs and proper quality control when one is trying to "prove the negative:"

"The sampling strategy for these situations (proving the negative) should be thorough enough to insure that one does not conclude a waste is nonhazardous when, in fact, it is hazardous. For example, one needs to take enough samples so that one does not miss areas of high concentration in an otherwise clean material. Samples must be handled so that properties do not change and

contaminants are not lost. The analytical methods must be quantitative, and regulatory detection limits must be met and documented" (see 55 FR 4440, "Hazardous Waste Management System: Testing and Monitoring Activities," February 8, 1990).

"Proving the negative" can be a more demanding objective for the waste handler in terms of the sampling strategy and resources than that faced by the enforcement official. To address this objective the waste handler could use the advice in this or similar guidance documents. In doing so, the waste handler should establish objectives using a systematic planning process, design a sampling and analysis plan based on the objectives, collect and analyze the appropriate number of samples, and use the information from the sample analysis results for decision-making.

The distinction between a sampling strategy designed to "prove the negative" versus one designed to "prove the positive" also has been supported in a recent judicial ruling. In *United States v. Allen Elias* (9th Cir. 2001) the Government used a limited number of samples to prove that hazardous waste was improperly managed and disposed. The court affirmed that additional sampling by the Government was not necessary to "prove the positive."

3 FUNDAMENTAL STATISTICAL CONCEPTS

Throughout the life cycle of a waste-testing program, the tools of statistics often are employed -- in planning, implementation, and assessment. For example, in the planning phase, you may state certain project objectives quantitatively and use statistical terminology. Designing and implementing a sampling plan requires an understanding of error and uncertainty. Statistical techniques can be used to describe and evaluate the data and to support decisions regarding the regulatory status of a waste or contaminated media, attainment of treatment or cleanup goals, or whether there has been a release to the environment. Because statistical concepts may be used throughout the sampling and analysis program, an understanding of basic statistical concepts and terminology is important.

While statistical methods can be valuable in designing and implementing a scientifically sound waste-sampling program, their use should not be a substitute for knowledge of the waste or as a substitute for common sense. Not every problem can, or necessarily must, be evaluated using probabilistic techniques. Qualitative expressions of decision confidence through the exercise of professional judgment (such as a “weight of evidence” approach) may well be sufficient, and in some cases may be the only option available (Crumbling 2001).

Do the RCRA regulations require statistical sampling?

Some RCRA regulations *require* the use of statistical tests (e.g., to determine if there has been a release to ground water from a waste management unit under 40 CFR Subpart F), whereas, other RCRA regulations *do not* require the use of statistical tests (such as those for determining if a solid waste is or is not a hazardous waste or determining compliance with LDR treatment standards). Even where there is no regulatory obligation to conduct sampling or apply statistical tests to evaluate sampling results, statistical methods can be useful in interpreting data and managing uncertainty associated with waste classification decisions.

If the objective of the sampling program is to make a hazardous waste determination, the regulations allow that a single representative sample is sufficient to classify a waste as hazardous. If a representative sample is found to have the properties set forth for the corrosivity, ignitability, reactivity, or toxicity characteristics, then the waste is hazardous. The regulations do not address directly what is a sufficient number of samples to classify a solid waste as *nonhazardous*. However, for a petition to reclassify (delist) a listed hazardous waste, which includes a determination that the listed hazardous waste is not a characteristic hazardous waste (a “nonhazardous” classification), the regulations provide that at least four representative samples sufficient to represent the variability or uniformity of the waste must be tested (40 CFR 260.22). This approach is not necessarily based on any statistical method but reflects concepts of proving the negative and proving the positive (see also Section 2.2.4).

Even if you have no formal training in statistics, you probably are familiar with basic statistical concepts and how samples are used to make inferences about the population from which the samples were drawn. For example, the news media frequently cite the results of surveys that make generalized conclusions about public opinion based on interviews with a relatively small proportion of the population. These results, however, are only *estimates* because no matter how carefully a survey is done, if repeated over and over in an identical manner, the answer will be a little different each time. There always will be some random sampling variation because it is not possible to survey every member of a population. There also will be measurement and estimation errors because of mistakes made in how data are obtained and interpreted. Responsible pollsters report this as their “margin of error” along with the findings of the survey

(Edmondson 1996).

Similar to surveys of human populations, waste characterization studies can be designed in such a way that a population can be identified, samples can be collected, and the uncertainty in the results can be reported.

The following sections provide a brief overview of the statistical concepts used in this guidance. Four general topics are described:

- Populations, samples, and distributions (Section 3.1)
- Measures of central tendency, variability, and relative standing (Section 3.2)
- Precision and bias (Section 3.3)
- Using sample analysis results to classify a waste or determine its status under RCRA (Section 3.4).

Guidance on selecting and using statistical methods for evaluating data is given in Section 8.2 and Appendix F of this document. Statistical tables are given in Appendix G. Additional statistical guidance can be found in *Guidance for Data Quality Assessment, EPA QA/G-9* (USEPA 2000d) and other references cited.

3.1 Populations, Samples, and Distributions

A “population” consists of all the waste or media whose characteristics are to be studied and estimated. A set of observations, known as a statistical sample, is a portion of the population that is studied in order to learn about the whole population. Sampling is necessary when a study of the entire population would be too expensive or physically impossible.

Inferences about the population are made from samples selected from the population. For example, the sample mean (or average) is a consistent estimator of the population mean. In general, estimates made from samples tend to more closely approximate the true population parameter as the number of samples increases. The precision of these inferences depends on the theoretical sampling distribution of the statistic that would occur if the sampling process were repeated over and over using the same sampling design and number of samples.

3.1.1 Populations and Decision Units

A “population” is the *entire* selection of interest for study. Populations can have *spatial* boundaries, which define the physical area to be studied, and *temporal* boundaries, which describe the time interval the study will represent. The definition of the population can be subjective, defined by regulation or permit condition, or based on risks to human health and the environment. In all cases, however, the population needs to be finite and have well-defined, unambiguous physical and/or temporal boundaries. The physical boundary defines the size, shape, orientation, and location of the waste or media about which a decision will be made.

For a large population of waste or media, you may wish to subdivide the population into smaller units about which decisions can be made, rather than attempt to characterize the entire

population. These units are called “decision units,” and they may represent a single type of waste at the point of waste generation, a waste from a single batch operation, waste generated over a specified time, or a volume of waste or contaminated media (such as soil) subject to characterization, removal, and/or treatment. The concept of a decision unit is similar to an “exposure unit” (Neptune, et al. 1990, Blacker and Goodman 1994a and 1994b, Myers 1997), or “exposure area” (USEPA 1992a and 1996a) in EPA’s Superfund program in which risk-based decisions consider the mass or area of the waste or media. A decision unit also is analogous to a “remediation unit” as described in EPA’s *Data Quality Objective Process for Superfund* (USEPA 1993a).

When using samples to determine whether a solid waste is a hazardous waste, that determination must be made at the **point of generation** (i.e., when the waste becomes a solid waste).

Hypothetical examples of populations or decision units that might be encountered in the context of RCRA waste characterization follow:

- Filter cake being placed in a 25-cubic-yard roll-off bin at the point of waste generation
- Waste water contained in a 55-gallon drum
- Liquid waste flowing from the point of generation during a specified time interval
- A block of soil (e.g., 10-feet-by-10-feet square, 6-inches deep) within a solid waste management unit (SWMU).

In some situations, it will be appropriate to define two separate populations for comparison to each other. For example, in monitoring a land-based waste management unit to determine if there has been a release to the subsurface at statistically significant levels above background, it is necessary to establish two populations: (1) a background population and (2) an exposed (or downgradient) population in the soil, pore-water, or ground-water system.

In situations in which the boundaries of the waste or contamination are not obvious or cannot be defined in advance (such as the case of contaminated soil *in situ*, as opposed to excavated soil in a pile), the investigator is interested in the *location* of the contamination as well as the concentration information. Such a sampling objective is best addressed by spatial analysis, for example, by using geostatistical methods (See also Section 3.4.4).

3.1.2 Samples and Measurements

Samples are portions of the population. Using information from a set of samples (such as measurements of chemical concentrations) and the tools of inductive statistics, inferences can be made about the population. The validity of the inferences depends on how closely the samples represent the physical and chemical properties of the population of interest.

In this document, we use the word “sample” in several different ways. To avoid confusion, definitions of terms follow:

Sample: A portion of material that is taken from a larger quantity for the purpose of estimating properties or composition of the larger quantity (from ASTM D 6233-98).

Statistical sample: A set of samples or measurements selected by probabilistic means (i.e., by using some form of randomness).

We sometimes refer to a “set of samples” to indicate more than one individual sample that may or may not have been obtained by probabilistic means.

Outside the fields of waste management and environmental sciences, the concept of a sample or “sampling unit” is fairly straightforward. For example, a pollster measures the opinions of individual human beings, or the QC engineer measures the diameter of individual ball bearings. It is easy to see that the measurement and the sampling unit correspond; however, in sampling waste or environmental media, *what is the appropriate “portion” that should be in a sampling unit?* The answer to this question requires consideration of the heterogeneities of the sample media and the dimension of the sampling problem (in other words, are you sampling over time or sampling over space?). The information can be used to define the appropriate *size, shape, and orientation* of the sample. The size, shape, and orientation of a sample are known as the **sample support**, and the sample support will affect the measurement value obtained from the sample.

As shown in Figure 2, after a sample of a certain *size, shape, and orientation* is obtained in the field (as the primary sample), it is handled, transported, and prepared for analysis. At each stage, changes can occur in the sample (such as the gain or loss of constituents, changes in the particle size distribution, etc.). These changes accumulate as errors throughout the sampling process such that measurements made on relatively small analytical samples (often less than 1 gram) may no longer “represent” the population of interest. Because sampling and analysis results may be relied upon to make decisions about a waste or media, it is important to understand the sources of the errors introduced at each stage of sampling and take steps to minimize or control those errors. In doing so, samples will be sufficiently “representative” of the population from which they are obtained.

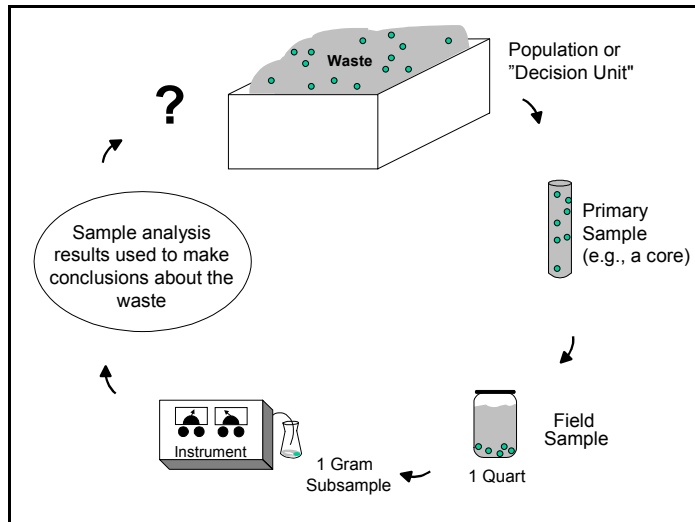

Figure 2. Very small analytical samples are used to make decisions about much larger volumes (modified after Myers 1997).

The RCRA solid waste regulations at 40 CFR §260.10 define a **representative sample** as:

“a sample of a universe or whole (e.g., waste pile, lagoon, ground water) which can be expected to exhibit the average properties of the universe or whole.”

RCRA implementors, at a minimum, must use this definition when a representative sample is called for by the regulations. Various other definitions of a representative sample have been developed by other organizations. For example, ASTM in their consensus standard D 6044-96 defines a representative sample as “a sample collected in such a manner that it reflects one or more characteristics of interest (as defined by the project objectives) of a population from which it was collected” (ASTM D 6044). A detailed discussion of representativeness also is given in *Guidance on Data Quality Indicators* (USEPA 2001e).

3.1.3 Distributions

Because the concentration of constituents of concern will not be the same for every individual sample, there must be a *distribution* of concentrations among the population. Understanding the distributional characteristics of a data set is an important first step in data analysis.

If we have a sufficient number of samples selected from a population, a picture of the distribution of the sample data can be represented in the form of a **histogram**. A histogram, which offers a simple graphical representation of the shape of the distribution of data, can be constructed by dividing the data range into units or “bins” (usually of equal width), counting the number of points within each unit, and displaying the data as the height or area within a bar graph. Figure 3 is an example of a histogram made using analysis results for total lead in 11 samples of No. 2 fuel oil (data set from USEPA 1998b). Guidance on constructing histograms can be found in EPA’s *Guidance for Data Quality Assessment, EPA QA/G-9* (USEPA 2000d).

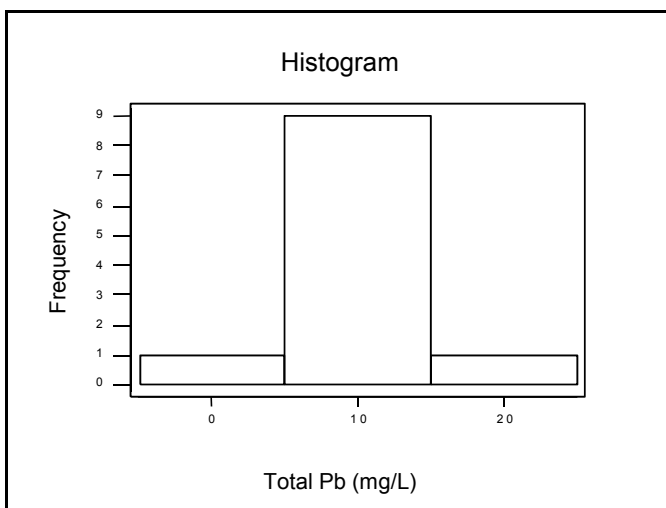

Figure 3. Histogram representing the distribution of total lead (Pb) in 11 samples of No. 2 fuel oil (USEPA 1998b).

With a sufficiently large number of samples, the bars of the histogram could be “blended together” to form a curve known as a probability density function (PDF). Figure 4 shows two probability density functions you might encounter: Figure 4(a) is a **normal distribution** with its familiar symmetrical mound-shape. Figure 4(b) is a **lognormal distribution** in which the natural log-transformed values exhibit a normal distribution. A lognormal distribution indicates that a relatively small proportion of the population includes some relatively large values.

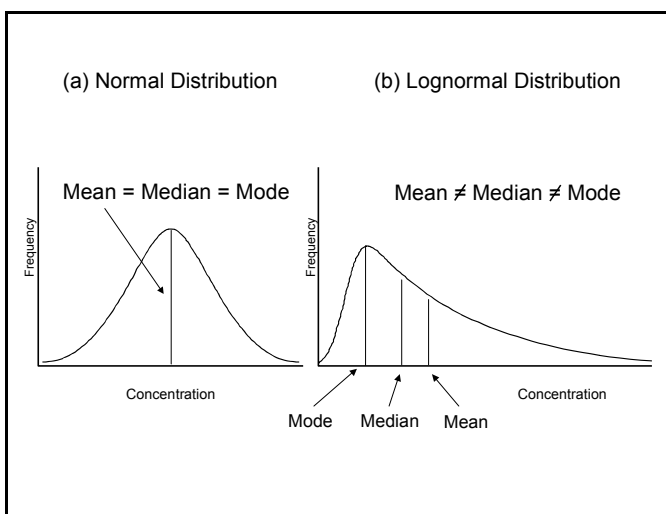

Figure 4. Examples of two distributions: (a) normal distribution and (b) lognormal distribution

Many of the tools used in statistics are based on the assumption that the data are normally distributed, can be transformed to a normal scale, or can be treated as if they are approximately normal. The assumption of a normal distribution often can be made without significantly increasing the risk of making a “wrong” decision. Of course, the normal and lognormal distributions are *assumed* models that only approximate the underlying population distribution.

Another distribution of interest is known as the **binomial distribution**. The binomial distribution can be used when the sample analysis results are interpreted as either “fail” or “pass” (e.g., a sample analysis result either exceeds a regulatory standard or does not exceed the standard).

In some cases, you may not be able to “fit” the data to any particular distributional model. In these situations, we recommend you consider using a “distribution-free” or “nonparametric” statistical method (see Section 8.2).

A simple but extremely useful graphical test for normality is to graph the data as a **probability plot**. In a probability plot, the vertical axis has a probability scale and the horizontal axis has a data scale. In general, if the data plot as a straight line, there is a qualitative indication of normality. If the natural logarithms of the data plot as a straight line, there is an indication of lognormality.

Figure 5 provides an example of a normal probability plot created from the same data used to generate the histogram in Figure 3. Guidance on constructing probability plots can be found in EPA’s *Guidance for Data Quality Assessment, EPA QA/G-9* (USEPA 2000d).

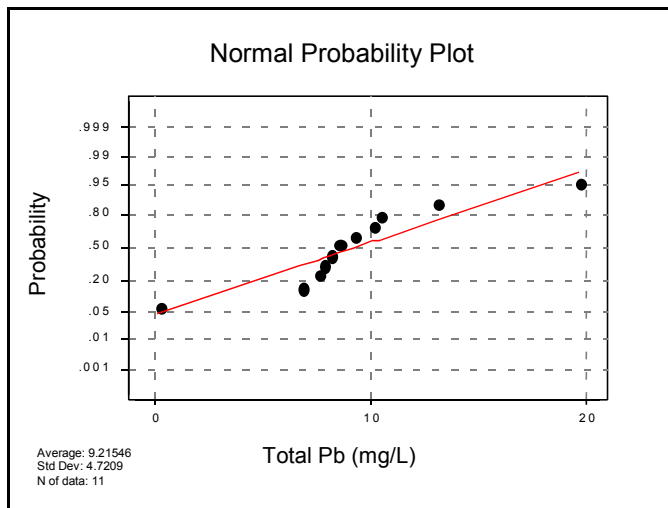

Figure 5. Normal probability plot

Section 8 (Assessment: Analyzing and Interpreting Data) provides guidance on checking the distribution of data sets and provides strategies for handling sample data exhibiting a non-normal distribution.

3.2 Measures of Central Tendency, Variability, and Relative Standing

In addition to graphical techniques for summarizing and describing data sets, numerical methods can be used. Numerical methods can be used to describe the central tendency of the set of measurements, the variability or spread of the data, and the relative standing or relative location of a measurement within a data set.

3.2.1 Measures of Central Tendency

The average or **mean** often is used as a measure of central tendency. The mean of a set of quantitative data is equal to the sum of the measurements divided by the number of measurements contained in the data set. Other measures of central tendency include the

median (the midpoint of an ordered data set in which half the values are below the median and half are above) and the **mode** (the value that occurs most often in the distribution). For distributions that are not symmetrical, the median and the mean do not coincide. The mean for a lognormal distribution, for instance, will exceed its median (see Figure 4(b)).

The true **population mean**, μ ("mu"), is the average of the true measurements (e.g., of the constituent concentration) made over all possible samples. The population mean is never known because we cannot measure all the members of a population (or all possible samples). We can, however, *estimate* the population mean by taking random samples from the population. The average of measurements taken on random samples is called the **sample mean**. The sample mean is denoted by the symbol \bar{x} ("x-bar") and calculated by summing the value obtained from each random sample (x_i) and dividing by the number of samples (n):

$$\bar{x} = \frac{1}{n} \sum_{i=1}^n x_i \quad \text{Equation 1}$$

Box 1 provides an example calculation of the sample mean.

Box 1. Example Calculation of the Sample Mean

Using Equation 1 and the following four data points in parts per million (ppm): 86, 90, 98, and 104, the following is an example of computing the sample mean.

$$\bar{x} = \frac{1}{n} \sum_{i=1}^n x_i = \frac{86 + 90 + 98 + 104}{4} = 95 \text{ ppm}$$

Therefore, the sample mean is 95 ppm.

3.2.2 Measures of Variability

Random variation in the population is described by "dispersion" parameters -- the **population variance** (σ^2) and the **population standard deviation** (σ). Because we cannot measure all possible samples that comprise the population, the values for σ^2 and σ are unknown. The variance, however, can be *estimated* from a statistical sample of the population by the **sample variance**:

$$s^2 = \frac{1}{n-1} \sum_{i=1}^n (x_i - \bar{x})^2 \quad \text{Equation 2}$$

The variance calculated from the samples is known as the **sample variance** (s^2) and it includes random variation in the population as well as random variation that can be introduced by sample collection and handling, sample transport, and sample preparation and analysis. The sample variance is an estimate of the variance that one would obtain if the entire set of all possible samples in the population were measured using the same measurement process as is

being employed for the n samples. If there were no sample handling or measurement error, this sample variance (s^2) would estimate the population variance (σ^2).

The **population standard deviation** (σ) is estimated by s , the **sample standard deviation**:

$$s = \sqrt{s^2} \quad \text{Equation 3}$$

Box 2 provides an example calculation of the sample variance and sample standard deviation.

Box 2. Example Calculations of Sample Variance and Standard Deviation

Using Equation 2 and the data points in Box 1, the following is an example calculation of the sample variance:

$$s^2 = \frac{[(86 - 94.5)^2 + (90 - 94.5)^2 + (98 - 94.5)^2 + (104 - 94.5)^2]}{4 - 1} = \frac{195}{3} = 65$$

Using Equation 3, the sample standard deviation is then calculated as follows:

$$s = \sqrt{s^2} = 8.1$$

The standard deviation is used to measure the variability in a data set. For a normal distribution, we know the following (see Figure 6):

- Approximately 68 percent of measurements will fall within ± 1 standard deviation of the mean
- Approximately 95 percent of the measurements will fall within ± 2 standard deviations of the mean
- Almost all (99.74 percent) of the measurements will fall within ± 3 standard deviations of the mean.

Estimates of the standard deviation, combined with the assumption of a normal distribution, allow us to make quantitative statements about the spread of the data. The larger the spread in the data, the less certainty we have in estimates or decisions made from the data. As discussed in the following section, a small spread in the data offers

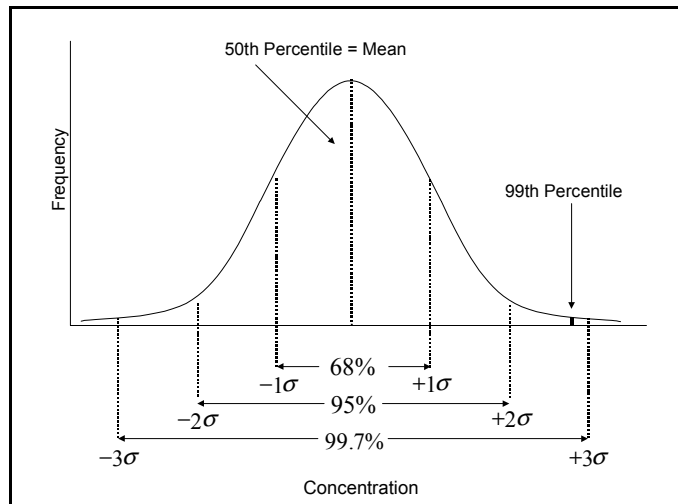

Figure 6. Percentage of values falling within 1, 2, and 3 standard deviations of the mean of a normal distribution. The figure also shows the relationship between the mean, the 50th percentile, and the 99th percentile in a normal distribution.

more certainty in estimates and decisions made from the data.

Because \bar{x} is an estimate of a population parameter based on a statistical sample, we expect its value to be different each time a new set of samples is drawn from the population. The means calculated from repeated statistical samples also form a distribution. The estimate of the standard deviation of the sampling distribution of means is called the **standard error**.

The standard error of the mean ($s_{\bar{x}}$) is estimated by:

$$s_{\bar{x}} = \frac{s}{\sqrt{n}} \quad \text{Equation 4}$$

The standard error is used in equations to calculate the appropriate number of samples to estimate the mean with specified confidence (see Section 5.4), and it is used in statistical tests to make inferences about \bar{x} (see Appendix F).

3.2.3 Measures of Relative Standing

In addition to measures of central tendency and variability to describe data, we also may be interested in describing the relative standing or location of a particular measurement within a data set. One such measure of interest is the **percentile** ranking. A population percentile represents the percentage of elements of a population having values less than a specified value. Mathematically, for a set of n measurements the p th percentile (or quantile) is a number such that $p\%$ of the measurements fall below the p th percentile, and $(100 - p)\%$ fall above it. For example, if a measurement is located at the 99th percentile in a data set, it means that 99 percent of measurements are less than that measurement, and 1 percent are above. In other words, almost the *entire* distribution lies below the value representing the 99th percentile. Figure 6 depicts the relationship between the mean, the 50th percentile, and the 99th percentile in a normal distribution.

Just like the mean and the median, a percentile is a population parameter that must be estimated from the sample data. As indicated in Figure 6, for a normal distribution a “point estimate” of a percentile (\hat{x}_p) can be obtained using the sample mean (\bar{x}) and the sample standard deviation (s) by:

$$\hat{x}_p = \bar{x} + z_p s \quad \text{Equation 5}$$

where z_p is the p th quantile of the standard normal distribution. (Values of z_p that correspond to values of p can be obtained from the last row of Table G-1 in Appendix G). A probability plot (see Figure 5) offers another method of estimating normal percentiles. See EPA’s *Guidance for Data Quality Assessment, EPA QA/G-9* (USEPA 2000d) for guidance on constructing probability plots and estimating percentiles.

3.3 Precision and Bias

The representativeness of a statistical sample (that is, a set of samples) can be described in terms of **precision** and **bias**. Precision is a measurement of the *closeness of agreement* between repeated measurements. Bias is the systematic or consistent over- or underestimation of the true value (Myers 1997, USEPA 2000d).

The analogy of a target often is used to illustrate the concepts of precision and bias. In Figure 7, the center of each target represents the true (but unknown) average concentration in a batch of waste. The “shots” in targets (a) through (d) represent measurement results from samples taken to estimate the true concentration. The figure also can be used to illustrate precision and bias associated with measurement processes within a laboratory in which the same sample is analyzed multiple times (for example, four times).

Figure 7(a) indicates high precision and low bias in the sampling and analysis results. Generally, high precision and minimal bias are required when one or more chemical constituents in a solid waste are present at concentrations close to the applicable regulatory threshold or action level. Note that each of the measurements in Figure 7(a) is in close agreement with the true value.

These measurements can be described as having high **accuracy**.

If the sampling and measurement process is very precise but suffers from bias (such as use of an incorrect sampling procedure or contamination of an analytical instrument), the situation could be as pictured in Figure 7(b) in which the repeated measurements are close to one another but not close to the true value. In fact, the data express a significant 70 percent bias that might go undetected if the true value is not known.

The opposite situation is depicted in Figure 7(c), where the data show low precision (that is, high dispersion around the mean) but are unbiased because the samples lack any systematic error and the average of the measurements reflects the true average concentration. Precision in sampling can be improved by increasing the number of samples, increasing the volume

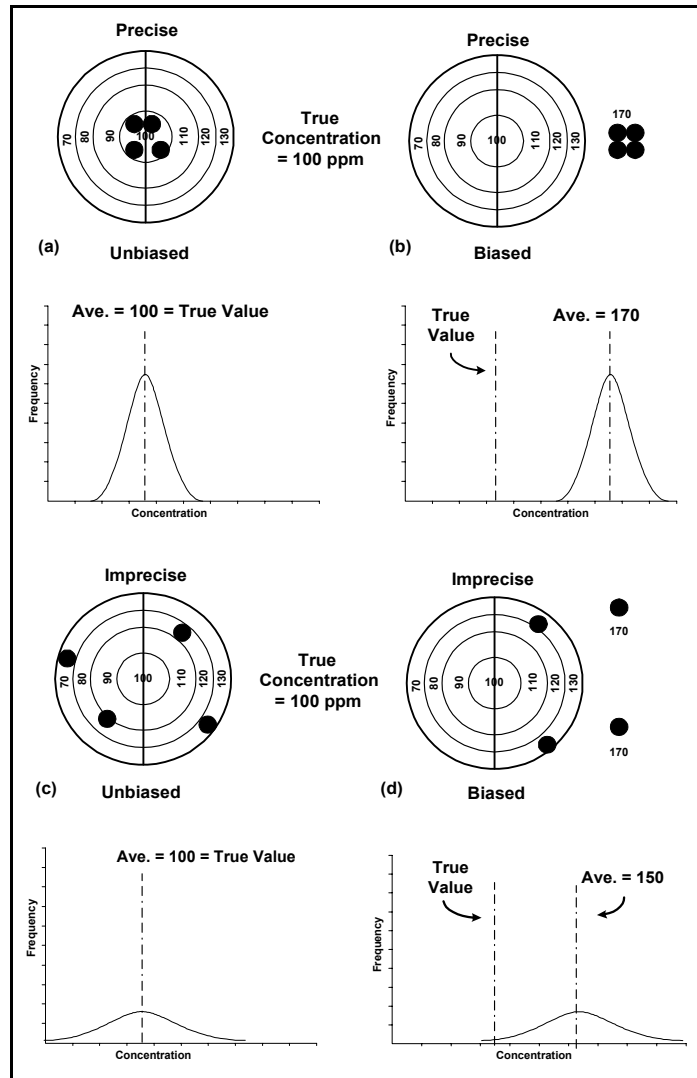

Figure 7. Shots at a target illustrate precision and bias (modified after Jessen 1978).

(mass) of each sample, or by employing a composite sampling strategies. Note, however, that relatively imprecise results can be tolerated if the contaminants of concern occur at levels either far below or far above their applicable thresholds.

Figure 7(d) depicts the situation where the sampling and analytical process suffers from both imprecision and bias. In both Figures 7(b) and (d), the bias will result in an incorrect estimate of the true concentration, even if innumerable samples are collected and analyzed to control the impact of imprecision (i.e., bias will not “cancel out” with increasing numbers of samples).

There are several types and causes of bias, including sampling bias, analytical bias, and statistical bias:

Sampling Bias: There are three potential sources of sampling bias: (1) Bias can be introduced in the field and the laboratory through the improper selection and use of devices for sampling and subsampling. Bias related to sampling tools can be minimized by ensuring all of the material of interest for the study is accessible by the sampling tool. (2) Bias can be introduced through improper design of the sampling plan. Improper sampling design can cause parts of the population of interest to be over- or under-sampled, thereby causing the estimated values to be systematically shifted away from the true values. Bias related to sampling design can be minimized by ensuring the sampling protocol is impartial so there is an equal chance for each part of the waste to be included in the sample over both the spatial and temporal boundaries defined for the study. (3) Bias can be introduced in sampling due to the loss or addition of contaminants during sampling and sample handling. This bias can be controlled using sampling devices made of materials that do not sorb or leach constituents of concern, and by use of careful decontamination and sample handling procedures. For example, agitation or homogenization of samples can cause a loss of volatile constituents, thereby indicating a concentration of volatiles lower than the true value. Proper decontamination of sampling equipment between sample locations or the use of disposable devices, and the use of appropriate sample containers and preservatives also can control bias in field sampling.

Analytical Bias: Analytical (or measurement) bias is a systematic error caused by instrument contamination, calibration drift, or by numerous other causes, such as extraction inefficiency by the solvent, matrix effect, and losses during shipping and handling.

Statistical Bias: After the sample data have been obtained, statistics are used to estimate population parameters using the sample data. Statistical bias can occur in two situations: (1) when the assumptions made about the sampling distribution are not consistent with the underlying population distribution, or (2) when the statistical estimator itself is biased.

Returning to Figure 7, note that each target has an associated frequency distribution curve. Frequency curves are made by plotting a concentration value versus the frequency of occurrence of that concentration. The curves show that as precision decreases (i.e., the variance σ^2 increases), the curve flattens out and an increasing number of measurements are found further away from the average (figures c and d). More precise measurements result in steeper curves (figures a and b) with the majority of measurements relatively closer to the

average value in normally distributed data. The greater the bias (figures b and d) the further the average of the measurements is shifted away from the true value. The smaller the bias (figures a and c) the closer the average of the samples is to the true average.

Representative samples are obtained by controlling (at acceptable levels) random variability (σ^2) and systematic error (or bias) in sampling and analysis. Quality control procedures and samples are used to estimate the precision and bias of sampling and analytical results.

3.4 Using Sample Analysis Results to Classify a Waste or to Determine Its Status Under RCRA

If samples are used to classify a waste or determine its regulatory status, then the sampling approach (including the number and type of samples) must meet the requirements specified by the regulations. Regardless of whether or not the regulations specify sampling requirements or the use of a statistical test, the Agency encourages waste handlers to use a systematic planning process such as the DQO Process to set objectives for the type, quantity, and quality of data needed to ensure with some known level of assurance that the regulatory standards are achieved.

After consideration of the objectives identified in the planning process, careful implementation of the sampling plan, and review of the analytical results, you can use the sample analysis results to classify a waste or make other decisions regarding the status of the waste under RCRA. The approach you select to obtain and evaluate the results will be highly dependent on the regulatory requirements (see Section 2 and Appendix B) and the data quality objectives (see Section 4 and Section 5).

The following sections provide a conceptual overview of how you can use sample analysis results to classify a waste or determine its status under RCRA. Guidance is provided on the following topics:

- Using an *average* to measure compliance with a fixed standard (Section 3.4.1)
- Using the *maximum* sample analysis result or an upper *percentile* to measure compliance with a fixed standard (Section 3.4.2)

There are other approaches you might use to evaluate sample analysis results, including tests that compare two populations, such as “downgradient” to “background” (see Section 3.4.3), and analysis of spatial patterns of contamination (see Section 3.4.4).

Detailed statistical guidance, including the necessary statistical equations, is provided in Section 8.2 and Appendix F.

3.4.1 Using an Average To Determine Whether a Waste or Media Meets the Applicable Standard

The arithmetic average (or mean) is a common parameter used to determine whether the concentration of a constituent in a waste or media is below a fixed standard. The mean often is used in cases in which a long-term (chronic) exposure scenario is assumed (USEPA 1992c) or where some average condition is of interest.

Because of the uncertainty associated with estimating the true mean concentration, a **confidence interval on the mean** is used to define the upper and lower limits that bracket the true mean with a known level of confidence. If the **upper confidence limit (UCL)** on the mean is less than the fixed standard, then we can conclude the true average is below the standard with a known amount of confidence. As an alternative to using a statistical interval to draw conclusions from the data, you could use hypothesis testing as described in EPA's *Guidance for the Data Quality Objectives Process, EPA QA/G-4* (USEPA 2000b) and *Guidance for Data Quality Assessment, EPA QA/G-9* (USEPA 2000d).

Confidence intervals are calculated using the sample analysis results. Figure 8 shows what is expected to happen when ten different sets of samples are drawn from the same waste and a confidence interval for the mean is calculated for each set of samples. The true (but unknown) mean (μ) – shown as a vertical line – does not change, but the positions of the *sample means* (\bar{x}) and confidence intervals (shown as the horizontal lines) do change. For most of the sampling events, the confidence interval contains the true mean, but sometimes it does not. In this particular example, we expect 8 out of 10 intervals to contain the true mean, so we call this an “80-percent confidence interval on the mean.” In practice, you only have one set of data from one sampling event, not ten. Note that an equal degree of uncertainty is associated with the parameter of interest being located outside each of the two interval endpoints. Consequently, the confidence interval employed in this example is, for all practical purposes, a 90-percent interval. We will refer to this as a “one-sided 90-percent confidence limit on the mean.” Of course, other levels of confidence could be used, such as a 95-percent confidence limit.

The *width* of the confidence interval (defined by the upper and lower confidence limits) is an indicator of the precision of the estimate of the parameter of interest. Generally, one can improve precision (i.e., reduce the standard error, s / \sqrt{n}) by taking more samples, increasing the physical size of each

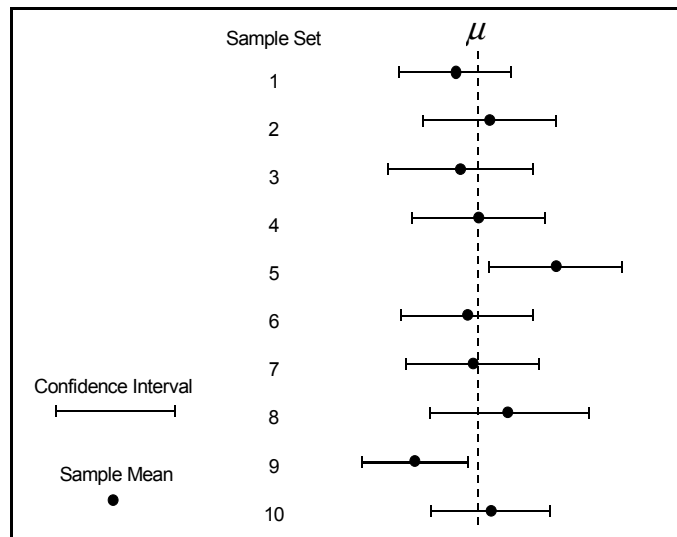

Figure 8. 80-percent confidence intervals calculated from 10 equal-sized sets of samples drawn at random from the same waste stream

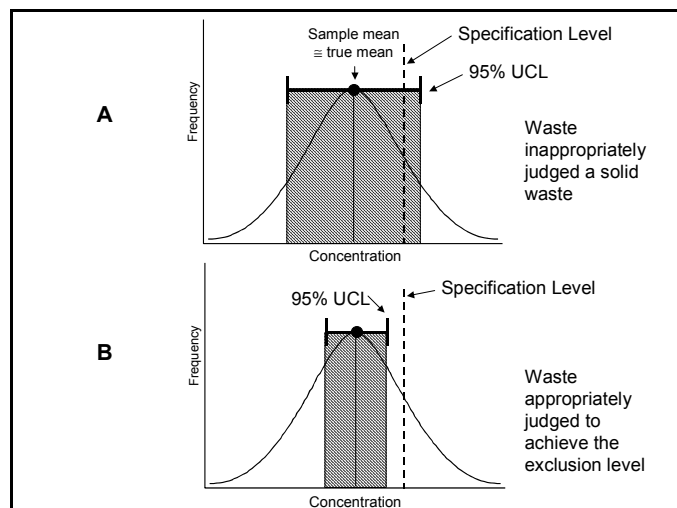

Figure 9. Example of how sampling precision could impact a waste exclusion demonstration under 40 CFR 261.38. Due to imprecision (A), the waste is inappropriately judged a solid waste. With more precise results (B), the entire confidence interval lies below the specification level, and the waste is appropriately judged eligible for the comparable fuels exclusion.

sample (i.e., increasing the sample support), and by minimizing random variability introduced in the sampling and measurement processes.

For example, Figure 9 shows how sampling precision can affect the ability to claim an exclusion from the definition of solid waste under the comparable fuels regulations at 40 CFR 261.38. In Figure 9 “A,” the sampling results are unbiased, but they are not sufficiently precise. In fact, the imprecision causes the confidence intervals to “straddle” the specification level; thus, there is not *statistically significant* evidence that the mean is below the standard. Imprecision can be caused by the heterogeneity of the material sampled, by random errors in the field and laboratory, and by too few samples. In Figure 9 “B,” the results also are unbiased, but significant improvement in precision is observed (e.g., because more or larger samples were analyzed and errors were kept within acceptable limits), allowing us to conclude that the mean is indeed below the specification level.

Detailed guidance on the calculation of confidence limits for the mean can be found in Appendix F of this document.

3.4.2 Using a Proportion or Percentile To Determine Whether a Waste or Media Meets an Applicable Standard

Under RCRA, some regulatory thresholds are defined as concentration values that cannot be exceeded (e.g., the RCRA LDR program concentration-based treatment standards for hazardous waste specified at § 268.40 and § 268.48), concentration values that cannot be equaled or exceeded (e.g., the Toxicity Characteristic maximum concentration levels specified at § 261.24), or waste properties that cannot be exhibited (e.g., ignitability per § 261.21, corrosivity per § 261.22, or reactivity per § 261.23) for the waste to comply with the regulatory standard.

To demonstrate compliance with such a standard using sampling, it is necessary to consider the waste or site (whose boundaries are defined as a decision unit) as a population of discrete sample units (of a defined size, shape, and orientation). Ideally, none of these sample units may exceed the standard or exhibit the properties of concern for the waste or site to be in compliance with the standard. However, since it is not possible to know the status of all portions of a waste or site, samples must be used to infer - using statistical methods - what proportion or percentage of the waste complies, or does not comply, with the standard. Generally, few if any samples drawn from the population of interest may exceed the regulatory standard or exhibit the property of concern to demonstrate with reasonable confidence that a high proportion or percentage of the population complies with the standard.

Two simple methods for measuring whether a specified proportion or percentile of a waste or media meets an applicable standard are described in the following sections:

- Using an upper confidence limit on a percentile to classify a waste or media (Section 3.4.2.1), and
- Using a simple exceedance rule method to classify a waste or media (Section 3.4.2.2).

3.4.2.1 Using a Confidence Limit on a Percentile to Classify a Waste or Media

A percentile is a population parameter. We cannot know the true value of that parameter, but we can *estimate* it from a statistical sample drawn from the population by using a **confidence interval for a percentile**. If the **upper confidence limit (UCL) on the upper percentile** is below the fixed standard, then there is statistically significant evidence that the specified proportion of the waste or media attains the standard (see Figure 10). If the UCL on the upper percentile exceeds the standard (but all sample analysis results are below the standard), then the waste or media still could be judged in compliance with the standard; however, you would not have the specified degree of confidence that the specified proportion of the waste or media complies with the standard (see also the exceedance rule method, Section 3.4.2.2).

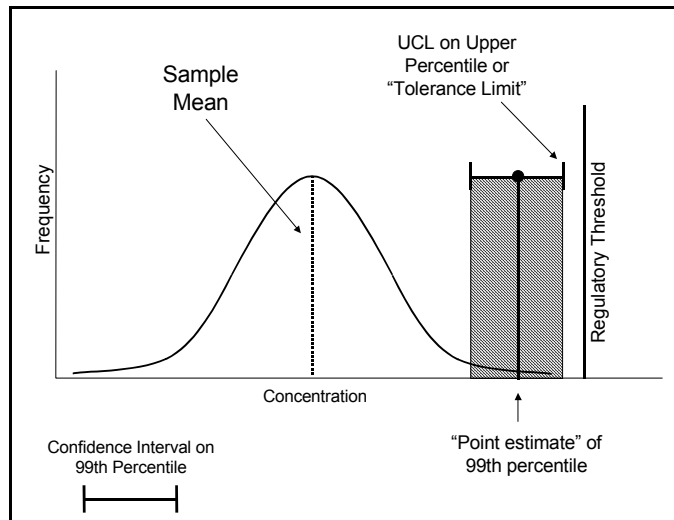

Figure 10. For a high percentile (e.g., the 99th percentile) to be less than an applicable standard, the mean concentration must be well below the standard.

Detailed guidance on the calculation of confidence limits for percentiles can be found in Section 8.2 and Appendix F of this document. Methods also are given in Conover (1999), Gilbert (1987, page 136), Hahn and Meeker (1991), and USEPA (1989a). A possible alternative to using a confidence limit on a percentile is the use of the “one-sample test for proportions” (see Section 3.2.2.1 of USEPA 2000d).

3.4.2.2 Using a Simple Exceedance Rule Method To Classify a Waste

One of the most straightforward methods for determining whether a given proportion or percentage of a waste (that is, all possible samples of a given sample support) complies with an applicable standard is to use a simple exceedance rule. To apply the method, simply obtain a number of samples and require that zero or few sample analysis results be allowed to exceed the applicable standard or possess the property (or “attribute”) of interest. The method (also known as “inspection by attributes”) is from a class of methods known as acceptance sampling plans (Schilling 1982, ASQ 1988 and 1993, and DoD 1996). One simple form of the exceedance rule, sometimes used by regulatory enforcement agencies, specifies zero exceedances in a set of samples. This method can be used to classify a waste (i.e., determine if it exhibits the characteristics of ignitability, corrosivity, reactivity¹, or toxicity) or to determine its status under RCRA (that is, to determine if the waste is prohibited from land disposal or if it attains an LDR treatment standard).

The method is attractive because it is simple (e.g., because sample analysis results are

¹ EPA uses a narrative criteria to define most reactive wastes, and waste handlers should use their knowledge to determine if a waste is sufficiently reactive to be regulated.

recorded as either “pass” or “fail” and statistical tables can be used instead of equations), it does not require an assumption about the form of the underlying distribution, and it can be used when a large proportion of the data are reported as less than a quantitation limit. Furthermore, the method has statistical properties that allow the waste handler to have a known level of confidence that at least a given proportion of the waste complies with the standard. One potential drawback of using an exceedance rule is that with a small number of samples, you might not be able to conclude with high confidence that a high proportion of the waste complies with the applicable standard (unless you have sufficient knowledge of the waste indicating there is little variability in concentrations or properties). That is, with a small number of samples, there is little statistical power: an unacceptably large proportion of the waste or site could exceed the standard or exhibit the property even though no such exceedances or properties were observed in the samples. Increasing the number of samples will improve the statistical performance.

As a practical matter, it is suggested that you scale the statistical performance and acceptance requirements (and thus, the number of samples) to the size of the lot or batch of waste of interest. For example, when large and/or very heterogeneous volumes of waste are the subject of the study, decision-makers may require high confidence that a high proportion of the waste meets the applicable standard. A relatively large number of samples will be required to satisfy these criteria if the exceedance rule is used. On the other hand, decision-makers may choose to relax the statistical performance criteria when characterizing a small volume of waste (or a very homogeneous waste) and thus fewer samples would be needed.

Detailed guidance on the use of an exceedance rule is provided in Section 5.5.2 and in Appendix F, Section F.3.2, of this document. The exceedance rule method also is described in *Methods for Evaluating the Attainment of Cleanup Standards. Volume 1: Soils and Solid Media* (USEPA 1989a, Section 7.4).

3.4.3 Comparing Two Populations

Some environmental studies do not involve testing compliance against a fixed standard but require comparison of two separate data. This type of analysis is common for detecting releases to ground water at waste management units such as landfills and surface impoundments, detecting releases to soil and the unsaturated zone at land treatment units, or determining if site contamination is distinguishable from natural background concentrations. In these situations, the operator must compare “on site” or “downgradient” concentrations to “background.”

For example, at a new land-based waste management unit (such as a new landfill), we expect the concentrations in a set of samples from downgradient locations to be similar to a set of samples from background locations. If a statistically significant change in downgradient conditions is detected, then there may be evidence of a release to the environment. Statistical methods called *two-sample tests* can be used to make such comparisons (they are called two-sample tests because two *sets* of samples are used). A two-sample test also could be used to measure changes in constituent concentrations in a waste or soil “before” treatment and “after” treatment to assess the effectiveness of the treatment process (see USEPA 2002a).

For detailed guidance on the use of two-sample tests, see EPA’s G-9 guidance (USEPA 2000d) and EPA’s guidance on the statistical analysis of ground-water monitoring data (USEPA 1989b).

and 1992b).

Note that detecting a release to the environment may not necessarily involve use of a statistical test and may not even involve sampling. For example, observation of a broken dike at a surface impoundment may indicate that a release has occurred.

3.4.4 Estimating Spatial Patterns

Under some circumstances, a site investigator may wish to determine the location of a contaminant in the environment as well as its concentration. Knowledge of spatial trends or patterns may be of particular value when conducting risk assessments or locating areas for clean-up or removal under the RCRA Corrective Action program. Estimation of spatial patterns is best addressed by geostatistics or other spatial data analysis methods.

Geostatistical models are based on the notion that elements of the population that are close together in space and/or time exhibit an identifiable relationship or positive correlation with one another. Geostatistical techniques attempt to recognize and describe the pattern of spatial dependence and then account for this pattern when generating statistical estimates. On the other hand, “classical” methods assume that members of a population are not correlated (USEPA 1997a).

While a full treatment of spatial analysis and geostatistics is beyond the scope of this guidance, certain techniques recommended in the guidance require consideration of spatial differences. For example, you may need to consider whether there are any spatial correlations in a waste or site when selecting a sampling design. There are some relatively simple graphical techniques that can be used to explore possible spatial patterns or relationships in data. For example, posting plots or spatial contour maps can be generated manually or via software (e.g., see EPA’s Geo-EAS software described in Appendix H). Interested readers can find a more comprehensive explanation of spatial statistics in texts such as Myers (1997), Isaaks and Srivastava (1989), Journel (1988), USEPA (1991a, 1997a), or consult a professional environmental statistician or geostatistician.

4 PLANNING YOUR PROJECT USING THE DQO PROCESS

To be successful, a waste-testing program must yield data of the type and quality necessary to achieve the particular purpose of the program. This is accomplished through correct, focused, and well-documented sampling, testing, and data evaluation activities. In each case, a clear understanding of the program objectives and thorough planning of the effort are essential for a successful, cost-effective waste-testing program.

Each program design is unique because of the many possible variables in waste sampling and analysis such as regulatory requirements, waste and facility-specific characteristics, and objectives for the type and quantity of data to be provided. Nonetheless, a systematic planning process such as the Data Quality Objectives (DQO) Process, which takes these variables into account, can be used to guide planning efforts. EPA recommends using the DQO Process when data are being used to select between two opposing conditions, such as determining compliance with a standard.

The DQO Process yields qualitative and quantitative statements that:

- Clarify the study objectives
- Define the type, quantity, and quality of required data
- Determine the most appropriate conditions from which to collect the samples
- Specify the amount of uncertainty you are willing to accept in the results
- Specify how the data will be used to test a decision rule.

The outputs of the DQO Process are used to define the quality control requirements for sampling, analysis, and data assessment. These requirements are then incorporated into a QAPP, WAP, or other similar planning document.

The DQO Process comprises seven planning steps depicted in Figure 11. The figure shows one of the most important features of the process: its iterative nature. You don't have to "get it right the first time." You can use existing information to establish DQOs. If the initial design is not feasible, then you can iterate through one or more of the earlier planning steps to identify a sampling design that will meet the budget and generate data that are adequate for the decision. This way, you can evaluate sampling designs and related costs *in advance* before significant time and resources are expended to collect and analyze samples.

In a practical sense, the DQO Process offers a structured approach to "begin with the end in

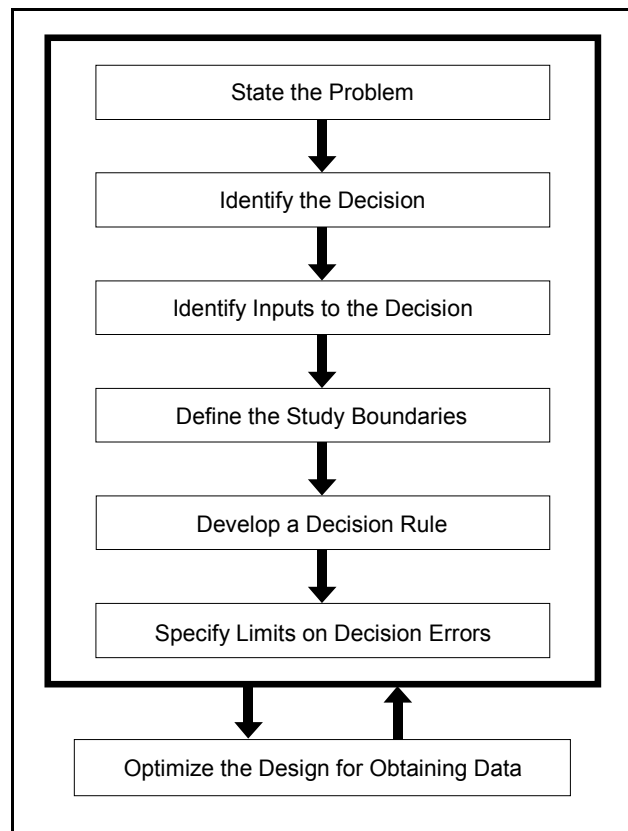

Figure 11. The seven steps of the DQO Process (from USEPA 2000b)

mind.” It is a framework for asking the right questions and using the answers to develop and implement a cost-effective plan for data collection. The DQO Process does not necessarily proceed in a linear fashion or involve rigid procedures; rather, it is a thought process to enable you to get useful information in a cost-effective manner.

Failure to establish DQOs before implementing field and laboratory activities can cause difficulties in the form of inefficiencies, increased or unnecessary costs, or the generation of unusable data. For example, if the limit of quantitation for sample analysis is greater than the Action Level, then the data will not be useable for its intended purpose; or, if you do not collect enough samples, then you may not be able to draw conclusions with the desired level of confidence.

Systematic Planning and the DQO Process: EPA References and Software

Guidance for the Data Quality Objectives Process, EPA QA/G-4, August 2000, EPA/600/R-96/055. Provides guidance on how to perform the DQO Process.

Data Quality Objectives Decision Error Feasibility Trials Software (DEFT) - User's Guide, EPA QA/G-4D, September 2001, EPA/240/B-01/007 (User's Guide and Software). PC-based software for determining the feasibility of data quality objectives defined using the DQO Process.

Guidance for the Data Quality Objectives Process for Hazardous Waste Sites, EPA QA/G-4HW, January 2000, EPA/600/R-00/007. Provides guidance on applying the DQO Process to hazardous waste site investigations.

When properly used, the DQO Process:

- Provides a good way to document the key activities and decisions necessary to address the problem and to communicate the approach to others.
- Involves key decision makers, other data users, and technical experts in the planning process before data collection begins which helps lead to a consensus prior to beginning the project and makes it easier to change plans when circumstances warrant because involved parties share common understandings, goals, and objectives.
- Develops a consensus approach to limiting decision errors that strikes a balance between the cost of an incorrect decision and the cost of reducing or eliminating the possible mistake.
- Saves money by greatly reducing the tendency to collect unneeded data by encouraging the decision makers to focus on data that support only the decision(s) necessary to solve the problem(s). When used with a broader perspective in mind, however, the DQO Process may help identify opportunities to consolidate multiple tasks and improve the efficiency of the data collection effort.¹

¹ In some cases, it might be appropriate and cost-effective to collect data beyond that required to support a near-term decision. For example, if a drill rig is mobilized to collect deep soil samples to determine the need for remediation, it would be cost-effective to also collect relatively low-cost data (such as geotechnical parameters, total organic carbon, moisture content, etc.) needed by engineers to design the remedy. Otherwise, unnecessary costs might be incurred to remobilize a drill rig to obtain data that could have been obtained in the initial effort.

The remainder of this section addresses how the DQO Process can be applied to RCRA waste-characterization studies. While the discussion is based on EPA's G-4 guidance (USEPA 2000b), some steps have been modified or simplified to allow for flexibility in their use. Keep in mind that not all projects or decisions (such as a hazardous waste determination) will require the full level of activities described in this section, but the logic applies nonetheless. In fact, EPA encourages use of a "graded approach" to quality assurance. A graded approach bases the level of management and QA/QC activities on the intended use of the results and the degree of confidence needed in their quality (USEPA 2001f).

4.1 Step 1: State the Problem

Before developing a data gathering program, the first step is to state the problem or determine what question or questions are to be answered by the study. For many waste characterization or monitoring programs the questions are spelled out in the applicable regulations; however, in some cases, determining the actual problem or question to be answered may be more complex. As part of this step, perform the four activities described in the following sections.

DQO Step 1: State the Problem
<p><u>Purpose</u> To define the problem so that the focus of the study will be unambiguous.</p>
<p><u>Activities</u></p> <ul style="list-style-type: none">• Identify members of the planning team.• Identify the primary decision maker(s).• Develop a concise description of the problem.• Determine resources – budget, personnel, and schedule.

4.1.1 Identify Members of the Planning Team

The planning team comprises personnel representing all phases of the project and may include stakeholders, decision makers, technical project managers, samplers, chemists, process engineers, QA/QC managers, statisticians, risk assessors, community leaders, grass roots organizations, and other data users.

4.1.2 Identify the Primary Decision Maker

Identify the primary decision maker(s) or state the process by which the decision will be made (for example, by consensus).

4.1.3 Develop a Concise Description of the Problem

Develop a problem description to provide background information on the fundamental issue to be addressed by the study. For RCRA waste-related studies, the "problem" could involve determining one of the following: (1) if a solid waste should be classified as a hazardous waste, (2) if a hazardous waste is prohibited from land disposal, (3) if a treated hazardous waste attains the applicable treatment standard, (4) if a cleanup goal has been attained, or (5) if hazardous constituents have migrated from a waste management unit.

Summarize existing information into a "conceptual model" or conceptual site model (CSM) including previous sampling information, preliminary estimates of summary statistics such as the mean and standard deviation, process descriptions and materials used, and any spatial and temporal boundaries of the waste or study area that can be defined. A CSM is a

three-dimensional “picture” of site conditions at a discrete point in time (a snapshot) that conveys what is known or suspected about the facility, releases, release mechanisms, contaminant fate and transport, exposure pathways, potential receptors, and risks. The CSM does not have to be based on a mathematical or computer model, although these tools often help to visualize current information and predict future conditions. The CSM should be documented by written descriptions of site conditions and supported by maps, cross sections, analytical data, site diagrams that illustrate actual or potential receptors, and any other descriptive, graphical, or tabular illustrations necessary to present site conditions.

4.1.4 Specify Available Resources and Relevant Deadlines

Identify available financial and human resources, identify deadlines established by permits or regulations, and establish a schedule. Allow time for developing acceptance and performance criteria, preparing planning documents (such as a QAPP, sampling plan, and/or WAP), collecting and analyzing samples, and interpreting and reporting data.

4.2 Step 2: Identify the Decision

The goal of this step is to define the questions that the study will attempt to answer and identify what actions may be taken based on the outcome of the study. As part of this step, perform the four activities described in the following sections.

4.2.1 Identify the Principal Study Question

Based on the problem identified in Step 1, identify the study question and state it as specifically as possible. This is an important step because the manner in which you frame the study question can influence whether sampling is even appropriate, and if so, how you will evaluate the results. Here are some examples of study questions that might be posed in a RCRA-related waste study:

- Does the filter cake from the filter press exhibit the TC at its point of generation?
- Does the treated waste meet the universal treatment standard (UTS) for land disposal under 40 CFR 268?
- Has the soil remediation at the SWMU attained the cleanup goal for benzene?
- Have hazardous constituents migrated from the land treatment unit to the underlying soil at concentrations significantly greater than background concentrations?
- Are radioactive and hazardous wastes colocated, producing a mixed waste management scenario?

DQO Step 2: Identify the Decision

Purpose

To define what specific decisions need to be made or what questions need to be answered.

Activities

- Identify the principal study question.
- Define the alternative actions that could result from resolution of the principal study question.
- Develop a decision statement.
- Organize multiple decisions.

Before conducting a waste-sampling and testing program to comply with RCRA, you should review the specific regulatory requirements in 40 CFR in detail and consult with staff from your EPA region or the representative from your State (if your State is authorized to implement the regulation).

4.2.2 Define the Alternative Actions That Could Result from Resolution of the Principal Study Question

Generally, two courses of action will result from the outcome of the study. One that involves action, such as deciding to classify a solid waste as a hazardous waste, and one that requires an alternative action, such as deciding to classify a solid waste as a nonhazardous solid waste.²

4.2.3 Develop a Decision Statement

In performing this activity, simply combine the principal study question and the alternative actions into a “decision statement.” For example, you may wish to determine whether a waste exhibits a hazardous waste characteristic. The decision statement should be in writing (for example, in the QAPP) and agreed upon by the planning team. This approach will help avoid misunderstandings later in the process.

4.2.4 Organize Multiple Decisions

If several separate decisions statements must be defined to address the problem, then you should list them and identify the sequence in which they should be resolved. For example, if you classify a solid waste as a nonhazardous waste, then you will need to make a waste management decision. Options might include land disposal (e.g., in an industrial landfill or a municipal solid waste landfill), recycling, or some other use. You might find it helpful to document the decision resolution sequence and relationships in a diagram or flowchart.

4.3 Step 3: Identify Inputs to the Decision

In most cases, it will be necessary to collect data or new information to resolve the decision statement. To identify the type and source of this information, perform the activities outlined in the following four sections.

4.3.1 Identify the Information Required

For RCRA-related waste studies, information requirements typically will

DQO Step 3: Identify Inputs to the Decision

Purpose

To identify data or other information required to resolve the decision statement.

Activities

- Identify the information required to resolve the decision statement.
- Determine the sources of information.
- Identify information needed to establish the Action Level.
- Identify sampling and analysis methods that can meet the data requirements.

² Testing alone might not be sufficient to determine if a solid waste is hazardous waste. You also should apply knowledge of the waste generation process to determine if the solid waste is a hazardous waste under 40 CFR 261.

include samples to be collected, variables to be measured (such as total concentrations, TCLP results, or results of tests for other characteristics, such as reactivity, ignitability, and corrosivity), the units of measure (such as mg/L), the form of the data (such as on a dry weight basis), and waste generation or process knowledge.

4.3.2 Determine the Sources of Information

Identify and list the sources of information needed and qualitatively evaluate the usefulness of the data. Existing information, such as analytical data, can be very valuable. It can help you calculate the appropriate number of new samples needed (if any) and reduce the need to collect new data (see also Section 5.4).

4.3.3 Identify Information Needed To Establish the Action Level

The Action Level is the threshold value that provides the criterion for choosing between alternative actions. Under RCRA, there are several types of Action Levels.

The first type of Action Level is a fixed standard or regulatory threshold (RT) usually specified as a *concentration* of a hazardous constituent (e.g., in mg/L). Examples of regulatory thresholds that are Action Levels in the RCRA regulations include the TC Regulatory Levels at 40 CFR 261.24 and the Land Disposal Restrictions (LDR) numeric treatment standards at 40 CFR 268.40.

Another criterion for choosing between alternative actions is defined by the *property* of a waste. Three such properties are defined in the RCRA regulations: ignitability (§ 261.21), corrosivity (§ 261.22), and reactivity (§ 261.23). The results of test methods used to determine if a waste is ignitable, corrosive, or reactive are interpreted as either “pass” or “fail” -- i.e., the waste either has the property or it does not. Note that a concentration measurement, such as a TCLP sample analysis result, also can be interpreted as either “pass” or “fail” based on whether the value is less than or greater than a specified threshold.

A third criterion for choosing between alternative actions involves making a comparison between constituent concentrations at different times or locations to determine if there has been a change in process or environmental conditions over time. In these situations, you need to determine if the two sets of data are different relative to each other rather than checking for compliance with a fixed standard.

Finally, an Action Level can represent a proportion of the population having (or not having) some characteristic. For example, while it might be desirable to have all portions of a waste or site comply with a standard, it would be more practical to test whether some high proportion (e.g., 0.95) of units of a given size, shape, and orientation comply with the standard. In such a case, the Action Level could be set at 0.95.

For more information on identifying the Action Level, see Section 2 (RCRA regulatory drivers for waste sampling and testing), the RCRA regulations in 40 CFR, ASTM Standard D 6250 (*Standard Practice for Derivation of Decision Point and Confidence Limit for Statistical Testing of Mean Concentration in Waste Management Decisions*), or consult with your State or EPA Regional staff.

4.3.4 Confirm That Sampling and Analytical Methods Exist That Can Provide the Required Environmental Measurements

Identify and evaluate candidate sampling and analytical methods capable of yielding the required environmental measurements. You will need to revisit this step during Step 7 of the DQO Process (“Optimize the Design for Obtaining the Data”) after the quantity and quality of the necessary data are fully defined. In evaluating sampling methods, consider the medium to be sampled and analyzed, the location of the sampling points, and the size, shape and orientation of each sample (see also Section 6, “Controlling Variability and Bias in Sampling” and Section 7, “Implementation: Selecting Equipment and Conducting Sampling”).

In evaluating analytical methods, choose the appropriate candidate methods for sample analyses based on the sample matrix and the analytes to be determined.

Guidance on the selection of analytical methods can be found in Chapter Two of SW-846 (“Choosing the Correct Procedure”). Up-to-date information on analytical methods can be found at SW-846 “On Line” at <http://www.epa.gov/epaoswer/hazwaste/test/main.htm>.

4.4 Step 4: Define the Study Boundaries

In this step of the DQO Process, you should identify the target population of interest and specify the spatial and temporal features of that population that are pertinent for decision making.

To define the study boundaries, perform the activities described in the following five sections.

4.4.1 Define the Target Population of Interest

It is important for you to clearly define the target population to be sampled. Ideally, the target population coincides with the population to be sampled (Cochran 1977)

– that is, the target population should represent the total collection of all possible sampling units that could be drawn. Note that the “units” that make up the population are defined operationally based on their size, shape, orientation, and handling (i.e., the “sample support”).³ The sampling unit definition must be considered when defining the target population because any changes in the definition can affect the population characteristics. See Section 6.3.1 for guidance on establishing the appropriate size (mass) of a sample, and see Section 6.3.2 for guidance on

DQO Step 4: Define the Study Boundaries

Purpose

To define the spatial and temporal boundaries that are covered by the decision statement.

Activities

- Define the target population of interest.
- Define the “sample support”
- Define the spatial boundaries that clarify what the data must represent.
- Define the time frame for collecting data and making the decision.
- Identify any practical constraints on data collection.
- Determine the smallest subpopulation, area, volume, or time for which separate decisions must be made.

³ The physical size (expressed as mass or volume), shape, and orientation of a sample is known as the *sample support*. Sample support plays an important role in characterizing waste or environmental media and in minimizing variability caused by the sampling process. The concept of *support* is discussed in greater detail in Section 6.2.3.

establishing the appropriate shape and orientation of sample.

Define the target population in terms of sampling units, the decision-making volume, and the location of that volume.

Sampling at the **point of generation** is *required* by regulation when determining the regulatory status of a waste. See 55 FR 11804, March 29, 1990, and 55 FR 22652, June 1, 1990.

4.4.2 Define the Spatial Boundaries

If sampling at the point of waste generation (i.e., *before* the waste is placed in a container or transport unit), then the sampling problem could involve collecting samples of a moving stream of material, such as from a conveyor, discharge pipe, or as poured into a container or tank. If so, then physical features such as the width of the flow or discharge and the rate of flow or discharge will be of interest for defining the spatial boundary of the problem.

If the sampling problem involves collecting samples from a waste storage unit or transport container, then the spatial boundaries can be defined by some physical feature, such as volume, length, width, height, etc. The spatial boundaries of most waste storage units or containers can be defined easily. Examples of these units follow:

- Container such as a drum or a roll-off box
- Tank
- Surface Impoundment
- Staging Pile
- Waste Pile
- Containment Building.

In other cases, the spatial boundary could be one or more geographic areas, such as areas representing “background” and “downgradient” conditions at a land treatment unit. Another example is a SWMU area that has been subject to remediation where the objective is verify that the cleanup goal has been achieved over a specified area or volume at the SWMU. If the study requires characterization of subsurface soils and ground water, then consult other guidance (for example, see USEPA 1989a, 1989b, 1991d, 1992a, 1993c, and 1996b).

To help the planning team visualize the boundary, it may be helpful to prepare a drawing, map, or other graphical image of the spatial boundaries, including a scale and orientation (e.g., a north arrow). If appropriate and consistent with the intended use of the information, maps also should identify relevant surface features (such as buildings, structures, surface water bodies, topography, etc.) and known subsurface features (pipes, utilities, wells, etc.).

If samples of waste will be taken at the point of generation (e.g., when the waste becomes a solid waste), the location of that point should be defined in this step of the DQO Process.

4.4.3 Define the Temporal Boundary of the Problem

A temporal boundary could be defined by a permit or regulation (such as the waste generated per day) or operationally (such as the waste generated per “batch” or truck load). You should

determine the time frame to which the decision applies and when to collect the data. In some cases, different time intervals might be established to represent different populations (e.g., in the case where there is a process change over time that affects the character of the waste).

Waste characteristics or chemistry, such as the presence of volatile constituents, also could influence the time frame within which samples are collected. For example, volatilization could occur over time.

4.4.4 Identify Any Practical Constraints on Data Collection

Identify any constraints or obstacles that could potentially interfere with the full implementation of the data collection design. Examples of practical constraints include physical access to a sampling location, unfavorable weather conditions, worker health and safety concerns, limitations of available sampling devices, and availability of the waste (e.g., as might be the case for wastes generated from batch processes) that could affect the schedule or timing of sample collection.

4.4.5 Define the Scale of Decision Making

Define the smallest, most appropriate subsets of the population (sub-populations), waste, or media to be characterized based on spatial or temporal boundaries. The boundaries will define the unit of waste or media about which a decision will be made. The unit is known as the **decision unit**.

When defining the decision unit, the consequences of making a decision error should be carefully considered. The consequences of making incorrect decisions (Step 6) are associated with the size, location, and shape of the decision unit. For example, if a decision, based on the data collected, results in a large volume of waste being classified as nonhazardous, when in fact a portion of the waste exhibits a hazardous waste characteristic (e.g., due to the presence of a “hot spot”), then the waste generator could potentially be found in violation of RCRA. To limit risk of managing hazardous waste with nonhazardous waste, the waste handler should consider dividing the waste stream into smaller decision units – such as the volume of waste that would be placed into an individual container to be shipped for disposal – and make a separate waste classification decision regarding each decision unit.

The planning team may establish decision units based on several considerations:

- **Risk** – The scale of the decision making could be defined based on an exposure scenario. For example, if the objective is to evaluate exposures via direct contact with surface soil, each decision unit could be defined based on the geographic area over which an individual is assumed to move randomly across over time. In EPA’s Superfund program, such a unit is known as an “exposure area” or EA (USEPA 1992c and 1996f). An example of an EA from EPA’s *Soil Screening Guidance: User’s Guide* (USEPA 1996f) is the top 2 centimeters of soil across a 0.5-acre area. In this example, the EA is the size of a suburban residential lot and the depth represents soil of the greatest concern for incidental ingestion of soil, dermal contact, and inhalation of fugitive dust.

If evaluation of a decision unit or EA for the purpose of making a cleanup

decision finds that cleanup is needed, then the same decision unit or EA should be used when evaluating whether the cleanup standard has been attained. Furthermore, the size, shape, and orientation (the “sample support”) of the samples used to determine that cleanup was necessary should be the same for samples used to determine whether the cleanup standard is met (though this last condition is not strictly necessary when the parameter of interest is the mean).

- **Operational Considerations** – The scale of the decision unit could be defined based on operational considerations, such as the need to characterize each “batch” of waste after it has been treated or the need to characterize each drum as it is being filled at the point of waste generation. As a practical matter, the scale for the decision making often is defined by the spatial boundaries – for example as defined by a container such as a drum, roll-off box, truck load, etc. or the time required to fill the container.
- **Other** – The possibility of “hot spots” (areas of high concentration of a contaminant) may be apparent to the planning team from the history of the facility. In cases where previous knowledge (or planning team judgment) includes identification of areas that have a higher potential for contamination, a scale may be developed to specifically represent these areas.

Additional information and considerations on defining the scale of the decision making can be found in *Guidance for the Data Quality Objectives Process for Hazardous Waste Site Operations EPA QA/G-4HW* (USEPA 2000a) and *Guidance for the Data Quality Objectives Process EPA QA/G-4* (USEPA 2000b).

4.5 Step 5: Develop a Decision Rule

A statement must be developed that combines the parameter of interest and the Action Levels with the DQO outputs already developed. The combination of these three elements forms the decision rule and summarizes what attributes the decision maker wants to study and how the information will assist in solving the central problem. To develop the decision rule, perform the activities described in the following three sections:

4.5.1 Specify the Parameter of Interest

A statistical “parameter” is a descriptive measure of a population such as the population mean, median, or a percentile (see also Section 3.2). See Table 2.

Some of the RCRA regulations specify the parameter of interest. For example, the comparable fuels sampling and analysis requirements at 40 CFR 261.38(c)(8)(iii)(A) specify the *mean* as the parameter of interest, and the ground-water monitoring requirements at 40 CFR 264.97 specify the parameter of interest for each statistical

DQO Step 5: Develop a Decision Rule

Purpose

To define the parameter of interest, specify the Action Level and integrate previous DQO outputs into a single statement that describes a logical basis for choosing among alternative actions; i.e., define how the data will be used to make a decision.

Activities

- Specify the parameter of interest (mean, median, percentile).
- Specify the Action Level for the study.
- Develop a decision rule.

test. Other RCRA regulations do not specify the parameter of interest, however, you can select a parameter based on what the Action Level is intended to represent. In general, if an Action Level is based on long-term average health effects, the parameter of interest could be the population mean (USEPA 1992a). If the Action Level represents a value that should never (or rarely) be exceeded, then the parameter of interest could be an upper population percentile, which can serve as a reasonable approximation of the *maximum* value.

If the objective of the study does not involve estimation of a parameter or testing a hypothesis, then specification of a parameter is not necessary.

Table 2. Population Parameters and Their Applicability to a Decision Rule

Parameter	Definition	Appropriate Conditions for Use
Mean	Average	Estimate central tendency: Comparison of middle part of population to an Action Level.
Median	Middle observation of the distribution; 50 th percentile; half of data are above and below	May be preferred to estimate central tendency if the population contains many values that are less than the limit of quantitation. The median is not a good choice if more than 50% of the population is less than the limit of quantitation because a true median does not exist in this case. The median is not influenced by the extremes of the contaminant distribution.
Percentile	Specified percent of sample that is equal to or below the given value	For cases where it is necessary to demonstrate that, at most, only a small portion of a population could exceed the Action Level. Sometimes selected if the decision rule is being developed for a chemical that can cause acute health effects. Also useful when a large part of the population contains values less than the detection limit.

4.5.2 Specify the Action Level for the Study

You should specify an Action Level or concentration limit that would cause the decision maker to choose between alternative actions. Examples of Action Levels follow:

- Comparable/syngas fuel constituent specification levels specified at § 261.38
- Land disposal restrictions concentration level treatment standards at § 268.40 and § 268.48
- Risk-based cleanup levels specified in a permit as part of a corrective action
- “Pass” or “fail” thresholds for tests for ignitability, corrosivity, reactivity⁴, and toxicity.

Also, be sure the detection or quantitation limits for the analytical methods identified in DQO Step 3 (Section 4.3) are below the Action Level, if possible.

⁴ EPA uses a narrative criteria to define most reactive wastes, and waste handlers should use their knowledge to determine if a waste is sufficiently reactive to be regulated.

If your objective is to compare “onsite” to “background” to determine if there is a statistically significant increase above background (as would be the case for monitoring releases from a land treatment unit under § 264.278), you will not need to specify an Action Level; rather, the Action Level is implicitly defined by the background concentration levels and the variability in the data. A summary of methods for determining background concentrations in soil can be found in USEPA 1995a. Methods for determining background concentrations in ground water can be found in USEPA 1989b and 1992b.

Finally, note that some studies will not require specification of a regulatory or risk-based Action Level. For example, if the objective may be to identify the existence of a release, samples could be obtained to verify the *presence or absence* of a spill, leak, or other discharge to the environment. Identifying a potential release also could include observation of abandoned or discarded barrels, containers, and other closed receptacles containing hazardous wastes or constituents (see 61 FR No. 85, page 19442).

4.5.3 Develop a Decision Rule

After you have completed the above activities, you can construct a decision rule by combining the selected population parameter and the Action Level with the scale of the decision making (from DQO Process Step 4) and the alternative action (from DQO Step 2). Decision rules are expressed as “if (criterion)..., then (action)....” A hypothetical example follows:

“If the true 95th percentile of all possible 100-gram samples of the waste being placed in the 20-cubic yard container is less than 5.0 mg/L TCLP lead, then the solid waste will be classified as nonhazardous waste. Otherwise, the solid waste will be classified as a RCRA hazardous waste.”

Note that this is a functional decision rule based on an ideal condition (i.e., knowledge of the true concentration that equals the 95th percentile of all possible sample analysis results). It also identifies the boundary of the study by specifying the sample unit (100-gram samples in accordance with the TCLP) and the size of the decision unit. It does *not*, however, specify the amount of uncertainty the decision maker is willing to accept in the estimate. You specify that in the next step.

4.6 Step 6: Specify Limits on Decision Errors

Because samples represent only a portion of the population, the information available to make decisions will be incomplete; hence, *decision errors* sometimes will be made. Decision errors occur because decisions are made using *estimates* of the parameter of interest, rather than the true (and unknown) value. In fact, if you repeatedly sampled and analyzed a waste over and over in an identical manner the results would be a little different each time (see Figure 8 in Section 3). This variability

Step 6: Specify Limits on Decision Errors

Purpose

To specify the decision maker's tolerable limits on decision error.

Activities

- Identify potential sources of variability and bias in the sampling and measurement processes (see Section 6)
- Determine the possible range on the parameter of interest.
- Choose the null hypothesis.
- Consider the consequences of making an incorrect decision.
- Specify a range of values where the consequences are minor (the “gray region”)
- Specify an acceptable probability of making a decision error.

in the results is caused by the non-homogeneity of the waste or media, slight differences in how the samples of the waste were collected and handled, variability in the analysis process, and the fact that only a small portion of the waste is usually ever sampled and tested. (See Section 6.1 for a more detailed discussion of sources of variability and bias in sampling). For example, if you conduct sampling and analysis of a solid waste and classify it as “nonhazardous” based on the results, when in fact it *is* a hazardous waste, you will have made a wrong decision or *decision error*. Alternatively, if you classify a solid waste as hazardous, when in fact it is nonhazardous, you also will have made a *decision error*.

There are two types of decision error. A “Type I” or “false rejection” decision error occurs if you reject the null hypothesis when it is true. (The “null hypothesis” is simply the situation presumed to be true or the “working assumption”.) A “Type II” or “false acceptance” decision error occurs if you accept the null hypothesis when it is false.⁵

Table 3 summarizes the four possible situations that might arise when a hypothesis is tested. The two possible true conditions correspond to the two columns of the table: the null hypothesis or “baseline assumption” is either true or the alternative is true. The two kinds of decisions are shown in the body of the table. Either you decide the baseline is true, or you decide the alternative is true. Associated with these two decisions are the two types of risk – the risk of making a Type I (false rejection) error (denoted by α) and the risk of making a Type II (false acceptance) error (denoted by β). You can improve your chances of making correct decisions by reducing α and β (which often requires more samples or a different sampling design) and by using field sampling techniques that minimize errors related to sampling collection and handling (see also Sections 6 and 7).

Table 3. Conclusions and Consequences for a Test of Hypotheses

		True Condition	
		Baseline is True	Alternative is True
Decision Based on Sample Data	Baseline is True	Correct Decision	Type II (false acceptance) error (probability β)
	Alternative is True	Type I (false rejection) error (probability α)	Correct Decision

For many sampling situations under RCRA, the most conservative (i.e., protective of the environment) approach is to presume that the constituent concentration in the waste or media exceeds the standard in the absence of strong evidence to the contrary.⁶ For example, in

⁵ Statisticians sometimes refer to a Type I error as a “false positive,” and a Type II error as a “false negative.” The terms refer to decision errors made relative to a null hypothesis, and the terms may not necessarily have the same meaning as those used by chemists to describe analytical detection of a constituent when it is not really present (“false positive”) or failure to detect a constituent when it really *is* present (“false negative”).

⁶ An exception to this assumption is found in “detection monitoring” and “compliance monitoring” in which underlying media (such as soil, pore water, or ground water) at a new waste management unit are presumed “clean” until a statistically significant increase above background is demonstrated (in the case of detection monitoring) or a statistically significant increase over a fixed standard is demonstrated (in the case of compliance or assessment monitoring).

testing a solid waste to determine if it exhibits the TC, the null hypothesis can be stated as follows: “the concentration is equal to or greater than the TC regulatory level.” The alternative hypothesis is “the concentration is less than the TC regulatory level.” After completion of the sampling and analysis phase, you conduct an assessment of the data. If your estimate of the parameter of interest is less than the threshold when the true value of the parameter exceeds the threshold, you will make a decision error (a Type I error). If the estimate of the parameter of interest is greater than the threshold when the true value is less than the threshold, you also will make an error (a Type II error) -- but one that has little potential adverse impacts to human health and the environment.

Note that during the planning phase and during sampling you will not know which kind of error you might make. Later, after a decision has been made, if you *rejected* the null hypothesis then you either made a Type I (false rejection) decision error or not; you could not have made a Type II (false acceptance) decision error. On the other hand, if you did not reject the null hypothesis, then you either made a Type II (false acceptance) error or not; you could not have made a Type I (false rejection) error. In either case, you will know which type of error you might have made and you will know the *probability* that the error was made.

In the RCRA program, EPA is concerned primarily with controlling errors having the most adverse consequences for human health and the environment. In the interest of protecting the environment and maintaining compliance with the regulations, there is an incentive on the part of the regulated entity to minimize the chance of a Type I decision error. The statistical methods recommended in this document emphasize controlling the Type I (false rejection) error rate and do not necessarily require specification of a Type II (false acceptance) error rate.

The question for the decision maker then becomes, what is the acceptable probability (or chance) of making a decision error? To answer this question, four activities are suggested. These activities are based on guidance found in *Guidance for the Data Quality Objectives Process QA/G-4* (USEPA 2000b) but have been tailored for more direct application to RCRA waste-related studies. The *Guidance for the Data Quality Objectives Process EPA QA/G-4* also provides detailed guidance on the use of a graphical construct called a Decision Performance Curve to represent the quality of a decision process.

4.6.1 Determine the Possible Range on the Parameter of Interest

Establish the possible range (maximum and minimum values) of the parameter of interest using data from a pilot study, existing data for a similar waste stream, or process knowledge (e.g., using a materials-balance approach). It is desirable, but not required, to have an estimate of the standard deviation as well.

4.6.2 Identify the Decision Errors and Choose the Null Hypothesis

Table 4 presents four examples of decision errors that could be made in a RCRA waste study. In the first three examples, the consequences of making a Type I error could include increased risk to human health and the environment or a potential enforcement action by a regulatory authority. The consequences of making a Type II error could include unnecessary financial and administrative resources required to manage the waste as hazardous (when, in fact, it is not) or continuing site cleanup activities when, in fact, the site is “clean.”

Table 4. Examples of Possible Decision Errors in RCRA Waste Studies

Regulatory Requirement	"Null Hypothesis" (baseline condition)	Possible Decision Errors	
		Type I Error (α) "False Rejection"	Type II Error (β) "False Acceptance"
Example 1: Under 40 CFR 261.11, conduct sampling to determine if a solid waste is a hazardous waste by the TC.	The solid waste contains TC constituents at concentrations equal to or greater than their applicable regulatory levels (i.e., the solid waste is a hazardous waste).	Concluding the waste is not hazardous when, in fact, it is.	Deciding the waste is hazardous when, in fact, it is not.
Example 2: Under 40 CFR 268.7, conduct sampling and testing to certify that a hazardous waste has been treated so that concentrations of hazardous constituents meet the applicable LDR treatment standards.	The concentration of the hazardous constituents exceeds the treatment standard (i.e., the treatment standard has not been attained).	Concluding the treatment standard has been met when, in fact, it has not.	Concluding the treatment standard has not been met when, in fact, it has.
Example 3: Under 40 CFR 264.101 (and proposed Subpart S - Corrective Action at SWMUs), a permittee conducts testing to determine if a remediation at a SWMU has attained the risk-based cleanup standard specified in the permit.*	The mean concentration in the SWMU is greater than the risk-based cleanup standard (i.e., the site is contaminated).†	Concluding the site is "clean" when, in fact, it is contaminated.	Concluding the site is still contaminated when, in fact, it is "clean."
Example 4: Under 40 CFR 264.98(f), detection monitoring, monitor ground water at a regulated unit to determine if there is a statistically significant increase of contamination above background.	The level of contamination in each point of compliance well does not exceed background.	Concluding the contaminant concentration in a compliance well exceeds background when, in fact, it does not.	Concluding the contaminant concentration in a compliance well is similar to background when, in fact, it is higher.

* If the cleanup standard is based on "background" rather than a risk-based cleanup standard, then the hypotheses would be framed *in reverse* where the mean background and on-site concentrations are presumed equal unless there is strong evidence that the site concentrations are greater than background.

† A parameter other than the mean may be used to evaluate attainment of a cleanup standard (e.g., see USEPA 1989a).

In Example 4, however, the null hypothesis is framed *in reverse* of Examples 1 through 3. When conducting subsurface monitoring to detect contamination at a new unit (such as in detection monitoring in the RCRA ground-water monitoring program), the natural subsurface environment is presumed uncontaminated until statistically significant increases over the background concentrations are detected. Accordingly, the null hypothesis is framed such that the downgradient conditions are consistent with the background. In this case, EPA's emphasis on the protection of human health and the environment calls for minimizing the Type II error -- the mistake of judging downgradient concentrations the same as the background when, in fact,

they are higher. Detailed guidance on detection and compliance monitoring can be found in *RCRA Ground-Water Monitoring: Draft Technical Guidance* (USEPA 1992c) and EPA's guidance on the statistical analysis of ground-water monitoring data at RCRA facilities (USEPA 1989b and 1992b).

4.6.3 Specify a Range of Possible Parameter Values Where the Consequences of a False Acceptance Decision Error are Relatively Minor (Gray Region)

The "gray region" is one component of the quantitative decision performance criteria the planning team establishes during the DQO Process to limit impractical and infeasible sample sizes. The gray region is a range of possible parameter values near the action level where it is "too close to call." This gray area is where the sample data tend toward rejecting the baseline condition, but the evidence (data statistics) is not sufficient to be overwhelming. In essence, the gray region is an area where it will not be feasible to control the false acceptance decision error limits to low levels because the high costs of sampling and analysis outweigh the potential consequences of choosing the wrong course of action.

In statistical language, the gray region is called the "minimum detectable difference" and is often expressed as the Greek letter delta (Δ). This value is an essential part of the calculations for determining the number of samples that need to be collected so that the decision maker may have confidence in the decision made based on the data collected.

The first boundary of the gray region is the Action Level. The other boundary of the gray region is established by evaluating the consequences of a false acceptance decision error over the range of possible parameter values in which this error may occur. This boundary corresponds to the parameter value at which the consequences of a false acceptance decision error are significant enough to have to set a limit on the probability of this error occurring. The gray region (or "area of uncertainty") establishes the minimum distance from the Action Level where the decision maker would like to begin to control false acceptance decision errors.

In general, the narrower the gray region, the greater the number of samples needed to meet the criteria because the area of uncertainty has been reduced.

The quality of the decision process, including the boundaries of the gray region, can be depicted graphically using a Decision Performance Goal Diagram (DPGD). Detailed guidance on the construction and use of DPGDs is given in EPA DQO guidance documents (e.g., USEPA 2000a and 2000b) and in *Data Quality Objectives Decision Error Feasibility Trials Software (DEFT) - User's Guide* (USEPA 2001a). Figure 12(a) and Figure 12(b) show how some of the key outputs of Step 6 of the DQO Process are depicted in a DPGD when the parameter of interest is the mean (Figure 12(a)) and a percentile (Figure 12(b)).

The DPGD given in Figure 12(a) shows how the boundaries of the gray region are set when the null hypothesis is established as "the true mean concentration exceeds the standard." Notice that the planning team has set the action level at 5 ppm and the other boundary of the gray region at 4 ppm. This implies that when the mean calculated from the sample data is less than 4 ppm (and the planning assumptions regarding variability hold true), then the data will be considered to provide "overwhelming evidence" that the true mean (unknown, of course) is below the action level.

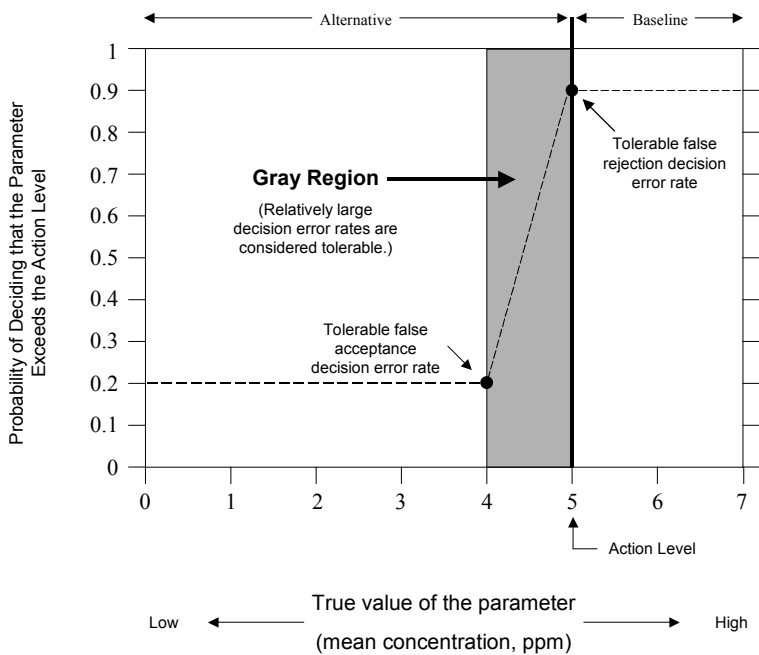

Figure 12(a). Decision Performance Goal Diagram where the mean is the parameter of interest. Null hypothesis (baseline condition): the true mean exceeds the action level.

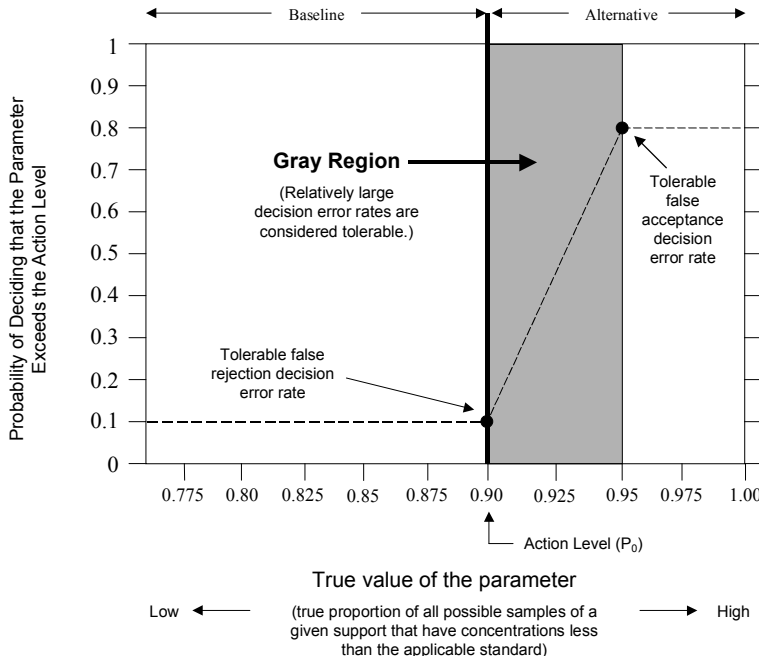

Figure 12(b). Decision Performance Goal Diagram where a percentile is the parameter of interest. Null hypothesis (baseline condition): true proportion -- of all possible samples of a given support that are less than the applicable standard -- is less than 0.90.

Now consider the DPGD given in Figure 12(b). The figure shows how the gray region is set when the null hypothesis is established as “the true proportion of samples below the concentration standard is less than 0.90.” Notice in this example the planning team has set the action level at 0.90 and the other boundary of the gray region at 0.95. This implies that when the proportion of samples that comply with the standard is greater than 0.95, then the data will be considered to provide “overwhelming evidence” that the true proportion (unknown, of course) is greater than the action level of 0.90.

The term “samples” refers to all possible samples of a specified size, shape, and orientation (or **sample support**) drawn from the DQO decision unit. Sampling procedures and sample support can affect the measurement value obtained on individual samples and have a profound effect on the shape of the sampling distribution. Thus, the outcome of statistical procedures that examine characteristics of the upper tail of the distribution can be influenced by the sample support – more so than when the mean is the parameter of interest. Accordingly, when testing for a proportion, a complete statement of the null hypothesis should include specification of the sample support. See Sections 6.3.1 and 6.3.2 for guidance on establishing the appropriate sample support as part of the DQO Process.

4.6.4 Specify an Acceptable Probability of Making a Decision Error

You can never completely eliminate decision errors or even know when they have occurred, but you can quantify the probability of making such errors. In this activity, you establish the acceptable probability of making a decision error.

The Type I error rate (α) is a measure of the amount of “mistrust” you have in the conclusion (Myers 1997) and is also known as the **significance level** for a test. The flip side of this is the amount of faith or confidence you have in the conclusion. The **confidence level** is denoted mathematically as $1 - \alpha$. As stated previously, the Type I error (the error of falsely rejecting the null hypothesis) is of greatest concern from the standpoint of environmental protection and regulatory compliance.

The probability of making a Type II error (the error of falsely accepting the null hypothesis) also can be specified. For example, if the sample data lead you to conclude that a waste does not qualify for the comparable fuels exclusion (40 CFR 261.38), when the true mean concentration in the waste is in fact below the applicable standard, then a Type II (false acceptance error) has been made. (Note that some of the statistical methods given in this document do not require specification of a Type II error rate).

As a general rule, the lower you set the probability of making a decision error, the greater the cost in terms of the number of samples required, time and personnel required for sampling and analysis, and financial resources required.

An acceptable probability level for making a decision error should be established by the planning team after consideration of the RCRA regulatory requirements, guidance from EPA or the implementing agency, the size (volume or weight) of the decision unit, and the consequences of making a decision error. In some cases, the RCRA regulations specify the Type I or Type II (or both) error rates that should be used. For example, when testing a waste to determine whether it qualifies for the comparable/syngas fuel exclusion under 40 CFR 261.38, the regulations *require* that the determination be made with a Type I error rate set at 5

percent (i.e., $\alpha = 0.05$).⁷

In other cases, the regulations do not specify any decision error limits. The planning team must specify the decision error limits based on their knowledge of the waste; impacts on costs, human health, and ecological conditions; and the potential consequences of making a decision error. For example, if the quantity of waste (that comprises a decision unit) is large and/or heterogeneous, then a waste handler may require high confidence (e.g., 95 or 99 percent) that a high proportion of the waste or media complies with the applicable standard. On the other hand, if the waste quantity is a relatively small (e.g., a drum) and sampling and measurement error can be minimized, then the waste handler may be willing to relax the confidence level required or simply use a nonstatistical (e.g., judgmental) sampling design and reduce the number of samples to be taken.

For additional guidance on controlling errors Section 6 and EPA's DQO guidance (USEPA 2000a and 2000b).

4.7 Outputs of the First Six Steps of the DQO Process

Table 5 provides a summary of the outputs of the first six steps of the DQO Process. Typically, this information will be incorporated into a QAPP, WAP, or other similar planning document (as described in Section 5.7). The DQOs can be simple and straight forward for simple projects and can be documented in just a few pages with little or no supporting data. For more complex projects, the DQOs can be more lengthy, and the supporting data may take up volumes. The team that will be optimizing the sample design(s) will need the information to support their plan development. The project manager and the individuals who assess the overall outcome of the project also will need the information to determine if the DQOs were achieved.

Keep in mind that the DQO Process is an iterative one; it might be necessary to return to earlier steps to modify inputs when new data become available or to change assumptions if achieving the original DQOs is not realistic or practicable.

The last step (Step 7) in the DQO Process is described in detail in the next section of this document. Example applications of the full DQO Process are presented in Appendix "I."

⁷ Under §261.38(c)(8)(iii)(A), a generator must demonstrate that "each constituent of concern is not present in the waste above the specification level at the 95% upper confidence limit around the mean."

Table 5. Summary of Outputs of the First Six Steps of the DQO Process

<i>DQO Step</i>	<i>Expected Outputs</i>
1. State the Problem	<ul style="list-style-type: none"> • List of members of the planning/scoping team and their role/expertise in the project. Identify individuals or organizations participating in the project (e.g. facility name) and discuss their roles, responsibilities, and organization. • A concise description of the problem. • Summary of available resources and relevant deadlines.
2. Identify the Decision	<ul style="list-style-type: none"> • A decision statement that links the principal study question to possible actions that will solve the problem or answer the question.
3. Identify Inputs to the Decision	<ul style="list-style-type: none"> • A list of informational inputs needed to resolve the decision statement, how the information will be used, sources of that information, and an indication of whether the information is available for will need to be obtained. • A list of environmental variables or characteristics that will be measured.
4. Define the Boundaries	<ul style="list-style-type: none"> • A detailed description of the spatial and temporal boundaries of the problem (i.e., define the population, each decision unit, and the sample support). • Options for stratifying the population under study. • Any practical constraints that may interfere with the study.
5. Develop a Decision Rule	<ul style="list-style-type: none"> • The parameter of interest that characterizes the population. • The Action Level or other method for testing the decision rule. • An “if ...then...” statement that defines the conditions that would cause the decision maker to choose among alternative actions.
6. Specify Limits on Decision Errors	<ul style="list-style-type: none"> • Potential variability and bias in the candidate sampling and measurement methods • The baseline condition (null hypothesis) • The boundaries of the gray region • The decision maker’s tolerable decision error rates based on a consideration of consequences of making an incorrect decision.

5 OPTIMIZING THE DESIGN FOR OBTAINING THE DATA

This section describes DQO Process Step 7, the last step in the DQO Process. The purpose of this step is to identify an optimal design for obtaining the data. An optimal sampling design is one that obtains the requisite information from the samples for the lowest cost and still satisfies the DQOs.

You can optimize the sampling design by performing five activities that are described in detail in this section. These activities are based on those described in *Guidance for the Data Quality Objectives Process EPA QA/G-4* (USEPA 2000b), but they have been modified to more specifically address RCRA waste-related studies.

In this final planning step, combine the data collection design information with the other outputs of the DQO Process and document the approach in a planning document such as a QAPP, WAP, or similar planning document. As part of this step, it may be necessary to work through Step 7 more than once after revisiting the first six steps of the DQO Process.

Step 7: Optimize the Design for Collecting the Data

Purpose

To identify a resource-effective data collection design for generating data that are expected to satisfy the DQOs.

Activities

- Review the outputs of the first six steps of the DQO Process (see Section 5.1).
- Consider various data collection design options, including sampling and analytical design alternatives (see Section 5.2), and composite sampling options (see Section 5.3).
- For each data collection design alternative, determine the appropriate number of samples (see Section 5.4 or 5.5).
- Select the most resource-effective design that satisfies all of the data needs for the least costs (see Section 5.6).
- Prepare a QAPP, WAP, or similar planning document as needed to satisfy the project and regulatory requirement (see Section 5.7).

5.1 Review the Outputs of the First Six Steps of the DQO Process

Each of the steps in the DQO Process has a series of outputs that include qualitative and quantitative information about the study. The outputs of the first six steps of the DQO Process, as described in Section 4, serve as inputs to DQO Step 7.

Review the existing information and DQO outputs (see Table 5). Determine if any data gaps exist and determine whether filling those gaps is critical to completion of the project. Data gaps can be filled by means of a “preliminary study” or “pilot study.” A preliminary study or pilot can include collection of samples to obtain preliminary estimates of the mean and standard deviation. In addition, a preliminary study can help you verify waste or site conditions, identify unexpected conditions or materials present, gain familiarization with the waste and facility operations, identify how the waste can be accessed, check and document the physical state of the material to be sampled, and identify potential health and safety hazards that may be present.

Review the potential sources of variability and bias (“error”) that might be introduced in the sampling design and measurement processes. See Section 6 for a discussion of sources of error in sampling and analysis.

5.2 Consider Data Collection Design Options

Data collection design incorporates two interdependent activities -- the sample collection design and analytical design.

Sampling Design: In developing a sampling design, you consider various strategies for selecting the locations, times, and components for sampling, and you define appropriate sample support. Examples of sampling designs include simple random, stratified random, systematic, and judgmental sampling. In addition to sampling designs, make sure your organization has documented standard operation procedures (SOPs) that describe the steps to be followed when implementing a sampling activity (e.g., equipment preparation, sample collection, decontamination). For guidance on suggested content and format for SOPs, refer to *Guidance for the Preparing Standard Operating Procedures (SOPs) EPA QA/G-6* (USEPA 2001c). Sampling QA/QC activities also should be part of sampling design. Activities used to document, measure, and control data quality include project-specific quality controls (e.g., duplicate samples, equipment blanks, field blanks, and trip blanks) and the associated quality assessments (e.g., audits, reviews) and assurances (e.g., corrective actions, reports to management). These activities typically are documented in the QAPP (see Section 5.7 and USEPA 1998a).

Analytical Design: In DQO Steps 3 and 5, an Action Level and candidate analytical methods were identified. The information should be used to develop analytical options in terms of cost, method performance, available turnaround times, and QA/QC requirements. The analytical options can be used as the basis for designing a performance-based cost-effective analytical plan (e.g., deciding between lower-cost field analytical methods and/or higher cost laboratory methods). Candidate laboratories should have adequate SOPs that describe the steps to be followed when implementing an analytical activity (e.g., sample receipt procedures, subsampling, sample preparation, cleanup, instrumental analysis, data generation and handling). If field analytical techniques are used, hard copies of the analytical methods or SOPs should be available in the field. Refer to Chapter Two of SW-846 for guidance on the selection of analytical methods.

The goal of this step is to find cost-effective design alternatives that balance the number of samples and the measurement performance, given the feasible choices for sample designs and measurement methods.

Sampling design is the “where, when, and how” component of the planning process. In the context of waste sampling under RCRA, there are two categories of sampling designs: (1) **probability** sampling and (2) **authoritative** (nonprobability) sampling. The choice of a sampling design should be made after consideration of the DQOs and the regulatory requirements.

Probability sampling refers to sampling designs in which all parts of the waste or media under study have a known probability of being included in the sample. In cases in which all parts of the waste or media are not accessible for sampling, the situation should be documented so its potential impacts can be addressed in the assessment phase. Probability samples can be of various types, but in some way, they all make use of randomization, which allows probability statements to be made about the quality of estimates derived from the resultant data.

Probability sampling designs provide the ability to reliably estimate variability, the reproducibility of the study (within limits), and the ability to make valid statistical inferences. Five types of probability sampling designs are described in Sections 5.2.1 through 5.2.5:

- Simple random sampling
- Stratified random sampling
- Systematic sampling
- Ranked set sampling
- Sequential sampling.

A strategy that can be used to improve the precision (reproducibility) of most sampling designs is **composite** sampling. Composite sampling is not a sampling design in and of itself, rather composite sampling is a *strategy* used as part of a probability sampling design or an authoritative sampling design. Composite sampling is discussed in Section 5.3.

One common misconception of probability sampling procedures is that these procedures preclude the use of important prior information. Indeed, just the opposite is true. An efficient sampling design is one that uses all available prior information to help design the study. Information obtained during DQO Step 3 (“Identify Inputs to the Decision”) and DQO Step 4 (“Define the Study Boundaries”) should prove useful at this stage. One of the activities suggested in DQO Step 4 is to segregate the waste stream or media into less heterogeneous subpopulations as a means of segregating variability. To determine if this activity is appropriate, it is critical to have an understanding of the various kinds of heterogeneity the constituent of concern exhibits within the waste or media (Pitard 1993). Making assumptions that a waste stream is homogeneous can result in serious sampling errors. In fact, some authors suggest the word “homogeneous” be removed from our sampling vocabulary (Pitard 1993, Myers 1997).

Table 6 provides a summary of sampling designs discussed in this guidance along with conditions for their use, their advantages, and their disadvantages. Figure 13 provides a graphical representation of the probability sampling designs described in this guidance. A number of other sampling designs are available that might perform better for your particular situation. Examples include cluster sampling and double sampling. If an alternative sampling design is required, review other publications such as Cochran (1977), Gilbert (1987), USEPA (2000c) and consult a professional statistician.

Sampling Over Time or Space?

An important feature of probability sampling designs is that they can be applied along a line of time or in space (see Figure 13) or both (Gilbert 1987):

Time

Sampling designs applied over time can be described by a *one-dimensional* model that corresponds to flowing streams such as the following:

- Solid materials on a conveyor belt
- A liquid stream, pulp, or slurry moving in a pipe or from a discharge point (e.g., from the point of waste generation)
- Continuous elongated piles (Pitard 1993).

Space

For practical reasons, sampling of material over a *three-dimensional* space is best addressed as though the material consists of a series of overlapping *two-dimensional* planes of more-or-less uniform thickness (Pitard 1993, Gy 1998). This is the case for obtaining samples from units such as the following:

- Drums, tanks, or impoundments containing single or multi-phasic liquid wastes
- Roll-off bins, relatively flat piles, or other storage units
- Landfills, soil at a land treatment unit, or a SWMU.

Table 6. Guidance for Selection of Sampling Designs

<i>Sampling Design</i>	<i>Appropriate Conditions for Use</i>	<i>Advantages</i>	<i>Limitations</i>
Probability Sampling			
Simple Random Sampling (Section 5.2.1)	Useful when the population of interest is relatively homogeneous (i.e., there are no major patterns or “hot spots” expected).	<ul style="list-style-type: none"> • Provides statistically unbiased estimates of the mean, proportions, and the variability. • Easy to understand and implement. 	<ul style="list-style-type: none"> • Least preferred if patterns or trends are known to exist and are identifiable. • Localized clustering of sample points can occur by random chance.
Stratified Random Sampling (Section 5.2.2)	Most useful for estimating a parameter (e.g., the mean) of wastes exhibiting high heterogeneity (e.g., there are distinct portions or components of the waste with high and low constituent concentrations or characteristics).	<ul style="list-style-type: none"> • Ensures more uniform coverage of the entire target population. • Potential for achieving greater precision in estimates of the mean and variance. • May reduce costs over simple random and systematic sampling designs because fewer samples may be required. • Enables computation of reliable estimates for population subgroups of special interest. 	<ul style="list-style-type: none"> • Requires some prior knowledge of the waste or media to define strata and to obtain a more precise estimate of the mean. • Statistical procedures for calculating the number of samples, the mean, and the variance are more complicated than for simple random sampling.
Systematic Sampling (Section 5.2.3)	Useful for estimating spatial patterns or trends over time.	<ul style="list-style-type: none"> • Preferred over simple random when sample locations are random within each systematic block or interval. • Practical and easy method for designating sample locations. • Ensures uniform coverage of site, unit, or process. • May be lower cost than simple random sampling because it is easier to implement. 	<ul style="list-style-type: none"> • May be misleading if the sampling interval is aligned with the pattern of contamination, which could happen inadvertently if there is inadequate prior knowledge of the pattern of contamination. • Not truly random, but can be modified through use of the “random within blocks” design.

Table 6. Guidance for Selection of Sampling Designs (Continued)

<i>Sampling Design</i>	<i>Appropriate Conditions for Use</i>	<i>Advantages</i>	<i>Limitations</i>
Probability Sampling (continued)			
Ranked Set Sampling (Section 5.2.4)	<ul style="list-style-type: none"> Useful for reducing the number of samples required. Useful when the cost of analysis is much greater than the cost of collecting samples. Inexpensive auxiliary variable (based on expert knowledge or measurement) is needed and can be used to rank randomly selected population units with respect to the variable of interest. Useful if the ranking method has a strong relationship with accurate measurements. 	<ul style="list-style-type: none"> Can reduce analytical costs. 	<ul style="list-style-type: none"> Requires expert knowledge of waste or process or use of auxiliary quantitative measurements to rank population units.
Sequential Sampling (Section 5.2.5)	<ul style="list-style-type: none"> Applicable when sampling and/or analysis are quite expensive, when information concerning sampling and/or measurement variability is lacking, when the waste and site characteristics of interest are stable over the time frame of the sampling effort, or when the objective of the sampling effort is to test a specific hypothesis. May not be especially useful if multiple waste characteristics are of interest or if rapid decision making is necessary. 	<ul style="list-style-type: none"> Can reduce the number of samples required to make a decision. Allows a decision to be made with less sampling if there is a large difference between the two populations or between the true value of the parameter of interest and the standard. 	<ul style="list-style-type: none"> If the concentration of the constituent of concern is only marginally different from the action level, sequential procedures will require an increasing number of samples approaching that required for other designs such as simple random or systematic sampling.

Table 6. Guidance for Selection of Sampling Designs (Continued)

<i>Sampling Design</i>	<i>Appropriate Conditions for Use</i>	<i>Advantages</i>	<i>Limitations</i>
Authoritative Sampling			
Judgmental (Section 5.2.6.1)	<ul style="list-style-type: none"> Useful for generating rough estimates of the average concentration or typical property. To obtain preliminary information about a waste stream or site to facilitate planning or to gain familiarity with the waste matrix for analytical purposes. To assess the usefulness of samples drawn from a small portion of the waste or site. To screen samples in the field to identify “hot” samples for subsequent analysis in a laboratory. 	<ul style="list-style-type: none"> Can be very efficient with sufficient knowledge of the site or waste generation process. Easy to do and explain. 	<ul style="list-style-type: none"> The utility of the sampling design is highly dependent on expert knowledge of waste. Nonprobability-based so inference to the general population is difficult. Cannot determine reliable estimates of variability.
Biased (Section 5.2.6.2)	<ul style="list-style-type: none"> Useful to estimate “worst-case” or “best-case” conditions (e.g., to identify the composition of a leak, spill, or waste of unknown composition). 		

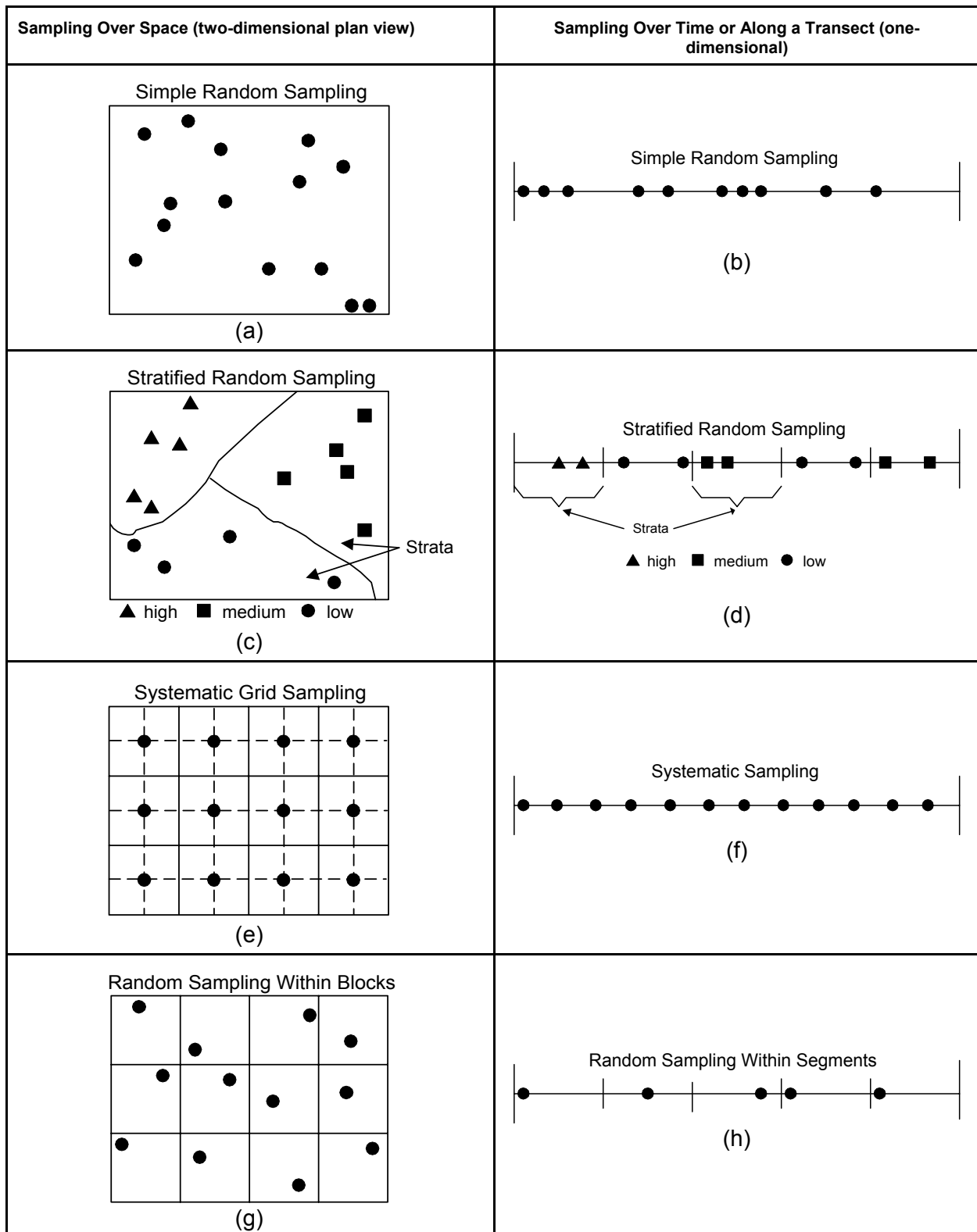

Figure 13. Probability sampling designs over space or along an interval (modified after Cochran 1977 and Gilbert 1987)

5.2.1 Simple Random Sampling

The simplest type of probability sampling is simple random sampling (without replacement), in which every possible sampling unit in the target population has an equal chance of being selected. Simple random samples, like the other samples, can be either samples in space (Figure 13(a)) or in time (Figure 13(b)) and are often appropriate at an early stage of an investigation in which little is known about nonrandom variation within the waste generation process or the site. All of the sampling units should have equal volume or mass, and ideally be of the same shape and orientation if applicable (i.e., they should have the same “sample support”).

With a simple random sample, the term “random” should not be interpreted to mean haphazard; rather, it has the explicit meaning of equiprobable selection. Simple random samples are generally developed through use of a random number table (found in many statistical text books), a random number function on a hand-held calculator, or by a computer.

One possible disadvantage of pure random sampling is that localized clustering of sample points can occur. If this occurs, one option is to select a new random time or location for the sample. Spatial or temporal biases could result if unknown trends, patterns, or correlations are present. In such situations, stratified random sampling or systematic sampling are better options.

5.2.2 Stratified Random Sampling

In stratified random sampling, a heterogeneous unit, site, or process is divided into nonoverlapping groups called **strata**. Each stratum should be defined so that internally it is relatively homogeneous (that is, the variability within each stratum is less than the variability observed over the entire population) (Gilbert 1987). After each stratum is defined, then simple random sampling is used within each stratum (see Figure 13(c) and 15(d)). For very heterogeneous wastes, stratified random sampling can be used to obtain a more efficient estimate of the parameter of interest (such as the mean) than can be obtained from simple random sampling.

It is important to note that stratified random sampling, as described in this guidance, can be used when the objective is to make a decision about the *whole* population or decision unit. If the objective is to determine if a solid waste is a hazardous waste or to measure attainment of a treatment standard for a hazardous waste, then any obvious “hot spots” or high concentration wastes should be characterized separately from low concentration wastes to minimize mixing of

Box 3. Simple Random Sampling: Procedure

1. Divide the area of the study into N equal-size grids, intervals (if sampling over time), or other units. The spacing between adjacent sampling locations should be established in the DQOs, but the length should be measurable in the field with reasonable accuracy. The total number of possible sampling locations (N) should be much larger than n (the number of samples to be collected).*
2. Assign a series of consecutive numbers to each location between 1 and N .
3. Draw n integers between 1 and N from a random number table or use the random number function on a hand-held calculator (i.e., generate a random number between 0 and 1 and multiply the number by N).
4. Collect samples at each of the n locations or intervals.

* For additional guidance on calculating spacing between sampling locations, see *Methods for Evaluating the Attainment of Cleanup Standards, Volume I: Soil and Solid Media* (USEPA 1989a).

hazardous waste with nonhazardous wastes and to prevent impermissible dilution (see also Appendix C). If the objective of the sampling effort is to identify nonrandom spatial patterns (for example, to create a map of contamination in shallow soils), then consider the use of a geostatistical technique to evaluate the site.

In stratified random sampling it is usually necessary to incorporate prior knowledge and professional judgment into a probabilistic sampling design. Generally, wastes or units that are “alike” or

anticipated to be “alike” are placed together in the same stratum. Units that are contiguous in space (e.g., similar depths) or time are often grouped together into the same stratum, but characteristics other than spatial or temporal proximity can be employed. For example, you could stratify a waste based on particle size (such that relatively large pieces of contaminated debris are assigned to one stratum and unconsolidated fines assigned to a separate stratum). This is called *stratification by component*. See Appendix C of this guidance for additional information on stratification, especially as a strategy for sampling heterogeneous wastes, such as debris.

In stratified random sampling a decision must be made regarding the allocation of samples among strata. When chemical variation within each stratum is known, samples can be allocated among strata using *optimum allocation* in which more samples are allocated to strata that are large, more variable internally, or cheaper to sample (Cochran 1977, Gilbert 1987). An alternative is to use *proportional allocation*. In proportional allocation, the sampling effort in each stratum is directly proportional to the size (for example, the mass) of the stratum. See Section 5.4.2 for guidance on determining optimum and proportional allocation of samples to strata.

There are several advantages to stratified random sampling. Stratified random sampling:

- Ensures more uniform coverage of the entire target population
- Ensures that subareas that contribute to overall variability are included in the sample
- Achieves greater precision in certain estimation problems
- Generally will be more cost-effective than simple random sampling even when imperfect information is used to form the strata.

There are also some disadvantages to stratified random sampling. Stratified random sampling is slightly more difficult to implement in the field and statistical calculations for stratified sampling are more complex than for simple random sampling (e.g., due to the use of weighting factors and more complex equations for the appropriate number of samples).

Box 4. Stratified Random Sampling: Procedure

1. Use prior knowledge of the waste stream or site to divide the target population into L nonoverlapping strata such that the variability within stratum is less than the variability of the entire population (for example, see Figure 13c and Figure 13d). The strata can represent area, volume, mass, or time intervals.
2. Assign a weight W_h to each h th stratum. The value of each W_h should be determined based on its relative importance to the data user, or it can be the proportion of the volume, mass, or area of the waste that is in stratum h .
3. Conduct random sampling within each stratum.

5.2.3 Systematic Sampling

Systematic sampling entails taking samples at a preset interval of time or in space and using a randomly selected time or location as the first sampling point (Gilbert 1987).

Systematic sampling over space involves establishing a two-dimensional grid of the unit or waste under investigation (Figure 13(e)). The orientation of the grid is sometimes chosen randomly and various types of systematic samples are possible. For example, points may be arranged in a pattern of squares (rectangular grid sampling) or a pattern of equilateral triangles (triangular grid sampling). The result of either approach is a simple pattern of equally spaced points at which sampling is to be performed. As shown in Figure 13(f), systematic sampling also can be conducted along a transect (every five feet, for example), along time intervals (every hour, for example), or by flow or batches (every 10,000 gallons, for example) (King 1993).

The systematic sampling approach is attractive because it can be easily implemented in the field, but it has some limitations such as not being truly random. You can improve on this sampling design by using random sampling within each grid block (Figure 13(g)) or within each time interval (Figure 13(h)). This approach maintains the condition of equiprobability during the sampling event (Myers 1997) and can be considered a form of *stratified random sampling* in which each of the boundaries of the strata are arbitrarily defined (rather than using prior information) and only one random sample is taken per stratum (Gilbert 1987). This approach is advantageous because it avoids potential problems caused by cycles or trends.

Systematic sampling also is preferred when one of the objectives is to locate “hot spots” within a site or otherwise map the pattern of concentrations over an area (e.g., using geostatistical techniques). Even without using geostatistical methods, “hot spots” or other patterns could be identified by using a systematic design (see “ELIPGRID” software in Appendix H and Gilbert 1987, page 119). On the other hand, the systematic sampling design should be used with caution whenever there is a possibility of some type of cyclical pattern in the waste unit or

Box 5: Systematic Sampling: Procedure

Sampling Over Space

1. Determine the size of the area to be sampled.
2. Denote the surface area of the sample area by A .
3. Assuming a square grid is used, calculate the length of spacing between grid nodes (L)

$$L = \sqrt{\frac{A}{n}}$$

where n is the number of samples. The distance L should be rounded to the nearest unit that can be easily measured in the field.

4. To determine the sampling locations, randomly select an initial sampling point within the area to be sampled. Using this location as one intersection of two gridlines, construct gridlines parallel to the original grid and separated by distance L .
5. Collect samples at each grid node (line intersection) (see Figure 13e). Alternatively, randomly select a sampling point *within* each grid block (see Figure 13g).

Sampling Along a Line (e.g., Over Time)

1. Determine the start time and point and the total length of time (N) over which the samples will be collected.
2. Decide how many samples (n) will be collected over the sampling period.
3. Calculate a sampling interval where $k = \frac{N}{n}$.
4. Randomly select a start time and collect a sample every k th interval until n samples have been obtained (see Figure 13f). Alternatively, randomly select a sampling point *within* each interval (Figure 13h).

process that might match the sampling frequency, especially processes being measured over time (such as discharges from a pipe or material on a conveyor).

Figure 14 illustrates the potential disadvantage of using systematic sampling when cyclic trends are present. When there is a cyclic trend in a waste generation process, using a uniform pattern of sampling points can result in samples with very unusual properties. The sets of points labeled “A” and “B” are systematic samples for which the sampling intervals are one period and one-half period, respectively. The points labeled “A” would result in a biased estimate of the mean but a sampling variance of zero. The points labeled “B” would result in an unbiased estimate of the mean with very small variance, even a zero variance if the starting point happened to be aligned exactly with the mean.

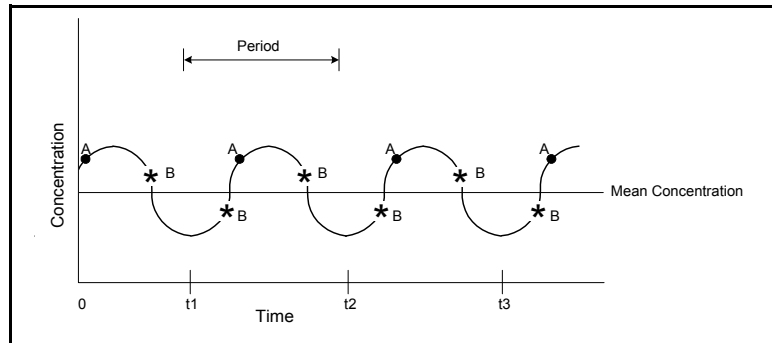

Figure 14. Potential pitfall of systematic sampling over time: cyclic trend combined with a systematic sampling design (after Cochran 1977 and Gilbert 1987)

5.2.4 Ranked Set Sampling

Ranked set sampling (RSS) (McIntyre 1952) can create a set of samples that at a minimum is equivalent to a simple random sample, but can be as much as two to three times more efficient than simple random sampling. This is because RSS uses the availability of expert knowledge or an inexpensive surrogate measurement or auxiliary variable that is correlated with the more expensive measurement of interest. The auxiliary variable can be a qualitative measure, such as visual inspection for color or an inexpensive quantitative (or semi-quantitative) measure that can be obtained from a field instrument such as a photoionization detector for volatile organics or an X-ray fluorescence analyzer for elemental analysis. RSS exploits this correlation to obtain a sample that is more representative of the population than would be obtained by random sampling, thereby leading to more precise estimates of the population parameters than random sampling. RSS is similar to other probabilistic sampling designs such as simple random sampling in that sampling points are identified and samples are collected. In RSS, however, only a subset of the samples are selected for analysis.

RSS consists of creating m groups, each of size m (for a total of “ $m \times m$ ” initial samples), then ranking the surrogate from largest to smallest within each group. One sample from each group is then selected according to a specified procedure and these m samples are analyzed for the more expensive measurement of interest (see Box 6 and Figure 15).

The true mean concentration of the characteristic of interest is estimated by the arithmetic sample mean of the measured samples (e.g., by Equation 1). The population variance and standard deviation also are estimated by the traditional equations (e.g., by Equations 2 and 3). For additional information on RSS, see USEPA 1995b, USEPA 2000c, and ASTM D 6582 *Standard Guide for Ranked Set Sampling: Efficient Estimation of a Mean Concentration in Environmental Sampling*.

Box 6. Ranked Set Sampling: Procedure

1. Identify some auxiliary characteristic by which samples can be ranked in order from lowest to highest (e.g., by use of a low-cost field screening method).
2. Randomly select $m \times m$ samples from the population (e.g., by using simple random sampling).
3. Arrange these samples into m sets of size m .
4. Within each set, rank the samples by using only the auxiliary information on the samples.
5. Select the samples to be analyzed as follows (see Figure 17):
 - In Set 1, select the sample with rank 1
 - In Set 2, select the sample with rank 2, etc ...
 - In Set m , select the unit with rank m .
6. Repeat Steps 1 through 5 for r cycles to obtain a total of $n = m \cdot r$ samples for analysis.

$m = 4$

Rank

	1	2	3	4
Set 1	●	○	○	○
Set 2	○	●	○	○
Set 3	○	○	●	○
Set 4	○	○	○	●

● Sample sent for analysis *For example, if 12 samples are needed, the process is repeated 2 more times using fresh samples.*

○ Sample ignored

Figure 15. Ranked set sampling. After the samples are ranked in order from lowest to highest, a sample is selected for analysis from Set 1 with Rank 1, from Set 2 with Rank 2, etc.

5.2.5 Sequential Sampling

In sequential testing procedures (Wald 1973), sampling is performed by analyzing one (or more) sample(s) at a time until enough data have been collected to meet the statistical confidence level that the material does not exceed the critical level. The expected sample size, using this sequential procedure, can be approximately 30- to 60-percent lower than a corresponding fixed sample size test with the same power. The sequential procedure is especially helpful in situations in which the contamination is very high or very low relative to the action level. In these situations, the sequential procedure will quickly accumulate enough evidence to conclude that the waste or site either meets or fails to meet the standard.

Figure 16 shows how the procedure operates in a simple example for determining the mean concentration of a constituent of concern in soil. This particular example involves clean closure of a waste management unit, however, the approach could be used for other situations in which the mean is the parameter of interest. The procedure consists of analyzing groups of samples and calculating the mean and 80-percent confidence interval (or upper 90-percent confidence limit) for the mean after analysis of each group of samples. The horizontal axis represents the number of sample units evaluated. The vertical axis represents the concentration of the contaminant; plotted are the mean and 80-percent confidence interval after analysis of n samples. The AL , against which the sample is to be judged, is shown as a horizontal line.

The sampled units are analyzed first in a small lot (e.g., five samples). After each evaluation the mean and confidence interval on the mean are determined (point "a"). If the 90-percent UCL on the mean value stays above the critical value, AL , after successive increments are analyzed, the soil in the unit cannot be judged to attain the action level (point "b"). If the UCL goes below

the critical value line, it may be concluded that the soil attains the standard. In the figure, the total number of samples is successively increased until the 90-percent UCL falls below the critical level (points “c” and “d”).

A sequential sampling approach also can be used to test a percentile against a standard. A detailed description of this method is given in Chapter 8 of *Methods for Evaluating the Attainment of Cleanup Standards Volume 1: Soil and Solid Media* (USEPA 1989a).

In sequential sampling, the number of samples is not fixed *a priori*; rather, a statistical test is performed after each analysis to arrive at one of three possible decisions: reject the hypothesis, accept the hypothesis, or perform another analysis. This strategy is applicable when sampling and/or analyses are quite expensive, when information concerning sampling and/or measurement variability is lacking, when the waste and site characteristics of interest are stable over the time frame of the sampling effort, or when the objective of the sampling effort is to test a specific hypothesis. It may not be especially useful if multiple waste characteristics are of interest or if rapid decision making is necessary.

In planning for a sequential sampling program, the following considerations are important:

- Pre-planning the effort between the field and laboratory, including developing a system of pre-planned paperwork and sample containers
- Arranging for a system of rapid delivery of samples to the laboratory
- Providing rapid turnaround in the laboratory
- Rapidly returning data to the planners, supervisors, and others responsible for decision making.

If the sequential sampling program is carried out using field methods (e.g., portable detectors), much of the inconvenience involved with shipping and return of results can be avoided.

5.2.6 Authoritative Sampling

Authoritative sampling is a nonstatistical sampling design because it does not assign an equal probability of being sampled to all portions of the population. This type of sampling should be considered only when the objectives of the investigation do not include the estimation of a population parameter. For example, authoritative sampling might be appropriate when the objective of a study is to identify specific locations of leaks, or when the study is focused solely

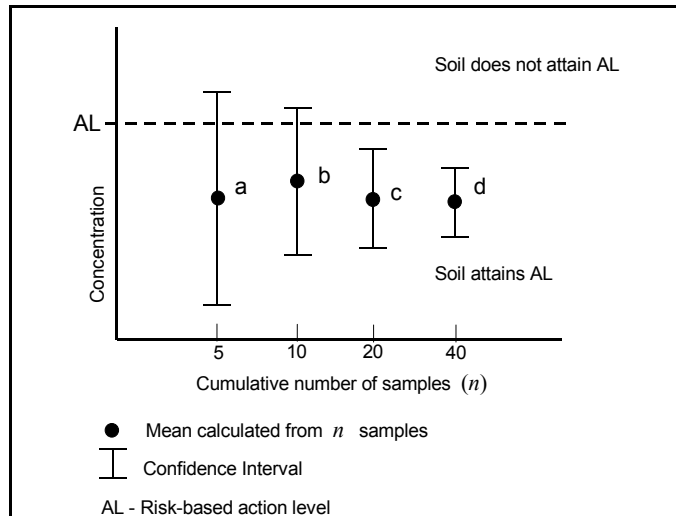

Figure 16. Example of sequential testing for determining if concentrations of a constituent of concern in soil at a closed waste management unit are below a risk-based action level (AL).

on the sampling locations themselves. The validity of the data gathered with authoritative sampling is dependent on the knowledge of the sampler and, although valid data sometimes can be obtained, it is not recommended for the chemical characterization of wastes when the parameter of interest (such as the mean) is near the action level.

Authoritative sampling (also known as judgmental sampling, biased sampling, nonprobability sampling, nonstatistical sampling, purposive sampling, or subjective sampling) may be appropriate under circumstances such as the following:

- You need preliminary information about a waste stream or site to facilitate planning or to gain familiarity with the waste matrix for analytical purposes.
- You are conducting sampling for a RCRA Facility Assessment (RFA) to identify a potential or actual release to the environment.
- You have encountered a spill of an unknown chemical and need to determine the chemical makeup of the spilled material.
- You have access to only small portions of the population and judgment is applied to assess the usefulness of samples drawn from the small portion.
- You are screening samples in the field, using an appropriate field method, to identify “hot” samples for subsequent analysis in a laboratory.
- You are sampling to support case development for an enforcement agency or to “prove the positive” (see also Section 2.2.4).

With authoritative sampling, it is not possible to accurately estimate the population variance. Also, due to its subjective nature, the use of authoritative sampling by the regulated community to demonstrate compliance with regulatory standards generally is not advisable except in those cases in which a small volume of waste is in question or where the concentration is either well above or well below the regulatory threshold.

The ASTM recognizes two types of authoritative sampling: judgmental sampling and biased sampling (ASTM D 6311).

5.2.6.1 Judgmental Sampling

Judgmental sampling is a type of authoritative sampling. The goal of judgmental sampling is to use process or site knowledge to choose one or more sampling locations to represent the “average” concentration or “typical” property.

Judgmental sampling designs can be cost-effective *if* the people choosing the sampling locations have sufficient knowledge of the waste. If the people choosing the sampling locations intentionally distort the sampling by a prejudiced selection, or if their knowledge is wanting, judgmental sampling can lead to incorrect and sometimes very costly decisions. Accurate and useful data can be generated from judgmental sampling more easily if the population is relatively homogeneous and the existence of any strata and their boundaries is known. The disadvantages of judgmental sampling designs follow:

- It can be difficult to demonstrate that prejudice was not employed in sampling location selection
- Variances calculated from judgmental samples may be poor estimates of the actual population variance
- Population statistics cannot be generated from the data due to the lack of randomness.

An example application of judgement sampling is given in Appendix C of *Guidance for the Data Quality Objectives Process for Hazardous Waste Site Operations* (USEPA 2000a).

5.2.6.2 Biased Sampling

Biased sampling is the type of authoritative sampling that intends not to estimate average concentrations or typical properties, but to estimate “worst” or “best” cases (ASTM D 6051-96). The term “biased,” as used here, refers to the collection of samples with expected very high or very low concentrations. For example, a sample taken at the source of a release could serve as an estimate of the “worst-case” concentration found in the affected media. This information would be useful in identifying the constituent of concern and estimating the maximum level of contamination likely to be encountered during a cleanup.

At times, it may be helpful to employ a “best case” or both a “best-case” and “worst-case” biased sampling approach. For example, if there is a range of wastes and process knowledge can be used to identify the wastes likely to have the lowest and highest contamination levels, then these two extremes could be sampled to help define the extent of the problem.

Biased sampling, while having the ability to cost-effectively generate information, has similar disadvantages to that of judgmental sampling.

5.3 Composite Sampling

Composite sampling is a strategy in which multiple individual or “grab” samples (from different locations or times) are physically combined and mixed into a single sample so that a physical, rather than a mathematical, averaging takes place.¹ Figure 17 illustrates the concept of composite samples. For a well-formed composite, a single measured value should be similar to the mean of measurements of the individual components of the composite (Fabrizio, et al. 1995). Collection of multiple composite samples can provide improved sampling precision and reduce the total number of analyses required compared to noncomposite sampling. This strategy is sometimes employed to reduce analysis costs when analysis costs are large relative to sampling costs. The appropriateness of using composite sampling will be highly dependent on the DQOs (Myers 1997), the constituent of concern, and the regulatory requirements. *To realize the full benefits of composite sampling, field and laboratory personnel must carefully*

¹ Some authors use the term “discrete sample” to refer to an individual sample that is used to form a composite sample. The RCRA regulations often use the term “grab sample.” For the purpose of this guidance, the terms “discrete,” “grab,” and “individual” sample have the same meaning.

follow correct procedures for sample collection, mixing, and subsampling (see Sections 6 and 7).

5.3.1 Advantages and Limitations of Composite Sampling

A detailed discussion of the advantages and limitations of composite sampling is presented in the *Standard Guide for Composite Sampling and Field Subsampling for Environmental Waste Management Activities* (ASTM D 6051-96) and EPA's *Guidance for Choosing a Sampling Design for Environmental Data Collection, EPA QA/G-5S* (USEPA 2000c). Additional information on composite sampling can be found in Edland and van Belle (1994), Gilbert (1987), Garner, et al. (1988 and 1989), Jenkins, et al. (1996 and 1997), Myers (1997), and USEPA (1995c).

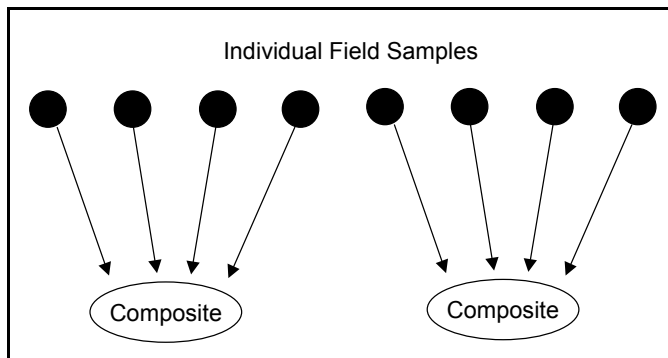

Figure 17. Forming composite samples from individual samples (from USEPA 1995c).

Advantages

Three principal advantages to using composite sampling (see ASTM D 6051-96) follow:

- It can improve the precision (i.e., reduce between-sample variance) of the estimate of the mean concentration of a constituent in a waste or media (see Section 5.3.5)
- It can reduce the cost of estimating a mean concentration, especially in cases in which analytical costs greatly exceed sampling costs or in which analytical capacity is limited
- A “local” composite sample, formed from several increments obtained from a localized area, is an effective way to increase the sample support, which reduces grouping and segregation errors (see also Section 6.2.2.2)
- It can be used to determine whether the concentration of a constituent in one or more individual samples used to form a composite might exceed a fixed standard (i.e., is there a “hot spot”?) (see Section 5.3.6).

Limitations

Composite sampling should not be used if the integrity of the individual sample values changes because of the physical mixing of samples (USEPA 1995c). The integrity of individual sample values could be affected by chemical precipitation, exsolution, or volatilization during the pooling and mixing of samples. For example, volatile constituents can be lost upon mixing of samples or interactions can occur among sample constituents. In the case of volatile constituents, compositing of individual sample extracts within a laboratory environment may be a reasonable alternative to mixing individual samples as they are collected.

Listed below are some additional conditions under which compositing usually is *not* advantageous:

- When regulations *require* the use of discrete or grab samples. For example, compliance with the LDR numeric treatment standards for non-wastewaters typically is to be determined using “grab” samples rather than composite samples. Grab samples processed, analyzed, and evaluated individually normally reflect maximum process variability, and thus reasonably characterize the range of treatment system performance. Typically, grab samples are used to evaluate LDR non-wastewaters and composite samples are used to evaluate LDR wastewaters, except when evaluating wastewaters for metals (D004 through D011) for which grab samples are required [40 CFR 268.40(b)].
- When data users require specific data points to generate high-end estimates or to calculate upper percentiles
- When sampling costs are much greater than analytical costs
- When analytical imprecision outweighs sampling imprecision and population heterogeneity
- When individual samples are incompatible and may react when mixed
- When properties of discrete samples, such as pH or flash point, may change qualitatively upon mixing. (Compositing of individual samples from different locations to be tested for hazardous waste characteristic properties, such as corrosivity, reactivity, ignitability, and toxicity, is not recommended)
- When analytical holding times are too short to allow for analysis of individual samples, *if* testing of individual samples is required later (for example, to identify a “hot” sample) (see Section 5.3.6)
- When the sample matrix impedes correct homogenization and/or subsampling
- When there is a need to evaluate whether the concentrations of different contaminants are correlated in time or space.

5.3.2 Basic Approach To Composite Sampling

The basic approach to composite sampling involves the following steps:

- Identify the boundaries of the waste or unit. The boundaries may be spatial, temporal, or based on different components or strata in the waste (such as battery casings and soil)
- Conduct sampling in accordance with the selected sampling design and collect a set of $n \times g$ individual samples where g is the number of individual samples used to form each composite and n is the number of such composites

- Group either randomly or systematically the set of $n \times g$ individual samples into n composite samples and thoroughly mix and homogenize each composite sample
- Take one or more subsamples from each composite
- Analyze each subsample for the constituent(s) of concern.

The n composite samples can then be used to estimate the mean and variance (see Section 5.3.5) or identify “hot spots” in the waste (see Section 5.3.6).

5.3.3 Composite Sampling Designs

Composite sampling can be implemented as part of a statistical sampling design, such as simple random sampling and systematic sampling. The choice of a sampling design to use with compositing will depend upon the study objectives.

5.3.3.1 Simple Random Composite Sampling

Figure 18 shows how composite sampling can be integrated into a simple random sampling design. In this figure, the decision unit could represent any waste or media about which a decision must be made (such as a block of contaminated soil at a SWMU). Randomly positioned field samples are randomly grouped together into composite samples. The set of composite samples can then be used to estimate the mean and the variance.

Because the compositing process is a mechanical way of averaging out variabilities in concentrations from location to location over a unit, the resulting concentration data should tend to be more normally distributed than individual samples (Exner, et al. 1985). This is especially advantageous because the assumption of many statistical tests is that the underlying data exhibit an approximately normal distribution.²

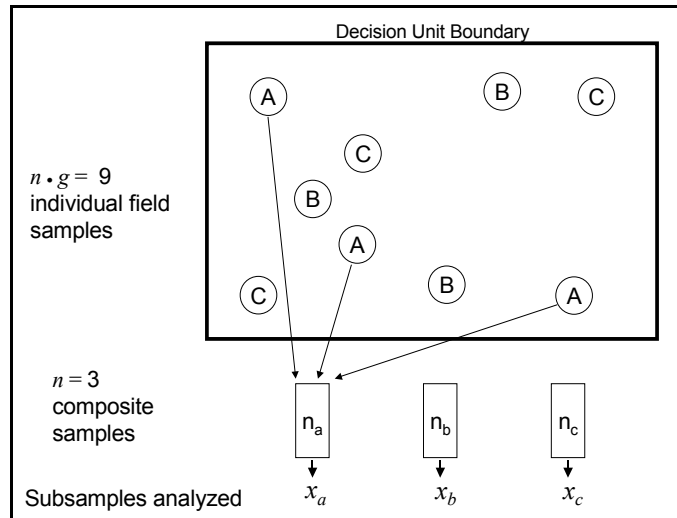

Figure 18. A basic approach to composite sampling. The figure shows how composite sampling can be integrated into a simple random sampling design. Random samples with the same letter are randomly grouped into composite samples to obtain an estimate of the unit-wide mean.

² By the Central Limit Theorem (CLT), we expect composite samples to generate normally distributed data. The CLT states that if a population is repeatedly sampled, the means of all the sampling events will tend to form a normal distribution, regardless of the shape of the underlying distribution.

5.3.3.2 Systematic Composite Sampling

A systematic composite sampling design is shown in Figure 19. The design can be used to estimate the mean concentration because each composite sample is formed from field samples obtained across the entire unit. For example, each field sample collected at the “A” locations is pooled and mixed into one composite sample. The process is then repeated for the “B,” “C,” and “D” locations. The relative location of each individual field sample (such as “A”) should be the same within each block.

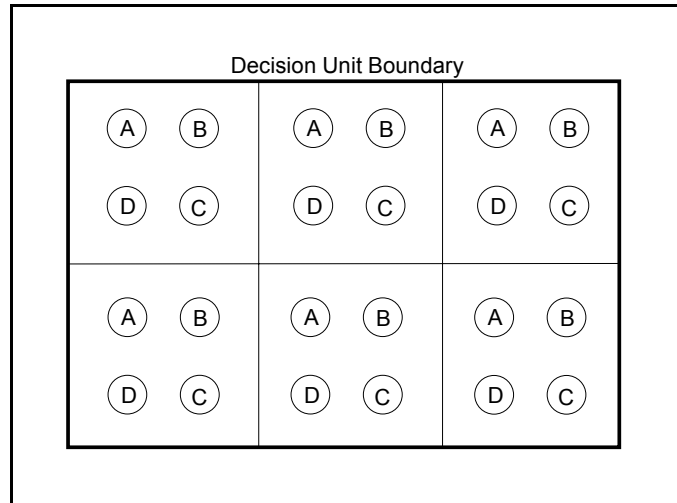

Figure 19. Systematic composite sampling across a unit or site. Samples with the same letter are pooled into composites.

This design is particularly advantageous because it is easy to implement and explain and it provides even coverage of the unit. Exner, et al. (1985)

demonstrated how this design was used to make cleanup decisions for blocks of soil contaminated with tetrachlorodibenzo-p-dioxin.

A second type of systematic composite involves collecting and pooling samples from *within* grid blocks, time intervals, or batches of waste grouped together (see Figure 20).

If there is spatial correlation between the grid blocks, compositing within grids can be used to estimate block-to-block variability (Myers 1997) or improve the estimate of the mean within a block or interval (if multiple composite samples are collected within each block). In fact, compositing samples collected from localized areas is an effective means to control “short-range” (small-scale) heterogeneity (Pitard 1993). When this type of compositing is used on localized areas in lieu of “grab” sampling, it is an attractive option to improve representativeness of individual samples (Jenkins, et al. 1996).

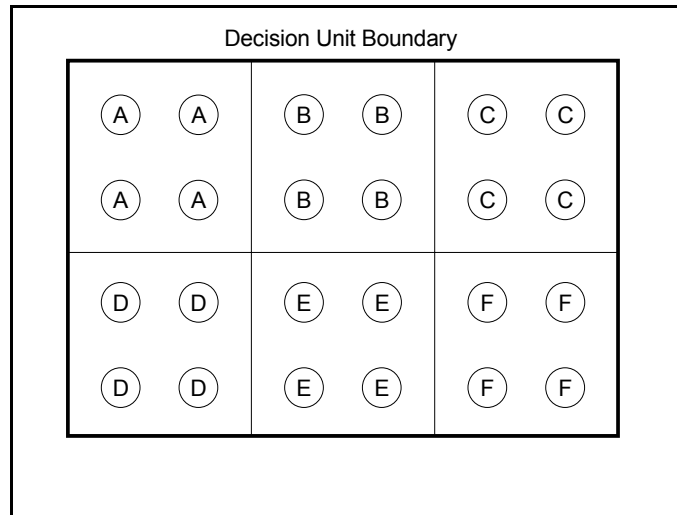

Figure 20. Systematic sampling within grid blocks or intervals. Samples with the same letter are pooled into a composite sample.

Systematic sampling within time intervals could be used in cases in which compositing occurs as part of sample collection (such as sampling of liquid effluent with an autosampling device into a single sample container over a specified time period).

If the individual field sample locations are independent (that is, they have no temporal or spatial correlation), then compositing within blocks can be an efficient strategy for estimating the population mean. If the assumption of sample independence cannot be supported, then an alternative design should be selected if the objective is to estimate the mean.

5.3.4 Practical Considerations for Composite Sampling

In creating composite samples from individual field samples, it is possible that a relatively large volume of material will need to be physically mixed at some point -- either in the field or in the laboratory. Thorough mixing is especially important when the individual samples exhibit a high degree of heterogeneity.

Once the individual samples are mixed, one or more subsamples must be taken because the entire composite sample usually cannot be analyzed directly. A decision must be made as to *where* the individual samples will be combined into the composite samples. Because large samples (e.g., several kilograms or more) may pose increased difficulties to the field team for containerization and shipping and pose storage problems for the laboratory due to limited storage space, there may be a distinct advantage to performing mixing or homogenization in the field. There are, however, some disadvantages to forming the composite samples in the field. As pointed out by Mason (1992), the benefits of homogenization may be temporary because gravity induced segregation can occur during shipment of the samples. Unless homogenization (mixing), particle size reduction, and subsampling are carried out immediately prior to analysis, the benefits of these actions may be lost. Therefore, if practical, it may be best to leave the mixing and subsampling operations to laboratory personnel.

See Section 7.3 of this document and ASTM standards D 6051 and D 6323 for guidance on homogenization, particle size reduction, and subsampling.

5.3.5 Using Composite Sampling To Obtain a More Precise Estimate of the Mean

When analytical error is minor compared to sampling error, then composite sampling can be a resource-efficient mechanism for increasing the precision of estimates of the population mean. If composite sampling is to be used to estimate the mean with a specified level of confidence, then multiple composite samples can be used to estimate the mean and variance. Alternately, confidence limits can be constructed around the sample analysis result for a single composite sample if an estimate of the variance of the fundamental error is available (see Gy 1998, page 73).³ See Section 6.2.2.1 for a discussion of fundamental error.

The population mean (μ) can be estimated from the analysis of n composite samples (each made from g individual samples). The population mean (μ) is estimated by the sample mean (\bar{x}) by

$$\bar{x} = \frac{1}{n} \sum_{i=1}^n x_i \quad \text{Equation 6}$$

³ ASTM D 6051, *Standard Guide for Composite Sampling and Field Subsampling for Environmental Waste Management Activities*, also provides a procedure for estimating the precision of a single composite sample.

The sample variance (s^2) can then be calculated by

$$s^2 = \frac{1}{n-1} \sum_{i=1}^n (x_i - \bar{x})^2 \quad \text{Equation 7}$$

Note that Equations 6 and 7 are the same as Equations 1 and 2, respectively, for the mean and variance. When the equations are used for composite sampling, x_i is the measurement value from a subsample taken from each n composite sample rather than each individual sample. Use of these equations assumes equal numbers of individual field samples (g) are used to form each composite, and equal numbers of subsamples are taken from each composite sample and analyzed. If these assumptions are not correct, an alternative approach described in Gilbert (1987, page 79) can be used.

By increasing the number of individual field samples (g) per composite sample, there will be a corresponding decrease in the standard error ($s_{\bar{x}}$), thus improving the precision of the estimate of the mean. Edland and van Belle (1994) show that by doubling the number of individual samples per composite (or laboratory) sample, the expected size of the confidence interval around the mean decreases by a factor of $1/\sqrt{2}$, which is a 29-percent decrease in the expected width of the confidence interval. One of the key assumptions underlying the above discussion is that variances between the samples greatly exceed the random error variance of the analytical method (Garner, et al. 1988).

Williams, et al. (1989) demonstrated the benefits of using composite sampling to obtain a more precise estimate of the mean. One of their objectives was to study the efficiency of using composite sampling as compared to collecting individual samples for the purpose of estimating the mean concentration at a site. Five sites known to have radium contamination in shallow soils were extensively sampled. At each site, shallow soil samples were collected at approximately uniformly spaced points over the entire site. Three types of samples were taken: (1) individual 500-gram samples, (2) composite samples consisting of ten 50-gram aliquots uniformly spaced over the site, and (3) composite samples consisting of twenty 25-gram aliquots uniformly spaced over the site. The samples were measured for ^{226}Ra . The results indicated the individual samples yielded the least precision, even when more than twice as many individual samples were collected. Sixty-six individual samples produced a standard error of 1.35, while the thirty 10-aliquot composites and the thirty 20-aliquot composite samples produced standard errors of 0.76 and 0.51 respectively. The results demonstrate that composite sampling can produce more precise estimates of the mean with fewer analytical samples.

Box 7 provides an example of how a mean and variance can be estimated using composite sampling combined with systematic sampling.

Box 7. Example of How To Estimate the Mean and Variance Using Systematic Composite Sampling (Assume Samples Are Independent)

Under 40 CFR 261.38, a generator of hazardous waste-derived fuel is seeking an exclusion from the definition of solid and hazardous-waste. To prepare the one-time notice under 40 CFR 261.38(c), the generator requires information on the mean and variance of the concentrations of constituents of concern in the waste as generated. The generator elects to use composite samples to estimate the mean and variance of the nonvolatile constituents of concern.

Using a systematic sampling design, a composite sample is prepared by taking an individual (grab) sample at regular time intervals t_1 through t_4 . The set of four grab samples are thoroughly mixed to form a composite, and one subsample is taken from each composite for analysis. The process is repeated until five composite samples are formed (see Figure 21). (Note: If the assumption of independent samples cannot be supported, then a simple random design should be used in which the 20 grab samples are randomly grouped to form the five composites).

The analytical results for one of the constituents of concern, in ppm, are summarized as follows for the composite samples (n_1 through n_5): 2.75, 3.71, 3.28, 1.95, and 5.10.

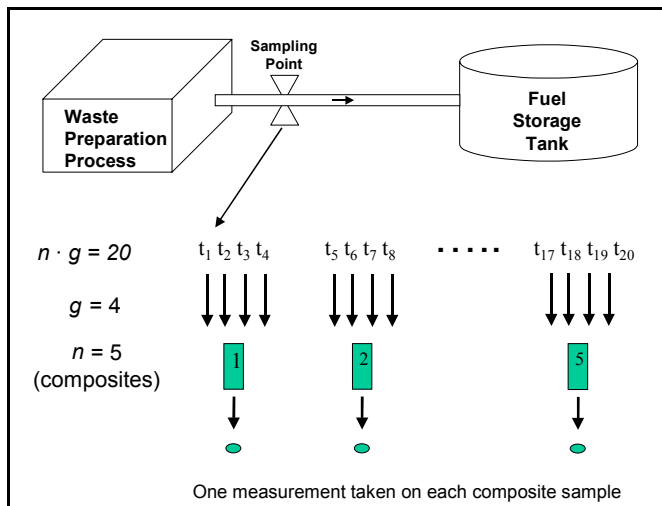

Figure 21. Example of systematic composite sampling

Using Equations 6 and 7 for the mean and variance of composite samples, the following results are obtained:

$$\bar{x} = \frac{1}{n} \sum_{i=1}^n x_i = \frac{16.79}{5} = 3.36 \text{ ppm}$$

$$s^2 = \frac{1}{n-1} \sum_{i=1}^n (x_i - \bar{x})^2 = \frac{1}{4} [0.3721 + 0.1225 + 0.0064 + 1.99 + 3.03] = 1.38$$

The standard error is obtained as follows:

$$s_{\bar{x}} = \frac{s}{\sqrt{n}} = \frac{1.17}{\sqrt{5}} = 0.52 \text{ ppm}$$

5.3.6 Using Composite Sampling To Locate Extreme Values or “Hot Spots”

One disadvantage of composite sampling is the possibility that one or more of the individual samples making up the composite could be “hot” (exceed a fixed standard), but remain undetected due to dilution that results from the pooling process. If the sampling objective is to determine if any one or more individual samples is “hot,” composite sampling can still be used.

A procedure for detecting hot spots using composite sampling is given below. The approach assumes the underlying distribution is normal and the composite samples were formed from equal-sized individual samples.

Let AL be some “action level” or regulatory threshold that cannot be exceeded in an individual sample. Note that AL must be large relative to the quantitation limit for the constituent of concern. For a measurement x_i from a composite sample formed from g individual samples, the following rules apply, assuming analytical and sampling error are negligible:

- If $x_i < \frac{AL}{g}$, then no single individual sample can be $> AL$
- If $x_i > AL$, then at least one *must*, and as many as all individual samples *may*, be $> AL$
- If $x_i > \frac{AL}{g}$, then at least one of the g individual samples must be $> AL$.

As a general rule, we can say that no more than $\frac{g \cdot x_i}{AL}$ individual samples can be $> AL$.

If one or more of the composites are “hot” (i.e., $> AL$), then it might be desirable to go back and analyze the individual samples used to form the composite. Consider saving splits of each individual field sampling so individual samples can be analyzed later, if needed.

If compositing is used to identify a hot spot, then the number of samples that make up the composite should be limited to avoid overall dilution below the analytical limit. It is possible for a composite sample to be diluted to a concentration below the quantitation limit if many of the individual samples have concentrations near zero and a single individual sample has a concentration just above the action level. Mason (1992) and Skalski and Thomas (1984) suggest the maximum number of identically sized individual samples (g) that can be used to form such a composite should not exceed the action level (AL) divided by the quantitation limit (QL). But the relationship of $g \leq AL / QL$ indicates that the theoretical maximum number of samples to form a composite can be quite high, especially given a very low quantitation limit. As a practical matter, the number of individual samples used to form a composite should be kept to a minimum (usually between 2 and 10).

An example of the above procedure, provided in Box 8, demonstrates how a “hot” drum can be identified through the analysis of just nine samples (five composites plus four individual analyses), resulting in considerable savings in analytical costs over analysis of individual samples from each of the 20 drums.

Box 8. How To Locate a “Hot Spot” Using Composite Sampling - Hypothetical Example

A secondary lead smelter produces a slag that under some operating conditions exhibits the Toxicity Characteristic (TC) for lead. At the point of generation, a grab sample of the slag is taken as the slag is placed in each drum. A composite sample is formed from the four grab samples representing a set of four drums per pallet. The process is repeated until five composite samples representing five sets of four drums (20 drums total) have been prepared (see Figure 22).

The generator needs to know if the waste in any single drum in a given set of four drums contains lead at a total concentration exceeding 100 ppm. If the waste in any single drum exceeds 100 ppm, then its maximum theoretical TCLP leachate concentration could exceed the regulatory limit of 5 mg/L. Waste in drums exceeding 100 ppm total lead will be tested using the TCLP to determine if the total leachable lead equals or exceeds the TC regulatory limit.

The sample analysis results for total lead are measured as follows (in ppm) in composite samples n_1 through n_5 : 6, 9, 18, 20, and 45.

Using the approach for locating a “hot spot” in a composite sample, we observe that all of the composite samples except for n_5 are less than AL / g or 100 ppm/4 (i.e., 25

ppm). The result for n_5 (45 ppm) is greater than 25 ppm, indicating a potential exceedance of the TC regulatory level. A decision about the set of drums represented by n_5 can be made as follows:

No more than $\frac{g \cdot x_i}{AL}$ individual samples can be $> AL$, or no more than $\frac{(4)45 \text{ ppm}}{100 \text{ ppm}} = 1.8$ or 1 (round down) individual sample exceeds 100 ppm total lead.

We now know that it is possible that one of the four drums on the fifth palette exceeds 100 ppm, but we do not know *which* one. As a practical matter, analysis of all four of the individual samples should reveal the identity of the “hot” drum (if, indeed, one exists); however, the above process of elimination could be repeated on two new composite samples formed from samples taken from just the four drums in question.

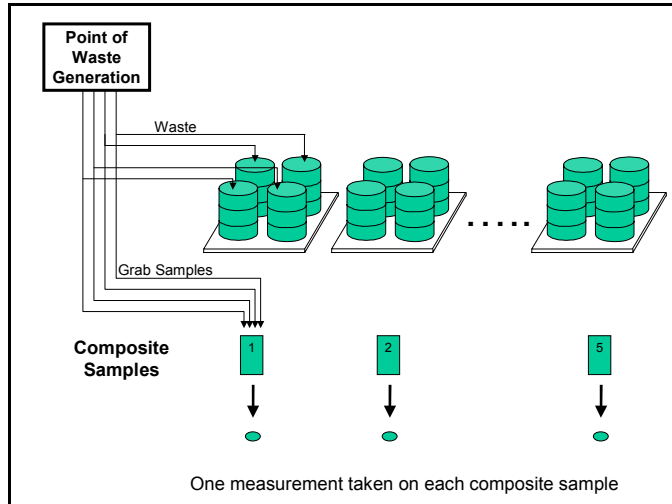

Figure 22. Composite sampling strategy for locating a “hot” drum

5.4 Determining the Appropriate Number of Samples Needed To Estimate the Mean

This section provides guidance for determining the appropriate number of samples (n) needed to estimate the mean. The procedures can be used when the objective is to calculate a confidence limit on the mean. If the objective is to estimate a percentile, see Section 5.5.

To calculate the appropriate number of samples, it is necessary to assemble existing data identified in DQO Step 3 (“Identify Inputs to the Decision”) and Step 6 (“Specify Limits on Decision Errors”). If the parameter of interest is the mean, you can calculate n using equations presented in the following sections or by using EPA’s DEFT software (USEPA 2001a).

Alternative equations can be found in the statistical literature and guidance, including ASTM (Standard D 6311), Cochran (1977), Gilbert (1987), and USEPA (2000a, 2000b, and 2000d).

The equations presented here should yield the approximate minimum number of samples needed to estimate the mean within the precision and confidence levels established in the DQO Process; however, *it is prudent to collect a somewhat greater number of samples than indicated by the equations.*⁴ This is recommended to protect against poor preliminary estimates of the mean and standard deviation, which could result in an underestimate of the appropriate number of samples to collect. For analytes with long holding times (e.g., 6 months), it may be possible to process and store extra samples appropriately until analysis of the initially identified samples is completed and it can be determined if analysis of the additional samples is warranted.

It is important to note that the sample size equations do not account for the number or type of control samples (or quality assessment samples) required to support the QC program associated with your project. Control samples may include blanks (e.g., trip, equipment, and laboratory), field duplicates, spikes, and other samples used throughout the data collection process. Refer to Chapter One of SW-846 for recommendations on the type and number of control samples needed to support your project. It is best to first determine how each type of control sample is to be used, then to determine the number of that type based on their use (van Ee, et al. 1990).

A key assumption for use of the sample size equations is that you have some prior estimate of the total study error, measured as the sample standard deviation (s) or sample variance (s^2). Since total study error includes variability associated with the sampling and measurement methods (see Section 6), it is important to understand the relative contributions that sampling and analysis activities make to the overall estimate of variability. Lack of prior information regarding population and measurement variability is one of the most frequently encountered difficulties in sampling. It quickly resembles a “chicken-and-the-egg” question for investigators – you need an estimate of the standard deviation to calculate how many samples you need, yet you cannot derive that estimate without any samples. To resolve this seemingly paradoxical question, two options are available:

Option 1. Conduct a pilot study. A pilot study (sometimes called an exploratory or preliminary study) is the preferred method for obtaining estimates of the mean and standard deviation, as well as other relevant information. The pilot study is simply phase one of a multi-phase sampling effort (Barth, et al. 1989). For some pilot studies, a relatively small number of samples (e.g., four or five or more) may provide a suitable *preliminary estimate* of the standard deviation.

Option 2. Use data from a study of a similar site or waste stream. In some cases, you might be able to use sampling and analysis data from another facility or similar operation that generates the same waste stream and uses the same process.

If neither of the above options can provide a suitable estimate of the standard deviation (s), a crude approximation of s still can be obtained using the following approach adopted from

⁴ One exception is when sequential sampling is used in which the number of samples is not fixed *a priori*; rather, the statistical test is performed after each round of sampling and analysis (see Section 5.2.5).

USEPA 1989a (page 6-6). The approximation is based on the *judgment* of a person knowledgeable of the waste and his or her *estimate* of the range within which constituent concentrations are likely to fall. Given a range of constituent concentrations in a waste, but lacking the individual data points, an *approximate* value for s may be computed by dividing the *range* (the estimated maximum concentration minus the minimum concentration) by 6, or $s \approx \text{Range} / 6$. This approximation method should be used only if no other alternative is available. The approach is based on the assumption that more than 99 percent of all normally distributed measurements will fall within three standard deviations of the mean; therefore, the length of this interval is $6s$.

5.4.1 Number of Samples to Estimate the Mean: Simple Random Sampling

In Step 6 of the DQO Process (“Specify Limits on Decision Errors”), you established the width of the gray region (Δ) and acceptable probabilities for making a decision error (α and β). Using this information, along with an estimate of the standard deviation (s), calculate the appropriate number of samples (n) for simple random sampling using

$$n = \frac{(z_{1-\alpha} + z_{1-\beta})^2 s^2}{\Delta^2} + \frac{z_{1-\alpha}^2}{2} \quad \text{Equation 8}$$

where

- $z_{1-\alpha}$ = the p th quantile of the standard normal distribution (from the last row of Table G-1, Appendix G), where α is the probability of making a Type I set in DQO Step 6 (Section 4.6.4).
- $z_{1-\beta}$ = the p th quantile of the standard normal distribution (from the last row of Table G-1, Appendix G), where β is the probability of making a Type II error set in DQO Step 6 (Section 4.6.4).
- s = an estimate of the standard deviation.
- Δ = the width of the gray region from DQO Step 6.

An example application of Equation 8 is presented in Box 9.

Two assumptions underlie the use of Equation 8. First, it is assumed that data are drawn from an approximately normal distribution. Second, it is assumed the data are uncorrelated. In correlated data, two or more samples taken close to each other (in time or in space) will have similar concentrations (Gilbert 1987). In situations in which spatial or temporal correlation is expected, some form of systematic sampling is preferred.

If the underlying population appears to exhibit a lognormal distribution, normal theory sample size equations (such as Equation 8) still can be used though they will tend to *underestimate* the minimum number of samples when the geometric standard deviation ($\exp(s_y)$) is low (e.g., ≤ 2). If the underlying distribution is known to be lognormal, the method given by Land (1971, 1975) and Gilbert (1987) for calculating confidence limits for a lognormal mean can be solved “in reverse” to obtain n . (A software tool for performing the calculation, MTCASat 3.0, is published by the Washington Department of Ecology. See Appendix H). Also, techniques described by Perez and Lefante (1996 and 1997) can be used to estimate the sample sizes needed to estimate the mean of a lognormal distribution. Otherwise, consult a professional statistician for assistance.

**Box 9. Number of Samples Required to Estimate the Mean Using Simple Random Sampling:
Hypothetical Example**

Under 40 CFR 261.38, a generator of hazardous waste-derived fuel is seeking an exclusion from the definition of solid and hazardous-waste. To prepare the one-time notice under 40 CFR 261.38(c), the generator plans to conduct waste sampling and analysis to support the exclusion. The output of the first six steps of the DQO Process are summarized below:

Step 1: State the Problem: The planning team reviewed the applicable regulations, historical analyses, and process chemistry information. The problem is to determine whether Appendix VIII constituents present in the waste are at concentration levels less than those specified in Table 1 of §261.38.

Step 2: Identify the Decision: If the waste attains the specification levels, then it will be judged eligible for the exclusion from the definition of hazardous and solid waste.

Step 3: Identify Inputs to the Decision: Sample analysis results are required for a large number of constituents present in the waste, however, most constituents are believed to be present at concentrations well below the specification levels. Historically, benzene concentrations have been most variable, therefore, the planning team will estimate the number of samples required to determine if the specification level for benzene is attained.

Step 4: Define the Boundaries: The DQO decision unit is defined as the batch of waste generated over a one-week period. Samples will be taken as the waste exits the preparation process and prior to storage in a fuel tank (i.e., at the point of generation).

Step 5: Develop a Decision Rule: The RCRA regulations at 40 CFR 261.38(c)(8)(iii)(A) specify the mean as the parameter of interest. The "Action Level" for benzene is specified in Table 1 of §268.38 as 4,100 ppm. If the mean concentration of benzene within the DQO decision unit is less than or equal to 4,100 ppm, then the waste will be considered eligible for the exclusion (for benzene). Otherwise, the waste will not be eligible for the exclusion for benzene. (Note that the demonstration must be made for all Appendix VIII constituents known to be present in the waste).

Step 6: Specify Limits on Decision Errors: In the interest of being protective of the environment, the null hypothesis was established as "the mean concentration of benzene within the decision unit boundary exceeds 4,100 ppm," or $H_0: \text{mean (benzene)} > 4,100 \text{ ppm}$. The boundaries of the gray region were set at the Action Level (4,100 ppm) and at a value less than the Action Level at 3000 ppm. The regulations at §261.38(c)(8)(iii)(A) specify a Type I (false rejection) error rate (α) of 0.05. The regulations do not specify a Type II (false acceptance) error rate (β), but the planning team deemed a false acceptance as of lesser concern than a false rejection, and set the false acceptance rate at 0.25. Sample analysis results from previous sampling and analyses indicate the standard deviation (s) of benzene concentrations is about 1,200 ppm.

What is the appropriate number of samples to collect and analyze for a simple random sampling design?

Solution: Using Equation 8 and the outputs of the first six steps of the DQO Process, the number of samples is determined as:

$$n = \frac{(z_{1-\alpha} + z_{1-\beta})^2 s^2}{\Delta^2} + \frac{z_{1-\alpha}^2}{2}$$

$$= \frac{(1.645 + 0.674)^2 (1200)^2}{(4100 - 3000)^2} + \frac{(1.645)^2}{2} = 7.75 \approx 8 \text{ (round up)}$$

where the values for $z_{1-\alpha}$ and $z_{1-\beta}$ are obtained from the last row of Table G-1 in Appendix G.

5.4.2 Number of Samples to Estimate the Mean: Stratified Random Sampling

An important aspect of a stratified random sampling plan is deciding how many samples to collect within each of the strata (Gilbert 1987). There are many ways to design a stratified random sampling plan; the development here makes the following assumptions (refer to Section 5.2.2 for a description of terms and symbols used below):

- Weights for each stratum (W_h) are known in advance. One possible way to assign weights to each stratum is to calculate the ratio between the waste volume classified as the h th stratum and the total waste volume.
- The number of *possible* sample units (i.e., physical samples) of a certain physical size is much larger than the number of sample units that will be collected and analyzed. As a general guide, this assumption should be reasonable as long as the ratio between the stratum waste volume and the volume of the individual samples is at least 100. Otherwise, you may need to consider formulas that include the finite population correction (see Cochran 1977, page 24).
- The number of sample units to be collected and analyzed in each stratum, due to analytical costs and other considerations, generally will be fairly small.
- A preliminary estimate of variability (s_h^2) is available for each stratum. If this is not the case, one can use an estimate of the overall variability (s^2) as a substitute for the separate stratum estimates. By ignoring possible differences in the variance characteristics of separate strata, the sample size formulas given below may tend to underestimate the necessary number of samples for each strata (n_h).

Given a set of stratum weights and sample measurements in each stratum, the *overall* mean (\bar{x}_{st}) and *overall* standard error of the mean ($s_{\bar{x}_{st}}$) (i.e., for the entire waste under study) are computed as follows for a stratified random sample:

$$\bar{x}_{st} = \sum_{h=1}^L W_h \bar{x}_h \quad \text{Equation 9}$$

and

$$s_{\bar{x}_{st}} = \sqrt{\sum_{h=1}^L W_h^2 \frac{s_h^2}{n_h}} \quad \text{Equation 10}$$

Note that \bar{x}_h and s_h^2 in these formulas represent the arithmetic mean and sample variance for the measurements taken within each stratum.

In general, there are two approaches for determining the number of samples to take when stratified random sampling is used: *optimal allocation* and *proportional allocation*.

5.4.2.1 Optimal Allocation

In optimal allocation, the number of samples assigned to a stratum (n_h) is proportional to the relative variability within each stratum and the relative cost of obtaining samples from each stratum. The number of samples can be determined to minimize the variance for a fixed cost or to minimize the cost for a prespecified variance.

Optimal allocation requires considerable advance knowledge about the relative variability within each stratum and the costs associated with obtaining samples from each stratum; therefore, we recommend the use of proportional allocation (see below) as an alternative. For more complex situations in which optimal allocation is preferred, consult a statistician or see Cochran (1977, page 96), Gilbert (1987, page 50), or USEPA (1989a (page 6-13)).

5.4.2.2 Proportional Allocation

In proportional allocation, the number of samples assigned to a stratum (n_h) is proportional to the stratum size, that is, $n_h = nW_h$. To determine the total number of samples (n) so that a true difference (Δ) between the mean waste concentration and the Action Level can be detected with Type I error rate α and Type II error rate β , use the following equation:

$$n = \frac{[t_{1-\alpha,df} + t_{1-\beta,df}]^2}{\Delta^2} \sum_{h=1}^L W_h S_h^2 \quad \text{Equation 11}$$

To use this formula correctly, the degrees of freedom (df) connected with each t -quantile (from Table G-1, Appendix G) in the above equation must be computed as follows:

$$df = \left(\sum_{h=1}^L W_h S_h^2 \right)^2 / \sum_{h=1}^L \frac{W_h^2 S_h^4}{nW_h - 1} \quad \text{Equation 12}$$

Because the degrees of freedom also depend on n , the final number of samples must be computed iteratively. Then, once the final total number of samples is computed, the number of samples for each stratum is determined by multiplying the total number of samples by the stratum weight. An example of this approach is presented in Box 10.

If only an *overall* estimate of s^2 is available in the preliminary data, Equation 11 reduces to:

$$n = \frac{[t_{1-\alpha,df} + t_{1-\beta,df}]^2 s^2}{\Delta^2} \quad \text{Equation 13}$$

and Equation 12 reduces to

$$df = 1 / \sum_{h=1}^L \frac{W_h^2}{nW_h - 1} \quad \text{Equation 14}$$

Box 10. Number of Samples Required to Estimate the Mean Using Stratified Random Sampling – Proportional Allocation: Hypothetical Example

Under the RCRA Corrective Action program, a facility owner has conducted a cleanup of a solid waste management unit (SWMU) in which the contaminant of concern is benzene. The cleanup involved removal of all waste residues, contaminated subsoils, and structures. The facility owner needs to conduct sampling and analysis to confirm that the remaining soils comply with the cleanup standard.

Step 1: State the Problem: The planning team needs to confirm that soils remaining in place contain benzene at concentrations below the risk-based levels established by the authorized state as part of the cleanup.

Step 2: Identify the Decision: If the soils attain the cleanup standard, then the land will be used for industrial purposes. Otherwise, additional soil removal will be required.

Step 3: Identify Inputs to the Decision: A sampling program will be conducted, and sample analysis results for benzene will be used to make the cleanup attainment determination.

Step 4: Define the Boundaries: The DQO decision unit is the top 6 inches of soil within the boundary of the SWMU. Based on prior sample analysis results and field observations, two strata are identified: fine-grained soils in 20 percent of the unit (“Stratum 1”), and coarse-grained soils comprising the other 80 percent of the unit (“Stratum 2”). Based on the relative mass of the two strata, a weighting factor W_h is assigned to each h th stratum such that $W_1 = 0.2$ and $W_2 = 0.8$.

Step 5: Develop a Decision Rule: The parameter of interest is established as the mean, and the Action Level for benzene is set at 1.5 mg/kg. If the mean concentration of benzene within the DQO decision unit is less than or equal to 1.5 mg/kg, then the unit will be considered “clean.” Otherwise, another layer of soil will be removed.

Step 6: Specify Limits on Decision Errors: In the interest of being protective of the environment, the null hypothesis is established as “the mean concentration of benzene within the decision unit boundary exceeds 1.5 mg/kg,” or H_0 : mean (benzene) > 1.5 mg/kg. The boundaries of the gray region are set at the Action Level (1.5 mg/kg) and at a value less than the Action Level at 1.0 mg/kg. The Type I error rate (α) is set at 0.10 and the Type II error rate (β) is set at 0.25. Sample analysis results from $n = 8$ initial non-composite samples provided an estimate of the overall standard deviation of $s = 1.83$, and the standard deviations (s_h) within each h th stratum of $s_1 = 2.5$ and $s_2 = 1.3$ (and $s_1^2 = 6.25$ and $s_2^2 = 1.69$).

What is the appropriate number of samples to collect and analyze for a stratified random sampling design?

Solution: Using Equation 12 for the degrees of freedom under proportional allocation:

$$df_1 = ((0.2 \times 6.25) + (0.8 \times 1.69))^2 / \left[\frac{(0.2 \times 6.25)^2}{8(0.2) - 1} + \frac{(0.8 \times 1.69)^2}{8(0.8) - 1} \right] = 2.3 \approx 2$$

Then, looking up the t -quantiles (from Table G-1, Appendix G) with 2 degree of freedom and taking $\Delta = 0.5$ (i.e., 1.5 ppm - 1.0 ppm), the total sample size (using Equation 12) works out to

$$n_1 = \frac{[1.886 + 0.816]^2}{(0.5)^2} ((0.2 \times 6.25) + (0.8 \times 1.69)) = 76$$

Since the equations must be solved iteratively, recompute the formulas using $n = 76$. The same calculations give $df_2 = 48$ and $n_2 = 41$. After two more iterations, the sample size stabilizes at $n = 42$. Using the proportional allocation with $n = 42$ one should take $42(0.2) = 8.4$ (round up to 9) measurements from the first stratum and $42(0.8) = 33.6$ (round up to 34) measurements from the second stratum. Since four samples already were collected from each stratum, at least five additional random samples should be obtained from the first stratum and at least thirty additional random samples should be collected from the second stratum.

In the example in Box 10, stratified random sampling provides a more efficient and cost-effective design compared to simple random sampling of the same unit. If simple random sampling were used, a total of 52 samples would be required. With stratified random sampling, only 42 samples are required, thereby reducing sampling and analytical costs.

5.4.3 Number of Samples to Estimate the Mean: Systematic Sampling

Despite the attractiveness and ease of implementation of systematic sampling plans, whether via a fixed square, rectangular, or triangular grid, or through the use of systematic random sampling, methods for estimating the standard error of the mean are beyond the scope of this guidance (for example, see Cochran 1977) and often involve more advanced geostatistical techniques (for example, see Myers 1997). An alternate approach is to treat the set of systematic samples as though they were obtained using simple random sampling. Such an approach should provide reasonable results as long as there are no strong cyclical patterns, periodicities, or significant spatial correlations between adjacent sample locations. If such features are present or suspected to be present, consultation with a professional statistician is recommended.

By regarding the systematic sample as a simple random sample, one can simply use the algorithm and formulas for simple random sampling described in Section 5.4.1 (Equation 8) to estimate the necessary sample size. As with all the sampling designs described in this section, you should have a preliminary estimate of the sample variance before using the sample size equation.

5.4.4 Number of Samples to Estimate the Mean: Composite Sampling

In comparison to noncomposite sampling, composite sampling may have the effect of minimizing between-sample variation, thereby reducing somewhat the total number of composite samples that must be submitted for analysis.

The appropriate number of composite samples to be collected from a waste or media can be estimated by Equation 8 for simple random and systematic composite sampling. Equation 11 can be used when composite sampling will be implemented with a stratified random sampling design (using proportional allocation). Any preliminary or pilot study conducted to estimate the appropriate number of composite samples should be generated using the same compositing scheme planned for the confirmatory study. If the preliminary or pilot study data were generated using random “grab” samples rather than composites, then the sample variance (s^2) in the sample size equations should be replaced with s^2/g where g is the number of individual or grab samples used to form each composite (Edland and Van Belle 1994, page 45).

Additional guidance on the optimal number of samples required for composite sampling and the number of subsample aliquots required to achieve maximum precision for a fixed cost can be found in Edland and van Belle (1994, page 36 and page 44), Exner, et al. (1985, page 512), and Gilbert (1987, page 78).

5.5 Determining the Appropriate Number of Samples to Estimate A Percentile or Proportion

This section provides guidance for determining the appropriate number of samples (n) needed to estimate an upper percentile or proportion with a prespecified level of confidence. The approaches can be used when the objective is to determine whether the upper percentile is less than a concentration standard or whether a given proportion of the population or decision unit is less than a specified value.

Two methods for determining the appropriate number of samples are given below: (1) Section 5.5.1 provides a method based on the assumption that the population is large and the samples are drawn at random from the population, and (2) Section 5.5.2 provides a method with similar assumptions but only requires specification of the level of confidence required and the number of exceedances allowed (usually zero). For both methods, it is assumed that the measurements can be expressed as a binary variable – that is, that the sample analysis results can be interpreted as either in compliance with the applicable standard (“pass”) or not in compliance with the applicable standard (“fail”).

5.5.1 Number of Samples To Test a Proportion: Simple Random or Systematic Sampling

This section provides a method for determining the appropriate number of samples when the objective is to test whether a proportion or percentile of a population complies with an applicable standard. A population proportion is the ratio of the number of elements of a population that has some specific characteristic to the total number of elements. A population percentile represents the percentage of elements of a population having values less than some value. The number of samples needed to test a proportion can be calculated using

$$n = \left[\frac{z_{1-\beta} \sqrt{GR(1-GR)} + z_{1-\alpha} \sqrt{AL(1-AL)}}{\Delta} \right]^2 \quad \text{Equation 15}$$

where

α	=	false rejection error rate
β	=	false acceptance error rate
z_p	=	the p th percentile of the standard normal distribution (from the last row of Table G-1 in Appendix G)
AL	=	the Action Level (e.g., the proportion of all possible samples of a given support that must comply with the standard)
GR	=	other bound of the gray region,
Δ	=	width of the gray region ($GR - AL$), and
n	=	the number of samples.

An example calculation of n using the approach described here is presented in Box 11.

Box 11. Example Calculation of the Appropriate Number of Samples Needed To Test a Proportion – Simple Random or Systematic Sampling

A facility is conducting a cleanup of soil contaminated with pentachlorophenol (PCP). Based on the results of a field test method, soil exceeding the risk-based cleanup level of 10 mg/kg total PCP will be excavated, classified as a solid or hazardous waste, and placed into roll-off boxes for subsequent disposal, or treatment (if needed) and disposal. The outputs of the first six steps of the DQO Process are summarized below.

Step 1: State the Problem: The project team needs to decide whether the soil being placed in each roll-off box is a RCRA hazardous or nonhazardous waste.

Step 2: Identify the Decision: If the excavated soil is hazardous, it will be treated to comply with the applicable LDR treatment standard and disposed as hazardous waste. If it is nonhazardous, then it will be disposed as solid waste in a permitted industrial waste landfill (as long as it is not mixed with a listed hazardous waste).

Step 3: Identify Inputs to the Decision: The team requires sample analysis results for TCLP PCP to determine compliance with the RCRA TC regulatory threshold of 100 mg/L.

Step 4: Define the Boundaries: The DQO “decision unit” for each hazardous waste determination is defined as a roll-off box of contaminated soil. The “support” of each sample is in part defined by SW-846 Method 1311 (TCLP) as a minimum mass of 100-grams with a maximum particle size of 9.5 mm. Samples will be obtained as the soil is excavated and placed in the roll-off box (i.e., at the point of generation).

Step 5: Develop a Decision Rule: The project team wants to ensure with reasonable confidence that little or no portions of the soil in the roll-off box are hazardous waste. The parameter of interest is then defined as the 90th percentile. If the 90th percentile concentration of PCP is less than 100 mg/L TCLP, then the waste will be classified as nonhazardous. Otherwise, it will be considered hazardous.

Step 6: Specify Limits on Decision Errors: The team establishes the null hypothesis (H_0) as the “true proportion (P) of the waste that complies with the standard is less than 0.90,” or $H_0: P < 0.90$. The false rejection error rate (α) is set at 0.10. The false acceptance error rate (β) is set at 0.30. The Action Level (AL) is 0.90, and the other boundary of the gray region (GR) is set at 0.99.

How many samples are required?

Solution: Using Equation 15 and the outputs of the first six steps of the DQO Process, the number of samples (n) is determined as:

$$= \left[\frac{0.524\sqrt{0.99(1-0.99)} + 1.282\sqrt{0.90(1-0.90)}}{0.99 - 0.90} \right]^2 = 23.5 \approx 24$$

where the values for $Z_{1-\alpha}$ and $Z_{1-\beta}$ are obtained from the last row of Table G-1 in Appendix G.

5.5.2 Number of Samples When Using a Simple Exceedance Rule

If a simple exceedance rule is used (see Section 3.4.2.2), then it is possible to estimate the number of samples required to achieve a prespecified level of confidence that a given fraction of the waste or site has a constituent concentration less than the standard or does not exhibit a characteristic or property of concern. The approach is based on the minimum sample size required to determine a nonparametric (distribution-free) one-sided confidence bound on a percentile (Hahn and Meeker 1991 and USEPA 1989a).

If the exceedance rule specifies no exceedance of the standard in any sample, then the number of samples that must achieve the standard can be obtained from Table G-3a in Appendix G. The table is based on the expression:

$$n = \log(\alpha)/\log(p) \quad \text{Equation 16}$$

where alpha (α) is the probability of a Type I error and p is the proportion of the waste or site that must comply with the standard. Alternatively, the equation can be rearranged so that statistical performance ($1 - \alpha$) can be determined for a fixed number of samples:

$$(1 - \alpha) = 1 - p^n \quad \text{Equation 17}$$

Notice that the method does not require specification of the other bound of the gray region, nor does it require specification of a Type II (false acceptance) error rate (β).

If the decision rule allows *one* exceedance of the standard in a set of samples, then the number of samples required can be obtained from Table G-3b in Appendix G.

An example application of the above equations is presented in Box 12. See also Appendix F, Section F.3.2.

Box 12. Example Calculation of Number of Samples Needed When a Simple Exceedance Rule Is Used – Simple Random or Systematic Sampling

What is the minimum number of samples required (with no exceedance of the standard in any of the samples) to determine with at least 90-percent confidence ($1 - \alpha = 0.90$) that at least 90 percent of all possible samples from the waste (as defined by the DQO decision unit) are less than the applicable standard?

From Table G-3a, we find that for $1 - \alpha = 0.90$ and $p = 0.90$ that 22 samples are required. Alternately, using Equation 16, we find

$$n = \frac{\log(\alpha)}{\log(p)} = \frac{\log(0.10)}{\log(0.90)} = \frac{-1}{-0.0457} = 21.8 \approx 22$$

If only 11 samples were analyzed (with no exceedance of the standard in any of the samples), what level of confidence can we have that at least 90 percent of all possible samples are less than the standard? Using Equation 17, we find

$$(1 - \alpha) = 1 - p^n = 1 - 0.90^{11} = 1 - 0.3138 = 0.6862$$

Rounding down, we can say with at least 68 percent confidence that at least 90 percent of all possible samples would be less than the applicable standard.

5.6 Selecting the Most Resource-Effective Design

If more than one sampling design option is under consideration, evaluate the various designs based on their cost and the ability to achieve the data quality and regulatory objectives. Choose the design that provides the best balance between the expected cost and the ability to meet the

For additional guidance on selecting the most resource-efficient design, see ASTM standard D 6311-98, *Standard Guide for Generation of Environmental Data Related to Waste Management Activities: Selection and Optimization of Sampling Design*.

objectives. To improve the balance between meeting your cost objectives and achieving the DQOs, it might be necessary to modify either the budget or the DQOs. As can be seen from the sample size equations in Section 5.4 and 5.5, there is an interrelationship between the appropriate number of samples and the desired level of confidence, expected variability (both population and measurement variability), and the width of the gray region. To reduce costs (i.e., decrease the number of samples required), several options are available:

- Decrease the confidence level for the test
- Increase the width of the “gray region” (not recommended if the parameter of interest is near the Action Level)
- Divide the population into smaller less heterogeneous decision units, or use a stratified sampling design in which the population is broken down into parts that are internally less heterogeneous
- Employ composite sampling (if non-volatile constituents are of interest and if allowed by the regulations).

Note that seemingly minor modifications to the sampling design using one or more of the above strategies may result in major increases or decreases in the number of samples needed.

When estimating costs, be sure to include the costs for labor, travel and lodging (if necessary), expendable items (such as personal protective gear, sample containers, preservatives, etc.), preparation of a health and safety plan, sample and equipment shipping, sample analysis, assessment, and reporting. Some sampling plans (such as composite sampling) may require fewer analyses and associated analytical costs, but might require more time to implement and not achieve the project objectives. EPA’s *Data Quality Objectives Decision Error Feasibility Trials Software (DEFT)* (USEPA 2001a) is one tool available that makes the process of selecting the most resource effective design easier.

5.7 Preparing a QAPP or WAP

In this activity, the outputs of the DQO Process and the sampling design are combined in a planning document such as a QAPP or WAP. The Agency has developed detailed guidance on how to prepare a QAPP (see USEPA 1998a) or WAP (see USEPA 1994a). The minimum requirements for a WAP are specified at 40 CFR §264.13. The following discussion is focused on the elements of a QAPP; however, the information can be used to help develop a WAP.

The QAPP is a critical planning document for any environmental data collection operation because it documents project activities including how QA and QC activities will be implemented during the life cycle of a project. The QAPP is the “blueprint” for identifying how the quality system of the organization performing the work is reflected in a particular project and in associated technical goals. QA is a system of management activities designed to ensure that data produced by the operation will be of the type and quality needed and expected by the data user. QA, acknowledged to be a management function emphasizing systems and policies, aids the collection of data of needed and expected quality appropriate to support management decisions in a resource-efficient manner.

Additional EPA Guidance on Preparing a QAPP or WAP

- Chapter One, SW-846
- *EPA Requirements for Quality Assurance Project Plans, EPA QA/R-5* (replaces QAMS-005/80) (USEPA 2001b)
- *EPA Guidance for Quality Assurance Project Plans, EPA QA/G-5* (EPA/600/R-98/018) (USEPA 1998a)
- *Guidance for Choosing a Sampling Design for Environmental Data Collection, EPA QA/G-5S - Peer Review Draft* (EPA QA/G-5S) (USEPA 2000c)
- *Waste Analysis at Facilities That Generate, Treat, Store, And Dispose Of Hazardous Wastes, a Guidance Manual* (USEPA 1994a)

The activities addressed in the QAPP cover the entire project life cycle, integrating elements of the planning, implementation, and assessment phases. If the DQOs are documented (e.g., in a memo or report format), include the DQO document as an attachment to the QAPP to help document the technical basis for the project and to document any agreements made between stakeholders.

As recommended in EPA QA/G-5 (USEPA 1998a), a QAPP is composed of four sections of project-related information called “groups,” which are subdivided into specific detailed “elements.” The elements and groups are summarized in the following subsections.

5.7.1 Project Management

The QAPP (or WAP) is prepared after completion of the DQO Process. Much of the following guidance related to project management can be excerpted from the outputs of the DQO Process.

The following group of QAPP elements covers the general areas of project management, project history and objectives, and roles and responsibilities of the participants. The following elements ensure that the project's goals are clearly stated, that all participants understand the goals and the approach to be used, and that project planning is documented:

- Title and approval sheet
- Table of contents and document control format
- Distribution list
- Project/task organization and schedule (from DQO Step 1)
- Problem definition/background (from DQO Step 1)
- Project/task description (from DQO Step 1)
- Quality objectives and criteria for measurement data (DQO Step 3)

- Special training requirements/certification
- Documentation and records.

For some projects, it will be necessary to include the names and qualifications of the person(s) who will obtain the samples (e.g., as required under 40 CFR §261.38(c)(7) in connection with testing for the comparable fuels exclusion).

5.7.2 Measurement/Data Acquisition

This group of QAPP elements covers all aspects of measurement system design and implementation, ensuring that appropriate methods for sampling, analysis, data handling, and QC are employed and thoroughly documented. Apart from the sample design step (DQO Step 7), the following information should be included in the QAPP or incorporated by reference:

- Sampling process design/experimental design (DQO Steps 5 and 7)
- Sampling methods and SOPs
- Sample handling and chain-of-custody requirements
- Analytical methods and SOPs (DQO Step 3)
- QC requirements;
- Instrument/equipment testing, inspection, and maintenance requirements
- Instrument calibration and frequency
- Inspection/acceptance requirements for supplies and consumables
- Data acquisition requirements (non-direct measurements)
- Data management.

For some projects, under various circumstances it may be appropriate to include hard copies of the SOPs in the QAPP, rather than incorporate the information by reference. For example, under the performance-based measurement system (PBMS) approach, alternative sampling and analytical methods can be used. Such methods can be reviewed and used more readily if actual copies of the SOPs are included in the QAPP. Hard copies of SOPs also are critically important when field analytical techniques are used. Field personnel must have detailed instructions available to ensure that the methods are followed. If it is discovered that deviation from an SOP is required due to site-specific circumstances, the deviations can be documented more easily if hard copies of the SOPs are available in the field with QAPP.

5.7.3 Assessment/Oversight

The purpose of assessment is to ensure that the QAPP is implemented as prescribed. The elements below address the activities for assessing the effectiveness of the implementation of the project and the associated QA/QC activities:

- Assessments and response actions
- Reports to management.

5.7.4 Data Validation and Usability

Implementation of these elements ensures that the data conform to the specified criteria, thus enabling reconciliation with the project's objectives. The following elements cover QA activities that occur after the data collection phase of the project has been completed:

- Data review, verification, and validation requirements
- Verification and validation methods
- Reconciliation with DQOs.

5.7.5 Data Assessment

Historically, the focus of most QAPPs has been on analytical methods, sampling, data handling, and quality control. Little attention has been paid to data assessment and interpretation. We recommend that the QAPP address the data assessment steps that will be followed after data verification and validation. While it may not be possible to specify the statistical test to be used in advance of data generation, the statistical objective (identified in the DQO Process) should be stated along with general procedures that will be used to test distributional assumptions and select statistical tests. EPA's *Guidance for Data Quality Assessment* (USEPA 2000d) suggests the following five-step methodology (see also Section 8 for a similar methodology):

1. Review the DQOs
2. Conduct a preliminary data review
3. Select the statistical test
4. Verify the assumptions of the test
5. Draw conclusions from the Data.

The degree to which each QAPP element should be addressed will be dependent on the specific project and can range from "not applicable" to extensive documentation. The final decision on the specific need for these elements for project-specific QAPPs will be made by the regulatory agency. Documents prepared prior to the QAPP (e.g., SOPs, test plans, and sampling plans) can be appended or, in some cases, incorporated by reference.

6 CONTROLLING VARIABILITY AND BIAS IN SAMPLING

The DQO Process allows you to identify the problem to be solved, set specific goals and objectives, establish probability levels for making incorrect decisions, and develop a resource-efficient data collection and analysis plan. While most of the sampling designs suggested in this guidance incorporate some form of randomness so that unbiased estimates can be obtained from the data, there are other equally important considerations (Myers 1997). Sampling and analysis activities must also include use of correct devices and procedures to minimize or control random variability and biases (collectively known as “error”) that can be introduced in field sampling, sample transport, subsampling, sample preparation, and analysis. Sampling error can lead to incorrect conclusions irrespective of the quality of the analytical measurements and the appropriateness of the statistical methods used to evaluate the data.

This section is organized into three subsections which respond to these questions:

1. What are the sources of error in sampling (Section 6.1)?
2. What is sampling theory (Section 6.2)?
3. How can you reduce or otherwise control sampling error in the field and laboratory (Section 6.3)?

6.1 Sources of Random Variability and Bias in Sampling

In conducting sampling, we are interested in obtaining an estimate of a population parameter (such as the mean, median, or a percentile); but an estimate of a parameter made from measurements of samples always will include some random variability (or variances) and bias (or a systematic shift away from the true value) due primarily to (1) the inherent variability of the waste or media (the “between-sampling-unit variability”) and (2) imprecision in the methods used to collect and analyze the samples (the “within-sampling-unit variability”) (USEPA 2001e).

Errors caused by the sample collection process can be much greater than the preparation, analytical, and data handling errors (van Ee, et al. 1990, Crockett, et al 1996) and can dominate the overall uncertainty associated with a characterization study (Jenkins, et al. 1996 and 1997). In fact, analytical errors are usually well-characterized, well-understood, and well-controlled by laboratory QA/QC, whereas sampling and sample handling errors are not usually well-characterized, well-understood, or well-controlled (Shefsky 1997). Because sampling error contributes to overall error, it is important for field and laboratory personnel to understand the sources of sampling errors and to take measures to control them in field sampling.

The two components of error -- random variability and bias -- are independent. This concept is demonstrated in the “target” diagram (see Figure 7 in Section 2), in which random variability (expressed as the variance, σ^2) refers to the “degree of clustering” and bias ($\mu - \bar{x}$) relates to the “amount of offset from the center of the target” (Myers 1997).

Random variability and bias occur at each stage of sampling. Variability occurs due to the **heterogeneity** of the material sampled and random variations in the sampling and sample handling procedures. In addition, bias can be introduced at each stage by the sampling device (or the manner in which it is used), sample handling and transport, subsampling, and analysis.

While it is common practice to calculate the variability of sample analysis results “after the fact,” it is more difficult to identify the sources and potential impacts of systematic sampling bias. As discussed in more detail below, it usually is best to understand the potential sources of error “up front” and take measures to minimize them when planning and implementing the sampling and analysis program.

Even though random variability and bias are independent, they are related quantitatively (see Figure 23). Errors expressed as the variance can be added together to estimate overall or “total study error.” Biases can be added together to estimate overall bias (though sampling bias is difficult to measure in practice). Conceptually, the sum of all the variances can be added to the sum of all biases (which is then squared) and expressed as the **mean square error** ($MSE(\bar{x})$) which provides a quantitative way of measuring the degree of *representativeness* of the samples. In practice, it is not necessary to try to calculate mean square error, however, we suggest you understand the sources and impacts of variability and bias so you can take steps to control them in sampling and improve the representativeness of the samples. (See Sections 5.2.4 and 5.2.5 of EPA’s *Guidance for Data Quality Assessment, EPA QA/G-9 - QA00 Update* (USEPA 2000d) for a more detailed discussion of how to address measurement variability and bias in the sampling design).

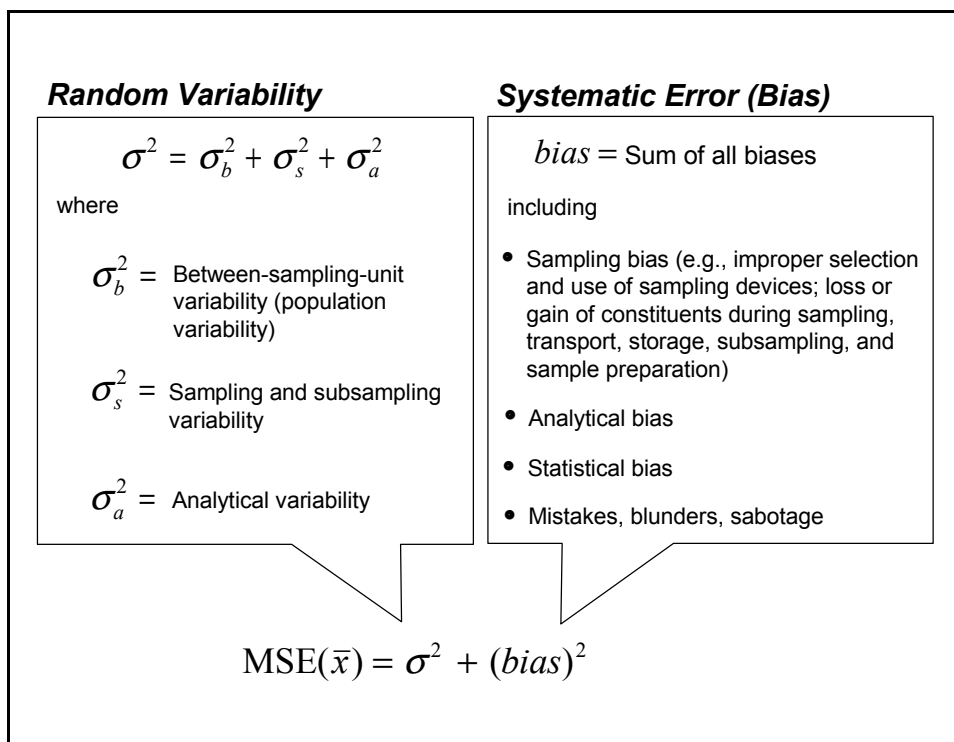

Figure 23. Components of error and the additivity of variances and biases in sampling and analysis

The relatively new science of sampling theory and practice (Myers 1997) provides a technically based approach for addressing sampling errors (see Section 6.2). Sampling theory recognizes that sampling errors arise from or are related to the size and distribution of particles in the waste, the weight of the sample, the shape and orientation of the sampling device, the manner

in which the sample is collected, sample handling, and the manner in which subsampling is performed within the laboratory. Sampling theory applies to particulate solids, liquids, and mixtures of solids and liquids. Understanding sampling theory does not allow us to completely eliminate sampling and analytical errors, but sampling theory does allow us to identify the sources and magnitudes of sampling errors so we can take steps to minimize those that are the largest. In doing so, samples will be more precise and unbiased (i.e., more “representative”), thus reducing the number of samples required (lowering costs) and improving our ability to achieve the decision error rate specified in the DQOs.

6.2 Overview of Sampling Theory

A number of environmental scientists have recognized a set of sampling theories developed by Dr. Pierre Gy (Gy 1982 and 1998) and others (Ingamells and Switzer 1973; Ingamells 1974; Ingamells and Pitard 1986; Pitard 1989; and Visman 1969) as one set of tools for improving sampling. These researchers have studied the sources of sampling error (particularly in the sampling of particulate matter) and developed techniques for quantifying the amount of error that can be introduced by the physical sampling process. The theories were originally developed in support of mineral exploration and mining and more recently were adopted by EPA for soil sampling (van Ee, et al. 1990; Mason 1992). Under some conditions, however, the theories can be applied to waste sampling as a means for improving the efficiency of the sampling and analysis process (Ramsey, et al. 1989).

As discussed in the context of this guidance, Gy’s theories focus on minimizing error during the physical collection of a sample of solid and liquid media and should not be confused with the statistical sampling designs such as simple random, stratified random, etc. discussed in Section 5. Both sampling theory and sampling design, however, are critical elements in sampling: Gy’s theories facilitate collection of “correct” individual samples, while statistical sampling designs allow us to conduct statistical analyses and make conclusions about the larger mass of waste or environmental media (i.e., the decision unit).

The following three subsections describe key aspects of sampling theory including heterogeneity, sampling errors, and the concept of sample support. The descriptions are mostly qualitative and intended to provide the reader with an appreciation for the types and complexities of sampling error. Detailed descriptions of the development and application of sampling theory can be found in *Sampling for Analytical Purposes* (Gy 1998), *Geostatistical Error Management* (Myers 1997), *Pierre Gy’s Sampling Theory and Sampling Practice* (Pitard 1993), and in EPA’s guidance document *Preparation of Soil Sampling Protocols: Sampling Techniques and Strategies* (Mason 1992).

6.2.1 Heterogeneity

One of the underlying principles of sampling theory is that the medium to be sampled is not uniform in its composition or in the distribution of constituents in the medium, rather, it is **heterogeneous**. Heterogeneity causes the sampling errors.

Appropriate treatment of heterogeneity in sampling depends on the scale of observation. Large-scale variations in a waste stream or site affect where and when we take samples. Small-scale variations in a waste or media affect the size, shape, and orientation of individual field samples and laboratory subsamples. Gy’s theory identifies three major types of heterogeneity: (1) short-

range (or small-scale) heterogeneity, (2) long-range (or large-scale) heterogeneity, and (3) periodic heterogeneity:

Short-range heterogeneity refers to properties of the waste at the sample level or in the immediate vicinity of a sample location. Two other types of heterogeneity are found within short-range heterogeneity: one reflected by differences in the *composition* between individual particles, the other having to do with the *distribution* of those particles in the waste. Composition heterogeneity (also known as *constitution heterogeneity*) is constant and cannot be altered except by particle size reduction (e.g., grinding or crushing the material). The distribution heterogeneity plays an important role in sampling because particles can separate into groups. Distribution heterogeneity can be increased (e.g., by gravitational segregation of particles or liquids) and can be reduced by homogenization (mixing) or by taking many small increments to form a sample.

Large-scale heterogeneity reflects local trends and plays an important role in deciding whether to divide the population into smaller internally homogenous decision units or to use a stratified sampling design. See Appendix C for a detailed description of large-scale heterogeneity.

Periodic heterogeneity, another larger-scale phenomena, refers to cyclic phenomena found in flowing streams or discharges. Understanding periodic heterogeneity can aid in dividing a waste into separate waste streams or in establishing a stratified sampling design.

Forming a conceptual model of the heterogeneity of a waste will help you to determine how to address it in sampling.

6.2.2 Types of Sampling Error

Gy's theory (see also Mason 1992, Pitard 1993, and Gy 1998) identifies a number of different types of error that can occur in sampling as a result of heterogeneity in the waste and failure to correctly define the appropriate shape and volume of material for inclusion in the sample. Understanding the types and sources of the errors is an important step toward *avoiding* them. In qualitative terms, these errors include the following:

- *Fundamental error*, which is caused by differences in the composition of individual particles in the waste
- Errors due to *segregation* and *grouping* of particles and the constituent associated with the particles
- Errors due to various types of trends including small-scale trends, large-scale trends, or cycles
- Errors due to defining (or *delimiting*) the sample space and *extracting* the sample from the defined area
- Errors due to *preparation* of the sample, including shipping and handling. [Note that the term "preparation," as used here, describes all the activities that take

place after the primary sample is obtained in the field and includes sample containerization, preservation, handling, mixing, grinding, subsampling, and other preparative steps taken prior to analysis (such as the “sample preparation methods” as described in Chapters Three, Four, and Five of SW-846).]

Errors that can occur during sampling are described below.

6.2.2.1 **Fundamental Error**

The composition of a sample never perfectly matches the overall composition of the larger mass from which it was obtained because the mass of an individual sample is always less than the mass of the population and the population is never completely homogeneous. These conditions result in a sampling error known as **fundamental error**. The error is referred to as “fundamental” because it is an incompressible minimum sampling error that depends on the composition, shape, fragment size distribution, and chemical properties of the material, and it is not affected by homogenization or mixing. It arises when the constituent of interest is concentrated in constituent “nuggets” in a less concentrated matrix, especially when the constituent is present at a trace concentration level (e.g., less than 1 percent). This type of sampling error occurs even when the nuggets are mixed as well as possible in the matrix (so long as they are not dissolved). The fundamental error is the only error that remains when the sampling operation is “perfect”; that is, when all parts of the sample are obtained in a probabilistic manner and each part is independent.

As a conceptual example of fundamental error, consider a container filled with many white marbles and a few black marbles that have been mixed together well (Figure 24). If a small sample comprising only a few marbles is picked at random, there is a high probability they would all be white (Sample “A” in Figure 24) and a small chance that one or more would be black. As the sample size becomes larger, the distribution in the sample will reflect more and more closely the parent population (Sample “B” in Figure 24). The situation is similar in a waste that contains rare highly concentrated “nuggets” of a constituent of concern. If a small sample is taken, it is possible, and even likely, that no nuggets of the constituent would be selected as part of the sample. This would lead to a major *underestimate* of the true parameter of interest. It also is possible with a small sample that a gross *overestimate* of the parameter of interest will occur if a nugget is included in the sample because the nugget would comprise a relatively large proportion of the analytical sample compared to the true population. To minimize fundamental error, the point is not to simply “fish” for a black marble (the contaminant), but to sample for all of the fragments and constituents such that the sample is a representation of the lot from which it is derived.

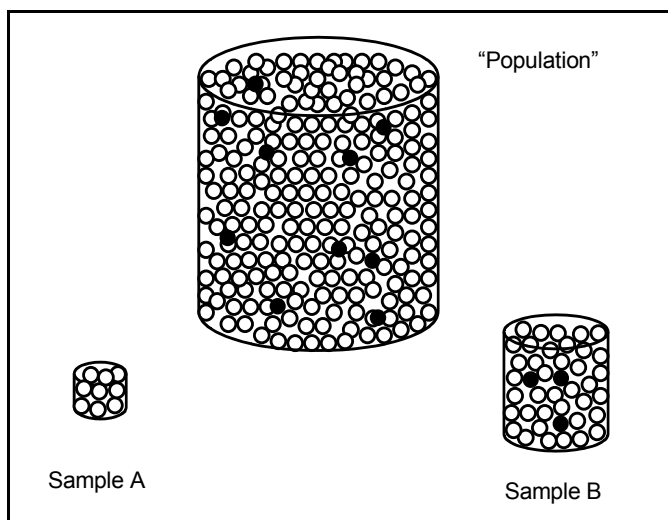

Figure 24. Effects of sample size on fundamental error. Small samples such as “A” cause the constituent of interest to be under-represented in most samples and over-represented in a small proportion of samples. Larger samples such as “B” more closely reflect the parent population.

The fundamental error is never zero (unless the population is completely homogeneous or the entire population is submitted for analysis) and it never “cancels out.” It can be controlled by taking larger physical samples; however, larger samples can be difficult to handle in the field and within the laboratory, and they may pose practical constraints due to increased space needed for storage. Furthermore, small samples (e.g., less than 1 gram) generally are required for analytical purposes. To preserve the character of a large sample in the small analytical sample, subsampling and particle size reduction strategies should be employed (see also Section 7.3).

6.2.2.2 Grouping and Segregation Error

Grouping and segregation results from the short-range heterogeneity within and around the area from which a sample is collected (i.e., the sampling location) and within the sample container. This small-scale heterogeneity is caused by the tendency for some particles to associate into groups of like particles due to gravitational separation, chemical partitioning, differing moisture content, magnetism, or electrostatic charge. Grouping and segregation of particles can lead to sampling bias.

Figure 25 depicts grouping of particles (at “A”) and segregation of particles (at “B”) within a sample location. The grouping of particles at location “A” could result from an affinity between like particles (for example, due to electrostatic forces). Analytical samples formed from just one group of particles would yield biased results.

The segregation of particles at location “B” could result from gravitation separation (e.g., during sample shipment). If the contaminant of interest was associated with only one class of particle (for example, only the black diamond shapes), then a sample collected from the top would result in a different concentration than a sample collected from the bottom, thus biasing the sample.

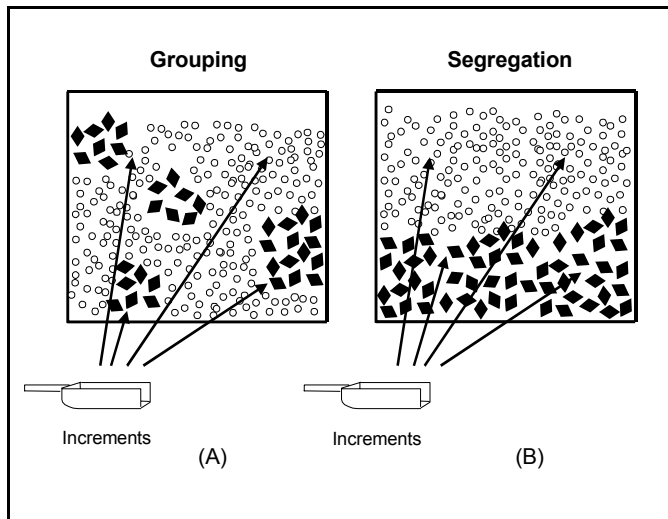

Figure 25. How grouping and segregation of particles can affect sampling results. Grouping and segregation error can be minimized by taking many small increments.

Grouping and segregation error can be minimized by properly homogenizing and splitting the sample. As an alternative, an individual sample can be formed by taking a number of increments (small portions of media) in the immediate vicinity of the sampling location and combining them into the final collected sample.¹ Pitard (1993) suggests collecting between 10 and 25 increments as a means to control grouping and segregation error. These increments are then combined to form an individual sample to be submitted to the laboratory for analysis.

¹ This approach should not be confused with composite sampling, in which individual samples from different times or locations are pooled and mixed into a single sample.

The approach of taking multiple increments to form a sample is not recommended when volatile constituents are of interest and may have practical limitations when sampling highly heterogeneous wastes or debris containing very large fragments.

6.2.2.3 *Increment Delimitation Error*

Increment delimitation error occurs when the shape of the sampling device excludes or discriminates against certain portions of the material to be sampled. For example, a sampling device that only samples the top portion of a liquid effluent as it leaves a discharge pipe (leaving a portion of the flow unsampled) causes increment delimitation error. This type of error is eliminated by choosing a sampling device capable of obtaining all of the flow for a fraction of the time (see also Sections 6.3.2 and 6.3.3).

6.2.2.4 *Increment Extraction Error*

Increment extraction error occurs when portions of the sample are lost or extraneous materials are included in the sample. For example, if the coring device is too small to accommodate a large fragment of waste, particles that should be in the sample might get pushed aside, causing sampling bias. Extraction error can be controlled through selection of devices designed to accommodate the physical characteristics of the waste.

6.2.2.5 *Preparation Error*

This error results from the incorrect preservation, handling, mixing, grinding, and subsampling that can result in loss, contamination, or altering of the sample such that it no longer is an accurate representation of the material being sampled. Proper choice and implementation of preparation methods controls this error.

6.2.3 The Concept of “Sample Support”

The weight, shape (length, width and height dimensions), and orientation of a sample describe the “sample support.” The term “support” has been used in sampling and statistical literature in various ways, such as to describe the mass or volume of an “exposure unit” or “exposure area” in the Superfund program -- similar to the “decision unit” described in the DQO Process.

Conceptually, there is a continuum of support from the decision unit level (e.g., an exposure area of a waste site or a drum of solid waste) to the sample and subsample level down to the molecular level. Because it is not possible to submit the entire decision unit for analysis, samples must be submitted instead. For heterogeneous media, *the sample support will have a substantial effect on the reported measurement values.*

Measures can be taken to ensure adequate size, shape, and orientation of a sample:

- The appropriate *size* of a sample (either volume or mass) can be determined based on the relationship that exists between the particle size distribution and expected sampling error -- known as the fundamental error (see Section 6.2.2.1). In the DQO Process, you can define the amount of fundamental error that is acceptable (specified in terms of the standard deviation of the fundamental error) and estimate the volume required for field samples. The sampling tool should

have dimensions three or more times larger than that of the diameter of the largest particles. Proper sizing of the sampling tool will help ensure that the particle size distribution of the sampled material is represented in the sample (see discussion at Section 6.3.1).

- The appropriate *shape and orientation* of the sample are determined by the sampling mode. For a one-dimensional waste (e.g., liquid flowing from a discharge pipe or solids on a conveyor belt), the correct or “ideal” sample is an undisturbed cross section delimited by two parallel planes (Pitard 1993, Gy 1998) (see discussion at Section 6.3.2.1). For three-dimensional waste forms (such as solids in a roll-off bin, piles, thick slabs, soil in drums, liquids in a tank, etc.), the sampling problem is best treated as a series of overlapping two-dimensional problems. The correct or ideal sample is an undisturbed core (Pitard 1993) that captures the entire thickness of the waste (see discussion at Section 6.3.2.2).

6.3 Practical Guidance for Reducing Sampling Error

This section describes steps that can be taken to control sampling error. While the details of sampling theory may appear complex and difficult to explain, in practice most sampling errors can be minimized by observing a few simple rules that, when used, can greatly improve the reliability of sampling results with little or no additional costs (Gy 1998):

- Determine the optimal mass of each field sample. For particulate solids, determine the appropriate sample weight based on the particle size distribution and characteristics, and consider any practical constraints (see Section 6.3.1). Also, determine additional amounts of the sampled material needed for split samples, for field and laboratory quality control purposes, or for archiving.
- Select the appropriate shape and orientation of the sample based on the sampling design model identified in DQO Step 7 (see Section 6.3.2).
- Select sampling devices and procedures that will minimize grouping and segregation errors and increment delimitation and increment extraction errors (see Sections 6.3.3 and 7.1).

Implement the sampling plan by obtaining the number of samples at the sampling locations and times specified in the sampling design selected in DQO Step 7, and take measures to minimize preparation errors during sample handling, subsampling, analysis, documentation, and reporting. When collecting samples for analysis for volatile organic constituents, special considerations are warranted to minimize bias due to loss of constituents (see Section 6.3.4).

Table 7 provides a summary of strategies that can be employed to minimize the various types of sampling error.

Table 7. Strategies for Minimizing Sampling Error

Type of Sampling Error	Strategy To Minimize or Reduce Error
Fundamental Error	<ul style="list-style-type: none"> • To reduce variability caused by fundamental error, increase the volume of the sample. • To reduce the volume of the sample and maintain low fundamental error, perform particle-size reduction followed by subsampling. • When volatile constituents are of interest, do not grind or mix the sample. Rather, take samples using a method that minimizes disturbances of the sample material (see also Section 6.3.4).
Grouping and Segregation Error	<ul style="list-style-type: none"> • To minimize grouping error, take many increments. • To minimize segregation error, homogenize the sample (but beware of techniques that promote segregation)
Increment Delimitation/Extraction Errors	<ul style="list-style-type: none"> • Select sampling devices that delimit and extract the sample so that all material that should be included in the sample is captured and retained by the device (Pitard 1993, Myers 1997). • For one-dimensional wastes (e.g., flowing streams or waste on a conveyor), the correct or "ideal" sample is an undisturbed cross section delimited by two parallel planes (Pitard 1993, Gy 1998). To obtain such a sample, use a device that can obtain "all of the flow for a fraction of the time" (Gy 1998) (see also Section 6.3.2.1). • For three-dimensional wastes (e.g., solids in a roll-off bin), the waste can be considered for practical purposes a series of overlapping two-dimensional wastes. The correct or "ideal" sample is an undisturbed vertical core (Pitard 1993, Gy 1998) that captures the full depth of interest.
Preparation Error	<ul style="list-style-type: none"> • Take steps to prevent contamination of the sample during field handling and shipment. Sample contamination can be checked through preparation and analysis of field quality control samples such as field blanks, trip blanks, and equipment rinsate blanks. • Prevent loss of volatile constituents through proper storage and handling. • Minimize chemical transformations via proper storage and chemical/physical preservation. • Take care to avoid unintentional mistakes when labeling sample containers, completing other documentation, and handling and weighing samples.

6.3.1 Determining the Optimal Mass of a Sample

As part of the DQO Process (Step 4 - Define the Boundaries), we recommend that you determine the appropriate size (i.e., the mass or volume), shape, and orientation of the primary field sample. For heterogeneous materials, the size, shape, and orientation of each field sample will affect the analytical result. To determine the optimal mass (or weight) of samples to be collected in the field, you should consider several key factors:

- The number and type of chemical and/or physical analyses to be performed on each sample, including extra volumes required for QA/QC. (For example, SW-846 Method 1311 (TCLP) specifies the minimum sample mass to be used for the extraction.)
- Practical constraints, such as the available volume of the material and the ability to collect, transport, and store the samples

- The characteristics of the matrix (such as particulate solid, sludge, liquid, debris, oily waste, etc.)
- Health and safety concerns (e.g., acutely toxic, corrosive, reactive, or ignitable wastes should be transported and handled in safe quantities)
- Availability of equipment and personnel to perform particle-size reduction (if needed) in the field rather than within a laboratory.

Often, the weight (or mass) of a field sample is determined by “whatever will fit into the jar.” While this criterion may be adequate for some wastes or media, it can introduce serious biases – *especially in the case of sampling particulate solids*.

If a sample of particulate material is to be representative, then it needs to be representative of the largest particles of interest (Pitard 1993). This is relevant if the constituent of concern is not uniformly distributed across all the particle size fractions. To obtain a sample representative of the largest particles of interest, the sample must be of sufficient weight (or mass) to control the amount of fundamental error introduced during sampling.

If the constituent(s) of concern is uniformly distributed throughout all the particle size fractions, then determination of the optimal sample mass using Gy’s approach will not improve the representativeness of the sample. Homogeneous or uniform distribution of contaminants among all particle sizes, however, is not a realistic assumption, especially for contaminated soils. In contaminated soils, concentrations of metals tend to be higher in the clay- and silt-size fractions and organic contaminants tend to be associated with organic matter and fines in the soil.

The following material provides a “rule of thumb” approach for determining the particle-size sample-weight relationship sufficient to maintain fundamental error (as measured by the standard deviation of the fundamental error) within desired limits. A detailed quantitative method is presented in Appendix D. Techniques for calculating the variance of the fundamental error also are presented in Mason (1992), Pitard (1993), Myers (1997), and Gy (1998).

The variance of the fundamental error (s_{FE}^2) is directly proportional to the size of the largest particle and inversely proportional to the mass of the sample.² To calculate the appropriate mass of the sample, Pitard (1989) proposed a “Quick Safety Rule” for use in environmental sampling based on a standard deviation of the fundamental error of 5 percent ($s_{FE} = \pm 5\%$):

$$M_s \geq 10000d^3 \qquad \text{Equation 18}$$

where M_s is the mass of the sample in grams (g) and d of the diameter of the largest particle in centimeters (cm).

² In this section, we use the “relative variance” (s^2/\bar{x}^2) and the “relative standard deviation” (s/\bar{x}). The values are dimensionless and are useful for comparing results from different experiments.

Alternatively, if we are willing to accept $s_{FE} = \pm 16\%$, we can use

$$M_s \geq 1000d^3 \quad \text{Equation 19}$$

An important feature of the fundamental error is that it does not “cancel out.” On the contrary, the variance of the fundamental error adds together at each stage of subsampling. As pointed out by Myers (1997), the fundamental error quickly can accumulate and exceed 50 percent, 100 percent, 200 percent, or greater unless it is controlled through particle-size reduction *at each stage of sampling and subsampling*. The variance, s_{FE}^2 , calculated at each stage of subsampling and particle-size reduction, must be added together at the end to derive the total s_{FE}^2 . An example of how the variances of the fundamental error can be added together is provided in Appendix D.

6.3.2 Obtaining the Correct Shape and Orientation of a Sample

When sampling heterogeneous materials, the shape and orientation of the sampling device can affect the composition of the resulting samples and facilitate or impede achievement of DQOs. The following two subsections provide guidance on selecting the appropriate shape and orientation of samples obtained from a moving stream of material and a stationary batch or unit of material.

6.3.2.1 Sampling of a Moving Stream of Material

In sampling a moving stream of material, such as solids, liquids, and multi-phase mixtures moving through a pipe, on a conveyor, etc., the material can be treated as a one-dimensional mass. That is, the material is assumed to be linear in time or space.

The correct or “ideal” sample is an undisturbed cross section delimited by two parallel planes (Pitard 1993, Gy 1998). The approach is depicted in Figure 26 in which all of the flow is collected for part of the time. In practice, the condition can be met by using “cross-stream” sampling devices positioned at the discharge of a conveyor, hose, duct, etc. (Pitard 1993). Alternatively, in sampling solids from a conveyor belt, a transverse cutter or flat scoop (with vertical sides) can be used to obtain a sample, preferably with the conveyor stopped (though this condition may not be practical for large industrial conveyors).

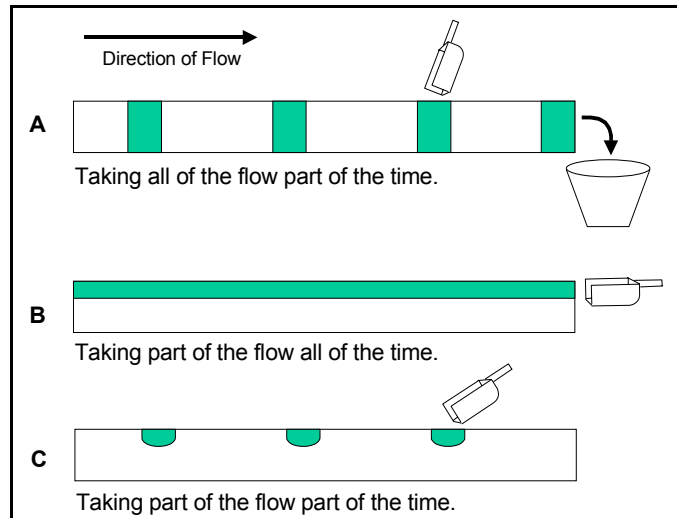

Figure 26. Three ways of obtaining a sample from a moving stream. “A” is correct. “B” and “C” will obtain biased samples unless the material is homogeneous (modified after Gy 1998).

For sampling of liquids, if the entire stream cannot be obtained for a fraction of the time (e.g., at the discharge point), then it may be necessary to introduce turbulence in the stream using baffles and to obtain a portion of the mixed stream part of the time (Pitard 1993).

6.3.2.2 Sampling of a Stationary Batch of Material

Sampling of a stationary batch of material, such as filter cake in a roll-off bin, soil in a drum, or liquid in a tank can be approached by viewing the three-dimensional space as a series of overlapping two-dimensional (i.e., relatively flat) masses in a horizontal plane. The correct or “ideal” sample of a is a core that obtains the full thickness of the material of interest.

For example, Figure 27 shows a bin of granular waste with fine grain material in the upper layer and larger fragments in the bottom layer. The entire batch of material is the “decision unit.” Coring device “A” is correct: it is wide enough and long enough to include the largest fragments in the waste. Coring device “B” is too narrow. It either fails to capture the larger particles or simply pushes them out of the way (causing *increment delimitation error*). Device “C,” a trowel or small shovel, can collect an adequate volume of sample, but it preferentially selects only the finer grained material near the top of the bin. Device “D” is the correct shape, but it is not in the correct orientation. Devices “B,” “C,” and “D” yield incorrect sample support.

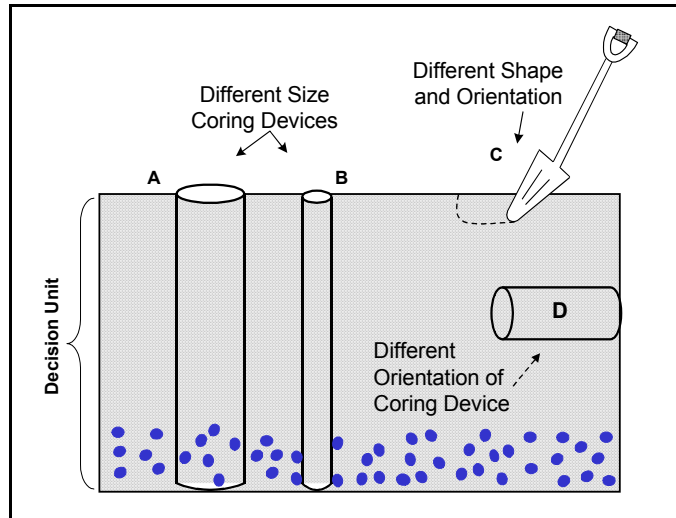

Figure 27. Sampling a three-dimensional waste by treating the sampling problem as a series of overlapping two-dimensional wastes. Only device “A” provides the correct size, shape, and orientation of the sample.

6.3.3 Selecting Sampling Devices That Minimize Sampling Errors

As part of the project planning process, you should establish performance goals for the sampling devices to be used and understand the possible limitations of any candidate sampling devices or equipment. The performance goals can then be used to select specific sampling devices or technologies with a clear understanding of the limitations of those devices in the field. Detailed guidance on the selection of specific sampling devices is provided in Section 7 and Appendix E of this document.

6.3.3.1 General Performance Goals for Sampling Tools and Devices

Selection of the appropriate sampling device and sampling method will depend on the sampling objectives, the physical characteristics of the waste or media, the chemical constituents of concern, the sampling location, and practical concerns such as technology limitations and safety issues (see also Section 7). The following general performance goals apply to the selection of sampling devices for use in those situations in where it is desirable to control or otherwise minimize biases introduced by the sampling device:

- The device should not include or exclude portions of the waste that do not belong in the sample (in other words, the device should minimize delimitation and extraction errors).

- If volatile constituents are of interest, the device should obtain samples in an undisturbed state to minimize loss of volatile constituents.
- The device should be constructed of materials that will not alter analyte concentrations due to loss or gain of analytes via sorption, desorption, degradation, or corrosion.
- The device should retain the appropriate size (volume or mass) and shape of sample, and obtain it in the orientation appropriate for the sampling condition -- preferably in one pass.

Other considerations not related to performance follow:

- "Ease of use" of the sampling device under the conditions that will be encountered in the field. This includes the ease of shipping to and from the site, ease of deployment, and ease of decontamination.
- The degree of hazard associated with the deployment of one sampling device versus another (e.g., consider use of an extension pole instead of a boat to sample from a waste lagoon).
- Cost of the sampling device and of the labor (e.g., single vs. multiple operators) for its deployment (including training) and maintenance.

6.3.3.2 Use and Limitations of Common Devices

Unfortunately, many sampling devices in common use today lack the properties required to minimize certain types of sampling error. In fact, there are few devices available that satisfy all the general performance goals stated above. Pitard (1993), however, has identified a number of devices that can help minimize delimitation and extraction error (depending on the physical form of the waste to be sampled). These devices include:

- COLIWASA (or "composite liquid waste sampler") -- for sampling free-flowing liquids in drums or containers
- Shelby tube or similar device -- for obtaining core samples of solids
- Kemmerer depth sampler -- for obtaining discrete samples of liquids
- Flat scoop (with vertical walls) -- for subsampling solids on a flat surface.

Some devices in common use that can cause delimitation and extraction errors include the following: auger, shovel, spoon, trowel, thief, and trier. In spite of the limitations of many conventional sampling devices, it is necessary to use them under some circumstances encountered in the field because there are few alternatives. When selecting a sampling tool, choose the one that will introduce the least sampling error. In cases in which no such tool exists, document the approach used and be aware of the types of errors likely introduced and their possible impact on the sampling results. To the extent possible and practicable, minimize sampling errors by applying the concepts presented in this chapter.

6.3.4 Special Considerations for Sampling Waste and Soils for Volatile Organic Compounds

In most contaminated soils and other solid waste materials, volatile organic compound (VOCs), when present, coexist in gaseous, liquid, and solid (sorbed) phases. Of particular concern with regard to the collection, handling, and storage of samples for VOC characterization is the retention of the gaseous component. This phase exhibits molecular diffusion coefficients that allow for the immediate loss of gas-phase VOCs from a freshly exposed surface and continued losses from well within a porous matrix. Furthermore, once the gaseous phase becomes depleted, nearly instantaneous volatilization from the liquid and sorbed phases occurs in an attempt to restore the temporal equilibrium that often exists, thereby allowing the impact of this loss mechanism to continue.

Another mechanism that can influence VOC concentrations in samples is biological degradation. In general, this loss mechanism is not expected to be as large a source of determinate error as volatilization. This premise is based on the observation that losses of an order of magnitude can occur on a time scale of minutes to hours due solely to diffusion and advection, whereas losses of a similar magnitude due to biological processes usually require days to weeks. Furthermore, under aerobic conditions, which is typical of most samples that are transported and stored, biological mechanisms favor the degradation of aromatic hydrocarbons over halogenated compounds. Therefore, besides the slower rate of analyte loss, biodegradation is compound selective.

To limit the influence of volatilization and biodegradation losses, which, if not addressed can biased results by one or more orders of magnitude, it is currently recommended that sample collection and preparation, however not necessarily preservation, follow one or the other of these two protocols:

- The immediate in-field transfer of a sample into a weighed volatile organic analysis vial that either contains VOC-free water so that a vapor partitioning (purge-and-trap or headspace) analysis can be performed without reopening or that contains methanol for analyte extraction in preparation for analysis, or
- The collection and up to 2-day storage of intact samples in airtight containers before initiating one of the aforementioned sample preparation procedures.

In both cases, samples should be held at 4 ± 2 °C while being transported from the sampling location to the laboratory.

The *Standard Guide for Sampling Waste and Solids for Volatile Organics* (ASTM D 4547-98) is recommended reading for those unfamiliar with the many challenges associated with collecting and handling samples for VOC analysis.

7 IMPLEMENTATION: SELECTING EQUIPMENT AND CONDUCTING SAMPLING

This section provides guidance on selecting appropriate sampling tools and devices (Section 7.1), conducting field sampling activities (Section 7.2), and using sample homogenization, splitting, and subsampling techniques (Section 7.3).

7.1 Selecting Sampling Tools and Devices

The tools, devices, and methods used for sampling waste materials will vary with the form, consistency, and location of the waste materials to be sampled. As part of the DQO Process, you identify the location (type of unit or other source description) from which the samples will be obtained and the “dimension” of the sampling problem (such as “one-dimensional” or “two-dimensional”). In the DQO Process, you also specify the appropriate size, shape, orientation and other characteristics for each sample (called the “sample support”). In addition to the DQOs for the sample, you will identify performance goals for the sampling device. You may need a device that meets the following qualifications:

For additional guidance on the selection and use of sampling tools and devices, see:

- 40 CFR 261, Appendix I, Representative Sampling Methods
- *Standard Guide for Selection of Sampling Equipment for Waste and Contaminated Media Data Collection Activities* (ASTM D 6232)

- Minimizes delimitation and extraction errors so that it does not include material that should not be in the sample, nor exclude material that should be in the sample
- Provides a largely undisturbed sample (e.g., one that minimizes the loss of volatile constituents, if those are constituents of concern)
- Is constructed of materials that are compatible with the media and the constituents of concern (e.g., the materials of construction do not cause constituent loss or gain due to sorption, desorption, degradation, or corrosion)
- Is easy to use under the conditions of the sampling location, and the degree of health or safety risks to workers is minimal
- Is easy to decontaminate
- Is cost-effective during use and maintenance.

Unfortunately, few devices will satisfy all of the above goals for a given waste or medium and sampling design. When selecting a device, try first to choose one that will introduce the least sampling error and satisfy other performance criteria established by the planning team, within practical constraints.

Figure 28 summarizes the steps you can use to select an optimal device for obtaining samples.

Using the outputs from the DQO Process, a description of the medium to be sampled, and knowledge of the site or location of sample collection, Tables 8 and 9 (beginning on pages 109 and 115 respectively) can be used to quickly identify an appropriate sampling device. For most situations, the information in the tables will be sufficient to make an equipment selection; however, if you need additional guidance, review the more detailed information provided in Appendix E or refer to the references cited.

If desired, you can refer to the documents (such as ASTM standards) referenced by Table 8 for supplementary guidance specific to sampling a specific medium and site, or refer to those referenced by Table 9 for supplementary guidance on a device.¹ The contents of the ASTM standards are summarized in Appendix J. (For more information on ASTM or purchasing their publications, including the standards referenced in this chapter, contact ASTM at: ASTM, 100 Barr Harbor Drive, West Conshohocken, PA 19428-2959, or by telephone at 610-832-9585, via the World Wide Web at <http://www.astm.org>.)

In particular, we recommend that you review the guidance found in ASTM Standard D 6232, *Standard Guide for Selection of Sampling Equipment for Waste and Contaminated Media Data Collection Activities*. Most of the information on sampling devices found in this chapter and in Tables 8 and 9 came from that standard. As noted by the standard, it covers criteria that should be considered when selecting sampling equipment for collecting environmental and waste samples for waste management activities. It also describes many of the typical devices used during such sampling.

Because each sampling situation is unique, the guidance in this chapter may not adequately cover your specific sampling scenario. You may have to modify a part of the device or modify the device application to improve its performance or to facilitate sample collection. For

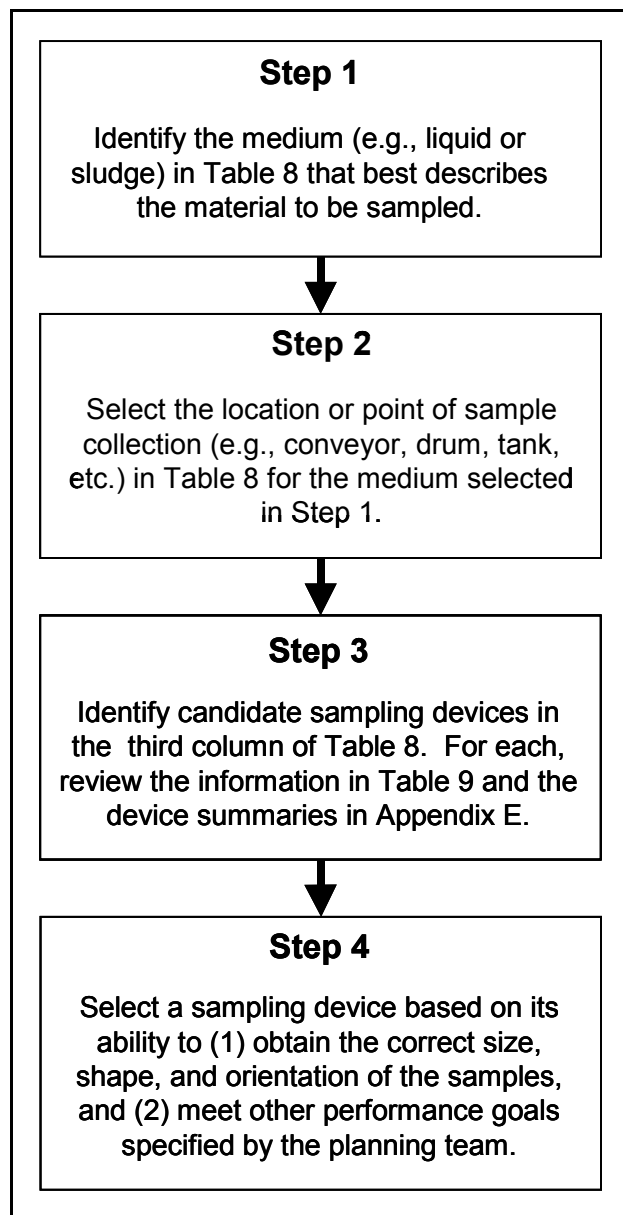

Figure 28. Steps for selecting a sampling device

¹ ASTM is a consensus standards development organization. Consistent with the provisions of the National Technology Transfer and Advancement Act of 1995 (NTTAA), Public Law 104-113, Section 12(d), which directs EPA to use voluntary consensus standards to the extent possible, this guidance supports the use of and provides references to ASTM standards applicable to waste sampling.

example, you might use a rope or an extension handle on a device to access a particular location within a waste management unit. In other cases, you may need auxiliary equipment that will increase the cost or complexity of sampling operation (such as a drill rig to drive a split barrel sampler or a power supply to run a pump). The physical state of the waste or design of the unit also may affect how the equipment is deployed. You should address such variations as part of your sampling plan and make sure that any modifications do not cause sampling bias.

Finally, other sampling devices not addressed in this chapter can and should be used if appropriate (e.g., if the device meets the performance goals and is more practical). New or innovative devices not discussed in this chapter also should be considered for use if they allow you to meet the sampling objectives in a more cost-effective manner. In other words, we encourage and recommend a performance-based approach for selecting sampling equipment.

7.1.1 Step 1: Identify the Waste Type or Medium to be Sampled

The first column of Table 8 (page 109) lists the media type or waste matrix commonly sampled under RCRA. These media may include liquids, sludges or slurries, various unconsolidated solids, consolidated solids and debris, soil, ground water, sediment, soil gas, and air. In general, the types of media describe the physical state of the material to be sampled. The physical characteristics of the waste or medium affect many aspects of sampling, including the volume of material required, selection of the appropriate sampling device, how the device is deployed, and the containers used for the samples. Table 10 provides an expanded description of the media listed in Table 8.

7.1.2 Step 2: Identify the Site or Point of Sample Collection

In the second column of Table 8, identify the site or point of sample collection that best describes where you plan to obtain the samples. The “site or point of sample collection” may include (1) the point at which the waste is generated (e.g., as the waste exits a pipe, moves along a conveyor, or is poured or placed into a container, tank, impoundment or other waste management unit); (2) the unit in which the waste is stored (such as a drum, collection hopper, tank, waste pile, surface impoundment, sack or bag) or transported (such as a drum, tanker truck, or roll-off box); or (3) the environmental medium to be sampled (such as surface soil, subsurface soil, ground water, surface water, soil gas, or air).

When testing a solid waste to determine if it should be characterized as a hazardous waste or to determine if the waste is restricted from land disposal, such a determination must be made at the **point of waste generation**.

7.1.2.1 Drums and Sacks or Bags

Drums and sacks or bags are portable containers used to store, handle, or transport waste materials and sometimes are used in waste disposal (e.g., drums in a landfill). “Drums” include metal drums and pails, plastic drums, or durable fiberboard paper drums or pails (USEPA 1994a). Drums and pails may contain nearly the full range of media -- liquids (single or multi-layered), sludges, slurries, or solids. Sacks or bags include less rigid portable containers and thus can contain only solids. The sampling approach (including number of samples, locations of samples, sampling device, depth of samples) for these containers will depend on the number of

containers to be sampled, waste accessibility, physical and chemical characteristics of the waste, and component distribution within the containers.

Review ASTM Standards D 6063, *Guide for Sampling Drums and Similar Containers by Field Personnel*, and D 5679, *Practice for Sampling Consolidated Solids in Drums or Similar Containers*, for more information on the sampling of drums and sacks or bags. Other useful guidance on sampling drums includes "Drum Sampling" (USEPA 1994b), issued by EPA's Environmental Response Team.

7.1.2.2 *Surface Impoundments*

Surface impoundments include natural depressions, manmade excavations, or diked areas that contain an accumulation of liquids or wastes containing free liquids and solids. Examples of surface impoundments are ponds, lagoons, and holding, storage, settling, and aeration pits (USEPA 1994a). The appropriate sampling device for sampling a surface impoundment will depend on accessibility of the waste, the type and number of phases of the waste, the depth, and chemical and physical characteristics of the waste.

7.1.2.3 *Tanks*

A tank is defined at § 260.10 as a stationary device, designed to contain an accumulation of hazardous waste which is constructed primarily of non-earthen materials which provide structural support. A container is defined at § 260.10 as a portable device, in which a material is stored, transported, treated, disposed of, or otherwise handled. The distinction that a tank is not a container is important because the regulations at 261.7 set forth conditions to distinguish whether hazardous waste in a container is subject to regulation. Nevertheless, for the purpose of selecting an appropriate sampling device, the term "tank" as used in Table 8 could include other units such as tank trucks and tanker cars even though they are portable devices.

The selection of equipment for sampling the pipes and sampling ports of a tank system is covered separately under those categories. The equipment used to sample a pipe or spigot can be very different from that used to sample an open tank.

Tanks usually contain liquids (single or multi-layered), sludges, or slurries. In addition, suspended solids or sediments may have settled in the bottom of the tank. When sampling from a tank, one typically considers how to acquire a sufficient number of samples from different locations (including depths) to adequately represent the entire content of the tank.

Waste accessibility and component distribution will affect the sampling strategy and equipment selection. In addition to discharge valves near the bottom, most tanks have hatches or other openings at the top. It is usually desirable to collect samples via a hatch or opening at the top of the tank because of the potential of waste stratification in the tank (USEPA 1996b). In an open tank, the size of the tank may restrict sampling to the perimeter of the tank. Usually, the most appropriate type of sampling equipment for tanks depends on the design of the tanks and the media contained within the tank.

You can find additional guidance on sampling tanks in "Tank Sampling" (USEPA 1994c), issued by the EPA's Environmental Response Team.

7.1.2.4 Pipes, Point Source Discharges, or Sampling Ports

For the purpose of this guidance, pipes or point source discharges include moving streams of sludge or slurry discharging from a pipe opening, sluice, or other discharge point (such as the point of waste generation). Sampling ports include controlled liquid discharge points that were installed for the purpose of sampling, such as may be found on tank systems, a tank truck, or leachate collection systems at waste piles or landfills.

A dipper also is used to sample liquids from a sampling port. Typically, it is passed through the stream in one sweeping motion so that it is filled in one pass. In that instance, the size of the dipper beaker should be related to the stream flow rate. If the cross-sectional area of the stream is too large, more than one pass may be necessary to obtain a sample (USEPA 1993b). Besides the use of a dipper or other typical sampling devices, sometimes the sample container itself is used to sample a spigot or point source discharge. This eliminates the possibility of contaminating the sample with intermediate collection equipment, such as a dipper (USEPA 1996b).

See ASTM D 5013-89 *Standard Practices for Sampling Wastes from Pipes and Other Point Discharges* for more information on sampling at this location. Also see Gy (1998) and Pitard (1989, 1993).

7.1.2.5 Storage Bins, Roll-Off Boxes, or Collection Hoppers

Discharges of unconsolidated solids from a process, such as filter cakes, often fall from the process into a collection hopper or other type of open-topped storage container. Sometimes the waste materials are combined into large a storage bin, such as a roll-off box or collection hopper. A storage bin also may be used to collect consolidated solids, such as construction debris. The waste can be sampled either as it is placed in the container or after a certain period of accumulation, depending on the technical and regulatory objectives of the sampling program.

7.1.2.6 Waste Piles

Waste piles include the non-containerized accumulation of solid and nonflowing waste material on land. The size of waste piles can range from small heaps to large aggregates of wastes. Liners may underlie a waste pile, thereby preventing direct contact with the soil. As with other scenarios, waste accessibility and heterogeneity will be key factors in the sampling design and equipment selection. Besides the devices listed in this chapter, excavation equipment may be needed at first to properly sample large piles. Waste piles may present unique sample delimitation problems (Pitard 1993 and Myers 1997), and special considerations related to sampling design may be necessary (such as the need to flatten the pile).

We recommend a review of ASTM Standard D 6009, *Guide for Sampling Waste Piles* for more information. Another source of information on sampling waste piles is "Waste Pile Sampling" (USEPA 1994d), issued by EPA's Environmental Response Team.

7.1.2.7 Conveyors

Solid process discharges are sometimes sampled from conveyors such as conveyor belts or screw conveyors. Conveyor belts are open moving platforms used to transport material

between locations. Solid or semi-solid wastes on a conveyor belt can be sampled with a flat scoop or similar device (see also Section 6.3.2.1). Screw conveyors usually are enclosed systems that require access via a sampling port, or they can be sampled at a discharge point. See also ASTM D 5013 and Gy (1998, pages 43 through 56).

7.1.2.8 Structures and Debris

This guidance assumes that the sampling of structure or debris typically will include the sampling of consolidated solids such as concrete, wood, or other structure debris. Appendix C provides supplemental guidance on developing a sampling strategy for such heterogeneous wastes. See also AFCEE (1995), Koski, et al. (1991), Rupp (1990), USEPA and USDOE (1992), and ASTM Standard D 5956, *Standard Guide For Sampling Strategies for Heterogeneous Wastes*.

7.1.2.9 Surface or Subsurface Soil

Selection of equipment for sampling soil is based on the depth of sampling, the grain-size distribution, physical characteristics of the soil, and the chemical parameters of interest (such as the need to analyze the samples for volatiles). Your sampling strategy should specify the depth and interval (e.g., “0 to 6 inches below ground surface”) of interest for the soil samples.

Simple manual techniques and equipment can be used for surface or shallow depth sampling. To obtain samples of soil from greater depths, powered equipment (e.g., power augers or drill rigs) will be required; however, those are not used for actual sample collection, but are used solely to gain easier access to the required sample depth (USEPA 1996b). Once at the depth, surface sampling devices may be used.

ASTM has developed many informative standards on the sampling of soil, including D 4700, *Standard Guide for Soil Sampling from the Vadose Zone*, and D 4220, *Standard Practices for Preserving and Transporting Soil Samples*. In addition, see EPA-published guidance such as *Preparation of Soil Sampling Protocols: Sampling Techniques and Strategies* (Mason 1992) and *Description and Sampling of Contaminated Soils - A Field Pocket Guide* (USEPA 1991b).

7.1.3 Step 3: Consider Device-Specific Factors

After you identify the medium and site of sample collection, refer to the third column of Table 8 for the list of candidate sampling devices. We listed common devices that are appropriate for the given media and site. Next, refer to the information in Table 9 for each of the candidate devices to select the most appropriate one for your sampling effort.

Table 9 provides device-specific information to help you choose the appropriate device based on the study objective and the DQOs established for volume (size), shape, depth, and orientation of the sample, and sample type (discrete or composite, surface or at depth).

For easy reference, the devices are listed alphabetically in Table 9. Appendix E contains a summary description of key features of each device and sources for other information. Under the third column in Table 9, “Other Device-Specific Guidance,” we have identified some of those sources, especially relevant ASTM standards (see summaries of ASTM standards in Appendix J).

7.1.3.1 *Sample Type*

The column “Sample Type” Table 9 identifies whether the device can sample at surface only, shallow or at a deeper profile (depth), and whether the device can obtain a discrete sample or a composite sample. For example, a COLIWASA or drum thief can be used to sample a container that is 3-feet deep, but a Kemmerer sampler may be required to sample the much deeper depth of an impoundment. We also identify in this column whether the device collects a undisturbed or disturbed solid sample. Also, the actual depth capacity may depend on the design of the device. Some devices can be modified or varied to collect at different depths or locations in a material. You should refer to the device summary in Appendix E if you need specifics regarding the sampling depth available for a given device.

7.1.3.2 *Sample Volume*

The column for volume in Table 9 identifies the range of sample volume, in liters, that the device can obtain. It may be possible to increase or decrease this value through modification of the device. During the planning process, you should determine the correct volume of sample needed. Volume is one of the components of sample “support” (that is, the size, shape, and orientation of the sample).

7.1.3.3 *Other Device-Specific Considerations*

The last column of Table 9 notes other considerations for device selection. The comments focus on those factors that may cause error to be introduced or that might increase the time or cost of sampling. For some devices, the column includes comments on how easy the equipment is to use, such as whether it needs a power source or is heavy, and whether it can be decontaminated easily. The table also mentions whether the device is appropriate for samples requiring the analysis of volatile organic constituents and any other important considerations regarding analyte and device compatibility. The equipment should be constructed of materials that are compatible with the waste and not susceptible to reactions that might alter or bias the physical or chemical characteristics of the sample of the waste.

7.1.4 Step 4: Select the Sampling Device

Select the sampling device based on its ability to (1) obtain the correct size, shape, and orientation of the samples (see Sections 6.3.1 and 6.3.2) and (2) meet any other performance criteria specified by the planning team in the DQO Process (see Section 6.3.3.1). In addition, samples to be analyzed for volatile organic constituents should be obtained using a sampling technique that will minimize the loss of constituents and obtain a sample volume required for the analytical method (see Section 6.3.4).

Table 8. Device Selection Guide -- Media and Site of Sample Collection

Media <i>(See Section 7.1.1)</i>	Site or Point of Sample Collection <i>(See Section 7.1.2)</i>	Candidate Devices <i>(Listed Alphabetically. For Device-Specific Information, See Table 9)</i>	Other Related Guidance
Liquids, no distinct layer of interest Examples: Containerized spent solvents, leachates or other liquids discharged from a pipe or spigot	Drum	COLIWASA Dipper Drum thief Liquid grab sampler Peristaltic pump Plunger type sampler Settleable solids profiler Swing jar sampler Syringe sampler Valved drum sampler	ASTM D 5743 ASTM D 6063 EPA/ERT SOP 2009 (USEPA 1994b)
	Surface impoundment	Automatic sampler Bacon bomb Bailer Bladder pump Centrifugal sub-pump Dipper Displacement pump Kemmerer sampler Liquid grab sampler Peristaltic pump Plunger type sampler Settleable solids profiler Swing jar sampler Syringe sampler	ASTM D 6538 USEPA (1984, 1985, and 1989c)
	Tank	Bacon bomb Bailer COLIWASA Dipper Drum thief Kemmerer sampler Liquid grab sampler Peristaltic pump Plunger type sampler Settleable solids profiler Submersible pump Swing jar sampler Syringe sampler	ASTM D 6063 ASTM D 5743 EPA/ERT SOP 2010 (USEPA 1994c)

* Copies of EPA/ERT SOPs are available on the Internet at <http://www.ert.org/>

Table 8. Device Selection Guide -- Media and Site of Sample Collection (Continued)

Media <i>(See Section 7.1.1)</i>	Site or Point of Sample Collection <i>(See Section 7.1.2)</i>	Candidate Devices <i>(Listed Alphabetically. For Device-Specific Information, See Table 9)</i>	Other Related Guidance
Liquids, no distinct layer of interest (continued)	Pipe, point source discharge	Automatic sampler Bladder pump Centrifugal submersible pump Dipper Displacement pump Liquid grab sampler Plunger type sampler Sample container Swing jar sampler	ASTM D 5013 ASTM D 5743 ASTM D 6538 Gy 1998
	Sampling port (e.g., spigot)	Beaker, bucket, sample container Swing jar sampler	Gy 1998
Liquids, multi-layered, with one or more distinct layers of interest Examples: Non-aqueous phase liquids (NAPLs) in a tank; mixtures of antifreeze in a tank.	Drum	COLIWASA Discrete level sampler Drum thief Plunger type sampler Settleable solids profiler Swing jar sampler Syringe sampler Valved drum sampler	ASTM D 6063
	Surface impoundment	Automatic sampler Bacon bomb Bailer (point source bailer) Bladder pump Centrifugal submersible pump Discrete level sampler Displacement pump Peristaltic pump Plunger type sampler Settleable solids profiler Swing jar sampler Syringe sampler	ASTM D 6538 USEPA (1989c)
	Tank	COLIWASA Centrifugal submersible pump Bacon bomb Bailer Discrete level sampler Peristaltic pump Plunger type sampler Settleable solids profiler Swing jar sampler Syringe sampler Valved drum sampler	ASTM D 6063 ASTM D 5743 EPA/ERT SOP 2010 (USEPA 1994c)

Table 8. Device Selection Guide -- Media and Site of Sample Collection (Continued)

Media (See Section 7.1.1)	Site or Point of Sample Collection (See Section 7.1.2)	Candidate Devices (Listed Alphabetically. For Device-Specific Information, See Table 9)	Other Related Guidance
Sludges, slurries, and solid-liquid suspensions Examples: Paint sludge, electroplating sludge, and ash and water slurry.	Drum	COLIWASA Dipper Liquid grab sampler Plunger type sampler Settleable solids profiler Swing jar sampler Syringe sampler	ASTM D 6063
	Tank	COLIWASA Dipper Lidded sludge/water sampler Liquid grab sampler Plunger type sampler Ponar dredge Settleable solids profiler Swing jar sampler Syringe sampler	ASTM D 6063 EPA/ERT 2010 (USEPA 1994c)
	Surface impoundment	Dipper Lidded sludge/water sampler Liquid grab sampler Peristaltic pump Plunger type sampler Ponar dredge Settleable solids profiler Swing jar sampler	USEPA (1989c)
	Pipe or conveyor	Dipper or bucket Scoop/trowel/shovel Swing jar sampler	ASTM D 5013
Granular solids – unconsolidated Examples: Filter press cake, powders, excavated (<i>ex situ</i>) soil, incinerator ash	Drum	Bucket auger Coring type sampler (w/valve) Miniature core sampler Modified syringe sampler Trier Scoop/trowel/shovel	ASTM D 5680 ASTM D 6063 EPA/ERT SOP 2009 (USEPA 1994b)
	Sack or bag	Concentric tube thief Miniature core sampler Modified syringe sampler Scoop/trowel/shovel Trier	ASTM D 5680 ASTM D 6063

Table 8. Device Selection Guide -- Media and Site of Sample Collection (Continued)

Media <i>(See Section 7.1.1)</i>	Site or Point of Sample Collection <i>(See Section 7.1.2)</i>	Candidate Devices <i>(Listed Alphabetically. For Device-Specific Information, See Table 9)</i>	Other Related Guidance
Granular solids – unconsolidated (continued)	Storage bin, roll-off box, or collection hopper	Bucket auger Concentric tube thief Coring type sampler (w/valve) Miniature core sampler Modified syringe sampler Scoop/trowel Trier	ASTM D 5680 ASTM D 6063
	Waste pile	Bucket auger Concentric tube thief Coring type sampler (w/valve) Miniature core sampler Modified syringe sampler Scoop/trowel/shovel Thin-walled tube Trier	ASTM D 6009 EPA/ERT SOP 2017 (USEPA 1994d)
	Pipe (e.g., vertical discharge from cyclone centrifuge or baghouse) or conveyor	Bucket, dipper, pan, or sample container Miniature core sampler Scoop/trowel/shovel Trier	ASTM D 5013 Gy (1998) Pitard (1993)
Other solids – unconsolidated Examples: Waste pellets, catalysts, or large-grained solids.	Drum	Bucket auger Scoop/trowel/shovel	ASTM D 5680 ASTM D 6063 EPA/ERT SOP 2009 (USEPA 1994b)
	Sack or bag	Bucket auger Scoop/trowel/shovel	ASTM D 5680 ASTM D 6063
	Storage bin, roll-off box, or collection hopper	Bucket auger Scoop/trowel/shovel	ASTM D 5680 ASTM D 6063
	Waste pile	Bucket auger Scoop/trowel/shovel Split barrel Thin-walled tube	ASTM D 6009 EPA/ERT SOP 2017 (USEPA 1994d)
	Conveyor	Scoop/trowel/shovel	ASTM D 5013 Gy (1998) Pitard (1993)

Table 8. Device Selection Guide -- Media and Site of Sample Collection (Continued)

Media (See Section 7.1.1)	Site or Point of Sample Collection (See Section 7.1.2)	Candidate Devices (Listed Alphabetically. For Device-Specific Information, See Table 9)	Other Related Guidance
Soil and other unconsolidated geologic material Examples: <i>In situ</i> soil at a land treatment unit or <i>in situ</i> soil at a SWMU	Surface	Bucket auger Concentric tube thief Coring type sampler Miniature core sampler Modified syringe sampler Penetrating probe sampler Scoop/trowel/shovel Thin-Walled Tube Trier	ASTM D 5730 ASTM E 1727 ASTM D 4700 EISOPQA Manual (USEPA 1996b)
	Subsurface	Bucket auger Coring type sampler Miniature core sampler Mod. syringe sampler Penetrating probe sampler Shovel/scoop/shovel Split barrel Thin-walled tube	ASTM D 4700 ASTM D 5730 ASTM D 6169 ASTM D 6282 USEPA (1996b) USEPA (1993c)
Solids – consolidated Examples: Concrete, wood, architectural debris*	Storage bin (e.g., roll-off box)	Penetrating probe sampler Rotating coring device	ASTM D 5679 ASTM D 5956 ASTM D 6063 USEPA and USDOE (1992)
	Waste pile	Penetrating probe sampler Rotating coring device Split barrel	ASTM D 6009 USEPA and USDOE (1992)
	Structure	Rotating coring device (See also Appendix C, Section C.5)	AFCEE (1995) Koski, et al (1991) USEPA and USDOE (1992)

* The term “debris” has a specific definition under 40 CFR 268.2(g) (Land Disposal Restrictions regulations) and includes “solid material exceeding a 60 mm particle size that is intended for disposal and that is a manufactured object; or plant or animal matter; or natural geologic material.” § 268.2(g) also identifies materials that are not debris. In general, debris includes materials of either a large particle size or variation in the items present.

Table 8. Device Selection Guide -- Media and Site of Sample Collection (Continued)

Selected References for Sampling of Other Media	
<p>Air</p> <p>Example: BIF emissions</p>	<p>Chapter Ten SW-846</p> <p>EISOPQA Manual (USEPA 1996b)</p>
<p>Sediment</p> <p>Example: Surface impoundment sediment</p>	<p><i>QA/QC Guidance for Sampling and Analysis of Sediments, Water, and Tissues for Dredged Material Evaluations</i> (USEPA 1995d)</p> <p><i>Superfund Program Representative Sampling Guidance Volume 5; Water and Sediment, Part I – Surface Water and Sediment, Interim Final Guidance</i> (USEPA 1995e)</p> <p>Region 4 EISOPQA Manual (USEPA 1996b)</p> <p><i>Sediment Sampling</i> (USEPA 1994e)</p> <p>ASTM D 4823; ASTM D 5387</p>
<p>Soil Gas or Vapor</p> <p>Examples: Soil, soil water, or gas in the vadose zone at a waste disposal site</p>	<p><i>Subsurface Characterization and Monitoring Techniques - A Desk Reference Guide</i> (USEPA 1993c)</p> <p><i>ASTM Standard Guide for Soil Gas Monitoring in the Vadose Zone</i> (ASTM D 5314)</p> <p><i>Soil Gas Sampling</i> (USEPA 1996c)</p>
<p>Ground Water</p> <p>Example: Ground-water monitoring wells at a landfill</p>	<p><i>RCRA Ground-Water Monitoring Draft Technical Guidance</i> (USEPA 1992c)</p> <p><i>Low-Flow (Minimal Drawdown) Ground-Water Sampling Procedures</i> (Puls and Barcelona 1996)</p> <p>ASTM D4448-01 Standard Guide for Sampling Ground-Water Monitoring Wells</p> <p>ASTM D 5092-90 <i>Standard Practice for Design and Installation of Ground Water Monitoring Wells in Aquifers</i></p> <p>ASTM D 6286-98 <i>Standard Guide for Selection of Drilling Methods for Environmental Site Characterization</i></p> <p>ASTM D 6282 <i>Standard Guide for Direct Push Soil Sampling for Environmental Site Characterizations</i></p> <p>ASTM D 6771-02 <i>Standard Practice for Low-Flow Purging and Sampling for Wells and Devices Used for Ground-Water Quality Investigations</i></p>

Table 9. Device Selection Guide – Device-Specific Factors

Sampling Device (Listed in Alphabetical Order)	Description, Appendix E, Section No.	Other Device-Specific Guidance (in Addition to ASTM D 6232)	Sample Type	Volume (Liters per Pass)	Comments (For Example: Effects on Matrix, Operational Considerations, Typical Uses)
Automatic sampler	E.1.1	ASTM D 6538 EISOPQA Manual (USEPA 1996b)	Shallow (25 in.), discrete or composite	Unlimited	Auto samplers are available to collect samples for volatile organics analysis, provide a grab or composite sample, and may be unattended. Need power source/battery. Commonly used at waste water treatment plants. Must be knowledgeable of compatibility of waste and sampler components.
Bacon bomb	E.3.1	USEPA 1984 USEPA 1994c	Depth, discrete	0.1 to 0.5	For parameters that do not require a polytetrafluoroethylene (PTFE) sampler. Recommended for sampling of lakes, ponds, large tanks, or lagoons. May be difficult to decontaminate and materials of construction may not be compatible with sample matrix.
Bailer	E.7.1	ASTM D 4448 USEPA 1992c USEPA 1994c	Depth, discrete	0.5 to 2.0	Bailers are not recommended for sampling ground water for trace constituent analysis due to sampling induced turbidity (USEPA 1992c and Puls and Barcelona 1996). Unable to collect samples from specific depths (unless a point-source bailer is used). Available in a variety of sizes as either reusable or single use devices. May be chemically incompatible with certain matrices unless constructed of resistant material.
Bladder pump	E.1.2	ASTM D 4448 USEPA 1992c USEPA 1996b	Depth, discrete	Unlimited	For purging or sampling of wells, surface impoundments, or point discharges. Contact parts are made of PTFE, PVC and stainless steel. Requires a power source, compressed gas, and a controller. Difficult to decontaminate (based on design). Suitable for samples requiring VOAs. May require a winch or reel.
Bucket auger	E.5.1	ASTM D 1452 ASTM D 4700 ASTM D 6063 Mason 1992 USEPA 1993c	Surface or depth, disturbed	0.2 to 1.0	Easy and quick for shallow subsurface samples but not recommended for VOAs. Requires considerable strength and labor and destroys soil horizons.

Table 9. Device Selection Guide – Device-Specific Factors (Continued)

Sampling Device (listed in alphabetical order)	Description, Appendix E, Section	Other Device-Specific Guidance (in addition to ASTM D 6232)	Sample Type	Volume (Liters Per Pass)	Comments (For Example: Effects on Matrix, Operational Considerations, Typical Uses)
Centrifugal submersible pump	E.1.4	ASTM D 4448 ASTM D 4700 USEPA 1992c	Depth, discrete	Unlimited	For purging or sampling wells, surface impoundments, or point discharges. Contact parts are made of PTFE and stainless steel. Requires a power source. Adjustable flow rate and easy to decontaminate. Not compatible with liquids containing high percent solids. May require a winch or reel.
COLIWASA	E.6.1	ASTM D 5495 ASTM D 5743 ASTM D 6063 USEPA 1980	Shallow, composite	0.5 to 3.0	Reusable and single use models available. Inexpensive. Glass type devices may be difficult to decontaminate. Collects undisturbed sample. For mixed solid/liquid media will collect semi-liquid only. Not for high viscosity liquids.
Concentric tube thief	E.4.3	ASTM D 6063 USEPA 1994d	Surface, relatively undisturbed, selective	0.5 to 1.0	Recommended for powdered or granular materials or wastes in piles or in bags, drums or similar containers. Best used in dry, unconsolidated materials. Not suitable for sampling large particles due to narrow width of slot.
Coring type sampler (with or without valve)	E.4.6	ASTM D 4823 USEPA 1989c	Surface or depth, disturbed	0.2 to 1.5	Designed for wet soils and sludge. May be equipped with a plastic liner and caps. May be used for VOAs. Reusable and easy to decontaminate.
Dipper (or “pond sampler”)	E.7.2	ASTM D 5358 ASTM D 5013 USEPA 1980	Shallow, composite	0.5 to 1.0	For sampling liquids in surface impoundments. Inexpensive. Not appropriate for sampling stratified waste if discrete characterization needed.
Discrete level sampler	E.3.5		Depth, discrete	0.2 to 0.5	Easy to decontaminate. Obtains samples from a discrete interval. Limited by sample volume and liquids containing high solids. Can be used to store and transport sample.
Displacement pumps	E.1.5	ASTM D 4448	Depth, discrete	Unlimited	Can be used for purging or sampling of wells, impoundments, or point discharges. Contact parts are made of PVC, stainless steel, or PTFE to reduce risk of contamination when trace levels or organics are of interest. Requires a power source and a large gas source. May be difficult to decontaminate (piston displacement type). May require a winch or reel to deploy.

Table 9. Device Selection Guide – Device-Specific Factors (Continued)

Sampling Device (listed in alphabetical order)	Description, Appendix E, Section	Other Device-Specific Guidance (in addition to ASTM D 6232)	Sample Type	Volume (Liters Per Pass)	Comments (For Example: Effects on Matrix, Operational Considerations, Typical Uses)
Drum thief	E.6.2	ASTM D 6063 ASTM D 5743 USEPA 1994b	Shallow, composite	0.1 to 0.5	Usually single use. If made of glass and reused, decontamination may be difficult. Limited by length of sampler, small volume of sample collected, and viscosity of fluids.
Kemmerer sampler	E.3.2		Depth, discrete	1.0 to 2.0	Recommended for lakes, ponds, large tanks or lagoons. May be difficult to decontaminate. Materials may not be compatible with sample matrix but all PTFE construction is available. Sample container exposed to media at other depths while being lowered to sample point.
Lidded sludge/water sampler	E.3.4		Discrete, composite	1.0	1-L sample jar placed into device (low risk of contamination). May sample at different depths and samples up to 40-percent solids. Equipment is heavy and limited to one bottle size.
Liquid grab sampler	E.7.3		Shallow, discrete, composite-suspended solids only	0.5 to 1.0	For sampling liquids or slurries. Can be capped and used to transport sample. Easy to use. May be lowered to specific depths. Compatibility with sample parameters is a concern.
Miniature core sampler	E.4.7	ASTM D 4547 ASTM D 6418	Discrete	0.01 to 0.05	Used to retrieve samples from surface soil, trench walls, or sub-samples from soil cores. O-rings on plunger and cap minimize loss of volatiles and allow device to be used to transport sample. Designed for single use. Cannot be used on gravel or rocky soils must avoid trapping air with samples.
Modified syringe sampler	E.4.8	ASTM D 4547	Discrete	0.01 to 0.05	Made by modifying a plastic, medical, single-use syringe. Used to collect a sample from a material surface or to sub-sample a core. The sample is transferred to a vial for transportation. Inexpensive. Must ensure device is clean and compatible with media to be sampled.

Table 9. Device Selection Guide – Device-Specific Factors (Continued)

Sampling Device (listed in alphabetical order)	Description, Appendix E, Section	Other Device-Specific Guidance (in addition to ASTM D 6232)	Sample Type	Volume (Liters Per Pass)	Comments (For Example: Effects on Matrix, Operational Considerations, Typical Uses)
Penetrating probe sampler	E.4.1	USEPA 1993c	Discrete, undisturbed	0.2 to 2.0	Used to sample soil vapor, soil, and ground water (pushed or hydraulically driven). Versatile, make samples available for onsite analysis and reduces investigation derived waste. Limited by sample volume and composition of subsurface material.
Peristaltic pump	E.1.3	ASTM D 4448 ASTM D 6063 USEPA 1996b	Shallow, discrete or composite-suspended solids only	Unlimited	Possible to collect samples from multiple depths up to 25 feet. Decontamination of pump is not required and tubing is easy to replace. Can collect samples for purgeable organics with modified equipment, but may cause loss of VOAs.
Plunger type sampler	E.6.4	ASTM D 5743	Surface or depth, discrete	0.2 to Unlimited	Made of high-density polyethylene (HDPE) or PTFE with optional glass sampling tubes. Used to collect a vertical column of liquid. Either a reusable or single use device. Decontamination may be difficult (with glass tubes).
Ponar dredge	E.2.1	ASTM D 4387 ASTM D 4342 USEPA 1994e	Bottom surface, rocky or soft, disturbed	0.5 to 3.0	One of the most effective samplers for general use on all types of substrates (silt to granular material). May be difficult to repeatedly collect representative samples. May be heavy.
Rotating coring device	E.5.2	ASTM D 5679	Surface or depth, undisturbed	0.5 to 1.0	May obtain a core of consolidated solid. Requires power and water source and is difficult to operate. Sample integrity may be affected.
Scoop	E.7.5	ASTM D 5633 ASTM D 4700 ASTM D 6063	Surface, disturbed, selective	<0.1 to 0.6	Usually for surface soil and solid waste samples. Available in different materials and simple to obtain. May bias sample because of particle size. May exacerbate loss of VOCs.
Settleable solids profiler	E.6.5		Depth, composite-suspended solids only	1.3 to 4.0	Typically used at waste water treatment plants, waste settling ponds, and impoundments to measure and sample settleable solids. Easy to assemble, reusable and unbreakable under normal use. Not recommended for caustics or high viscosity materials.

Table 9. Device Selection Guide – Device-Specific Factors (Continued)

Sampling Device (listed in alphabetical order)	Description, Appendix E, Section	Other Device-Specific Guidance (in addition to ASTM D 6232)	Sample Type	Volume (Liters Per Pass)	Comments (For Example: Effects on Matrix, Operational Considerations, Typical Uses)
Shovel	E.7.5	ASTM D 4700	Surface, disturbed	1.0 to 5.0	Used to collect surface material or large samples from waste piles. Easy to decontaminate and rugged. Limited to surface use and may exacerbate the loss of samples for VOAs.
Split barrel sampler	E.4.2	ASTM D 1586 ASTM D 4700 ASTM D 6063	Discrete, undisturbed	0.5 to 30.0	May be driven manually, or mechanically by a drill rig with trained personnel. May collect a sample at depth. A liner may be used in the device to minimize disturbance or for samples requiring VOAs.
Swing jar sampler	E.7.4		Shallow, composite	0.5 to 1.0	Used to sample liquids, powders, or small solids at a distance up to 12 feet. Adaptable to different container sizes. Not suitable for discrete samples. Can sample a wide variety of locations.
Syringe sampler	E.3.3	ASTM D 5743 ASTM D 6063	Shallow, discrete, disturbed	0.2 to 0.5	Recommended for highly viscous liquids, sludges and tar-like substances. Easy to decontaminate. Obtains samples at discrete depths but limited to length of device. Waste must be viscous enough to stay in sampler.
Thin-walled tube	E.4.5	ASTM D 1587 ASTM D 4823 ASTM D 4700	Surface or depth, undisturbed	0.5 to 5.0	Useful for collecting an undisturbed sample (depends on extension). May require a catcher to retain soil samples. Inexpensive, easy to decontaminate. Samples for VOAs may be biased when sample is extruded.
Trier	E.4.4	ASTM D 5451 ASTM D 6063	Surface, relatively undisturbed, selective	0.1 to 0.5	Recommended for powdered or granular materials or wastes in piles or in bags, drums, or similar containers. Best for moist or sticky materials. Will introduce sampling bias when used to sample coarse-grained materials.
Trowel	E.7.5	ASTM D 5633 ASTM D 4700 ASTM D 6063	Surface, disturbed, selective	0.1 to 0.6	Usually for surface soil and solid waste samples. Available in different materials and simple to obtain. May bias sample because of particle size, and may exacerbate loss of VOAs.
Valved drum sampler	E.6.3		Shallow, composite	0.3 to 1.6	Used to collect a vertical column of liquid. Available in various materials for repeat or single use. High viscosity liquids may be difficult to sample.

Table 10. Descriptions of Media Listed in Table 8.

Media	Description	Examples
Liquids -- no distinct layer of interest	Liquids (aqueous or nonaqueous) that are or are not stratified and samples from discrete intervals are not of interest. Sampling devices for this medium do not need to be designed to collect liquids at discrete depths.	Containerized leachates or spent solvents; leachates or other liquids released from a spigot or discharged from a pipe.
Liquids -- one or more distinct layers of interest	Liquids (aqueous or nonaqueous) that are stratified with distinct layers and collection of samples from discrete intervals is of interest. Sampling devices for this media do need to be designed to collect liquids at discrete depths.	Mixtures of antifreeze and used oil; light or dense non-aqueous phase liquids and water in a container, such as a tank.
Sludges or slurries	Materials that are a mixture of liquids and solids and that may be viscous or oily. Includes materials with suspended solids.	Waste water treatment sludges from electroplating; slurry created by combining solid waste incinerator ash and water.
Granular solids, unconsolidated	Solids which are not cemented, or do not require significant pressure to separate into particles, and are comprised of relatively small particles or components.	Excavated (<i>ex situ</i>) soil in a staging pile; filter press cake; fresh cement kiln dust; incinerator ash.*
Other solids, unconsolidated	Solids with larger particles than those covered by granular solids. The sampling device needs to collect a larger diameter or volume of sample to accommodate the larger particles.	Waste pellets or catalysts.

* For EPA-published guidance on the sampling of incinerator ash, see *Guidance for the Sampling and Analysis of Municipal Waste Combustion Ash for the Toxicity Characteristic* (USEPA 1995f).

Table 10. Descriptions of Media Listed in Table 8 (Continued).

Media	Description	Examples
Soil (in-situ) and other unconsolidated geologic material	Soil in its original undisturbed location or other geologic material that does not require significant pressure to separate into particles. <i>In situ</i> soil sampling may be conducted at subsurface or surface depths. Surface soils generally are defined as soils between the ground surface and 6 to 12 inches below the ground surface (USEPA 1996b); however, the definition of surface soils in State programs may vary considerably from EPA's.	Subsurface soil at a land treatment unit; surface soil contaminated by a chemical spill on top of the ground or soil near a leak from an excavated underground storage tank.*
Solids, consolidated	Cemented or otherwise dense solids that require significant physical pressure to break apart into smaller parts.	Concrete, wood, and architectural debris.
Air	For the purpose of RCRA sampling, air includes emissions from stationary sources or indoor air.	Emissions from boilers and industrial furnaces (BIFs).**
Sediment	Settled, unconsolidated solids beneath a flowing or standing liquid layer.	Sediment in a surface water body.
Soil gas or vapor	Gas or vapor phase in the vadose zone. The vadose zone is the hydrogeological region extending from the soil surface to the top of the principal water table.	Soil gas overlying a waste disposal site.
Ground water	"Water below the land surface in a zone of saturation" (40 CFR 260.10). Water can also be present below the land surface in the unsaturated (vadose) zone.	Ground water in monitoring wells surrounding a hazardous waste landfill.***

* Detailed guidance on soil sampling can be found in *Preparation of Soil Sampling Protocols: Sampling Techniques and Strategies* (Mason 1992), which provides a discussion of the advantages and disadvantages of various sample collection methods for soil.

** See Chapter Ten of SW-846 for EPA-approved methods for sampling air under RCRA.

*** Detailed guidance on ground-water sampling can be found in *RCRA Ground-Water Monitoring -- Draft Technical Guidance* (USEPA 1992c), which updates technical information in Chapter Eleven of SW-846 (Rev. 0, Sept. 1986) and the *Technical Enforcement Guidance Document* (TEGD).

7.2 Conducting Field Sampling Activities

This section provides guidance on performing field sampling activities that typically are performed during implementation of the sampling plan. Additional guidance can be found in *Waste Analysis at Facilities That Generate, Treat, Store, and Dispose of Hazardous Wastes, a Guidance Manual* (USEPA 1994a), *Environmental Investigations Standard Operating Procedures and Quality Assurance Manual, U.S. EPA Region 4, May 1996* (USEPA 1996b), other USEPA guidance cited in the reference section of this chapter, and various ASTM standards summarized in Appendix J of this guidance. See also Appendix C of EPA's *Guidance for Quality Assurance Project Plans* (USEPA 1998a). The latter document includes extensive checklists, including the following:

- Sample handling, preparation, and analysis checklist
- QAPP review checklist
- Chain-of-custody checklist.

In this section, we provide guidance on the following topics:

- Sample containers (Section 7.2.1)
- Sample preservation and holding times (Section 7.2.2)
- Documentation of field activities (Section 7.2.3)
- Field quality control samples (Section 7.2.4)
- Sample identification and chain-of-custody procedures (Section 7.2.5)
- Decontamination of equipment and personnel (Section 7.2.6)
- Health and safety (Section 7.2.7)
- Sample packaging and shipping (Section 7.2.8).

7.2.1 Selecting Sample Containers

All samples should be placed in containers of a size and construction appropriate for the volume of material specified in the sampling plan and as appropriate for the requested analyses. If sufficient sample volume is not collected, the analysis of all requested parameters and complete quality control determinations may not be possible. In addition, minimum sample volumes may be required to control sampling errors (see Section 6). Chapters Two, Three, and Four of SW-846 identify the appropriate containers for RCRA-related analyses by SW-846 methods.

Chapters Two, Three, and Four of SW-846 identify some of the appropriate containers for RCRA-related analyses by SW-846 methods.

It is important to understand that a single "sample" may need to be apportioned to more than one container to satisfy the volume and preservation requirements specified by different categories of analytical methods. Furthermore, the analytical plan may require transport of portions of a sample to more than one laboratory.

Factors to consider when choosing containers are compatibility with the waste components, cost, resistance to breakage, and volume. Containers must not distort, rupture, or leak as a result of chemical reactions with constituents of waste samples. The containers must have adequate wall thickness to withstand handling during sample collection and transport. For analysis of non-volatile constituents, containers with wide mouths are often desirable to facilitate

transfer of samples from the equipment. The containers must be large enough to contain the optimum sample volume specified in the DQO Process.

You should store samples containing light-sensitive organic constituents in amber glass bottles with Teflon®-lined lids. Polyethylene containers are not appropriate for use when the samples are to be analyzed for organic constituents because the plastics could contribute organic contaminants and potentially introduce bias. If liquid samples are to be submitted for analysis of volatile compounds, you must store the samples in air-tight containers with zero head space. You can store samples intended for metals and other inorganic constituent analyses in polyethylene containers with polyethylene-lined lids. We recommend that you consult with a chemist for further direction regarding chemical compatibility of available containers and the media to be sampled. We recommend that an extra supply of containers be available at the sampling location in case you want to collect more sample material than originally planned or you need to retain splits of each sample.²

Always use clean sample containers of an assured quality. For container cleaning procedures and additional container information, refer to the current iteration of *Specifications and Guidance for Contaminant-Free Sample Containers* (USEPA 1992d). You may wish to purchase pre-cleaned/quality assured bottles in lieu of cleaning your own bottles (USEPA 2001g).

7.2.2 Sample Preservation and Holding Times

Samples are preserved to minimize any chemical or physical changes that might occur between the time of sample collection and analysis. Preservation can be by physical means (e.g., kept at a certain temperature) or chemical means (e.g., with the addition of chemical preservatives). If a sample is not preserved properly, the levels of constituents of concern in the sample may be altered through chemical, biological, or photo-degradation, or by leaching, sorption, or other chemical or physical reactions within the sample container.

The appropriate method for preserving a sample will depend on the physical characteristics of the sample (such as soil, waste, water, etc.), the concentration of constituents in the sample, and the analysis to be performed on the sample. Addition of chemical preservatives may be required for samples to be analyzed for certain parameters. You should not chemically preserve highly concentrated samples. Samples with low concentrations, however, should be preserved. You should consult with a chemist at the laboratory regarding the addition of chemical preservatives and the possible impact on the concentration of constituents in the sample. Also, be aware that addition of some chemical preservatives to highly concentrated waste samples may result in a dangerous reaction.

Regardless of preservation measures, the concentrations of constituents within a sample can degrade over time. Therefore, you also should adhere to sample holding times (time from sample collection to analysis), particularly if the constituents of concern are volatiles in low concentrations. Analytical data generated outside of the specified holding times are considered to be minimum values only. You may use such data to demonstrate that a waste is hazardous

² For example, when inspections are conducted under Section 3007 of RCRA (42 U.S.C. § 6927), and samples are obtained, EPA must provide a split sample to the facility, upon request.

where the value of a constituent-of-concern is above the regulatory threshold, but you cannot use the data to demonstrate that a waste is not hazardous. Exceeding a holding time when the results are above a decision level does not invalidate the data.

Appropriate sample preservation techniques and sample holding times for aqueous matrices are listed in Chapters Two, Three, and Four of SW-846. You should also consult the methods to be used during analysis of the sampled waste. In addition, *Standard Guide for Sampling Waste and Soil for Volatile Organic Compounds* (ASTM D 4547-98) provides information regarding the preservation of volatile organic levels in waste and soil samples.

7.2.3 Documentation of Field Activities

This section provides guidance on documenting field activities. Records of field activities should be legible, identifiable, retrievable and protected against damage, deterioration, and loss. You should record all documentation in waterproof, non-erasable ink. If you make an error in any of these documents, make corrections by crossing a single line through the error and entering the correct information adjacent to it. The corrections should then be initialed and dated. Stick-on labels of information should not be removable without evidence of the tampering. Do not put labels over previously recorded information.

Keep a dedicated logbook for each sampling project with the name of the project leader, team members, and project name written inside the front cover. Document all aspects of sample collection and handling in the logbook. Entries should be legible, accurate, and complete. The language should be factual and objective.

You also should include information regarding sample collection equipment (use and decontamination), field analytical equipment and the measurements, calculations and calibration data, the name of the person who collected the sample, sample numbers, sample location description and diagram or map, sample description, time of collection, climatic conditions, and observations of any unusual events. Document the collection of QC samples and any deviations from procedural documents, such as the QAPP and SOPs.

When videos, slides, or photographs are taken, you should number them to correspond to logbook entries. The name of the photographer, date, time, site location, and site description should be entered sequentially into the logbook as photos are taken. A series entry may be used for rapid aperture settings and shutter speeds for photographs taken within the normal automatic exposure range. Special lenses, films, filters, or other image enhancement techniques must be noted in the logbook. Chain-of-custody procedures for photoimages depend on the subject matter, type of film, and the processing it requires. Adequate logbook notations and receipts may be used to account for routine film processing. Once developed, the slides or photographic prints should be serially numbered corresponding to the logbook descriptions and labeled (USEPA 1992e).

7.2.4 Field Quality Control Samples

Quality control samples are collected during field studies to monitor the performance of sample collection and the risk of sampling bias or errors. Field QC samples could include the following:

Equipment blank: A rinse sample of the decontaminated sampling equipment using organic/analyte free water under field conditions to evaluate the effectiveness of equipment decontamination or to detect sample cross contamination.

Trip blank: A sample prepared prior to the sampling event and stored with the samples throughout the event. It is packaged for shipment with the samples and not opened until the shipment reaches the laboratory. The sample is used to identify any contamination that may be attributed to sample handling and shipment.

Field blank: A sample prepared in the field using organic/analyte free water to evaluate the potential for contamination by site contaminants not associated with the sample collected (e.g., airborne organic vapors)

Field split sample: Two or more representative portions taken from the same sample and submitted for analysis to different laboratories. Field split samples are used to estimate interlaboratory precision.

In addition to collecting field QC samples, other QC procedures include sample storage, handling, and documentation protocols. These procedures are covered separately in the following sections. In addition, Chapter One of SW-846, entitled "Quality Control", contains guidance regarding both field and laboratory QA/QC. We also recommend reviewing the following for information on field QA/QC:

- *EPA Guidance for Quality Assurance Project Plans (USEPA 1998a)*
- *Standard Practice for Generation of Environmental Data Related to Waste Management Activities: Quality Assurance and Quality Control Planning and Implementation (ASTM D 5283-92).*

7.2.5 Sample Identification and Chain-of-Custody Procedures

You should identify samples for laboratory analysis with sample tags or labels. An example of a sample label is given in Figure 29.

Typically, information on the sample label should include the sample identification code or number, date, time of collection, preservative used, media, location, initials of the sampler, and analysis requested. While not required, you may elect to seal each sample container with a custody seal (Figure 30).

You should use chain-of-custody procedures to record the custody of the samples. Chain-of-custody is the custody of samples from time of collection through shipment to analysis. A sample is in one's custody if:

[Name of Sampling Organization]	
Sample Description _____ _____	
Plant: _____	Location: _____
Date: _____	_____
Time: _____	_____
Media: _____	Station: _____
Sample Type: _____	Preservative: _____
Sampled By: _____	
Sample ID No.: _____	

Figure 29. Sample label

- It is in the actual possession of an investigator
- It is in the view of an investigator, after being in their physical possession
- It is in the physical possession of an investigator, who secures it to prevent tampering
- It is placed in a designated secure area.

 UNITED STATES ENVIRONMENTAL PROTECTION AGENCY OFFICIAL SAMPLE SEAL	SAMPLE No.	DATE	SEAL BROKEN BY	DATE	EPA FORM 1600-2(R7-76)
	SIGNATURE				
	PRINT NAME AND TITLE (<i>INSPECTOR, ANALYST or TECHNICIAN</i>)				

Figure 30. Custody seal

All sample sets should be accompanied by a chain-of-custody form. This record also serves as the sample logging mechanism for the laboratory sample custodian. Figure 31 illustrates the content of a chain-of-custody form. When the possession of samples is transferred, both the individual relinquishing the samples and the individual receiving the samples should sign, date, and note the time on the chain-of-custody document. If you use overnight shipping service to transport the samples, record the air bill number on the chain-of-custody form. This chain-of-custody record represents the official documentation for all transfers of the sample custody until the samples have arrived at the laboratory. The original form of the chain-of-custody record should accompany each shipment. A copy should be retained by a representative of the sampling team.

When sample custody is transferred between individuals, the samples or coolers containing the samples are sealed with a custody seal. This seal cannot be removed or broken without destruction of the seal, providing an indicator that custody has been terminated.

EPA's Superfund Program has developed software called *Field Operations and Records Management System (FORMS) II Lite™* that automates the printing of sample documentation in the field, reduces time spent completing sample collection and transfer documentation, and facilitates electronic capture of data prior to and during field sampling activities. For information on *FORMS II Lite™*, see <http://www.epa.gov/superfund/programs/clp/f2lite.htm>.

For additional information on chain-of-custody procedures, we recommend ASTM D 4840, *Standard Guide for Sampling Chain-of-Custody Procedures*.

7.2.6 Decontamination of Equipment and Personnel

Decontamination of sampling equipment refers to the physical and chemical steps taken to remove any chemical or material contamination. Equipment decontamination helps prevent sampling bias. All equipment that comes in contact with the sampled material should be free of components that could influence (contaminate) the true physical or chemical composition of the material. Besides the equipment used to collect the samples, any containers or equipment used for sample compositing or for field subsampling should be free of contamination.

Equipment decontamination also prevents cross-contamination of samples when the equipment is used to collect more than one sample. Disposable equipment or the use of dedicated equipment provides the most effective means of avoiding cross-contamination; however, the use of such equipment is not always practical.

You should decontaminate equipment to a level that meets the minimum requirements for your data collection effort. Your decontamination steps (e.g., use of solvents versus use of only soap and water), therefore, should be selected based on the constituents present, their concentration levels in the waste or materials sampled, and their potential to introduce bias in the sample analysis results if not removed from the sampling equipment. You should describe the project-specific decontamination procedures in your planning document for the sampling effort. In addition, items used to clean the equipment, such as bottle brushes, should be free of contamination.

The following procedure is an example of one you could use to decontaminate a sampling device to be used for collecting samples for trace organic or inorganic constituent analyses (from USEPA 1996b):

1. Clean the device with tap water and soap, using a brush if necessary to remove particulate matter and surface films.
2. Rinse thoroughly with tap water.
3. Rinse thoroughly with analyte- or organic-free water.
4. Rinse thoroughly with solvent. Do not solvent-rinse PVC or plastic items.
5. Rinse thoroughly with organic/analyte free water, or allow equipment to dry completely.
6. Remove the equipment from the decontamination area. Equipment stored overnight should be wrapped in aluminum foil and covered with clean, unused plastic.

The specifications for the cleaning materials are as follows (you should justify and document the use of substitutes):

- "Soap" should be a phosphate-free laboratory detergent such as Liquinox®. It must be kept in clean plastic, metal, or glass containers until used and poured directly from the container when in use.

- "Solvent" should be pesticide-grade isopropanol. It must be stored in the unopened original containers until used. It may be applied using the low pressure nitrogen system fitted with a Teflon® nozzle, or using Teflon® squeeze bottles. For equipment highly contaminated with organics (such as oily waste), a laboratory-grade hexane may be a more suitable alternative to isopropanol.
- "Tap water" may be used from any municipal water treatment system. Use of an untreated potable water supply is not an acceptable substitute. Tap water may be kept in clean tanks, hand pressure sprayers, squeeze bottles, or applied directly from a hose or tap.
- "Analyte free water" (deionized water) is tap water treated by passing it through a standard deionizing resin column. At a minimum, it must contain no detectable heavy metals or other inorganic compounds as defined by a standard ICP (or equivalent) scan. It may be obtained by other methods as long as it meets the analytical criteria. Analyte free water must be stored in clean glass, stainless steel, or plastic containers that can be closed prior to use. It can be applied from plastic squeeze bottles.
- "Organic/analyte free water" is tap water that has been treated with activated carbon and deionizing units. A portable system to produce such water under field conditions is available. At a minimum, the water must meet the criteria of analyte free water and not contain detectable pesticides, herbicides, or extractable organic compounds, and no volatile organic compounds above minimum detectable levels as determined for a given set of analyses. Organic/analyte free water obtained by other methods is acceptable, as long as it meets the analytical criteria. It must be stored in clean glass, Teflon®, or stainless steel containers. It may be applied using Teflon® squeeze bottles or with the portable system.

Clean the field equipment prior to field use. Designate a decontamination zone at the site and, if necessary, construct a decontamination pad at a location free of surface contamination. You should collect wastewater from decontamination (e.g., via a sump or pit) and remove it frequently for appropriate treatment or disposal. The pad or area should not leak contaminated water into the surrounding environment. You also should collect solvent rinses for proper disposal.

You should always handle field-cleaned equipment in a manner that prevents recontamination. For example, after decontamination but prior to use, store the equipment in a location away from the cleaning area and in an area free of contaminants. If it is not immediately reused, you should cover it with plastic or aluminum foil to prevent recontamination.

Decontamination will generate a quantity of wastes called investigation derived waste (IDW). You should address the handling and disposal of IDW in your sampling plan. You must handle this material in accordance with whether it is nonhazardous or suspected of, or known to be, hazardous. You should minimize the generation of hazardous IDW and keep it separated from nonhazardous IDW. For example, you should control the volume of spent solvents during equipment decontamination by applying the minimum amount of liquid necessary and capturing

it separately from the nonhazardous washwater. For additional guidance on handling IDW, see *Management of Investigation-Derived Wastes* (USEPA 1992f).

Decontamination of personnel and their protective gear also is often necessary during hazardous waste sampling. This important type of decontamination protects personnel from chemical exposure and prevents cross-contamination when personnel change locations. The level or degree of such decontamination will depend on site-specific considerations, such as the health hazards posed by exposure to the sampled waste. You should address these decontamination procedures in your health and safety plan.

For additional information regarding decontamination, see ASTM D 5088, *Standard Practice for Decontamination of Field Equipment Used at Nonradioactive Waste Sites*. Another source of additional information is "Sampling Equipment Decontamination" (USEPA 1994f), issued by EPA's Environmental Response Team.

7.2.7 Health and Safety Considerations

Regulations published by the Occupational Safety and Health Administration (OSHA) at 29 CFR Part 1910.120 govern workers at hazardous waste sites and include requirements for training, equipment, medical monitoring, and other practices. Many sampling activities covered by this guidance may require compliance with OSHA's health and safety regulations. Specific guidance on worker health and safety is beyond the scope of this chapter; however, development and use of a project-specific health and safety plan may be required. It is the responsibility of the sampling team leader and others in charge to ensure worker safety.

Some important health and safety considerations follow:

- Field personnel should be up-to-date in their health and safety training.
- Field personnel should have a medical examination at the initiation of sampling activities and routinely thereafter, as appropriate and as required by the OSHA regulations. Unscheduled examinations should be performed in the event of an accident or suspected exposure to hazardous materials.
- Staff also should be aware of the common routes of exposure at a site and be instructed in the proper use of safety equipment and protective clothing and equipment. Safe areas should be designated for washing, drinking, and eating.
- To minimize the impact of an emergency situation, field personnel should be aware of basic first aid and have immediate access to a first aid kit.

The guidance manual *Occupational Safety and Health Guidance Manual for Hazardous Waste Site Activities* (OSHA 1985, revised 1998) was jointly developed by the National Institute for Occupational Safety and Health (NIOSH), OSHA, the United States Coast Guard (USCG), and EPA. Its intended audience is those who are responsible for occupational safety and health programs at hazardous waste sites.

7.2.8 Sample Packaging and Shipping

During transport of waste samples, you should follow all State and Federal regulations governing environmental sample packaging and shipment and ship according to U.S. Department of Transportation (DOT) and International Air Transportation Association (IATA) regulations. Minimum guidelines for sample packaging and shipping procedures follow in the next subsections; however, the rules and regulations for sample packaging and shipping are complex, and for some samples and shipping situations the procedures outlined below may need to be exceeded.

7.2.8.1 Sample Packaging

You should package and label samples in an area free of contamination. You also should ship or transport samples to a laboratory within a time frame that meets recommended sample holding times for the respective analyses. Additional guidelines follow:

- Aqueous samples for inorganic analysis and volatile organic analysis may require chemical preservation. The specific preservation requirements will depend on the analytical method to be used.
- Make sure all lids/caps are tight and will not leak.
- Make sure sample labels are intact and covered with a piece of clear tape for protection.
- Enclose the sample container in a clear plastic bag and seal the bag. Make sure the sample labels are visible. If bubble wrap or other wrapping material will be placed around the labeled containers, write the sample number and fraction (e.g., "BLH01-VOCs") so that it is visible on the outside of the wrap, then place the wrapped container in a clear plastic bag and seal the bag.
- Make sure that all samples that need to be kept cold (4 ± 2 °C) have been thoroughly cooled before placing in packing material so that the packing material serves to insulate the cold. Change the ice prior to shipment as needed. Ideally, pack the cooled samples into shipping containers that have already been chilled. (Of course, these precautions are not necessary if none of the samples in the shipping container need to be kept cold.)
- Any soil/sediment samples suspected to be of medium/high concentration or containing dioxin must be enclosed in a metal can with a clipped or sealable lid (e.g., paint cans) to achieve double containment of those samples. Place suitable absorbent packing material around the sample container in the can. Make sure the sample is securely stored in a can and the lid is sealed. Label the outer metal container with the sample number and fraction of the sample inside.
- Use *clean* waterproof metal or hard plastic ice chests or coolers that are in good repair for shipping samples.
- Remove the inapplicable previous shipping labels. Make sure any drain plugs

are shut. Seal plugs shut on the inside and outside with a suitable tape such as duct tape. Line the cooler with plastic (e.g., large heavy-duty garbage bag) before inserting samples.

- Ship samples at 4 ± 2 °C, place double-bagged ice on top of samples. Ice must be sealed in double plastic bags to prevent melting ice from soaking the packing material. Loose ice should not be poured into the cooler.
- Conduct an inventory of sample numbers, fractions, and containers when placing samples into the coolers. Check the inventory against the corresponding chain-of-custody form before sealing the cooler to make sure that all samples and containers are present.
- Pack the lined shipping containers with noncombustible absorbent packing material, such as vermiculite or rock wool. Place the packing material on the bottom of the shipping container (inside the plastic liner) and around sample bottles or metal cans to avoid breakage during shipment. Never use earth, ice, paper, or styrofoam to pack samples. Earth is a contaminant, melted ice may cause complications and allow the sample containers to bang together when the shipping container is moved, and styrofoam presents a disposal problem (it also may easily blow out of the shipping container at the site).
- For samples that need to be shipped at 4 ± 2 °C, place double-bagged ice on top of samples and fill remaining space with packing material. If sample bottles have been protected with packaging material such as bubble wrap, then some double-bagged ice or ice packs also may be placed between samples.
- Use tape to securely fasten the top of the plastic used to line the shipping container. It is a good idea to then place a completed custody seal around the top of the bag that contains the sample in case the outer seals placed across the cooler lid are inadvertently damaged during shipment.
- Enclose all sample documentation (i.e., chain-of-custody forms and cooler return shipping documents) in a waterproof plastic bag, and tape the bag to the underside of the cooler lid. This documentation should address all samples in the cooler, but not address samples in any other cooler.
- If more than one cooler is being used, place separate sample documentation in each cooler. Instructions for returning the cooler should be documented inside the cooler lid. Write a return name and address for the sample cooler on the inside of the cooler lid in permanent ink to ensure return of the cooler.
- Tape the cooler shut using strapping tape over the hinges. Place completed custody seals across the top and sides of the cooler lid so that lid cannot be opened without breaking the seal.
- Place clear tape over the seal to prevent inadvertent damage to the seal during shipment. Do not place clear tape over the seals in a manner that would allow the seals to be lifted off with the tape and then reattached without breaking the

seal.

For additional detailed guidance on sample documentation, packaging, and shipping, we recommend the *Contract Laboratory Program (CLP) Guidance for Field Samplers - Draft Final* (USEPA 2001g).

7.2.8.2 Sample Shipping

In general, samples of drinking water, most ground waters and ambient surface waters, soil, sediment, treated waste waters, and other low concentration samples can be shipped as environmental samples; however, shipment of high concentration waste samples may require shipment as dangerous goods (not as “hazardous waste”). Note that RCRA regulations specifically exempt samples of hazardous waste from RCRA waste identification, manifest, permitting, and notification requirements (see 40 CFR §261.4(d)). The shipment of samples to and from a laboratory, however, must comply with U.S. DOT, U.S. Postal Service, or any other applicable shipping requirements. If a sample is a hazardous waste, once received at the laboratory, it must be managed as a hazardous waste.

In recent years, commercial overnight shipping services have adopted the regulations of the IATA for shipment of dangerous goods by air. The IATA Dangerous Goods Regulations contain all provisions mandated by the International Civil Aviation Organization and all rules universally agreed to by airlines to correctly package and safely transport dangerous goods by air. Contact IATA for a copy of the IATA Dangerous Goods Regulations and for assistance in locating suppliers of specialized packaging for dangerous goods.

For information on shipping dangerous goods visit the International Air Transport Association (IATA) Dangerous Goods Information Online at <http://www.iata.org/cargo/dg/index.htm> or call 1-800-716-6326.

When shipping samples, perform the following activities:

- Clearly label the cooler and fill out appropriate shipping papers.
- Place return address labels clearly on the outside of the cooler.
- If more than one cooler is being shipped, mark each cooler as "1 of 2," "2 of 2," etc.
- Ship samples through a commercial carrier. Use appropriate packaging, mark and label packages, and fill out all required government and commercial carrier shipping papers according to DOT and IATA commercial carrier regulations.
- Ship all samples by overnight delivery in accordance with DOT and IATA regulations.

7.3 Using Sample Homogenization, Splitting, and Subsampling Techniques

7.3.1 Homogenization Techniques

The objective of homogenization (mixing) is to minimize grouping and segregation of particles so they are randomly distributed within the sample. While homogenization can reduce grouping and segregation of particles, it will not eliminate it and will not make the material “homogeneous.” If homogenization is successful, subsamples of the homogenized material will show less variability than if the material was not homogenized. Homogenization, combined with a composite sampling strategy, can be an efficient method for improving the accuracy and precision in sampling of particulate material (Jenkins, et al. 1996). Homogenization can be applied to solids, liquids, slurries, and sludges.

Pitard (1993) recognizes two processes for homogenization:

Stationary processes - in which the material is not mixed but is redistributed so that any correlation between the characteristics of individual fragments or particles is lost or minimized. An example of this process is the collection of many small increments to form an individual sample (ideally we would pick many individual particles at random to form the sample, but this is not possible).

Dynamic processes - in which the material is mechanically mixed to remove or minimize correlation between the characteristics of the fragment or particle and its position within the sample. Examples of this process include mechanical mixing within a container and use of magnetic stirrers in a beaker.

Note that the benefits of homogenization may be temporary because gravity-induced segregation can occur during shipment, storage, and handling of samples. For this reason, consider carrying out homogenization (mixing) immediately prior to analysis.

Some homogenization techniques work better than others. The strengths and limitations of homogenization equipment and procedures (cone and quartering, riffle splitters, rotary splitters, multiple cone splitters, and V-blenders) have been reviewed in the literature by Pitard (1993), Schumacher, et al. (1991), ASTM (Standard D 6051-96), and others. The preferred techniques for use within the laboratory follow:

- Riffing (see also Section 7.3.2)
- Fractional shoveling (see also Section 7.3.2)
- Mechanical mixing
- Cone and quartering
- Magnetic stirrers (e.g., to homogenize the contents of an open beaker)
- V-blenders.

Fractional shoveling and mechanical mixing also can be used in the field. Note that some techniques for homogenization, such as riffing and fractional shoveling, also are used for splitting and subsampling. Note that Pitard (1993) discourages the use of “sheet mixing” (also called “mixing square”) and vibratory spatulas because they tend to segregate particles of different density and size.

7.3.2 Sample Splitting

Splitting is employed when a field sample is significantly larger than the required analytical sample. The goal of splitting is to reduce the mass of the retained sample and obtain an aliquot of the field sample that reflects the average properties of the entire field sample. It is often necessary to repeat the splitting process a number of times to achieve a sufficient reduction in mass for analytical purposes.

Splitting can be used to generate a reduced mass aliquot that can be analyzed in its entirety or a much reduced and homogenized mass from which an analytical or subsample can be collected. ASTM's *Standard Guide for Laboratory Subsampling of Media Related to Waste Management Activities* (ASTM D 6323-98), lists and discusses a variety of splitting equipment (such as sectorial splitters and riffle splitters) and splitting procedures (such as cone and quartering and the alternate scoop method). Gerlach, et al. (2002) also evaluated sample splitting methods (riffle splitting, paper cone riffle splitting, fractional shoveling, coning and quartering, and grab sampling) and found that riffle splitting methods performed the best.

A simple alternative to riffle splitting a sample of solid media is a technique called "fractional shoveling." To perform fractional shoveling, deal out small increments from the larger sample in sequence into separate piles, randomly select one of the piles and retain it as the subsample (or retain more than one if a portion of the sample is to be "split" with another party and/or retained for archive purposes), and reject the others (see Figure 32).

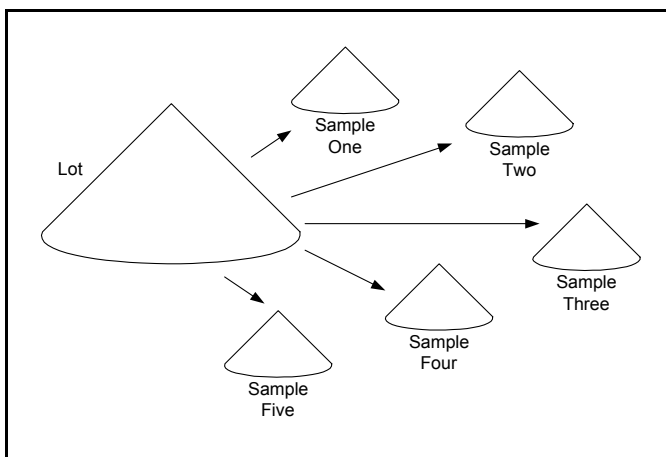

Figure 32. Fractional shoveling as a sample splitting method (after Pitard 1993)

7.3.3 Subsampling

The size of the sample submitted to the laboratory (either an individual sample or a composite) by field personnel typically far exceeds that required for analysis. Consequently, subsampling is needed. A subsample is defined as "a portion of material taken from a larger quantity for the purpose of estimating properties or the composition of the whole sample" (ASTM D 4547-98). Taking a subsample may be as simple as collecting the required mass from a larger mass, or it may involve one or more preparatory steps such as grinding, homogenization, and/or splitting of the larger mass prior to removal of the subsample.

Specific procedures for maintaining sample integrity (e.g., minimizing fundamental error) during splitting and subsampling operations typically are not addressed in quality assurance, sampling, or analytical plans, and error may be introduced unknowingly in subsampling and sample preparation. Many environmental laboratories do not have adequate SOPs for subsampling; therefore, it is important for the data users to provide the laboratory personnel clear instruction if any special subsampling or sample handling procedures are needed (such as instructions on mixing of the sample prior to analysis, removing particles greater than a certain size, analyzing

phases separately, etc.). If proper subsampling procedures are not specified in planning documents, SOPs, or documents shipped with the samples, it may be difficult to assess the usability of the results.

The following sections provide general guidance on obtaining subsamples of liquids, mixtures of liquids and solids, and soils and solid media. For additional guidance and detailed procedures, see *Standard Guide for Composite Sampling and Field Subsampling for Environmental Waste Management Activities* (ASTM D 6051-96) and *Standard Guide for Laboratory Subsampling of Media Related to Waste Management Activities* (ASTM D 6323-98).

7.3.3.1 *Subsampling Liquids*

In the case of subsampling a liquid, special precautions may be warranted if the liquid contains suspended solids and/or the liquid comprises multiple liquid phases. In practice, samples may contain solids and/or separate phases that are subject to gravitational action (Gy 1998). Even a liquid that appears clear (absent of solids and without iridescence) may not be “homogeneous.”

Subsampling of liquids (containing solids and/or in multiple phases) can be addressed by using one or the other of two possible approaches:

- Mixing the sample such that all phases are homogenized, and then taking a subsample (using a pipette, for example)
- Allowing all of the phases to separate followed by subsampling and analysis of each phase separately.

Of course, the characteristics of the waste and the type of test must be considered. For example, mixing of multi-phasic wastes to be analyzed for volatiles should be avoided due to the potential loss of constituents. Some multi-phasic liquid wastes can form an emulsion when mixed. Others, in spite of mixing, will quickly separate back into distinct phases.

7.3.3.2 *Subsampling Mixtures of Liquids and Solids*

If the sample is a mixture of liquids and solids, subsampling usually requires that the phases be separated. The separate phases are then separately subsampled. Subsampling of the liquid phase can be accomplished as described above, while subsampling of the solid phase should be done according to sampling theory, as summarized below.

7.3.3.3 *Subsampling Soils and Solid Media*

To correctly subsample soil or solid media, use sampling tools and techniques that minimize delimitation and extraction error. If the particles in the sample are too coarse to maintain fundamental error within desired limits, it may be necessary to perform a series of steps of particle size reduction followed by subsampling (see Appendix D). If the field sample mass is equal to or less than the specified analytical size, the field sample can be analyzed in its entirety. If the mass of the field sample is greater than the specified analytical sample size, subsampling will be required.

One possible alternative to particle-size reduction prior to subsampling is to simply remove the

coarse particles (e.g., via a sieve or visually) from the sample. This selective removal technique is *not* recommended in situations in which the larger particles contribute to the overall concentration of the constituent of concern in the waste. In other words, do not remove the large particles if the constituents of concern tend to be concentrated in the large particles relative to the smaller particles.

If the largest particle size of the field sample exceeds the allowable size for maintaining the fundamental error specified by the DQO *and* the analyte of interest is volatile, it may be necessary to analyze the sample as is and accept a large fundamental error. Guidance on handling VOCs in samples can be found in Section 6.3.4 and in ASTM Standard D 4547-98.

The *Standard Guide for Laboratory Subsampling of Media Related to Waste Management Activities* (ASTM D 6323-98) lists a variety of equipment for performing particle-size reduction (e.g., cutting mills, jar mills, disc mills, dish and puck mills, mortar grinders and jaw crushers) and tabulates their uses and limitations.

The techniques discussed below are most relevant to subsampling of solid particulate matter for analysis of nonvolatile constituents. Mason (1992, page 5-7) provides a field procedure that can be used to reduce the volume of a field soil sample for submission to the laboratory.

The issues regarding the subsampling of particulate-containing materials are identical to those considered when collecting the original field samples and are as follows:

- The tool used to collect the analytical sample must be correct and not discriminate against any portion of the sample (in other words, the tool should not introduce increment delimitation and increment extraction errors).
- The mass of the subsample must be enough to accommodate the largest of the particles contained within the parent sample (to reduce fundamental error).
- The sample mass and the manner in which it is collected must accommodate the short-term heterogeneity within the field sample (to reduce grouping and segregation error).

The sampling tool must be constructed such that its smallest dimension is at least three times greater than the largest particle size contained within the material being subsampled. The construction of the sampling tool must be such that it does not discriminate against certain areas of the material being sampled. For example, Pitard (1993) argues that all scoops for subsampling should be rectangular or square in design with flat bottoms as opposed to having curved surfaces (Figure 33).

Pitard (1993) and ASTM D 6323-98 suggest

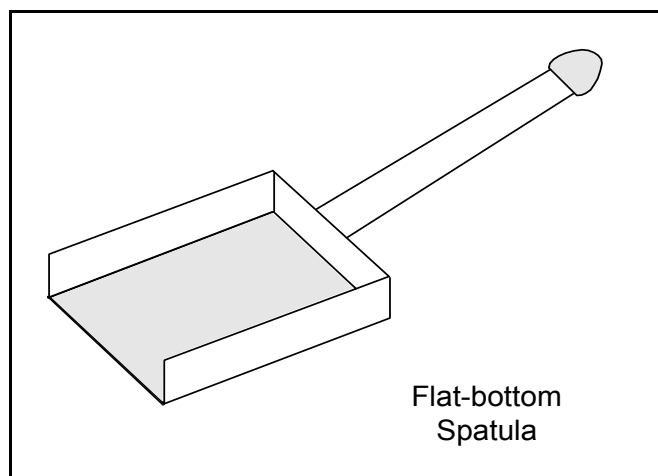

Figure 33. Example of correctly designed device for subsampling. Flat bottom and vertical side walls minimize increment delimitation error.

subsampling from relatively flat elongated piles using a transversal subsampling technique that employs a sampling scoop or spatula and a flat working surface (Figure 34(a)). The objective is to convert the sampling problem to a one-dimensional approach. Specifically, Pitard (1993) recommends the following procedure:

- Empty the sample from the sample container onto a smooth and clean surface or appropriate material.
- Do not try to homogenize the sample, as this may promote segregation of particles.
- Reduce the sample by using the fractional shoveling technique (Figure 32) until a sample 5 to 10 times larger than the analytical sample is obtained.
- Shape the remaining material into an elongated pile with uniform width and thickness (Figure 34(a)).
- Take increments all across the pile through the entire thickness.
- Reshape the pile perpendicular to its long axis, and continue to take increments across the pile until the appropriate sample weight is reached.

Fractional shoveling and alternate scoop techniques alone (Figure 32) also can be used to generate subsamples.

When using these techniques, several stages or iterations of subsampling followed by particle size reduction may be needed to minimize fundamental error (also see Appendix D). At each stage, the number of increments should be at least 10 and preferably 25 to control grouping and segregation (short-term heterogeneity) within the sample. In the final stage, however, where very small analytical samples are required, the number of increments required will be much less.

The subsampling procedures described above offer a more correct and defensible alternative to an approach to subsampling in which the analyst simply opens the sample jar or vial and removes a small increment from the top for preparation and analysis (Figure 34(b)).

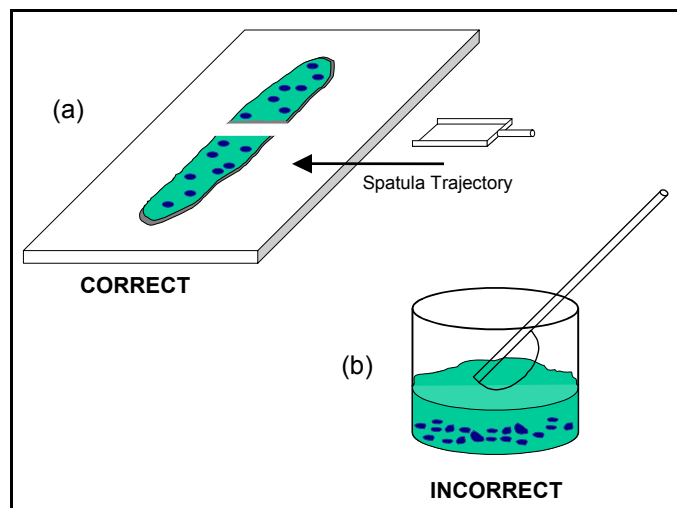

Figure 34. Correct (a) and incorrect (b) laboratory techniques for obtaining subsamples of granular solid media ((a) modified after Pitard 1993).

8 ASSESSMENT: ANALYZING AND INTERPRETING DATA

This section presents guidance for the assessment of sampling and analytical results. In performing data assessment, evaluate the data set to determine whether the data are sufficient to make the decisions identified in the DQO Process. The data assessment process includes (1) sampling assessment and analytical assessment, and (2) data quality assessment (DQA) (Figure 35) and follows a series of logical steps to determine if the data were collected as planned and to reach conclusions about a waste relative to RCRA requirements.

At the end of the process, EPA recommends reconciliation with the DQOs to ensure that they were achieved and to decide whether additional data collection activities are needed.

8.1 Data Verification and Validation

Data verification and validation are performed to ensure that the sampling and analysis protocols specified in the QAPP or WAP were followed and that the measurement systems performed in accordance with the criteria specified in the QAPP or WAP. The process is divided into two parts:

- sampling assessment (Section 8.1.1), and
- analytical assessment (Section 8.1.2).

Guidance on analytical assessment is provided in Chapter One of SW-846 and in the individual analytical methods. Additional guidance can be found in *Guidance on Environmental Data Verification and Data Validation EPA QA/G-8*, published by EPA's Office of Environmental Information (USEPA 2001c). For projects generating data for input into risk assessments, see EPA's *Guidance for Data Usability in Risk Assessment, Final* (USEPA 1992g).

8.1.1 Sampling Assessment

Sampling assessment is the process of reviewing field sampling and sample handling methods to check conformance with the requirements specified in the QAPP. Sampling assessment activities include a review of the sampling design, sampling methods, documentation, sampling handling and custody procedures, and preparation and use of quality control samples.

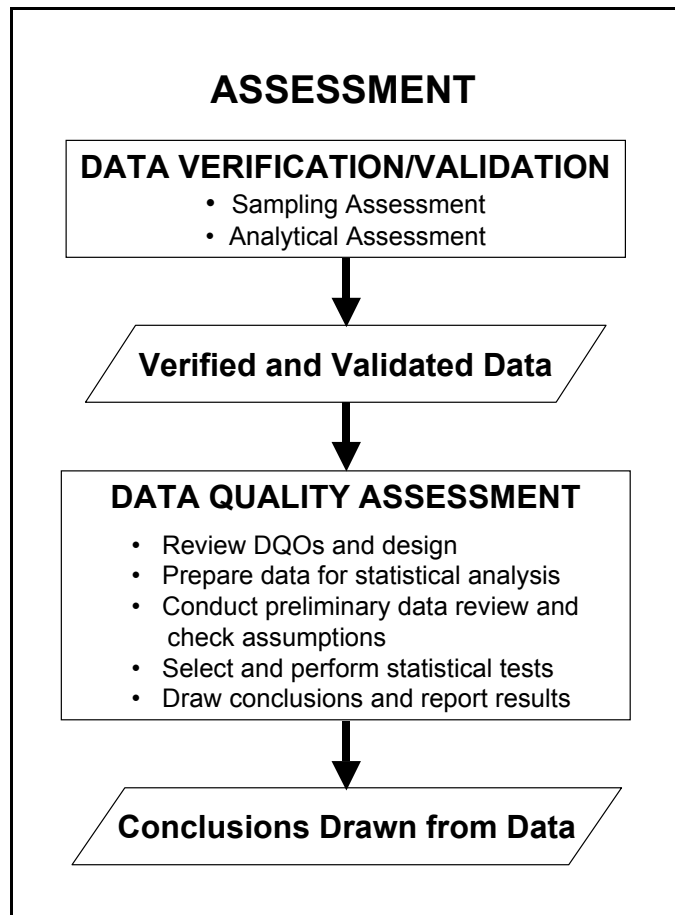

Figure 35. Elements of the quality assurance assessment process (modified after USEPA 1998a)

The following types of information are useful in assessing the sampling activity:

- Copies of the sampling plan, QAPP, and SOPs.
- Copies of logbooks, chain-of-custody records, bench sheets, well logs, sampling sequence logs, field instrument calibration records and performance records, and/or other records (including electronic records such as calculations) that describe and/or record all sampling operations, observations, and results associated with samples (including all QC samples) while in the custody of the sampling team. Records/results from the original sampling and any resampling, regardless of reason, should be retained. Also, retain copies of the shipping manifest and excess sample disposition (disposal) records describing the ultimate fate of any sample material remaining after submission to the laboratory.
- Copies of all records/comments associated with the sample team review of the original data, senior staff review, and QA/QC review of the sampling activity. Copies of any communication (telephone logs, faxes, E-mail, other records) between the sampling team and the customer dealing with the samples and any required resampling or reporting should be provided.

The following subsections outline the types of sampling information that should be assessed.

8.1.1.1 *Sampling Design*

Review the documentation of field activities to check if the number and type of samples called for in the sampling plan were, in fact, obtained and collected from the correct locations. Perform activities such as those described below:

- **Sampling Design:** Document any deviations from the sampling plan made during the field sampling effort and state what impact those modifications might have on the sampling results.
- **Sample Locations/Times:** Confirm that the locations of the samples in time or space match those specified in the plan.
- **Number of Samples:** Check for completeness in the sampling in terms of the number of samples obtained compared to the number targeted. Note the cause of the deficiencies such as structures covering planned locations, limited access due to unanticipated events, samples lost in shipment or in the laboratory, etc.
- **Discrete versus Composite Samples:** If composite sampling was employed, confirm that each component sample was of equal mass or volume. If not, determine if sufficient information is presented to allow adjustments to any calculations made on the data. Both field and laboratory records should be reviewed because compositing can occur at either location.

8.1.1.2 *Sampling Methods*

Details of how a sample was obtained from its original time/space location are important for properly interpreting the measurement results. Review the selection of sampling and ancillary equipment and procedures (including equipment decontamination) for compliance with the QAPP and sampling theory. Acceptable departures (for example, alternate equipment) from the QAPP and the action to be taken if the requirements cannot be satisfied should be specified for each critical aspect. Note potentially unacceptable departures from the QAPP and assess their potential impact on the quality and usefulness of the data. Comments from field surveillance on deviations from written sampling plans also should be noted.

Sampling records should be reviewed to determine if the sample collection and field processing were appropriate for the analytes being measured. For example, sampling for volatiles analysis poses special problems due to the likely loss of volatiles during sample collection. Also, determination of the appropriate “sample support” should be reviewed, whether it was obtained correctly in the field, whether any large particles or fragments were excluded from the sample, and whether any potential biases were introduced.

Laboratory subsampling and sample preparation protocols should be examined for the same types of potential bias as the field procedures. When found, they should be discussed in the assessment report.

8.1.1.3 *Sample Handling and Custody Procedures*

Details of how a sample is physically treated and handled between its original site or location and the actual measurement site are extremely important. Sample handling activities should be reviewed to confirm compliance with the QAPP or WAP for the following areas:

- Sample containers
- Preservation (physical and chemical)
- Chain-of-custody procedures and documentation
- Sample shipping and transport
- Conditions for storage (before analysis)
- Holding times.

8.1.1.4 *Documentation*

Field records generally consist of bound field notebooks with prenumbered pages, sample collection forms, sample labels or tags, sample location maps, equipment maintenance and calibration forms, chain-of-custody forms, sample analysis request forms, and field change request forms. Documentation also may include maps used to document the location of sample collection points or photographs or video to record sampling activities.

Review field records to verify they include the appropriate information to support technical

interpretations, judgments, and discussions concerning project activities. Records should be legible, identifiable, and retrievable and protected against damage, deterioration, or loss. Especially note any documentation of deviations from SOPs and the QAPP.

8.1.1.5 Control Samples

Assess whether the control samples were collected or prepared as specified in the QAPP or WAP. Control samples include blanks (e.g., trip, equipment, and laboratory), duplicates, spikes, analytical standards, and reference materials that are used in different phases of the data collection process from sampling through transportation, storage, and analysis. There are many types of control samples, and the appropriate type and number of control samples to be used will depend on the data quality specifications.

See Section 7.2.4 for guidance on the type of control samples for RCRA waste-testing programs. Additional guidance on the preparation and use of QC samples can be found in the following publications:

- *Test Methods for Evaluating Solid Waste, SW-846* (USEPA 1986a), Chapter One
- *EPA Guidance for Quality Assurance Project Plans, EPA QA/G-5* (USEPA 1998a), Appendix D
- *Contract Laboratory Program (CLP) Guidance for Field Samplers - Draft Final* (USEPA 2001g), Section 3.1.1.

8.1.2 Analytical Assessment

Analytical assessment includes an evaluation of analytical and method performance and supporting documentation relative to the DQOs. Proper data review is necessary to minimize decision errors caused by out-of-control laboratory processes or calculation or transcription errors. The level and depth of analytical assessment is determined during the planning process and is dependent on the types of analyses performed and the intended use of the data.

Analytical records needed to perform the assessment of laboratory activities may include the following:

- Contract Statement of Work requirements
- SOPs
- QAPP or WAP
- Equipment maintenance documentation
- Quality assurance information on precision, bias, method quantitation limits, spike recovery, surrogate and internal standard recovery, laboratory control standard recovery, checks on reagent purity, and checks on glassware cleanliness

- Calibration records
- Traceability of standards/reagents (which provide checks on equipment cleanliness and laboratory handling procedures)
- Sample management records
- Raw data
- Correspondence
- Logbooks and documentation of deviation from procedures.

If data gaps are identified, then the assessor should prepare a list of missing information for correspondence and discussion with the appropriate laboratory representative. At that time, the laboratory should be requested to supply the information or to attest that it does not exist in any form.

8.1.2.1 Analytical Data Verification

The term **data verification** is confirmation by examination and provision of objective evidence that specified requirements have been fulfilled. Data verification is the process of evaluating the completeness, correctness, and conformance/compliance of a specific data set against the method, procedural, or contractual requirements. The goal of data verification is to ensure that the data are what they purport to be, that is, that the reported results reflect what was actually done, and to document that the data fulfill specific requirements. When deficiencies in the data are identified, then those deficiencies should be documented for the data user's review and, where possible, resolved by corrective action (USEPA 2001c).

Data verification may be performed by personnel involved with the collection of samples or data, generation of analytical data, and/or by an external data verifier. The verification process normally starts with a list of requirements that apply to an analytical data package. It compares the laboratory data package to the requirements and produces a report that identifies those requirements that were met and not met. Requirements that were not met can be referred to as exceptions and may result in flagged data. Examples of the types of exceptions that are found and reported are listed below:

- Failure to analyze samples within the required holding times
- Required steps not carried out by the laboratory (i.e., failure to maintain sample custody, lack of proper signatures, etc.)
- Procedures not conducted at the required frequency (i.e., too few blanks, duplicates, etc.)
- Contamination found in storage, extraction, or analysis of blanks
- Procedures that did not meet pre-set acceptance criteria (poor laboratory control, poor sample matrix spike recovery, unacceptable duplicate precision, etc).

The verification report should detail all exceptions found with the data packages. If the laboratory was able to provide the missing information or a suitable narrative explanation of the exceptions, they should be made part of the report and included in the data package for use by the people who determine the technical defensibility of the data.

8.1.2.2 Analytical Data Validation (Evaluation)

The term **data validation** (also known as “evaluation”) is the confirmation by examination and provision of objective evidence that the particular requirements for a specific intended use are fulfilled. Data validation is an analyte- and sample-specific process that extends the evaluation of data beyond method, procedural, or contractual compliance (i.e., data verification) to determine the analytical quality of a specific data set. Data validation criteria are based upon the measurement quality objectives developed in the QAPP or similar planning document, or presented in the sampling or analytical method. Data validation includes a determination, where possible, of the reasons for any failure to meet method, procedural, or contractual requirements, and an evaluation of the impact of such failure on the overall data set (USEPA 2001c)

Data validation includes inspection of the verified data and both field and analytical laboratory data verification documentation; a review of the verified data to determine the analytical quality of the data set; and the production of a data validation report and, where applicable, qualified data. A focused data validation may also be required as a later step. The goals of data validation are to evaluate the quality of the data, to ensure that all project requirements are met, to determine the impact on data quality of those requirements that were not met, and to document the results of the data validation and, if performed, the focused data validation. The main focus of data validation is determining data quality in terms of accomplishment of measurement quality objectives.

As in the data verification process, all planning documents and procedures not only must exist, but they should also be readily available to the data validators. A data validator’s job cannot be completed properly without the knowledge of the specific project requirements. In many cases, the field and analytical laboratory documents and records are validated by different personnel. Because the data validation process requires knowledge of the type of information to be validated, a person familiar with field activities usually is assigned to the validation of the field documents and records. Similarly, a person with knowledge of analytical laboratory analysis, such as a chemist (depending on the nature of the project), usually is assigned to the validation of the analytical laboratory documents and records. The project requirements should assist in defining the appropriate personnel to perform the data validation (USEPA 2001c).

The personnel performing data validation should also be familiar with the project-specific data quality indicators (DQIs) and associated measurement quality objectives. One of the goals of the data validation process is to evaluate the quality of the data. In order to do so, certain data quality attributes are defined and measured. DQIs (such as precision, bias, comparability, sensitivity, representativeness, and completeness) are typically used as expressions of the quality of the data (USEPA 2001c).

The outputs that may result from data validation include validated data, a data validation report, and a focused validation report. For detailed guidance on data validation, see Chapter One of SW-846 and *Guidance on Environmental Data Verification and Data Validation EPA QA/G-8*

(USEPA 2001c).

8.2 Data Quality Assessment

Data quality assessment (DQA) is the scientific and statistical evaluation of data to determine if the data are of the right type, quality, and quantity to support their intended purpose (USEPA 2000d). The focus of the DQA process is on the use of statistical methods for environmental decision making – though not every environmental decision necessarily must be made based on the outcome of a statistical test (see also Section 3). If the sampling design established in the planning process requires estimation of a parameter or testing of a hypothesis, then the DQA process can be used to evaluate the sample analysis results.

The DQA process described in this section includes five steps: (1) reviewing the DQOs and study design, (2) preparing the data for statistical analysis, (3) conducting a preliminary review of the data and checking statistical assumptions, (4) selecting and performing statistical test, and (5) drawing conclusions from the data (Figure 36).

Detailed guidance on the statistical analysis of data can be found in Appendix F. Additional guidance can be found in *Guidance for Data Quality Assessment, EPA QA/G-9* (USEPA 2000d). A list of software tools to help you implement the DQA is provided in Appendix H.

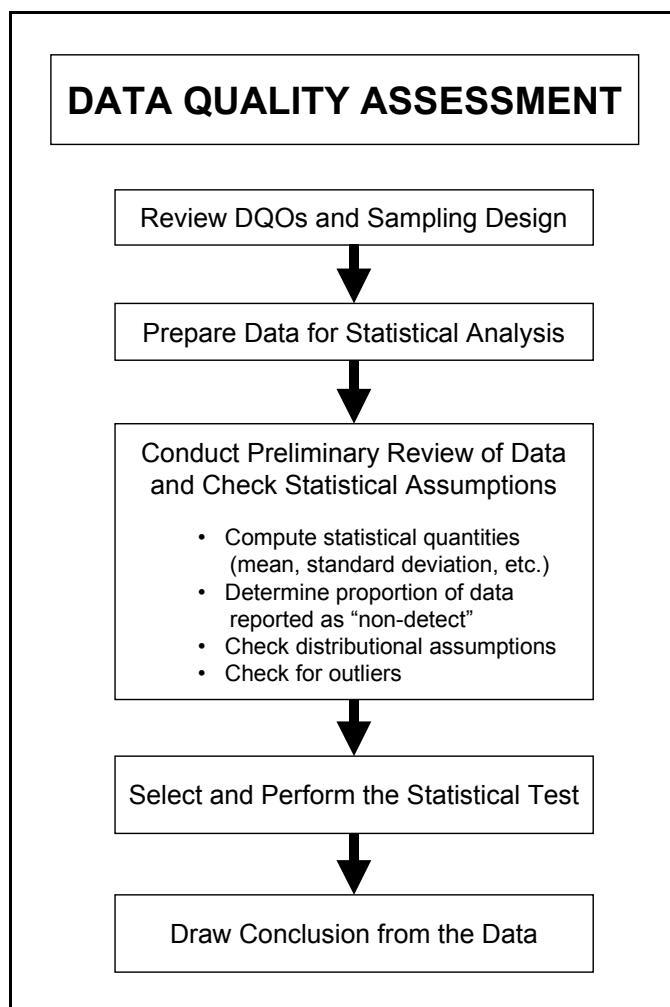

Figure 36. The DQA Process (modified from USEPA 2000d)

8.2.1 Review the DQOs and the Sampling Design

Review the DQO outputs to ensure that they are still applicable. Refer back to Sections 4 and 5 of this document for more information on the DQO Process or see USEPA 2000a or 2000b. A clear understanding of the original project objectives, as determined during the systematic planning process, is critical to selecting the appropriate statistical tests (if needed) and interpreting the results relative to the applicable RCRA regulatory requirements.

8.2.2 Prepare Data for Statistical Analysis

After data validation and verification and before the data are available in a form for further analysis, several intermediate steps usually are required. For most situations, EPA

recommends you prepare the data in computer-readable format. Steps in preparing data for statistical analysis are outlined below (modified from Ott 1988):

1. *Receive the verified and validated source from the QA reports.* Data are supplied to the user in a variety of formats and readiness for use, depending on the size and complexity of the study and the types of analyses requested. Most laboratories supply a QA evaluation package that includes the verification/validation review, a narrative, tabulated summary forms (including the results of analyses of field samples, laboratory standards, and QC samples), copies of logbook pages, and copies of chain-of-custody records. From this information, you can create a data base for statistical analysis.

Steps in Preparing Data for Statistical Analysis

1. Receive the verified and validated data source.
2. Create a data base from the verified and validated data source.
3. Check and edit the data base.
4. Create data files from the data base.

2. *Create a data base from the verified and validated data source.* For most studies in which statistical analyses are scheduled, a computer-readable data base is the most efficient method for managing the data. The steps required to create the data base and the format used will depend on the software systems used to perform the analysis. For example, the data base may be as simple as a string of concentration values for a single constituent input into a spreadsheet or word processor (such as required for use of EPA's DataQUEST software (USEPA 1997b)), or it may be more complex, requiring multiple and related data inputs, such as sample number, location coordinates, depth, date and time of collection, constituent name and concentration, units of measurements, test method, quantitation limit achieved, QC information, etc.

If the data base is created via manual data entry, the verified and validated data should be checked for legibility. Any questions pertaining to illegible information should be resolved before the data are entered. Any special coding considerations, such as indicating values reported as "nondetect" should be specified in a coding guide or in the QAPP. For very large projects, it may be appropriate to prepare a separate detailed data management plan in advance.

3. *Check and edit the data base.* After creation of the data set, the data base should be checked against the data source to verify accurate data entry and to correct any errors discovered. Even if the data base is received from the laboratory in electronic format, it should be checked for obvious errors, such as unit errors, decimal errors, missing values, and quantitation limits.
4. *Create data files from the data base.* From the original data files, work files are created for use within the statistical software package. This step could entail separating data by constituent and by DQO decision unit and separating any QA/QC data from the record data. When creating the final data files for use in the statistical software, be sure to use a file naming and storage convention that facilitates easy retrieval for future use, reference, or reporting.

8.2.3 Conduct Preliminary Review of the Data and Check Statistical Assumptions

Many statistical tests and procedures require that certain assumptions be met for their use. Failure to satisfy these assumptions can result in biased estimates of the parameter of interest; therefore, it is important to conduct preliminary analyses of the data to learn about the characteristics. EPA recommends that you compute statistical quantities, determine the proportion of the data reported as “nondetect” for each constituent of concern, check whether the data exhibit a normal distribution, then determine if there are any “outliers” that deserve a closer look. The outputs of these activities are used to help select and perform the appropriate statistical tests.

8.2.3.1 Statistical Quantities

To help “visualize” and summarize the data, calculate basic statistical quantities such as the:

- Mean
- Maximum
- Percentiles
- Variance
- Standard deviation
- Coefficient of variation.

Calculate the quantities for each constituent of concern. Example calculations of the mean, variance, standard deviation, and standard error of the mean are given in Section 3. Detailed guidance on the calculation of statistical quantities is provided in Chapter Two of EPA’s QA/G-9 guidance document (USEPA 2000d). The useful quantities easily can be computed using EPA’s DataQUEST software (USEPA 1997b, see also Appendix H) or any similar statistical software package.

When calculating statistical quantities, determine which data points were reported as below a limit of detection or quantitation - known as “nondetects” (NDs). See also Section 8.2.4.2 (“Treatment of Nondetects”).

8.2.3.2 Checking Data for Normality

Check the data sets for normality by using graphical methods, such as histograms, box and whisker plots, and normal probability plots (see also Section 3.1.3), or by using numerical tests, such as the Shapiro-Wilk test for normality (see Appendix F). Table 11 provides a summary of recommended methods. Detailed guidance on the use of graphical and statistical methods can be found in USEPA 1989b, 1992b, 1997b, and 2000d.

Table 11. Recommended Graphical and Statistical Methods for Checking Distributional Assumptions

Test	Use	Reference
Graphical Methods		
Histograms and frequency plots	Provides visual display of probability or frequency distribution	See USEPA 2000d. Construct via EPA's DataQUEST software (USEPA 1997b) or use a commercial software package.
Normal probability plot	Provides visual display of deviation from expected normality	See USEPA 2000d. Construct via EPA's DataQUEST software (USEPA 1997b) or use a commercial software package.
Box and Whisker Plot	Provides visual display of potential "outliers" or extreme values	See USEPA 2000d. Construct via EPA's DataQUEST software (USEPA 1997b) or use a commercial software package.
Numerical Tests for Normality		
Shapiro-Wilk Test	Use for sample sizes of ≤ 50	See procedure in Appendix F, Section F.1.2. This test also can be performed using EPA's DataQUEST software (USEPA 1997b).
Filliben's Statistic	Use for sample sizes of > 50	See USEPA 2000d. This test can be performed using EPA's DataQUEST software (USEPA 1997b).

Graphical methods allow you to visualize the central tendency of the data, the variability in the data, the location of extreme data values, and any obvious trends in the data. For example, a symmetrical "mound" shape of a histogram is an indicator of an approximately normal distribution. If a normal probability plot is constructed on the data (see Figure 5 in Section 3.1.3), a straight line plot usually is an indicator of normality. (Note that interpretation of a probability plot depends on the method used to construct it. For example, in EPA's DataQUEST software, normally distributed data will form an "S"-shaped curve rather than a straight line on a normal probability plot.)

The Shapiro-Wilk test is recommended as a superior method for testing normality of the data. The specific method for implementing the Shapiro-Wilk Test is provided in Appendix F. The method also is described in Gilbert (1987), EPA's guidance on the statistical analysis of groundwater monitoring data (USEPA 1992b), and can be performed with EPA's DataQUEST software or other commercially available statistical software.

8.2.3.3 How To Assess "Outliers"

A measurement that is very different from other values in the data set is sometimes referred to as an "outlier." EPA cautions that the term "outlier" be used advisedly, since a common reaction to the presence of "outlying" values has been to "cleanse the data," thereby removing any "outliers" prior to further analysis. In fact, such discrepant values can occur for many reasons,

including (1) a catastrophic event such as a spill or process upset that impacts measurements at the sampling point, (2) inconsistent sampling or analytical chemistry methodology that may result in laboratory contamination or other anomalies, (3) errors in the transcription of data values or decimal points, and (4) *true* but extreme hazardous constituent measurements.

While any one of these events can cause an apparent “outlier,” it should be clear that the appropriate response to an outlier will be very different depending on the origin. Because high values due to contaminated media or waste are precisely what one may be trying to identify, it would not be appropriate to eliminate such data in the guise of “screening for outliers.” Furthermore, depending on the form of the underlying population, unusually high concentrations may be real but infrequent such as might be found in lognormally distributed data. Again, it would not be appropriate to remove such data without adequate justification.

A *statistical outlier* is defined as a value originating from a different underlying population than the rest of the data set. If the value is not consistent with the distributional behavior of the remaining data and is “too far out in one of the tails” of the assumed underlying population, it may test out as a statistical outlier. Defined as it is strictly in statistical terms, however, an outlier test may identify values as discrepant when no physical reason can be given for the aberrant behavior. One should be especially cautious about indiscriminate testing for statistical outliers for this reason.

If an outlier is suspected, an initial and helpful step is to construct a probability plot of the data set (see also Section 3.1.3 and USEPA 2000d). A probability plot is designed to judge whether the sample data are consistent with an underlying normal population model. If the rest of the data follow normality, but the outlier comes from a distinctly different population with higher (or lower) concentrations, this behavior will tend to show up on a probability plot as a lone value “out of line” with the remaining observations. If the data are lognormal instead, but the outlier is again from a distinct population, a probability plot on the logged observations should be constructed. Neither of these plots is a formal test; still, they provide invaluable visual evidence as to whether the suspected outlier should really be considered as such.

Methods for conducting outlier tests are described in Chapter 4 of EPA’s QA/G-9 guidance document (USEPA 2000d), and statistical tests are available in the DataQUEST software (for example, Rosner’s Test and Walsh’s Test) (USEPA 1997b).

8.2.4 Select and Perform Statistical Tests

This section provides guidance on how you can select the appropriate statistical test to make a decision about the waste or media that is the subject of the study. It is important to select the appropriate statistical test because decisions and conclusions derived from incorrectly used statistics can be expensive (Singh, et al. 1997).

Prior to selecting the statistical test, consider the following factors:

- The objectives of the study (identified in DQO Step 2)
- Whether assumptions of the test are fulfilled
- The nature of the underlying distribution

- The decision rule and null hypothesis (identified in DQO Step 5)
- The relative performance of the candidate tests (for example, parametric tests generally are more efficient than their nonparametric counterparts)
- The proportion of the data that are reported as nondetects (NDs).

The decision-tree presented in Figure 37 provides a starting point for selecting the appropriate statistical test. The statistical methods are offered as guidance and should not be used as a "cook book" approach to data analysis. The methods presented here usually will be adequate for the tests conducted under the specified conditions (see also Appendix F). An experienced statistician should be consulted whenever there are questions.

Based on the study objective (DQO Step 2), determine which category of statistical tests to use. Note the statistical methods recommended in the flow charts in Figure 38 and Figure 39 are for use when the objective is to compare the parameter of interest to a fixed standard. Other methods will be required if the objective is different (e.g., when comparing two populations, detecting trends, and evaluating spatial patterns or relationships of sampling points).

8.2.4.1 Data Transformations in Statistical Tests

Users of this guidance may encounter data sets that show significant evidence of non-normality. Due to the assumption of underlying normality in most parametric tests, a common statistical strategy when encountering this predicament is to search for a mathematical transformation that will lead to normally-distributed data on the transformed scale. Unfortunately, because of the complexities associated with interpreting statistical results from data that have been transformed to another scale and the common occurrence of lognormal patterns in environmental data, EPA generally recommends that the choice of scale be limited to either the original measurements (for normal data) or a log-transformed scale (for lognormal data). If neither of these scales results in approximate normality, it is typically easiest and wisest to switch to a nonparametric (or "distribution-free") version of the same test.

If a transformation to the log scale is needed, and a confidence limit on the mean is desired, special techniques are required. If a data set exhibits a normal distribution on the log-transformed scale, it is a common mistake to assume that a standard normal-based confidence interval formula can be applied to the transformed data with the confidence interval endpoints retransformed to the original scale to obtain the confidence interval on the mean. Invariably, such an interval will be biased to the low side. In fact, the procedure just described actually produces a confidence interval around the *median* of a lognormal population, rather than the higher *mean*. To correctly account for this "transformation bias", special procedures are required (Land 1971 and 1975, Gilbert 1987). See Section F.2.3 in Appendix F for detailed guidance on calculating confidence limits for the mean of a lognormal population.

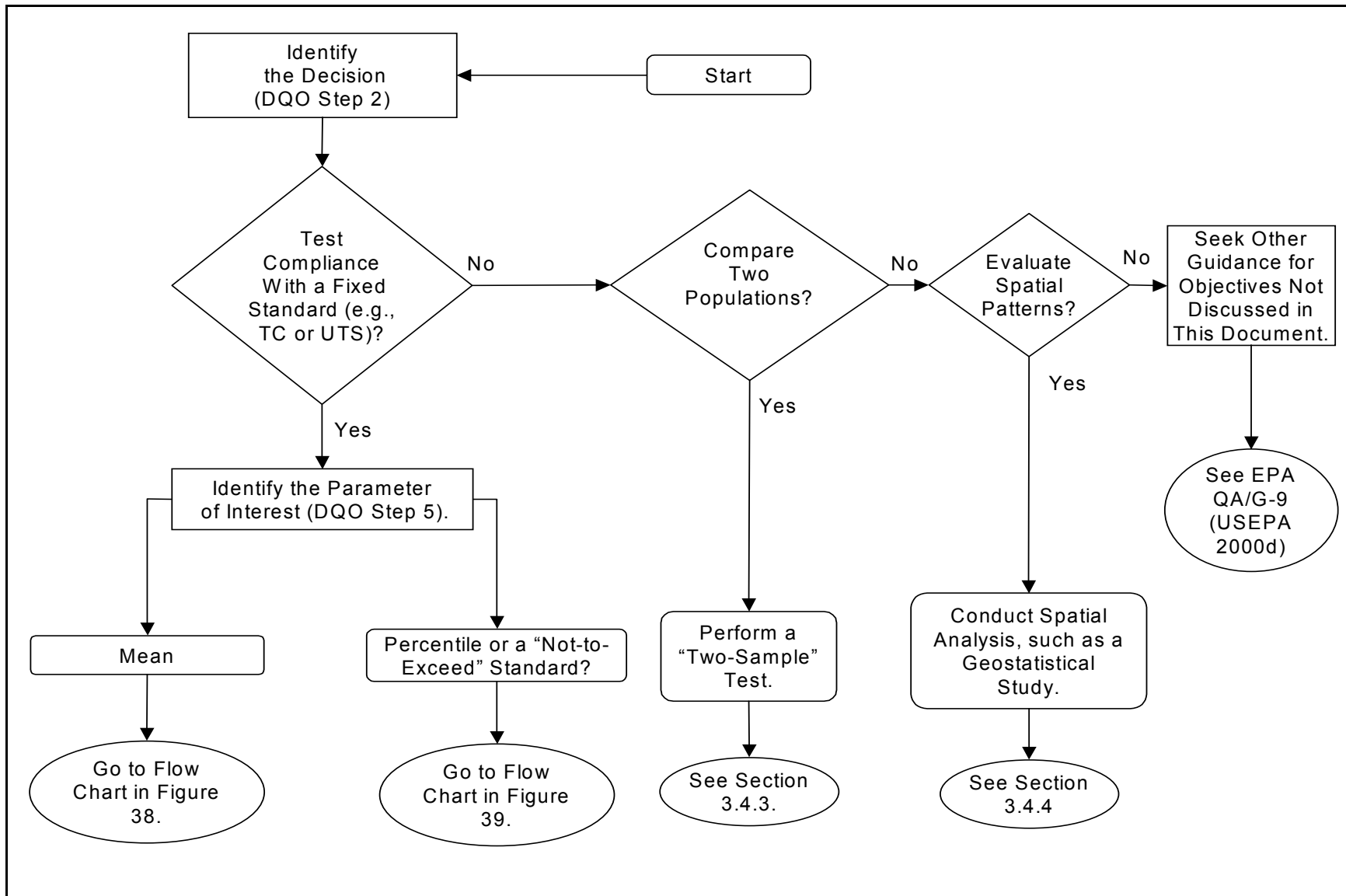

Figure 37. Flow chart for selecting a statistical method

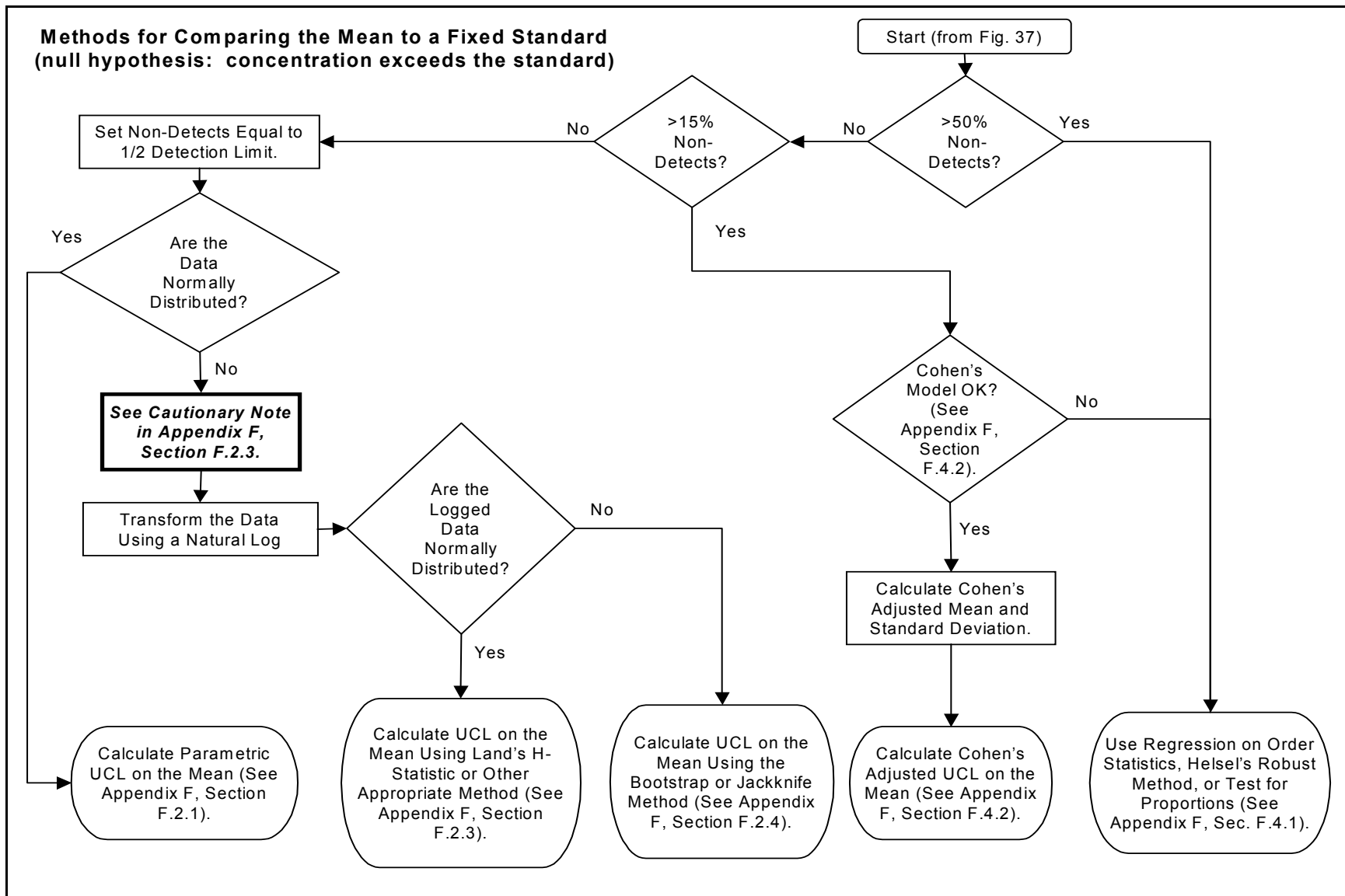

Figure 38. Flowchart of statistical methods for comparing the mean to a fixed standard (null hypothesis is “concentration exceeds the standard”)

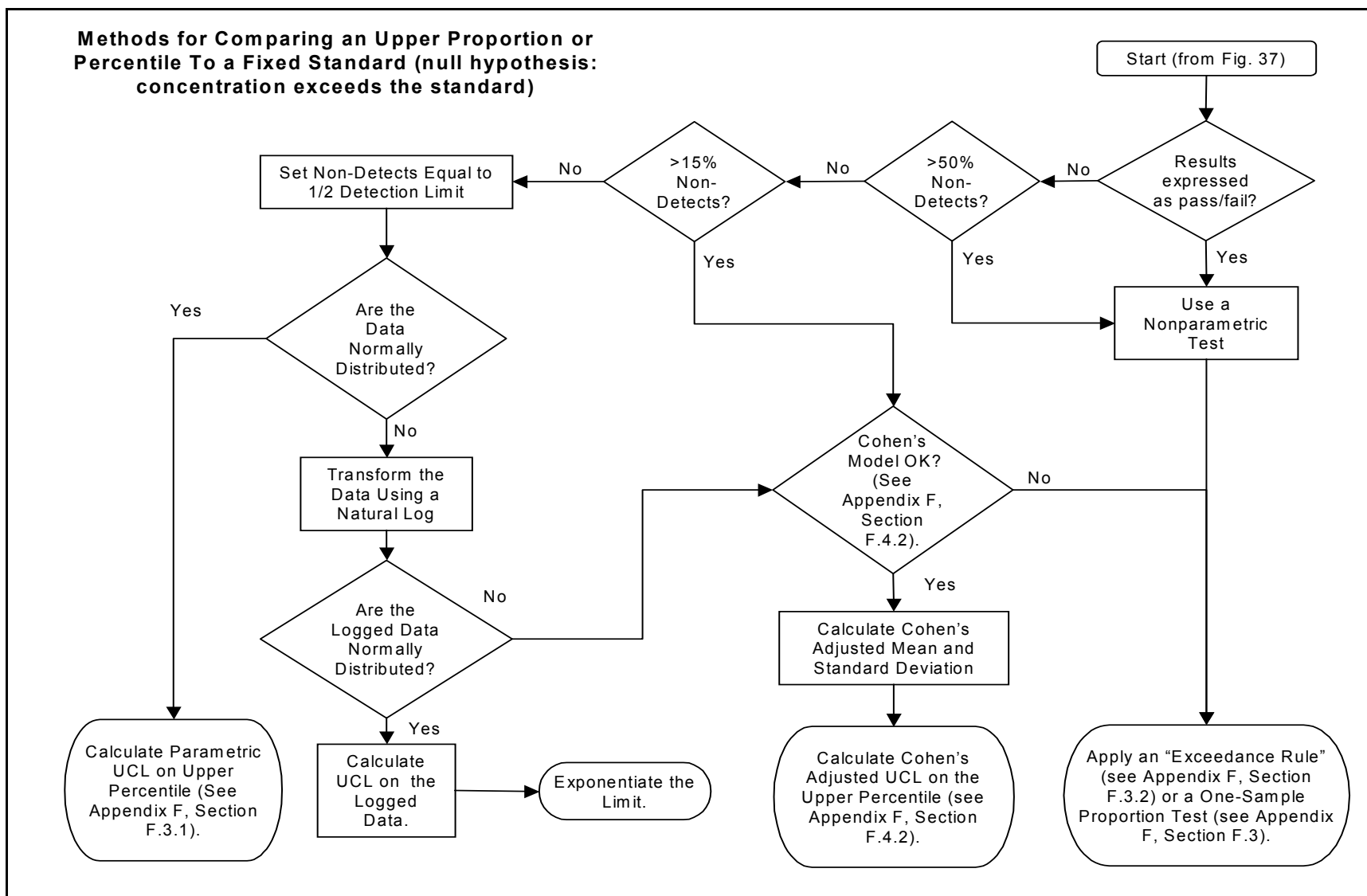

Figure 39. Flowchart of statistical methods for comparing an upper proportion or percentile to a fixed standard (null hypothesis is “concentration exceeds the standard”)

If the number of samples is small, it may not be possible to tell whether the distribution is normal, lognormal, or any other specific function. You are urged not to read too much into small data sets and not to attempt overly sophisticated evaluations of data distributions based on limited information. If the distribution of data appears to be highly skewed, it is best to take operational measures (such as more samples or samples of a larger physical size) to better characterize the waste.

8.2.4.2 Treatment of Nondetects

If no more than approximately 15 percent of the samples for a given constituent are nondetect (i.e., reported as below a detection or quantitation limit), the results of parametric statistical tests will not be substantially affected if nondetects are replaced by half their detection limits (known as a substitution method) (USEPA 1992b). When a larger percentage of the sample analysis results are nondetect, however, the treatment of nondetects is more crucial to the outcome of statistical procedures. Indeed, simple substitution methods (such as replacing the detection limit with one-half the detection limit) tend to perform poorly in statistical tests when the nondetect percentage is substantial (Gilliom and Helsel 1986, Helsel 1990).

Guidance on selecting an approach for handling nondetects in statistical intervals is given in Appendix F, Section F.4. Guidance also is given in Section 4.7 of EPA's *Guidance for Data Quality Assessment Practical Methods for Data Analysis EPA QA/G-9* (USEPA 2000d).

8.2.5 Draw Conclusions and Report Results

The final step in the DQA Process is to draw conclusions from the data, determine if further sampling is required, and report the results. This step brings the planning, implementation, and assessment process "full circle" in that you attempt to resolve the problem and make the decision identified in Steps 1 and 2 of the DQO Process.

In the DQO Process, you establish a "null hypothesis" and attempt to gather evidence via sampling that will allow you to reject that hypothesis; otherwise, the null hypothesis must be accepted. If the decision making process involves use of a statistical method (such as the calculation of a statistical confidence limit or use of a statistical hypothesis test), then the outcome of the statistical test should be reported along with the uncertainty associated with the result. If other decision making criteria are used (such as use of a simple exceedance rule or a "weight of evidence" approach), then the outcome of that decision making process should be reported.

Detailed guidance on the use and interpretation of statistical methods for decision making can be found in **Appendix F**. Additional guidance can be found in EPA's *Guidance for Data Quality Assessment, EPA QA/G-9* (USEPA 2000d).

Most of the statistical methods suggested in this document involve the construction of one-sided confidence limits (or bounds). The upper confidence limit, whether calculated on a mean, median, or percentile, provides a value below which one can claim with specified confidence that the true value of the parameter lies.

Figure 40 demonstrates how you can use a confidence limit to test a hypothesis: In the situation depicted at “A,” the upper confidence limit calculated from the sample data is less than the applicable standard and provides the evidence needed to reject the null hypothesis. The decision can be made that the waste concentration is below the standard with sufficient confidence and without further analysis.

In situation “B,” we cannot reject the null hypothesis; however, because the interval “straddles” the standard, it is *possible* that the true mean lies below the standard and a Type II (false acceptance) error has been made (i.e., to conclude the concentration is above the standard, when in fact it is not). One possible remedy to this situation is to obtain more data to “tighten” the confidence interval.

In situation “C,” the Type II (false acceptance) decision error rate is satisfied and we must conclude that the mean concentration exceeds the standard.

One simple method for checking the performance of the statistical test is use the information obtained from the samples to retrospectively estimate the number of samples required. For example, the sample variance can be input into the sample size equation used (see Section 5.4 and 5.5, DQO Process Step 7). (An example of this approach is presented in Appendix I.) If this theoretical sample size is less than or equal to the number of samples actually taken, then the test is sufficiently powerful. If the required number of samples is greater than the number actually collected, then additional samples would be required to satisfy the data user’s performance criteria for the statistical test. See EPA’s *Guidance for Data Quality Assessment, EPA QA/G-9* (USEPA 2000d) for additional guidance on this topic.

Finally, if a simple exceedance rule is used to measure compliance with a standard, then interpretation of the results is more straightforward. For example, if zero exceedances are allowed, and one or more samples exceeds the standard, then there is evidence of noncompliance with that standard (see Appendix F, Section F.3.2).

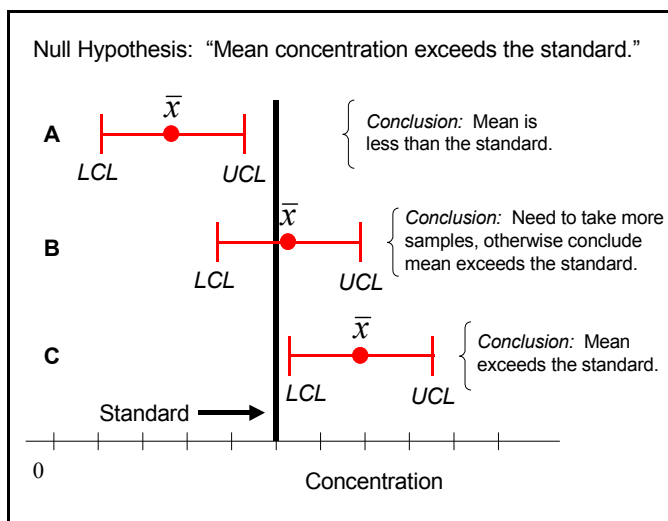

Figure 40. Using confidence limits on the mean to compare waste concentrations to a fixed standard.

This page intentionally left blank

APPENDIX A

GLOSSARY OF TERMS*

Accuracy - A measure of the closeness of an individual measurement or the average of a number of measurements to the true value. Accuracy includes a combination of random error (*precision*) and systematic error (bias) components that are due to sampling and analytical operations. EPA recommends using the terms “precision” and “bias,” rather than the term “accuracy,” to convey the information usually associated with accuracy. Pitard (1993) indicates that a sample is accurate when the absolute value of the bias is smaller than an acceptable standard of accuracy.

Action Level - The numerical value that causes the decision maker to choose one of the alternative actions (for example, compliance or noncompliance). It may be a regulatory threshold standard, such as the maximum contaminant level for drinking water, a risk-based concentration level, a technological limitation, or a reference-based standard (ASTM D 5792-95).

Alternative Hypothesis - See *Hypothesis*.

Assessment - The evaluation process used to measure the performance or effectiveness of a system and its elements. As used here, assessment is an all-inclusive term used to denote any of the following: *audit*, performance evaluation (PE), management systems review (MSR), peer review, inspection, or surveillance.

Audit (quality) - A systematic and independent examination to determine whether quality activities and related results comply with planned arrangements and whether these arrangements are implemented effectively and are suitable to achieve objectives.

Audit of Data Quality - A qualitative and quantitative evaluation of the documentation and procedures associated with environmental measurements to verify that the resulting data are of acceptable quality.

Baseline Condition - A tentative assumption to be proven either true or false. When *hypothesis* testing is applied to a site *assessment* decision, the data are used to choose between a presumed baseline condition of the environment and an alternative condition. The baseline condition is retained until overwhelming evidence indicates that the baseline condition is false. This is often called the *null hypothesis* in statistical tests.

Bias - The systematic or persistent distortion of a measured value from its true value (this can occur during sampling design, the sampling process, or laboratory analysis).

* The definitions in this appendix are from USEPA 1998a, 2000b, 2000e, and 2001b, unless otherwise noted. Some definitions were modified based on comments received from technical reviewers during development of this document. These definitions do not constitute the Agency's official use of the terms for regulatory purposes and should not be construed to alter or supplant other terms in use.

Note: Terms in *italics* also are defined in this glossary.

Appendix A

Blank - A sample that is intended to contain none of the analytes of interest and is subjected to the usual analytical or measurement process to establish a zero baseline or background value. Sometimes used to adjust or correct routine analytical results. A blank is used to detect contamination during sample handling preparation and/or analysis (see also *Rinsate*, *Method Blank*, *Trip Blank*, and *Field Blank*).

Boundaries - The spatial and temporal limits and practical constraints under which environmental data are collected. Boundaries specify the area or volume (spatial boundary) and the time period (temporal boundary) to which the decision will apply. Samples are then collected within these boundaries.

Calibration - Comparison of a measurement standard, instrument, or item with a standard or instrument of higher *accuracy* to detect and quantify inaccuracies and to report or eliminate those inaccuracies by adjustments. Calibration also is used to quantify instrument measurements of a given concentration in a given sample.

Calibration Drift - The deviation in instrument response from a reference value over a period of time before recalibration.

Chain of Custody - An unbroken trail of accountability that ensures the physical security of samples, data, and records.

Characteristic - Any property or attribute of a datum, item, process, or service that is distinct, describable, and/or measurable.

Coefficient of Variation (CV) - A dimensionless quantity used to measure the spread of data relative to the size of the numbers. For a normal distribution, the coefficient of variation is given by s / \bar{x} . Also known as the *relative standard deviation (RSD)*.

Colocated Samples - Two or more portions collected as close as possible at the same point in time and space so as to be considered identical. If obtained in the field, these samples also are known as "field replicates."

Comparability - A measure of the confidence with which one data set or method can be compared to another.

Completeness - A measure of the amount of valid data obtained from a measurement system compared to the amount that was expected to be obtained under correct, normal conditions.

Component - An easily identified item such as a large crystal, an agglomerate, rod, container, block, glove, piece of wood, or concrete (ASTM D 5956-96). An elementary part or a constituent that can be separated and quantified by analysis (Pitard 1993).

Composite Sample - A physical combination of two or more samples (ASTM D 6233-98). A sample collected across a temporal or spatial range that typically consists of a set of discrete samples (or "individual" samples) that are combined or "composited." Area-wide or long-term compositing should not be confused with localized compositing in which a sample of the desired support is created from many small increments taken at a single location. Four types of composite samples are listed below:

1. Time Composite - a sample comprising a varying number of discrete samples collected at equal time intervals during the compositing period. The time composite sample is typically used to sample waste water or streams.
2. Flow Proportioned Composite (FPC) - a sample collected proportional to the flow during the compositing period by either a time-varying/constant volume (TVCV) or a time-constant/varying volume method (TCVV). The TVCV method typically is used with automatic samplers that are paced by a flow meter. The TCVV method is a manual method that individually proportions a series of discretely collected samples. The FPC is typically used when sampling waste water.
3. Areal Composite - sample composited from individual equal-size samples collected on an areal or horizontal cross-sectional basis. Each discrete sample is collected in an identical manner. Examples include sediment composites from quarter-point sampling of streams and soil samples from within grids.
4. Vertical Composite - a sample composited from individual equal samples collected from a vertical cross section. Each discrete sample is collected in an identical manner. Examples include vertical profiles of soil/sediment columns, lakes, and estuaries (USEPA 1996c).

Confidence Level - The probability, usually expressed as a percent, that a confidence interval will contain the *parameter* of interest (ASTM D 5792-95). Also known as the confidence coefficient.

Confidence Limits - Upper and/or lower limit(s) within which the true value of a parameter is likely to be contained with a stated probability or confidence (ASTM D 6233-98).

Conformance - An affirmative indication or judgment that a product or service has met the requirements of the relevant specifications, contract, or regulation. Also the state of meeting the requirements.

Consensus Standard - A standard established by a group representing a cross section of a particular industry or trade, or a part thereof.

Control Sample - A quality control sample introduced into a process to monitor the performance of the system (from Chapter One, SW-846).

Data Collection Design - A design that specifies the configuration of the environmental monitoring effort to satisfy the *data quality objectives*. It includes: the types of samples or monitoring information to be collected; where, when, and under what conditions they should be collected; what variables are to be measured; and the quality assurance/quality control (QA/QC) components that ensure acceptable sampling design error and measurement error to meet the *decision error* rates specified in the DQOs. The data collection design is the principal part of the quality assurance project plan (QAPP).

Appendix A

Data of Known Quality - Data that have the qualitative and quantitative components associated with their derivation documented appropriately for their intended use, and when such documentation is verifiable and defensible.

Data Quality Assessment (DQA) Process - A statistical and scientific evaluation of the data set to assess the validity and performance of the data collection design and statistical test and to establish whether a data set is adequate for its intended use.

Data Quality Indicators (DQIs) - The quantitative statistics and qualitative descriptors that are used to interpret the degree of acceptability or utility of data to the user. The principal data quality indicators are *bias*, *precision*, *accuracy* (precision and bias are preferred terms), *comparability*, *completeness*, and *representativeness*.

Data Quality Objectives (DQOs) - Qualitative and quantitative statements derived from the DQO Process that clarify study technical and quality objectives, define the appropriate type of data, and specify tolerable levels of potential *decision errors* that will be used as the basis for establishing the quality and quantity of data needed to support decisions.

Data Quality Objectives (DQO) Process - A systematic strategic planning tool based on the scientific method that identifies and defines the type, quality, and quantity of data needed to satisfy a specified use. The key elements of the process include:

- concisely defining the problem
- identifying the decision to be made
- identifying the key inputs to that decision
- defining the *boundaries* of the study
- developing the decision rule
- specifying tolerable limits on potential *decision errors*
- selecting the most resource efficient data collection design.

Data Reduction - The process of transforming the number of data items by arithmetic or statistical calculations, standard curves, and concentration factors, and collating them into a more useful and understandable form. Data reduction generally results in a reduced data set and an associated loss of detail.

Data Usability - The process of ensuring or determining whether the quality of the data produced meets the intended use of the data.

Data Validation - See *Validation*.

Debris - Under 40 CFR 268.2(g) (Land Disposal Restrictions regulations) debris includes “solid material exceeding a 60 mm particle size that is intended for disposal and that is a manufactured object; or plant or animal matter; or natural geologic material.” 268.2(g) also identifies materials that are not debris. In general, debris includes materials of either a large particle size or variation in the items present. When the constituent items are more than 2 or 3 inches in size or are of different compositions, *representative* sampling becomes more difficult.

Decision Error - An error made when drawing an inference from data in the context of *hypothesis* testing such that variability or *bias* in the data mislead the decision maker to draw a

conclusion that is inconsistent with the true or actual state of the population under study. See also *False Negative Decision Error*, and *False Positive Decision Error*.

Decision Performance Curve - A graphical representation of the quality of a decision process. In statistical terms it is known as a power curve or function (or a reverse power curve depending on the hypotheses being tested).

Decision Performance Goal Diagram (DPGD) - A graphical representation of the tolerable risks of *decision errors*. It is used in conjunction with the decision performance curve.

Decision Unit - A volume or mass of material (such as waste or soil) about which a decision will be made.

Defensible - The ability to withstand any reasonable challenge related to the veracity, integrity, or quality of the logical, technical, or scientific approach taken in a decision-making process.

Design - Specifications, drawings, design criteria, and performance requirements. Also, the result of deliberate planning, analysis, mathematical manipulations, and design processes (such as experimental design and sampling design).

Detection Limit - A measure of the capability of an analytical method to distinguish samples that do not contain a specific analyte from samples that contain low concentrations of the analyte. The lowest concentration or amount of the target analyte that can be determined to be different from zero by a single measurement at a stated level of probability. Detection limits are analyte- and matrix-specific and may be laboratory-dependent.

Discrete Sample - A sample that represents a single location or short time interval. A discrete sample can be composed of more than one increment. The term has the same meaning as "individual sample."

Distribution - A probability function (density function, mass function, or distribution function) used to describe a set of observations (*statistical sample*) or a population from which the observations are generated.

Duplicate Samples - Two samples taken from and *representative* of the same population and carried through all steps of the sampling and analytical procedures in an identical manner. Duplicate samples are used to assess the *variance* of the total method, including sampling and analysis. See also *Colocated Sample* and *Field Duplicate Samples*.

Dynamic Work Plan - A work plan that allows the project team to make decisions in the field about how subsequent site activities will progress (for example, by use field analytical methods that provide near real-time sample analysis results). Dynamic work plans provide the strategy for how dynamic field activities will take place. As such, they document a flexible, adaptive sampling and analytical strategy. (Adopted from EPA Superfund web site at <http://www.epa.gov/superfund/programs/dfa/dynwork.htm>).

Environmental Conditions - The description of a physical medium (e.g., air, water, soil, sediment) or a biological system expressed in terms of its physical, chemical, radiological, or biological characteristics.

Appendix A

Environmental Data - Any measurements or information that describe environmental processes, location, or conditions; ecological or health effects and consequences; or the performance of environmental technology. For EPA, environmental data include information collected directly from measurements, produced from models, and compiled from other sources, such as data bases or the scientific literature.

Environmental Monitoring - The process of measuring or collecting environmental data for evaluating a change in the environment (e.g., ground-water monitoring).

Environmental Processes - Manufactured or natural processes that produce discharges to or that impact the ambient environment.

Equipment Blank - See *Rinsate*.

Estimate - A characteristic from the sample from which inferences about population *parameters* can be made.

Evaluation - See *validation*.

Evidentiary Records - Records identified as part of litigation and subject to restricted access, custody, use, and disposal.

False Negative (False Acceptance) Decision Error (β) - A false negative decision error occurs when the decision maker does not reject the null *hypothesis* when the null hypothesis actually is false. In statistical terminology, a false negative decision error also is called a Type II error. The measure of the size of the error is expressed as a probability, usually referred to as "beta" (β). This probability also is called the complement of power (where "power" is expressed as $(1 - \beta)$).

False Positive (False Rejection) Decision Error (α) - A false positive decision error occurs when a decision maker rejects the null *hypothesis* when the null hypothesis is true. In statistical terminology, a false positive decision error also is called a Type I error. The measure of the size of the error is expressed as a probability, usually referred to as "alpha" (α), the "level of significance," or "size of the critical region."

Field Blank - A *blank* used to provide information about contaminants that may be introduced during sample collection, storage, and transport. The clean sample is carried to the sampling site, exposed to sampling conditions, returned to the laboratory, and treated as an environmental sample.

Field Duplicates - Independent samples that are collected as close as possible to the same point in space and time. Two separate samples are taken from the same source, stored in separate containers, and analyzed independently. These duplicates are useful in documenting the *precision* of the sampling process (from Chapter One, SW-846, July 1992).

Field (matrix) Spike - A sample prepared at the sampling point (i.e., in the field) by adding a known mass of the target analyte to a specified amount of the sample. Field matrix spikes are

used, for example, to determine the effect of the sample preservation, shipment, storage, matrix, and preparation on analyte recovery efficiency (the analytical *bias*).

Field Split Samples - Two or more *representative* portions taken from the same sample and usually submitted for analysis to different laboratories to estimate interlaboratory *precision*.

Fundamental Error - The fundamental error results when discrete units of the material to be sampled have different compositions with respect to the property of interest. The error is referred to as “fundamental” because it is an incompressible minimum sampling error that depends on the mass, composition, shape, fragment size distribution, and liberation factor of the material and is not affected by homogenization or mixing. The fundamental error is the only error that remains when the sampling operation is “perfect,” i.e., when all parts of the sample are obtained in a probabilistic manner and each part is independent. The fundamental error is never zero (unless the population is completely homogeneous or the entire population is submitted for exhaustive analysis) and it never “cancels out.” It can be reduced by taking larger physical samples and by using particle-size reduction steps in preparing the analytical sample.

Geostatistics - A branch of statistics, originating in the mining industry and greatly developed in the 1950s, that assesses the spatial correlation among samples and incorporates this information into the estimates of population *parameters*.

Goodness-of-Fit Test - In general, the level of agreement between an observed set of values and a set wholly or partly derived from a model of the data.

Grab Sample - A one-time sample taken from any part of the waste (62 FR 91, page 26047, May 12, 1997).

Graded Approach - The process of basing the level of application of managerial controls applied to an item or work according to the intended use of the results and the degree of confidence needed in the quality of the results. (See also *Data Quality Objectives Process*.)

Gray Region - A range of values of the population *parameter* of interest (such as mean contaminant concentration) within which the consequences of making a *decision error* are relatively minor. The gray region is bounded on one side by the *action level*. The width of the gray region is denoted by Δ in this guidance.

Guidance - A suggested practice that is not mandatory, but rather intended as an aid or example in complying with a standard or requirement.

Guideline - A suggested practice that is nonmandatory in programs intended to comply with a standard.

Hazardous Waste - Any waste material that satisfies the definition of “hazardous waste” as given in 40 CFR Part 261, “Identification and Listing of Hazardous Waste.”

Heterogeneity - The condition of the population under which items of the population are not identical with respect to the *parameter* of interest (ASTM D 6233-98). (See Section 6.2.1).

Holding Time - The period of time a sample may be stored prior to its required analysis. While

Appendix A

exceeding the holding time does not necessarily negate the veracity of analytical results, it causes the qualifying or “flagging” of any data not meeting all of the specified acceptance criteria.

Homogeneity - The condition of the population under which all items of the population are identical with respect to the *parameter* of interest (ASTM D 6233-98). The condition of a population or lot in which the elements of that population or lot are identical; it is an inaccessible limit and depends on the “scale” of the elements.

Hot Spots - Strata that contain high concentrations of the *characteristic* of interest and are relatively small in size when compared with the total size of the materials being sampled (ASTM D 6009-96).

Hypothesis - A tentative assumption made to draw out and test its logical or empirical consequences. In hypothesis testing, the hypothesis is labeled “null” (for the baseline condition) or “alternative,” depending on the decision maker's concerns for making a *decision error*. The baseline condition is retained until overwhelming evidence indicates that the baseline condition is false. See also *baseline condition*.

Identification Error - The misidentification of an analyte. In this error type, the contaminant of concern is unidentified and the measured concentration is incorrectly assigned to another contaminant.

Increment - A group of particles extracted from a batch of material in a single operation of the sampling device. It is important to make a distinction between an increment and a sample that is obtained by the reunion of several increments (from Pitard 1989).

Individual Sample - See *Discrete Sample*.

Inspection - The examination or measurement of an item or activity to verify *conformance* to specific requirements.

Internal Standard - A standard added to a test portion of a sample in a known amount and carried through the entire determination procedure as a reference for calibrating and assessing the *precision* and *bias* of the applied analytical method.

Item - An all-inclusive term used in place of the following: appurtenance, facility, sample, assembly, *component*, equipment, material, module, part, product, structure, subassembly, subsystem, system, unit, documented concepts, or data.

Laboratory Split Samples - Two or more *representative* portions taken from the same sample for laboratory analysis. Often analyzed by different laboratories to estimate the interlaboratory *precision* or variability and the data *comparability*.

Limit of Quantitation - The minimum concentration of an analyte or category of analytes in a specific matrix that can be identified and quantified above the method detection limit and within specified limits of *precision* and *bias* during routine analytical operating conditions.

Limits on Decision Errors - The tolerable maximum decision error probabilities established by

the decision maker. Potential economic, health, ecological, political, and social consequences of decision errors should be considered when setting the limits.

Matrix Spike - A sample prepared by adding a known mass of a target analyte to a specified amount of sample matrix for which an independent estimate of the target analyte concentration is available. Spiked samples are used, for example, to determine the effect of the matrix on a method's recovery efficiency.

Mean (arithmetic) (\bar{x}) - The sum of all the values of a set of measurements divided by the number of values in the set; a measure of central tendency.

Mean Square Error (MSE) - A statistical term equivalent to the *variance* added to the square of the *bias*. An overall measure of the representativeness of a sample.

Measurement Error - The difference between the true or actual state and that which is reported from measurements.

Median - The middle value for an ordered set of n values. Represented by the central value when n is odd or by the average of the two most central values when n is even. The median is the 50th percentile.

Medium - A substance (e.g., air, water, soil) that serves as a carrier of the analytes of interest.

Method - A body of procedures and techniques for performing an activity (e.g., sampling, chemical analysis, quantification) systematically presented in the order in which they are to be executed.

Method Blank - A *blank* prepared to represent the sample matrix as closely as possible and analyzed exactly like the *calibration* standards, samples, and QC samples. Results of method blanks provide an estimate of the within-batch variability of the blank response and an indication of *bias* introduced by the analytical procedure.

Natural Variability - The variability that is inherent or natural to the media, objects, or subjects being studied.

Nonparametric - A term describing statistical methods that do not assume a particular population probability distribution, and are therefore valid for data from any population with any probability distribution, which can remain unknown (Conover 1999).

Null Hypothesis - See *Hypothesis*.

Observation - (1) An *assessment* conclusion that identifies a condition (either positive or negative) that does not represent a significant impact on an item or activity. An observation may identify a condition that has not yet caused a degradation of quality. (2) A datum.

Outlier - An observation that is shown to have a low probability of belonging to a specified data population.

Appendix A

Parameter - A quantity, usually unknown, such as a mean or a standard deviation characterizing a population. Commonly misused for "variable," "*characteristic*," or "property."

Participant - When used in the context of environmental programs, an organization, group, or individual that takes part in the planning and design process and provides special knowledge or skills to enable the planning and design process to meet its objective.

Percent Relative Standard Deviation (%RSD) - The quantity, $100(\text{RSD})\%$.

Percentile - The specific value of a distribution that divides the distribution such that p percent of the distribution is equal to or below that value. For example, if we say "the 95th percentile is X ," then it means that 95 percent of the values in the *statistical sample* are less than or equal to X .

Planning Team - The group of people that will carry out the DQO Process. Members include the decision maker (senior manager), representatives of other data users, senior program and technical staff, someone with statistical expertise, and a QA/QC advisor (such as a QA Manager).

Population - The total collection of objects, media, or people to be studied and from which a sample is to be drawn. The totality of items or units under consideration (ASTM D 5956-96).

Precision - A measure of mutual agreement among individual measurements of the same property, usually under prescribed similar conditions, expressed generally in terms of the sample standard deviation. See also the definition for *precision* in Chapter One, SW-846.

Probabilistic Sample - See *statistical sample*.

Process - A set of interrelated resources and activities that transforms inputs into outputs. Examples of processes include analysis, design, data collection, operation, fabrication, and calculation.

Qualified Data - Any data that have been modified or adjusted as part of statistical or mathematical evaluation, data *validation*, or data verification operations.

Quality - The totality of features and characteristics of a product (including data) or service that bears on its ability to meet the stated or implied needs and expectations of the user (i.e., fitness for use).

Quality Assurance (QA) - An integrated system of management activities involving planning, implementation, *assessment*, reporting, and quality improvement to ensure that a process, item, or service is of the type and quality needed and expected by the client.

Quality Assurance Manager - The individual designated as the principal manager within the organization having management oversight and responsibilities for planning, coordinating, and assessing the effectiveness of the quality system for the organization.

Quality Assurance Project Plan (QAPP) - A formal document describing, in comprehensive detail, the necessary QA, QC, and other technical activities that must be implemented to ensure

that the results of the work performed will satisfy the stated performance criteria.

Quality Control (QC) - The overall system of technical activities that measures the attributes and performance (quality characteristics) of a process, item, or service against defined standards to verify that they meet the stated requirements established by the customer. Operational techniques and activities that are used to fulfill requirements for quality. The system of activities and checks used to ensure that measurement systems are maintained within prescribed limits, providing protection against “out-of-control” conditions and ensuring the results are of acceptable quality.

Quality Control (QC) Sample - An uncontaminated sample matrix spiked with known amounts of analytes from a source independent of the *calibration* standards. Generally used to establish intralaboratory or analyst-specific *precision* and *bias* or to assess the performance of all or a portion of the measurement system.

Quality Management - That aspect of the overall management system of the organization that determines and implements the quality policy. Quality management includes strategic planning, allocation of resources, and other systematic activities (e.g., planning, implementation, and *assessment*) pertaining to the quality system.

Quality Management Plan - A formal document that describes the quality system in terms of the organization’s structure, the functional responsibilities of management and staff, the lines of authority, and the required interfaces for those planning, implementing, and assessing all activities conducted.

Quality System - A structured and documented management system describing the policies, objectives, principles, organizational authority, responsibilities, accountability, and implementation plan of an organization for ensuring quality in its work processes, products (items), and services. The quality system provides the framework for planning, implementing, and assessing work performed by the organization and for carrying out required QA and QC.

Random Error - The chance variation encountered in all measurement work, characterized by the random occurrence of deviations from the mean value.

Range - The numerical difference between the minimum and maximum of a set of values.

Relative Standard Deviation - See *Coefficient of Variation*.

Remediation - The process of reducing the concentration of a contaminant (or contaminants) in air, water, or soil media to a level that poses an acceptable risk to human health.

Repeatability - The degree of agreement between independent test results produced by the same analyst using the same test method and equipment on random aliquots of the same sample within a short time period; that is, within-run precision of a method or set of measurements.

Reporting Limit - The lowest concentration or amount of the target analyte required to be reported from a data collection project. Reporting limits are generally greater than detection limits and usually are not associated with a probability level.

Appendix A

Representative Sample - RCRA regulations define a representative sample as "a sample of a universe or whole (e.g., waste pile, lagoon, ground water) which can be expected to exhibit the average properties of the universe or whole" (40 CFR § 260.10).

Representativeness - A measure of the degree to which data accurately and precisely represent a *characteristic* of a population, parameter variations at a sampling point, a process condition, or an environmental condition.

Reproducible - The condition under which there is no statistically significant difference in the results of measurements of the same sample made at different laboratories.

Reproducibility - The degree of agreement between independent test results produced by the same method or set of measurements for very similar, but not identical, conditions (e.g., at different times, by different technicians, using different glassware, laboratories, or samples); that is, the between-run precision of a method or set of measurements.

Requirement - A formal statement of a need and the expected manner in which it is to be met.

Rinsate (Equipment Rinsate) - A sample of analyte-free medium (such as HPLC-grade water for organics or reagent-grade deionized or distilled water for inorganics) which has been used to rinse the sampling equipment. It is collected after completion of decontamination and prior to sampling. This *blank* is useful in documenting the adequate decontamination of sampling equipment (modified from Chapter One, SW-846).

Sample - A portion of material that is taken from a larger quantity for the purpose of estimating the properties or the composition of the larger quantity (ASTM D 6233-98).

Sample Support - See *Support*.

Sampling - The process of obtaining *representative* samples and/or measurements of a population or subset of a population.

Sampling Design Error - The error due to observing only a limited number of the total possible values that make up the population being studied. It should be distinguished from: errors due to imperfect selection; *bias* in response; and errors of observation, measurement, or recording, etc.

Scientific Method - The principles and processes regarded as necessary for scientific investigation, including rules for concept or *hypothesis* formulation, conduct of experiments, and validation of hypotheses by analysis of observations.

Sensitivity - The capability of a method or instrument to discriminate between measurement responses representing different levels of a variable of interest (i.e., the slope of the calibration).

Set of Samples - More than one individual sample.

Split Samples - Two or more *representative* portions taken from one sample and often analyzed by different analysts or laboratories as a type of QC sample used to assess analytical variability and *comparability*.

Standard Deviation - A measure of the dispersion or imprecision of a sample or population distribution expressed as the positive square root of the *variance* and that has the same unit of measurement as the mean. See *variance*.

Standard Operating Procedure (SOP) - A written document that details the method for an operation, analysis, or action with thoroughly prescribed techniques and steps and that is officially approved (usually by the quality assurance officer) as the method for performing certain routine or repetitive tasks.

Statistic - A function of the sample measurements; e.g., the sample mean or standard deviation. A statistic usually, but not necessarily, serves as an estimate of a population *parameter*. A summary value calculated from a sample of observations.

Statistical Sample - A set of samples or measurements selected by probabilistic means (i.e., by using some form of randomness). Also known as a *probabilistic sample*.

Statistical Test - Any statistical method that is used to determine the acceptance or rejection of a hypothesis.

Stratum - A subgroup of a population separated in space or time, or both, from the remainder of the population and being internally consistent with respect to a target constituent or property of interest and different from adjacent portions of the population (ASTM D 5956-96).

Subsample - A portion of material taken from a larger quantity for the purpose of estimating properties or the composition of the whole sample (ASTM D 4547-98).

Support - The physical volume or mass, orientation, and shape of a sample, subsample, or decision unit.

Surrogate Spike or Analyte - A pure substance with properties that mimic the analyte of interest. It is unlikely to be found in environmental samples and is added to them to establish that the analytical method has been performed properly.

Technical Review - A documented critical review of work that has been performed within the state of the art. The review is accomplished by one or more qualified reviewers who are independent of those who performed the work, but are collectively equivalent in technical expertise to those who performed the original work. The review is an in-depth analysis and evaluation of documents, activities, material, data, or items that require technical verification or *validation* for applicability, correctness, adequacy, *completeness*, and assurance that established requirements are satisfied.

Total Study Error - The combination of sampling design error and measurement error.

Traceability - The ability to trace the history, application, or location of an entity by means of recorded identifications. In a *calibration* sense, traceability relates measuring equipment to national or international standards, primary standards, basic physical constants or properties, or reference materials. In a data collection sense, it relates calculations and data generated throughout the project back to the requirements for the project's quality.

Appendix A

Trip Blank - A clean sample of a matrix that is taken to the sampling site and transported to the laboratory for analysis without having been exposed to sampling procedures. A trip blank is used to document contamination attributable to shipping and field handling procedures. This type of *blank* is useful in documenting contamination of volatile organics samples.

True - Being in accord with the actual state of affairs.

Type I Error (α) - A Type I error occurs when a decision maker rejects the null *hypothesis* when it is actually true. See also *False Positive Decision Error*.

Type II Error (β) - A Type II error occurs when the decision maker fails to reject the null *hypothesis* when it is actually false. See also *False Negative Decision Error*.

User - When used in the context of environmental programs, an organization, group, or individual that utilizes the results or products from environmental programs. A user also may be the client for whom the results or products were collected or created.

Vadose Zone - In soil, the unsaturated zone, limited above by the ground surface and below by the saturated zone.

Validation - Confirmation by examination and provision of objective evidence that the particular requirements for a specific intended use are fulfilled. In design and development, *validation* concerns the process of examining a product or result to determine *conformance* to user needs.

Variable - The attribute of the environment that is indeterminant. A quantity which may take any one of a specified set of values.

Variance - A measure of the variability or dispersion in (1) a population (population variance, σ^2), or (2) a sample or set of subsamples (sample variance, s^2). The variance is the second moment of a frequency distribution taken about the arithmetic mean as the origin. For a normal distribution, it is the sum of the squared deviations of the (population or sample) member observation about the (population or sample) mean divided by the degrees of freedom (N for σ^2 , or $n - 1$ for s^2).

Verification - Confirmation by examination and provision of objective evidence that specified requirements have been fulfilled. In design and development, verification concerns the process of examining a result of a given activity to determine *conformance* to the stated requirements for that activity.

APPENDIX B

SUMMARY OF RCRA REGULATORY DRIVERS FOR CONDUCTING WASTE SAMPLING AND ANALYSIS

Through RCRA, Congress provided EPA with the framework to develop regulatory programs for the management of solid and hazardous waste. The provisions of RCRA Subtitle C establish the criteria for identifying hazardous waste and managing it from its point of generation to ultimate disposal. EPA's regulations set out in 40 CFR Parts 260 to 279 are the primary reference for information on the hazardous waste program. These regulations include provisions for waste sampling and testing and environmental monitoring. Some of these RCRA regulations require sampling and analysis, while others do not specify requirements and allow sampling and analysis to be performed at the discretion of the waste handler or as specified in individual facility permits.

Table B-1 provides a comprehensive listing of the regulatory citations, the applicable RCRA standards, requirements for demonstrating attainment or compliance with the standards, and relevant USEPA guidance documents. The table is divided into three major sections addressing regulations for (1) hazardous waste identification, (2) land disposal restrictions, and (3) other programs. The table is meant to be used as a general reference guide. Consult the latest 40 CFR, related *Federal Register* notices, and EPA's World Wide Web site (www.epa.gov) for new or revised regulations and further clarification and definitive articulation of requirements. In addition, because some states have requirements that differ from EPA regulations and guidance, we recommend that you consult with a representative from your State if your State is authorized to implement the regulation.

Table B-1. Summary of Waste Analysis Drivers for Major RCRA Regulatory Program Areas

40 CFR Citation and Description	Applicable Standards	Requirements for Demonstrating Attainment of or Compliance With the Standards	Relevant USEPA Guidance
Waste Analysis Drivers for the Hazardous Waste Identification Program			
<p>§261.3(a)(2)(v) - Used oil rebuttable presumption (see also Part 279, Subpart B and the Part 279 standards for generators, transporters, processors, re-refiners, and burners.)</p>	<p>Used oil that contains more than 1,000 parts per million (ppm) of total halogens is presumed to have been mixed with a regulated halogenated hazardous waste (e.g., spent halogenated solvents), and is therefore subject to applicable hazardous waste regulations. The rebuttable presumption does not apply to metalworking oils and oils from refrigeration units, under some circumstances.</p>	<p>A person may rebut this presumption by demonstrating, through analysis or other documentation, that the used oil has not been mixed with halogenated hazardous waste. One way of doing this is to show that the used oil does not contain significant concentrations of halogenated hazardous constituents (50 FR 49176; November 29, 1985). If the presumption is successfully rebutted, then the used oil will be subject to the used oil management standards instead of the hazardous waste regulations.</p>	<p><i>Hazardous Waste Management System; Identification and Listing of Hazardous Waste; Recycled Used Oil Management Standards</i>, 57 FR 41566; September 10, 1992</p> <p><i>Part 279 Requirements: Used Oil Management Standards</i>, EPA530-H-98-001</p>
<p>§261.3(c)(2)(ii)(C) - Generic exclusion levels for K061, K062, and F006 nonwastewater HTMR residues</p>	<p>To be excluded from the definition of hazardous waste, residues must meet the generic exclusion levels specified at §261.3(c)(2)(ii)(C)(1) and exhibit no characteristics of hazardous waste.</p>	<p>Testing requirements must be incorporated in a facility's waste analysis plan or a generator's self-implementing waste analysis plan. At a minimum, composite samples of residues must be collected and analyzed quarterly and/or when the process or operation generating the waste changes. Claimant has the burden of proving by clear and convincing evidence that the material meets all of the exclusion requirements.</p>	<p><i>Waste Analysis at Facilities That Generate, Treat, Store, and Dispose of Hazardous Wastes, a Guidance Manual</i>, EPA530-R-94-024 (USEPA 1994a)</p>

Table B-1. Summary of Waste Analysis Drivers for Major RCRA Regulatory Program Areas

40 CFR Citation and Description	Applicable Standards	Requirements for Demonstrating Attainment of or Compliance With the Standards	Relevant USEPA Guidance
Waste Analysis Drivers for the Hazardous Waste Identification Program (continued)			
§261.21- Characteristic of Ignitability	A solid waste exhibits the characteristic of ignitability if a representative sample of the waste is: (1) A liquid having a flashpoint of less than 140 degrees Fahrenheit (60 degrees Centigrade); (2) A non-liquid which causes fire through friction, absorption of moisture, or spontaneous chemical changes and, when ignited, burns so vigorously and persistently it creates a hazard; (3) An ignitable compressed gas; or (4) An oxidizer. (Aqueous solutions with alcohol content less than 24% are not regulated.)	If a representative sample of the waste exhibits the characteristic, then the waste exhibits the characteristic. Appendix I of 40 CFR Part 261 contains references to representative sampling methods; however a person may employ an alternative method without formally demonstrating equivalency. Also, for those methods specifically prescribed by regulation, the generator can petition the Agency for the use of an alternative method (see 40 CFR 260.21).	See Chapters Seven and Eight in <i>Test Methods for Evaluating Solid Waste, Physical/Chemical Methods, Updates I, II, IIA, IIB, III, and IIIA. SW-846.</i> (USEPA 1986a)
§261.22 - Characteristic of Corrosivity	A solid waste exhibits the characteristic of corrosivity if a representative sample of the waste is: (1) Aqueous, with a pH less than or equal to 2, or greater than or equal to 12.5; or (2) Liquid and corrodes steel at a rate greater than 6.35 mm per year when applying a National Association of Corrosion Engineers Standard Test Method.	If a representative sample of the waste exhibits the characteristic, then the waste exhibits the characteristic. Appendix I of 40 CFR Part 261 contains references to representative sampling methods; however a person may employ an alternative method without formally demonstrating equivalency. Also, for those methods specifically prescribed by regulation, the generator can petition the Agency for the use of an alternative method (see 40 CFR 260.21).	See Chapters Seven and Eight in <i>Test Methods for Evaluating Solid Waste, Physical/Chemical Methods, Updates I, II, IIA, IIB, III, and IIIA. SW-846.</i> (USEPA 1986a)

Table B-1. Summary of Waste Analysis Drivers for Major RCRA Regulatory Program Areas

<i>40 CFR Citation and Description</i>	<i>Applicable Standards</i>	<i>Requirements for Demonstrating Attainment of or Compliance With the Standards</i>	<i>Relevant USEPA Guidance</i>
Waste Analysis Drivers for the Hazardous Waste Identification Program (continued)			
§261.23 - Characteristic of Reactivity	A solid waste exhibits the characteristic of reactivity if a representative sample of the waste: (1) Is normally unstable and readily undergoes violent change; (2) Reacts violently with water; (3) Forms potentially explosive mixtures with water; (4) Generates toxic gases, vapors, or fumes when mixed with water; (5) Is a cyanide or sulfide-bearing waste which, when exposed to pH conditions between 2 and 12.5, can generate toxic gases, vapors, or fumes; (6) Is capable of detonation or explosion if subjected to a strong initiating source or if heated under confinement; (7) Is readily capable of detonation or explosive decomposition or reaction at standard temperature and pressure; or (8) Is a forbidden explosive as defined by DOT.	EPA relies on these narrative criterion to define reactive wastes. Waste handlers should use their knowledge to determine if a waste is sufficiently reactive to be regulated. Also, for those methods specifically prescribed by regulation, the generator can petition the Agency for the use of an alternative method (see 40 CFR 260.21).	EPA currently relies on narrative standards to define reactive wastes, and withdrew interim guidance related to sulfide and cyanide levels (see a Memorandum entitled, "Withdrawal of Cyanide and Sulfide Reactivity Guidance" from David Bussard and Barnes Johnson to Diana Love, dated April 21, 1998).
§ 261.24 - Toxicity Characteristic	A solid waste exhibits the characteristic of toxicity if the extract of a representative sample of the waste contains any of the contaminants listed in Table 1 in 261.24, at or above the specified regulatory levels. The extract should be obtained through use of the Toxicity Characteristic Leaching Procedure (TCLP). If the waste contains less than .5 percent filterable solids, the waste itself, after filtering, is considered to be the extract.	Appendix I of 40 CFR Part 261 contains references to representative sampling methods; however, a person may employ an alternative method without formally demonstrating equivalency.	See Chapters Seven and Eight in <i>Test Methods for Evaluating Solid Waste, Physical/Chemical Methods, Updates I, II, IIA, IIB, III, and IIIA</i> . SW-846. (USEPA 1986a)

Table B-1. Summary of Waste Analysis Drivers for Major RCRA Regulatory Program Areas

40 CFR Citation and Description	Applicable Standards	Requirements for Demonstrating Attainment of or Compliance With the Standards	Relevant USEPA Guidance
Waste Analysis Drivers for the Hazardous Waste Identification Program (continued)			
§261.38(c)(8)(iii)(A) - Exclusion of Comparable Fuels from the Definition of Solid and Hazardous Waste	For each waste for which an exclusion is claimed, the generator of the hazardous waste must test for all of the constituents on Appendix VIII to part 261, except those that the generator determines, based on testing or knowledge, should not be present in the waste. The generator is required to document the basis for each determination that a constituent should not be present.	For waste to be eligible for exclusion, a generator must demonstrate that "each constituent of concern is not present in the waste above the specification level at the 95% upper confidence limit around the mean."	See the final rule from June 19, 1998 (63 <i>FR</i> 33781) For further information on the comparable fuels exclusion, see the following web site: http://www.epa.gov/combustion/fastrack/
Part 261- Appendix I - Representative Sampling Methods	Provides sampling protocols for obtaining a representative sample.	For the purposes of Subpart C, a sample obtained using Appendix I sampling methods will be considered representative. The Appendix I methods, however, are not formally adopted (see comment at §261.20(c)).	<i>Test Methods for Evaluating Solid Waste, Physical/Chemical Methods, Updates I, II, IIA, IIB, III, and IIIA.</i> SW-846. (USEPA 1986a) ASTM Standards

Table B-1. Summary of Waste Analysis Drivers for Major RCRA Regulatory Program Areas

40 CFR Citation and Description	Applicable Standards	Requirements for Demonstrating Attainment of or Compliance With the Standards	Relevant USEPA Guidance
Waste Analysis Drivers for the Land Disposal Restriction Program			
§268.6(b)(1) - Petitions to Allow Land Disposal of a Waste Prohibited Under Subpart C of Part 268 (No-Migration Petition)	The demonstration must meet the following criteria: (1) All waste and environmental sampling, test, and analysis data must be accurate and reproducible to the extent that state-of-the-art techniques allow; (2) All sampling, testing, and estimation techniques for chemical and physical properties of the waste and all environmental parameters must have been approved by the EPA Administrator.	<ul style="list-style-type: none"> Waste analysis requirements will be specific to the petition. Sampling methods are specified in the facility's Waste Analysis Plan. 	<p><i>Waste Analysis at Facilities That Generate, Treat, Store, and Dispose of Hazardous Wastes, a Guidance Manual</i>, EPA530-R-94-024 (USEPA 1994a)</p> <p><i>Land Disposal Restrictions No Migration Variances; Proposed Rule</i>. Federal Register, August 11, 1992 (USEPA 1992)</p>
§268.40 - Land Disposal Restriction (LDR) concentration-level standards	For total waste standards, all hazardous constituents in the waste or in the treatment residue must be at or below the values in the table at 268.40. For waste extract standards, the hazardous constituents in the extract of the waste or in the extract of the treatment residue must be at or below the values in the table at 268.40.	<ul style="list-style-type: none"> Sampling methods are specified in the facility's Waste Analysis Plan. Compliance with the standards for nonwastewater is measured by an analysis of grab samples. Compliance with wastewater standards is based on composite samples. No single sample may exceed the applicable standard. 	<p><i>Waste Analysis at Facilities That Generate, Treat, Store, and Dispose of Hazardous Wastes, a Guidance Manual</i>, EPA530-R-94-024 (USEPA 1994a)</p>

Table B-1. Summary of Waste Analysis Drivers for Major RCRA Regulatory Program Areas

40 CFR Citation and Description	Applicable Standards	Requirements for Demonstrating Attainment of or Compliance With the Standards	Relevant USEPA Guidance
Waste Analysis Drivers for the Land Disposal Restriction Program (continued)			
§268.44 - Land Disposal Restriction Treatability Variance	If you are a generator or treatment facility whose wastes cannot be treated to achieve the established treatment standards, or for which treatment standards are not appropriate, you may petition EPA for a variance from the treatment standard. A treatment variance does not exempt your wastes from treatment, but rather establishes an alternative LDR treatment standard.	The application must demonstrate that the treatment standard for the waste in question is either “unachievable” or “inappropriate.”	<p>Memorandum entitled “<i>Use of Site-Specific Land Disposal Restriction Treatability Variances Under 40 CFR 268.44(h) During Cleanups</i>” (Available from the RCRA Call Center or on EPA’s web site at http://www.epa.gov/epaoswer/hazwaste/ldr/tv-rule/guidmem.txt)</p> <p>Variance Assistance Document: Land Disposal Restrictions Treatability Variances & Determinations of Equivalent Treatment (available from the RCRA Call Center or on EPA’s web site at http://www.epa.gov/epaoswer/hazwaste/ldr/guidance2.pdf)</p>
§268.49(c)(1) - Alternative LDR Treatment Standards for Contaminated Soil	All constituents subject to treatment must be treated as follows: (A) For non-metals, treatment must achieve 90 percent reduction in total constituent concentrations except where treatment results in concentrations less than 10 times the Universal Treatment Standard (UTS) at 268.48. (B) For metals, treatment must achieve 90 percent reduction in constituent concentrations as measured in TCLP leachate from the treated media or 90 percent reduction in total concentrations when a metal removal technology is used, except where treatment results in concentrations less than 10 times the UTS at 268.48.	Sampling methods are specified in the facility’s Waste Analysis Plan.	<p><i>Guidance on Demonstrating Compliance With the Land Disposal Restrictions (LDR) Alternative Soil Treatment Standards</i> (USEPA 2002)</p> <p><i>Waste Analysis at Facilities That Generate, Treat, Store, and Dispose of Hazardous Wastes, a Guidance Manual</i>, EPA530-R-94-024 (USEPA 1994a)</p>

Table B-1. Summary of Waste Analysis Drivers for Major RCRA Regulatory Program Areas

40 CFR Citation and Description	Applicable Standards	Requirements for Demonstrating Attainment of or Compliance With the Standards	Relevant USEPA Guidance
Waste Analysis Drivers in Other RCRA Regulations			
§260.10 - Definitions	“Representative sample” means a sample of a universe or whole (e.g. waste pile, lagoon, ground water) which can be expected to exhibit the average properties of the universe or whole.	Representative samples may be required to measure compliance with various provisions within the RCRA regulations. See requirements specified in the applicable regulation or implementation guidance.	<i>Test Methods for Evaluating Solid Waste, Physical/Chemical Methods, Updates I, II, IIA, IIB, III, and IIIA.</i> SW-846. (USEPA 1986a)
Part 260 - Subpart C - Rulemaking Petitions	In the section for petitions to amend Part 261 to “delist” a hazardous waste, the petitioner must demonstrate that the waste does not meet any of the criteria under which the waste was listed as a hazardous waste (§260.22).	Demonstration samples must consist of enough representative samples, but in no case less than four samples, taken over a period of time sufficient to represent the variability or the uniformity of the waste.	<i>Petitions to Delist Hazardous Waste—A Guidance Manual.</i> 2 nd ed. (USEPA 1993d) <i>Region 6 RCRA Delisting Program Guidance Manual for the Petitioner</i> (USEPA 1996d)
Part 262 - Subpart A - Purpose, Scope, and Applicability (including §262.11 - Hazardous Waste Determination)	Generators must make the following determinations if a secondary material is a solid waste: 1) whether the solid waste is excluded from regulation; 2) whether the waste is a listed waste; and 3) whether the waste is characteristic waste (§262.11)	Generators must document their waste determination and land disposal restriction determination.	<i>Waste Analysis at Facilities That Generate, Treat, Store, and Dispose of Hazardous Wastes, a Guidance Manual,</i> EPA530-R-94-024 (USEPA 1994a)
Part 262 - Subpart C - Pre-Transport Requirements	Under §262.34(a)(4), if generators are performing treatment within their accumulation units, they must comply with the waste analysis plan requirements of §268.7(a)(5).	Generators must develop a waste analysis plan (kept on-site for three years) which details the treatment they are performing to meet LDR treatment standards and the type of analysis they are performing to show completion of treatment.	<i>Waste Analysis at Facilities That Generate, Treat, Store, and Dispose of Hazardous Wastes, a Guidance Manual,</i> EPA530-R-94-024 (USEPA 1994a)

Table B-1. Summary of Waste Analysis Drivers for Major RCRA Regulatory Program Areas

40 CFR Citation and Description	Applicable Standards	Requirements for Demonstrating Attainment of or Compliance With the Standards	Relevant USEPA Guidance
Waste Analysis Drivers in Other RCRA Regulations (continued)			
Part 264 - Subpart A - Purpose, Scope, and Applicability	§264.1(j)(2) - In an exemption established by the HWIR-media rulemaking, remediation waste can be exempt under circumstances that require chemical and physical analysis of a representative sample of the hazardous remediation waste to be managed at the site.	The analysis, at a minimum, must contain all the information needed to treat, store, or dispose of the waste according to Part 264 and Part 268. The waste analysis must be accurate and up-to-date.	See the final <i>Federal Register</i> notice from November 30, 1998 (63 <i>FR</i> 65873) For further documentation, see the following web site: http://www.epa.gov/epaoswer/hazwaste/id/hwirmdia.htm
Parts 264/265 - Subpart B - General Facility Standards	§264/265.13 - General waste analysis requirements specify: (a) Detailed chemical and physical analysis of a representative sample is required before an owner treats, stores, or disposes of any hazardous waste. Sampling method may be those under Part 261; and (b) Owner/operator must develop and follow a written waste-analysis plan.	All requirements are case-by-case and are determined in the facility permit.	<i>Waste Analysis at Facilities That Generate, Treat, Store, and Dispose of Hazardous Wastes, a Guidance Manual</i> , EPA530-R-94-024 (USEPA 1994a)

Table B-1. Summary of Waste Analysis Drivers for Major RCRA Regulatory Program Areas

40 CFR Citation and Description	Applicable Standards	Requirements for Demonstrating Attainment of or Compliance With the Standards	Relevant USEPA Guidance
Waste Analysis Drivers in Other RCRA Regulations (continued)			
<p>Part 264 - Subpart F - Groundwater Monitoring</p>	<p>Groundwater monitoring wells must be properly installed so that samples will yield representative results. All monitoring wells must be lined, or cased, in a manner that maintains the integrity of the monitoring well bore hole (§264.97(c)). Poorly installed wells may give false results.</p> <p>There are specific monitoring standards for all three sub-programs:</p> <ul style="list-style-type: none"> • Detection Monitoring (§264.98); • Compliance Monitoring (§264.99); and • Corrective Action Program (§264.100). <p>The Corrective Action Program is specific to the Groundwater Monitoring Program.</p>	<p>At a minimum, there must be procedures and techniques for sample collection, sample preservation and shipment, analytical procedures, and chain-of-custody control (§264.97(d)). Sampling and analytical methods must be appropriate for groundwater sampling and accurately measure the hazardous constituents being analyzed. The owner and operator must develop an appropriate sampling procedure and interval for each hazardous constituent identified in the facility's permit. The owner and operator may use an alternate procedure if approved by the RA. Requirements and procedures for obtaining and analyzing samples are detailed in the facility permit, usually in a Sampling and Analysis Plan.</p>	<p><i>Statistical Analysis of Ground-Water Monitoring Data at RCRA Facilities (Interim Final Guidance)</i>. Office of Solid Waste (USEPA 1989b)</p> <p><i>RCRA Ground-Water Monitoring: Draft Technical Guidance</i>. (USEPA 1992c)</p> <p><i>Statistical Analysis of Ground-Water Monitoring Data at RCRA Facilities Addendum to Interim Final Guidance</i> (USEPA 1992b)</p> <p><i>Methods for Evaluating the Attainment of Cleanup Standards. Volume 2: Ground Water</i> (USEPA. 1992i)</p>

Table B-1. Summary of Waste Analysis Drivers for Major RCRA Regulatory Program Areas

40 CFR Citation and Description	Applicable Standards	Requirements for Demonstrating Attainment of or Compliance With the Standards	Relevant USEPA Guidance
Waste Analysis Drivers in Other RCRA Regulations (continued)			
Part 265 - Subpart F - Ground-water Monitoring	To comply with Part 265, Subpart F, the owner/operator must install, operate, and maintain a ground-water monitoring system capable of representing the background groundwater quality and detecting any hazardous constituents that have migrated from the waste management area to the uppermost aquifer. Under Part 265, Subpart F, there are two types of groundwater monitoring programs: an indicator evaluation program designed to detect the presence of a release, and a ground-water quality assessment program that evaluates the nature and extent of contamination.	To determine existing ground-water conditions at an interim status facility, the owner and operator must install at least one well hydraulically upgradient from the waste management area. The well(s) must be able to accurately represent the background quality of ground water in the uppermost aquifer. The owner and operator must install at least three wells hydraulically downgradient at the limit of the waste management area, which are able to immediately detect any statistically significant evidence of a release. A separate monitoring system for each management unit is not required as long as the criteria in §265.91(a) are met and the system is able to detect any release at the edge of the waste management area.	<p><i>Statistical Analysis of Ground-Water Monitoring Data at RCRA Facilities (Interim Final Guidance)</i>. Office of Solid Waste (USEPA 1989b)</p> <p><i>RCRA Ground-Water Monitoring: Draft Technical Guidance</i>. (USEPA 1992c)</p> <p><i>Statistical Analysis of Ground-Water Monitoring Data at RCRA Facilities Addendum to Interim Final Guidance</i> (USEPA 1992b)</p>
Part 264/265 - Subpart G - Closure and Post-Closure	The closure plan must include a detailed description of the steps for sampling and testing surrounding soils and criteria for determining the extent of decontamination required to satisfy the closure performance standards. (§264/265.112(b)(4))	All requirements are facility-specific and are set forth in the facility permit.	<p>Closure/Postclosure Interim Status Standards (40 CFR 265, Subpart G): Standards Applicable to Owners and Operators of Hazardous Waste Treatment, Storage, and Disposal Facilities Under RCRA, Subtitle C, Section 3004</p> <p><i>RCRA Guidance Manual for Subpart G Closure and Postclosure Care Standards and Subpart H Cost Estimating Requirements</i> (USEPA 1987)</p>

Table B-1. Summary of Waste Analysis Drivers for Major RCRA Regulatory Program Areas

<i>40 CFR Citation and Description</i>	<i>Applicable Standards</i>	<i>Requirements for Demonstrating Attainment of or Compliance With the Standards</i>	<i>Relevant USEPA Guidance</i>
Waste Analysis Drivers in Other RCRA Regulations (continued)			
Part 264 - Subpart I - Use and Management of Containers	Spilled or leaked waste and accumulated precipitation must be removed from the sump or collection area in as timely a manner as is necessary to prevent overflow of the collection system (§264.175).	If the collected material is a hazardous waste under part 261 of this Chapter, it must be managed as a hazardous waste in accordance with all applicable requirements of parts 262 through 266 of the chapter. If the collected material is discharged through a point source to waters of the United States, it is subject to the requirements of section 402 of the Clean Water Act, as amended. Testing scope and requirements are site-specific and are set forth in the facility waste analysis plan.	<i>Waste Analysis at Facilities That Generate, Treat, Store, and Dispose of Hazardous Wastes, a Guidance Manual, EPA530-R-94-024 (USEPA 1994a)</i> <i>Guidance for Permit Writers: Facilities Storing Hazardous Waste in Containers, 11/2/82, PB88-105 689</i> <i>Model RCRA Permit for Hazardous Waste Management Facilities, 9/15/88, EPA530-SW-90-049</i>
Parts 264/265 - Subpart J - Tank Systems	Demonstrate the absence or presence of free liquids in the stored/treated waste using EPA Method 9095 (Paint Filter Liquid Tests) of SW-846 (§§264/265.196).	The Paint Filter Liquid Test is a positive or negative test.	<i>Method 9095 of Test Methods for Evaluating Solid Waste, Physical/Chemical Methods, Updates I, II, IIA, IIB, III, and IIIA. SW-846. (USEPA 1986a)</i>

Table B-1. Summary of Waste Analysis Drivers for Major RCRA Regulatory Program Areas

40 CFR Citation and Description	Applicable Standards	Requirements for Demonstrating Attainment of or Compliance With the Standards	Relevant USEPA Guidance
Waste Analysis Drivers in Other RCRA Regulations (continued)			
Part 264/265 - Subpart M - Land Treatment	To demonstrate adequate treatment (treatment demonstration), the permittee must perform testing, analytical, design, and operating requirements. (§264.272) Demonstration that food-chain crops can be grown on a treatment unit can include sample collection with criteria for sample selection, sample size, analytical methods, and statistical procedures. (§264/265.276) Owner/operator must collect pore-water samples and determine if there has been a statistically significant change over background using procedures specified in the permit. (§264/265.278) During post-closure period, owner may conduct pore-water and soil sampling to determine if there has been a statistically significant change in the concentration of hazardous constituents. (§264/265.280)	All requirements are facility-specific and are set forth in the facility permit.	See Chapters Twelve in <i>Test Methods for Evaluating Solid Waste, Physical/Chemical Methods, Updates I, II, IIA, IIB, III, and IIIA. SW-846.</i> (USEPA 1986a) <i>Guidance Manual on Hazardous Waste Land Treatment Closure/Postclosure (40 CFR Part 265), 4/14/87, PB87-183 695</i> <i>Hazardous Waste Land Treatment, 4/15/83, SW-874</i> <i>Permit Applicants' Guidance Manual for Hazardous Waste Land Treatment, Storage, and Disposal Facilities; Final Draft, 5/15/84, EPA530-SW-84-004</i> <i>Permit Guidance Manual on Hazardous Waste Land Treatment Demonstrations, 7/15/86, EPA530-SW-86-032</i> <i>Permit Guidance Manual on Unsaturated Zone Monitoring for Hazardous Waste Land Treatment Units, 10/15/86, EPA530-SW-86-040</i>

Table B-1. Summary of Waste Analysis Drivers for Major RCRA Regulatory Program Areas

<i>40 CFR Citation and Description</i>	<i>Applicable Standards</i>	<i>Requirements for Demonstrating Attainment of or Compliance With the Standards</i>	<i>Relevant USEPA Guidance</i>
Waste Analysis Drivers in Other RCRA Regulations (continued)			
Part 264 - Subpart O - Incinerators	<p>There are waste analysis requirements to verify that waste fed to the incinerator is within physical and chemical composition limits specified in the permit. (§§264/265.341)</p> <p>The owner/operator must conduct sampling and analysis of the waste and exhaust emissions to verify that the operating requirements established in the permit achieve the performance standards of §264.343 (§§264/265.347)</p>	All requirements are facility-specific and are set forth in the facility permit.	See Chapter Thirteen in <i>Test Methods for Evaluating Solid Waste, Physical/Chemical Methods, Updates I, II, IIA, IIB, III, and IIIA. SW-846.</i> (USEPA 1986a)

Table B-1. Summary of Waste Analysis Drivers for Major RCRA Regulatory Program Areas

<i>40 CFR Citation and Description</i>	<i>Applicable Standards</i>	<i>Requirements for Demonstrating Attainment of or Compliance With the Standards</i>	<i>Relevant USEPA Guidance</i>
Waste Analysis Drivers in Other RCRA Regulations (continued)			
Corrective Action for Solid Waste Management Units	EPA includes corrective action in permits through the following statutory citations: Section 3008(h) - provides authority to require corrective action at interim status facilities Section 3004(u) - requires corrective action be addressed as a condition of a facility's Part B permit Section 3004(v) - provides authority to require corrective action for releases migrating beyond the facility boundary Section 3005(c)(3) - provides authority to include additional requirements in a facility's permit, including corrective action requirements Section 7003 - gives EPA authority to take action when contamination presents an imminent hazard to human health or the environment	Often the first activity in the corrective action process is the RCRA facility Assessment (RFA), which identifies potential and actual releases from solid waste management units (SWMUs) and make preliminary determinations about releases, the need for corrective action, and interim measures. Another activity in the corrective action process is the RCRA Facility Investigation (RFI), which takes place when a release has been identified and further investigation is necessary. The purpose of the RFI is to gather enough data to fully characterize the nature, extent, and rate of migration of contaminants to determine the appropriate response action. Once the implementing agency has selected a remedy, the facility enters the Corrective Measures Implementation (CMI) phase, in which the owner and operator of the facility implements the chosen remedy. Corrective action may include various sampling and monitoring requirements.	There is a substantial body of guidance and publications related to RCRA corrective action. See the following link for further information: http://www.epa.gov/epaoswer/hazwaste/ca/resource.htm
§264.552 - Corrective Action Management Units	There are ground-water monitoring, closure, and post-closure requirements for CAMUs.	All requirements are case-by-case and are determined in the facility permit.	There are numerous guidance documents available. See the following link for further information: http://www.epa.gov/epaoswer/hazwaste/ca/resource.htm

Table B-1. Summary of Waste Analysis Drivers for Major RCRA Regulatory Program Areas

<i>40 CFR Citation and Description</i>	<i>Applicable Standards</i>	<i>Requirements for Demonstrating Attainment of or Compliance With the Standards</i>	<i>Relevant USEPA Guidance</i>
Waste Analysis Drivers in Other RCRA Regulations (continued)			
Parts 264/265 - Subpart AA - Air Emission Standards	<p>The following types of units are subject to the Subpart AA process vent standards:</p> <ul style="list-style-type: none"> • Units subject to the permitting standards of Part 270 (i.e., permitted or interim status) • Recycling units located at hazardous waste management facilities otherwise subject to the permitting standards of Part 270 (i.e., independent of the recycling unit, the facility has a RCRA permit or is in interim status) • Less than 90-day large quantity generator units. 	<p>Testing and statistical methods are specified in the regulations at §264.1034(b).</p>	<p>The primary source of guidance is the regulations.</p> <p>See also the final rulemakings that promulgated the regulations: June 21, 1990 (55 <i>FR</i> 25494) November 25, 1996 (62 <i>FR</i> 52641) June 13, 1997 (62 <i>FR</i> 32462)</p>
Parts 264/265 - Subpart BB - Air Emission Standards	<p>The following types of units are subject to the Subpart BB equipment leak standards:</p> <ul style="list-style-type: none"> • Units subject to the permitting standards of Part 270 (i.e., permitted or interim status) • Recycling units located at hazardous waste management facilities otherwise subject to the permitting standards of Part 270 (i.e., independent of the recycling unit, the facility already has a RCRA permit or is in interim status) • Less than 90-day large quantity generator units 	<p>The standards specify the type and frequency of all inspection and monitoring activities required. These requirements vary depending on the piece of equipment at the facility. Testing and statistical methods are specified in the regulations at §264.1063(c).</p>	<p>The primary source of guidance is the regulations.</p> <p>See also the final rulemakings that promulgated the regulations: June 21, 1990 (55 <i>FR</i> 25494) June 13, 1997 (62 <i>FR</i> 32462)</p>

Table B-1. Summary of Waste Analysis Drivers for Major RCRA Regulatory Program Areas

40 CFR Citation and Description	Applicable Standards	Requirements for Demonstrating Attainment of or Compliance With the Standards	Relevant USEPA Guidance
Waste Analysis Drivers in Other RCRA Regulations (continued)			
§266.112 - Regulation of Residues	A residue from the burning or processing of hazardous waste may be exempt from hazardous waste determination if the waste derived residue is either: substantially similar to normal residue or below specific health based levels for both metal and nonmetal constituents.	Concentrations must be determined based on analysis of one or more samples obtained over a 24-hour period. Multiple samples may be analyzed and composite samples may be used provided the sampling period does not exceed 24 hours. If more than one sample is analyzed to represent the 24-hour period, the concentration shall be the arithmetic mean of the concentrations in the samples.	The regulations under §266.112 have specific sampling and analysis requirements Part 266, Appendix IX
Part 270 - Subpart B - Permit Application, Hazardous Waste Permitting	Provides the corresponding permit requirement to the general requirements (including the requirement for a waste analysis plan) under §270.14. There are also unit-specific waste analysis, monitoring, and sampling requirements incinerators (§270.19) and boilers and industrial furnaces (§270.22). There are also specific requirements for dioxin listings handled in waste piles (§270.18) and landfills (§270.21).	The permittee must conduct appropriate sampling procedures, and retain results of all monitoring. All requirements are facility specific and are set forth in the permit and waste analysis plan.	<i>Test Methods for Evaluating Solid Waste, Physical/Chemical Methods, Updates I, II, IIA, IIB, III, and IIIA. SW-846. (USEPA 1986a)</i> <i>Waste Analysis at Facilities That Generate, Treat, Store, and Dispose of Hazardous Wastes, a Guidance Manual, EPA530-R-94-024 (USEPA 1994a)</i>
Part 270 - Subpart C - Conditions Applicable to All Permits	Under §270.30, there are specific requirements for monitoring and recordkeeping. Section 270.31 requires monitoring to be detailed in the permit.	The permittee must conduct appropriate sampling procedures, and retain results of all monitoring. All requirements are facility specific and are set forth in the permit and waste analysis plan.	<i>Test Methods for Evaluating Solid Waste, Physical/Chemical Methods, Updates I, II, IIA, IIB, III, and IIIA. SW-846. (USEPA 1986a)</i> <i>Waste Analysis at Facilities That Generate, Treat, Store, and Dispose of Hazardous Wastes, a Guidance Manual, EPA530-R-94-024 (USEPA 1994a)</i>

Table B-1. Summary of Waste Analysis Drivers for Major RCRA Regulatory Program Areas

<i>40 CFR Citation and Description</i>	<i>Applicable Standards</i>	<i>Requirements for Demonstrating Attainment of or Compliance With the Standards</i>	<i>Relevant USEPA Guidance</i>
Waste Analysis Drivers in Other RCRA Regulations (continued)			
Part 270 - Subpart F - Special Forms of Permits	Specifies sampling and monitoring requirements based on trial burns for incinerators (§270.62) and Boiler and Industrial Furnaces (§270.66).	Waste analysis and sampling requirements are site specific and set forth in each facility's waste analysis plan required under 264.13.	<p><i>Test Methods for Evaluating Solid Waste, Physical/Chemical Methods, Updates I, II, IIA, IIB, III, and IIIA. SW-846. (USEPA 1986a)</i></p> <p><i>Waste Analysis at Facilities That Generate, Treat, Store, and Dispose of Hazardous Wastes, a Guidance Manual, EPA530-R-94-024 (USEPA 1994a)</i></p>
Part 273 - Universal Wastes	Handlers and transporters of universal wastes must determine if any material resulting from a release is a hazardous waste. (§273.17(b) for small quantity handlers, §273.37(b) for large quantity handlers, and §273.54 for transporters of universal wastes) Also, if certain universal wastes are dismantled, such as batteries or thermostats, in certain cases the resulting materials must be characterized for hazardous waste purposes. (§§273.13(a)(3) and (c)(3)(i))	Sampling and analysis requirements are identical to hazardous waste identification requirements.	<p><i>Test Methods for Evaluating Solid Waste, Physical/Chemical Methods, Updates I, II, IIA, IIB, III, and IIIA. SW-846. (USEPA 1986a)</i></p> <p><i>Universal Waste Final Rule, 60 FR 25492; May 11, 1995</i></p> <p><i>Final rule adding Fluorescent Lamps, 64 FR 36465; July 6, 1999</i></p>

Table B-1. Summary of Waste Analysis Drivers for Major RCRA Regulatory Program Areas

40 CFR Citation and Description	Applicable Standards	Requirements for Demonstrating Attainment of or Compliance With the Standards	Relevant USEPA Guidance
Waste Analysis Drivers in Other RCRA Regulations (continued)			
Part 279 - Standards for the Management of Used Oil	Specifies sampling and analysis procedures for owners or operators of used-oil processing and re-refining facilities.	Under §279.55, owners or operators of used oil processing and re-refining facilities must develop and follow a written analysis plan describing the procedures that will be used to comply with the analysis requirements of §279.53 and/or §279.72. The plan must be kept at the facility.	Sampling: Part 261, Appendix I <i>Hazardous Waste Management System; Identification and Listing of Hazardous Waste; Recycled Used Oil Management Standards</i> , 57 FR 41566, September 10, 1992 <i>Part 279 Requirements: Used Oil Management Standards</i> , EPA530-H-98-001

This page intentionally left blank

APPENDIX C

STRATEGIES FOR SAMPLING HETEROGENEOUS WASTES

C.1 Introduction

“Heterogeneous wastes” include structures, demolition debris, waste-construction materials, containers (e.g., drums, tanks, and paint cans), solid waste from laboratories and manufacturing processes, and post-consumer wastes (e.g., electronics components, battery casings, and shredded automobiles) (USEPA and USDOE 1992). Heterogeneous wastes can pose challenges in the development and implementation of a sampling program due to the physical variety in size, shape, and composition of the material and the lack of tools and approaches for sampling heterogeneous waste. The application of conventional sampling approaches to heterogeneous waste is difficult and may not provide a representative sample.

To develop a sampling strategy for heterogeneous waste, it is first important to understand the scale, type, and magnitude of the heterogeneity. This appendix provides an overview of *large-scale heterogeneity* and provides some strategies that can be used to obtain samples of heterogeneous wastes. See also Section 6.2.1 for a description of other types of heterogeneity including short range (small-scale) heterogeneity (which includes distribution and constitution heterogeneity).

Additional guidance on sampling heterogeneous waste can be found in the following documents:

- *Characterizing Heterogeneous Wastes: Methods and Recommendations* (USEPA and USDOE 1992)
- *Standard Guide for Sampling Strategies for Heterogeneous Waste* (ASTM D 5956-96)
- *Pierre Gy's Sampling Theory and Sampling Practice: Heterogeneity, Sampling Correctness, and Statistical Process Control*. 2nd ed. (Chapter 21) (Pitard 1993), and
- *Geostatistical Error Management: Quantifying Uncertainty for Environmental Sampling and Mapping* (Myers 1997).

C.2 Types of Large-Scale Heterogeneity

The notion of heterogeneity is related to the scale of observation. An example given by Pitard (1993) and Myers (1997) is that of a pile of sand. From a distance of a few feet, a pile of sand appears to be uniform and homogeneous; however, at close range under magnification a pile of sand is heterogeneous. Substantial differences are found between the individual grains in their sizes, shapes, colors, densities, hardness, mineral composition, etc. For some materials, the differences between individual grains or items are not measurable or are not significant relative to the project objectives. In such a case, the degree of heterogeneity is so minor that for practical purposes the material can be considered homogeneous. The *Standard Guide for Sampling Strategies for Heterogeneous Waste* (ASTM D 5956-96) refers to this condition as

Appendix C

“practical homogeneity,” but recognizes that true homogeneity does not exist.

At a larger scale, such as an entire waste site, long-range (or large-scale) nonrandom heterogeneity is of interest. Large-scale heterogeneity reflects local trends and plays an important role in deciding whether to use a geostatistical appraisal to identify spatial patterns at the site, to use stratified sampling design to estimate a parameter (such as the overall mean), or to define the boundaries of the sampling problem so that it comprises two or more decision units that are each internally relatively homogeneous.

Items, particles, or phases within a waste or site can be distributed in various ways to create distinctly different types of heterogeneity. These types of heterogeneity include:

- **Random heterogeneity** – occurs when dissimilar items are randomly distributed throughout the population.
- **Non-random heterogeneity** – occurs when dissimilar items are nonrandomly distributed, resulting in the generation of strata. The term *strata* refers to subgroups of a population separated in space, in time, or by component from the remainder of the population. Strata are internally consistent with respect to a target constituent or a property of interest and are different from adjacent portions of the population.

The differences between items or particles that result in heterogeneity are due to differences in their composition or properties. One of these properties – particle size – deserves special consideration because significant differences in particle size are common and can complicate sampling due to the fundamental error. Fundamental error can be reduced only through particle-size reduction or the collection of sufficiently large samples. (Section 6 describes the impacts that fundamental error and particle size can have on sampling error.)

Figure C-1 depicts populations exhibiting the three types of heterogeneity described in ASTM D 5956-96 *Standard Guide for Sampling Strategies for Heterogeneous Waste*: (1) homogeneous, (2) randomly heterogeneous, (3) and nonrandomly heterogeneous populations. The drum-like populations portray different types of *spatial* distributions while the populations being discharged through the pipes represent different types of *temporal* distributions.

In the first scenario, very little spatial or temporal variation is found between the identical particles of the “homogeneous” population; however, in the second scenario, spatial and temporal variations are present due to the difference between the composition of the particles or items that make up the waste. ASTM D 5956-96 refers to this as a “randomly heterogeneous” population. In the third scenario, the overall composition of the particles or items remain the same as in the second scenario, but the two different components have segregated into distinct strata (e.g., due to gravity), with each strata being internally homogeneous. ASTM D 5956-96 refers to waste with this characteristic as “non-randomly heterogeneous.”

C.3 Magnitude of Heterogeneity

The *magnitude* of heterogeneity is the degree to which there are differences in the characteristic of interest between fragments, particles, or volumes within the population. The magnitude of heterogeneity can range from that of a population whose items are so similar that it is practically

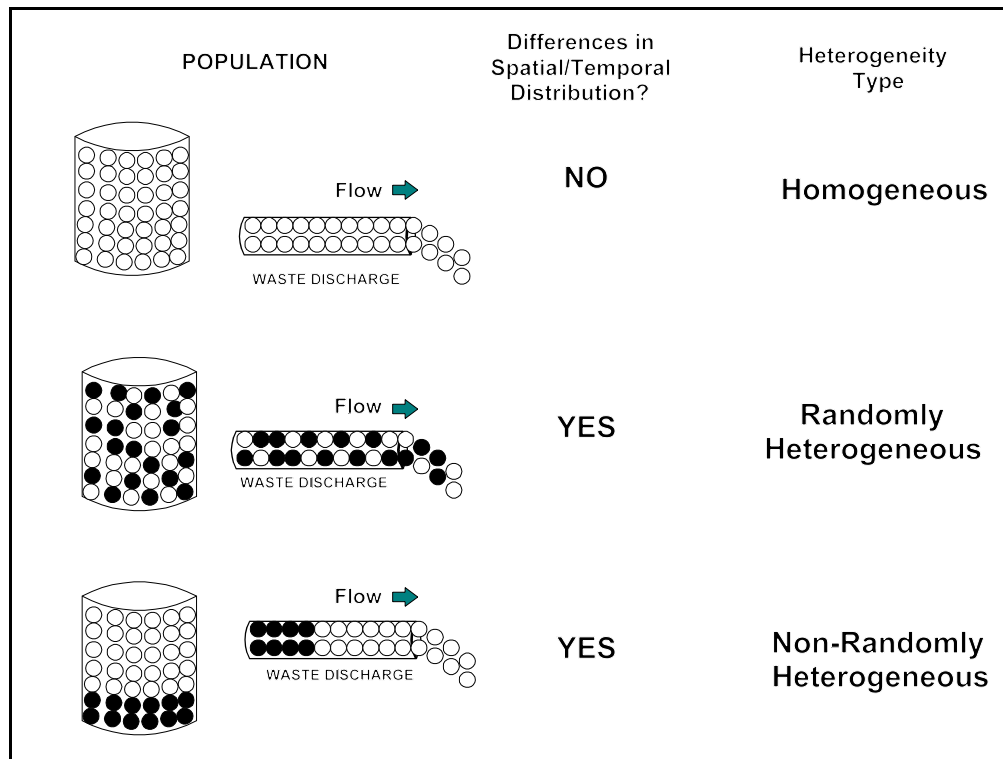

Figure C-1. Different types of spatial and temporal heterogeneity.

homogeneous to a population whose items are all dissimilar. Statistical measures of dispersion, the variance and standard deviation, are useful indicators of the degree of heterogeneity within a waste or waste site (assuming sampling error is not a significant contributor to the variance -- an optimistic assumption).

If the waste exhibits *nonrandom* heterogeneity and a *high magnitude* of heterogeneity, then consider segregating (e.g., at the point of generation) and managing the waste as two or more separate decision units (if physically possible and allowed by regulations). This approach will require prior knowledge (for example, from a pilot study) of the portions of the waste that fall into each specified category (such as hazardous debris and nonhazardous debris).

C.4 Sampling Designs for Heterogeneous Wastes

The choice of a sampling design to characterize heterogeneous waste will depend upon the regulatory objective of the study (e.g., waste identification or classification, site characterization, etc.), the data quality objectives, the type and magnitude of the heterogeneity, and practical considerations such as access to all portions of the waste, safety, and the availability of equipment suitable for obtaining and preparing samples.

As described in Section 5 of this document, there are two general categories of sampling designs: *probability* sampling design and *authoritative* (nonprobability) sampling designs. Probability sampling refers to sampling designs in which all parts of the waste or media under study have a known probability of being included in the sample. This assumption may be difficult to support when sampling highly heterogeneous materials such as construction debris.

Appendix C

All parts of a highly heterogeneous waste may not be accessible by conventional sampling tools, limiting the ability to introduce some form of randomness into the sampling design.

Random Heterogeneous Waste: For random heterogeneous waste, a probability sampling design such as simple random or systematic sampling can be used. At least one of two sample collection strategies, however, also should be used to improve the precision (reproducibility) of the sampling design: (1) take very large individual samples (to increase the sample support), or (2) take many increments to form each individual sample (i.e., use composite sampling). The concept of sample support is described in Section 6.2.3. Composite sampling is discussed in Section 5.3.

Non-Random Heterogeneous Waste: For non-random heterogeneous wastes, one of two strategies can be used to improve sampling: (1) If the objective is to estimate an *overall* population parameter (such as the mean), then stratified random sampling could be used. Stratified random sampling is discussed in detail in Section 5.2.2. (2) If the objective is to characterize each stratum separately (e.g., to classify the stratum as either a hazardous waste or a nonhazardous waste), then an appropriate approach is to separate or divert each stratum at its point of generation into discrete, nonoverlapping decision units and characterize and manage each decision unit separately (i.e., to avoid mixing or managing hazardous waste with nonhazardous waste).

If some form of stratified sampling is used, then one of three types of stratification must be considered. There are three types of stratification that can be used in sampling:

- stratification by space
- stratification by time
- stratification by component.

The choice of the type of stratification will depend on the type and magnitude of heterogeneity present in the population under consideration.

Figure C-2 depicts these different types of strata which are often generated by different processes or a significant variant of the same process. The different origins of the strata usually result in a different concentration or property distribution and different mean concentrations or average properties. While stratification over time or space is widely understood, stratification by component is less commonly employed. Some populations lack obvious spatial or temporal stratification yet display high levels of heterogeneity. If these populations contain easily identifiable components, such as bricks, gloves, pieces of wood or concrete, then it may be advantageous to consider the population as consisting of a number of component strata. An advantage of component stratification is that it can simplify the sampling and analytical process and allow a mechanism for making inferences to a highly stratified population. Component stratification shares many similarities with the gender or age stratification applied to demographic data by pollsters (i.e., the members of a given age bracket belonging to the same stratum regardless of where they reside). Component stratification is used by the mining industry to assay gold ore and other commodities where the analyte of interest is found in

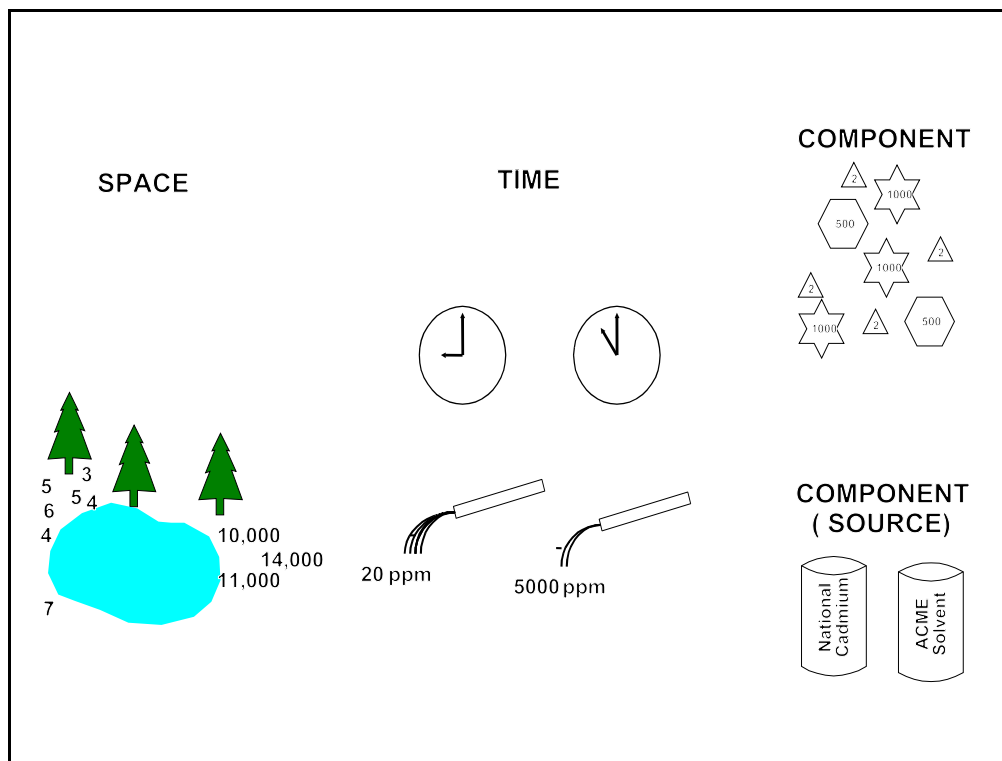

Figure C-2. Three different types of strata (from ASTM 5956-96)

discrete particles relative to a much greater mass of other materials.

Component stratification, although not commonly employed, is applicable to many waste streams, including the more difficult-to-characterize waste streams such as building debris. Additional guidance on stratification by component can be found in ASTM D 5956-96.

Table C-1 offers practical examples when wastes considered “non-randomly heterogeneous” might be good candidates for stratification across space, time, or by component.

The stratification approach can result in a more precise estimate of the mean compared to simple random sampling. However, keep in mind that greater precision is likely to be realized only if a waste exhibits substantial nonrandom chemical heterogeneity and stratification efficiently “divides” the waste into strata that exhibit maximum between-strata variability and minimum within-strata variability. If that does not occur, stratified random sampling can produce results that are less precise than in the case of simple random sampling; therefore, it is reasonable to employ stratified sampling only if the distribution of chemical contaminants in a waste is sufficiently known to allow an intelligent identification of the strata and at least two or three samples can be collected in each stratum.

Note that failure to recognize separate strata might lead one to conclude incorrectly, via a statistical test, that the underlying population is lognormal or some other right-skewed distribution.

Table C-1. Examples of Three Types of Stratification

Type of Stratification	Example Scenario
Stratification Across Space	A risk-based cleanup action requires a site owner to remove the top two feet of soil from a site. Prior to excavation, the waste hauler wants to know the average concentration of the constituent of concern in the soil to be removed. The top six inches of soil are known to be more highly contaminated than the remaining 18-inches of soil. Sampling of the soil might be carried out more efficiently by stratifying the soil into two subpopulations - the upper six-inch portion and the lower 18-inch portion.
Stratification Across Time	A waste discharge from a pipe varies across time. If the objective is to estimate the overall mean, then an appropriate sampling design might include stratification across time.
Stratification by Component	Construction debris covered with lead-based paint in the same structure with materials such as glass and unpainted wood could be sampled by components (lead-based paint debris, glass, and unpainted wood). This strategy is known as "stratification by component" (from ASTM D 5956-96).

C.5 Sampling Techniques for Heterogeneous Waste

Due to practical constraints, conventional sampling approaches may not be suitable for use in sampling of heterogeneous wastes. For example, sampling of contaminated debris can pose significant challenges due to the high degree of heterogeneity encountered. Methods used to sample contaminated structures and debris have included the following:

- Coring and cutting pieces of debris followed by crushing and grinding of the matrix (either in the field or within the laboratory) so the laboratory can handle the sample in a manner similar to a soil sample (Koski, et al 1991)
- Drilling of the matrix (e.g., with a hand held drill) followed by collection of the cuttings for analysis. This technique may require 20 to 50 drill sites in a local area to obtain a sufficient volume for an individual field sample (Koski, et al 1991)
- Grinding an entire structure via a tub grinder followed by conventional sampling approaches (AFCEE 1995).

ASTM has published a guide for sampling debris for lead-based paint (LBP) in ASTM E1908-97 *Standard Guide for Sample Selection of Debris Waste from a Building Renovation or Lead Abatement Project for Toxicity Characteristic Leaching Procedure (TCLP) testing for Leachable Lead (Pb)*.

Additional methods are described in Chapter Five, "Sample Acquisition," of *Characterizing Heterogeneous Wastes: Methods and Recommendations* (USEPA and USDOE 1992) and in Rupp (1990).

APPENDIX D

A QUANTITATIVE APPROACH FOR CONTROLLING FUNDAMENTAL ERROR

This appendix provides a basic approach for determining the particle-size sample-weight relationship sufficient to achieve the fundamental error level specified in the DQOs. The procedure is based on that described by Pitard (1989, 1993), Gy (1998), and others; however, a number of simplifying assumptions have been made for ease of use. *The procedure described in this appendix is applicable to sampling of granular solid media (including soil) to be analyzed for nonvolatile constituents. It is not applicable to liquids, oily wastes, or debris.*

The mathematical derivation of the equation for the fundamental error is complex and beyond the scope of this guidance. Readers interested in the full documentation of the theory and underlying mathematics are encouraged to review Gy (1982) and Pitard (1993). Several authors have developed example calculations for the variance of the fundamental sampling error for a “typical” contaminated soil to demonstrate its practical application.¹ Examples found in Mason (1992), and Myers (1997) may be particularly useful.

The equation for the variance of the fundamental error is extremely practical for optimization of sampling protocols (Pitard 1993). In a relatively simple “rule of thumb” form, the equation for the variance of the fundamental error (s_{FE}^2) is estimated by

$$s_{FE}^2 = \frac{f\lambda}{M_s} \left(\frac{1}{a_{LC}} - 2 \right) d^3 \quad \text{Equation D.1}$$

where

- f = a dimensionless “shape” factor for the shape of particles in the material to be sampled where cubic = 1.0, sphere = 0.523, flakes = 0.1, and needles = 1 to 10
- λ = average density (gm/cm³) of the material
- M_s = the sample weight (or mass of sample) in grams
- a_{LC} = proportion of the sample with a particle size less than or equal to the particle size of interest
- d = diameter of the largest fragment (or particle) in the waste, in centimeters.

Pitard’s methodology suggests the particle size of interest should be set at 95 percent of the largest particle in the population (or “lot”), such that $a_{LC} = 0.05$. Equation D.1 then reduces to

$$s_{FE}^2 = \frac{f\lambda}{M_a} 18d^3 \quad \text{Equation D.2}$$

¹ It is important to note that discussion of the “variance of the fundamental error” refers to the relative variance, which is the ratio of the sample variance over square of the sample mean (s^2/\bar{x}^2). The relative variance is useful for comparing results from different experiments.

Appendix D

The equation demonstrates that the variance of the fundamental error is directly proportional to the size of the largest particle and inversely proportional to the mass of the sample. To calculate the appropriate mass of the sample, Equation D.2 easily can be rearranged as

$$M_a = \frac{f\lambda}{(s_{FE})^2} 18d^3 \quad \text{Equation D.3}$$

Pitard (1989, 1993) proposed a “Quick Safety Rule” for use in environmental sampling using the following input assumptions for Equation D.3:

$$\begin{aligned} f &= 0.5 \text{ (dimensionless shape factor for a sphere)} \\ \lambda &= 2.7 \text{ (density of a waste in gm/cm}^3\text{)} \\ s_{FE} &= \pm 5\% \text{ (standard deviation of the fundamental error).} \end{aligned}$$

By putting these assumed factors into Equation D.3, we get:

$$M_s = \frac{0.5 \times 2.7}{(0.05)^2} 18d^3 \quad \text{Equation D.4}$$

Pitard (1993) rounds up, to yield the relationship

$$M_s \geq 10000d^3 \quad \text{Equation D.5}$$

Alternatively, if we are willing to accept $s_{FE} = \pm 16\%$, Equation D.4 yields

$$M_s \geq 1000d^3 \quad \text{Equation D.6}$$

Equation D.4 was used to develop Table D-1 showing the maximum particle size that is allowed for a given sample mass with the standard deviation of the fundamental error (s_{FE}) prespecified at various levels (e.g., 5%, 10%, 16%, 20%, and 50%). A table such as this one can be used to estimate the optimal weight of field samples and the optimal weight of subsamples prepared within the laboratory. An alternative graphical method is presented by Pitard (1993) and Myers (1997).

An important feature of the fundamental error is that it does not “cancel out.” On the contrary, the variance of the fundamental error adds together at each stage of subsampling. As pointed out by Myers (1997), the fundamental error can quickly accumulate and exceed 50%, 100%, 200%, or greater unless it is controlled through particle-size reduction. The variance of the fundamental error, s_{FE}^2 , calculated at each stage of subsampling and particle-size reduction must be added together at the end to derive the total s_{FE}^2 .

Table D-1. Maximum Allowable Particle Size (cm) for a Given Sample Mass for Selected Standard Deviations of the Fundamental Error

Sample Mass (g)	Maximum Allowable Particle Size d (cm)				
	$S_{FE} = 5\%$	$S_{FE} = 10\%$	$S_{FE} = 16\%^*$	$S_{FE} = 20\%$	$S_{FE} = 50\%$
0.1	0.02	0.03	0.05	0.05	0.10
1	0.05	0.07	0.10	0.12	0.22
2	0.06	0.09	0.13	0.15	0.27
3	0.07	0.11	0.15	0.17	0.31
4	0.07	0.12	0.16	0.19	0.35
5	0.08	0.13	0.17	0.20	0.37
10	0.10	0.16	0.22	0.25	0.47
20	0.13	0.20	0.28	0.32	0.59
30	0.15	0.23	0.32	0.37	0.68
40	0.16	0.25	0.35	0.40	0.74
50	0.17	0.27	0.37	0.43	0.80
75	0.20	0.31	0.43	0.50	0.92
100	0.22	0.35	0.47	0.55	1.01
500	0.37	0.59	0.81	0.94	1.73
1000	0.47	0.74	1.02	1.18	2.17
5000	0.80	1.27	1.74	2.02	3.72

*A maximum standard deviation of the fundamental error of 16% has been recommended by Pitard (1993) and is included in this table as a point of reference only. Project-specific fundamental error rates should be set in the DQO Process.

Two important assumptions underlie the use of Table D-1:

1. The table is valid only if each and all steps of the sampling and subsampling minimize other sampling error through use of careful and correct sampling procedures
2. The table is valid only for wastes or soils with a shape factor (f) and density (λ) similar to that used to derive the table; otherwise, waste-specific tables or graphical methods (see Pitard 1993, Mason 1992, or Myers 1997) should be used.

Hypothetical Example

Suppose we have a waste that is a particulate solid to be analyzed for total metals. The laboratory requires an analytical sample of only 1 gram. The DQO planning team wants to maintain the total standard deviation of the fundamental error (S_{FE}) within $\pm 16\%$. The sample masses are determined at each stage of sampling and subsampling as follows:

Primary Stage: Based on prior inspection of the waste, it is known that 95 percent of the particles are 0.47 cm in diameter or less. Using Table D-1, we determine that a field sample of 1,000 grams (or 1 Kg) will generate a fundamental error S_{FE} not greater than $\pm 5\%$.

Appendix D

Secondary Stage: After shipment of the 1,000-gram sample to the laboratory, particle-size reduction to about 0.23 cm (2.36 mm or a No. 8 sieve) is performed, and a 30-gram subsample is taken. This step generates a fundamental error S_{FE} of $\pm 10\%$.

Final Stage: A 1-gram subsample is required for the analysis. Particle-size reduction to 0.07 cm or less (e.g., a No. 30 sieve) is performed, and a 1-g subsample is taken. This step generates a fundamental error S_{FE} of $\pm 10\%$.

The variance (S_{FE}^2) from each stage is then summed to determine the *total* variance of the fundamental error. As shown in Table D-2, the total standard deviation of the fundamental error is less than ± 16 percent and the DQO is achieved.

Table D-2. Example Calculation of the Total Variance of the Fundamental Error

Sampling and Subsampling Stage	Mass (grams)	d (cm)	S_{FE}	S_{FE}^2
Primary Stage	1000	0.47	.05	.0025
Secondary Stage	30	0.23	.10	.01
Final Stage	1	0.07	.10	.01
Sum of the variances of the fundamental errors (S_{FE}^2)				$S_{FE}^2 = 0.0225$
Total standard deviation of the fundamental error (S_{FE}) (DQO = 16%)				$S_{FE} = 0.15$ or 15%

One final word of caution is provided regarding the use of the particle-size reduction and subsampling routine outlined above. The approach can reduce bias and improve precision of analyses for *total* constituent analyses, but the particle-size reduction steps may actually *introduce bias* when used in conjunction with some leaching tests. For example, the TCLP specifies a minimum sample mass of 100 grams (for nonvolatile extractions) and maximum particle size of 9.5 mm. While this combination would generate a S_{FE} of almost ± 50 percent, excessive particle-size reduction below 9.5 mm to lower S_{FE} would *increase* the leachability of the material during the test due to the increased surface area-to-volume ratio of smaller particles. Therefore, it is important to remember that particle-size reduction to control fundamental error is beneficial when total constituent analyses are performed, but may introduce bias for some leaching tests. Furthermore, particle-size reduction below 9.5 mm is *not required* by Method 1311 (TCLP) (except during Step 7.1.4, "Determination of Appropriate Extraction Fluid").

APPENDIX E

SAMPLING DEVICES

The key features of recommended sampling devices are summarized in this appendix. For each sampling device, information is provided in a uniform format that includes a brief description of the device and its use, advantages and limitations of the device, and a figure to indicate the general design of the device. Each summary also identifies sources of other guidance on each device, particularly any relevant ASTM standards.

Much of the information in this appendix was drawn from ASTM standards (see also Appendix J for summaries of ASTM standards). In particular, much of the information came from ASTM D 6232, *Standard Guide for Selection of Sampling Equipment for Waste and Contaminated Media Data Collection Activities*.

Devices not listed in this appendix or described elsewhere in this chapter also may be appropriate for use in RCRA-related sampling. For example, other more innovative or less common technologies may allow you to meet your performance goals and may be appropriate for your sampling effort. Therefore, we encourage and recommend the selection and use of sampling equipment based on a performance-based approach. In future revisions to this chapter, we will include new technologies, as appropriate.

Internet Resource

Information on sampling devices can be found on the Internet at the Federal Remediation Technologies Roundtable site at <http://www.frtr.gov/>. The Field Sampling and Analysis Technologies Matrix and accompanying Reference Guide are intended as an initial screening tool to provide users with an introduction to innovative site characterization technologies and to promote the use of potentially cost-effective methods for onsite monitoring and measurement.

This appendix is divided into subsections based on various categories of sampling technologies. The categories are based on those listed in ASTM D 6232. The equipment categories covered within this appendix are as follows:

- E.1 Pumps and Siphons
- E.2 Dredges
- E.3 Discrete Depth Samplers
- E.4 Push Coring Devices
- E.5 Rotating Coring Devices
- E.6 Liquid Profile Devices
- E.7 Surface Sampling Devices

E.1 Pumps and Siphons

Pumps and siphons can be used to obtain samples of liquid wastes and ground water. For detailed guidance on the selection and use of pumps for sampling of ground water, see *RCRA Ground-Water Monitoring: Draft Technical Guidance* (USEPA 1992c).

In this section, you will find summaries for the following pumps or siphons:

Appendix E

- E.1.1 Automatic Sampler
- E.1.2 Bladder Pump
- E.1.3 Peristaltic Pump
- E.1.4 Centrifugal Submersible Pump
- E.1.5 Displacement Pumps

E.1.1 Automatic Sampler

An automatic sampler (see Figure E-1) is a type of pumping device used to periodically collect samples. It is recommended for sampling surface water and point discharges. It can be used in waste-water collection systems and treatment plants and in stream sampling investigations. An automatic sampler designed for collection of samples for volatile organic analyses is available.

An automatic sampler typically uses peristaltic pumps as the sampling mechanism. It can be programmed to obtain samples at specified intervals or to obtain a continuous sample. It also can be programmed to collect time composite or flow proportional samples.

Advantages

- Can provide either grab sample or composite samples over time.
- Operates unattended, and it can be programmed to sample variable volumes at variable times.

Limitations

- Requires power to operate (either AC or battery power).
- May be difficult to decontaminate.
- May not operate correctly when sampling liquid streams containing a high percentage of solids.
- Highly contaminated water or waste can degrade sampler components.

Other Guidance

- *Standard Guide for Selection of Sampling Equipment for Waste and Contaminated Media Data Collection Activities*, ASTM D 6232.

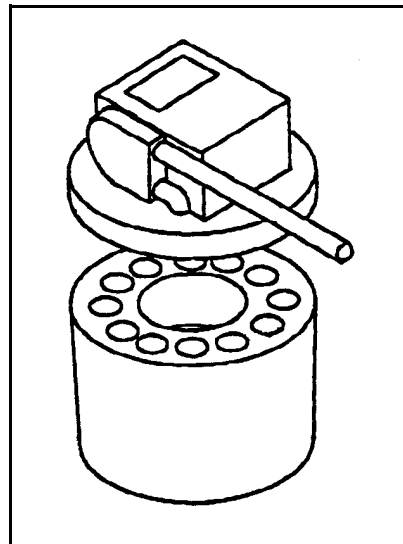

Figure E-1. Automatic sampler

E.1.2 Bladder Pump

The bladder pump is recommended for the sampling of surface water, ground water, and point discharges. It also can be used to sample other liquids in surface impoundments.

A bladder pump consists of a flexible membrane (bladder) enclosed by a rigid sample container and can be constructed of a variety of materials, such as neoprene, rubber, stainless steel, nitrile, etc. There are two types of bladder pumps - the squeeze type and the expanding type (see Figure E-2). The squeeze type has the bladder connected to the sample discharge line. The chamber between the bladder and the sampler body is connected to the gas line. The expanding type has the bladder connected to the gas line. In this type of bladder pump, the chamber between the bladder and the sampler body is connected to the sample discharge line.

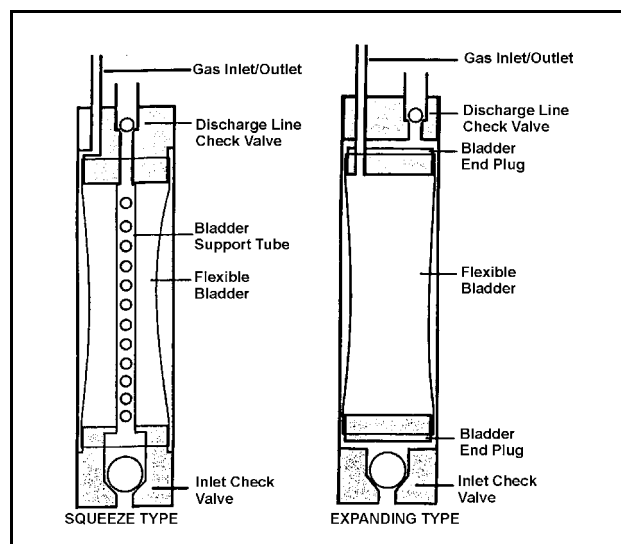

Figure E-2. Bladder pump

During sampling, water enters the sampler through a check valve at the bottom of the device. Compressed air or gas is then injected into the sampler. This causes the bladder to expand or compress depending on the type of bladder pump. The inlet valve closes and the contents of the sampler are forced through the top check valve into the discharge line. The top check valve prevents water from re-entering the sampler. By removing the pressure, the process is repeated to collect more sample. Automated sampling systems have been developed to control the time between pressurization cycles.

Advantages

- Is suitable for sampling liquids containing volatile compounds.
- Can collect samples up to a depth of 60 m (200 ft.) (ASTM D 6232).

Limitations

- Operation requires large volumes of compressed air or gas and a controller.
- Requires a power source.
- Can be heavy and difficult to operate.
- Decontamination can be difficult.

Other Guidance

- *Standard Guide for Selection of Sampling Equipment for Waste and Contaminated Media Data Collection Activities*, ASTM D 6232
- *Standard Guide for Sampling Groundwater Monitoring Wells*, ASTM D 4448

E.1.3 Peristaltic Pump

A peristaltic pump (Figure E-3) is a suction lift pump used at the surface to collect liquid from ground-water monitoring wells or surface impoundments. It can be used for sampling surface water, ground water, point discharges, impounded liquids, and multi-layer liquid wastes.

A peristaltic pump consists of a rotor with ball bearing rollers and it has a piece of flexible tubing threaded around the pump rotor and connected to two pieces of polytetrafluoroethylene (PTFE) or other suitable tubing. One end of the tubing is placed in the sample. The other end is connected to a sample container. Silicone tubing is commonly used within the pumphead; however, for organic sampling purposes, medical grade silicone is recommended to avoid contamination of the sample (ASTM D 4448). Fluorocarbon resin tubing is also sometimes used for high hazard materials and for samples to be analyzed for organics (ASTM D 6063). The device can be modified to avoid contact of the sample with the flexible tubing. In such a case, the pump is connected to a clean glass container using a PTFE insert. A second PTFE tubing is used to connect the glass container to the sample source.

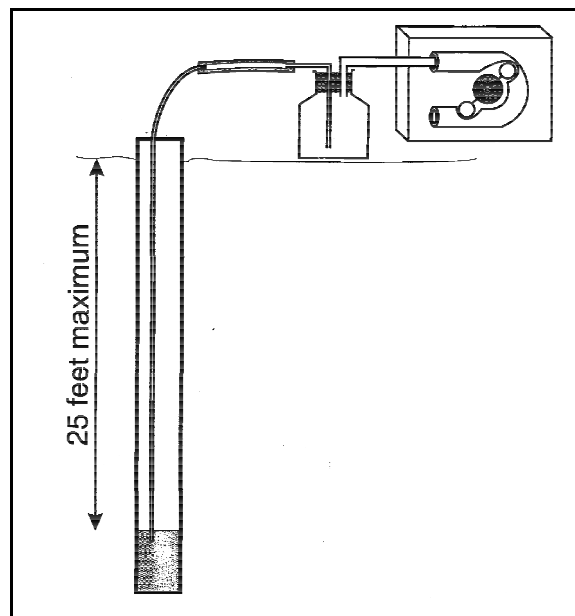

Figure E-3. Peristaltic pump

During operation, the rotor squeezes the flexible tubing, causing a vacuum to be applied to the inlet tubing. The sample material is drawn up the inlet tubing and discharged through the outlet end of the flexible tubing. In the modified peristaltic pump, the sample is emptied into the glass container without coming in contact with the flexible tubing. To sample liquids from drums, the peristaltic pump is first used to mix the sample. Both ends of the tubing are placed in the sample and the pump is turned on. Once the drum contents are mixed, the sample is collected as described above. To collect samples for organic volatile analyses, the PTFE tubing attached to the intake end of the pump is filled with the sample and then disconnected from the pump. The tube is then drained into the sample vials.

Advantages

- Can collect samples from multiple depths and small diameter wells.
- Easy to use and readily available.

- The pump itself does not need to be decontaminated. The tubing can be either decontaminated or replaced.

Limitations

- The drawing of a vacuum to lift the sample may cause the loss of volatile contaminants.
- Sampling depth cannot exceed about 7.6 m (25 ft.) (ASTM D 6232).
- Requires a power source.
- Flexible tubing may be incompatible with certain matrices.

Other Guidance

- *Standard Guide for Selection of Sampling Equipment for Waste and Contaminated Media Data Collection Activities*, ASTM D 6232
- *Standard Guide for Sampling of Drums and Similar Containers by Field Personnel*, ASTM D 6063
- *Standard Guide for Sampling Groundwater Monitoring Wells*, ASTM D 4448

E.1.4 Centrifugal Submersible Pump

The centrifugal submersible pump (Figure E-4) is a type of pump used for purging and sampling monitoring wells, sampling of waste water from impoundments, and sampling point discharges.

A centrifugal submersible pump uses a set of impellers, powered by an electric motor, to draw water up and through a discharge hose. Parts in contact with liquid may be made of PTFE and stainless steel. The pump discharge hose can be made of PTFE or other suitable material. The motor cavity is filled with either air or deionized or distilled water that may be replaced when necessary. Flow rates for centrifugal submersible pumps range from 100 mL per minute to 9 gallons per minute (ASTM D 6232).

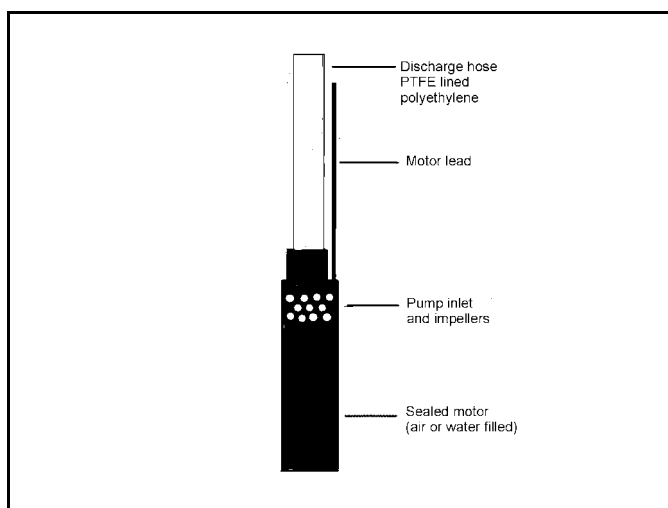

Figure E-4. Centrifugal submersible pump

During operation, water is drawn into the pump by a slight suction created by the rotation of the impellers. The impellers work against fixed stator plates and pressurize the water which is driven to the surface through the discharge hose. The speed at which the impellers are driven controls the pressure and, thus, the flow rate.

Appendix E

Advantages

- Can be constructed of materials (PTFE and stainless steel) that are chemically resistant.
- Can be used to pump liquids up to a 76 m (250 ft) head (ASTM D 6232).
- Flow rate is adjustable.

Limitations

- May be incompatible with liquids containing a high percentage of solids.
- May not be appropriate for collection of samples for volatile organics analysis. Loss of volatiles can occur as a result of motor heating and sample pressurization.
- Requires an electric power source; e.g., either a 12 v (DC) or a 110/220 v (AC) converter (ASTM D 6232).
- May require a winch or reel system for portable use.

Other Guidance

- *Standard Guide for Selection of Sampling Equipment for Waste and Contaminated Media Data Collection Activities, ASTM D 6232*

E.1.5 Displacement Pumps

The displacement pump (Figure E-5) is a type of pump used for the sampling of surface water, ground water, point discharges and other liquids (e.g., in impoundments).

A displacement pump forces a discrete column of water to the surface via a mechanical lift. During sampling, water enters the sampler through the check valve at the bottom of the device. It is commonly constructed of PVC, stainless steel, or both. It also can be made of PTFE to reduce the risk of contamination when collecting samples with trace levels of organic compounds. Two common types of displacement pumps include the air/gas and piston displacement pumps.

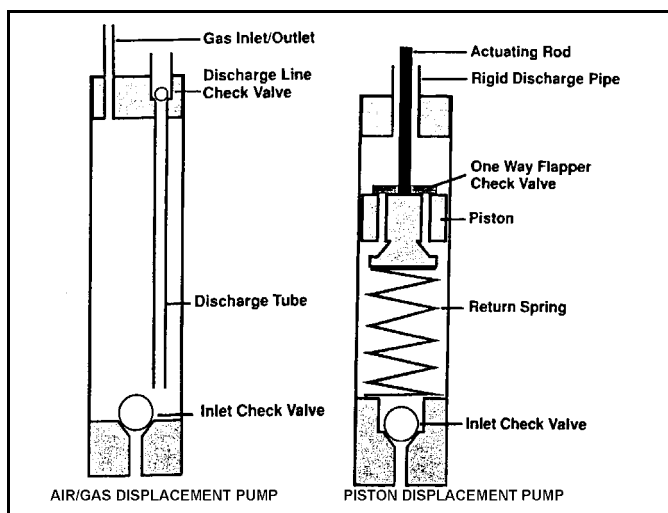

Figure E-5. Displacement pump

The air/gas displacement pump uses compressed gas and it operates by applying positive

pressure to the gas line. This causes the inlet check valve to close and the discharge line check valve to open, forcing water up the discharge line to the surface. Removal of the gas pressure causes the top valve to close and the bottom valve to open. Water enters the sampler and the process is repeated.

The piston displacement pump uses an actuating rod powered from the surface or from an air or electric actuator. The mechanically operated plunger delivers the sample to the surface at the same time the chamber fills. It has a flap valve on the piston and an inlet check valve at the bottom of the sampler.

Advantages

- Can be constructed of PTFE to reduce the risk of contamination caused by materials of construction when collecting samples for trace levels of organics.

Limitations

- May be difficult to decontaminate.
- Displacement pumps require large volumes of air or gas and a power source.
- Loss of dissolved gases or sample contamination from the driving gas may occur during sampling.
- Displacement pumps may be heavy.

Other Guidance

- *Standard Guide for Selection of Sampling Equipment for Waste and Contaminated Media Data Collection Activities*, ASTM D 6232
- *Standard Guide for Sampling Groundwater Monitoring Wells*, ASTM D 4448

E.2 Dredges

Dredges include equipment that is often used to collect bottom material (e.g., sediments) from beneath a layer of stationary or moving liquid. A variety of dredges are available including the **Ekman** bottom grab sampler and the **Ponar** dredge. The Ponar dredge is described below.

E.2.1 Ponar Dredge

The ponar dredge is recommended for sampling sediment. It has paired jaws that penetrate the substrate and close to retain the sample. The sample volume range is 0.5 to 3.0 liters (ASTM D 6232).

Appendix E

The Ponar dredge is lowered slowly with controlled speed so that the dredge will properly land and avoid blowout of the surface layer to be sampled. The weight of the dredge causes it to penetrate the substrate surface. The slack in tension unlocks the open jaws and allows the dredge to close as it is raised. The dredge is raised slowly to minimize disturbance and sample washout as the dredge is retrieved through the liquid column. The collected sample is emptied into a suitable container. Auxiliary weight may be added to the dredge to increase penetration.

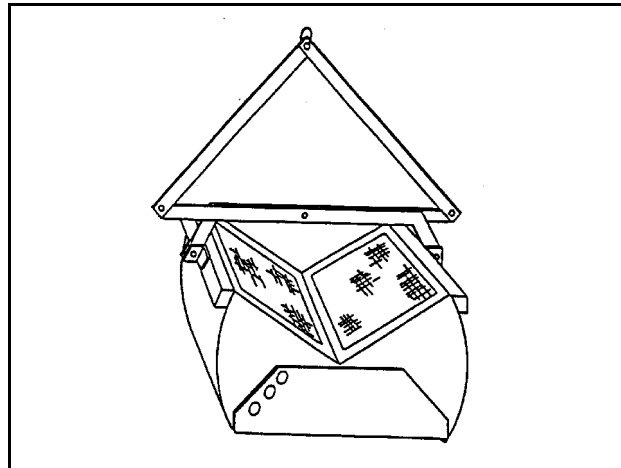

Figure E-6. Ponar dredge

Advantages

- Reusable
- Can obtain samples of most types of stationary sediments ranging from silt to granular material
- Available in a range of sizes and weights
- Some models may be available in either stainless steel or brass.

Limitations

- Not capable of collecting undisturbed samples
- May be difficult to decontaminate (depending upon the dredge's design and characteristics of the sampled material)
- Cannot collect a representative lift or repeatedly sample to the same depth and position
- Can be heavy and require a winch or portable crane to lift; however, a smaller version, the petit Ponar, is available and can be operated by a hand-line (ASTM D 4342).

Other Guidance

- *Standard Guide for Selection of Sampling Equipment for Waste and Contaminated Media Data Collection Activities*, ASTM D 6232
- *Standard Practice for Collecting of Benthic Macroinvertebrates with Ponar Grab Sampler*, ASTM D 4342
- *Standard Guide for Selecting Grab Sampling Devices for Collecting Benthic Macroinvertebrates*, ASTM D 4387

- “Sediment Sampling” (USEPA 1994e)

E.3 Discrete Depth Samplers

Discrete depth samplers include equipment that can collect samples at a specific depth. Such samplers are sometimes used to collect samples from layered liquids in tanks or surface impoundments. You will find summaries for the following discrete depth samplers in this section:

- E.3.1 Bacon Bomb
- E.3.2 Kemmerer Sampler
- E.3.3 Syringe Sampler
- E.3.4 Lidded Sludge/Water Sampler
- E.3.5 Discrete Level Sampler

Besides the samplers listed below, a self-purging, discrete depth sampler is available for sampling ground-water monitoring wells. It fills when stopped at the desired depth and eliminates the need for well purging. It samples directly into a 40-mL glass VOA sample vial contained within the sampler; therefore, the loss of volatile organic compounds is minimized.

E.3.1 Bacon Bomb

A bacon bomb (Figure E-7) is a type of discrete level sampler that provides a sample from a specific depth in a stationary body of water or waste. A bacon bomb is recommended for sampling surface water and is usually used to collect samples from a lake or pond. It can also be used to collect liquid waste samples from large tanks or lagoons. It originally was designed to collect oil samples. The sample volume range is from 0.1 to 0.5 liters (100 to 500 mL) (ASTM D 6232).

A bacon bomb has a cylindrical body sometimes constructed of stainless steel, but it is sometimes made of chrome-plated brass and bronze. It is lowered into material by a primary support line and has an internal tapered plunger that acts as a valve to admit the sample. A secondary line attached to the top of the plunger opens and closes the plunger valve. The top cover has a locking mechanism to keep the plunger closed after sampling. The bacon bomb remains closed until triggered to collect the sample. Sample collection is triggered by raising the plunger line and allowing the sampler to fill. The device is then closed by releasing the plunger line. It is returned to the surface by raising the primary support line, and the sample is transferred directly to a container.

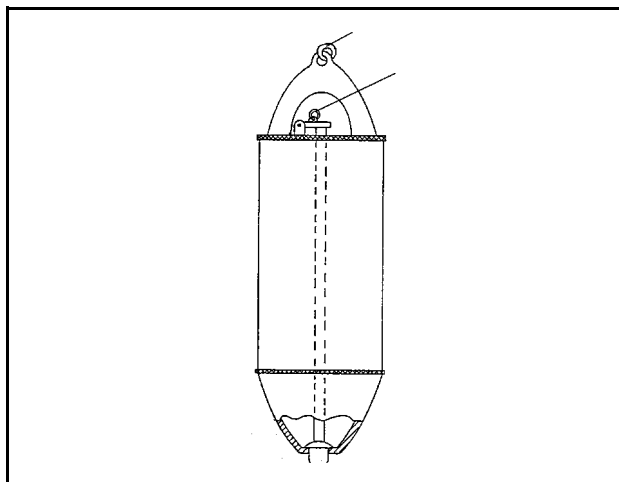

Figure E-7. Bacon bomb

Appendix E

Advantages

- Collects a discrete depth sample; it is not opened until the desired depth.
- Easy to use, without physical requirement limitations.

Limitations

- May be difficult to decontaminate due to design or construction materials.
- Maximum sample capacity is only 500 mL.
- Materials of construction may not be compatible with parameters of concern.

Other Guidance

- *Standard Guide for Selection of Sampling Equipment for Waste and Contaminated Media Data Collection Activities*, ASTM D 6232
- “Tank Sampling” (USEPA 1994c)

E.3.2 Kemmerer Sampler

A kemmerer sampler (Figure E-8) is a type of discrete level sampler that provides a sample from a specific depth. Recommended for sampling surface water, it is usually used to collect samples from a lake or pond. It can also be used to collect liquid waste samples from large tanks or lagoons. The sample volume range is from 1 to 2 liters (ASTM D 6232).

The sampler comprises a stainless steel or brass cylinder with rubber stoppers for the ends, but all PTFE construction also is available. The ends are left open while being lowered in a vertical position, allowing free passage of water or liquid through the cylinder. When the device is at the designated depth, a messenger is sent down a rope to close the stoppers at each end. The cylinder is then raised and the sample is removed through a valve to fill sample containers.

Advantages

- Can collect a discrete depth sample.

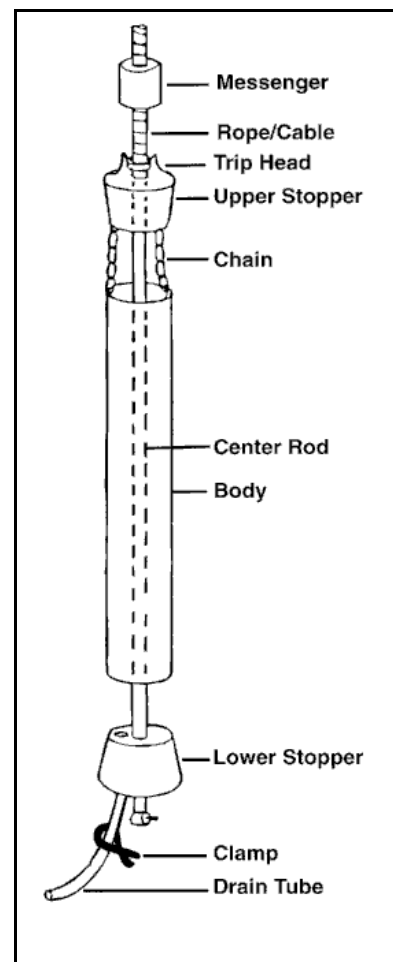

Figure E-8. Kemmerer sampler

- Provides correct delimitation and extraction of sample (Pitard 1989)
- Easy to use
- All PTFE construction is available.

Limitations

- May be difficult to decontaminate due to construction or materials.
- The sampler is exposed to the medium at other depths while being lowered to a sampling point at the desired depth.
- Materials of construction may not be compatible with parameters of concern.

Other Guidance:

- *Standard Guide for Selection of Sampling Equipment for Waste and Contaminated Media Data Collection Activities, ASTM D 6232*

E.3.3 Syringe Sampler

A syringe sampler (Figure E-9) is a discrete depth sampler used to sample liquids. With the optional coring tip, it can be used as a coring device to sample highly viscous liquids, sludges, and tar-like substances. It is used to collect samples from drums, tanks, and surface impoundments, and it can also draw samples when only a small amount remains at the bottom of a tank or drum. The sample volume range is 0.2 to 0.5 liters (ASTM D 6232).

A syringe sampler generally is constructed of a piston assembly that comprises a T-handle, safety locking nut, control rod, piston body assembly, sampling tube assembly, and two tips for the lower end (a closeable valve and a coring tip). When used as a syringe, the sampler is slowly lowered to the sampling point and the T-handle is gradually raised to collect the sample. Once the desired sample is obtained, the lock nut is tightened to secure the piston rod and the

bottom valve is closed by pressing down on the sampler against the side or bottom of the container. When used as a coring device, the sampler is slowly pushed down into the material. Once the desired sample is obtained, the lock nut is tightened to secure the piston rod and the sampler is removed from the media. The sample material is extruded into the sample container by opening the bottom valve (if fitted), loosening the lock nut, and pushing the piston down.

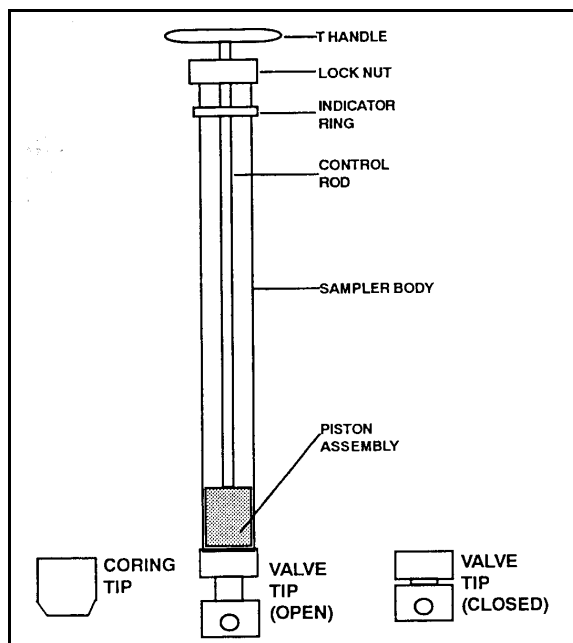

Figure E-9. Syringe sampler

Appendix E

Advantages

- The syringe sampler is easy to use and decontaminate.
- The syringe sampler can sample at discrete depths, including the bottom of a container.

Limitations

- The syringe sampler can be used to depths of about 1.8 meters only (ASTM D 6232).
- Material to be sampled must be viscous enough to remain in the device when the coring tip is used; the valve tip is not recommended for viscous materials (ASTM D 6063).

Other Guidance

- *Standard Guide for Sampling Single or Multilayered Liquids*, ASTM D 5743
- *Standard Guide for Selection of Sampling Equipment for Waste and Contaminated Media Data Collection Activities*, ASTM D 6232
- *Standard Guide for Sampling of Drums and Similar Containers by Field Personnel*, ASTM D 6063

E.3.4 Lidded Sludge/Water Sampler

A lidded sludge/water sampler (Figure E-10) is a type of discrete depth device that provides a sample from a specific depth. It is used to collect sludges or waste fluids from tanks, tank trucks, and ponds. It can sample liquids, multi-layer liquid wastes, and mixed-phase solid/liquid wastes. The typical sample volume is 1.0-liter (ASTM D 6232).

A lidded sludge/water sampler comprises a removable glass jar, sometimes fitted with a cutter for sampling materials containing more than 40-percent solids (ASTM D 6232), that is mounted on a stainless steel device.

The sampler is lowered into the material to be sampled and opened at the desired depth. The top handle is rotated to upright the jar and open and close the lid. Then, the device is carefully retrieved from the material. The jar is removed from the sampler by lifting it from the holder, and

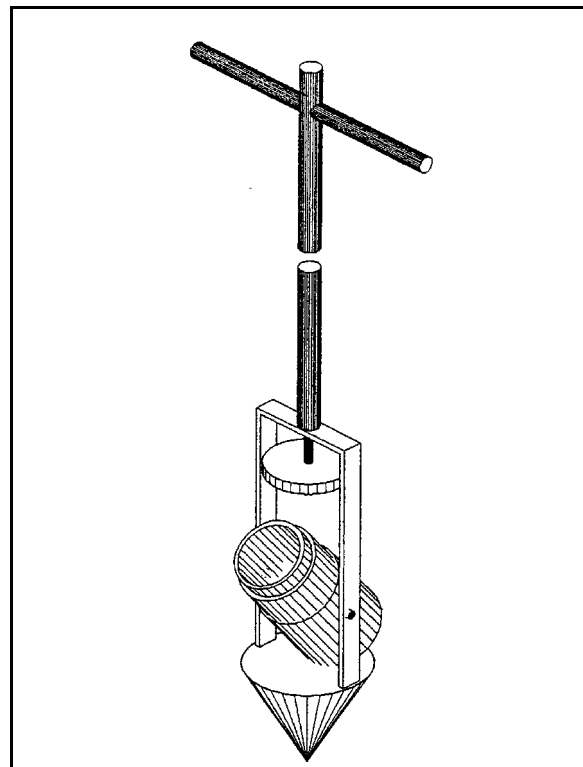

Figure E-10. Lidded sludge/water sampler

the jar serves as a sample container so there is no need to transfer the sample.

Advantages

- The jar in the sampling device also serves as a sample container reducing the risk of cross-contamination.
- Bottles and lids are unique to each sample, therefore, decontamination of an intermediate transfer container is not required.

Limitations

- Heavy and limited to one bottle size
- Thick sludge is difficult to sample (ASTM D 6232).

Other Guidance

- *Standard Guide for Selection of Sampling Equipment for Waste and Contaminated Media Data Collection Activities, ASTM D 6232*

E.3.5 Discrete Level Sampler

A discrete level sampler (Figure E-11) is a dismountable cylindrical sampler fitted with a manually-operated valve(s). It is recommended for sampling surface water, ground water, point discharges, liquids, and multi-layer liquids and is used for sampling drums, tanks, containers, wells, and surface impoundments. The typical sample volume range is 0.2 to 0.5 liters (ASTM D 6232).

A discrete level sampler is made from PTFE and stainless steel and is designed to be reusable. It comprises a tube fitted with manually-operated valve or valves, which are operated by a control assembly attached to the upper end of the sampler. This assembly consists of a rigid tube and rod or a flexible tube and inner cable. The standard level sampler has a manually operated upper valve and a lower spring-retained bottom dump valve. The dual valve model may be emptied by opening the valves manually or with a metering device attached to the lower end of the sampler (not shown).

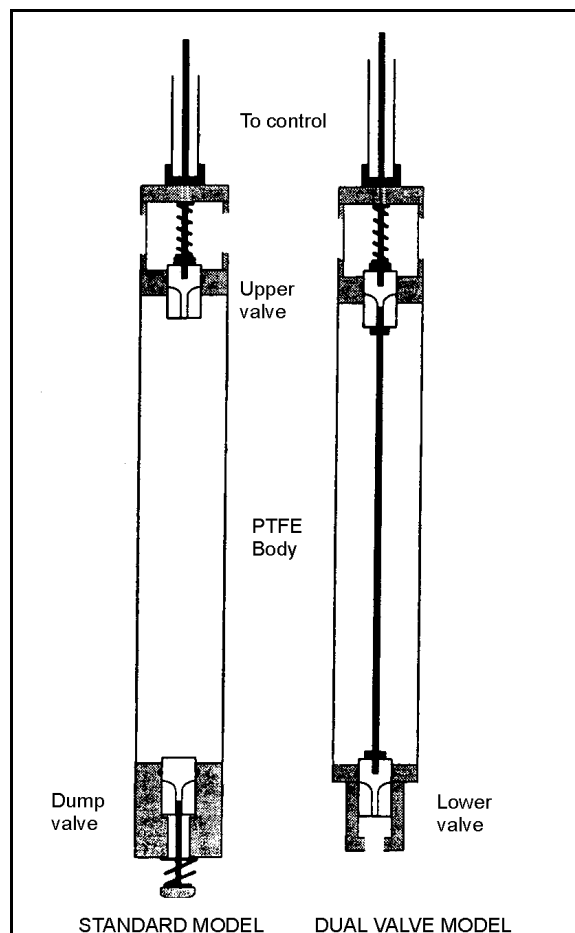

Figure E-11. Discrete level sampler

Appendix E

To collect a sample, the discrete level sampler is lowered into the sample material to the desired sampling depth. The valve or valves are opened manually to collect the sample and closed before retrieving the sampler. The standard model is emptied by pressing the dump valve against the side of the sample container. The dual valve sampler is emptied by opening the valves manually. Alternatively, the collected sample may be taken to the laboratory in the sampler body by replacing the valves with solid PTFE end caps.

Advantages

- Relatively easy to decontaminate and reuse
- May be used to sample liquids in most environmental situations.
- Can be remotely operated in hazardous environments.
- Sample representativeness is not affected by liquids above the sampling point.
- The sampling body can be used for sample storage and transport.

Limitations

- Limited to sample chamber capacities of 240-475 mL (ASTM D 6232).
- May be incompatible with liquids containing a high percentage of solids.

Other Guidance

- Standard Guide for Selection of Sampling Equipment for Waste and Contaminated Media Data Collection Activities, ASTM D 6232

E.4 Push Coring Devices

Push coring devices include equipment that use a pushing action to collect a vertical column of a solid sample. You will find summaries for the following push coring devices in this section:

- E.4.1 Penetrating Probe Sampler
- E.4.2 Split Barrel Sampler
- E.4.3 Concentric Tube Thief
- E.4.4 Trier
- E.4.5 Thin-Walled Tube
- E.4.6 Coring Type Sampler (with Valve)
- E.4.7 Miniature Core Sampler
- E.4.8 Modified Syringe Sampler

E.4.1 Penetrating Probe Sampler

The penetrating probe sampler (Figure E-12) is a push coring device and, therefore, provides a core sample. The probe sampler is recommended for sampling soil and other solids. The sample volume range is 0.2 to 2.0 liters (ASTM D 6232).

The probe sampler typically consists of single or multiple threaded steel tubes, a threaded top cap, and a detachable steel tip. The steel tubes are approximately 1 inch or less in diameter. Specialized attachments may be used for various matrices. Some probes are equipped with adjustable screens or retractable inner rods to sample soil vapor or ground water.

Advantages

- Easy to decontaminate and is reusable.
- Can provide samples for onsite analysis (ASTM D 6232).
- Versatile and may sample 15 to 20 locations a day for any combination of matrices (ASTM D 6232).
- Can reduce quantity of investigative derived wastes.

Limitations

- May be heavy and bulky depending on the size used.
- Limited by composition of subsurface materials and accessibility to deeper depth materials.
- May be inappropriate for sampling materials that require mechanical strength to penetrate.

Other Guidance

- *Standard Guide for Selection of Sampling Equipment for Waste and Contaminated Media Data Collection Activities, ASTM D 6232*

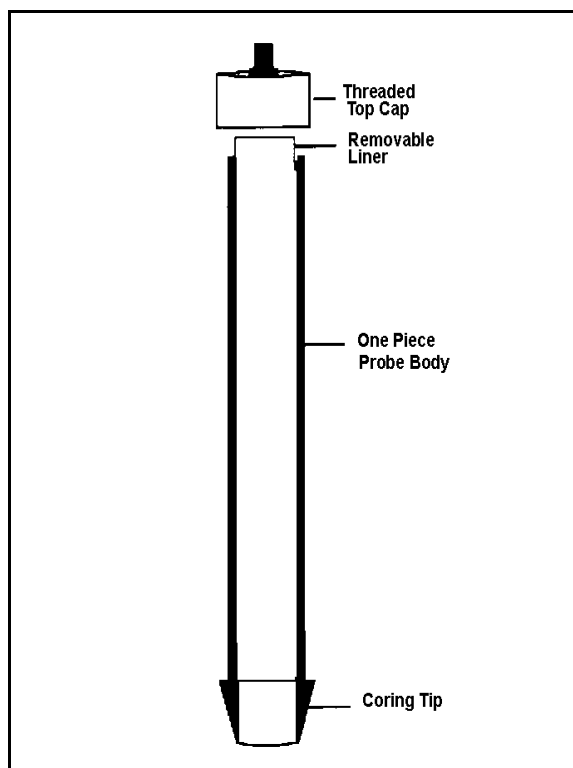

Figure E-12. Probe sampler

E.4.2 Split Barrel Sampler

A split barrel sampler (Figure E-13) is a push coring device often used with a drill rig to collect deep subsurface samples. The device is recommended for soil sampling, but can be used to sample other solids. The materials to be sampled should be moist enough to remain in the sampler. The sample volume range is 0.5 to 30.0 liters (ASTM D 6232).

The sampler consists of a length of steel tubing split longitudinally and equipped with a drive shoe, made of steel, and a drive head. The drive shoe is detachable and should be replaced when dented or distorted. The samplers are available in a variety of diameters and lengths. The split barrel is typically 18 to 30 inches in length with an inside diameter of 1.5 to 2.5 inches (ASTM D 4700, ASTM D 1586). The split barrel sampler can be used to collect relatively undisturbed soil samples at considerable depths.

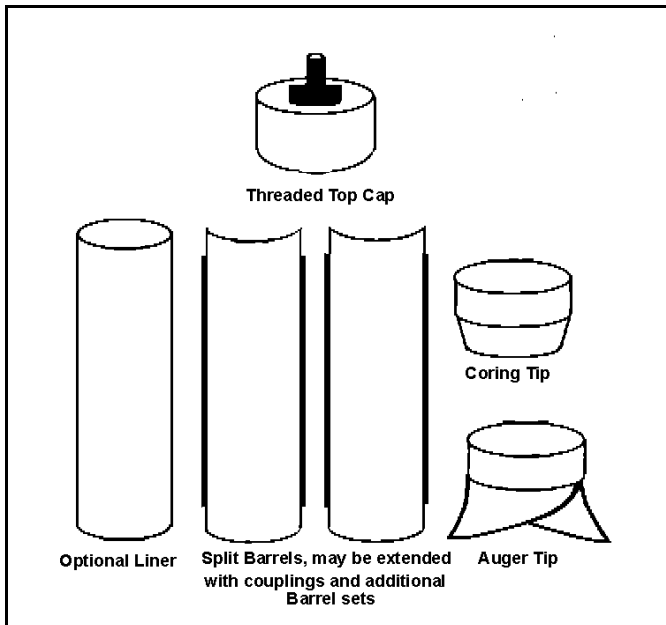

Figure E-13. Split barrel sampler

The split barrel sampler may be driven manually, but is usually driven with a drill rig drive weight assembly or hydraulically pushed using rig hydraulics. The sampler is placed on the surface of the material to be sampled, then pushed downward while being twisted slightly. Because pushing by hand may be difficult, a drop hammer typically is attached to a drill rig used to finish inserting the sampler. When the desired depth is reached the sampler is twisted again to break the core; then, the sampler is pulled straight up and out of the material. The sample may be removed from the barrel or the liner may be capped off for analysis. Barrels may be extended to 5 inches in diameter (ASTM D 6232). Liners often are used when sampling for volatile organic compounds or other trace constituents of interest. With a liner, the sample can be removed with a minimum amount of disturbance. Liners must be compatible with the matrix and compounds of interest; plastic liners may be inappropriate if analyzing for organics.

Advantages

- Reusable, easily decontaminated, and easy to use.
- Provides a relatively undisturbed sample, therefore, can minimize the loss of volatile organic compounds.

Limitations

- Requires a drill or direct push rig for deep samples.
- Made of steel and may penetrate underground objects such as a pipe or drum.

- Only accommodates samples that contain particles smaller than the opening of the drive shoe (ASTM D 4700).

Other Guidance:

- *Standard Guide for Selection of Sampling Equipment for Waste and Contaminated Media Data Collection Activities*, ASTM D 6232
- *Standard Guide for Soil Sampling from the Vadose Zone*, ASTM D 4700
- *Standard Test Method for Penetration Test and Split-Barrel Sampling of Soils*, ASTM D 1586

E.4.3 Concentric Tube Thief

The concentric tube thief (also known as a grain sampler) (Figure E-14) is a push coring device that the user directly pushes into the material to be sampled. It can be used to sample powdered or granular solids and wastes in piles or in bags, drums, or similar containers. The concentric tube thieves are generally 61 to 100 cm (24 to 40 inches) long by 1.27 to 2.54 cm ($\frac{1}{2}$ to 1 inch) in diameter (USEPA 1994i). The sample volume range is 0.5 to 1.0 liters (ASTM D 6232).

The concentric tube thief consists of two slotted telescoping tubes, which are constructed of stainless steel, brass, or other material. The outer tube has a conical pointed tip on one end which allows the thief to penetrate the material being sampled. The thief is opened and closed by rotating the inner tube, and it is inserted into the material while in the closed position. Once inserted, the inner tube is rotated into the open position and the device is wiggled to allow the material to enter the open slots. The thief then is closed and withdrawn.

Advantages

- Is a good direct push sampler for dry unconsolidated materials.
- Easy to use.

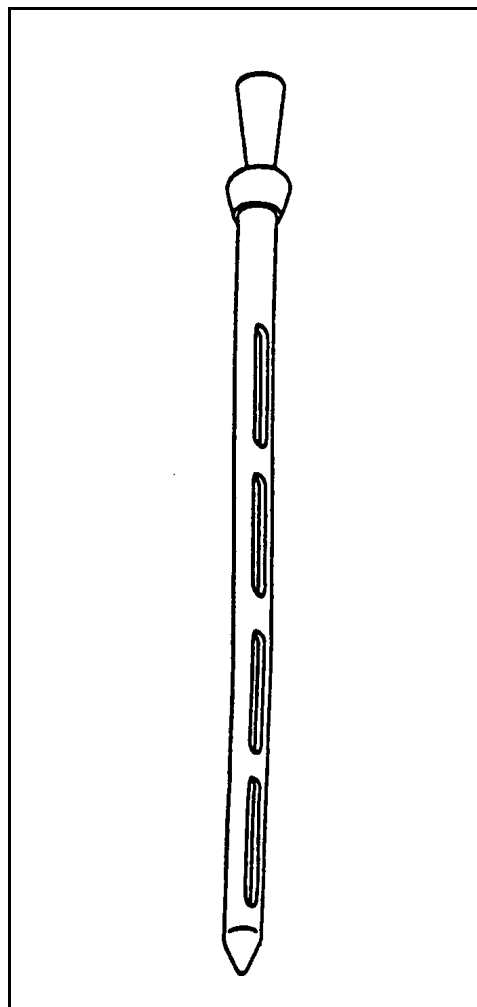

Figure E-14. Concentric tube thief

Appendix E

Limitations

- May be difficult to decontaminate, depending on the matrix
- Not recommended for sampling of moist or sticky materials.
- Does not collect samples containing all particle sizes if the diameter of the largest solid particle is greater than one-third of the slot width (ASTM D 6232). Most useful when the solids are no greater than 0.6 cm (1/4-inch) in diameter (USEPA 1994i).
- Depth of sample is limited by the length of the thief.
- Not recommended for use when volatiles are of interest. Collects a somewhat disturbed sample, which may cause loss of some volatiles.

Other Guidance

- *Standard Guide for Selection of Sampling Equipment for Waste and Contaminated Media Data Collection Activities*, ASTM D 6232
- "Waste Pile Sampling" (USEPA 1994d)

E.4.4 Trier

A trier (Figure E-15) is a push coring device that resembles an elongated scoop and is used to sample moist or sticky solids with a particle diameter less than one-half the diameter of the tube portion. The trier can be used to sample soils and similar fine-grained cohesive materials. The typical sample volume range is 0.1 to 0.5 liters (ASTM D 6232).

A trier comprises a handle connected to a tube cut in half lengthwise, with a sharpened tip that allows it to cut into the material. Triers are made of stainless steel, PTFE-coated metal, or plastic. One should be selected whose materials of construction are compatible with the sampled material.

A trier, typically 61 to 100 cm long and 1.27 to 2.54 cm in diameter, is used as a vertical coring device when a relatively complete and cylindrical sample can be extracted.

The trier is pushed into the material to be sampled and turned one or two times to cut a

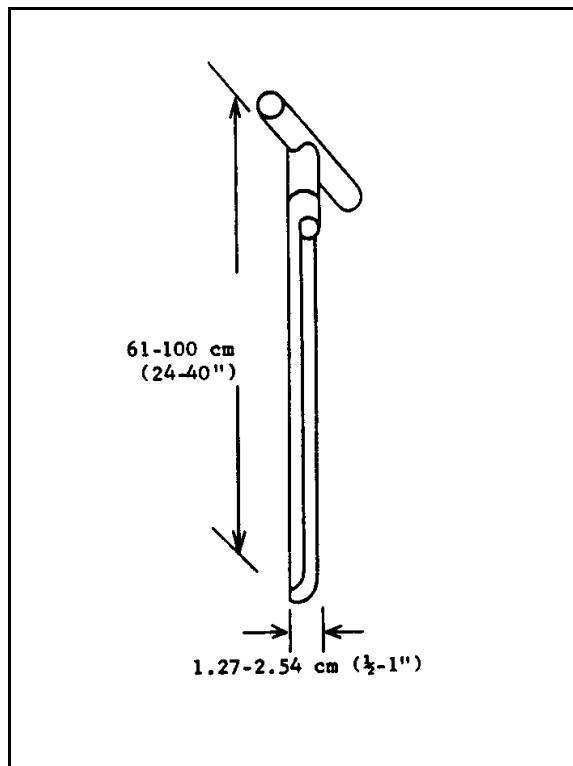

Figure E-15. Trier

core. The rotation is stopped with the open face pointing upward. The core is then carefully removed from the hole, preventing overburden material from becoming a part of the sample. The sample is inspected for irregularities (e.g., pebbles) or breakage. If breakage occurred and if the core does not satisfy minimum length requirements, discard it and extract another from an immediately adjacent location (ASTM D 5451). The sample is emptied into the appropriate container for analysis.

Advantages

- A good direct push sampler for moist or sticky materials.
- Lightweight, easy to use, and easy to decontaminate for reuse.

Limitations

- Limited to sample particle sizes within the diameter of the inserted tube and will not collect particles greater than the slot width.
- Not recommended for sampling of dry unconsolidated materials. (A concentric tube thief is good for such materials.)
- Only for surface sampling, and the depth of sample is limited by the length of the trier.

Other Guidance

- *Standard Guide for Selection of Sampling Equipment for Waste and Contaminated Media Data Collection Activities*, ASTM D 6232
- *Standard Practice for Sampling Using a Trier Sampler*, ASTM D 5451
- *Sampling of Drums and Similar Containers by Field Personnel*, ASTM D 6063
- *Standard Practice for Sampling Unconsolidated Solids in Drums or Similar Containers*, ASTM D 5680

E.4.5 Thin-Walled Tube

A thin-walled tube (Figure E-16) is a type of push coring device recommended for sampling cohesive, unconsolidated solids – particularly soil. It is not recommended for gravel or rocky soil. The sample volume range is 0.5 to 5.0 liters (ASTM D 6232).

The tube generally is constructed of carbon stainless steel, but can be manufactured from other metals (ASTM D 4700). It is commonly 30-inches long and is readily available in 2-, 3-, and 5-inch outside diameters (ASTM D 4700). The tube is attached with set screws to a length of a solid or tubular rod, and the upper end of the rod, or sampler head, is threaded to accept a handle or extension rod. Typically, the length of the tube depends on the desired sampling depth. Its advancing end is beveled and has a cutting edge with a smaller diameter than the

Appendix E

tube inside diameter. The tube can be used in conjunction with drills – from hand-held to full-sized rigs.

The end of the sampler is pushed directly into the media using a downward force on the handle. It can be pushed downward by hand, with a jack-like system, or with a hydraulic piston. Once the desired depth is reached, the tube is twisted to break the continuity of the tip and is pulled from the media. The sample material is extruded into the sample container by forcing a rod through the tube. A paring device has been developed to remove the outer layer during extrusion (ASTM D 4700). Plastic and PTFE sealing caps for use after sampling are available for the 2-, 3-, and 5-inch tubes.

Advantages

- Readily available, inexpensive, and easy to use.
- Reusable and can be decontaminated.
- Obtains a relatively undisturbed sample.

Limitations

- Some thin-walled tubes are large and heavy.
- The material to be sampled must be of a physical consistency (cohesive solid material) to be cored and retrieved within the tube. It cannot be used to sample gravel or rocky soils.
- Some volatile loss is possible when the sample is removed from the tube.
- The most disturbed portion in contact with the tube may be considered unrepresentative. Shorter tubes provide less-disturbed samples than longer tubes.
- Materials with particles larger than one-third of the inner diameter of the tube should not be sampled with a thin-walled tube.

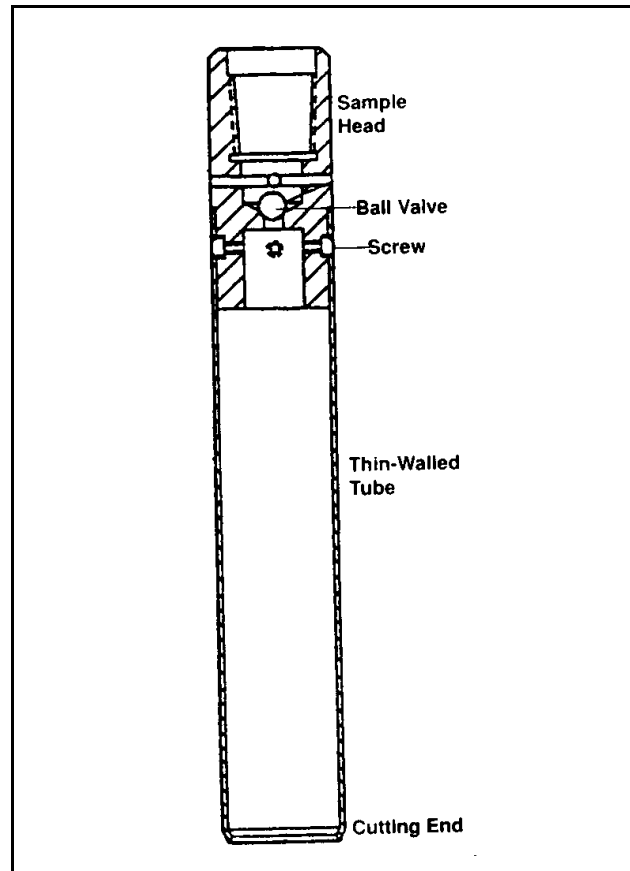

Figure E-16. Thin-walled tube

Other Guidance

- *Standard Guide for Selection of Sampling Equipment for Waste and Contaminated Media Data Collection Activities*, ASTM D 6232
- *Standard Guide for Core Sampling of Submerged, Unconsolidated Sediments*, ASTM D 4823
- *Standard Practice for Thin-Walled Type Geotechnical Sampling of Soils*, ASTM D 1587
- *Standard Guide for Soil Sampling from the Vadose Zone*, ASTM D 4700

E.4.6 Coring Type Sampler (with Valve)

A coring type sampler with valve (Figure E-17) is a type of push coring device recommended for wet soil, and can also be used to sample unconsolidated solid waste, mixed-phase solid/liquid waste, and free-flowing powders. The coring device may be used in drums and small containers as well as tanks, lagoons, and waste impoundments. The sample volume range is 0.2 to 1.5 liters (ASTM D 6232).

The coring type sampler with valve is a stainless steel cylindrical sampler with a coring tip, top cap, an extension with a cross handle, and a non-return valve at the lower end behind a coring or augering tip. The valve is a retaining device to hold the sample in place as the coring device is removed. Samples are normally collected in an optional liner. It is operated by attaching a handle or an extension with a handle to the top of the coring device. The corer is lowered to the surface, pushed into the material being sampled and removed. The top cap is removed and the contents emptied into a sample container. Alternatively, the liner can be removed (with the sampled material retained inside) and capped on both ends for shipment to a laboratory.

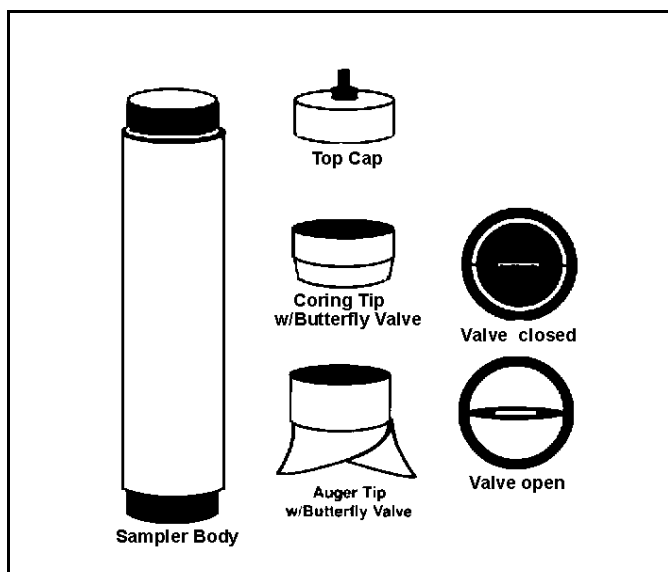

Figure E-17. Coring type sampler (with valve)

Advantages

- Reusable and is easily decontaminated.
- Provides a relatively undisturbed sample if not extruded.
- Can be hand operated and does not require significant physical strength.

Appendix E

Limitations

- Can not be used in gravel, large particle sediments, or sludges.
- When sampling for volatile organic compounds, it must be used with a liner and capped to minimize the loss of volatiles.

Other Guidance

- *Standard Guide for Selection of Sampling Equipment for Waste and Contaminated Media Data Collection Activities*, ASTM D 6232
- *Guide for Core Sampling Submerged, Unconsolidated Sediments*, ASTM D 4823

E.4.7 Miniature Core Sampler

The miniature core sampler (Figure E-18) can be used to collect soil and waste samples for volatile organics analysis. These include devices such as the Purge-and-Trap Soil Sampler™, the EnCore™ sampler, or a cut plastic syringe (see Section 6.0 of SW-846 Method 5035). A miniature core sampler is a single-use push coring sampling device that also can be used as an air-tight sample storage and shipping container. It collects a small contained subsample and is particularly useful for the sampling and analysis of volatile organic compounds.

It is recommended for sampling soil, from the ground or the side of a trench, and may be used for sampling sediment and unconsolidated solid wastes. It cannot be used for sampling cemented material, consolidated material, or material having fragments coarse enough to interfere with proper coring. The EnCore™ sampler can be used to collect subsamples from soil cores and has a sample volume range of 0.01 to 0.05 liters (ASTM D 6232).

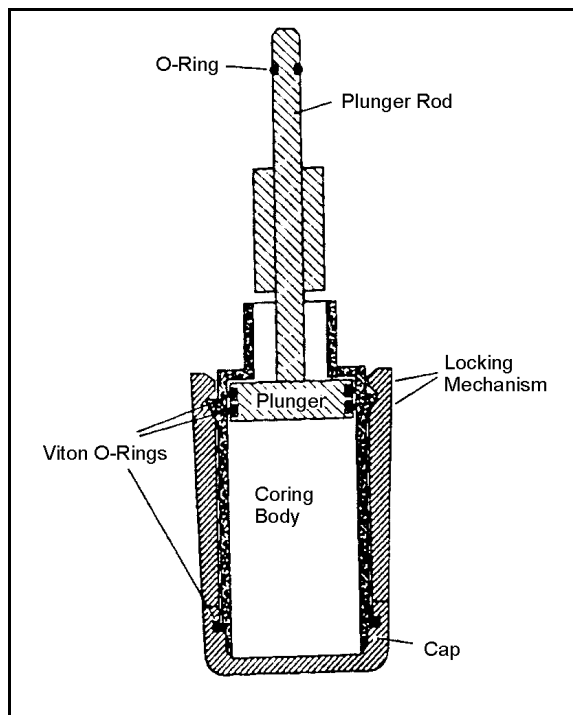

Figure E-18. Miniature core sample (EnCore™ sampler)

The device is available from the manufacturer in two sizes for collection of 5- and 25-gram samples (assuming a soil density of 1.7 g/cm³). The size is chosen based on the sample size required by the analytical procedure.

SW-846 Method 5035, "Closed-System Purge-and-Trap and Extraction for Volatile Organics in Soil and Waste Samples," recommends that samples not be stored in the device longer than 48 hours prior to sample preparation for analysis. The manufacturer's instructions for sample extrusion should be followed carefully.

Advantages

- Maintains sample structure in a device that also can be used to store and transport the sample directly to the laboratory.
- Recommended for collecting samples for the analysis of volatile compounds. It collects a relatively undisturbed sample that is contained prior to analysis to minimize the loss of volatile compounds.
- Usually is compatible with the chemicals and physical characteristics of the sampled media.
- No significant physical limitations for its use.
- Cross-contamination should not be a concern if the miniature core sampler is certified clean by the manufacturer and employed as a single-use device.

Limitations

- Cannot be used to sample gravel or rocky soils.
- Instructions must be followed carefully for proper use to avoid trapping air with the sample and to ensure that the sample does not compromise the seals.

Other Guidance

- *Standard Guide for Selection of Sampling Equipment for Waste and Contaminated Media Data Collection Activities*, ASTM D 6232
- *Standard Practice for Using the Disposable EnCore™ Sampler for Sampling and Storing Soil for Volatile Organic Analysis*, ASTM D 6418
- *Standard Guide for Sampling Waste and Soils for Volatile Organic Compounds*, ASTM D 4547

E.4.8 Modified Syringe Sampler

A modified syringe sampler (Figure E-19) is a push coring sampling device constructed by the user by modifying a plastic, single-use, medical syringe. It can be used to provide a small, sub-sample of soil, sediments, and unconsolidated solid wastes. It is sometimes used to sub-sample a larger core of soil. It is not recommended for sampling cemented material, consolidated material, or material having fragments coarse enough to interfere with proper coring. Unlike the EnCore™ sampler, it should not be used to store and ship a sample to the laboratory. Instead, the sample should be extruded into another container. Although the modified syringe sampler does not provide as contained a sample as the EnCore™ sampler, it can be used for sampling volatile compounds, as long as sample extrusion into another container is quickly and carefully executed. The modified syringe sampler has a volume range of 0.01 to 0.05 liters (ASTM D 6232).

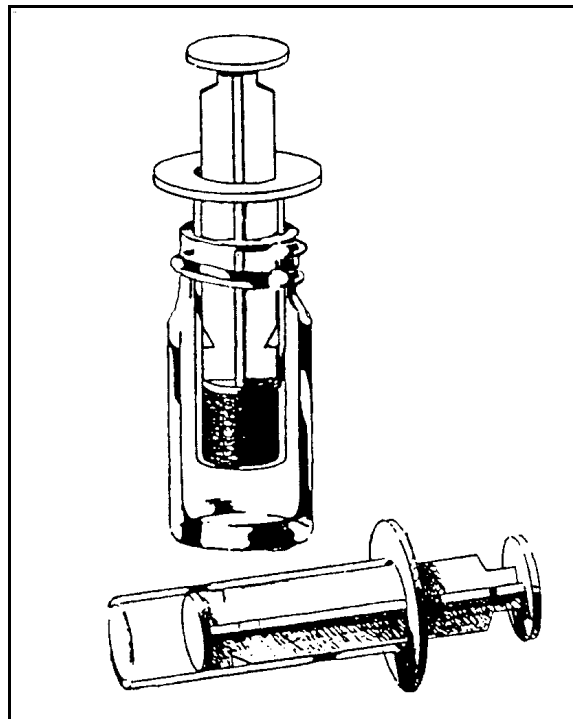

Figure E-19. Modified syringe sampler

A modified syringe sampler is constructed by cutting off the lower end of the syringe attachment for the needle. The rubber cap is removed from the plunger, and the plunger is pushed in until it is flush with the cut end. For greater ease in pushing into the solid matrix, the front edge sometimes can be sharpened (ASTM D 4547). The syringe sampler is then pushed into the media to collect the sample, which then may be placed in a glass VOA vial for storage and transport to the laboratory. The sample is immediately extruded into the vial by gently pushing the plunger. The volume of material collected should not cause excessive stress on the device during intrusion into the material, or be so large that the sample falls apart easily during extrusion.

Advantages

- Obtains a relatively undisturbed profile sample.
- Can be used for the collection of samples for the analysis of volatile compounds as long as sample extrusion is quickly and carefully executed.
- No significant physical limitations for its use.
- Low-cost, single-use device.

Limitations

- Cannot be used to sample gravel or rocky soils.
- Material of construction may be incompatible with highly contaminated media.
- Care is required to ensure that the device is clean before use.
- The device cannot be used to store and transport a sample.

Other Guidance

- *Standard Guide for Selection of Sampling Equipment for Waste and Contaminated Media Data Collection Activities, ASTM D 6232*
- *Standard Guide for Sampling Waste and Soils for Volatile Organic Compounds, ASTM D 4547*

E.5 Rotating Coring Devices

Rotating coring devices include equipment that obtains vertical columns of a solid sample through a rotating action. Some of these devices (such as augers) also can be used for just boring a hole for sample collection at a certain depth using another piece of equipment. You will find summaries for the following rotating coring devices in this section:

E.5.1 Bucket Auger

E.5.2 Rotating Coring Device

E.5.1 Bucket Auger

The bucket auger (Figure E-20) is a hand-operated rotating coring device generally used to sample soil, sediment, or unconsolidated solid waste. It can be used to obtain samples from drums, storage containers, and waste piles. The sample volume range is 0.2 to 1.0 liters (ASTM D 6232).

The cutting head of the auger bucket is pushed and twisted by hand with a downward force into the ground and removed as the bucket is filled. The empty auger is returned to the hole and the procedure is repeated. The sequence is continued until the required depth is reached. The same bucket may be used to advance the hole if the vertical sample is a composite of all intervals; however, discrete grab

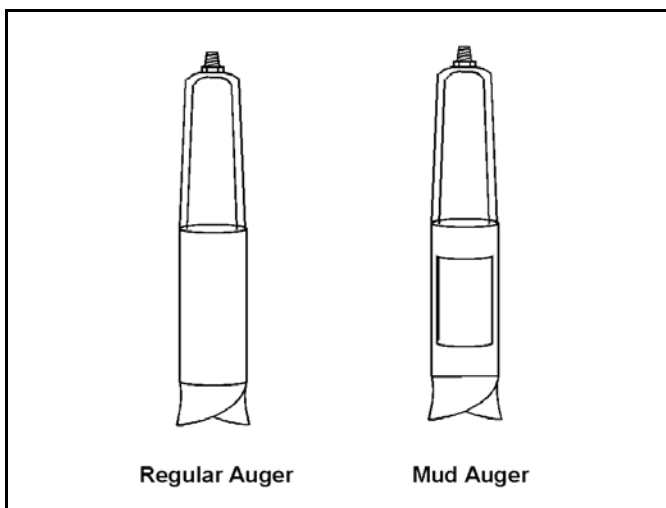

Figure E-20. Bucket auger

Appendix E

samples should be collected in separate clean auger buckets. The top several inches of material should be removed from the bucket to minimize chances of cross-contamination of the sample from fall-in material from the upper portions of the hole.

Note that hand augering may be difficult in tight clays or cemented sands. At depths approaching 20 feet (6 m), the tension of hand auger extension rods may make operation of the auger too difficult. Powered methods are recommended if deeper samples are required (ASTM D 6232).

Advantages

- Reusable and easy to decontaminate.
- Easy to use and relatively quick for shallow subsurface samples.
- Allows the use of various auger heads to sample a wide variety of soil conditions (USEPA 1993c).
- Provides a large volume of sample in a short time.

Limitations

- Depth of sampling is limited to about 20 feet (6 m) below the surface.
- Not suitable for obtaining undisturbed samples.
- Requires considerable strength to operate and is labor intensive.
- Not ideal for sampling soils for volatile organic compounds.

Other Guidance

- *Standard Guide for Selection of Sampling Equipment for Waste and Contaminated Media Data Collection Activities*, ASTM D 6232
- *Standard Practice for Soil Investigation and Sampling by Auger Borings*, ASTM D 1452
- *Standard Guide for Soil Sampling from the Vadose Zone*, ASTM D 4700
- *Standard Practice for Sampling Unconsolidated Waste From Trucks*, ASTM D 5658
- *Standard Guide for Sampling of Drums and Similar Containers by Field Personnel*, ASTM D 6063
- "Waste Pile Sampling" (USEPA 1994d)

- “Sediment Sampling” (USEPA 1994e)

E.5.2 Rotating Coring Device

The rotating coring device (Figure E-21) collects vertical columns of a solid sample through a rotating action and can be used in sampling consolidated solid waste, soil, and sediment. The sample volume range is 0.5 to 1.0 liters (ASTM D 6232).

The rotating coring device consists of a diamond- or carbide-tipped open steel cylinder attached to an electric drill. The coring device may be operated with the drill hand-held or with the drill mounted on a stand. When on a portable stand, full-depth core samples can be obtained. The barrel length is usually 1- to 1.5-feet long and the barrel diameter ranges from 2 to 6 inches (ASTM D 6232 and ASTM D 5679). The rotating coring device may be used for surface or depth samples.

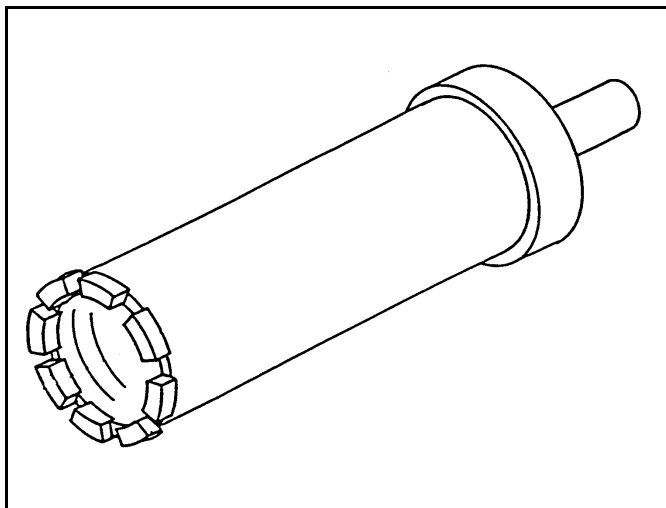

Figure E-21. Rotating coring device

The rotating coring device is placed vertical to the surface of the media to be sampled, then turned on before contact with the surface. Uniform and continuous pressure is supplied to the device until the specified depth is reached. The coring device is then withdrawn and the sample is placed into a container for analysis, or the tube itself may be capped and sent to the laboratory. Capping the tube is preferred when sampling for volatile organic compounds. The rotating tube must be cooled and lubricated with water between samples.

Advantages

- Easy to decontaminate.
- Reusable.
- Can obtain a solid core sample.

Limitations

- Requires a battery or other source of power.
- Requires a supply of water, used for cooling the rotating tube.
- Not easy to operate.

Other Guidance

- *Standard Guide for Selection of Sampling Equipment for Waste and Contaminated Media Data Collection Activities*, ASTM D 6232
- *Standard Practice for Sampling Consolidated Solids in Drums or Similar Containers*, ASTM D 5679
- “Drum Sampling” (USEPA 1994b)
- “Sediment Sampling” (USEPA 1994e)

E.6 Liquid Profile Devices

Liquid profile devices include equipment that can collect a vertical column of a liquid, sludge, or slurry sample. You will find summaries for the following liquid profile devices in this section:

- E.6.1 Composite Liquid Waste Sampler (COLIWASA)
- E.6.2 Drum Thief
- E.6.3 Valved Drum Sampler
- E.6.4 Plunger Type Sampler
- E.6.5 Settleable Solids Profiler (Sludge Judge)

E.6.1 COLIWASA (Composite Liquid Waste Sampler)

The COLIWASA (Figure E-22) is a type of liquid profile sampling device used to obtain a vertical column of sampled material. A COLIWASA is recommended for sampling liquids, multi-layer liquid wastes, and mixed-phase solid/liquid wastes and is commonly used to sample containerized liquids, such as tanks and drums. It also may be used for sampling open bodies of stagnant liquids. The sample volume range is 0.5 to 3 liters (ASTM D 6232).

A COLIWASA can be constructed of polyvinyl chloride (PVC), glass, metal, PTFE or any other material compatible with the sample being collected. In general, a COLIWASA comprises a tube with a tapered end and an inner rod that has some type of stopper on the end. The design can be modified or adapted to meet the needs of the sampler. One configuration comprises a piston valve attached by an inner rod to a locking

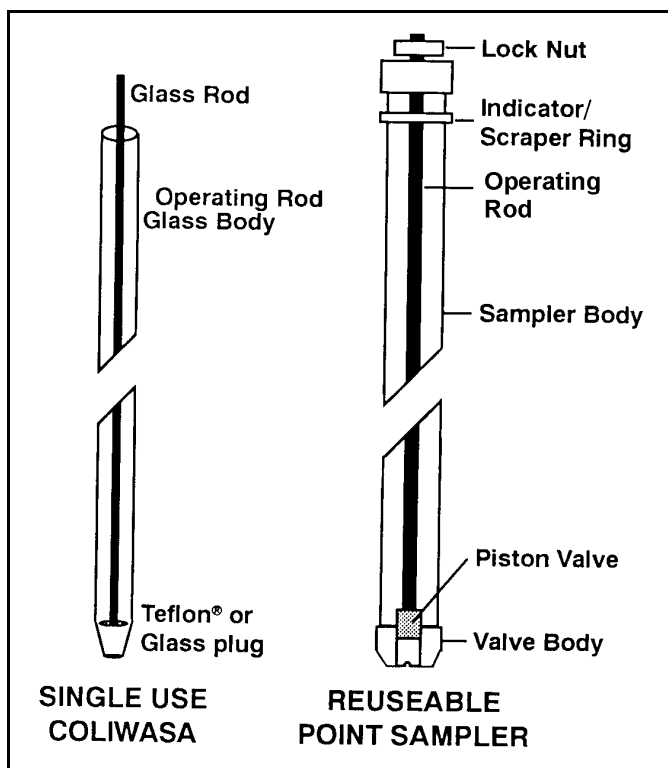

Figure E-22. COLIWASA

mechanism at the other end. Designs are available for specific sampling situations (i.e., drums, tanks). COLIWASAs specifically designed for sampling liquids, viscous materials, and heavy sludges are also available. COLIWASAs come in a variety of diameters (0.5 to 2 inches) and lengths (4 to 20 feet) (ASTM D 6232).

COLIWASAs are available commercially with different types of stoppers and locking mechanisms, but all have the same operating principle. To draw a sample, the COLIWASA is slowly lowered into the sample at a right angle with the surface of the material. (If the COLIWASA sampler is lowered too fast, the level of material inside and outside the sampler may not be the same, causing incorrect proportions in the sample. In addition, the layers of multi-layered materials may be disturbed.) The sampler is opened at both ends as it is lowered to allow the material to flow through it. When the device reaches the desired sampling depth, the sampler is closed by the stopper mechanism and both tubes are removed from the material. The sampled material is then transferred to a sample container by opening the COLIWASA. A COLIWASA can be reused following proper decontamination (reusable point sampler) or disposed after use (single-use COLIWASA). The reusable point sampler is used in the same way as the single use COLIWASA; however, it can also sample at a specific point in the liquid column.

Advantages

- Provides correct delimitation and extraction of waste (Pitard 1989).
- Easy to use.
- Inexpensive.
- Reusable.
- Single-use models are available.

Limitations

- May break if made of glass and used in consolidated matrices.
- Decontamination may be difficult.
- The stopper may not allow collection of material in the bottom of a drum.
- High viscosity fluids are difficult to sample.

Other Guidance

- *Standard Practice for Sampling with a Composite Liquid Waste Sampler (COLIWASA)*, ASTM D 5495
- *Standard Guide for Selection of Sampling Equipment for Waste and Contaminated Media Data Collection Activities*, ASTM D 6232

Appendix E

- *Standard Guide for Sampling Drums and Similar Containers by Field Personnel*, ASTM D 6063
- *Standard Practice for Sampling Single or Multilayered Liquids, With or Without Solids, in Drums or Similar Containers*, ASTM D 5743
- “Drum Sampling” (USEPA 1994b)
- “Tank Sampling” (USEPA 1994c)

E.6.2 Drum Thief

A drum thief (Figure E-23) is an open-ended tube and liquid profile sampling device that provides a vertical column of the sampled material. It is recommended for sampling liquids, multi-layer liquid wastes, and mixed-phase solid/liquid wastes and can be used to sample liquids in drums or similar containers. The typical sample volume range is 0.1 to 0.5 liters (ASTM D 6232).

Drum thieves can be made of glass, stainless steel, or any other suitable material. Drum thieves are typically 6 mm to 16 mm inside diameter and 48-inches long (USEPA 1994c). To sample liquids with low surface tension, a narrow bailer works best. In most cases, tubes with a 1-centimeter inside diameter work best. Wider tubes can be used to sample sludges.

The drum thief is lowered vertically into the material to be sampled, inserted slowly to allow the level of material inside and outside the tube to be approximately the same. This avoids incorrect proportions in the sample. The upper end is then sealed with the thumb or a rubber stopper to hold the sample in the tube as it is removed from the container. The thief is emptied by removing the thumb or stopper.

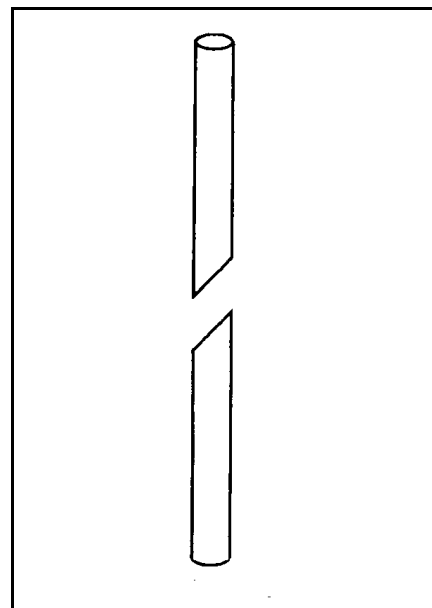

Figure E-23. Drum thief

Advantages

- Easy to use and inexpensive.
- Available in reusable and single-use models.

Limitations

- Sampling depth is limited to the length of the sampler.
- May not collect material in the bottom of a drum. The depth of unsampled material depends on the density, surface tension, and viscosity of the material being sampled.

- Highly viscous materials are difficult to sample.
- May be difficult to retain sample in the tube when sampling liquids of high specific gravity.
- If made of glass, may break if used in consolidated matrices. In addition, chips and cracks in a glass drum thief may cause an imperfect seal.
- Decontamination is difficult.
- When sampling a drum, repeated use of the drum thief to obtain an adequate volume of sample may disturb the drum contents.
- Drum-size tubes have a small volume and sometimes require repeated use to obtain a sample. Two or more people may be required to use larger sizes.

Other Guidance

- *Standard Guide for Selection of Sampling Equipment for Waste and Contaminated Media Data Collection Activities*, ASTM D 6232
- *Standard Guide for Sampling of Drums and Similar Containers by Field Personnel*, ASTM D 6063
- *Standard Practice for Sampling Single or Multilayered Liquids, With or Without Solids, in Drums or Similar Containers*, ASTM D 5743
- “Drum Sampling” (USEPA 1994b)
- “Tank Sampling” (USEPA 1994c)

E.6.3 Valved Drum Sampler

A valved drum sampler (Figure E-24) is a liquid profile device often used to sample liquids in drums or tanks and provides a vertical column of the sampled material. A valved drum sampler is recommended for sampling liquids, multi-layered liquid wastes, and mixed-phase solid/liquid wastes. The typical sample volume range is 0.3 to 1.6 liters (ASTM D 6232).

The sampler can be constructed from PTFE for reuse or polypropylene for single use and comprises a tube fitted with a top plug and a bottom valve. A sliding indicator ring allows specific levels or fluids interfaces to be identified.

The valved drum sampler is open at both ends during

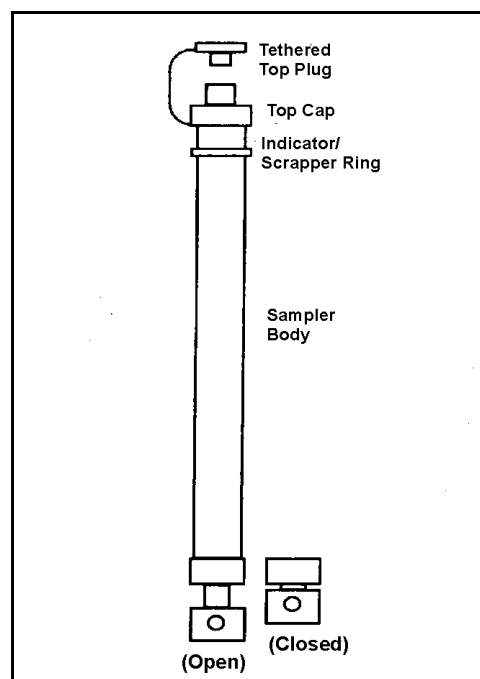

Figure E-24. Valved drum sampler

Appendix E

sample collection and lowered vertically into the material to be sampled. The sampler is inserted slowly to allow the level of material inside and outside the tube to equalize. Once the desired amount of sample is collected, the top plug and the bottom valve are closed. The top plug is closed manually and the bottom valve is closed by pressing against the side or bottom of the container. The sample is poured from the top of the sampler into a suitable container.

Advantages

- Easy to use, inexpensive, and unbreakable.
- Obtains samples to depths of about 8 feet (2.4 m) (ASTM D 6232).
- Reusable if made from PTFE (single-use if made from polypropylene) (ASTM D 6232).

Limitations

- Somewhat difficult to decontaminate
- The bottom valve may prevent collection of the bottom 1.25 cm of material (ASTM D 6232).
- High viscosity fluids are difficult to sample.

Other Guidance

- *Standard Guide for Selection of Sampling Equipment for Waste and Contaminated Media Data Collection Activities, ASTM D 6232*

E.6.4 Plunger Type Sampler

The plunger type sampler (Figure E-25) is a liquid profile sampling device used to collect a vertical column of liquid and is recommended for the sampling of single and multi-layered liquids or mixtures of liquids and solids. The plunger type sampler can be used to collect samples from drums, surface impoundments, and tanks. Sample volume is at least 0.2 liters and ultimately depends on the size of the sample container (ASTM D 6232).

A plunger type sampler comprises a sample tube, sample line or rod, head section, and plunger and is made of HDPE, PTFE, or glass. A sample jar is connected to the head section. The sample tube is lowered into the liquid to the desired depth. The plunger is engaged into the tube to secure the sample within the tube and the cord or rod is raised to transfer the sample directly into the

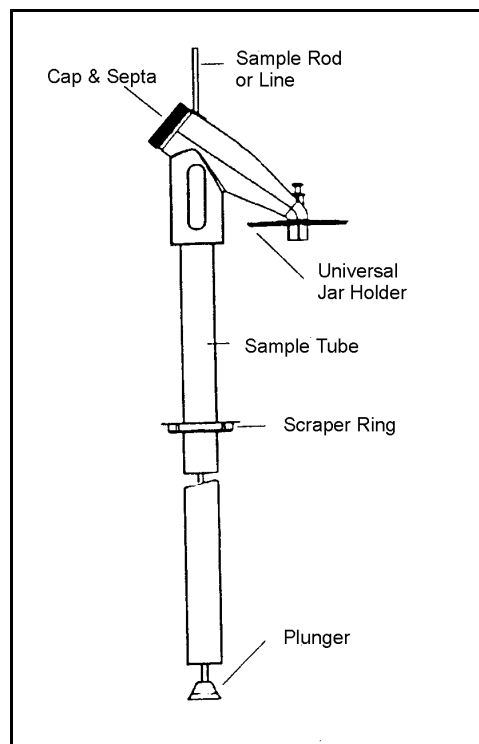

Figure E-25. Plunger type sampler

sampling bottle or jar. The plunger can be pushed back down the sampling tube to reset the sampler.

Advantages

- Easy to use.
- Provides a sealed collection system.
- Relatively inexpensive and available in various lengths.

Limitations

- Care is needed when using a glass sampling tube.
- Decontamination may be difficult, particularly when a glass sampling tube is used.

Other Guidance:

- *Standard Guide for Selection of Sampling Equipment for Waste and Contaminated Media Data Collection Activities*, ASTM D 6232
- *Standard Practice for Sampling Single or Multilayered Liquids, With or Without Solids, in Drums or Similar Containers*, ASTM D 5743

E.6.5 Settleable Solids Profiler (Sludge Judge)

The settleable solids profiler (Figure E-26), also known as the sludge judge, primarily is used to measure or sample settleable (suspended) solids found in sewage treatment plants, waste settling ponds and impoundments containing waste. It also can be used to sample drums and tanks. It has a sample volume range of 1.3 to 4.0 liters (ASTM D 6232).

The sludge judge is made from clear PVC and has 1-foot-depth markings on its 5-foot-long body sections. It has a check valve on the lower section and a cord on the upper section and is assembled using the threaded connections of the sections to the length needed for the sampling event. The sampler is lowered into the media to allow it to fill. A tug on the cord sets the check valve and it is removed from the sampled material. The level of settleable solids can be measured using the markings. It is emptied by pressing in the protruding pin on the lower end.

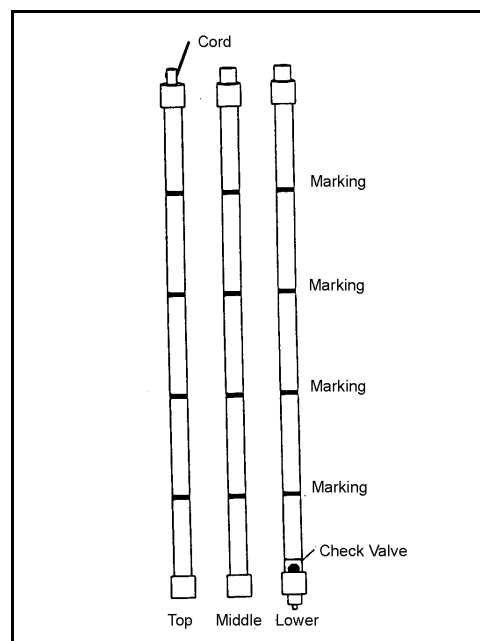

Figure E-26. Settleable solids profiler

Appendix E

Advantages

- Allows measurement of the liquid/settleable solids columns of any length.
- Easy to assemble and use.
- Unbreakable in normal use and reusable.

Limitations

- Suitable for sampling noncaustic liquids only.
- May be difficult to sample high viscosity materials.

Other Guidance

- *Standard Guide for Selection of Sampling Equipment for Waste and Contaminated Media Data Collection Activities, ASTM D 6232*

E.7 Surface Sampling Devices

Surface sampling devices include equipment that by design are limited to sample collection at the surface of material or can sample material of limited depth or width only. You will find summaries for the following surface sampling devices in this section:

- E.7.1 Bailer
- E.7.2 Dipper
- E.7.3 Liquid Grab Sampler
- E.7.4 Swing Jar Sampler
- E.7.5 Spoons, Scoops, Trowels, and Shovels

E.7.1 Bailer

Bailers (Figure E-27) are designed for obtaining samples of ground water; however, they also can be used to obtain samples of liquids and multi-layered liquid wastes from tanks and surface impoundments. Bailers are not suitable for sampling sludges. The sample volume range is 0.5 to 2 liters (ASTM D 6232).

A bailer is a hollow tube with a check valve at the base (open bailer) or valves at both ends (point-source bailer). A bailer can be threaded in the middle so that extension tubes can be added to increase the sampling volume. It can be constructed of stainless steel, PVC, PTFE, or any other

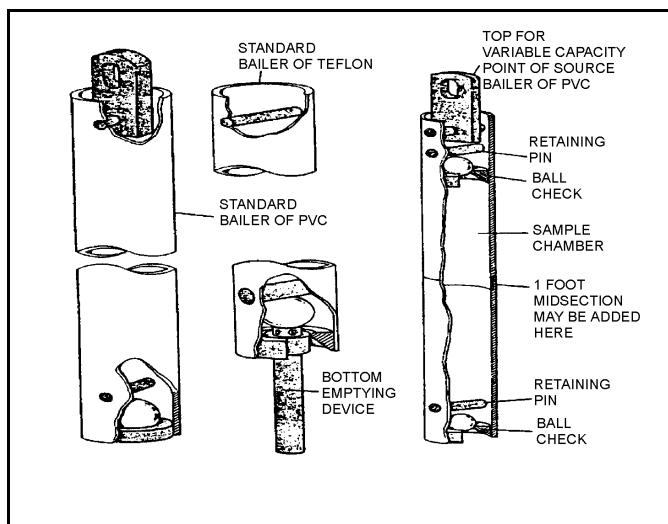

Figure E-27. Bailer

suitable material and is available in numerous sizes for use in a variety of well sizes. The bailer is attached to a line and gradually lowered into the sample. As the bailer is lowered, the bottom check valve allows water to flow through the tube. The bailer is then slowly raised to the surface. The weight of the water closes the bottom check valve. A point-source bailer allows sampling at a specific depth. The check valve at the top of the tube limits water or particles from entering the bailer as it is retrieved.

The bailer is emptied either by pouring from the top or by a bottom emptying device. When using a top-emptying bailer, the bailer should be tipped slightly to allow a slow discharge into the sample container to minimize aeration. A bottom-emptying model has controlled flow valves, which is good for collecting samples for volatile organic analysis since agitation of the sample is minimal.

Advantages

- Easy to use, inexpensive, and does not require an external power source.
- Can be constructed of almost any material that is compatible with the parameters of interest.
- Relatively easy to decontaminate between samples. Single-use models are available.
- Bottom-emptying bailers with control valves can be used to obtain samples for volatile compound analysis.

Limitations

- Not designed to obtain samples from specific depths below liquid surface (unless it is a point-source bailer).
- If using a top-emptying bailer, the sample may become aerated if care is not taken during transfer to the sample container.
- May disturb the sample in a water column if it is lowered too rapidly.
- High suspended solids' content or freezing temperatures can impact operation of check valves.
- One of the least preferred devices for obtaining samples of ground water for low concentration analyses due to their imprecision and agitation of the sample (see USEPA 1992a and Puls and Barcelona 1996).

Other Guidance

- *Standard Guide for Selection of Sampling Equipment for Waste and Contaminated Media Data Collection Activities*, ASTM D 6232
- *Standard Guide for Sampling Groundwater Monitoring Wells*, ASTM D 4448

Appendix E

- “Tank Sampling” (USEPA 1994c)

E.7.2 Dipper

A dipper (Figure E-28) is a type of surface sampling device used to sample surface samples from drums, surface impoundments, tanks, pipes, and point source discharges. Sampling points are shallow (10 inches) and taken at, or just below, the surface. The typical sample volume range is 0.5 to 1.0 liters (ASTM D 6232).

A dipper comprises a glass, metal, or plastic beaker clamped to the end of a two- or three-piece telescoping aluminum or fiberglass pole, which serves as a handle. A dipper may vary in the number of assembled pieces. Some dippers have an adjustable clamp attached to the end of a piece of metal tubing. The tubing forms the handle; the clamp secures the beaker.

Another type of dipper is a stainless steel scoop clamped to a movable bracket that is attached to a piece of rigid tube. The scoop may face either toward or away from the person collecting the sample, and the angle of the scoop to the pipe is adjustable. The dipper, when attached to a rigid tube, can reach easily 10 to 13 feet (3 to 4 m) away from the person collecting the samples (ASTM D 6232).

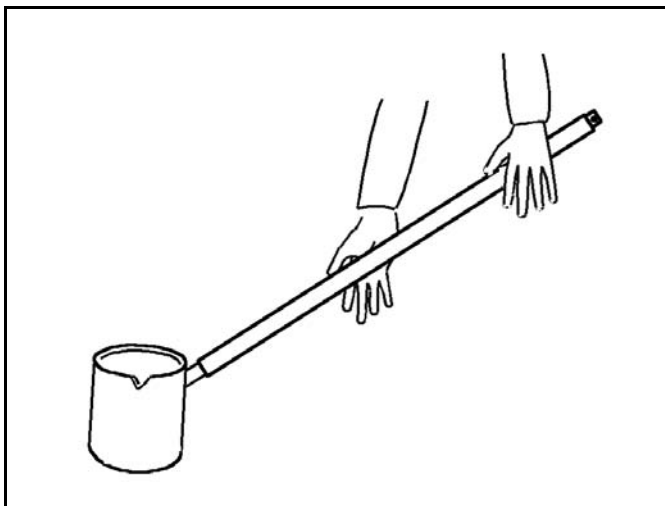

Figure E-28. Dipper

The dipper is used by submerging the beaker end into the material slowly (to minimize surface disturbance). It should be on its side so that the liquid runs into the container without swirling or bubbling. The beaker is filled and rotated up, then brought slowly to the surface. Dippers and their beakers should be compatible with the sampled material.

Advantages

- Inexpensive.
- Easy to construct and adapt to the sampling scenario by modifying the length of the tubing or the type of container.

Limitations

- Not appropriate for sampling subsurface layers or to characterize discrete layers of stratified liquids.
- Can only be used to collect surface samples.

Other Guidance

- *Standard Practice for Sampling with a Dipper or Pond Sampler*, ASTM D 5358
- *Standard Guide for Selection of Sampling Equipment for Waste and Contaminated Media Data Collection Activities*, ASTM D 6232
- *Standard Practice for Sampling Wastes from Pipes and Other Point Discharges*, ASTM D 5013

E.7.3 Liquid Grab Sampler

A liquid grab sampler (Figure E-29) is a surface sampling device designed to collect samples at a specific shallow depth beneath the liquid surface. It can be used to collect samples of liquids or slurries from surface impoundments, tanks, and drums. Its sample volume range is from 0.5 to 1.0 liters (ASTM D 6232).

The liquid grab sampler is usually made from polypropylene or PTFE with an aluminum or stainless steel handle and stainless steel fittings. The sampling jar is usually made of glass, although plastic jars are available. The jar is threaded into the sampler head assembly, then lowered by the sampler to the desired sampling position beneath the liquid surface. The valve is then opened by pulling up on a finger ring to fill the jar. The valve is closed before retrieving the sample.

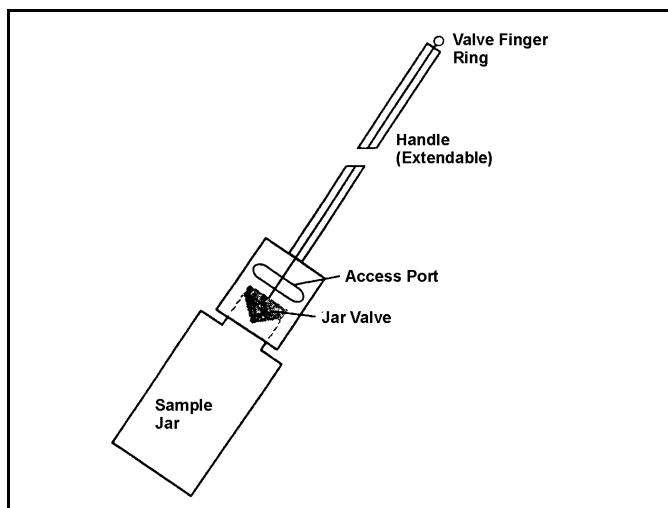

Figure E-29. Liquid grab sampler

Advantages

- Easy to use.
- The sample jar can be capped and used for transport to the laboratory, thus minimizing the loss of volatile organic compounds.
- The closed sampler prevents contaminants in upper layers from compromising the sample.

Limitations

- Care is required to prevent breakage of glass sample jar.
- Materials of construction need to be compatible with the sampled media.

Appendix E

- Cannot be used to collect deep samples.

Other Guidance

- *Standard Guide for Selection of Sampling Equipment for Waste and Contaminated Media Data Collection Activities, ASTM D 6232*

E.7.4 Swing Sampler (Swing Jar Sampler)

The swing jar sampler (Figure E-30) is a surface sampler that may be used to sample liquids, powders, or small solids at distances of up to 12 feet (3.5 m). It can be used to sample many different types of units, including drums, surface impoundments, tanks, pipe/point source discharges, sampling ports, and storage bins. It has a sample volume range of 0.5 to 1.0 liters.

The swing jar sampler is normally used with high density polyethylene sample jars and has an extendable aluminum handle with a pivot at the juncture of the handle and the jar holder. The jar is held in the holder with an adjustable clamp. The pivot allows samples to be collected at different angles.

Advantages

- Easy to use.
- Easily adaptable to samples with jars of different sizes and materials, which can be used to facilitate compatibility with the material to be sampled.
- Can be pivoted to collect samples at different angles.
- Can sample from a wide variety of locations and units.

Limitations

- Cannot collect discrete depth samples.
- Care is required to prevent breakage when using a glass sample jar.

Other Guidance

- *Standard Guide for Selection of Sampling Equipment for Waste and Contaminated Media Data Collection Activities, ASTM D 6232*

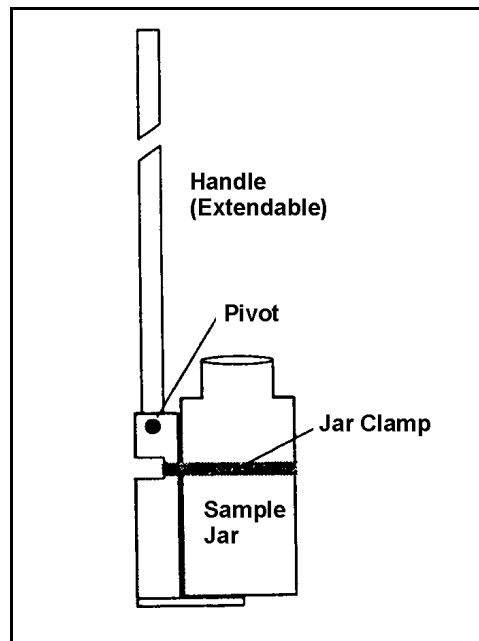

Figure E-30. Swing jar sampler

E.7.5 Spoons, Scoops, Trowels, and Shovels

Spoons, scoops, trowels, or shovels are types of surface sampling devices used to sample sludge, soil, powder, or solid wastes. The typical sample volume range is 0.1 to 0.6 liters for scoops or trowels and 1.0 to 5.0 Liters for shovels (ASTM D 6232). The typical sample volume for a spoon is 10 to 100 grams (USEPA 1993c).

Spoons, available in stainless steel or PTFE (reusable) or in plastic (disposable), easily sample small volumes of liquid or other waste from the ground or a container.

Scoop samplers provide best results when the material is uniform and may be the only sampler possible for materials containing fragments or chunks. The scoop size should be suitable for the size and quantity of the collected material. Scoops and trowels come in a variety of sizes and materials, although unpainted stainless steel is preferred (ASTM D 6232). Scoops may be attached to an extension, similar to the dipper, in order to reach a particular area. Scoops and trowels are used by digging and rotating the sampler. The scoop is used to remove a sample and transfer it into a sample container.

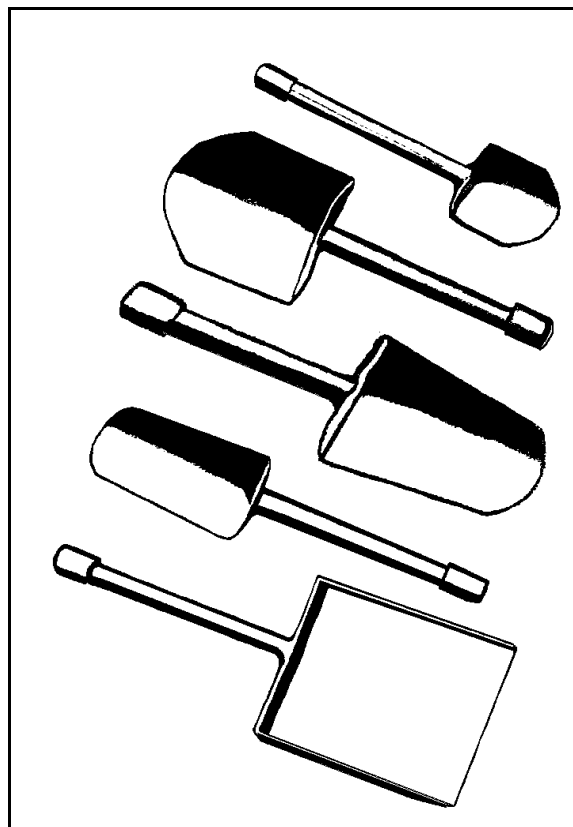

Figure E-31. Scoops

Shovels, usually made from stainless steel or suitable plastic materials, are typically used to collect surface samples or to remove overburden material so that a scoop may remove a sample.

Advantages

- A correctly designed scoop or spatula (i.e., with a flat bottom and vertical sides) is one of the preferred devices for sampling a one-dimensional mass of granular solids (see also Sections 6.3.2.1 and 7.3.3.3).
- Spoons, scoops, trowels, and shovels are reusable, easy to decontaminate, and do not require significant physical strength to use.
- Spoons and scoops are inexpensive and readily available.
- Spoons and scoops are easily transportable and often disposable -- hence, their use can reduce sampling time.
- Shovels are rugged and can be used to sample hard materials.

Appendix E

Limitations

- Spoons, scoops, trowels, and shovels are limited to shallow and surface sampling.
- Shovels may be awkward to handle and cannot be used to easily fill small sample containers.
- Sampling with a spoon, scoop, trowel, or shovel may cause loss of volatile organic compounds through disturbance of the media.
- Spoons, scoops, trowels, and shovels of incorrect design (e.g., with rounded bottoms) can introduce bias by preferentially selecting certain particle sizes.

Other Guidance

- *Standard Guide for Selection of Sampling Equipment for Waste and Contaminated Media Data Collection Activities*, ASTM D 6232
- *Standard Practice for Sampling with a Scoop*, ASTM D 5633
- “Waste Pile Sampling” (USEPA 1994d)
- “Sediment Sampling” (USEPA 1994e).

APPENDIX F

STATISTICAL METHODS

This appendix provides guidance on the statistical analysis of waste testing and environmental monitoring data. You should select the statistical test during the Data Quality Assessment (DQA) phase after you review the data quality objectives, the sampling design, and the characteristics of the data set. See guidance provided in Section 8.

The statistical methods in this appendix are appropriate for use in evaluating sample analysis results when comparing constituent concentrations in a waste or environmental medium to a *fixed standard*. Users of this guidance may have other objectives such as comparing two populations, detecting trends, or characterizing the spatial pattern of contamination. If so, review other guidance or seek assistance from a professional environmental statistician.

Additional Guidance on the Statistical Analysis of Waste Testing and Environmental Monitoring Data

USEPA. 2000d. *Guidance For Data Quality Assessment, EPA QA/G-9, (QA00 version)*. EPA/600/R-96/084. Office of Research and Development, Washington, D.C.

Note that not all RCRA standards require the waste handler to use sampling, analysis, and statistical tests to measure compliance. However, if sampling and analysis is used by the waste handler to measure compliance with a RCRA standard, then statistical methods may be used to help quantify uncertainty associated with the decisions made using the data – even where there is no regulatory obligation to do so (see also Sections 2 and 3).

This appendix is divided into subsections that describe the following statistical methods:

- F.1 Testing Distributional Assumptions
 - F.1.1 Overview and Recommendations
 - F.1.2 Shapiro-Wilk Test for Normality ($n \leq 50$)
- F.2 Confidence Limits for the Mean
 - F.2.1 Confidence Limits for the Mean of a Normal Distribution
 - F.2.2 Confidence Limits for a Normal Mean When Composite Sampling Is Used
 - F.2.3 Confidence Limits for a Lognormal Mean
 - F.2.4 Confidence Limits for the Mean of a Non-normal or Unknown Distribution
- F.3 Tests for a Proportion or a Percentile
 - F.3.1 Parametric Upper Confidence Limits for an Upper Percentile
 - F.3.2 Using a Simple Exceedance Rule Method for Determining Compliance With A Fixed Standard
- F.4 Treatment of Nondetects
 - F.4.1 Recommendations
 - F.4.2 Cohen's Adjustment

Table F-1 provides a summary of frequently used statistical equations. See Appendix G for statistical tables used with these methods.

Appendix F

Table F-1. Summary of Basic Statistical Terminology Applicable to Sampling Plans for Solid Waste

Terminology	Symbol	Mathematical Equation	Equation No.
Variable (e.g., barium or endrin)	x	--	--
Individual measurement of variable	x_i	--	--
Simple Random Sampling and Systematic Random Sampling			
Mean of measurements generated from the samples (sample mean)	\bar{x}	$\bar{x} = \frac{1}{n} \sum_{i=1}^n x_i$ <p>where n = number of sample measurements.</p>	1
Variance of sample	s^2	$s^2 = \frac{1}{n-1} \sum_{i=1}^n (x_i - \bar{x})^2$	2
Standard deviation of sample	s	$s = \sqrt{s^2}$	3
Standard error (also standard deviation of the mean)	$s_{\bar{x}}$	$s_{\bar{x}} = \frac{s}{\sqrt{n}}$	4
Approximate number of samples to estimate the mean (financial constraints not considered) (See Section 5.4.1)	n	$n = \frac{(z_{1-\alpha} + z_{1-\beta})^2 s^2}{\Delta^2} + \frac{z_{1-\alpha}^2}{2}$ <p>where the "z" values are obtained from the last row of Table G-1 in Appendix G.</p>	8
Approximate number of samples to test a proportion against a fixed standard (See Section 5.5.1).	n	$n = \left[\frac{z_{1-\beta} \sqrt{GR(1-GR)} + z_{1-\alpha} \sqrt{AL(1-AL)}}{\Delta^2} \right]^2$	15
Number of samples to test a proportion when the decision rule specifies zero nonconforming samples (See Section 5.5.2).	n	$n = \log(\alpha) / \log(p)$ <p>where p equals the proportion of the waste or media exceeded by the largest sample</p>	16

Table F-1. (Continued)

Terminology	Symbol	Mathematical Equation	Equation No.
Stratified Random Sampling (Proportional Allocation)			
Arithmetic mean of the measurements generated from the samples obtained from each h th stratum	\bar{x}_h	$\bar{x}_h = \frac{1}{n_h} \sum_{i=1}^{n_h} x_{hi}$ <p>where n_h = number of sample measurements obtained from each hth stratum.</p>	--
Variance of measurements generated from the samples obtained from each h th stratum	s_h^2	$s_h^2 = \frac{1}{n_h - 1} \sum_{i=1}^{n_h} (x_{hi} - \bar{x}_h)^2$	--
The weighting factor assigned to each h th stratum when stratified random sampling is used	W_h	--	--
Overall sample mean using stratified random sampling	\bar{x}_{st}	$\bar{x}_{st} = \sum_{h=1}^L W_h \bar{x}_h$	9
Standard error of the mean for a stratified random sample	$s_{\bar{x}_{st}}$	$s_{\bar{x}_{st}} = \sqrt{\sum_{h=1}^L W_h^2 \frac{s_h^2}{n_h}}$	10
Total number of samples to collect from a solid waste to estimate the mean using stratified random sampling (proportional allocation)	n	$n = \frac{[t_{1-\alpha,df} + t_{1-\beta,df}]^2}{\Delta^2} \sum_{h=1}^L W_h s_h^2$	11
Degrees of freedom associated with the t -quantile in Table G-1, Appendix G, when stratified random sampling is used	df	$df = \left(\sum_{h=1}^L W_h s_h^2 \right)^2 / \sum_{h=1}^L \frac{W_h^2 s_h^4}{n W_h - 1}$	12

F.1 Testing Distributional Assumptions

F.1.1 Overview and Recommendations

The assumption of normality is very important as it is the basis for many statistical tests. A normal distribution is a reasonable model of the behavior of certain random phenomena and often can be used to approximate other probability distributions. In addition, the Central Limit Theorem and other limit theorems state that as the sample size gets large, some of the sample summary statistics (such as the sample mean) behave as if they are normally distributed variables. As a result, a common assumption associated with parametric tests or statistical models is that the errors associated with data or a model follow a normal distribution.

While assumption of a normal distribution is convenient for statistical testing purposes, it is not always appropriate. Sometimes data are highly skewed. In environmental applications, it is not unusual to encounter data that exhibit a lognormal distribution in which the *natural* logarithms of the data exhibit a normal distribution. Statistical tests can be used to verify the assumption of normality or lognormality, but the conclusion of lognormality should not be based on the outcome of a statistical test alone. There are several physical phenomena that can cause the underlying distribution to appear lognormal when in fact it is not. For example, Singh, et al. (1997) note that the presence of a relatively small highly contaminated area in an otherwise uncontaminated area can cause sampling results to indicate a lognormal distribution. In such a situation, it may be more appropriate to treat the areas as two separate decision units or use a stratified sampling design. In other cases, sampling bias may cause a population to appear lognormal. For example, analytical results could be skewed if highly concentrated portions of the waste are over- or under-represented by the sampling procedure.

There are many methods available for verifying the assumption of normality ranging from simple to complex. This guidance recommends use of the Shapiro-Wilk test for normality. Use of the test is appropriate when the number of samples (n) is 50 or less. For n greater than 50, an alternative test for normality should be used. One alternative presented in EPA's QA/G-9 guidance (USEPA 2000d) and the DataQUEST software (USEPA 1997b) is Filliben's Statistic (Filliben 1975). Refer to EPA's QA/G-9 (USEPA 2000d) guidance or EPA's statistical guidance for ground-water monitoring data (USEPA 1989b and 1992b) for other graphical and statistical goodness-of-fit tests.

F.1.2 Shapiro-Wilk Test for Normality ($n \leq 50$)

Purpose and Background

This section provides the method for performing the Shapiro-Wilk test for normality. The test is easily performed using statistical software such as EPA's DataQUEST freeware (USEPA 1997b); however, the test also can be performed manually, as described here.

The Shapiro-Wilk test is recommended as a superior method for testing normality of the data. It is based on the premise that if the data are normally distributed, the ordered values should be highly correlated with corresponding quantiles (z-scores) taken from a normal distribution (Shapiro and Wilk 1965). In particular, the Shapiro-Wilk test gives substantial weight to evidence of non-normality in the tails of a distribution, where the robustness of statistical tests based on the normality assumption is most severely affected.

The Shapiro-Wilk test statistic (W) will tend to be large when a probability plot of the data indicates a nearly straight line. Only when the plotted data show significant bends or curves will the test statistic be small. The Shapiro-Wilk test is considered to be one of the very best tests of normality available (Miller 1986, Madansky 1988).

Procedure

- Step 1. Order the data from least to greatest, labeling the observations as x_i for $i = 1 \dots n$. Using the notation $x_{(j)}$, let the j th order statistic from any data set represent the j th smallest value.
- Step 2. Compute the differences $[x_{(n-i+1)} - x_{(i)}]$ for each $i = 1 \dots n$. Then determine k as the greatest integer less than or equal to $(n / 2)$.
- Step 3. Use Table G-4 in Appendix G to determine the Shapiro-Wilk coefficients, a_{n-i+1} , for $i = 1 \dots n$. Note that while these coefficients depend only on the sample size (n), the order of the coefficients must be preserved when used in step 4 below. The coefficients can be determined for any sample size from $n = 3$ up to $n = 50$.
- Step 4. Compute the quantity b given by the following formula:

$$b = \sum_{i=1}^k b_i = \sum_{i=1}^k a_{n-i+1} (x_{(n-i+1)} - x_{(i)}) \quad \text{Equation F.1}$$

Note that the values b_i are simply intermediate quantities represented by the terms in the sum of the right-hand expression in the above equation.

- Step 5. Calculate the standard deviation (s) of the data set. Then compute the Shapiro-Wilk test statistic using the following formula:

$$W = \left[\frac{b}{s\sqrt{n-1}} \right]^2 \quad \text{Equation F.2}$$

- Step 6. Given the significance level (α) of the test (for example, 0.01 or 0.05), determine the critical point of the Shapiro-Wilk test with n observations using Table G-5 in Appendix G. Compare the Shapiro-Wilk statistic (W) against the critical point (w_c). If the test statistic exceeds the critical point, accept normality as a reasonable model for the underlying population; however, if $W < w_c$, reject the null hypothesis of normality at the α -level and decide that another distributional model would provide a better fit.

An example calculation of the Shapiro-Wilk test for normality is presented in Box F.1.

Box F.1. Example Calculation of the Shapiro-Wilk Test for Normality

Use the Shapiro-Wilk test for normality to determine whether the following data set, representing the total concentration of nickel in a solid waste, follows a normal distribution: 58.8, 19, 39, 3.1, 1, 81.5, 151, 942, 262, 331, 27, 85.6, 56, 14, 21.4, 10, 8.7, 64.4, 578, and 637.

Solution

Step 1. Order the data from smallest to largest and list, as in Table F-2. Also list the data in reverse order alongside the first column.

Step 2. Compute the differences $[x_{(n-i+1)} - x_{(i)}]$ in column 4 of the table by subtracting column 2 from column 3. Because the total number of samples is $n = 20$, the largest integer less than or equal to $(n/2)$ is $k = 10$.

Step 3. Look up the coefficients a_{n-i+1} from Table G-4 in Appendix G and list in column 4.

Step 4. Multiply the differences in column 4 by the coefficients in column 5 and add the first k products (b_i) to get quantity b_i , using Equation F.1.

$$b = [.4734(941.0) + .3211(633.9) + \dots + .0140(2.8)] = 932.88$$

Step 5. Compute the standard deviation of the sample, $S = 259.72$, then use Equation F.2 to calculate the Shapiro-Wilk test statistic:

$$W = \left[\frac{932.88}{259.72\sqrt{19}} \right]^2 = 0.679$$

Step 6. Use Table G-5 in Appendix G to determine the .01-level critical point for the Shapiro-Wilk test when $n = 20$. This gives $w_c = 0.868$. Then, compare the observed value of $W = 0.679$ to the 1-percent critical point. Since $W < 0.868$, the sample shows significant evidence of non-normality by the Shapiro-Wilk test. The data should be transformed using natural logs and rechecked using the Shapiro-Wilk test before proceeding with further statistical analysis.

Table F-2. Example Calculation of the Shapiro-Wilk Test (see example in Box F.1)

i	$x_{(i)}$	$x_{(n-i+1)}$	$x_{(n-i+1)} - x_{(i)}$	a_{n-i+1}	b_i
1	1	942	941	0.4734	445.47
2	3.1	637	634	0.3211	203.55
3	8.7	578	569	0.2565	146.03
4	10	331	321	0.2085	66.93
5	14	262	248	0.1686	41.81
6	19	151	132	0.1334	17.61
7	21.4	85.6	64.2	0.1013	6.5
8	27	81.5	54.5	0.0711	3.87
9	39	64.4	25.4	0.0422	1.07
10	56	58.8	2.8	0.0140	<u>0.04</u>
11	58.8	56	-2.8		$b = 932.88$
12	64.4	39	-25.4		
13	81.5	27	-54.5		
14	85.6	21.4	-64.2		
15	151	19	-132.0		
16	262	14	-248.0		
17	331	10	-321.0		
18	578	8.7	-569.3		
19	637	3.1	-633.9		
20	942	1	-941.0		

F.2 Confidence Limits for the Mean

When a fixed standard or limit is meant to represent an average or mean concentration level, attainment of the standard can be measured using a confidence limit on the mean. A confidence limit is then compared with the fixed compliance limit. Under the null hypothesis that the mean concentration in the waste exceeds the standard unless proven otherwise, statistically significant evidence of compliance with the standard is shown if and only if the entire confidence interval lies below the standard. By implication, the key test then involves comparing the upper confidence limit (UCL) to the standard. In other words, the entire confidence interval must lie below the standard for the waste to be compliant with the standard. If the UCL exceeds the regulatory limit, on the other hand, we cannot conclude the mean concentration is below the standard.

F.2.1 Confidence Limits for the Mean of a Normal Distribution

Requirements and Assumptions

Confidence intervals for the mean of a normal distribution should be constructed only if the data pass a test of approximate normality or at least are reasonably symmetric. It is strongly recommended that a confidence interval not be constructed with less than four measurements, though the actual number of samples should be determined as part of the planning process. The reason for this is two-fold: (1) the formula for a normal-based confidence interval on the

Appendix F

mean involves calculation of the sample standard deviation (s), which is used as an estimate of the underlying population standard deviation (this estimate may not be particularly accurate when the sample size is smaller than four), and (2) the confidence interval formula also involves a Student's t -quantile based on $n - 1$ degrees of freedom, where n equals the number of samples used in the calculation (see Table G-1 in Appendix G). When n is quite small, the t -quantile will be relatively large, leading to a much wider confidence interval than would be expected with a larger n . For example, at a 90-percent confidence level, the appropriate t -quantile would be $t = 3.078$ for $n = 2$, $t = 1.638$ for $n = 4$, and $t = 1.415$ for $n = 8$.

Procedure

Step 1. Check the n sample concentrations for normality. If the normal model is acceptable, calculate the mean (\bar{x}) and standard deviation (s) of the data set. If the lognormal model provides a better fit, see Section F.2.3.

Step 2. Given the desired level of confidence, $(1 - \alpha)$, calculate the upper confidence limit as follows:

$$UCL = \bar{x} + t_{1-\alpha,df} \frac{s}{\sqrt{n}} \quad \text{Equation F.3}$$

where $t_{1-\alpha,df}$ is obtained from a Student's t -table (Table G-1) with the appropriate degrees of freedom. If simple random or systematic sampling is used, then $df = n - 1$.

If stratified random sampling is used, calculate the UCL as follows:

$$UCL_{st} = \bar{x}_{st} + t_{1-\alpha,df} s_{\bar{x}_{st}} \quad \text{Equation F.4}$$

where \bar{x}_{st} is the overall mean from Equation 8, the df is obtained from Equation 11, and the standard error ($s_{\bar{x}_{st}}$) is obtained from Equation 9 (see also Table F-1 for these equations).

Step 3. Compare the UCL calculated in Step 2 to the fixed standard. If the UCL is less than the standard, then you can conclude, with $100(1 - \alpha)\%$ confidence, that the mean concentration of the constituent of concern is less than the standard. If, however, the upper confidence bound is greater than the standard, then there is not sufficient evidence that the mean is less than the standard.

An example calculation of the UCL on the mean is provided in Box F.2.

Box F.2. Example Calculation of the UCL for a Normal Mean

A generator obtains ten samples of waste to demonstrate that the waste qualifies for the comparable fuels exclusion under 40 CFR 261.38. The samples are obtained using a simple random sampling design. Analysis of the samples for lead generated the following results: 16, 17.5, 21, 22, 23, 24, 24.5, 27, 31, and 38 ppm. The regulation requires comparison of a 95% UCL on the mean to the specification level. The specification level is 31 ppm.

Solution

Step 1. Using the Shapiro-Wilk test, we confirmed that the normal model is acceptable. The mean is calculated as 24.4 ppm and the standard deviation as 6.44 ppm.

Step 2. The RCRA regulations at 40 CFR 261.38(c)(8)(iii)(A) require that the determination be made with a level of confidence, $100(1 - \alpha)\%$, of 95 percent. We turn to Table G-1 (Appendix G) and find the Student's t value is 1.833 for $n - 1 = 9$ degrees of freedom. The UCL is calculated as follows:

$$UCL = 24.4 + 1.833 \frac{6.44}{\sqrt{10}} = 28.1 \approx 28$$

Step 3. We compare the limit calculated in step 2 to the fixed standard. Because the UCL (28 ppm) is less than the regulatory level (31 ppm), we can conclude with at least 95-percent confidence that the mean concentration of the constituent in the waste is less than 31 ppm.

F.2.2 Confidence Limits for a Normal Mean When Composite Sampling Is Used

If a composite sampling strategy has been employed to obtain a more precise estimate of the mean, confidence limits can be calculated from the analytical results using the same procedure outlined above in Section F.2.1, except that n represents the number of composite samples and s represents the standard deviation of the n composite samples.

F.2.3 Confidence Limits for a Lognormal Mean

If the results of a test for normality indicate the data set may have a lognormal distribution, and a confidence limit on the mean is desired, then a special approach is required. It is *not* correct to simply transform the data to the log scale, calculate a normal-based mean and confidence interval on the logged data, and transform the results back to the original scale. It is a common mistake to do so. Invariably, a transformation bias will be introduced and the approach will underestimate the mean and UCL. In fact, the procedure just described actually produces a confidence interval around the *median* of a lognormal population rather than the higher-valued *mean*.

To calculate a UCL on the mean for data that exhibit a lognormal distribution, this guidance recommends use of a procedure developed by Land (1971, 1975); however, as noted below, Land's procedure should be used with caution because it relies heavily on the lognormal assumption, and if that assumption is not true, the results may be substantially biased.

Requirements and Assumptions

Confidence intervals for the mean of a lognormal distribution should be constructed only if the data pass a test of approximate normality *on the log-scale*. While many environmental

Appendix F

populations tend to follow the lognormal distribution, it is usually wisest to first test the data for normality on the original scale. If such a test fails, the data can then be transformed to the log-scale and retested.

Cautionary Note: Even if a data set passes a test for normality on the log scale, do not proceed with calculation of the confidence limits using Land's procedure until you have considered the following:

- The skewness of the data set may be due to biased sampling, mixed distributions of multiple populations, or outliers, and not necessarily due to lognormally distributed data (see Singh, et al. 1997). Review the sampling approach, the physical characteristics of the waste or media, and recheck any unusually high values before computing the confidence limits. Where there is spatial clustering of sample data, declustering and distribution weighting techniques (Myers 1997) may also be appropriate.
- If the number of samples (n) is small, the confidence interval obtained by Land's procedure could be remarkably wide. Singh, et al. (1997) have recommended that Land's procedure not be used for cases in which the number of samples is less than 30. They argue that in many cases the resulting UCL will be an order of magnitude larger than the maximum observed data value. Even higher values for the UCL could be generated if the coefficient of variation (CV or the standard deviation divided by the mean) is greater than 1.

If the lognormal distribution is the best fit, and the number of samples (n) is small, then Land's method (provided below) can still be used, though a "penalty" will be paid for the small sample size. If the number of samples is small and the distribution is skewed to the right, one of the following alternative approaches should be considered: (1) Simply treat the data set as if the parent distribution were normal and use the parametric Student- t method to calculate confidence limits using the *untransformed* (original scale) data (as described in Section F.2.1). If, however, this normal theory approach is used with highly skewed data, the actual confidence level achieved by the test will be less than that desired (Porter, et al. 1997); (2) UCLs on the mean could be constructed using procedures such as the "bootstrap" or the "jackknife," as recommended by Singh, et al. (1997) (see Section F.2.4).

The approach for Land's "H-statistic" method is given below:

Procedure

- Step 1. Test the data for normality on the log-scale. After determining that the lognormal distribution is a good fit, transform the data via logarithms (the natural log is used) and denote the transformed measurements by y_i .
- Step 2. Compute the sample mean and the standard deviation (S_y) from the log-scale measurements.
- Step 3. Obtain Land's bias-correction factor(s) ($H_{1-\alpha}$) from Table G-6 in Appendix G, where the correct factor depends on the sample size (n), the log-scale sample

standard deviation (s_y), and the desired confidence level ($1 - \alpha$).¹

Step 4. Plug all these factors into the equations given below for the UCL.

$$UCL_{1-\alpha} = \exp\left(\bar{y} + .5s_y^2 + \frac{s_y H_{1-\alpha}}{\sqrt{n-1}}\right) \quad \text{Equation F.5}$$

Step 5. Compare the UCL against the fixed standard. If the UCL is less than the standard, then you can conclude with $100(1 - \alpha)\%$ confidence that the mean concentration of the constituent of concern is less than the standard. If, however, the upper confidence bound is greater than the standard, then there is not sufficient evidence that the mean is less than the standard.

An example calculation of the UCL on a lognormal mean is given in Box F.3.

Box F.3: Example Calculation of the UCL on a Lognormal Mean

This example is modified after an example provided in *Supplemental Guidance to RAGS: Calculating the Concentration Term* (USEPA 1992a).

The concentration of lead (total in mg/Kg) in 31 soil samples obtained using a simple random sampling design are: 1, 3, 13, 14, 18, 20, 21, 36, 37, 41, 42, 45, 48, 59, 60, 110, 110, 111, 111, 136, 137, 140, 141, 160, 161, 200, 201, 230, 400, 1300, and 1400. Using these data, calculate a 90% UCL on the mean.

Solution

Step 1. Using the Shapiro-Wilk test, the natural logarithms of the data set are shown to exhibit a normal distribution. The data are then transformed to natural logs.

Step 2. The mean of logged data is $\bar{y} = 4.397$. The standard deviation is $s_y = 1.509$.

Step 3. The bias-correction factor ($H_{1-\alpha} = 2.282$) is obtained from Table G-6 for $n = 31$ and a confidence level of 90 percent.

Step 4. Plug the factors into the equation for the upper (UCL) confidence limit.

$$\begin{aligned} UCL_{1-\alpha} &= \exp\left(4.222 + 0.5(1.509)^2 + \frac{1.509(2.282)}{\sqrt{31-1}}\right) \\ &= \exp(5.989) = 399 \text{ mg / kg} \end{aligned}$$

Step 5. The 90-percent UCL on the mean is 399 mg/kg.

¹ For a more extensive tabulation of Land's factors, see Land (1975) or Tables A10 through A13 in Gilbert (1987).

F.2.4 Confidence Limits for the Mean of a Non-normal or Unknown Distribution

If the assumption of a normal or lognormal distribution cannot be justified, then you may construct a UCL on the mean using one of several alternative methods described in this section.

Bootstrap or Jackknife Methods: Bootstrap and jackknife procedures, as discussed by Efron (1981) and Miller (1974), typically are nonparametric statistical techniques which can be used to reduce the bias of point estimates and construct approximate confidence intervals for parameters such as the population mean. These procedures require no assumptions regarding the statistical distribution (e.g., normal or lognormal) for the underlying population.

Using a computer, the bootstrap method randomly samples n values with replacement from the original set of n random observations. For each bootstrap sample, the mean (or some other statistic) is calculated. This process of “resampling” is repeated hundreds or perhaps thousands of times and the multiple estimates of the mean are used to define the confidence limits on the mean. The jackknife approximates the bootstrap. Rather than resampling randomly from the entire sample like the bootstrap does, the jackknife takes the entire sample except for one value, and then calculates the statistic of interest. It repeats the process, each time leaving out a different value, and each time recalculating the test statistic.

Both the bootstrap and the jackknife methods require a great deal of computer power, and, historically have not been widely adopted by environmental statisticians (Singh, et al. 1997). However, with advances in computer power and availability of software, computationally intensive statistical procedures have become more practical and accessible. Users of this guidance interested in applying a “resampling” method such as the bootstrap or jackknife should check the capabilities of available software packages and consult with a professional statistician on the correct use and application of the procedures.

Nonparametric Confidence Limits: If the data are not assumed to follow a particular distribution, then it may not be possible to calculate a UCL on the mean using normal theory techniques. If, however, the data are non-normal but approximately *symmetric*, a nonparametric UCL on the *median* (or the 50th percentile) may serve as a reasonable alternative to calculation of a parametric UCL on the mean. *One severe limitation of this approach is that it involves changing the parameter of interest (as determined in the DQO Process) from the mean to the median, potentially biasing the result if the distribution of the data is not symmetric.* Accordingly, the procedure should be used with caution.

Lookup tables can be used to determine the confidence limits on the median (50th percentile). For example, see Conover (1999, Table A3) or Gilbert (1987, Table A14). In general, when the sample size is very small (e.g., less than about nine or ten samples) and the required level of confidence is high (e.g., 95 to 99 percent), the tables will designate the maximum value in the data set as the upper confidence limit. Conover (1999, page 143) gives a large sample approximation for a confidence interval on a proportion (quantile). Methods also are given in Gilbert (1987, page 173), Hahn and Meeker (1991, page 83), and USEPA (1992i, page 5-30).

F.3 Tests for a Proportion or Percentile

Some RCRA standards represent concentrations that should rarely or never be exceeded for the waste or media to comply with the standard. To measure compliance with such a standard, a waste handler may want to know with some specified level of confidence that a high proportion of the waste complies with the standard (or conversely, that at most only a small proportion of all possible samples could exceed the standard). Two approaches are given for measuring compliance with such a standard:

1. Under the assumption of a normal distribution, use a parametric UCL on a percentile to demonstrate that the true p th percentile (x_p) concentration in the set of all possible samples is less than the concentration standard. The method is given below in **Section F.3.1**.
2. By far, the simplest method for testing proportions is to use an “exceedance rule” in which the proportion of the population with concentrations less than the standard can be estimated based on the total number of sample values and the number of those (if any) that exceed the standard. The exceedance rule method is given below in **Section F.3.2**.

If the number of samples is relatively large, then a “one-sample proportion test” also can be used to test a proportion against a fixed standard. The one-sample proportion test is described in Section 3.2.2.1 in *Guidance for Data Quality Assessment, EPA QA/G-9 (QA00 Update)* (USEPA 2000d).

F.3.1 Parametric Upper Confidence Limits for an Upper Percentile

If the study objective is to demonstrate that the true p th percentile (x_p) concentration in the set of all possible samples (of a given sample support) is less than the applicable standard or Action Level, then a UCL on the upper percentile can be used to determine attainment of the standard.

Requirements and Assumptions

The formulas for constructing parametric UCL on an upper percentile assume that the data are at least approximately normally distributed. Therefore, such a limit should be constructed only if the data pass a test of normality. If the data are best fit by a lognormal distribution instead, the observations should first be transformed to the log-scale. Unlike confidence limits for a lognormal mean, no special equations are required to construct similar limits on an upper percentile. The same formula used when the data are normally distributed can be applied to the log-scale data. The only additional step is that the confidence interval limits must be re-exponentiated before comparing them against the regulatory standard.

It is strongly recommended that a confidence limit not be constructed with less than four measurements, and preferably more (the actual number, however, should be determined during Step Seven of the DQO Process). There are three reasons for this: (1) the formula for a normal-based confidence interval on an upper percentile involves calculation of the sample standard deviation, s , which is used as an estimate of the underlying population standard deviation. This estimate may not be accurate when fewer than four samples are used. (2) The confidence interval formula also involves a special factor κ (“kappa”), which depends on both

Appendix F

the desired confidence level $(1 - \alpha)$ and the number of samples, n , used in the calculation. When n is quite small, the κ factor is more extreme, leading to a much wider confidence interval than would be expected with a larger n . For example, at a confidence level of 90 percent, the appropriate κ factor for an upper one-sided limit on the 99th percentile is $\kappa = 18.50$ when $n = 2$, $\kappa = 5.438$ when $n = 4$, and $\kappa = 3.783$ when $n = 8$. (3) The third reason is that the power of the test for normality or lognormality is very low with a small number of samples.

Procedure

- Step 1. First test the data for normality on the original scale. If a test of normality is passed, calculate the limit on the raw measurements. If the data violate the assumption of normality, but pass a test of lognormality, calculate the limit using the log-scale data.
- Step 2. If the data are normal, compute the mean and standard deviation of the raw data. If the data are consistent with lognormality instead, compute the mean and standard deviation after first transforming the data to the log-scale.
- Step 3. Given the percentile (p) being estimated, the sample size (n), and the desired confidence level $(1 - \alpha)$, use Table G-2 (in Appendix G) to determine the κ factor(s) needed to construct the appropriate UCL. A one-sided upper confidence bound is then computed with the formula

$$UL_{1-\alpha}(x_p) = \bar{x} + s \cdot \kappa_{1-\alpha,p} \quad \text{Equation F.6}$$

where $\kappa_{1-\alpha,p}$ is the upper $1 - \alpha$ factor for the p th percentile with n sample measurements.

Again, if the data are lognormal instead of normal, the same formula would be used but with the log-scale mean and standard deviation substituted for the raw-scale values. Then the limit must be exponentiated to get the final upper confidence bound, as in the following formula for an upper bound with $(1 - \alpha)100\%$ confidence:

$$UL_{1-\alpha}(x_p) = \exp\left[\bar{y} + s_y \cdot \kappa_{1-\alpha,p}\right] \quad \text{Equation F.7}$$

- Step 4. Compare the upper $(1 - \alpha)100\%$ confidence bound against the fixed standard. If the upper limit exceeds the standard, then the standard is not met.

An example calculation of the UCL on a percentile is given in Box F.4.

Box F.4. Example Calculation of a UCL on an Upper Percentile To Classify a Solid Waste

A secondary lead smelter produces a slag that under some operating conditions exhibits the Toxicity Characteristic (TC) for lead. The facility owner needs to classify a batch of waste as either hazardous or nonhazardous at the point of waste generation. During the planning process, the owner determined based on previous sampling studies that the constituent of interest is lead, TCLP results for lead tend to exhibit a normal distribution, and a sample size of ten 200-gram samples (not including QC samples) should satisfy the study objectives. The TC regulatory level for lead is 5 mg/L. The owner wants to determine, with 90-percent confidence, whether a large proportion (e.g., at least 95 percent) of all possible samples of the waste will be below the regulatory limit.

At the point of waste generation, the facility representative takes a series of systematic samples of the waste. The following sample analysis results were generated for ten samples analyzed for lead via the TCLP and SW-846 Method 6010B: <0.5, 0.55, 0.60, 0.80, 0.90, 1.00, 1.50, 1.80, 2.00, and 3.00 mg/L.

Calculate a 90-percent upper confidence limit on the 95th percentile.

Solution

Step 1. Based on the shape of the histogram and normal probability plot, the data were judged to exhibit a normal distribution. Therefore, we proceed with the calculation on the original (untransformed) scale.

Step 2. One value (10% of the measurements) is reported below the quantitation limit of 0.5 mg/L so we replace that value with half the quantitation limit (0.25 mg/L) (see also Section F.4). The mean and standard deviation of the data set are then calculated as $\bar{x} = 1.24$ mg/L and $s = 0.836$.

Step 3. Use Table G-2 (in Appendix G) to determine the K' factor for $n = 10$ needed to construct a 90-percent UCL on the 95th percentile. The table indicates $K' = 2.568$. Plug \bar{x} , s , and K' into Equation F.6, as follows:

$$UL_{0.90}(x_{0.95}) = 1.24 + (0.836)(2.568) = 3.39 \approx 3.4 \text{ mg / L}$$

Step 4. All of the sample analysis results are less than the TC regulatory limit of 5 mg/L TCLP for lead, and the owner concludes that the waste is a nonhazardous waste under RCRA. The owner also can conclude with at least 90-percent confidence that at least 95 percent of all possible sample analysis results representing the batch of waste in the roll-off bin are nonhazardous.

F.3.2 Using a Simple Exceedance Rule Method for Determining Compliance With A Fixed Standard

Some RCRA standards represent concentration limits that should never or rarely be exceeded or waste properties that should never or rarely be exhibited for the waste to comply with the standard. One of the simplest nonparametric methods for determining compliance with such a standard is to use an “exceedance rule” (USEPA 1989a). To apply this method, simply require that a number of samples be acquired and that zero or a small number (e.g., one) of the concentration measurements be allowed to exceed the standard. This kind of rule is easy to implement and evaluate once the data are collected. It only requires specification of a number of samples and the number of exceedances allowed (usually zero, for example, for compliance with the LDR concentration level treatment standards). Alternately, one can specify the statistical performance criteria in advance and then determine the number of samples required.

Requirements and Assumptions for Use of an Exceedance Rule

The method given here is a simple nonparametric method and requires only the ability to identify the number of samples in the data set and whether each sample analysis result complies with the applicable standard or does not comply with the standard. Unfortunately, this ease of use comes with a price. Compared to parametric methods that assume underlying normality or lognormality of the data, the nonparametric method given here requires significantly more samples to achieve the same level of confidence.

Procedure

- Step 1: Specify the degree of confidence desired, $100(1 - \alpha)\%$, and the proportion (p) of the population that must comply with the standard.
- Step 2: If the decision rule permits no exceedance of the standard for any single sample in a set of samples, then obtain and analyze the number of samples (n) indicated in Table G-3a in Appendix G.
- If the decision rule permits a single exceedance of the standard in a set of samples, then obtain and analyze the number of samples (n) indicated in Table G-3b in Appendix G.
- Step 3: Based on the number of samples obtained and the statistical performance required, determine whether the applicable standard has been attained.

An example application of the exceedance rule is Box F.5.

Box F.5: Example Application of a Simple Exceedance Rule

A facility has treated nonwastewater F003 solvent waste containing carbon disulfide to attain the LDR UTS. Samples of the treatment residue are obtained systematically as the waste treatment is completed. The treater wants to have at least 90% confidence that at least 90% of the batch of treated waste attains the standard. To comply with the LDR regulations, no samples can exceed the UTS. TCLP analyses for carbon disulfide in the treated waste are required to measure compliance with the treatment standard of 4.8 mg/L TCLP.

From **Table G-3a** we find that for a confidence level ($1 - \alpha$) of .90 (or 90%) and a proportion of .90, at least 22 samples are required. All sample analysis results must be less than or equal to the UTS of 4.8 mg/L TCLP for the statistical performance criteria to be achieved.

If only 9 samples are obtained (with all sample analysis results less than or equal to the standard), what level of confidence can the treater have that at least 90-percent (or $p = 0.90$) of all possible samples drawn from the waste meet the treatment standard?

From **Table G-3a** we find for $p = 0.90$ and $n = 9$, $1 - \alpha = 0.60$. Therefore, the $100(1 - \alpha)\%$ confidence level equals only 60 percent.

F.4 Treatment of Nondetects in Statistical Tests

Data generated from chemical analysis may fall below a limit of detection of the analytical procedure. These measurement data generally are described as “nondetects”, (rather than as zero or not present) and the appropriate limit of detection - such as a quantitation limit - usually is reported. Data sets that include both detected and nondetected results are called “censored” data in the statistical literature.

If a relatively small proportion of the data are reported below detection limit values, replacing the nondetects with a small number (between zero and the detection limit) and proceeding with the usual analysis may be satisfactory. For moderate amounts of data below the detection limit, a more detailed adjustment is appropriate. In situations in which relatively large amounts of data below the detection limit exist, one may need only to consider whether the chemical was detected as above some level or not.

F.4.1 Recommendations

If no more than approximately 15 percent of the sample analysis results are nondetect for a given constituent, then the results of parametric statistical tests will not be substantially affected if nondetects are replaced by half their detection limits (USEPA 1992b).² When more than approximately 15 percent of the samples are nondetect, however, the handling of nondetects is more crucial to the outcome of statistical procedures. Indeed, simple substitution methods tend to perform poorly in statistical tests when the nondetect percentage is substantial (Gilliom and Helsel 1986). If the percentage of nondetects is between approximately 15 percent and 50 percent, we recommend use of Cohen’s Adjustment (see method below).

The conditions for use of Cohen's method, however, are limited (see method given below) and numerous alternative techniques for imputing left-censored data should be considered if the conditions for use of Cohen’s method do not apply. Other methods available include iterative techniques, regression on order statistics (ROS) methods, bias-corrected maximum likelihood estimator (MLE), restricted MLE, modified probability plotting, Winsorization, and lognormalized statistics (EPA Delta log). A modified probability plotting method called Helsel's Robust Method (Helsel 1990) is a popular method that should be considered. Most of the above methods can be performed using publicly available software entitled UnCensor© v. 4.0 (Newman et al. 1995). Although EPA’s Office of Solid Waste has not reviewed or tested this software, users of this guidance may be interested in investigating its use.

If the percentage of nondetects is greater than 50 percent, then the regression on order statistics method or Helsel’s Robust Method should be considered. As an alternative, EPA’s *Guidance for Data Quality Assessment EPA QA/G-9* (USEPA 2000d) suggests the use of a test for proportions when the percentage of nondetects is in the range of greater than 50 percent to 90 percent.

This guidance does not advocate a specific method for imputing or replacing values that lie

² Additional experience and research for EPA supporting development of guidance on the statistical analysis of ground-water monitoring data indicates that if the percentage of nondetects is as high as 20 to 25 percent, the results of parametric statistical tests may not be substantially affected if the nondetects are replaced with half their detection limits (Cameron 1999).

Appendix F

below the limit of detection, however, whichever method is selected should be adequately supported. Table F-3 provides a summary of approaches for handling nondetects in statistical intervals.

Table F-3. Guidance for Handling Nondetects In Statistical Intervals

Percentage of Data Reported as "Nondetect"	Recommended Treatment of Data Set
< 15%	Replace nondetects with DL/2
15% to 50%	Cohen's adjustment, regression order statistics, or Helsel's Robust Method
> 50%	Regression on order statistics, Helsel's Robust Method, or a test for proportions

Even with a small proportion of nondetects, care should be taken when choosing which value should be used as the "detection limit". There are important differences between the method detection limit and the quantitation limit (QL) in characterizing "nondetect" concentrations. Many nondetects are characterized by analytical laboratories with one of three data qualifier flags: "U," "J," or "E." Samples with a "U" data qualifier represent "undetected" measurements, meaning that the signal characteristic of that analyte could not be observed or distinguished from "background noise" during lab analysis. Inorganic samples with an "E" flag and organic samples with a "J" flag may or may not be reported with an estimated concentration. If no concentration estimate is reported, these samples represent "detected but not quantified" measurements. In this case, the actual concentration is assumed to be positive, falling somewhere between zero and the QL. Because the actual concentration is unknown, the suggested substitution for parametric statistical procedures is to replace each nondetect qualified with an "E" or "J" with one-half the QL. Note, however, that "E" and "J" samples reported *with* estimated concentrations should be treated, for statistical purposes, as valid measurements. In other words, substitution of one-half the QL is *not recommended* for samples for which an estimated concentration is provided.

As a general rule, nondetect concentrations should not be assumed to be bounded above by the MDL. The MDL is usually estimated on the basis of ideal laboratory conditions with analyte samples that may or may not account for matrix or other interferences encountered when analyzing specific, actual field samples. For this reason, the QL typically should be taken as the most reasonable upper bound for nondetects when imputing specific concentration values to these measurements.

If a constituent is reported only as "not detected" and a detection limit is not provided, then review the raw data package to determine if a detection limit was provided. If not, identify the analytical method used and consult a qualified chemist for guidance on an appropriate QL.

F.4.2 Cohen's Adjustment

If a confidence limit is used to compare waste concentrations to a fixed standard, and a significant fraction of the observed measurements in the data set are reported as nondetects, simple substitution techniques (such as putting in half the detection limit for each nondetect) can lead to biased estimates of the mean or standard deviation and inaccurate confidence limits.

By using the detection limit and the pattern seen in the detected values, Cohen's method (Cohen 1959) attempts to reconstruct the key features of the original population, providing explicit estimates of the population mean and standard deviation. These, in turn, can be used to calculate confidence intervals, where Cohen's adjusted estimates are used as replacements for the sample mean and sample standard deviation.

Requirements and Assumptions

Cohen's Adjustment assumes that the common underlying population is normal. As such, the technique should only be used when the observed sample data approximately fit a normal model. Because the presence of a large fraction of nondetects will make explicit normality testing difficult, if not impossible, the most helpful diagnostic aid may be to construct a censored probability plot on the detected measurements. If the censored probability plot is clearly linear on the original measurement scale but not on the log-scale, assume normality for purposes of computing Cohen's Adjustment. If, however, the censored probability plot is clearly linear on the log-scale, but not on the original scale, assume the common underlying population is lognormal instead; then compute Cohen's Adjustment to the estimated mean and standard deviation on the log-scale measurements and construct the desired statistical interval using the algorithm for lognormally-distributed observations (see also Gilbert 1987, page 182).

When more than 50 percent of the observations are nondetect, the accuracy of Cohen's method breaks down substantially, getting worse as the percentage of nondetects increases. Because of this drawback, EPA does not recommend the use of Cohen's adjustment when more than half the data are nondetect. In such circumstances, one should consider an alternate statistical method (see Section F.4.1).

One other requirement of Cohen's method is that there be just a single censoring point. As discussed previously, data sets with multiple detection or quantitation limits may require a more sophisticated treatment.

Procedure

Step 1. Divide the data set into two groups: detects and nondetects. If the total sample size equals n , let m represent the number of detects and $(n - m)$ represent the number of nondetects. Denote the i th detected measurement by x_i , then compute the mean and sample variance of the group of detects (i.e., above the quantitation limit data) using the following formulas:

$$\bar{x}_d = \frac{1}{m} \sum_{i=1}^m x_i \quad \text{Equation F.8}$$

and

$$s_d^2 = \frac{1}{m-1} \left[\sum_{i=1}^m x_i^2 - m\bar{x}_d^2 \right] \quad \text{Equation F.9}$$

Appendix F

Step 2. Denote the single censoring point (e.g., the quantitation limit) by QL . Then compute the two intermediate quantities, h and γ , necessary to derive Cohen's adjustment via the following equations:

$$h = (n - m)/n \quad \text{Equation F.10}$$

and

$$\gamma = s_d^2 / (\bar{x}_d - QL)^2 \quad \text{Equation F.11}$$

Step 3. Use the intermediate quantities, h and γ to determine Cohen's adjustment parameter $\hat{\lambda}$ from Table G-7 in Appendix G. For example, if $h = 0.4$ and $\gamma = 0.30$, then $\hat{\lambda} = 0.6713$.

Step 4. Using the adjustment parameter $\hat{\lambda}$ found in step 3, compute adjusted estimates of the mean and standard deviation with the following formulas:

$$\bar{x} = \bar{x}_d - \hat{\lambda}(\bar{x}_d - QL) \quad \text{Equation F.12}$$

and

$$s = \sqrt{s_d^2 + \hat{\lambda}(\bar{x}_d - QL)^2} \quad \text{Equation F.13}$$

Step 5. Once the adjusted estimates for the population mean and standard deviation are derived, these values can be substituted for the sample mean and standard deviation in formulas for the desired confidence limit.

An example calculation using Cohen's method is given in Box F.6.

Box F.6. An Example of Cohen's Method

To determine attainment of a cleanup standard at SWMU, 24 random soil samples were obtained and analyzed for pentachlorophenol. Eight of the 24 values (33%) were below the matrix/laboratory-specific quantitation limit of 1 mg/L. The 24 values are <1.0, <1.0, <1.0, <1.0, <1.0, <1.0, <1.0, <1.0, 1.1, 1.5, 1.9, 2.0, 2.5, 2.6, 3.1, 3.3, 3.2, 3.2, 3.3, 3.4, 3.5, 3.8, 4.5, 5.8 mg/L. Cohen's Method will be used to adjust the sample mean and standard deviation for use in constructing a UCL on the mean to determine if the cleanup has attained the site-specific risk-based cleanup standard of 5.0 mg/kg.

Solution

Step 1: The sample mean of the $m = 16$ values greater than the quantitation limit is $\bar{x}_d = 3.044$

Step 2: The sample variance of the 16 quantified values is $s_d^2 = 1.325$.

Step 3: $h = (24 - 16) / 24 = 0.333$ and $\gamma = 1.325 / (3.044 - 1.0)^2 = 0.317$

Step 4: Table G-7 of Appendix G was used for $h = 0.333$ and $\gamma = 0.317$ to find the value of $\hat{\lambda}$. Since the table does not contain these entries exactly, double linear interpolation was used to estimate $\hat{\lambda} = 0.5223$.

Step 5: The adjusted sample mean and standard deviation are then estimated as follows:

$$\bar{x} = 3.044 - 0.5223(3.044 - 1.0) = 1.976 \approx 2.0 \text{ and}$$

$$s = \sqrt{1.325 + 0.5223(3.044 - 1.0)^2} = 1.873 \approx 1.9$$

This page intentionally left blank

APPENDIX G

STATISTICAL TABLES

Table G-1. Critical Values of Student's t Distribution (One-Tailed)

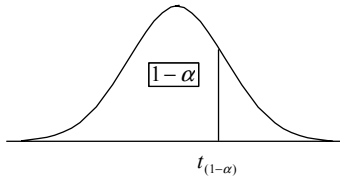

Degrees of Freedom (see note)	<i>t</i> values for $(1 - \alpha)$ or $(1 - \beta)$								
	0.70	0.75	0.80	0.85	0.90	0.95	0.975	0.99	0.995
1	0.727	1.000	1.376	1.963	3.078	6.314	12.706	31.821	63.657
2	0.617	0.816	1.061	1.386	1.886	2.920	4.303	6.965	9.925
3	0.584	0.765	0.978	1.250	1.638	2.353	3.182	4.541	5.841
4	0.569	0.741	0.941	1.190	1.533	2.132	2.776	3.747	4.604
5	0.559	0.727	0.920	1.156	1.476	2.015	2.571	3.365	4.032
6	0.553	0.718	0.906	1.134	1.440	1.943	2.447	3.143	3.707
7	0.549	0.711	0.896	1.119	1.415	1.895	2.365	2.998	3.499
8	0.546	0.706	0.889	1.108	1.397	1.860	2.306	2.896	3.355
9	0.543	0.703	0.883	1.100	1.383	1.833	2.262	2.821	3.250
10	0.542	0.700	0.879	1.093	1.372	1.812	2.228	2.764	3.169
11	0.540	0.697	0.876	1.088	1.363	1.796	2.201	2.718	3.106
12	0.539	0.695	0.873	1.083	1.356	1.782	2.179	2.681	3.055
13	0.538	0.694	0.870	1.079	1.350	1.771	2.160	2.650	3.012
14	0.537	0.692	0.868	1.076	1.345	1.761	2.145	2.624	2.977
15	0.536	0.691	0.866	1.074	1.340	1.753	2.131	2.602	2.947
16	0.535	0.690	0.865	1.071	1.337	1.746	2.120	2.583	2.921
17	0.534	0.689	0.863	1.069	1.333	1.740	2.110	2.567	2.898
18	0.534	0.688	0.862	1.067	1.330	1.734	2.101	2.552	2.878
19	0.533	0.688	0.861	1.066	1.328	1.729	2.093	2.539	2.861
20	0.533	0.687	0.860	1.064	1.325	1.725	2.086	2.528	2.845
21	0.532	0.686	0.859	1.063	1.323	1.721	2.080	2.518	2.831
22	0.532	0.686	0.858	1.061	1.321	1.717	2.074	2.508	2.819
23	0.532	0.685	0.858	1.060	1.319	1.714	2.069	2.500	2.807
24	0.531	0.685	0.857	1.059	1.318	1.711	2.064	2.492	2.797
25	0.531	0.684	0.856	1.058	1.316	1.708	2.060	2.485	2.787
26	0.531	0.684	0.856	1.058	1.315	1.706	2.056	2.479	2.779
27	0.531	0.684	0.855	1.057	1.314	1.703	2.052	2.473	2.771
28	0.530	0.683	0.855	1.056	1.313	1.701	2.048	2.467	2.763
29	0.530	0.683	0.854	1.055	1.311	1.699	2.045	2.462	2.756
30	0.530	0.683	0.854	1.055	1.310	1.697	2.042	2.457	2.750
40	0.529	0.681	0.851	1.050	1.303	1.684	2.021	2.423	2.704
60	0.527	0.679	0.848	1.046	1.296	1.671	2.000	2.390	2.660
120	0.526	0.677	0.845	1.041	1.289	1.658	1.980	2.358	2.617
∞	0.524	0.674	0.842	1.036	1.282	1.645	1.960	2.326	2.576

Note: For simple random or systematic sampling, degrees of freedom (df) are equal to the number of samples (n) collected from a solid waste and analyzed, less one (in other words, $df = n - 1$). If stratified random sampling is used, calculate df using Equation 12 or 14 in Section 5.4.2.2.

The last row of the table (∞ degrees of freedom) gives the critical values for a standard normal distribution (z). For example, the z value for $1 - \alpha$ where $\alpha = 0.10$ is found in the last row as 1.282.

Appendix G

Table G-2. Factors (K) for Parametric Upper Confidence Bounds on Upper Percentiles (p)

n	$p = 0.80$					$p = 0.90$					
	$1 - \alpha$	0.800	0.900	0.950	0.975	0.990	0.800	0.900	0.950	0.975	0.990
2		3.417	6.987	14.051	28.140	70.376	5.049	10.253	20.581	41.201	103.029
3		2.016	3.039	4.424	6.343	10.111	2.871	4.258	6.155	8.797	13.995
4		1.675	2.295	3.026	3.915	5.417	2.372	3.188	4.162	5.354	7.380
5		1.514	1.976	2.483	3.058	3.958	2.145	2.742	3.407	4.166	5.362
6		1.417	1.795	2.191	2.621	3.262	2.012	2.494	3.006	3.568	4.411
7		1.352	1.676	2.005	2.353	2.854	1.923	2.333	2.755	3.206	3.859
8		1.304	1.590	1.875	2.170	2.584	1.859	2.219	2.582	2.960	3.497
9		1.266	1.525	1.779	2.036	2.391	1.809	2.133	2.454	2.783	3.240
10		1.237	1.474	1.703	1.933	2.246	1.770	2.066	2.355	2.647	3.048
11		1.212	1.433	1.643	1.851	2.131	1.738	2.011	2.275	2.540	2.898
12		1.192	1.398	1.593	1.784	2.039	1.711	1.966	2.210	2.452	2.777
13		1.174	1.368	1.551	1.728	1.963	1.689	1.928	2.155	2.379	2.677
14		1.159	1.343	1.514	1.681	1.898	1.669	1.895	2.109	2.317	2.593
15		1.145	1.321	1.483	1.639	1.843	1.652	1.867	2.068	2.264	2.521
16		1.133	1.301	1.455	1.603	1.795	1.637	1.842	2.033	2.218	2.459
17		1.123	1.284	1.431	1.572	1.753	1.623	1.819	2.002	2.177	2.405
18		1.113	1.268	1.409	1.543	1.716	1.611	1.800	1.974	2.141	2.357
19		1.104	1.254	1.389	1.518	1.682	1.600	1.782	1.949	2.108	2.314
20		1.096	1.241	1.371	1.495	1.652	1.590	1.765	1.926	2.079	2.276
21		1.089	1.229	1.355	1.474	1.625	1.581	1.750	1.905	2.053	2.241
22		1.082	1.218	1.340	1.455	1.600	1.572	1.737	1.886	2.028	2.209
23		1.076	1.208	1.326	1.437	1.577	1.564	1.724	1.869	2.006	2.180
24		1.070	1.199	1.313	1.421	1.556	1.557	1.712	1.853	1.985	2.154
25		1.065	1.190	1.302	1.406	1.537	1.550	1.702	1.838	1.966	2.129
26		1.060	1.182	1.291	1.392	1.519	1.544	1.691	1.824	1.949	2.106
27		1.055	1.174	1.280	1.379	1.502	1.538	1.682	1.811	1.932	2.085
28		1.051	1.167	1.271	1.367	1.486	1.533	1.673	1.799	1.917	2.065
29		1.047	1.160	1.262	1.355	1.472	1.528	1.665	1.788	1.903	2.047
30		1.043	1.154	1.253	1.344	1.458	1.523	1.657	1.777	1.889	2.030
31		1.039	1.148	1.245	1.334	1.445	1.518	1.650	1.767	1.877	2.014
32		1.035	1.143	1.237	1.325	1.433	1.514	1.643	1.758	1.865	1.998
33		1.032	1.137	1.230	1.316	1.422	1.510	1.636	1.749	1.853	1.984
34		1.029	1.132	1.223	1.307	1.411	1.506	1.630	1.740	1.843	1.970
35		1.026	1.127	1.217	1.299	1.400	1.502	1.624	1.732	1.833	1.957
36		1.023	1.123	1.211	1.291	1.391	1.498	1.618	1.725	1.823	1.945
37		1.020	1.118	1.205	1.284	1.381	1.495	1.613	1.717	1.814	1.934
38		1.017	1.114	1.199	1.277	1.372	1.492	1.608	1.710	1.805	1.922
39		1.015	1.110	1.194	1.270	1.364	1.489	1.603	1.704	1.797	1.912
40		1.013	1.106	1.188	1.263	1.356	1.486	1.598	1.697	1.789	1.902
41		1.010	1.103	1.183	1.257	1.348	1.483	1.593	1.691	1.781	1.892
42		1.008	1.099	1.179	1.251	1.341	1.480	1.589	1.685	1.774	1.883
43		1.006	1.096	1.174	1.246	1.333	1.477	1.585	1.680	1.767	1.874
44		1.004	1.092	1.170	1.240	1.327	1.475	1.581	1.674	1.760	1.865
45		1.002	1.089	1.165	1.235	1.320	1.472	1.577	1.669	1.753	1.857
46		1.000	1.086	1.161	1.230	1.314	1.470	1.573	1.664	1.747	1.849
47		0.998	1.083	1.157	1.225	1.308	1.468	1.570	1.659	1.741	1.842
48		0.996	1.080	1.154	1.220	1.302	1.465	1.566	1.654	1.735	1.835
49		0.994	1.078	1.150	1.216	1.296	1.463	1.563	1.650	1.730	1.828
50		0.993	1.075	1.146	1.211	1.291	1.461	1.559	1.646	1.724	1.821
55		0.985	1.063	1.130	1.191	1.266	1.452	1.545	1.626	1.700	1.790
60		0.978	1.052	1.116	1.174	1.245	1.444	1.532	1.609	1.679	1.764
65		0.972	1.043	1.104	1.159	1.226	1.437	1.521	1.594	1.661	1.741
70		0.967	1.035	1.094	1.146	1.210	1.430	1.511	1.581	1.645	1.722
75		0.963	1.028	1.084	1.135	1.196	1.425	1.503	1.570	1.630	1.704
80		0.959	1.022	1.076	1.124	1.183	1.420	1.495	1.559	1.618	1.688
85		0.955	1.016	1.068	1.115	1.171	1.415	1.488	1.550	1.606	1.674
90		0.951	1.011	1.061	1.106	1.161	1.411	1.481	1.542	1.596	1.661
95		0.948	1.006	1.055	1.098	1.151	1.408	1.475	1.534	1.586	1.650
100		0.945	1.001	1.049	1.091	1.142	1.404	1.470	1.527	1.578	1.639

Table G-2. Factors (K) for Parametric Upper Confidence Bounds on Upper Percentiles (p) (continued)

n	$1 - \alpha$	$p = 0.95$					$p = 0.99$				
		0.800	0.900	0.950	0.975	0.990	0.800	0.900	0.950	0.975	0.990
2		6.464	13.090	26.260	52.559	131.426	9.156	18.500	37.094	74.234	185.617
3		3.604	5.311	7.656	10.927	17.370	5.010	7.340	10.553	15.043	23.896
4		2.968	3.957	5.144	6.602	9.083	4.110	5.438	7.042	9.018	12.387
5		2.683	3.400	4.203	5.124	6.578	3.711	4.666	5.741	6.980	8.939
6		2.517	3.092	3.708	4.385	5.406	3.482	4.243	5.062	5.967	7.335
7		2.407	2.894	3.399	3.940	4.728	3.331	3.972	4.642	5.361	6.412
8		2.328	2.754	3.187	3.640	4.285	3.224	3.783	4.354	4.954	5.812
9		2.268	2.650	3.031	3.424	3.972	3.142	3.641	4.143	4.662	5.389
10		2.220	2.568	2.911	3.259	3.738	3.078	3.532	3.981	4.440	5.074
11		2.182	2.503	2.815	3.129	3.556	3.026	3.443	3.852	4.265	4.829
12		2.149	2.448	2.736	3.023	3.410	2.982	3.371	3.747	4.124	4.633
13		2.122	2.402	2.671	2.936	3.290	2.946	3.309	3.659	4.006	4.472
14		2.098	2.363	2.614	2.861	3.189	2.914	3.257	3.585	3.907	4.337
15		2.078	2.329	2.566	2.797	3.102	2.887	3.212	3.520	3.822	4.222
16		2.059	2.299	2.524	2.742	3.028	2.863	3.172	3.464	3.749	4.123
17		2.043	2.272	2.486	2.693	2.963	2.841	3.137	3.414	3.684	4.037
18		2.029	2.249	2.453	2.650	2.905	2.822	3.105	3.370	3.627	3.960
19		2.016	2.227	2.423	2.611	2.854	2.804	3.077	3.331	3.575	3.892
20		2.004	2.208	2.396	2.576	2.808	2.789	3.052	3.295	3.529	3.832
21		1.993	2.190	2.371	2.544	2.766	2.774	3.028	3.263	3.487	3.777
22		1.983	2.174	2.349	2.515	2.729	2.761	3.007	3.233	3.449	3.727
23		1.973	2.159	2.328	2.489	2.694	2.749	2.987	3.206	3.414	3.681
24		1.965	2.145	2.309	2.465	2.662	2.738	2.969	3.181	3.382	3.640
25		1.957	2.132	2.292	2.442	2.633	2.727	2.952	3.158	3.353	3.601
26		1.949	2.120	2.275	2.421	2.606	2.718	2.937	3.136	3.325	3.566
27		1.943	2.109	2.260	2.402	2.581	2.708	2.922	3.116	3.300	3.533
28		1.936	2.099	2.246	2.384	2.558	2.700	2.909	3.098	3.276	3.502
29		1.930	2.089	2.232	2.367	2.536	2.692	2.896	3.080	3.254	3.473
30		1.924	2.080	2.220	2.351	2.515	2.684	2.884	3.064	3.233	3.447
31		1.919	2.071	2.208	2.336	2.496	2.677	2.872	3.048	3.213	3.421
32		1.914	2.063	2.197	2.322	2.478	2.671	2.862	3.034	3.195	3.398
33		1.909	2.055	2.186	2.308	2.461	2.664	2.852	3.020	3.178	3.375
34		1.904	2.048	2.176	2.296	2.445	2.658	2.842	3.007	3.161	3.354
35		1.900	2.041	2.167	2.284	2.430	2.652	2.833	2.995	3.145	3.334
36		1.895	2.034	2.158	2.272	2.415	2.647	2.824	2.983	3.131	3.315
37		1.891	2.028	2.149	2.262	2.402	2.642	2.816	2.972	3.116	3.297
38		1.888	2.022	2.141	2.251	2.389	2.637	2.808	2.961	3.103	3.280
39		1.884	2.016	2.133	2.241	2.376	2.632	2.800	2.951	3.090	3.264
40		1.880	2.010	2.125	2.232	2.364	2.627	2.793	2.941	3.078	3.249
41		1.877	2.005	2.118	2.223	2.353	2.623	2.786	2.932	3.066	3.234
42		1.874	2.000	2.111	2.214	2.342	2.619	2.780	2.923	3.055	3.220
43		1.871	1.995	2.105	2.206	2.331	2.615	2.773	2.914	3.044	3.206
44		1.868	1.990	2.098	2.198	2.321	2.611	2.767	2.906	3.034	3.193
45		1.865	1.986	2.092	2.190	2.312	2.607	2.761	2.898	3.024	3.180
46		1.862	1.981	2.086	2.183	2.303	2.604	2.756	2.890	3.014	3.168
47		1.859	1.977	2.081	2.176	2.294	2.600	2.750	2.883	3.005	3.157
48		1.857	1.973	2.075	2.169	2.285	2.597	2.745	2.876	2.996	3.146
49		1.854	1.969	2.070	2.163	2.277	2.594	2.740	2.869	2.988	3.135
50		1.852	1.965	2.065	2.156	2.269	2.590	2.735	2.862	2.980	3.125
55		1.841	1.948	2.042	2.128	2.233	2.576	2.713	2.833	2.943	3.078
60		1.832	1.933	2.022	2.103	2.202	2.564	2.694	2.807	2.911	3.038
65		1.823	1.920	2.005	2.082	2.176	2.554	2.677	2.785	2.883	3.004
70		1.816	1.909	1.990	2.063	2.153	2.544	2.662	2.765	2.859	2.974
75		1.810	1.899	1.976	2.047	2.132	2.536	2.649	2.748	2.838	2.947
80		1.804	1.890	1.964	2.032	2.114	2.528	2.638	2.733	2.819	2.924
85		1.799	1.882	1.954	2.019	2.097	2.522	2.627	2.719	2.802	2.902
90		1.794	1.874	1.944	2.006	2.082	2.516	2.618	2.706	2.786	2.883
95		1.790	1.867	1.935	1.995	2.069	2.510	2.609	2.695	2.772	2.866
100		1.786	1.861	1.927	1.985	2.056	2.505	2.601	2.684	2.759	2.850

Appendix G

Table G-3a. Sample Size Required to Demonstrate With At Least $100(1 - \alpha)\%$ Confidence That At Least $100p\%$ of a Lot or Batch of Waste Complies With the Applicable Standard (No Samples Exceeding the Standard)

<i>p</i>	$1 - \alpha$										
	0.50	0.55	0.60	0.65	0.70	0.75	0.80	0.85	0.90	0.95	0.99
0.50	1	2	2	2	2	2	3	3	4	5	7
0.55	2	2	2	2	3	3	3	4	4	6	8
0.60	2	2	2	3	3	3	4	4	5	6	10
0.65	2	2	3	3	3	4	4	5	6	7	11
0.70	2	3	3	3	4	4	5	6	7	9	13
0.75	3	3	4	4	5	5	6	7	9	11	17
0.80	4	4	5	5	6	7	8	9	11	14	21
0.85	5	5	6	7	8	9	10	12	15	19	29
0.90	7	8	9	10	12	14	16	19	22	29	44
0.95	14	16	18	21	24	28	32	37	45	59	90
0.99	69	80	92	105	120	138	161	189	230	299	459

Table G-3b. Sample Size Required to Demonstrate With At Least $100(1 - \alpha)\%$ Confidence That At Least $100p\%$ of a Lot or Batch of Waste Complies With the Applicable Standard (One Sample Exceeding the Standard)

<i>p</i>	$1 - \alpha$										
	0.50	0.55	0.60	0.65	0.70	0.75	0.80	0.85	0.90	0.95	0.99
0.50	3	4	4	4	5	5	5	6	7	8	11
0.55	4	4	4	5	5	6	6	7	8	9	12
0.60	4	5	5	5	6	6	7	8	9	10	14
0.65	5	5	6	6	7	7	8	9	10	12	16
0.70	6	6	7	7	8	9	9	10	12	14	20
0.75	7	7	8	9	9	10	11	13	15	18	24
0.80	9	9	10	11	12	13	14	16	18	22	31
0.85	11	12	13	15	16	18	19	22	25	30	42
0.90	17	19	20	22	24	27	29	33	38	46	64
0.95	34	37	40	44	49	53	59	67	77	93	130
0.99	168	184	202	222	244	269	299	337	388	473	662

Table G-4. Coefficients $[a_{n-i+1}]$ for the Shapiro-Wilk Test for Normality

i \ n	2	3	4	5	6	7	8	9	10	
1	.7071	.7071	.6872	.6646	.6431	.6233	.6052	.5888	.5739	
2		.0000	.1677	.2413	.2806	.3031	.3164	.3244	.3291	
3			.0000	.0875	.1401	.1743	.1976	.2141		
4				.0000	.0561	.0947	.1224			
5						.0000	.0399			
i \ n	11	12	13	14	15	16	17	18	19	20
1	.5601	.5475	.5359	.5251	.5150	.5056	.4968	.4886	.4808	.4734
2	.3315	.3325	.3325	.3318	.3306	.3290	.3273	.3253	.3232	.3211
3	.2260	.2347	.2412	.2460	.2495	.2521	.2540	.2553	.2561	.2565
4	.1429	.1586	.1707	.1802	.1878	.1939	.1988	.2027	.2059	.2085
5	.0695	.0922	.1099	.1240	.1353	.1447	.1524	.1587	.1641	.1686
6	.0000	.0303	.0539	.0727	.0880	.1005	.1109	.1197	.1271	.1334
7			.0000	.0240	.0433	.0593	.0725	.0837	.0932	.1013
8				.0000	.0196	.0359	.0496	.0612	.0711	
9						.0000	.0163	.0303	.0422	
10								.0000	.0140	
i \ n	21	22	23	24	25	26	27	28	29	30
1	.4643	.4590	.4542	.4493	.4450	.4407	.4366	.4328	.4291	.4254
2	.3185	.3156	.3126	.3098	.3069	.3043	.3018	.2992	.2968	.2944
3	.2578	.2571	.2563	.2554	.2543	.2533	.2522	.2510	.2499	.2487
4	.2119	.2131	.2139	.2145	.2148	.2151	.2152	.2151	.2150	.2148
5	.1736	.1764	.1787	.1807	.1822	.1836	.1848	.1857	.1864	.1870
6	.1399	.1443	.1480	.1512	.1539	.1563	.1584	.1601	.1616	.1630
7	.1092	.1150	.1201	.1245	.1283	.1316	.1346	.1372	.1395	.1415
8	.0804	.0878	.0941	.0997	.1046	.1089	.1128	.1162	.1192	.1219
9	.0530	.0618	.0696	.0764	.0823	.0876	.0923	.0965	.1002	.1036
10	.0263	.0368	.0459	.0539	.0610	.0672	.0728	.0778	.0822	.0862
11	.0000	.0122	.0228	.0321	.0403	.0476	.0540	.0598	.0650	.0697
12			.0000	.0107	.0200	.0284	.0358	.0424	.0483	.0537
13					.0000	.0094	.0178	.0253	.0320	.0381
14							.0000	.0084	.0159	.0227
15									.0000	.0076

Source: After Shapiro and Wilk (1965)

Appendix G

Table G-4. Coefficients $[a_{n-i+1}]$ for the Shapiro-Wilk Test for Normality (Continued)

i \ n	31	32	33	34	35	36	37	38	39	40
1	.4220	.4188	.4156	.4127	.4096	.4068	.4040	.4015	.3989	.3964
2	.2921	.2898	.2876	.2854	.2834	.2813	.2794	.2774	.2755	.2737
3	.2475	.2463	.2451	.2439	.2427	.2415	.2403	.2391	.2380	.2368
4	.2145	.2141	.2137	.2132	.2127	.2121	.2116	.2110	.2104	.2098
5	.1874	.1878	.1880	.1882	.1883	.1883	.1883	.1881	.1880	.1878
6	.1641	.1651	.1660	.1667	.1673	.1678	.1683	.1686	.1689	.1691
7	.1433	.1449	.1463	.1475	.1487	.1496	.1505	.1513	.1520	.1526
8	.1243	.1265	.1284	.1301	.1317	.1331	.1344	.1356	.1366	.1376
9	.1066	.1093	.1118	.1140	.1160	.1179	.1196	.1211	.1225	.1237
10	.0899	.0931	.0961	.0988	.1013	.1036	.1056	.1075	.1092	.1108
11	.0739	.0777	.0812	.0844	.0873	.0900	.0924	.0947	.0967	.0986
12	.0585	.0629	.0669	.0706	.0739	.0770	.0798	.0824	.0848	.0870
13	.0435	.0485	.0530	.0572	.0610	.0645	.0677	.0706	.0733	.0759
14	.0289	.0344	.0395	.0441	.0484	.0523	.0559	.0592	.0622	.0651
15	.0144	.0206	.0262	.0314	.0361	.0404	.0444	.0481	.0515	.0546
16	.0000	.0068	.0131	.0187	.0239	.0287	.0331	.0372	.0409	.0444
17			.0000	.0062	.0119	.0172	.0220	.0264	.0305	.0343
18					.0000	.0057	.0110	.0158	.0203	.0244
19							.0000	.0053	.0101	.0146
20									.0000	.0049
i \ n	41	42	43	44	45	46	47	48	49	50
1	.3940	.3917	.3894	.3872	.3850	.3830	.3808	.3789	.3770	.3751
2	.2719	.2701	.2628	.2667	.2651	.2635	.2620	.2604	.2589	.2574
3	.2357	.2345	.2334	.2323	.2313	.2302	.2291	.2281	.2271	.2260
4	.2091	.2085	.2078	.2072	.2065	.2058	.2052	.2045	.2038	.2032
5	.1876	.1874	.1871	.1868	.1865	.1862	.1859	.1855	.1851	.1847
6	.1693	.1694	.1695	.1695	.1695	.1695	.1695	.1693	.1692	.1691
7	.1531	.1535	.1539	.1542	.1545	.1548	.1550	.1551	.1553	.1554
8	.1384	.1392	.1398	.1405	.1410	.1415	.1420	.1423	.1427	.1430
9	.1249	.1259	.1269	.1278	.1286	.1293	.1300	.1306	.1312	.1317
10	.1123	.1136	.1149	.1160	.1170	.1180	.1189	.1197	.1205	.1212
11	.1004	.1020	.1035	.1049	.1062	.1073	.1085	.1095	.1105	.1113
12	.0891	.0909	.0927	.0943	.0959	.0972	.0986	.0998	.1010	.1020
13	.0782	.0804	.0824	.0842	.0860	.0876	.0892	.0906	.0919	.0932
14	.0677	.0701	.0724	.0745	.0775	.0785	.0801	.0817	.0832	.0846
15	.0575	.0602	.0628	.0651	.0673	.0694	.0713	.0731	.0748	.0764
16	.0476	.0506	.0534	.0560	.0584	.0607	.0628	.0648	.0667	.0685
17	.0379	.0411	.0442	.0471	.0497	.0522	.0546	.0568	.0588	.0608
18	.0283	.0318	.0352	.0383	.0412	.0439	.0465	.0489	.0511	.0532
19	.0188	.0227	.0263	.0296	.0328	.0357	.0385	.0411	.0436	.0459
20	.0094	.0136	.0175	.0211	.0245	.0277	.0307	.0335	.0361	.0386
21	.0000	.0045	.0087	.0126	.0163	.0197	.0229	.0259	.0288	.0314
22			.0000	.0042	.0081	.0118	.0153	.0185	.0215	.0244
23					.0000	.0039	.0076	.0111	.0143	.0174
24							.0000	.0037	.0071	.0104
25									.0000	.0035

Table G-5. α -Level Critical Points for the Shapiro-Wilk Test

n	α	
	0.01	0.05
3	0.753	0.767
4	0.687	0.748
5	0.686	0.762
6	0.713	0.788
7	0.730	0.803
8	0.749	0.818
9	0.764	0.829
10	0.781	0.842
11	0.792	0.850
12	0.805	0.859
13	0.814	0.866
14	0.825	0.874
15	0.835	0.881
16	0.844	0.887
17	0.851	0.892
18	0.858	0.897
19	0.863	0.901
20	0.868	0.905
21	0.873	0.908
22	0.878	0.911
23	0.881	0.914
24	0.884	0.916
25	0.888	0.918
26	0.891	0.920
27	0.894	0.923
28	0.896	0.924
29	0.898	0.926
30	0.900	0.927
31	0.902	0.929
32	0.904	0.930
33	0.906	0.931
34	0.908	0.933
35	0.910	0.934
36	0.912	0.935
37	0.914	0.936
38	0.916	0.938
39	0.917	0.939
40	0.919	0.940
41	0.920	0.941
42	0.922	0.942
43	0.923	0.943
44	0.924	0.944
45	0.926	0.945
46	0.927	0.945
47	0.928	0.946
48	0.929	0.947
49	0.929	0.947
50	0.930	0.947

Source: After Shapiro and Wilk (1965)

Appendix G

Table G-6. Values of $H_{1-\alpha} = H_{0.90}$ for Calculating a One-Sided 90-Percent UCL on a Lognormal Mean

S_y	n									
	3	5	7	10	12	15	21	31	51	101
0.10	1.686	1.438	1.381	1.349	1.338	1.328	1.317	1.308	1.301	1.295
0.20	1.885	1.522	1.442	1.396	1.380	1.365	1.348	1.335	1.324	1.314
0.30	2.156	1.627	1.517	1.453	1.432	1.411	1.388	1.370	1.354	1.339
0.40	2.521	1.755	1.607	1.523	1.494	1.467	1.437	1.412	1.390	1.371
0.50	2.990	1.907	1.712	1.604	1.567	1.532	1.494	1.462	1.434	1.409
0.60	3.542	2.084	1.834	1.696	1.650	1.606	1.558	1.519	1.485	1.454
0.70	4.136	2.284	1.970	1.800	1.743	1.690	1.631	1.583	1.541	1.504
0.80	4.742	2.503	2.119	1.914	1.845	1.781	1.710	1.654	1.604	1.560
0.90	5.349	2.736	2.280	2.036	1.955	1.880	1.797	1.731	1.672	1.621
1.00	5.955	2.980	2.450	2.167	2.073	1.985	1.889	1.812	1.745	1.686
1.25	7.466	3.617	2.904	2.518	2.391	2.271	2.141	2.036	1.946	1.866
1.50	8.973	4.276	3.383	2.896	2.733	2.581	2.415	2.282	2.166	2.066
1.75	10.48	4.944	3.877	3.289	3.092	2.907	2.705	2.543	2.402	2.279
2.00	11.98	5.619	4.380	3.693	3.461	3.244	3.005	2.814	2.648	2.503
2.50	14.99	6.979	5.401	4.518	4.220	3.938	3.629	3.380	3.163	2.974
3.00	18.00	8.346	6.434	5.359	4.994	4.650	4.270	3.964	3.697	3.463
3.50	21.00	9.717	7.473	6.208	5.778	5.370	4.921	4.559	4.242	3.965
4.00	24.00	11.09	8.516	7.062	6.566	6.097	5.580	5.161	4.796	4.474
4.50	27.01	12.47	9.562	7.919	7.360	6.829	6.243	5.763	5.354	4.989
5.00	30.01	13.84	10.61	8.779	8.155	7.563	6.909	6.379	5.916	5.508
6.00	36.02	16.60	12.71	10.50	9.751	9.037	8.248	7.607	7.048	6.555
7.00	42.02	19.35	14.81	12.23	11.35	10.52	9.592	8.842	8.186	7.607
8.00	48.03	22.11	16.91	13.96	12.96	12.00	10.94	10.08	9.329	8.665
9.00	54.03	24.87	19.02	15.70	14.56	13.48	12.29	11.32	10.48	9.725
10.0	60.04	27.63	21.12	17.43	16.17	14.97	13.64	12.56	11.62	10.79

Source: Land (1975)

Table G-7. Values of the Parameter $\hat{\lambda}$ for Cohen's Adjustment for Nondetected Values

γ	h											
	.01	.02	.03	.04	.05	.06	.07	.08	.09	.10	.15	.20
.00	.010100	.020400	.030902	.041583	.052507	.063625	.074953	.08649	.09824	.11020	.17342	.24268
.05	.010551	.021294	.032225	.043350	.054670	.066159	.077909	.08983	.10197	.11431	.17925	.25033
.10	.010950	.022082	.033398	.044902	.056596	.068483	.080563	.09285	.10534	.11804	.18479	.25741
.15	.011310	.022798	.034466	.046318	.058356	.070586	.083009	.09563	.10845	.12148	.18985	.26405
.20	.011642	.023459	.035453	.047829	.059990	.072539	.085280	.09822	.11135	.12469	.19460	.27031
.25	.011952	.024076	.036377	.048858	.061522	.074372	.087413	.10065	.11408	.12772	.19910	.27626
.30	.012243	.024658	.037249	.050018	.062969	.076106	.089433	.10295	.11667	.13059	.20338	.28193
.35	.012520	.025211	.038077	.051120	.064345	.077736	.091355	.10515	.11914	.13333	.20747	.28737
.40	.012784	.025738	.038866	.052173	.065660	.079332	.093193	.10725	.12150	.13595	.21129	.29250
.45	.013036	.026243	.039624	.053182	.066921	.080845	.094958	.10926	.12377	.13847	.21517	.29765
.50	.013279	.026728	.040352	.054153	.068135	.082301	.096657	.11121	.12595	.14090	.21882	.30253
.55	.013513	.027196	.041054	.055089	.069306	.083708	.098298	.11208	.12806	.14325	.22225	.30725
.60	.013739	.027849	.041733	.055995	.070439	.085068	.099887	.11490	.13011	.14552	.22578	.31184
.65	.013958	.028087	.042391	.056874	.071538	.086388	.10143	.11666	.13209	.14773	.22910	.31630
.70	.014171	.028513	.043030	.057726	.072505	.087670	.10292	.11837	.13402	.14987	.23234	.32065
.75	.014378	.029927	.043652	.058556	.073643	.088917	.10438	.12004	.13590	.15196	.23550	.32489
.80	.014579	.029330	.044258	.059364	.074655	.090133	.10580	.12167	.13775	.15400	.23858	.32903
.85	.014773	.029723	.044848	.060153	.075642	.091319	.10719	.12225	.13952	.15599	.24158	.33307
.90	.014967	.030107	.045425	.060923	.075606	.092477	.10854	.12480	.14126	.15793	.24452	.33703
.95	.015154	.030483	.045989	.061676	.077549	.093611	.10987	.12632	.14297	.15983	.24740	.34091
1.00	.015338	.030850	.046540	.062413	.078471	.094720	.11116	.12780	.14465	.16170	.25022	.34471

Appendix G

Table G-7. Values of the Parameter $\hat{\lambda}$ for Cohen's Adjustment for Nondetected Values (Continued)

γ	h											
	.25	.30	.35	.40	.45	.50	.55	.60	.65	.70	.80	.90
.05	.32793	.4130	.5066	.6101	.7252	.8540	.9994	1.166	1.358	1.585	2.203	3.314
.10	.33662	.4233	.5184	.6234	.7400	.8703	1.017	1.185	1.379	1.608	2.229	3.345
.15	.34480	.4330	.5296	.6361	.7542	.8860	1.035	1.204	1.400	1.630	2.255	3.376
.20	.35255	.4422	.5403	.6483	.7673	.9012	1.051	1.222	1.419	1.651	2.280	3.405
.25	.35993	.4510	.5506	.6600	.7810	.9158	1.067	1.240	1.439	1.672	2.305	3.435
.30	.36700	.4595	.5604	.6713	.7937	.9300	1.083	1.257	1.457	1.693	2.329	3.464
.35	.37379	.4676	.5699	.6821	.8060	.9437	1.098	1.274	1.475	1.713	2.353	3.492
.40	.38033	.4735	.5791	.6927	.8179	.9570	1.113	1.290	1.494	1.732	2.376	3.520
.45	.38665	.4831	.5880	.7029	.8295	.9700	1.127	1.306	1.511	1.751	2.399	3.547
.50	.39276	.4904	.5967	.7129	.8408	.9826	1.141	1.321	1.528	1.770	2.421	3.575
.55	.39679	.4976	.6061	.7225	.8517	.9950	1.155	1.337	1.545	1.788	2.443	3.601
.60	.40447	.5045	.6133	.7320	.8625	1.007	1.169	1.351	1.561	1.806	2.465	3.628
.65	.41008	.5114	.6213	.7412	.8729	1.019	1.182	1.368	1.577	1.824	2.486	3.654
.70	.41555	.5180	.6291	.7502	.8832	1.030	1.195	1.380	1.593	1.841	2.507	3.679
.75	.42090	.5245	.6367	.7590	.8932	1.042	1.207	1.394	1.608	1.851	2.528	3.705
.80	.42612	.5308	.6441	.7676	.9031	1.053	1.220	1.408	1.624	1.875	2.548	3.730
.85	.43122	.5370	.6515	.7781	.9127	1.064	1.232	1.422	1.639	1.892	2.568	3.754
.90	.43622	.5430	.6586	.7844	.9222	1.074	1.244	1.435	1.653	1.908	2.588	3.779
.95	.44112	.5490	.6656	.7925	.9314	1.085	1.255	1.448	1.668	1.924	2.607	3.803
1.00	.44592	.5548	.6724	.8005	.9406	1.095	1.287	1.461	1.882	1.940	2.626	3.827

APPENDIX H

STATISTICAL SOFTWARE

Since publication of Chapter Nine (“Sampling Plan”) of SW-846 in 1986, great advances have been made in desktop computer hardware and software. In implementing the procedures recommended in this chapter, you should take advantage of the powerful statistical software now available for low cost or no cost. A number of useful “freeware” packages are available from EPA and other organizations, and many are downloadable from the Internet. Commercially available software also may be used.

This appendix provides a list of software that you might find useful. *EPA Guidance for Quality Assurance Project Plans, EPA QA/G-5* (USEPA 1998a) also provides an extensive list of software that can assist you in developing and preparing a quality assurance project plan.

Sampling Design Software	
Title	Description
<i>Decision Error Feasibility Trials (DEFT)*</i>	<p>This software package allows quick generation of cost information about several simple sampling designs based on DQO constraints, which can be evaluated to determine their appropriateness and feasibility before the sampling and analysis design is finalized. This software supports the <i>Guidance for the Data Quality Objectives Process EPA QA/G-4</i> (USEPA 2000b), which provides general guidance to organizations developing data quality criteria and performance specifications for decision making. The <i>Data Quality Objectives Decision Error Feasibility Trials Software (DEFT) - User's Guide</i> (EPA/240/B-01/007) contains detailed instructions on how to use DEFT software and provides background information on the sampling designs that the software uses.</p> <p>Download from EPA's World Wide Web site at: http://www.epa.gov/quality/qa_docs.html.</p>
<i>GeoEAS*</i>	<p><i>Geostatistical Environmental Assessment Software (GeoEAS)</i> (USEPA 1991b) is a collection of interactive software tools for performing two-dimensional geostatistical analyses of spatially distributed data. Programs are provided for data file management, data transformations, univariate statistics, variogram analysis, cross-validation, kriging, contour mapping, post plots, and line/scatter plots. Users may alter parameters and re-calculate results or reproduce graphs, providing a “what-if” analysis capability.</p> <p>GeoEAS Version 1.2.1 (April 1989) software and documentation is available from EPA's Web site at http://www.epa.gov/ada/csmos/models/geoeas.html</p>

* Also available on EPA's CD-ROM *Site Characterization Library Volume 1* (Release 2) (USEPA 1998c)

Appendix H

Sampling Design Software (Continued)	
Title	Description
<i>ELIPGRID-PC</i>	<p><i>ELIPGRID-PC</i> is a program for the design and analysis of sampling grids for locating elliptical targets (e.g., contamination "hot spots"). It computes the probability of success in locating targets based on the assumed size, shape, and orientation of the targets, as well as the specified grid spacing. It also can be used to compute a grid spacing from a specified success probability, compute cost information associated with specified sampling grids, determine the size of the smallest "hot spot" detected given a particular grid, and create graphs of the results.</p> <p>Information, software, and user's guide are available on the World Wide Web at: http://dgo.pnl.gov/software/elipgrid.htm The site is operated for the U.S. Department of Energy Office of Environmental Management by the Pacific Northwest National Laboratory.</p>
<i>DQO-PRO</i>	<p>This software comprises a series of programs with a user interface such as a common calculator and it is accessed using Microsoft Windows. <i>DQO-PRO</i> provides answers for three objectives:</p> <ol style="list-style-type: none"> 1. Determining the rate at which an event occurs 2. Determining an estimate of an average within a tolerable error 3. Determining the sampling grid necessary to detect "hot spots." <p><i>DQO-PRO</i> facilitates understanding the significance of DQOs by showing the relationships between numbers of samples and DQO parameters, such as (1) confidence levels versus numbers of false positive or negative conclusions; (2) tolerable error versus analyte concentration, standard deviation, etc., and (3) confidence levels versus sampling area grid size. The user has only to type in his or her requirements and the calculator instantly provides the answers.</p> <p>Contact: Information and software are available on the Internet at the American Chemical Society, Division of Environmental Chemistry Web site at http://www.acs-envchem.duq.edu/dqopro.htm</p>
Visual Sample Plan (VSP)	<p>VSP provides statistical solutions for optimizing the sampling design. The software can answer two important questions in sample planning: (1) How many samples are needed? VSP can quickly calculate the number of samples needed for various scenarios at different costs. (2) Where should the samples be taken? Sample placement based on personal judgment is prone to bias. VSP provides random or grided sampling locations overlaid on the site map.</p> <p>Information and software available at http://dgo.pnl.gov/VSP/Index.htm VSP was developed in part by Department of Energy's (DOE's) National Analytical Management Program (NAMP) and through a joint effort between Pacific Northwest National Laboratory (PNNL) and Advanced Infrastructure Management Technologies (AIMTech).</p>

Data Quality Assessment Software	
Title	Description
<i>DataQUEST</i>	<p>This software tool is designed to provide a quick-and-easy way for managers and analysts to perform baseline Data Quality Assessment. The goal of the system is to allow those not familiar with standard statistical packages to review data and verify assumptions that are important in implementing the DQA Process. This software supports the <i>Guidance for Data Quality Assessment, EPA QA/G-9</i> (USEPA 2000d) which demonstrates the use of the DQA Process in evaluating environmental data sets.</p> <p>Download from EPA's World Wide Web site at http://www.epa.gov/quality/qa_docs.html</p>
<i>ASSESS 1.01a*</i>	<p>This software tool was designed to calculate variances for quality assessment samples in a measurement process. The software performs the following functions: (1) transforming the entire data set, (2) producing scatter plots of the data, (3) displaying error bar graphs that demonstrate the variance, and (4) generating reports of the results and header information.</p> <p>Available on EPA's CD-ROM <i>Site Characterization Library Volume 1</i> (Release 2) (USEPA 1998c)</p>
<i>MTCASat</i>	<p>This software package is published by the Washington Department of Ecology and can be used to calculate sample sizes (for both normal and lognormal distributions), basic statistical quantities, and confidence intervals. Requires MS Excel 97.</p> <p>The USEPA Office of Solid Waste has not evaluated this software for use in connection with RCRA programs, however, users of this guidance may wish to review the software for possible application to some of the concepts described in this document.</p> <p>Available from Washington Department of Ecology's "Site Cleanup, Sediments, and Underground Storage Tanks" World Wide Web site at http://www.ecy.wa.gov/programs/tcp/tools/toolmain.html</p>

* Also available on EPA's CD-ROM *Site Characterization Library Volume 1* (Release 2) (USEPA 1998c)

This page intentionally left blank

APPENDIX I

EXAMPLES OF PLANNING, IMPLEMENTATION, AND ASSESSMENT FOR RCRA WASTE SAMPLING

This appendix presents the following two hypothetical examples of planning, implementation, and assessment for RCRA waste sampling:

Example 1: Sampling soil in a RCRA Solid Waste Management Unit (SWMU) to confirm attainment of the cleanup standard (using the mean to measure compliance with a standard)

Example 2: Sampling of a process waste to make a hazardous waste determination (using a maximum or upper percentile to measure compliance with a standard).

Example 1: Sampling Soil at a RCRA SWMU to Confirm Attainment of a Cleanup Standard

Introduction

In this example, the owner of a permitted TSDf completed removal of contaminated soil at a SWMU as required under the facility's RCRA permit under EPA's RCRA Corrective Action Program. The permit required the facility owner to conduct sampling and analysis to determine if the remaining soil attains the facility-specific risk-based standard specified in the permit. This hypothetical example describes how the planning, implementation, and assessment activities were conducted.

Planning Phase

The planning phase included implementation of EPA's systematic planning process known as the Data Quality Objectives (DQO) Process and preparation of a quality assurance project plan (QAPP). A DQO planning team was assembled, and the DQO Process was implemented following EPA's guidance in *Guidance for the Data Quality Objectives Process for Hazardous Waste Site Operations EPA QA/G-4HW* (USEPA 2000a), *Guidance for the Data Quality Objectives Process EPA QA/G-4* (USEPA 2000b), and Chapter Nine of SW-846.

The outputs of the seven steps of the DQO Process are outlined below.

DQO Step 1: Stating the Problem

- The DQO planning team included the facility owner, a technical project manager, a chemist, environmental technician (sampler), and a facility engineer familiar with statistical methods. As part of the DQO Process, the team consulted with their state regulator to determine if the State has any additional regulations or guidance that applies. A state guidance document provided recommendations for the parameter of interest and the acceptable Type I decision error rate.

- A concise description of the problem was developed as follows: The facility conducted a soil removal action at the SWMU. Soil with concentrations greater than the risk-based cleanup standard of 10 mg/kg of pentachlorophenol (PCP) was excavated for off-site disposal. Removal was guided by the results of grab samples analyzed for PCP using a semi-quantitative field analytical method.
- The conceptual site model (CSM) assumed that the PCP migrated downward into the soil, and that if a soil layer were found to be “clean,” then the underlying soil layer also would be assumed “clean.”
- The technical staff were given six weeks to complete the study and submit a draft report to the regulatory agency.

DQO Step 2: Identifying Possible Decisions

- Decision statement: The study objective was to determine if the soil remaining in the SWMU after removal of the contaminated soil attained the cleanup standard. If the standard is attained, then the area will be backfilled with clean fill and reserved for future industrial development. If the standard is not attained, then the next layer of soil within the SWMU will be removed.

DQO Step 3: Identifying Inputs to the Decision

- The sample analysis results for total PCP (in mg/kg) in soil were used to decide whether or not the soil attained the cleanup. PCP was designated as the only constituent of concern, and its distribution within the SWMU was assumed to be random. The risk-based cleanup level for PCP in soil was set at 10 mg/kg.
- The decision was based on the concentrations in the top six-inch layer of soil across the entire SWMU. The study was designed to determine whether the entire unit attains the standards, or does not.
- The chemist identified two candidate analytical methods for measuring PCP concentrations in soil: (1) SW-846 Method 4010A “Screening For Pentachlorophenol By Immunoassay” (\$20/analysis), and (2) SW-846 Method 8270 (and prep method 3550) (\$110/analysis). The project chemist confirmed that both methods were capable of achieving a quantitation limit well below the action level of 10 mg/kg. During Step 7 of the DQO Process, the chemist revisited this step to select a final method and prepare method performance criteria as part of the overall specification of decision performance criteria.
- The planning team identified the need to specify the size, shape, and orientation of each sample to satisfy the acceptable sampling error (specified in DQO Process Step 7) and to enable selection of the appropriate sampling device (during development of the QAPP). Because the soil exists in a relatively flat stationary three-dimensional unit, it was considered a series of overlapping two-dimensional surfaces for the purposes of sampling. The correct orientation, size,

and shape of each sample was a vertical core capturing the full six-inch thickness of the soil unit. The minimum mass of each primary field sample was determined during DQO Process Step 7 using the particle size-weight relationship required to control fundamental error at an acceptable level.

DQO Step 4: Defining Boundaries

- The dimensions of the SWMU were approximately 125 feet by 80 feet (10,000 square feet). The SWMU was relatively flat. The depth of interest was limited to the top six inches of soil in the unit after removal of the contaminated soil. The spatial boundary of the SWMU was defined by the obvious excavation and by wooden stakes at the corners of the excavation.
- The soil within the study boundary was loamy sand with a maximum particle size of about 1.5 mm (0.15 cm).
- The project team planned to collect samples within a reasonable time frame, and degradation or transformation of the PCP over the investigation period was not a concern.

DQO Step 5: Developing Decision Rules

- The population parameter of interest was the *mean*. The mean was selected as the parameter of interest because the risk-based cleanup standard (Action Level) was derived based upon long-term average health effects predicted from exposures to the contaminated soil.
- The risk-based action level was 10 mg/kg total pentachlorophenol (PCP) in soil.
- The decision rule was then established as follows: "If the mean concentration for PCP in the soil is less than 10 mg/kg, then the cleanup standard is attained. Otherwise, the SWMU will be considered contaminated and additional remedial action will be required."

DQO Step 6: Specifying Limits on Decision Errors

- The major sources of variability (measured as the relative variance) were identified as within-sample unit variability (s_w^2) (including analytical imprecision and Gy's fundamental error) and between-sample unit variability (s_b^2) (or population variability). The total study variance (s_T^2), expressed as the relative variance, was estimated using the following relationship:

$$\begin{aligned} s_T^2 &= s_b^2 + s_w^2 \\ &= s_b^2 + s_s^2 + s_a^2 \end{aligned}$$

where s_b^2 = between-unit variance (population variance), s_s^2 = sample collection imprecision (estimated by Gy's fundamental error, s_{FE}^2), and s_a^2 = analytical imprecision (determined from the measurement of laboratory control samples with concentrations near the Action Level).

- Sample analysis results for eight samples of soil excavated from the previous lift gave a standard deviation and mean of $s = 7.1$ and $\bar{x} = 10.9$ respectively. The total study relative standard deviation (s_T) was then estimated as 0.65.
- The relative standard deviation (RSD) of the sampling error (s_s) was estimated as 0.10 (as estimated by Gy's fundamental error), based a maximum observed particle size of approximately 1.5 mm (0.15 cm) and a sample mass of 10 grams.
- The RSD for the analytical imprecision (s_a) associated with the field screening method (SW-846 Method 4010A - "Screening For Pentachlorophenol By Immunoassay") was estimated from replicate measurements as 0.40.
- The between-unit (population) relative standard deviation (s_b) was then estimated as:

$$\begin{aligned} s_b &= \sqrt{s_T^2 - (s_s^2 + s_a^2)} \\ &= \sqrt{(0.65)^2 - (.10^2 + .40^2)} = 0.50 \end{aligned}$$

- Two potential decision errors could be made based on interpreting sampling and analytical data:

Decision Error A: Concluding that the mean PCP concentration within the SWMU was less than 10 mg/kg when it was truly greater than 10 mg/kg, or

Decision Error B: Concluding that the mean PCP concentration within the SWMU was greater than 10 mg/kg when it was truly less than 10 mg/kg.

The consequences of Decision Error A, incorrectly deciding the SWMU was "clean" (mean PCP concentration less than 10 mg/kg), would leave contaminated soil undetected and would likely increase health risks for onsite workers and pose potential future legal problems for the owner.

The consequences of Decision Error B, incorrectly deciding the SWMU was "not clean" (mean PCP concentration greater than or equal to 10 mg/kg), would cause the needless expenditure of resources (e.g., funding, time, backhoe and operator, soil disposal, sampling crew labor, and analytical capacity) for unnecessary further remedial action.

Error A, incorrectly deciding that the mean PCP concentration is less than the action level of 10 mg/kg, posed more severe consequences for human health plus liability and compliance concerns. Consequently, the baseline condition chosen for the SWMU was that the mean PCP concentration within the SWMU is truly greater than or equal to the action level of 10 mg/kg.

Table I-1. Null Hypothesis and Possible Decision Errors for Example 1

“Null Hypothesis” (baseline condition)	Possible Decision Errors	
	Type I Error (α), False Rejection	Type II Error (β), False Acceptance
The true mean concentration of PCP in the SWMU is greater than or equal to the risk-based cleanup standard (i.e., the SWMU is contaminated).	Concluding the site is “clean” when, in fact, it is contaminated.	Concluding the site is still contaminated when, in fact, it is “clean.”

- Next, it was necessary to specify the boundaries of the gray regions. The gray region defines a range that is less than the action limit, but too close to the Action Level to be considered “clean,” given uncertainty in the data. When the null hypothesis (baseline condition) assumes that the site is contaminated (as in this example), the upper limit of the gray region is bounded by the Action Level; the lower limit is determined by the decision maker. The project team sets the lower bound of the gray region at 7.5 mg/kg, with the understanding that this bound could be modified after review of the outputs of Step 7 of the DQO Process.
- The planning team set the acceptable probability of making a Type I (false rejection) error at 5 percent ($\alpha = 0.05$) based on guidance provided by the State regulatory agency. In other words, the team was willing to accept a 5 percent chance of concluding the SWMU was clean, if in fact it was not. While a Type II (false acceptance) error could prove to be costly to the company, environmental protection and permit compliance are judged to be most important. The planning team decides to set the Type II error rate at only 20 percent.
- The information collected in Step 6 of the DQO Process is summarized below.

Table I-2. Initial Outputs of Step 6 of the DQO Process

Needed Parameter	Output
Action Level (AL)	10 mg/kg
Gray Region	7.5 - 10 mg/kg (width of gray region, $\Delta = 2.5$)
Relative Width of Gray Region	$(10 - 7.5)/7.5 = 0.33$
Null Hypothesis (H_0)	Mean (PCP) ≥ 10 mg/kg
False Rejection Decision Error Limit (probability of a Type I error)	$\alpha = 0.05$
False Acceptance Decision Error Limit (probability of a Type II error)	$\beta = 0.20$

DQO Step 7: Optimizing the Data Collection Design

1. **Review outputs from the first six steps of the DQO Process.** The project team reviewed the outputs of the first six steps of the DQO Process. They expected the PCP concentration to be near the cleanup standard (Action Level); thus, it was decided that a probabilistic sampling design would be used so that the results could be stated with a known probability of making a decision error.
2. **Consider various data collection designs.** The objective of this step was to find cost-effective design alternatives that balance the number of samples and the measurement performance, given the feasible choices for sampling designs and measurement methods. Based on characterization data from the excavated soil, the planning team assumed that the between-sample unit variability or population variability would remain relatively stable at approximately $s_b = 0.50$, independent of the sampling and analytical methods used. The planning team investigated various combinations of sampling and analytical methods (with varying associated levels of precision and cost) as a means find the optimal study design.

The planning team considered three probabilistic sampling designs: simple random, stratified random, and systematic (grid-based) designs. A composite sampling strategy also was considered. All designs allowed for an estimate of the mean to be made. Because the existence of strata was not expected (although could be discovered during the investigation), the stratified design was eliminated from consideration. A simple random design is the simplest of the probabilistic sampling methods, but it may not provide very even coverage of the SWMU; thus, if spatial variability becomes a concern, then it may go undetected with a simple random design. The systematic design provides more even coverage of the SWMU and typically is easy to implement.

The practical considerations were considered for each alternative design, including site access and conditions, equipment selection/use, experience

needed, special analytical needs, health and safety requirements, and scheduling. There were no significant practical constraints that would limit the use of either the systematic or the simple random sampling designs; however, the systematic design was preferred because it provides sampling locations that are easier to survey and locate in the field, and it provides better spatial coverage. Ultimately, two sampling designs were evaluated: a systematic sampling design and a systematic sampling design that incorporates composite sampling.

The acceptable mass of each primary field sample was determined using the particle size-weight relationship required to control fundamental error. The soil in the SWMU is a granular solid, and the 95th percentile particle size (d) was estimated at 1.5 mm (0.15 cm). To maintain the relative standard deviation of the fundamental error at 0.10, a sample mass of at least 8.2 grams was required (using Equation D.4 in Appendix D). To maintain the relative standard deviation of the fundamental error at 0.05, a sample mass of at least 30 grams would be required. There were no practical constraints on obtaining samples of these sizes.

Next, it was necessary to estimate unit costs for sampling and analysis. Based on prior experience, the project team estimated the cost of collecting a grab sample at \$40 – plus an additional \$30 per sample for documentation, processing of field screening samples, and \$60 per sample for documentation, processing, and shipment for samples sent for fixed laboratory analysis.

3. **Select the optimal number of samples.** Using the initial outputs of Step 6, the appropriate number of samples was calculated for each sampling design:

For the systematic sampling design (without compositing), the following formula was used (Equation 8 from Section 5.4.1):

$$n = \frac{(z_{1-\alpha} + z_{1-\beta})^2 S_T^2}{\Delta^2} + \frac{z_{1-\alpha}^2}{2}$$

where

- $z_{1-\alpha}$ = the p th quantile of the standard normal distribution (from the last row of Table G-1, Appendix G), where α is the probability of making a Type I error (the significance level of the test) set in DQO Step 6.
- $z_{1-\beta}$ = the p th quantile of the standard normal distribution (from the last row of Table G-1, Appendix G), where β is the probability of making a Type II error set in DQO Step 6.
- S_T = an estimate of the total study relative standard deviation.
- Δ = the width of the gray region from DQO Step 6 (expressed as the relative error in this example).

[EPA's DEFT software could be used to calculate the appropriate number of samples (see *Data Quality Objectives Decision Error Feasibility Trials Software (DEFT) - User's Guide*, USEPA 2001h). Note, however, that the DEFT program asks for the bounds of the gray region specified in absolute units. If the planning team uses the relative standard deviation (or coefficient of variation) in the sample size equation rather than the absolute standard deviation, then the bounds of the gray region also must be input into DEFT as relative values. Thus, the Action Level would be set equal to 1, and the other bound of the gray region would be set equal to $1 - (\text{relative width of gray region})$ or $1 + (\text{relative width of gray region})$ depending what baseline condition is selected.]

Note that if there were more than one constituent of concern, then the appropriate number of samples would need to be calculated for each constituent using preliminary estimates of their standard deviations. The number of samples would then be determined by the highest number of samples obtained for any single constituent of concern.

The sample size for systematic composite sampling also was evaluated. In comparison to non-composite sampling, composite sampling can have the effect of minimizing between-sample variation, thereby reducing somewhat the total number of composite samples that must be submitted for analysis. In addition, composite samples are expected to generate normally distributed data thereby allowing the team to apply normal theory statistical methods. To estimate the sample size, the planning team again required an estimate of the standard deviation. However, since the original estimate of the standard deviation was based on available individual or "grab" sample data rather than composite samples, it was necessary to adjust the variance term in the sample size equation for the appropriate number of composite samples. In the sample size equation, the between-unit (population) component of variance (s_b^2) was replaced with s_b^2/g , where g is the number of individual or "grab" samples used to form each composite. Sample sizes were then calculated assuming $g = 4$.

Table I-3 and Table I-4 summarize the inputs and outputs of Step 7 of the DQO Process and provides the estimated costs for the various sampling and analysis designs evaluated.

Table I-3. Summary of Inputs for Candidate Sampling Designs

Parameter	Systematic Sampling - Fixed Lab Analyses	Systematic Sampling - Field Analyses	Systematic Composite Sampling - Fixed Lab Analyses	Systematic Composite Sampling - Field Analyses
Inputs				
Sampling Costs				
Collection Cost (per "grab")	\$40 ea.	\$40 ea.	\$40 ea.	\$40 ea.
Documentation, processing, shipment	\$60 ea.	\$30 ea.	\$60 ea.	\$30 ea.
Analytical Costs				
SW-846 Method 3550/8270 (fixed lab)	\$110 ea.	\$110 ea.*	\$110 ea.	\$110 ea.*
SW-846 Method 4010A (field screening)	NA	\$20 ea.	NA	\$20 ea.
Relative Width of Gray Region (Δ)	0.33	0.33	0.33	0.33
Null Hypothesis (H_0)	Mean (PCP) \geq 10 mg/kg	Mean (PCP) \geq 10 mg/kg	Mean (PCP) \geq 10 mg/kg	Mean (PCP) \geq 10 mg/kg
False Rejection Decision Error Limit	$\alpha = 0.05$	$\alpha = 0.05$	$\alpha = 0.05$	$\alpha = 0.05$
False Acceptance Decision Error Limit	$\beta = 0.20$	$\beta = 0.20$	$\beta = 0.20$	$\beta = 0.20$
Relative Std. Dev.				
Sampling (S_s)	0.10	0.10	0.10	0.10
Analytical (S_a), SW-846 Method 8270	0.10	NA	0.10	NA
Analytical (S_a) SW-846 Method 4010A	NA	0.40	NA	0.40
"Population" (S_b)	0.50	0.50	0.50	0.50
Total Study	0.52	0.65	0.29**	0.48**
$s_T = \sqrt{s_s^2 + s_a^2 + s_b^2}$				

NA: Not applicable

* Assumes 20-percent of all field analyses must be confirmed via fix laboratory method.

** For composite sampling, the total study relative standard deviation (S_T) was estimated by replacing S_b^2 with

S_b^2/g , where g = the number of "grabs" per composite.

Table I-4. Summary of Outputs for Candidate Sampling Designs

Parameter	Systematic Sampling - Fixed Lab Analyses	Systematic Sampling - Field Analyses	Systematic Composite Sampling - Fixed Lab Analyses	Systematic Composite Sampling - Field Analyses
Outputs				
Number of Samples (<i>n</i>)	17	25	6	15
Cost Estimate				
“Grab” Sampling	\$40 x 17	\$40 x 25	\$40 x 4 x 6 (see note 1)	\$40 x 4 x 15 (see note 1)
Documentation, processing, and shipment	\$60 x 17	(\$30 x 25) + (\$60 x 5) (see note 2)	\$60 x 6	(\$30 x 15) + (\$60 x 3) (see note 2)
SW-846 Method 3550/8270 (fixed lab)	\$110 x 17	\$110 x 5 (see note 2)	\$110 x 6	\$110 x 3 (see note 2)
SW-846 Method 4010A (field screening)	NA	\$20 x 25	NA	\$20 x 15
Cost	\$3,570	\$3,100	\$1,980	\$3,660

1. The calculation assumes four grabs per composite sample.

2. The calculation includes costs for shipment and analysis of 20% of field screening samples for fixed laboratory analysis.

NA: Not applicable

4. **Select a resource-effective design.** It was determined that all of the systematic designs and systematic composite sampling designs would meet the statistical performance requirements for the study in estimating the mean PCP concentration in the SWMU. The project team selected the systematic composite sampling design - with fixed laboratory analysis - based on the cost savings projected over the other sampling designs.

The planning team decided that one additional field quality control sample (an equipment rinsate blank), analyzed by SW-846 Method 8720, was required to demonstrate whether the sampling equipment was free of contamination.

The outputs of the DQO Process were summarized in a memo report which was then used help prepare the QAPP.

5. **Prepare a QAPP.** The operational details of the sampling and analytical activities were documented in the QAPP using *EPA Guidance for Quality Assurance Project Plans, EPA QA/G-5* (USEPA 1998a) and Chapter One of SW-846 for guidance.

Implementation Phase

The QAPP was implemented in accordance with the schedule, sampling plan, and safety plan. The exact location of each field sample was established using a grid on a map of the SWMU. The start point for constructing the grid was selected at random.

The QAPP established the following DQOs and performance goals for the sampling equipment:

- The correct orientation and shape of each sample is a vertical core.
- Each sample must capture the full depth of interest (six inches).
- The minimum mass of each sample is 10 g.
- The device must be constructed of materials that will not alter analyte concentrations due to loss or gain of analytes via sorption, desorption, degradation, or corrosion.
- The device must be easy to use, safe, and low cost.

A sampling device was selected using the four-steps described in Figure 28 in Section 7.1.

Step 1 - Identify the Medium to be Sampled

The material to be sampled is a soil. Using Table 8 in Section 7.1, we find the media descriptor that most closely matches the waste in the first column of the table: "Soil and other unconsolidated geologic material."

Step 2 - Select the Sample Location

The second column of Table 8 in Section 7.1 provides a list of possible sampling sites (or units types) for soil (i.e., surface or subsurface). In this example, the sampling location is surface soil and "Surface" is found in the second column in the table.

Step 3 - Identify Candidate Sampling Devices

The third column of Table 8 in Section 7.1 provides a list of candidate sampling devices. For the waste stream in this example, the list includes bucket auger, concentric tube thief, coring type sampler, miniature core sampler, modified syringe, penetrating probe sampler, sampling scoop/trowel/shovel, thin-walled tube, and trier.

Step 4 - Select Devices

Sampling devices were selected from the list of candidate sampling devices after review of Table 9 in Section 7.1. Selection of the equipment was made after consideration of the DQOs for the sample support (i.e., required volume, depth, shape, and orientation), the performance goals established for the sampling device, ease of use and decontamination, worker safety issues, cost, and any practical considerations.

Table I-5 demonstrates how the DQOs and performance goals can be used together to narrow the candidate devices down to just one or two.

Table I-5. Using DQOs and Performance Goals to Select a Final Sampling Device

Candidate Devices	Data Quality Objectives and Performance Goals				
	Required Depth	Orientation and Shape	Sample Volume	Operational Considerations	Desired Material of Construction
	6 inches	Vertical undisturbed core	>10 g	Device is portable, safe, & low cost?	Stainless or carbon steel
Bucket auger	Y	N	Y	Y	Y
Concentric tube thief	Y	N	Y	Y	Y
Coring Type Sampler	Y	N	Y	Y	Y
Miniature core sampler	Y	Y	N	Y	N
Modified syringe sampling	N	N	N	Y	N
Penetrating Probe Sampler	Y	Y	Y	Y	Y
Scoop, trowel, or shovel	Y	N	Y	Y	Y
Thin-walled tube	Y	Y	Y	Y	Y
Trier	Y	N	Y	Y	Y

Key: Y = The device is capable of achieving the specified DQO or performance goal.
N = The device is not capable of achieving the DQO or performance goal.

The “penetrating probe sampler” and the “thin-walled tube” were identified as the preferred devices because they could satisfy all of the DQOs and performance goals for the sampling devices. The penetrating probe was selected because it was easy to use and was readily available to the field sampling crew.

A penetrating probe sampler was then used to take the field samples at each location on the systematic square grid (see Figure I-1). Each composite sample was formed by pooling and mixing individual samples collected from within each of four quadrants. The process was repeated until six composite samples were obtained. Because the total mass of each individual (grab) sample used to form composite samples exceeded that required by the laboratory for analysis, a field subsampling routine was used to reduce the volume of material submitted to the laboratory.

The field samples and associated field QC samples were submitted to the laboratory where a subsample was taken from each field sample for analysis. The samples were analyzed in accordance with the QAPP.

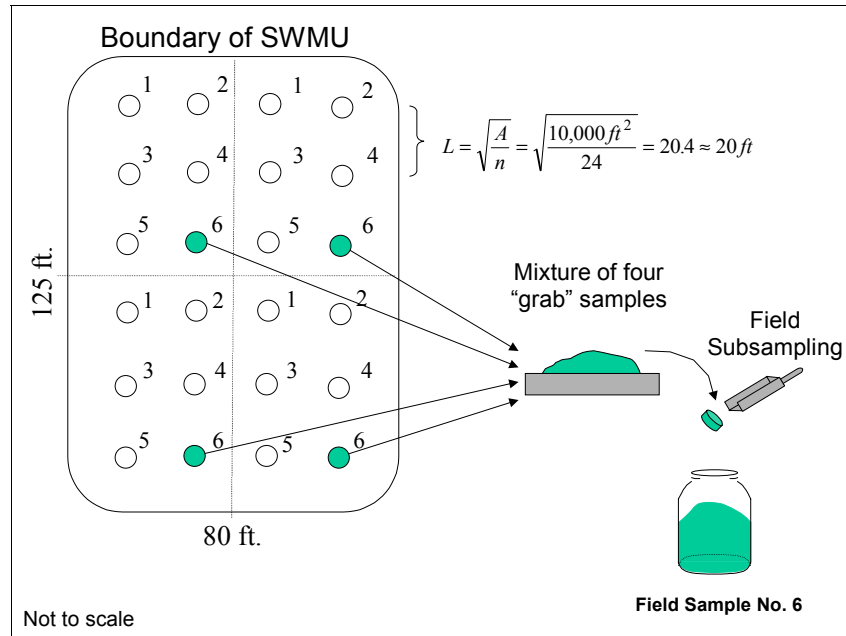

Figure I-1. Systematic sampling with compositing. The distance between sampling points (L) is determined using the approach described in Section 5.2.3 (Box 5). Samples with the same number are pooled and mixed to form each composite sample. A field sample is formed from each composite using one of the subsampling methods described in Section 7.3.2 (e.g., by fractional shoveling).

Assessment Phase

Data Verification and Validation

Sampling and analytical records were reviewed to check compliance with the QAPP. The data collected during the study met the measurement objectives. Sampling and analytical error were minimized through the use of a statistical sampling design, correct field sampling and subsampling procedures, and adherence to the requirements of the analytical methods. The soil that was sampled did not present any special problems concerning access to sampling locations, equipment usage, particle-size distribution, or matrix interferences. A quantitation limit of 0.5 mg/kg was achieved. The analytical package was verified and validated, and the data generated were judged acceptable for their intended purpose.

Data Quality Assessment (DQA)

DQA was performed using the approach outlined in Section 8.2:

1. **Review DQOs and sampling design.** The DQO planning team reviewed the original objectives: “If the mean concentration for PCP in the soil is less than 10 mg/kg, then the cleanup standard is attained. Otherwise, the SWMU will be considered contaminated and additional remedial action will be required.”

2. **Prepare the data for statistical analysis.** The summary of the verified and validated data were received in hard-copy format and an electronic data base was created by manual data entry into spreadsheet software. The data base was checked by a second person for accuracy. The results for the data collection effort are listed in Table I-6. A data file was created in a format suitable for import into EPA's *DataQUEST* software.

Table I-6. Soil Sample Analysis Results for PCP (mg/kg)

<i>Sample Identification</i>	<i>Result (PCP, mg/kg)</i>
1	8.0
2	8.0
3	7.0
4	6.0
5	10.5
6	7.5

3. **Conduct preliminary analysis of data and check distributional assumptions:** Using EPA's *DataQUEST*, statistical quantities were computed as shown in Figure I-2.

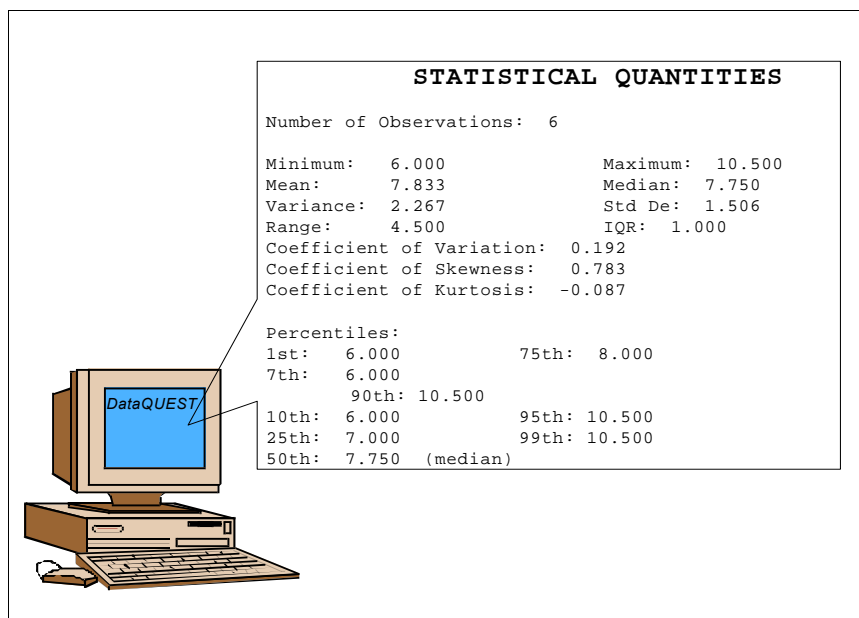

Figure I-2. Statistical quantities using *DataQUEST* software

On a normal probability plot, the data plot as a straight line, indicating approximate normality (see Figure I-3).

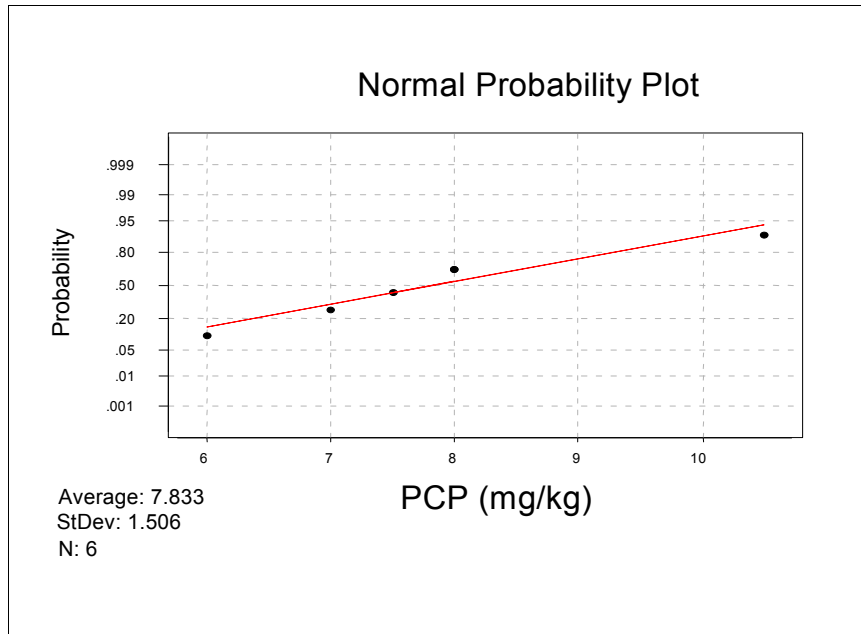

Figure I-3. Normal probability plot

The data also were checked for normality by the Shapiro-Wilk test. Using the *DataQUEST* software, the Shapiro-Wilk test was performed at the 0.05 percent significant level. The Shapiro-Wilk test did not reject the null hypothesis of normality (see Figure I-4).

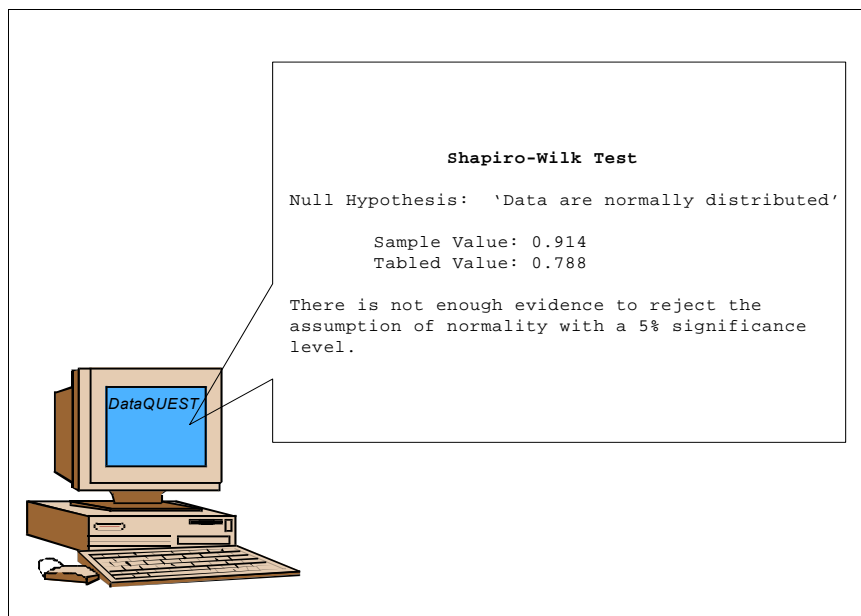

Figure I-4. Results of the Shapiro-Wilk test using EPA's *DataQUEST* software

4. **Select and perform the statistical test:** The analysis of the data showed there were no “non-detects” and a normal distribution was an acceptable model. Using the guidance in Figure 38 (Section 8.2.4), a parametric upper confidence limit (UCL) on the mean was selected as the correct statistic to compare to the regulatory level. The 95% UCL on the mean was calculated as follows:

$$\begin{aligned} UCL_{0.95} &= \bar{x} + t_{0.95, n-1} \frac{s}{\sqrt{n}} \\ &= 7.833 + 2.015 \left(\frac{1.506}{\sqrt{6}} \right) \\ &= 9.1 \text{ mg / kg} \end{aligned}$$

The tabulated “t value” (2.015) was obtained from Table G-1 in Appendix G and based on a 95-percent one-tailed confidence interval with $\alpha = 0.05$ and 5 degrees of freedom.

5. **Draw conclusions and report results:** The 95% UCL for the mean of the sample analysis results for PCP, 9.1 mg/kg, was less than the specified cleanup level of 10 mg/kg. Thus, the null hypothesis was rejected, and the owner made the determination that the soil remaining in the SWMU attains the cleanup standard for PCP based on the established decision rule.

A summary report including a description of all planning, implementation, and assessment activities was submitted to the regulatory agency for review.

Example 2: Sampling of a Process Waste to Make a Hazardous Waste Determination**Introduction**

An aircraft manufacturing and maintenance facility strips paint from parts before remanufacturing them. The facility recently switched its paint stripping process from a solvent-based system to use of an abrasive plastic blasting media (PBM). The waste solvent, contaminated with stripped paint, had to be managed as a hazardous waste. The facility owner changed the process to reduce - or possibly eliminate - the generation of hazardous waste from this operation and thereby reduce environmental risks and lower waste treatment and disposal costs.

The plant operators thought the spent PBM could include heavy metals such as chromium and cadmium from the paint, and therefore there was a need to make a hazardous waste determination in order to comply with the RCRA regulations at 40 CFR Part 262.11. The facility owner determined that the spent PBM is a solid waste under RCRA but not a listed hazardous waste. The facility owner then needed to determine if the solid waste exhibits any of the characteristics of hazardous waste: ignitability (§261.21), corrosivity (§261.22), reactivity (§261.23), or toxicity (§261.24). Using process and materials knowledge, the owner determined that the waste blasting media would not exhibit the characteristics of ignitability, corrosivity, or reactivity. The facility owner elected to conduct waste testing to determine if the waste blasting media exhibits the characteristic of toxicity.

This hypothetical example describes how the planning, implementation, and assessment activities were conducted.

Planning Phase

The planning phase comprises the Data Quality Objectives (DQO) Process and preparation of a quality assurance project plan (QAPP) including a sampling and analysis plan. A DQO planning team was assembled and the DQO Process was implemented following EPA's guidance in *Guidance for the Data Quality Objectives Process EPA QA/G-4* (USEPA 2000b) and SW-846.

The outputs of the seven steps of the DQO Process are outlined below.

DQO Step 1: Stating the Problem

- The DQO planning team included the plant manager, a technical project manager, a consulting chemist, and the paint stripping booth operator who also served as the sampler.
- The conceptual model of the waste generation process was developed as follows: The de-painting operation consists of a walk-in blast booth with a reclamation floor. After blasting, the plastic blast media, mixed with paint fines, is passed through a reclamation system; the reusable media is separated out for reloading to the blast unit, while the spent media and paint waste is discharged to a container.

- A concise description of the problem was developed as follows: The problem was described as determining whether the new waste stream (the spent plastic blasting media and waste paint) should be classified as a hazardous waste that requires treatment and subsequent disposal in a RCRA Subtitle C landfill (at \$300 per ton), or whether it is a nonhazardous industrial waste that can be land-disposed in an industrial landfill (at \$55 per ton).
- The plant manager gave the plant staff and consultant 60 days to complete the study. The turn-around time was established to minimize the amount of time that the waste was stored at the facility while the data were being generated, and to allow adequate time to have the waste shipped off site - if it were found to be a hazardous waste - within the 90-day accumulation time specified at 40 CFR Part 262.34(a).

DQO Step 2: Identifying Possible Decisions

- Decision statement: The decision statement was determining whether the spent PBM paint waste was hazardous under the RCRA regulations.
- Alternative actions: If the waste was hazardous, then treatment and subsequent disposal in a RCRA landfill would be required.

DQO Step 3: Identifying Inputs to the Decision

- The decision was to be based on the quantity of waste generated over approximately a one-month period, but not to exceed the quantity placed in a single 10-cubic yard roll off box.
- Based on process and materials knowledge, the team specified cadmium and chromium as the constituents of concern.
- To resolve the decision statement, the planning team needed to determine if, using the Toxicity Characteristic Leaching Procedure (TCLP) SW-846 Method 1311, the extract from a representative sample of the waste contained the constituents of concern at concentrations equal to or greater than their regulatory levels as required by the RCRA regulations at 40 CFR 261.24. The chemist noted, however, that the TCLP method allows the following: "If a total analysis of the waste demonstrates that individual analytes are not present in the waste, or that they are present but at such low concentrations that the appropriate regulatory levels could not possibly be exceeded, the TCLP need not be run." With that flexibility in mind, the planning team identified a candidate method for total analysis (including SW-846 Method 3050B/6010), and noted that the TCLP would be required if the total analysis indicated TC levels could be exceeded.
- The project chemist found that SW-846 Methods 3010A (prep) and 6010B were suitable for analysis of the TCLP extracts at quantitation limits at or below the applicable regulatory levels.

- The minimum sample “support” was determined as follows: Method 1311 (TCLP) specifies a minimum sample mass of 100 grams for analysis of nonvolatile constituents and a maximum particle size of 9.5 mm. The waste stream, composed of dry fine to medium-grained plastic and paint chips, was well within the particle size requirements of the TCLP. During Step 7 of the DQO Process, the planning team revisited this step to determine whether a sample mass larger than 100-grams would be necessary to satisfy the overall decision performance criteria.

DQO Step 4: Defining Boundaries

- The paint stripping operation includes a blast booth, a PBM reclamation unit, and a waste collection roll-off box that complies with the applicable container requirements of Subparts I and CC of 40 CFR part 265. The spent blast media and paint waste is discharged to the roll-off box from the reclamation unit. Each discharge event was considered a “batch” for the purposes of the waste classification study.
- When testing a solid waste to determine if it exhibits a characteristic of hazardous waste, the determination must be made when management of the solid waste would potentially be subject to the RCRA hazardous waste regulations at 40 CFR Part 262 through 265. Accordingly, the planning team decided samples should be obtained at the point where the waste discharges from the reclamation unit into the roll-off container (i.e., the point of generation). Until such time that the generator determined that the waste is not a hazardous waste, the generator complied with the applicable pre-transport requirements at 40 CFR Part 262 - Subpart C (i.e., packaging, labeling, marking, and accumulation time).
- The boundary of the decision was set as the extent of time over which the decision applies. The boundary would change only if there were a process or materials change that would alter the composition of the waste. Such a process or materials change could include, for example, a change in the composition, particle size or particle shape of the blasting media, or a significant change in the application (pressure) rate of the blast media.

DQO Step 5: Developing Decision Rules

- The planning team reviewed the RCRA regulations at for the Toxicity Characteristic at 40 CFR 261.24 and found the regulation does not specify a parameter of interest (such as the mean or a percentile). They observed, however, that the Toxicity Characteristic (TC) regulatory levels specified in Table 1 of Part 261.24 represent “maximum” concentrations that cannot be equaled or exceeded; otherwise, the solid waste must be classified as hazardous. While the regulations for hazardous waste determination do not require the use of any statistical test to make a hazardous waste determination, the planning team decided to use a high percentile value as a reasonable approximation of the maximum TCLP sample analysis result that could be obtained from a sample of the waste. Their objective was to “prove the negative” - that is, to demonstrate

with a desired level of confidence that the vast majority of the waste was nonhazardous. The upper 90th percentile was selected. The team specified an additional constraint that no single sample could exceed the standard. Otherwise, there may be evidence that the waste is hazardous at least part of the time.

- The Action Levels were set at the TC regulatory limits specified in Table 1 of 40 CFR Part 261.24:

Cadmium: 1.0 mg/L TCLP
Chromium: 5.0 mg/L TCLP

- The decision rule was then established as follows: “If the upper 90th percentile TCLP concentration for cadmium or chromium in the waste and all samples analysis results are less than their respective action levels of 1.0 and 5.0 mg/L TCLP, then the waste can be classified as nonhazardous waste under RCRA; otherwise, the waste will be considered a hazardous waste.”

DQO Step 6: Specifying Limits on Decision Errors

- The null hypothesis was that the waste is hazardous, i.e., the true proportion (P) of samples with concentrations of cadmium or chromium less than their regulatory thresholds is less than 0.90, or $H_0: P < 0.90$.
- Two potential decision errors could be made based on interpreting sampling and analytical data:

Decision Error A: Concluding that the true proportion (P) of the waste that is nonhazardous was greater than 0.90 when it was truly less than 0.90,
or

Decision Error B: Concluding that the true proportion (P) of the waste that is nonhazardous was less than 0.90 when it was truly greater than 0.90.

The consequences of Decision Error A - incorrectly deciding the waste was nonhazardous - would lead the facility to ship untreated hazardous waste off site for disposal in solid waste landfill, likely increase health risks for onsite workers, and pose potential future legal problems for the owner.

The consequences of Decision Error B - incorrectly deciding the waste was hazardous when in fact it is not hazardous - would cause the needless costs for treatment and disposal, but with no negative environmental consequences.

Error A, incorrectly deciding that a hazardous waste is a nonhazardous waste, posed more severe consequences for the generator in terms of liability and compliance concerns. Consequently, the baseline condition (null hypothesis) chosen was that the true proportion of waste that is nonhazardous is less than 90 percent.

Table I-7. Null Hypothesis and Possible Decision Errors for Example 2

“Null Hypothesis” (baseline condition)	Possible Decision Errors	
	Type I Error (α), False Rejection	Type II Error (β), False Acceptance
The true proportion (P) of waste that is nonhazardous is less than 0.90.	Concluding the waste is nonhazardous when, in fact, it is hazardous.	Concluding the waste is hazardous when, in fact, it is nonhazardous.

- Next, it was necessary to specify the boundaries of the gray region. When the null hypothesis (baseline condition) assumes that the waste is hazardous (as in this example), one limit of the gray region is bounded by the Action Level and the other limit is set at a point where it is desirable to control the Type II (false acceptance) error. The project team set one bound of the gray region at 0.90 (the Action Level). Since a “no exceedance” criterion is included in the decision rule, the other bound of the gray region is effectively set at 1.
- The DQO planning team then sets the acceptable probability of making a Type I (false rejection) error at 10 percent ($\alpha = 0.10$). In other words, they are willing to accept a 10 percent chance of concluding the waste is nonhazardous when at least a portion of the waste is hazardous. The use of the exceedance rule method does not require specification of the Type II (false acceptance) error rate.
- The information collected in Step 6 of the DQO Process is summarized below.

Table I-8. Initial Outputs of Step 6 of the DQO Process - Example 2

Needed Parameter	Output
Action Level	0.90
Gray Region	0.90 to 1.0 ($\Delta = 0.10$)
Null Hypothesis (H_0)	$P < 0.90$
False Rejection Decision Error Limit (probability of a Type I error)	$\alpha = 0.10$
False Acceptance Decision Error Limit (probability of a Type II error)	Not specified

DQO Step 7: Optimizing the Data Collection Design

- **Review outputs from the first six steps of the DQO Process.** The planning team reviewed the outputs of the first six steps of the DQO Process.
- **Consider various data collection designs.** The DQO planning team considered two probabilistic sampling designs: simple random and systematic (random within time intervals). Both the simple random and the systematic design would allow the facility owner to estimate whether a high percentage of the waste complies with the standard. The team also considered using an authoritative “biased” sampling design to estimate the high end or “worst case” waste characteristics.

Two analytical plans were then considered: One in which the full TCLP would be performed on each sample, and one in which TCLP concentrations could be estimated from total concentration by comparing each total sample analysis result to 20 times the TC regulatory limit (to account for the 20:1 dilution used in the TCLP).

The laboratory requested a sample mass of at least 300 grams (per sample) to allow the laboratory to perform the preliminary analyses required by the TCLP and to provide sufficient mass to perform the full TCLP (if required).

The practical considerations were then evaluated for each alternative design, including access to sampling locations, worker safety, equipment selection/use, experience needed, special analytical needs, and scheduling.

- **Select the optimal number of samples.** Since the decision rule specified no exceedance of the standard in any sample, the number of samples was determined from Table G-3a in Appendix G. The table is based on the formula $n = \log(\alpha)/\log(p)$. For a desired $p = 0.90$ and $(1 - \alpha) = 0.90$, the number of samples (n) for a simple random or systematic sampling design was 22.

The team also considered how many samples might be required if a nonprobabilistic authoritative sampling design were used. Some members of the planning team thought that significantly fewer samples (e.g., four) could be used to make a hazardous waste determination, and they pointed out that the RCRA regulations do not require statistical sampling for waste classification. On the other hand, other members of the planning team argued against the authoritative design. They argued that there was insufficient knowledge of the waste to implement authoritative sampling and noted that a few samples taken in a non-probabilistic manner would limit their ability to quantify any possible decision errors.

- **Select a resource-effective design.** The planning team evaluated the sampling and analytical design options and costs. The following table summarizes the estimated costs for the four sampling designs evaluated.

Table I-9. Estimated Costs for Implementing Candidate Sampling Designs

	Simple Random or Systematic Sampling (total metals only)	Simple Random or Systematic Sampling (TCLP metals)	Authoritative (Biased) Sampling (total metals only)	Authoritative (Biased) Sampling (TCLP metals)
Sample collection cost (per sample)	\$50	\$50	\$50	\$50
Analysis cost				
• SW-846 Methods 3050B/6010B (total Cd and Cr) (per sample)	\$40		\$40	
• SW-846 TCLP Method 1311. Extract analyzed by SW-846 Methods 3010A/6010B (per sample)		\$220		\$220
Number of samples	22	22	4	4
Total Estimated Cost	\$1,980	\$5,940	\$360	\$1,080

While the authoritative design with total metals analysis offered the least cost compared to the probabilistic designs, the team decided that they did not have sufficient knowledge of the waste, its leaching characteristics, or the process yet to use an authoritative sampling approach with total metals analysis only. Furthermore, the team needed to quantify the probability of making a decision error. The planning team selected the systematic design with total metals analysis for Cd and Cr with the condition that if any total sample analysis result indicated the maximum theoretical TCLP result could exceed the TC limit, then the TCLP would be performed for that sample. This approach was selected for its ease of implementation, it would provide adequate waste knowledge for future waste management decisions (assuming no change in the waste generation process), and would satisfy other cost and performance objectives specified by the planning team.

- **Prepare a QAPP/SAP.** The operational details of the sampling and analytical activities are documented in a Quality Assurance Project Plan and Sampling and Analysis Plan (QAPP/SAP).

Implementation Phase

The QAPP/SAP was implemented in accordance with the schedule and the facility’s safety program. Based on the rate of waste generation, it was estimated that the roll-off box would be filled in about 30 work days assuming one “batch” of waste was placed in the roll off box each day. It was decided to obtain one random sample from each batch as the waste was discharge from the reclamation unit to the roll-off container (i.e., at the *point of waste generation*). See Figure I-5.

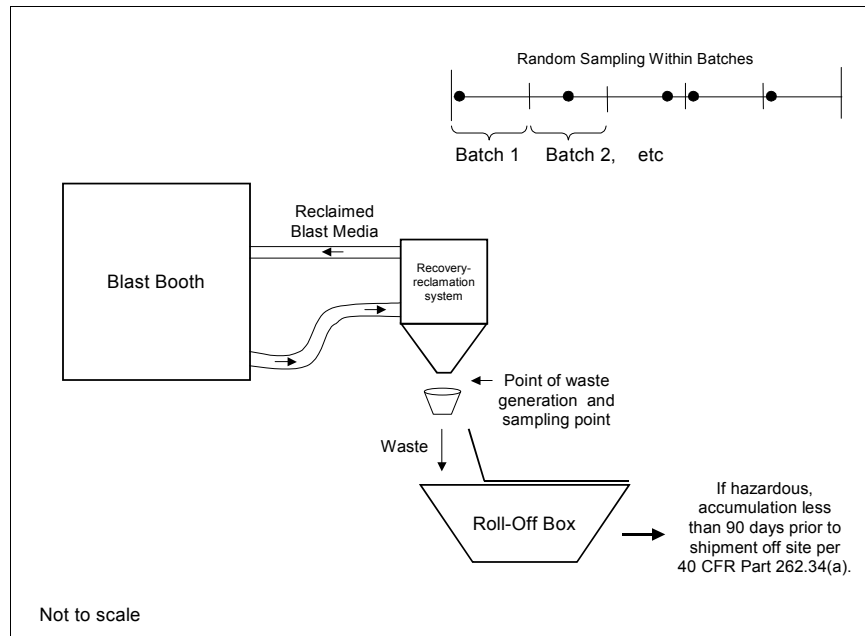

Figure I-5. Systematic sampling design with random sampling times selected within each batch

The QAPP/SAP established the following DQOs and performance goals for the equipment.

The sampling device must meet the following criteria:

- Be able to obtain a minimum mass of 300 grams for each sample
- Be constructed of materials that will not alter analyte concentrations due to loss or gain of analytes via sorption, desorption, degradation, or corrosion
- Be easy to use, safe, and low cost
- Be capable of obtaining increments of the waste at the discharge drop without introducing sampling bias.

The following four steps were taken to select the sampling device (from Section 7.1):

Step 1 - Identify the Medium To Be Sampled

Based on a prior inspection, it was known that the waste is a unconsolidated dry granular solid. Using Table 8 in Section 7.1, we find the media descriptor that most closely matches the waste in the first column of the table: "Other Solids - Unconsolidated."

Step 2 - Select the Sample Location

The second column of Table 8 provides a list of common sampling locations for unconsolidated solids. The discharge drop opening is four inches wide, and the waste is released downward into the collection box. "Pipe or Conveyor" found in the table is the closest match to the

configuration of the waste discharge point.

Step 3 - Identify Candidate Sampling Devices

The third column of Table 8 provides a list of candidate sampling devices for sampling solids from a pip or conveyor. For this waste stream, the list of devices for sampling a pipe or conveyor includes bucket, dipper, pan, sample container, miniature core sampler, scoop/trowel/shovel, and trier. The planning team immediately eliminated miniature core sampler, scoop/trowel/shovel, and trier because they are not suitable for obtaining samples from a falling stream or vertical discharge.

Step 4 - Select Devices

From the list of candidate sampling devices, one device was selected for use in the field from Table 9 in Section 7.1. Selection of the equipment was made after consideration of the DQOs for the sample support (i.e., required volume, width, shape, and orientation), the performance goals established for the sampling device, ease of use and decontamination, worker safety issues, cost, and any practical considerations. Table I-10 demonstrates how the DQOs and performance goals were used to narrow the candidate devices down to just one or two.

Table I-10. Using DQOs and Performance Goals To Select a Final Sampling Device

Candidate Devices	Data Quality Objectives and Performance Goals				
	Required Width	Orientation and Shape	Sample Volume	Operational Considerations	Desired Material of Construction
	4 inches	Cross-section of entire stream	>300 g	Device is portable, safe, and low cost?	Polyethylene or PTFE
Bucket	Y	Y	Y	Y	Y
Dipper	N	Y	Y	Y	Y
Pan	Y	Y	Y	Y	Y
Sample container	N	N	Y	Y	Y

Key: Y = The device is capable of achieving the specified DQO or performance goal.
 N = The device is not capable of achieving the specified DQO or performance goal.

The sampling mode was “one-dimensional,” that is, the material is relatively linear in time and space. The ideal sampling device would obtain a sample of constant thickness and must be capable of obtaining the entire width of the stream for a fraction of the time (see discussion at Section 6.3.2.1). Either a bucket or pan wide enough (preferably 3 times the width of the stream) to obtain all of the flow for a fraction of the time are identified as suitable devices because they are capable of achieving all the performance goals.

A flat 12-inch wide polyethylene pan with vertical sides was used to collect each primary field sample. Each primary field sample was approximately 2 kilograms, therefore, the field team used the “fractional shoveling” technique (see Section 7.3.2) to reduce the sample mass to a subsample of approximately 300 grams. The field samples (each in a 32-oz jar) and associated

field QC samples were submitted to the laboratory in accordance with the sample handling and shipping instructions specified in the QAPP/SAP.

A total of 30 samples were obtained by the time the roll-off box was filled, so it was necessary to randomly select 22 samples from the set of 30 for laboratory analysis.

All 22 samples were first analyzed for total cadmium and chromium to determine if the maximum theoretical TCLP concentration in any one sample could exceed the applicable TC limit. Samples whose maximum theoretical TCLP value exceeded the applicable TC limit were then analyzed using the full TCLP.

For the TCLP samples, no particle-size reduction was required for the sample extraction because the maximum particle size in the waste passed through a 9.5 mm sieve (the maximum particle size allowed for the TCLP). (On a small subsample of the waste, however, particle size reduction to 1 mm was required to determine the TCLP extract type (I or II)). A 100-gram subsample was taken from each field sample for TCLP analysis.

Assessment Phase

Data Verification and Validation

Sampling and analytical records were reviewed to check compliance with the QAPP/SAP. The data collected during the study met the DQOs. Sampling and analytical error were minimized through the use of a statistical sampling design, correct field sampling and subsampling procedures, and adherence to the requirements of the analytical methods. The material that was sampled did not present any special problems concerning access to sampling locations, equipment usage, particle-size distribution, or matrix interferences. Quantitation limits achieved for total cadmium and chromium were 5 mg/kg and 10 mg/kg respectively. Quantitation limits achieved for cadmium and chromium in the TCLP extract were 0.10 mg/L and 1.0 mg/L respectively. The analytical package was validated and the data generated were judged acceptable for their intended purpose.

Data Quality Assessment

DQA was performed using the approach outlined in Section 9.8.2 and EPA QA/G-9 (USEPA 2000d):

1. **Review DQOs and sampling design.** The DQO planning team reviewed the original objectives: "If the upper 90th percentile TCLP concentration for cadmium or chromium in the waste and all samples analysis results are less than their respective action levels of 1.0 and 5.0 mg/L TCLP, then the waste can be classified as nonhazardous waste under RCRA; otherwise, the waste will be considered a hazardous waste."
2. **Prepare the data for statistical analysis.** The summary of the verified and validated data were received in hard copy format, and summarized in a table. The table was checked by a second person for accuracy. The results for the data collection effort are listed in Table I-11.

Table I-11. Total and TCLP Sample Analysis Results

Sample No.	Cadmium		Chromium	
	Total (mg/kg)	Total / 20 (TC limit = 1 mg/L)	Total (mg/kg)	Total / 20 (TC limit = 5 mg/L)
1	<5	<0.25	11	0.55
2	6	0.3	<10	<0.5
3	29	1.45 (full TCLP = 0.72)	<10	<0.5
4	<5	<0.25	<10	<0.5
5	<5	<0.25	42	2.1
6	7	0.35	<10	<0.5
7	7	0.35	<10	<0.5
8	13	0.65	26	1.3
9	<5	<0.25	19	0.95
10	<5	<0.25	<10	<0.5
11	36	1.8 (full TCLP = 0.8)	<10	<0.5
12	<5	<0.25	<10	<0.5
13	<5	<0.25	<10	<0.5
14	<5	<0.25	12	0.6
15	<5	<0.25	<10	<0.5
16	9	0.45	<10	<0.5
17	<5	<0.25	<10	<0.5
18	<5	<0.25	<10	<0.5
19	<5	<0.25	31	1.55
20	20	1 (full TCLP = <0.10)	<10	<0.5
21	<5	<0.25	<10	<0.5
22	<5	<0.25	<10	<0.5

3. **Conduct preliminary analysis of data and check distributional assumptions.** To use the nonparametric “exceedance rule” no distributional assumptions are required. The only requirements are a random sample, and that the quantitation limit is less than the applicable standard. These requirements were met.

4. **Select and perform the statistical test:** The maximum TCLP sample analysis results for cadmium and chromium were compared to their respective TC regulatory limits. While several of the total results indicated the maximum theoretical TCLP result could exceed the regulatory limit, subsequent analysis of the TCLP extracts from these samples indicated the TCLP concentrations were below the regulatory limits.

5. **Draw conclusions and report results.** All 22 sample analysis results were less than the applicable TC limits, therefore the owner concluded with at least 90-percent confidence that at least 90-percent of all possible samples of the waste would be below the TC regulatory levels. Based on the decision rule established for the study, the owner decided to manage the waste as a nonhazardous waste.¹

A summary report including a description of all planning, implementation, and assessment activities was placed in the operating record.

¹ Note that if fewer than 22 samples were analyzed - for example, due to a lost sample - and all sample analysis results indicated concentrations less than the applicable standard, then one still could conclude that 90-percent of all possible samples are less than the standard but with a lower level of confidence. See Section 5.5.2, Equation 17.

APPENDIX J

SUMMARIES OF ASTM STANDARDS

ASTM (the American Society for Testing and Materials) is one of the entities that can provide additional useful information on sampling. This appendix references many of the standards published by ASTM that are related to sampling.

ASTM is a not-for-profit organization that provides a forum for writing standards for materials, products, systems, and services. The Society develops and publishes standard test methods, specifications, practices, guides, classifications, and terminology.

Each ASTM standard is developed within the consensus principles of the Society and meets the approved requirements of its procedures. The voluntary, full-consensus approach brings together people with diverse backgrounds and knowledge. The standards undergo intense round-robin testing. Strict balloting and due process procedures guarantee accurate, up-to-date information.

Contact ASTM

For more information on ASTM or how to purchase their publications, including the standards referenced by this appendix, contact them at: ASTM, 100 Barr Harbor Drive, West Conshohocken, PA 19428-2959; telephone: 610-832-9585; World Wide Web: <http://www.astm.org>.

To help you determine which ASTM standards may be most useful, this appendix includes text found in the scope of each standard. The standards, listed in alpha-numerical order, each deal in some way with sample collection. ASTM has future plans to publish these standards together in one volume on sampling.

D 140 Standard Practice for Sampling Bituminous Materials

This practice applies to the sampling of bituminous materials at points of manufacture, storage, or delivery.

D 346 Standard Practice for Collection and Preparation of Coke Samples for Laboratory Analysis

This practice covers procedures for the collection and reduction of samples of coke to be used for physical tests, chemical analyses, and the determination of total moisture.

D 420 Guide to Site Characterization for Engineering, Design, and Construction Purposes

This guide refers to ASTM methods by which soil, rock, and ground-water conditions may be determined. The objective of the investigation should be to identify and locate, both horizontally and vertically, significant soil and rock types and ground-water conditions present within a given site area and to establish the characteristics of the subsurface materials by sampling or *in situ* testing, or both.

D 1452 Standard Practice for Soil Investigation and Sampling by Auger Borings

This practice covers equipment and procedures for the use of earth augers in shallow geotechnical exploration. It does not apply to sectional continuous flight augers. This practice applies to any purpose for which disturbed samples can be used. Augers are valuable in connection with ground water level determinations, to help indicate changes in strata, and in the advancement of a hole for spoon and tube sampling.

D 1586 Standard Test Method for Penetration Test and Split-Barrel Sampling of Soils

This test method describes the procedure, generally known as the Standard Penetration Test, for driving a split-barrel sampler. The procedure is used to obtain a representative soil sample and to measure the resistance of the soil to penetration of the sampler.

D 1587 Standard Practice for Thin-Walled Tube Geotechnical Sampling of Soils

This practice covers a procedure for using a thin-walled metal tube to recover relatively undisturbed soil samples suitable for laboratory tests of structural properties. Thin-walled tubes used in piston, plug, or rotary-type samplers, such as the Denison or Pitcher sampler, should comply with the portions of this practice that describe the thin-walled tubes. This practice is used when it is necessary to obtain a relatively undisturbed sample. It does not apply to liners used within the above samplers.

D 2113 Standard Practice for Diamond Core Drilling for Site Investigation

This practice describes equipment and procedures for diamond core drilling to secure core samples of rock and some soils that are too hard to sample by soil-sampling methods. This method is described in the context of obtaining data for foundation design and geotechnical engineering purposes rather than for mineral and mining exploration.

D 2234 Standard Practice for Collection of a Gross Sample of Coal

This practice covers procedures for the collection of a gross sample of coal under various conditions of sampling. The practice describes general and special purpose sampling procedures for coals by size and condition of preparation (e.g., mechanically cleaned coal or raw coal) and by sampling characteristics. The sample is to be crushed and further prepared for analysis in accordance with ASTM Method D 2013. This practice also gives procedures for dividing large samples before any crushing.

D 3213 Standard Practices for Handling, Storing, and Preparing Soft Undisturbed Marine Soil

These practices cover methods for project/cruise reporting; and for the handling, transporting and storing of soft cohesive undisturbed marine soil. The practices also cover procedures for preparing soil specimens for triaxial strength, and procedures for consolidation testing. These practices may include the handling and transporting of sediment specimens contaminated with hazardous materials and samples subject to quarantine regulations.

D 3326 Standard Practice for Preparation of Samples for Identification of Waterborne Oils

This practice covers the preparation for analysis of waterborne oils recovered from water. The identification is based on the comparison of physical and chemical characteristics of the waterborne oils with oils from suspect sources. These oils may be of petroleum or vegetable/animal origin, or both. The practice covers the following seven procedures (A through G): Procedure A, for samples of more than 50-mL volume containing significant quantities of hydrocarbons with boiling points above 280°C; Procedure B, for samples containing significant quantities of hydrocarbons with boiling points above 280°C; Procedure C, for waterborne oils containing significant amounts of components boiling below 280°C and to mixtures of these and higher boiling components; Procedure D, for samples containing both petroleum and vegetable/animal derived oils; Procedure E, for samples of light crudes and medium distillate fuels; Procedure F, for thin films of oil-on-water; and Procedure G, for oil-soaked samples.

D 3370 Standard Practices for Sampling Water from Closed Conduits

These practices cover the equipment and methods for sampling water from closed conduits (e.g., process streams) for chemical, physical, and microbiological analyses. It provides practices for grab sampling, composite sampling, and continual sampling of closed conduits.

D 3550 Standard Practice for Ring-Lined Barrel Sampling of Soils

This practice covers a procedure for using a ring-lined barrel sampler to obtain representative samples of soil for identification purposes and other laboratory tests. In cases in which it has been established that the quality of the sample is adequate, this practice provides shear and consolidation specimens that can be used directly in the test apparatus without prior trimming. Some types of soils may gain or lose significant shear strength or compressibility, or both, as a result of sampling. In cases like these, suitable comparison tests should be made to evaluate the effect of sample disturbance on shear strength and compressibility. This practice is not intended to be used as a penetration test; however, the force required to achieve penetration or a blow count, when driving is necessary, is recommended as supplemental information.

D 3665 Standard Practice for Random Sampling of Construction Materials

This practice covers the determination of random locations (or timing) at which samples of construction materials can be taken. For the exact physical procedures for securing the sample, such as a description of the sampling tool, the number of increments needed for a sample, or the size of the sample, reference should be made to the appropriate standard method.

D 3975 Standard Practice for Development and Use (Preparation) of Samples for Collaborative Testing of Methods for Analysis of Sediments

This practice establishes uniform general procedures for the development, preparation, and use of samples in the collaborative testing of methods for chemical analysis of sediments and similar materials. The principles of this practice are applicable to aqueous samples with suitable technical modifications.

D 3976 Standard Practice for Preparation of Sediment Samples for Chemical Analysis

This practice describes standard procedures for preparing test samples (including the removal of occluded water and moisture) of field samples collected from locations such as streams, rivers, ponds, lakes, and oceans. These procedures are applicable to the determination of volatile, semivolatile, and nonvolatile constituents of sediments.

D 3694 Standard Practices for Preparation of Sample Containers and for Preservation of Organic Constituents

These practices cover the various means of (1) preparing sample containers used for collection of waters to be analyzed for organic constituents and (2) preservation of such samples from the time of sample collection until the time of analysis. The sample preservation practice depends on the specific analysis to be conducted. Preservation practices are listed with the corresponding applicable general and specific constituent test method. The preservation method for waterborne oils is given in Practice D 3325. Use of the information given will make it possible to choose the minimum number of sample preservation practices necessary to ensure the integrity of a sample designated for multiple analysis.

D 4136 Standard Practice for Sampling Phytoplankton with Water-Sampling Bottles

This practice covers the procedures for obtaining quantitative samples of a phytoplankton community by the use of water-sampling bottles.

D 4220 Standard Practices for Preserving and Transporting Soil Samples

These practices cover procedures for preserving soil samples immediately after they are obtained in the field and accompanying procedures for transporting and handling the samples. These practices are not intended to address requirements applicable to transporting of soil samples known or suspected to contain hazardous materials.

D 4342 Standard Practice for Collecting of Benthic Macroinvertebrates with Ponar Grab Sampler

This practice covers the procedures for obtaining qualitative or quantitative samples of macroinvertebrates inhabiting a wide range of bottom substrate types (e.g., coarse sand, fine gravel, clay, mud, marl, and similar substrates). The Ponar grab sampler is used in freshwater lakes, rivers, estuaries, reservoirs, oceans, and similar habitats.

D 4343 Standard Practice for Collecting Benthic Macroinvertebrates with Ekman Grab Sampler

This practice covers the procedures for obtaining qualitative or quantitative samples of macroinvertebrates inhabiting soft sediments. The Ekman grab sampler is used in freshwater lakes, reservoirs, and, usually, small bodies of water.

D 4387 Standard Guide for Selecting Grab Sampling Devices for Collecting Benthic Macroinvertebrates

This guide covers the selection of grab sampling devices for collecting benthic macroinvertebrates. Qualitative and quantitative samples of macroinvertebrates in sediments or substrates are usually taken by grab samplers. The guide discusses the advantages and limitations of the Ponar, Peterson, Ekman and other grab samplers.

D 4411 Standard Guide for Sampling Fluvial Sediment in Motion

This guide covers the equipment and basic procedures for sampling to determine discharge of sediment transported by moving liquids. Equipment and procedures were originally developed to sample mineral sediments transported by rivers but they also are applicable to sampling a variety of sediments transported in open channels or closed conduits. Procedures do not apply to sediments transported by flotation. This guide does not pertain directly to sampling to determine nondischarge-weighted concentrations, which in special instances are of interest. However, much of the descriptive information on sampler requirements and sediment transport phenomena is applicable in sampling for these concentrations and the guide briefly specifies suitable equipment.

D 4448 Standard Guide for Sampling Groundwater Monitoring Wells

This guide covers procedures for obtaining valid representative samples from ground-water monitoring wells. The scope is limited to sampling and "in the field" preservation and does not include well location, depth, well development, design and construction, screening, or analytical procedures. This guide provides a review of many of the most commonly used methods for sampling ground-water quality monitoring wells and is not intended to serve as a ground-water monitoring plan for any specific application. Because of the large and ever-increasing number of options available, no single guide can be viewed as comprehensive. The practitioner must make every effort to ensure that the methods used, whether or not they are addressed in this guide, are adequate to satisfy the monitoring objectives at each site.

D 4489 Standard Practices for Sampling of Waterborne Oils

These practices describe the procedures to be used in collecting samples of waterborne oils, oil found on adjoining shorelines, or oil-soaked debris, for comparison of oils by spectroscopic and chromatographic techniques, and for elemental analyses. Two practices are described. Practice A involves "grab sampling" macro oil samples. Practice B involves sampling most types of waterborne oils and is particularly applicable in sampling thin oil films or slicks. Practice selection will be dictated by the physical characteristics and the location of the spilled oil. Specifically, the two practices are (1) Practice A, for grab sampling thick layers of oil, viscous oils or oil soaked debris, oil globules, tar balls, or stranded oil, and (2) Practice B, for TFE-fluorocarbon polymer strip samplers. Each of the two practices collect oil samples with a minimum of water, thereby reducing the possibility of chemical, physical, or biological alteration by prolonged contact with water between the time of collection and analysis.

D 4547 Standard Guide for Sampling Waste and Soils for Volatile Organic Compounds

This guide describes recommended procedures for the collection, handling, and preparation of solid waste, soil, and sediment subsamples for subsequent determination of volatile organic compounds (VOCs). This class of compounds includes low molecular weight aromatics, hydrocarbons, halogenated hydrocarbons, ketones, acetates, nitriles, acrylates, ethers, and sulfides with boiling points below 200°C that are insoluble or slightly soluble in water. Methods of subsample collection, handling, and preparation for analysis are described. This guide does not cover the details of sampling design, laboratory preparation of containers, and the analysis of the subsamples.

D 4687 Standard Guide for General Planning of Waste Sampling

This guide provides information for formulating and planning the many aspects of waste sampling that are common to most waste-sampling situations. This guide addresses the following aspects of sampling: Sampling plans, safety plans, quality assurance considerations, general sampling considerations, preservation and containerization, cleaning equipment, labeling and shipping procedures, and chain-of-custody procedures. This guide does not provide comprehensive sampling procedures for these aspects, nor does it serve as a guide to any specific application.

D 4696 Standard Guide for Pore-Liquid Sampling from the Vadose Zone

This guide discusses equipment and procedures used for sampling pore-liquid from the vadose zone (unsaturated zone). The guide is limited to *in-situ* techniques and does not include soil core collection and extraction methods for obtaining samples. The term "pore-liquid" is applicable to any liquid from aqueous pore-liquid to oil, however, all of the samplers described in this guide are designed to sample aqueous pore-liquids only. The abilities of these samplers to collect other pore-liquids may be quite different than those described. Some of the samplers described in the guide currently are not commercially available. These samplers are presented because they may have been available in the past, and may be encountered at sites with established vadose zone monitoring programs. In addition, some of these designs are particularly suited to specific situations. If needed, these samplers could be fabricated.

D 4700 Standard Guide for Soil Sampling from the Vadose Zone

This guide addresses procedures that may be used for obtaining soil samples from the vadose zone (unsaturated zone). Samples can be collected for a variety of reasons, including the following:

- Stratigraphic description
- Hydraulic conductivity testing
- Moisture content measurement
- Moisture release curve construction
- Geotechnical testing
- Soil gas analyses
- Microorganism extraction
- Pore-liquid and soil chemical analyses.

This guide focuses on methods that provide soil samples for chemical analyses of the soil or contained liquids or contaminants. Comments on how methods may be modified for other objectives, however, also are included. This guide does not describe sampling methods for lithified deposits and rocks (e.g., sandstone, shale, tuff, granite).

D 4823 Standard Guide for Core Sampling Submerged, Unconsolidated Sediments

This guide covers core-sampling terminology, advantages and disadvantages of various core samplers, core distortions that may occur during sampling, techniques for detecting and minimizing core distortions, and methods for dissecting and preserving sediment cores. In this guide, sampling procedures and equipment are divided into the following categories (based on water depth): sampling in depths shallower than 0.5 m, sampling in depths between 0.5 m and 10 m, and sampling in depths exceeding 10 m. Each category is divided into two sections: (1) equipment for collecting short cores and (2) equipment for collecting long cores. This guide also emphasizes general principles. Only in a few instances are step-by-step instructions given. Because core sampling is a field-based operation, methods and equipment usually must be modified to suit local conditions. Drawings of samplers are included to show sizes and proportions. These samplers are offered primarily as examples (or generic representations) of equipment that can be purchased commercially or built from plans in technical journals. This guide is a brief summary of published scientific articles and engineering reports, and the references are listed. These documents provide operational details that are not given in the guide but are nevertheless essential to the successful planning and completion of core sampling projects.

D 4840 Standard Guide for Sampling Chain-of-Custody Procedures

This guide contains a comprehensive discussion of potential requirements for a sample chain-of-custody program and describes the procedures involved in sample chain-of-custody. The purpose of these procedures is to provide accountability for and documentation of sample integrity from the time of sample collection until sample disposal. These procedures are intended to document sample possession during each stage of a sample's life cycle, that is, during collection, shipment, storage, and the process of analysis. Sample chain of custody is just one aspect of the larger issue of data defensibility. A sufficient chain-of-custody process (i.e., one that provides sufficient evidence of sample integrity in a legal or regulatory setting) is situationally dependent. The procedures presented in this guide are generally considered sufficient to assure legal defensibility of sample integrity. In a given situation, less stringent measures may be adequate. It is the responsibility of the users of this guide to determine their exact needs. Legal counsel may be needed to make this determination.

D 4854 Standard Guide for Estimating the Magnitude of Variability from Expected Sources in Sampling Plans

The guide explains how to estimate the contributions of the variability of lot sampling units, laboratory sampling units, and specimens to the variation of the test result of a sampling plan. The guide explains how to combine the estimates of the variability from the three sources to obtain an estimate of the variability of the sampling plan results. The guide is applicable to all sampling plans that produce variables data. It is not applicable to plans that produce attribute data, since such plans do not take specimens in stages, but require that specimens be taken at random from all of the individual items in the lot.

D 4916 Standard Practice for Mechanical Auger Sampling

This practice describes procedures for the collection of an increment, partial sample, or gross sample of material using mechanical augers. Reduction and division of the material by mechanical equipment at the auger also is covered.

D 5013 Standard Practices for Sampling Wastes from Pipes and Other Point Discharges

These practices provide guidance for obtaining samples of waste at discharge points from pipes, sluiceways, conduits, and conveyor belts. The following are included: Practice A – Liquid or Slurry Discharges, and Practice B – Solid or Semisolid Discharges. These practices are intended for situations in which there are no other applicable ASTM sampling methods for the specific industry. These practices do not address flow and time-proportional samplers and other automatic sampling devices. Samples are taken from a flowing waste stream or moving waste mass and, therefore, are descriptive only within a certain period. The length of the period for which a sample is descriptive will depend on the sampling frequency and compositing scheme.

D 5088 Standard Practice for Decontamination of Field Equipment Used at Nonradioactive Waste Sites

This practice covers the decontamination of field equipment used in the sampling of soils, soil gas, sludges, surface water, and ground water at waste sites that are to undergo both physical and chemical analyses. This practice is applicable only at sites at which chemical (organic and inorganic) wastes are a concern and is not intended for use at radioactive or mixed (chemical and radioactive) waste sites. Procedures are included for the decontamination of equipment that comes into contact with the sample matrix (sample contacting equipment) and for ancillary equipment that has not contacted the portion of sample to be analyzed (nonsample contacting equipment). This practice is based on recognized methods by which equipment may be decontaminated. When collecting environmental matrix samples, one should become familiar with the site-specific conditions. Based on these conditions and the purpose of the sampling effort, the most suitable method of decontamination can be selected to maximize the integrity of analytical and physical testing results. This practice is applicable to most conventional sampling equipment constructed of metallic and synthetic materials. The manufacturer of a specific sampling apparatus should be contacted if there is concern regarding the reactivity of a decontamination rinsing agent with the equipment.

D 5092 Standard Practice for Design and Installation of Ground Water Monitoring Wells in Aquifers

This practice addresses the selection and characterization (by defining soil, rock types, and hydraulic gradients) of the target monitoring zone as an integral component of monitoring well design and installation. The development of a conceptual hydrogeologic model for the intended monitoring zone(s) is recommended prior to the design and installation of a monitoring well. The guidelines are based on recognized methods by which monitoring wells may be designed and installed for the purpose of detecting the presence or absence of a contaminant, and collecting representative ground water quality data. The design standards and installation procedures in the practice are applicable to both detection and assessment monitoring programs for facilities. The recommended monitoring well design, as presented in this practice,

is based on the assumption that the objective of the program is to obtain representative ground-water information and water quality samples from aquifers. Monitoring wells constructed following this practice should produce relatively turbidity-free samples for granular aquifer materials ranging from gravels to silty sand and sufficiently permeable consolidated and fractured strata. Strata having grain sizes smaller than the recommended design for the smallest diameter filter pack materials should be monitored by alternative monitoring well designs not addressed by this practice.

D 5283 Standard Practice for Generation of Environmental Data Related to Waste Management Activities Quality Assurance and Quality Control Planning and Implementation

This practice addresses the planning and implementation of the sampling and analysis aspects of environmental data generation activities. It defines the criteria that must be considered to assure the quality of the field and analytical aspects of environmental data generation activities. Environmental data include, but are not limited to, the results from analyses of samples of air, soil, water, biota, waste, or any combinations thereof. DQOs should be adopted prior to application of this practice. Data generated in accordance with this practice are subject to a final assessment to determine whether the DQOs were met. For example, many screening activities do not require all of the mandatory quality assurance and quality control steps found in this practice to generate data adequate to meet the project DQOs. The extent to which all of the requirements must be met remains a matter of technical judgment as it relates to the established DQOs. This practice presents extensive management requirements designed to ensure high-quality environmental data.

D 5314 Standard Guide for Soil Gas Monitoring in the Vadose Zone

This guide covers information pertaining to a broad spectrum of practices and applications of soil atmosphere sampling, including sample recovery and handling, sample analysis, data interpretation, and data reporting. This guide can increase the awareness of soil gas monitoring practitioners concerning important aspects of the behavior of the soil-water-gas contaminant system in which this monitoring is performed, as well as inform them of the variety of available techniques of each aspect of the practice. Appropriate applications of soil gas monitoring are identified, as are the purposes of the various applications. Emphasis is placed on soil gas contaminant determinations in certain application examples. This guide suggests a variety of approaches useful in monitoring vadose zone contaminants with instructions that offer direction to those who generate and use soil gas data. This guide does not recommend a standard practice to follow in all cases, nor does it recommend definite courses of action. The success of any one soil gas monitoring methodology is strongly dependent upon the environment in which it is applied.

D 5358 Standard Practice for Sampling with a Dipper or Pond Sampler

This practice describes the procedure and equipment for taking surface samples of water or other liquids using a dipper. A pond sampler or dipper with an extension handle allows the operator to sample streams, ponds, waste pits, and lagoons as far as 15 feet from the bank or other secure footing. The dipper is useful in filling a sample bottle without contaminating the outside of the bottle.

D 5387 Standard Guide for Elements of a Complete Data Set for Non-Cohesive Sediments

This guide covers criteria for a complete sediment data set, and it provides guidelines for the collection of non-cohesive sediment alluvial data. This guide describes what parameters should be measured and stored to obtain a complete sediment and hydraulic data set that could be used to compute sediment transport using any prominently known sediment-transport equations.

D 5451 Standard Practice for Sampling Using a Trier Sampler

This practice covers sampling using a trier. A trier resembles an elongated scoop, and is used to collect samples of granular or powdered materials that are moist or sticky and have a particle diameter less than one-half the diameter of the trier. The trier can be used as a vertical coring device only when it is certain that a relatively complete and cylindrical sample can be extracted.

D 5495 Standard Practice for Sampling with a Composite Liquid Waste Sampler (COLIWASA)

This practice describes the procedure for sampling liquids with the composite liquid waste sampler (COLIWASA). The COLIWASA is an appropriate device for obtaining a representative sample from stratified or unstratified liquids. Its most common use is for sampling containerized liquids, such as tanks, barrels, and drums. It may also be used for pools and other open bodies of stagnant liquid. (A limitation of the COLIWASA is that the stopper mechanism may not allow collection of approximately the bottom inch of material, depending on construction of the stopper.) The COLIWASA should not be used to sample flowing or moving liquids.

D 5608 Standard Practice for Decontamination of Field Equipment Used at Low Level Radioactive Waste Sites

This practice covers the decontamination of field equipment used in the sampling of soils, soil gas, sludges, surface water, and ground water at waste sites known or suspected of containing low-level radioactive wastes. This practice is applicable at sites where low-level radioactive wastes are known or suspected to exist. By itself or in conjunction with Practice D 5088, this practice may also be applicable for the decontamination of equipment used in the vicinity of known or suspected transuranic or mixed wastes. Procedures are contained in this practice for the decontamination of equipment that comes into contact with the sample matrix (sample contacting equipment), and for ancillary equipment that has not contacted the sample, but may have become contaminated during use (noncontacting equipment). This practice is applicable to most conventional sampling equipment constructed of metallic and hard and smooth synthetic materials. Materials with rough or porous surfaces, or having a high sorption rate, should not be used in radioactive-waste sampling due to the difficulties with decontamination. In those cases in which sampling will be periodically performed, such as sampling of wells, consideration should be given to the use of dedicated sampling equipment if legitimate concerns exist for the production of undesirable or unmanageable waste byproducts, or both, during the decontamination of tools and equipment. This practice does not address regulatory requirements for personnel protection or decontamination, or for the handling, labeling, shipping, or storing of wastes, or samples. Specific radiological release requirements and limits must be determined by users in accordance with local, State and Federal regulations.

D 5633 Standard Practice for Sampling with a Scoop

This procedure covers the method and equipment used to collect surface and near-surface samples of soils and physically similar materials using a scoop. This practice is applicable to rapid screening programs, pilot studies, and other semi-quantitative investigations. The practice describes how a shovel is used to remove the top layers of soil to the appropriate sample depth and either a disposable scoop or a reusable scoop is used to collect and place the sample in the sample container.

D 5658 Standard Practice for Sampling Unconsolidated Waste from Trucks

This practice covers several methods for collecting waste samples from trucks. These methods are adapted specifically for sampling unconsolidated solid wastes in bulk loads using several types of sampling equipment.

D 5679 Standard Practice for Sampling Consolidated Solids in Drums or Similar Containers

This practice covers typical equipment and methods for collecting samples of consolidated solids in drums or similar containers. These methods are adapted specifically for sampling drums having a volume of 110 U.S. gallons (416 L) or less, and are applicable to a hazardous material, product, or waste.

D 5680 Standard Practice for Sampling Unconsolidated Solids in Drums or Similar Containers

This practice covers typical equipment and methods for collecting samples of unconsolidated solids in drums or similar containers. These methods are adapted specifically for sampling drums having a volume of 110 U.S. gallons (416 L) or less, and are applicable to a hazardous material, product, or waste.

D 5730 Standard Guide for Site Characterization for Environmental Purposes with Emphasis on Soil, Rock, the Vadose Zone and Ground Water

This guide covers a general approach to planning field investigations that is useful for any type of environmental investigation with a primary focus on the subsurface and major factors affecting the surface and subsurface environment. Generally, such investigations should identify and locate, both horizontally and vertically, significant soil and rock masses and ground-water conditions present within a given site area and establish the characteristics of the subsurface materials by sampling or *in situ* testing, or both. The extent of characterization and specific methods used will be determined by the environmental objectives and data quality requirements of the investigation. This guide focuses on field methods for determining site characteristics and collection of samples for further physical and chemical characterization. It does not address special considerations required for characterization of karst and fractured rock terrain.

D 5743 Standard Practice for Sampling Single or Multilayered Liquids, with or without Solids, in Drums or Similar Containers

This practice covers typical equipment and methods for collecting samples of single or multilayered liquids, with or without solids, in drums or similar containers. These methods are adapted specifically for sampling drums having a volume of 110 gallons (416 L) or less, and are applicable to a hazardous material, product, or waste.

D 5792 Standard Practice for Generation of Environmental Data Related to Waste Management Activities: Development of Data Quality Objectives

This practice covers the development of data quality objectives (DQOs) for the acquisition of environmental data. Optimization of sampling and analysis design is a part of the DQO Process. This practice describes the DQO Process in detail. The various strategies for design optimization are too numerous to include in this practice. Many other documents outline alternatives for optimizing sampling and analysis design, therefore, only an overview of design optimization is included. Some design aspects are included in the examples for illustration purposes.

D 5903 Standard Guide for Planning and Preparing for a Groundwater Sampling Event

This guide covers planning and preparing for a ground-water sampling event. It includes technical and administrative considerations and procedures. Example checklists are also provided as appendices. This guide may not cover every consideration and procedure that is necessary before all ground-water sampling projects. This guide focuses on sampling of ground water from monitoring wells; however, most of the guidance herein can apply to the sampling of springs as well.

D 5911 Standard Practice for Minimum Set of Data Elements to Identify a Soil Sampling Site

This practice covers what information should be obtained to uniquely identify any soil sampling or examination site where an absolute and recoverable location is necessary for quality control of the study, such as for a waste disposal project. The minimum set of data elements was developed considering the needs for informational data bases, such as geographic information systems. Other distinguishing details, such as individual site characteristics, help in singularly cataloging the site. For studies that are not environmentally regulated, such as for an agricultural or preconstruction survey, the data specifications established by a client and the project manager may be different from that of the minimum set. As used in this practice, a soil sampling site is meant to be a single point, not a geographic area or property, located by an X, Y, and Z coordinate position at land surface or a fixed datum. All soil data collected for the site are directly related to the coordinate position, e.g., a sample is collected from a certain number of feet (or meters) or sampled from a certain interval to feet (or meters) below the X, Y, and Z coordinate position. A soil sampling site can include a test well, augered or bored hole, excavation, grab sample, test pit, sidewall sample, stream bed, or any other site where samples of the soil can be collected or examined for the purpose intended. Samples of soil (sediment) filtered from the water of streams, rivers, or lakes are not in the scope of this practice.

D 5956 Standard Guide for Sampling Strategies for Heterogeneous Wastes

This guide is a practical nonmathematical discussion for heterogeneous waste sampling strategies. This guide is consistent with the particulate material sampling theory, as well as inferential statistics, and may serve as an introduction to the statistical treatment of sampling issues. This guide does not provide comprehensive sampling procedures, nor does it serve as a guide to any specification.

D 6001 Standard Guide for Direct-Push Water Sampling for Geoenvironmental Investigations

This guide reviews methods for sampling ground water at discrete points or in increments by insertion of sampling devices by static force or impact without drilling and removal of cuttings. By directly pushing the sampler, the soil is displaced and helps to form an annular seal above the sampling zone. Direct-push water sampling can be one-time or multiple-sampling events. Methods for obtaining water samples for water quality analysis and detection of contaminants are presented. Field test methods described in this guide include installation of temporary well points and insertion of water samplers using a variety of insertion methods. The insertion methods include (1) soil probing using combinations of impact, percussion, or vibratory driving with or without additions of smooth static force; (2) smooth static force from the surface using hydraulic penetrometer or drilling equipment and incremental drilling combined with direct-push water sampling events. Methods for borehole abandonment by grouting are also addressed.

D 6008 Standard Practice for Conducting Environmental Baseline Surveys

The purpose of this practice is to define good commercial and customary practice in the United States for conducting an environmental baseline survey (EBS). Such surveys are conducted to determine certain elements of the environmental condition of Federal real property, including excess and surplus property at closing and realigning military installations. This effort is conducted to fulfill certain requirements of the Comprehensive Environmental Response Compensation and Liability Act of 1980 (CERCLA) section 120(h), as amended by the Community Environmental Response Facilitation Act of 1992 (CERFA). As such, this practice is intended to help a user to gather and analyze data and information in order to classify property into seven environmental condition of property area types (in accordance with the Standard Classification of Environmental Condition of Property Area Types). Once documented, the EBS is used to support Findings of Suitability to Lease, or uncontaminated property determinations, or a combination thereof, pursuant to the requirements of CERFA. Users of this practice should note that it does not address (except where explicitly noted) requirements of CERFA. The practice also does not address (except where explicitly noted) requirements for appropriate and timely regulatory consultation or concurrence, or both, during the conduct of the EBS or during the identification and use of the standard environmental condition of property area types.

D 6009 Standard Guide for Sampling Waste Piles

This guide provides guidance for obtaining representative samples from waste piles. Guidance is provided for site evaluation, sampling design, selection of equipment, and data interpretation. Waste piles include areas used primarily for waste storage or disposal, including above-grade dry land disposal units. This guide can be applied to sampling municipal waste piles, and it addresses how the choice of sampling design and sampling methods depends on specific

features of the pile.

D 6044 Standard Guide for Representative Sampling for Management of Waste and Contaminated Media

This guide covers the definition of representativeness in environmental sampling, identifies sources that can affect representativeness (especially bias), and describes the attributes that a representative sample or a representative set of samples should possess. For convenience, the term “representative sample” is used in this guide to denote both a representative sample and a representative set of samples, unless otherwise qualified in the text. This guide outlines a process by which a representative sample may be obtained from a population, and it describes the attributes of a representative sample and presents a general methodology for obtaining representative samples. It does not, however, provide specific or comprehensive sampling procedures. It is the user’s responsibility to ensure that proper and adequate procedures are used.

D 6051 Standard Guide for Composite Sampling and Field Subsampling for Environmental Waste Management Activities

This guide discusses the advantages and appropriate use of composite sampling, field procedures and techniques to mix the composite sample and procedures to collect an unbiased and precise subsample from a larger sample. Compositing and subsampling are key links in the chain of sampling and analytical events that must be performed in compliance with project objectives and instructions to ensure that the resulting data are representative. This guide discusses the advantages and limitations of using composite samples in designing sampling plans for characterization of wastes (mainly solid) and potentially contaminated media. This guide assumes that an appropriate sampling device is selected to collect an unbiased sample. It does not address where samples should be collected (depends on the objectives), selection of sampling equipment, bias introduced by selection of inappropriate sampling equipment, sample collection procedures or collection of a representative specimen from a sample, or statistical interpretation of resultant data and devices designed to dynamically sample process waste streams. It also does not provide sufficient information to statistically design an optimized sampling plan, or to determine the number of samples to collect or to calculate the optimum number of samples to composite to achieve specified data quality objectives. The mixing and subsampling described in this guide is expected to cause significant losses of volatile constituents. Specialized procedures should be used for compositing samples for determination of volatiles.

D 6063 Standard Guide for Sampling of Drums and Similar Containers by Field Personnel

This guide covers information, including flow charts, for field personnel to follow in order to collect samples from drums and similar containers. The purpose of this guide is to help field personnel in planning and obtaining samples from drums and similar containers, using equipment and techniques that will ensure that the objectives of the sampling activity will be met. It can also be used as a training tool.

D 6169 Standard Guide for Selection of Soil and Rock Sampling Devices Used With Drill Rigs for Environmental Investigations

This guide covers the selection of soil and rock sampling devices used with drill rigs for the purpose of characterizing *in situ* physical and hydraulic properties, chemical characteristics, subsurface lithology, stratigraphy, and structure, and hydrogeologic units in environmental investigations.

D 6232 Standard Guide for Selection of Sampling Equipment for Waste and Contaminated Media Data Collection Activities

This guide covers criteria that should be considered when selecting sampling equipment for collecting environmental and waste samples for waste management activities. This guide includes a list of equipment that is used and is readily available. Many specialized sampling devices are not specifically included in this guide, however, the factors that should be weighed when choosing any piece of equipment are covered and remain the same for the selection of any piece of equipment. Sampling equipment described in this guide include automatic samplers, pumps, bailers, tubes, scoops, spoons, shovels, dredges, and coring and augering devices. The selection of sampling locations is outside the scope of this guide.

D 6233 Standard Guide for Data Assessment for Environmental Waste Management Activities

This guide covers a practical strategy for examining an environmental project data collection effort and the resulting data to determine conformance with the project plan and impact on data usability. This guide also leads the user through a logical sequence to determine which statistical protocols should be applied to the data.

D 6250 Standard Practice for Derivation of Decision Point and Confidence Limit for Statistical Testing of Mean Concentration in Waste Management Decisions

This practice covers a logical basis for the derivation of a decision point and confidence limit when the mean concentration is used for making environmental waste management decisions. The determination of a decision point or confidence limit should be made in the context of the defined problem. The main focus of this practice is on the determination of a decision point. In environmental management decisions, the derivation of a decision point allows a direct comparison of a sample mean against this decision point. Similar decisions can be made by comparing a confidence limit against a concentration limit. This practice focuses on making environmental decisions using this kind of statistical comparison. Other factors, such as any qualitative information that also may be important to decision making, are not considered in the practice. This standard derives the decision point and confidence limit in the framework of a statistical test of hypothesis under three different presumptions. The relationship between decision point and confidence limit also is described.

D 6282 Standard Guide for Direct Push Soil Sampling for Environmental Site Characterizations

This guide addresses direct push soil samplers, which may be driven into the ground from the surface or through pre-bored holes. The samplers can be continuous or discrete interval

units. The samplers are advanced to the depth of interest by a combination of static push, or impacts from hammers, or vibratory methods, or a combination thereof. Field methods described in this guide include the use of discreet and continuous sampling tools, split and solid barrel samplers and thin walled tubes with or without fixed piston style apparatus. Insertion methods described include static push, impact, percussion, other vibratory/sonic driving, and combinations of these methods using direct push equipment adapted to drilling rigs, cone penetrometer units, and specially designed percussion/direct push combination machines. Hammers described by this guide for providing force for insertion include drop style, hydraulically activated, air activated and mechanical lift devices. The guide does not cover open chambered samplers operated by hand such as augers, agricultural samplers operated at shallow depths, or side wall samplers.

D 6286 Standard Guide for Selection of Drilling Methods for Environmental Site Characterization

This guide provides descriptions of various drilling methods for environmental site characterization, along with the advantages and disadvantages associated with each method. This guide is intended to aid in the selection of drilling method(s) for environmental soil and rock borings and the installation of monitoring wells and other water-quality monitoring devices. This guide does not address methods of well construction, well development, or well completion.

D 6311 Standard Guide for Generation of Environmental Data Related to Waste Management Activities: Selection and Optimization of Sampling Design

This guide provides practical information on the selection and optimization of sample designs in waste management sampling activities, within the context of the requirements established by the data quality objectives or other planning process. Specifically, this document provides (1) guidance for the selection of sampling designs; (2) techniques to optimize candidate designs; and (3) descriptions of the variables that need to be balanced in choosing the final optimized design.

D 6323 Standard Guide for Laboratory Subsampling of Media Related to Waste Management Activities

This guide covers common techniques for obtaining representative subsamples from a sample received at a laboratory for analysis. These samples may include solids, sludges, liquids, or multilayered liquids (with or without solids). The procedures and techniques discussed in this guide depend upon the sample matrix, the type of sample preparation and analysis performed, the characteristic(s) of interest, and the project specific instructions or data quality objectives. This guide includes several sample homogenization techniques, including mixing and grinding, as well as information on how to obtain a specimen or split laboratory samples. This guide does not apply to air or gas sampling.

D 6418 Standard Practice for Using the Disposable EnCore™ Sampler for Sampling and Storing Soil for Volatile Organic Analysis

This practice provides a procedure for using the disposable EnCore™ sampler to collect and store a soil sample of approximately 5 grams or 25 grams for volatile organic analysis. The EnCore™ sampler is designed to collect and hold a soil sample during shipment to the

laboratory. It consists of a coring body/storage chamber, O-ring sealed plunger, and O-ring sealed cap. In performing the practice, the integrity of the soil sample structure is maintained and there is very limited exposure of the sample to the atmosphere. Laboratory subsampling is not required; the sample is expelled directly from the sampler body into the appropriate container for analysis.

D 6538 Standard Guide for Sampling Wastewater With Automatic Samplers

This guide covers the selection and use of automatic wastewater samplers including procedures for their use in obtaining representative samples. Automatic wastewater samplers are intended for the unattended collection of samples that are representative of the parameters of interest in the wastewater body. While this guide primarily addresses the sampling of wastewater, the same automatic samplers may be used to sample process streams and natural water bodies.

D 6582 Standard Guide for Ranked Set Sampling: Efficient Estimation of a Mean Concentration in Environmental Sampling

This guide describes ranked set sampling, discusses its relative advantages over simple random sampling, and provides examples of potential applications in environmental sampling. Ranked set sampling is useful and cost-effective when there is an auxiliary variable, which can be inexpensively measured relative to the primary variable, and when the auxiliary variable has correlation with the primary variable. The resultant estimation of the mean concentration is unbiased, more precise than simple random sampling, and more representative of the population under a wide variety of conditions.

D 6771 Standard Practice for Low-Flow Purging and Sampling for Wells and Devices Used for Ground-Water Quality Investigations

This practice covers the method for purging and sampling wells and devices used for ground-water quality investigations and monitoring programs known as low-flow purging and sampling. The method is also known by the terms minimal drawdown purging or low-stress purging. The method could be used for other types of ground-water sampling programs but these uses are not specifically addressed in this practice. This practice applies only to wells sampled at the wellhead. This practice does not address sampling of wells containing either light or dense non-aqueous-phase liquids (LNAPLs or DNAPLs).

E 122 Standard Practice for Choice of Sample Size to Estimate the Average for a Characteristic of a Lot or Process

This practice covers methods for calculating the sample size (the number of units to include in a random sample from a lot of material) in order to estimate, with a prescribed precision, an average of some characteristic for that lot or process. The characteristic may be either a numerical value of some property or the fraction of nonconforming units with respect to an attribute. If sampling from a process, the process must be in a state of statistical control for the results to have predictive value.

E 178 Standard Practice for Dealing with Outlying Observations

This practice covers outlying observations in samples and how to test the statistical significance

Appendix J

of them. An outlying observation, or "outlier," is an observation that appears to deviate markedly from other members of the sample in which it occurs. An outlying observation may be merely an extreme manifestation of the random variability inherent in the data. If this is true, the value should be retained and processed in the same manner as the other observations in the sample. On the other hand, an outlying observation may be the result of gross deviation from prescribed experimental procedure or an error in calculating or recording the numerical value. In such cases, it may be desirable to institute an investigation to ascertain the reason for the aberrant value. The observation may even actually be rejected as a result of the investigation, though not necessarily so. At any rate, in subsequent data analysis the outlier or outliers probably will be recognized as being from a different population than that of the other sample values. The procedures covered herein apply primarily to the simplest kind of experimental data; that is, replicate measurements of some property of a given material, or observations in a supposedly single random sample. Nevertheless, the tests suggested do cover a wide enough range of cases in practice to have broad utility.

E 300 Standard Practice for Sampling Industrial Chemicals

This practice covers procedures for sampling several classes of industrial chemicals, as well as recommendations for determining the number and location of such samples to ensure representativeness in accordance with accepted probability sampling principles. Although this practice describes specific procedures for sampling various liquids, solids, and slurries, in bulk or in packages, these recommendations only outline the principles to be observed. They should not take precedence over specific sampling instructions contained in other ASTM product or method standards.

E 1402 Standard Terminology Relating to Sampling

This standard includes those items related to statistical aspects of sampling. It is applicable to sampling in any matrix and provides definitions, descriptions, discussions, and comparisons of trends.

E 1727 Standard Practice for Field Collection of Soil Samples for Lead Determination by Atomic Spectrometry Techniques

This practice covers the collection of soil samples using coring and scooping methods. Soil samples are collected in a manner that will permit subsequent digestion and determination of lead using laboratory analysis techniques such as Inductively Coupled Plasma Atomic Emission Spectrometry (ICP-AES), Flame Atomic Absorption Spectrometry (FAAS), and Graphite Furnace Atomic Absorption Spectrometry (GFAAS).

F 301 Standard Practice for Open Bottle Tap Sampling of Liquid Streams

This practice covers a general method to take samples of liquid streams in such a way so that the samples are representative of the liquid in the sampled stream and that the sample acquisition process does not interfere with any operations taking place in the stream. The practice is particularly applicable for sampling the feed and filtrate streams around a filter medium. The practice includes consideration of potential limits in the sample size or sample flow rate observation capability of the device used to measure particle content in the sample.

REFERENCES

Note: Due to the dynamic nature of the Internet, the location and content of World Wide Web sites given in this document may change over time. If you find a broken link to an EPA document, use the search engine at <http://www.epa.gov/> to find the document. Links to web sites outside the U.S. EPA web site are provided for the convenience of the user, and the U.S. EPA does not exercise any editorial control over the information you may find at these external web sites.

- Air Force Center for Environmental Excellence (AFCEE). 1995. "Disposal of Construction and Demolition Debris." Pro-Act Fact Sheet TI5040. Brooks Air Force Base, TX.
- American Society for Quality (ASQ). 1988. *Sampling Procedures and Tables for Inspection of Isolated Lots by Attributes*. American National Standard ANSI/ASQC Standard Q3-1988. Milwaukee, Wisconsin.
- ASQ. 1993. *Sampling Procedures and Tables for Inspection By Attributes*. American National Standard ANSI/ASQC Z1.4-1993. Milwaukee, Wisconsin.
- American Society for Testing and Materials (ASTM) D 1452-80. 1980. *Standard Practice for Soil Investigation and Sampling by Auger Borings*. West Conshohocken, PA.
<http://www.astm.org/>
- ASTM D 1586-84. 1984. *Standard Test Method for Penetration Test and Split-Barrel Sampling of Soils*. West Conshohocken, PA.
- ASTM D 1587-94. 1994. *Standard Practice for Thin-Walled Tube Geotechnical Sampling of Soils*. West Conshohocken, PA.
- ASTM D 3665-95. 1995. *Standard Practice for Random Sampling of Construction Materials*. West Conshohocken, PA.
- ASTM D 4220-95. 1995. *Standard Practices for Preserving and Transporting Soil Samples*. West Conshohocken, PA.
- ASTM D 4342-84. 1984. *Standard Practice for Collecting of Benthic Macroinvertebrates with Ponar Grab Sampler*. West Conshohocken, PA.
- ASTM D 4387-97. *Standard Guide for Selecting Grab Sampling Devices for Collecting Benthic Macroinvertebrates*. West Conshohocken, PA.
- ASTM D 4448-85a. 1985. *Standard Guide for Sampling Groundwater Monitoring Wells*. West Conshohocken, PA.
- ASTM D 4489-95. 1995. *Standard Practices for Sampling of Waterborne Oils*. West Conshohocken, PA.
- ASTM D 4547-98. 1998. *Standard Guide for Sampling Waste and Soils for Volatile Organics*. West Conshohocken, PA.

References

- ASTM D 4700-91. 1991. *Standard Guide for Soil Sampling from the Vadose Zone*. West Conshohocken, PA.
- ASTM D 4823-95. 1995. *Standard Guide for Core Sampling Submerged, Unconsolidated Sediments*. West Conshohocken, PA.
- ASTM D 4840-95. 1995. *Standard Guide for Sampling Chain-of-Custody Procedures*. West Conshohocken, PA.
- ASTM D 5013-89. 1989. *Standard Practices for Sampling Wastes from Pipes and Other Point Discharges*. West Conshohocken, PA.
- ASTM D 5088-90. 1990. *Standard Practice for Decontamination of Field Equipment Used at Nonradioactive Waste Sites*. West Conshohocken, PA.
- ASTM D 5092-90. 1990. *Standard Practice for Design and Installation of Ground Water Monitoring Wells in Aquifers*. West Conshohocken, PA.
- ASTM D 5283-92. 1992. *Standard Practice for Generation of Environmental Data Related to Waste Management Activities Quality Assurance and Quality Control Planning and Implementation*. West Conshohocken, PA.
- ASTM D 5314-92. 1992. *Standard Guide for Soil Gas Monitoring in the Vadose Zone*. West Conshohocken, PA.
- ASTM D 5358-93. 1993. *Standard Practice for Sampling with a Dipper or Pond Sampler*. West Conshohocken, PA.
- ASTM D 5387-93. 1993. *Standard Guide for Elements of a Complete Data Set for Non-Cohesive Sediments*. West Conshohocken, PA.
- ASTM D 5451-93. 1993. *Standard Practice for Sampling Using a Trier Sampler*. West Conshohocken, PA.
- ASTM D 5495-94. 1994. *Standard Practice for Sampling with a Composite Liquid Waste Sampler (COLIWASA)*. West Conshohocken, PA.
- ASTM D 5633-94. 1994. *Standard Practice for Sampling with a Scoop*. West Conshohocken, PA.
- ASTM D 5658-95. 1995. *Standard Practice for Sampling Unconsolidated Waste from Trucks*. West Conshohocken, PA.
- ASTM D 5679-95a. 1995. *Standard Practice for Sampling Consolidated Solids in Drums or Similar Containers*. West Conshohocken, PA.
- ASTM D 5680-95a. 1995. *Standard Practice for Sampling Unconsolidated Solids in Drums or Similar Containers*. West Conshohocken, PA.

- ASTM D 5730-96. 1996. *Standard Guide for Site Characterization for Environmental Purposes with Emphasis on Soil, Rock, the Vadose Zone and Ground Water*. West Conshohocken, PA.
- ASTM D 5743-97. 1997. *Standard Practice for Sampling Single or Multilayered Liquids, With or Without Solids, in Drums or Similar Containers*. West Conshohocken, PA.
- ASTM D 5792-95. 1995. *Standard Practice for Generation of Environmental Data Related to Waste Management Activities: Development of Data Quality Objectives*. West Conshohocken, PA.
- ASTM D 5956-96. 1996. *Standard Guide for Sampling Strategies for Heterogeneous Waste*. West Conshohocken, PA.
- ASTM D 6009-96. 1996. *Standard Guide for Sampling Waste Piles*. West Conshohocken, PA.
- ASTM D 6044-96. 1996. *Standard Guide for Representative Sampling for Management of Waste and Contaminated Media*. West Conshohocken, PA.
- ASTM D 6051-96. 1996. *Standard Guide for Composite Sampling and Field Subsampling for Environmental Waste Management Activities*. West Conshohocken, PA.
- ASTM D 6063-96. 1996. *Standard Guide for Sampling of Drums and Similar Containers by Field Personnel*. West Conshohocken, PA.
- ASTM D 6169-98. 1998. *Standard Guide for Selection of Soil and Rock Sampling Devices Used With Drill Rigs for Environmental Investigations*. West Conshohocken, PA.
- ASTM D 6232-98. 1998. *Standard Guide for Selection of Sampling Equipment for Waste and Contaminated Media Data Collection Activities*. West Conshohocken, PA.
- ASTM D 6233-98. 1998. *Standard Guide for Data Assessment for Environmental Waste Management Activities*. West Conshohocken, PA.
- ASTM D 6250-98. 1998. *Standard Practice for Derivation of Decision Point and Confidence Limit for Statistical Testing of Mean Concentration in Waste Management Decisions*. West Conshohocken, PA.
- ASTM D 6282-98. 1998. *Standard Guide for Direct Push Soil Sampling for Environmental Site Characterizations*. West Conshohocken, PA.
- ASTM D 6286-98. 1998. *Standard Guide for Selection of Drilling Methods for Environmental Site Characterization*. West Conshohocken, PA.
- ASTM D 6311-98. 1998. *Standard Guide for Generation of Environmental Data Related to Waste Management Activities: Selection and Optimization of Sampling Design*. West Conshohocken, PA.

References

- ASTM D 6323-98. 1998. *Standard Guide for Laboratory Subsampling of Media Related to Waste Management Activities*. West Conshohocken, PA.
- ASTM D 6418-99. 1999. *Standard Practice for Using the Disposable EnCore™ Sampler for Sampling and Storing Soil for Volatile Organic Analysis*. West Conshohocken, PA.
- ASTM E 1727-95. 1995. *Standard Practice for Field Collection of Soil Samples for Lead Determination by Atomic Spectrometry Techniques*. West Conshohocken, PA.
- Barth, D.S., B.J. Mason, T.H. Starks, and K.W. Brown. 1989. *Soil Sampling Quality Assurance User's Guide*. 2nd ed. EPA 600/8-89/046. NTIS PB89-189864. Environmental Monitoring Systems Laboratory. Las Vegas, NV.
- Blacker, S. and D. Goodman. 1994a. "An Integrated Approach for Efficient Site Cleanup." *Environmental Science & Technology* 28(11).
- Blacker, S. and D. Goodman. 1994b. "Case Study: Application at a Superfund Site." *Environmental Science & Technology* 28(11).
- Cameron, K. 1999. Personal communication between Dr. Kirk Cameron (Statistical Scientist, MacStat Consulting, Ltd.) and Bob Stewart (Science Applications International Corporation), March 9.
- Cochran, W.G. 1977. *Sampling Techniques*. 3rd ed. New York: John Wiley & Sons, Inc.
- Cohen, A.C., Jr. 1959. "Simplified Estimator for the Normal Distribution When Samples Are Single Censored or Truncated." *Technometrics* 1:217-37.
- Conover, W.J. 1999. *Practical Nonparametric Statistics, Third Edition*. New York: John Wiley & Sons, Inc.
- Crockett, A.B., H.D. Craig, T.F. Jenkins, and W.E. Sisk. 1996. *Field Sampling and Selecting On-Site Analytical Methods For Explosives in Soil*. EPA/540/R-97/501. Office of Research and Development and Office of Solid Waste and Emergency Response. Washington, DC.
- Crumbling, D.M. Current Perspectives in Site Remediation and Monitoring: Clarifying DQO Terminology Usage to Support Modernization of Site Cleanup Practice. EPA542-R-01-014. Office of Solid Waste and Emergency Response, Technology Innovation Office. October.
- Department of Defense (DoD). 1996. DOD Preferred Methods for Acceptance of Product. Department of Defense Test Method Standard MIL-STD-1916 (April).
- Edland, S.D. and G. van Belle. 1994. *Decreased Sampling Costs and Improved Accuracy with Composite Sampling in Environmental Statistics, Assessment and Forecasting*. Boca Raton, FL: Lewis Publishers.
- Edmondson, B. 1996. "How to Spot a Bogus Poll." *American Demographics*. October.

- Efron, B. 1981. "Nonparametric Estimates of Standard Error: The Jackknife, the Bootstrap, and Other Resampling Plans," *Biometrika. Transactions on Reliability*, 40, 547-552.
- Exner, J.H., W.D. Keffer, R.O. Gilbert, and R.R. Kinnison. 1985. "A Sampling Strategy for Remedial Action at Hazardous Waste Sites: Clean-up Soil Contaminated by Tetrachlorodibenzo-p-Dioxin." *Hazardous Waste & Hazardous Materials* 2(2):503-21.
- Fabrizio, M.C., A.M. Frank, and J.F. Savino. 1995. "Procedures for Formation of Composite Samples from Segmented Populations." *Environmental Science & Technology* 29(5):1137-44.
- Federal Remediation Technologies Roundtable (FRTR). 1999. <http://www.frtr.gov/>
- Filliben, J.J. 1975. "The Probability Plot Correlation Coefficient Test for Normality." *Technometrics* 17:111-17.
- Flatman, G.T. and A.A. Yfantis. 1996. "Geostatistical Sampling Designs for Hazardous Waste Sites." *Principles of Environmental Sampling*. 2nd ed. L.H. Keith, ed. Washington, DC: American Chemical Society.
- Garner, F.C., M.A. Stapanian, and L.R. Williams. 1988. "Composite Sampling for Environmental Monitoring." *Principles of Environmental Sampling*, L.H. Kieth, ed. Washington, DC: American Chemical Society.
- Garner, F.C., M.A. Stapanian, E.A. Yfantis, and L.R. Williams. 1989. "Probability Estimation with Sample Compositing Techniques." *Journal of Official Statistics* 5(4):365-74.
- Gerlach, R.W., D.E. Dobb, G.A. Raab, and J.M. Nocerino. 2002. Gy Sampling Theory in Environmental Studies. 1. Assessing Soil Splitting Protocols. *Journal of Chemometrics*. 16: 321-328. Jon Wiley & Sons, Ltd.
- Gilbert, R.O. 1987. *Statistical Methods for Environmental Pollution Monitoring*. New York: Van Nostrand Reinhold.
- Gilliom, R.J. and D.R. Helsel. 1986. "Estimation of Distributional Parameters for Censored Trace Level Water Quality Data: Part I Estimation Techniques." *Water Resources Research* 22(2):135-46.
- Guttman, I. 1970. *Statistical Tolerance Regions: Classical and Bayesian*. London: Charles Griffin & Co.
- Gy, P. 1982. *Sampling of Particulate Materials: Theory and Practice*. 2nd ed. New York: Elsevier.
- Gy, P. 1998. *Sampling for Analytical Purposes*. Chichester, England: John Wiley & Sons, Inc.
- Hahn, G.J. and W.Q. Meeker. 1991. *Statistical Intervals: A Guide for Practitioners*. New York: John Wiley & Sons, Inc.

References

- Helsel, D.R. 1990. "Less than Obvious: Statistical Treatment of Data Below the Detection Limit." *Environmental Science & Technology* 24(12):1766-74.
- Ingamells, C.O. and F.F. Pitard. 1986. *Applied Geochemical Analysis*. Vol. 88. New York: John Wiley.
- Ingamells, C.O. 1974. "New Approaches to Geochemical Analysis and Sampling." *Talanta* 21:141-55.
- Ingamells, C.O. and P. Switzer. 1973. "A Proposed Sampling Constant for Use in Geochemical Analysis." *Talanta* 20:547-68.
- Isaaks, E.H. and R.M. Srivastava. 1989. *An Introduction to Applied Geostatistics*. New York: Oxford University Press.
- Jenkins, T.F., C.L. Grant, G.S. Brar, P.G. Thorne, T.A. Ranney, and P.W. Schumacher. 1996. *Assessment of Sampling Error Associated with Collection and Analysis of Soil Samples at Explosives-Contaminated Sites*. Special Report 96-15. September. U.S. Army Corps of Engineers Cold Regions Research and Engineering Laboratory (USACE CRREL). Hanover, NH.
http://www.crrel.usace.army.mil/techpub/CRREL_Reports/reports/SR96_15.pdf
- Jenkins, T.F., M.E. Walsh, P.G. Thorne, S. Thiboutot, G. Ampleman, T.A. Ranney, and C.L. Grant. 1997. *Assessment of Sampling Error Associated with Collection and Analysis of Soil Samples at a Firing Range Contaminated with HMX*. Special Report 97-22. September. USACE CRREL. Hanover, NH.
http://www.crrel.usace.army.mil/techpub/CRREL_Reports/reports/SR97_22.pdf
- Jessen, R.J. 1978. *Statistical Survey Techniques*. New York: John Wiley & Sons, Inc.
- Journel, A.G. 1988. "Non-parametric Geostatistics for Risk and Additional Sampling Assessment." *Principles of Environmental Sampling*. L.H. Keith, ed. Washington, DC: American Chemical Society.
- Keith, L.H., ed. 1996. *Principles of Environmental Sampling*. 2nd ed. Washington, DC: American Chemical Society.
- King, J.A. 1993. "Wastewater Sampling." *The National Environmental Journal* 3(1).
- Koski, W.M., R. Troast, and W. Keffer. 1991. "Contaminated Structures and Debris—Site Remediation." In: *Hazardous Materials Control/Superfund '91 - Proceedings of the 12th National Conference*. Hazardous Materials Control Research Institute. Greenbelt, MD.
- Land, C.E. 1971. "Confidence Intervals for Linear Functions of the Normal Mean and Variance." *The Annals of Mathematical Statistics* 42:1187-1205.
- Land, C.E. 1975. "Tables of Confidence Limits for Linear Functions of the Normal Mean and Variance." In: *Selected Tables in Mathematical Statistics*. Vol III. Providence, RI: American Mathematical Society.

- Madansky, A. 1988. *Prescription for Working Statisticians*. New York: Springer-Verlag.
- Mason, B.J. 1992. *Preparation of Soil Sampling Protocols: Sampling Techniques and Strategies*. EPA/600/R-92/128. NTIS PB 92-220532. U.S. Environmental Protection Agency, Office of Research and Development. Las Vegas, NV.
<http://www.epa.gov/swerust1/cat/mason.pdf>
- McIntyre, G.A. 1952. "A Method for Unbiased Selective Sampling Using Ranked Sets." *Australian Journal of Agricultural Research* 3:385-390.
- Miller, R. 1974. "The Jackknife - A Review," *Biometrika*, 61, 1-15.
- Miller, R.G., Jr. 1986. *Beyond ANOVA, Basics of Applied Statistics*. New York: John Wiley & Sons.
- Myers, J.C. 1997. *Geostatistical Error Management: Quantifying Uncertainty for Environmental Sampling and Mapping*. New York: Van Nostrand Reinhold.
- Natrella, M.G. 1966. *Experimental Statistics*. National Bureau of Standards Handbook 91. United States Department of Commerce. Washington, DC.
- Neptune, D., E.P. Brantly, M.J. Messner, and D.I. Michael. 1990. "Quantitative Decision Making in Superfund: A Data Quality Objectives Case Study." *Hazardous Materials Control* 44(2):358-63.
- Newman, M.C., K.D. Greene, and P.M. Dixon. 1995. UnCensor Version 4.0. University of Georgia, Savannah River Ecology Laboratory. Aiken, SC. UnCensor is public domain software. http://www.vims.edu/env/research/risk/software/vims_software.htm
- Occupational Safety and Health Administration (OSHA). 1985. *Occupational Safety and Health Guidance Manual for Hazardous Waste Site Activities*. Revised 1998. Prepared by the National Institute for Occupational Safety and Health, the Occupational Safety and Health Administration, the U.S. Coast Guard, and the U.S. Environmental Protection Agency. Washington, DC.
- Ott, L. 1988. *An Introduction to Statistical Methods and Data Analysis*. 3rd ed. Boston: PWS-Kent Publishing Co.
- Perez, A. and J. Lefante. 1996. "How Much Sample Size Is Required To Estimate the True Arithmetic Mean of a Lognormal Distribution?" In: Proceedings from the 1996 Joint Statistical Meetings in Chicago. American Statistical Association. Alexandria, VA.
- Perez, A. and J. Lefante. 1997. "Sample Size Determination and the Effect of Censoring When Estimating the Arithmetic Mean of a Lognormal Distribution." *Communications in Statistics—Theory and Methods* 26(11):2779-2801.
- Pitard, F.F. 1989. *Pierre Gy's Sampling Theory and Sampling Practice*. Vols. 1 and 2. Boca Raton, FL: CRC Press LLC.

References

- Pitard, F.F. 1993. *Pierre Gy's Sampling Theory and Sampling Practice: Heterogeneity, Sampling Correctness, and Statistical Process Control*. 2nd ed. Boca Raton, FL: CRC Press LLC.
- Porter, P.S, S.T. Rao, J.Y. Ku, R.L. Poirot, and M. Dakins. 1997. "Small Sample Properties of Nonparametric Bootstrap t Confidence Intervals—Technical Paper." *Journal of the Air & Waste Management Association* 47:1197-1203.
- Puls, R.W. and M.J. Barcelona. 1996. *Low-Flow (Minimal Drawdown) Ground-Water Sampling Procedures*. EPA/540/S-95/504. U.S. Environmental Protection Agency, Office of Research and Development, Office of Solid Waste and Emergency Response. Washington, DC. <http://www.epa.gov/r10earth/offices/oea/gwf/lwflw2a.pdf>
- Ramsey, C.A., M.E. Ketterer, and J.H. Lowry. 1989. "Application of Gy's Sampling Theory to the Sampling of Solid Waste Materials." In: Proceedings of the EPA Fifth Annual Waste Testing and Quality Assurance Symposium, Vol. II. U.S. Environmental Protection Agency. Washington, DC.
- Rendu, J-M. 1980. *Optimization of Sampling Policies: A Geostatistical Approach*. Tokyo: MMIJ-AIME.
- Rupp, G. 1990. *Debris Sampling at NPL Sites—Draft Interim Report*. Prepared for the U.S. Environmental Protection Agency, Exposure Assessment Division, Environmental Monitoring Systems Laboratory, Las Vegas, by the Environmental Research Center, University of Nevada, Las Vegas, NV, under Cooperative Agreement Number 814701.
- Ryan, T.A. and B.L. Joiner. 1990. "Normal Probability Plots and Tests for Normality." *Minitab Statistical Software: Technical Reports* November 1-1 to 1-14.
- Schilling, E.G. 1982. *Acceptance Sampling in Quality Control*. Marcel Dekker. NY.
- Schulman, R.S. 1992. *Statistics in Plain English with Computer Applications*. New York: Van Nostrand Reinhold.
- Schumacher, B.A., Shines, K.C., Burton, J.V. and Papp, M.L. 1991. "A Comparison of Soil Sample Homogenization Techniques." In: *Hazardous Waste Measurements*. M.S. Simmons, ed. Boca Raton, FL: Lewis Publishers.
- Shapiro, S.S. and R.S. Francia. 1972. "An Approximate Analysis of Variance Test for Normality." *Journal of American Statistical Association* 67(337):215-16.
- Shapiro, S.S. and M.B. Wilk. 1965. "An Analysis of Variance Test for Normality (Complete Samples)." *Biometrika* 52:591-611.
- Shefsky, S. 1997. "Sample Handling Strategies for Accurate Lead-In-Soil Measurements in the Field and Laboratory." Presented at the International Symposium of Field Screening Methods Hazardous Wastes and Toxic Chemicals, Las Vegas, NV.

- Singh, A.K., A. Singh, and M. Engelhardt. 1997. *The Lognormal Distribution in Environmental Applications*. EPA/600/R-97/006. U.S. Environmental Protection Agency, Office of Research and Development. Washington, DC.
<http://www.epa.gov/nerlesd1/pdf/lognor.pdf>
- Skalski, J.R. and J.M. Thomas. 1984. *Improved Field Sampling Designs and Compositing Schemes for Cost Effective Detection of Migration and Spills at Commercial Low-level Radioactive or Chemical Wastes Sites*. PNL-4935. Battelle Pacific Northwest Laboratory. Richland, WA.
- United States Department of Energy (USDOE). 1996. "Statistical Methods for the Data Quality Objective Process." In: *DQO Statistics Bulletin* vol. 1. PNL-SA-26377-2. Prepared by Joanne Wendelberger, Los Alamos National Laboratory, for the U.S. Department of Energy. Washington, DC.
- United States Environmental Protection Agency (USEPA). 1980. *Samplers and Sampling Procedures for Hazardous Waste Streams*. EPA-600/2-80-018. Municipal Environmental Research Laboratory. Cincinnati, OH.
- USEPA. 1984. *Characterization of Hazardous Waste Sites—A Methods Manual. Volume I Site Investigations*. EPA/600/4-84-075. Environmental Monitoring Systems Laboratory, Office of Research and Development, Las Vegas, NV. (Available on CD-ROM. See USEPA 1998c)
- USEPA. 1985. *Characterization of Hazardous Waste Sites—A Methods Manual. Volume II: Available Sampling Methods*. EPA/600/4-84-076. Environmental Monitoring Systems Laboratory, Office of Research and Development, Las Vegas, NV. (Available on CD-ROM. See USEPA 1998c)
- USEPA. 1986a. *Test Methods for Evaluating Solid Waste, Physical/Chemical Methods, Updates I, II, IIA, IIB, III, and IIIA*. SW-846. NTIS publication no. PB97-156111 or GPO publication no. 955-001-00000-1. Office of Solid Waste. Washington, DC.
<http://www.epa.gov/epaoswer/hazwaste/test/sw846.htm>
- USEPA. 1986b. *Permit Guidance Manual on Unsaturated Zone Monitoring for Hazardous Waste Land Treatment Units*. EPA/530-SW-86-040. Washington, DC.
- USEPA. 1987. RCRA Guidance Manual for Subpart G Closure and Post-Closure Care Standards and Subpart H Cost Estimating Requirements. 530-SW-87-010 (NTIS: PB87-158 978).
- USEPA. 1988. *Methodology for Developing Best Demonstrated Available (BDAT) Treatment Standards*. EPA/530-SW-89-017L. Treatment Technology Section, Office of Solid Waste. Washington, DC.
- USEPA. 1989a. *Methods for Evaluating the Attainment of Cleanup Standards. Volume 1: Soils and Solid Media*. EPA 230/02-89-042. NTIS PB89-234959. Statistical Policy Branch, Office of Policy, Planning, and Evaluation. Washington, DC.
<http://www.epa.gov/tio/stats/vol1soils.pdf>

References

- USEPA, 1989b, *Statistical Analysis of Ground-Water Monitoring Data at RCRA Facilities (Interim Final Guidance)*. Office of Solid Waste (NTIS, PB89-151047).
- USEPA. 1989c. *RCRA Facility Investigation Guidance*. Vols. 1 - 4. EPA 530/SW-89-031. OSWER Directive 9502.00-6D. NTIS PB89-200299. Office of Solid Waste. Washington, DC. (Available on CD-ROM. See USEPA 1998g.)
- USEPA. 1990. "Corrective Action for Solid Waste Management Units at Hazardous Waste Management Facilities: Proposed Rule." *Federal Register* (55 FR 30798, July 27, 1990).
- USEPA. 1991a. *GEO-EAS 1.2.1 User's Guide*. EPA/600/8-91/008. Environmental Monitoring Systems Laboratory, Las Vegas, NV.
- USEPA. 1991b. *Description and Sampling of Contaminated Soils—A Field Pocket Guide*. EPA/625/12-91/002. Center for Environmental Research Information. Cincinnati, OH.
- USEPA. 1991c. *Final Best Demonstrated Available Technology (BDAT) Background Document for Quality Assurance/Quality Control Procedures and Methodology*. NTIS PB95-230926. Office of Solid Waste. Washington, DC.
- USEPA. 1991d. *Site Characterization for Subsurface Remediation*. EPA/625/4-91/026. Office of Research and Development. Washington, DC.
- USEPA. 1992a. *Supplemental Guidance to RAGS: Calculating the Concentration Term 1(1)*. OERR Publication 9285.7-08I. NTIS PB92-963373. Office of Emergency and Remedial Response. Cincinnati, OH.
- USEPA. 1992b. *Statistical Analysis of Ground-Water Monitoring Data at RCRA Facilities Addendum to Interim Final Guidance (July 1992)*. Office of Solid Waste. <http://www.epa.gov/epaoswer/hazwaste/ca/resource/guidance/sitechar/gwstats/gwstats.htm>
- USEPA. 1992c. *RCRA Ground-Water Monitoring: Draft Technical Guidance*. EPA/530/R-93/001. Office of Solid Waste. Washington, DC.
- USEPA. 1992d. *Specifications and Guidance for Contaminant-Free Sample Containers*. Publication 9240.05A. EPA/540/R-93/051.
- USEPA. 1992e. *Multi-Media Investigation Manual*. EPA/330/9-89/003-R. National Enforcement Investigation Center. Denver, CO.
- USEPA. 1992f. *Management of Investigation-Derived Wastes*. Directive 9345.3-03FS. NTIS PB92-963353. Office of Solid Waste and Emergency Response. Washington, DC.
- USEPA. 1992g. *Guidance for Data Usability in Risk Assessment*. Final. 9285.7-09A and B. Office of Emergency and Remedial Response. Washington, DC.
- USEPA. 1992h. 40 CFR Parts 268 and 271 Land Disposal Restrictions No Migration Variances; Proposed Rule. *Federal Register*: August 11, 1992.

References

- USEPA. 1992i. *Methods for Evaluating the Attainment of Cleanup Standards. Volume 2: Ground Water*. EPA 230-R-92-14. Office of Policy, Planning, and Evaluation. Washington, DC.
- USEPA. 1993a. *Data Quality Objectives Process for Superfund*. Interim Final Guidance. EPA/540.G-93/071. Office of Solid Waste and Emergency Response. Washington, DC.
- USEPA. 1993b. *Guidance Specifying Management Measures for Sources of Nonpoint Pollution in Coastal Waters*. EPA-840-B-93-001c. Office of Water. Washington, DC.
- USEPA. 1993c. *Subsurface Characterization and Monitoring Techniques—A Desk Reference Guide*. Vols. 1 and 2. EPA/625/R-93/003a and EPA/625/R-93/003b. Office of Research and Development. Washington, DC.
- USEPA. 1993d. *Petitions to Delist Hazardous Waste—A Guidance Manual*. 2nd ed. EPA 530-R-93-007. NTIS PB 93-169365. Office Of Solid Waste. Washington, DC.
- USEPA. 1994a. *Waste Analysis at Facilities That Generate, Treat, Store, and Dispose of Hazardous Wastes, a Guidance Manual*. OSWER 9938.4-03. Office of Solid Waste and Emergency Response. Washington, DC.
<http://www.epa.gov/epaoswer/hazwaste/ldr/wap330.pdf>
- USEPA. 1994b. “Drum Sampling.” Environmental Response Team SOP #2009, Revision #0.0. Edison, NJ. <http://www.ert.org/>
- USEPA. 1994c. “Tank Sampling.” Environmental Response Team SOP #2010, Revision #0.0. Edison, NJ. <http://www.ert.org/>
- USEPA. 1994d. “Waste Pile Sampling.” Environmental Response Team SOP #2017, Revision #0.0. Edison, NJ. <http://www.ert.org/>
- USEPA. 1994e. “Sediment Sampling.” Environmental Response Team SOP #2016, Revision #0.0. Edison, NJ. <http://www.ert.org/>
- USEPA. 1994f. “Sampling Equipment Decontamination.” Environmental Response Team SOP #2006, Revision #0.0. Edison, NJ. <http://www.ert.org/>
- USEPA. 1995a. *Determination of Background Concentrations of Inorganics in Soils and Sediment at Hazardous Waste Sites*. EPA/540/S-96/500. Office of Research and Development and Office of Solid Waste and Emergency Response. Washington, DC.
<http://www.epa.gov/nerlesd1/pdf/engin.pdf>
- USEPA. 1995b. *EPA Observational Economy Series, Volume 2: Ranked Set Sampling*. EPA/230-R-95-006. Office of Policy Planning and Evaluation. Washington, DC.
- USEPA. 1995c. *EPA Observational Economy Series, Volume 1: Composite Sampling*. EPA-230-R-95-005. Office of Policy Planning and Evaluation. Washington, DC.
- USEPA. 1995d. *QA/QC Guidance for Sampling and Analysis of Sediments, Water, and Tissues for Dredged Material Evaluations*. EPA/823-B-95-001.

References

- USEPA. 1995e. *Superfund Program Representative Sampling Guidance Volume 5: Water and Sediment, Part I—Surface Water and Sediment*. Interim Final Guidance. Environmental Response Team. Office of Emergency and Remedial Response and Office of Solid Waste and Emergency Response. Washington, DC.
- USEPA. 1995f. *Guidance for the Sampling and Analysis of Municipal Waste Combustion Ash for the Toxicity Characteristic*. Office of Solid Waste. EPA 530-R-95-036.
- USEPA. 1996a. *Soil Screening Guidance User's Guide* (9355.4-23). Office of Solid Waste and Emergency Response. Washington, DC.
<http://www.epa.gov/superfund/resources/soil/index.htm>
- USEPA. 1996b. *Environmental Investigations Standard Operating Procedures and Quality Assurance Manual*. Region 4, Science and Ecosystem Support Division. Athens, GA.
<http://www.epa.gov/region04/sesd/eisopqam/eisopqam.html>
- USEPA. 1996c. "Soil Gas Sampling." Environmental Response Team SOP #2042, Revision #0.0. Edison, NJ.
- USEPA. 1996d. *Region 6 RCRA Delisting Program Guidance Manual for the Petitioner*. Region 6, RCRA Multimedia Planning and Permitting Division, Dallas, TX. (Updated March 23, 2000).
- USEPA. 1997a. "Geostatistical Sampling and Evaluation Guidance for Soils and Solid Media." Draft. Prepared by Dr. Kirk Cameron, MacStat Consulting, Ltd. and SAIC for the Office of Solid Waste under EPA contract 68-W4-0030. Washington, DC.
- USEPA. 1997b. *Data Quality Assessment Statistical Toolbox (DataQUEST), EPA QA/G-9D*. User's Guide and Software. EPA/600/R-96/085. Office of Research and Development. Las Vegas. <http://www.epa.gov/quality/dqa.html>
- USEPA. 1998a. *EPA Guidance for Quality Assurance Project Plans, EPA QA/G-5*. EPA/600/R-98/018. Office of Research and Development. Washington, DC.
<http://www.epa.gov/quality/qs-docs/g5-final.pdf>
- USEPA. 1998b. *Final Technical Support Document for HWC MACT Standards, Volume VI Development of Comparable Fuels Standards*. Office of Solid Waste and Emergency Response, Washington, D.C. (May 1998).
- USEPA. 1998c. *Site Characterization Library, Volume 1*. Release 2. EPA/600/C-98/001. Office of Research and Development, National Exposure Research Laboratory (NERL). Las Vegas, NV.
- USEPA. 2000a. *Guidance for the Data Quality Objectives Process for Hazardous Waste Site Operations EPA QA/G-4HW*, EPA/600/R-00/007. Quality Staff, Office of Environmental Information, United States Environmental Protection Agency, Washington, D.C. January 2000. <http://www.epa.gov/quality/qs-docs/g4hw-final.pdf>

- USEPA. 2000b. *Guidance for the Data Quality Objectives Process EPA QA/G-4*, EPA/600/R-96/055. Quality Staff, Office of Environmental Information, United States Environmental Protection Agency, Washington, D.C. August 2000. <http://www.epa.gov/quality/qs-docs/g4-final.pdf>
- USEPA. 2000c. *Guidance for Choosing a Sampling Design for Environmental Data Collection*, EPA QA/G-5S. PEER REVIEW DRAFT. Quality Staff, Office of Environmental Information, United States Environmental Protection Agency, Washington, D.C. August 2000.
- USEPA. 2000d. *Guidance for Data Quality Assessment, EPA QA/G-9 (QA00 Update)*. Quality Staff, Office of Environmental Information, United States Environmental Protection Agency, Washington, D.C. July 2000. <http://www.epa.gov/quality1/qs-docs/g9-final.pdf>
- USEPA. 2001a. *Data Quality Objectives Decision Error Feasibility Trials Software (DEFT) - User's Guide*. EPA/240/B-01/007. (User's guide and software) Office of Environmental Information. Washington, DC. http://www.epa.gov/quality/qa_docs.html
- USEPA. 2001b. *EPA Requirements for Quality Assurance Project Plans, EPA QA/R-5*. EPA/240/B-01/003. Office of Environmental Information. Washington, DC. http://www.epa.gov/quality/qa_docs.html
- USEPA. 2001c. *Guidance on Environmental Data Verification and Data Validation EPA QA/G-8*. Quality Staff, Office of Environmental Information, United States Environmental Protection Agency, Washington, D.C. PEER REVIEW DRAFT. June 2001.
- USEPA. 2001d. *Land Disposal Restrictions: Summary of Requirements*. EPA530-R-01-007. Office of Solid Waste and Emergency Response and Enforcement and Compliance Assurance. Revised August 2001.
- USEPA. 2001e. *Guidance on Data Quality Indicators EPA QA/G-5i*. PEER REVIEW DRAFT. Office of Environmental Information, Washington, D.C. September 2001.
- USEPA. 2001f. *EPA Requirements for Quality Management Plans, EPA QA/R-2*. EPA/240/B-01/002. Office of Environmental Information. Washington, DC. March. http://www.epa.gov/quality/qa_docs.html
- USEPA. 2001g. *Contract Laboratory Program (CLP) Guidance for Field Samplers - Draft Final*. OSWER 9240.0-35. EPA540-R-00-003. Office of Solid Waste and Emergency Response. June. <http://www.epa.gov/oerrpage/superfund/programs/clp/guidance.htm>
- USEPA. 2002a. *Guidance on Demonstrating Compliance With the Land Disposal Restrictions (LDR) Alternative Soil Treatment Standards, Final Guidance*. EPA530-R-02-003. Office of Solid Waste. July. http://www.epa.gov/epaoswer/hazwaste/ldr/soil_f4.pdf
- USEPA and USDOE. 1992. *Characterizing Heterogeneous Wastes: Methods and Recommendations*. EPA/600/R-92/033. NTIS PB 92-216894. EPA Office of Research and Development, Las Vegas, NV and USDOE Office of Technology Development, Washington, DC.

References

- van Ee, J.J., L.J. Blume, and T.H. Starks. 1990. *A Rationale for the Assessment of Errors in the Sampling of Soils*. EPA 600/4-90/013. Environmental Monitoring Systems Laboratory. Las Vegas, NV.
- Visman, J. 1969. "A General Sampling Theory. Materials Research and Standards." *MTRSA* 9(11):8-13.
- Wald, A. 1973. *Sequential Analysis*. New York: Dover Publications.
- Williams, L.R., R.W. Leggett, M.L. Espegren, and C.A. Little. 1989. "Optimization of Sampling for the Determination of Mean Radium 226 Concentration in Surface Soil." *Environmental Monitoring and Assessment* 12:83-96. Dordrecht, the Netherlands: Kluwer Academic Publishers.

INDEX

Note: **Bold** page numbers indicate where the primary discussion of the subject is given.

- Acceptance sampling, 27
- Accuracy, **22**, 57, 134, 157-158, 160
- Action level, 22, 31, **35**, 39-41, 45-47, 49, 51, 54, 61-63, 72, 78-79, 81-82, 84, 157, 163, 253, 278-282, 284, 296-297, 302
- Additivity of errors in sampling and analysis
 - of biases, 89
 - of variances, 89
- Alpha (α), **42**, 83
- Alternative hypothesis, **43**, 157
- Analytical methods, 1, 12, **36**, 40, 51, 70, 86-87, 108, 122, 131, 139, 144, 161, 164, 169
- Analytical design, 50, **51**, 183, 298
- Arithmetic mean, **77**, 165, 170, 187, 243
- ASTM, 2, 16, 17, 35, 60, 63-65, 69, 74, 84, 101, **103**, 106, 107, 122, 124-126, 130, 134-137, 157-159, 163-164, 166, 168-169, 175, 191-192, 195-196, 201-240
 - how to contact and obtain standards, 103
 - summaries of standards, 305-322
- Attribute, **27**, 39, 311, 321
- Auger, bucket, 100, 111-113, 115, **225-226**, 287-288
- Automatic sampler, 109-110, 159, **202**, 319, 321
- Auxiliary variable, 54, **60**, 321

- Background, 15, 24, 28, 33, 37, **41**, 42, 44, 181, 183
- Bacon bomb sampler, 109, 110, 115, **209**
- Bailer, 109, 110, 115, 230, **234-235**, 319
- Beta (β), **42**, 162
- Bias, **22-24**, 41, 49-50, 88-89, 95, 108, 118, 119, 123, 128, 141, 142, 144, 150, 157, 160, 164-165, 167-168, 200, 240, 249, 252, 274, 318
 - analytical, 23, 89, 163
 - sampling, 23, 89, 93-94, 104, 119, 124, 128, 244, 300
 - statistical, 23, 89
- Binomial distribution, 18
- Bladder pump, 109, 110, 115, **202-203**
- Bootstrap, 152, 250, **252**
- Bottles, see containers
- Boundaries
 - defining, 15, 26, 30, **36-37**, 45, 49, 52, 59, 63, 66, 76, 79, 82, 158, 160, 279, 295
 - spatial, 14, 23, 32, 36-37, 39, 49, 158
 - temporal, 14, 23, 32, 36-38, 49, 158
- Box and whisker plot, 147, **148**
- Bucket, **110-112**, 301

- Calibration, 23, 86, 124, 140-143, **158**
- Central limit theorem (CLT), **67**, 244
- Centrifugal pump, 109, 110, 116, **205**
- CERCLA, **2**, 317

- Chain-of-custody, 4, 86, 122, 124, **125-127**, 132, 139-141, 143, 146, 158, 180, 310, 311

- Cleanup (of a waste site), 8, 13, 28, 32, 33, 37-40, **43-44**, 51, 57, 62, 64, 68, 79, 82, 196, 261, 277
- Closure, 7, 8, 10, 61, **181**, **185**
- Coefficient of variation (CV), 147, **158**, 250, 284
- Cohen's Adjustment, 152-153, 241, **257-261**
- COLIWASA, 100, 108-111, 116, **228-229**, 314
- Component stratification, 58, **194-196**
- Comparing,
 - populations, 24, **28**, 150
 - to a fixed standard, **24**, 25, 27, 65, 71, 150, 152, 153, 155, 241, 242, 247-249, 251, 253-255, 258
- Composite sample, 64-73, 80, 108, 115, 140, 158-9, 172, 187, 249, 284, 288-289, 318
- Composite sampling, 52, **64-73**
 - advantages, 65
 - approach, 66-67
 - limitations, 65-66
 - number of samples, 73
 - simple random, 67
 - systematic, 68-69
- Computer codes, see software
- Conceptual site model (CSM), 32
- Cone and quartering, 134
- Confidence interval, **25-27**, 61-62, 70, 150, 155, 247-250, 252-254, 259
- Confidence level, **47-48**, 61, 74, 84, 159
- Confidence limits, **25**, 69, 155, 159
 - for a lognormal mean, 75, 249
 - for a normal mean using simple random or systematic sampling, 247-249
 - for a normal mean using stratified random sampling, 248
 - for a percentile, 253-255
 - nonparametric confidence limits, 252
 - using composite sampling, 249
- Consensus standard, 17, **103**, 159
- Containers, sample, 23, 62, 84, 96, 104, **122-123**, 128, 131-132, 138, 141
- Control samples, 74, 96, **124-125**, 139, 142, 280
 - duplicate, 51, 74, 142, 143, 161, 162
 - equipment blank, 51, 74, 96, 125, 142, 162, 286
 - field blank, 51, 74, 96, 125, 162
 - rinsate, 96, 168, 286
 - spikes, 74, 142, 143, 162, 163
 - trip blank, 51, 74, 96, 125, 142, 162
- Conveyor, 37, 52, 60, 95, 96, 98, 103, 104, **106-107**, 111, 112, 312
 - belt, 52, 95, 98, 106-107, 312
 - screw, 106-107
- Coring type sampler, 111-113, 116, 214, **221**
- Corrosivity, 7, 8, 13, 26, 27, 35, 40, 66, **173**, 293

- Corrective action (RCRA), 1, 8, 10, 29, 40, 44, 79, **185**, 277

Index

- Data quality assessment, 1, 2, 4, 139, **145**, 160, 241, 275, 289, 302
- Data quality objectives, 1, 2, 10, 24, 25, 145, 154, **160**
process, 30-87, 160
seven steps, 30
- Data (also see distributions)
collection design, 38, **50**, 51, 159
gaps, 50, 143
- DataQUEST software, 146-149, 244, **270**
- Debris, 10, 58, 94, 97, 104, 106, **107**, 113, 121, 160, 191-196
sampling methods, 191-196
- Decision error, 31, 38, **41-48**, 73, 75, 76, 82, 142, 155, 160
- Decision maker, 28, 31, **32**, 39-41, 43, 45, 49
- Decision unit, 4, 15, 16, 26, **38-39**, 41, 47-49, 57, 67, 68, 76, 79, 81, 82, 84, 90, 91, 94, 99, 146, 161, 193, 194, 244
- Decision rule, 30, **39-41**, 49, 76, 79, 82, 83, 150, 279, 295
- Decision support, see Decision Unit
- Decontamination, 23, 51, 100, 117, 118, 122, 124, 125, **128-130**, 141, 312, 314
- DEFT software, 31, 45, 73, 84, **273**, 284
- Degrees of freedom (*df*), **268**
simple random or systematic sampling, 248, 249
stratified random sampling, 78, 79, 243
- Delta (Δ), 45
- Detection limit, 40, **161**, 258
- Dilution, 10, **58**, 71, 72
- Dipper, 106, 109-112, 116, **236-237**, 313
- Dispersion, **19**, 22, 169, 170, 193
- Displacement pump, 109, 110, 116, **206-207**
- Distributions, 14, 16, 17
binomial, 18
non normal, 18, **252**
normal, **17-21**, 67, 75, 81, 147, 148, 150, 158, 170, 244
lognormal, **17-19**, 75, 149, 150, 154, 195, 244, 249-250
- Distributional assumptions, 87, 145, 148, **244**
- Distribution heterogeneity, 91
- Documentation, 86, 87, 95, 96, 122, **124-126**, 139-144, 336
- DOT, **131**, 133, 174
- Drum thief, 108, **230-231**
- Drums, 15, 37, 39, 72, 73, 95, 99, 100, 103, **104-105**, 314, 315, 316
- Duplicate, 51, 74, 142, 143, **161**, 162
- Dynamic work plan, 161
- Ease of use, 100
- Effluent, 68, 94
- Enforcement, **10-12**, 27, 43, 63
- Errors, 3, 13, 16, **88-101**
analytical, 3, 69, 88, 90
components of, 88, 89
contamination, 94, 96
decision, 31, 38, **41-48**, 73, 75, 76, 82, 142, 155, 160
delimitation, **94-96**, 99, 100, 102, 106, 136, 137, 211, 229
extraction, **94**, 95, 99, 100, 102, 136, 137
fundamental, 69, 91, **92-94**, 96-98, 135, 136, 197-200
preparation, **94**, 95, 96
segregation and grouping, 91
- Example calculations
Cohen's Adjustment, 261
confidence level when using a simple exceedance rule, 256
locating a hot spot using composite sampling, 73
mean, 19
mean and variance using composite sampling, 71
number of samples for simple random sampling, 76
number of samples for stratified random sampling, 79
number of samples to estimate a percentile, 82
number of samples using a "no exceedance" rule, 82
Shapiro-Wilk test, 246-247
standard deviation, 20
upper confidence limit for a normal mean, 249
upper confidence limit for a lognormal mean, 251
upper confidence limit for a percentile, 255
variance, 20
- Examples of the DQO/DQA processes, 277-304
- Exceedance rule method, 27-28, **255-256**
- Exploratory study, 74
- False positive (false rejection), **42**, 162
- False negative (false acceptance), **42**, 162
- Familiarization (analytical), 50
- Field QC samples, see control samples
- Filliben's Statistic, **148**, 244
- Finite population correction, 77
- Flash point, 66
- Flowing or moving materials, sampling of, 15, 52, 91, 95, 96, **98**, 106, 309, 312, 314
- Fragments, **92**, 94, 99, 134, 141, 163, 192, 197
- Frequency plot, 148
- Fundamental error, 69, 91, **92-94**, 96-98, 135, 136, 197-200
controlling, 97
definition, 163
derivation, 197-200
description, 92
- Gases, 104, 114, 121, 173, 174
- Geometric standard deviation (GSD), 75
- Geostatistics and geostatistical methods, **15**, 29, 58, 59, 80, 90, 151, 163, 192, 273
- Goodness-of-fit, 163, 244
- Grab sample, **64**, 66, 73, 80, 163, 176
- Graded approach, 32, 163
- Gravitational segregation, 91

- Gray region, 41, **45-47**, 49, 75, 76, 79, 81-84, 163, 281, 297
- Grid, 56, **57**, 59, 68,80, 159, 274
- Ground-water monitoring, 7, 10, 15, 28, 39, 44, 45, **114**, 121, 180, 181, 185, 309, 316, 321
- Grouping error, 65, 91, **93**, 96, 134, 137, 138
- Gy's sampling theory, 88-101
- Haphazard sampling, 57
- Hazardous waste:
 - determination, 8
 - regulations, 6-10, **171-189**
- Hazardous waste characteristics, 164-165
 - corrosivity, 7, 8, 13, 26, 27, 35, 40, 66, **173**
 - ignitability, 7, 8, 13, 26, 27, 35, 40, 66, **173**
 - reactivity, 7, 8, 13, 26, 27, 35, 40, 66, **174**
 - toxicity, 7, 8, 13, 26, 27, 35, 40, 66, 73, 120, **173**
- Health and safety, 38, 50, 84, 97, **130**
- Heterogeneity, 4, 26, 52, 53, 66, 68, 69, 88, **90-91**, 93, 106, 137, 138, 163, 191-196
 - large-scale, 91, 191,192
 - periodic, 91
 - short-range, 68, 91, 93, 191
- Heterogeneous waste, 4, 57, 58, 94, 107, **191-196**
- Histogram, **17**, 18, 147, 148, 255
- Holding time, 66, 74, 122, **123-124**, 131, 141, 143, 163
- Homogenization, 4, 23, 66, 69, 91, 92, 102, **134**, 320
 - stationary processes, 134
 - dynamic processes, 134
- Homogeneity, **164**, 192
- Homogeneous, 92, 93, 97, 98, **134**, 136
- Hot spots, 38, 39, 53, 57, 59, 65, 67, **71-73**, 164, 274
- Hypothesis, 40, 41
 - alternative, 43, 157
 - null, **41-47**, 49, 76, 79, 82, 150, 152-155, 157
- Hypothesis testing versus statistical intervals, 25
- Increments, 61, 65, 91, **93**, 94, 96, 134, 135, 138, 158, 164, 194
- Independence or independent samples, **69**, 71
- International Air Transport Association (IATA), 131, **133**
- Interpolation, 261
- Ignitability, 7, 8, 13, 26, 27, 35, 40, 66, **173**
- Investigation derived waste (IDW), 118, **129-130**
- Jackknife, 152, 250, **252**
- Judgment sampling, 48, 51, 55, **63-64**
- Kemmerer depth sampler, 100, 108, 109, 117, **210-211**
- Labels, sample, 96, 124, **125**, 131, 141, 310, 314
- Land Disposal Restrictions (LDRs), 7, 8, **9-10**, 13, 26, 27, 35, 40, 44,66, 82, 113, 160, 171, 176, 177
- Landfill, 28, 34, 52, 82, 104, 106
- Land treatment, 8, 28, 33, 37, 41, 52, 121, **183**
- Large-scale heterogeneity, 91, 191,192
- Less-than values, see nondetects
- Liquid grab sampler, 109-111, **237**
- Liquids, 90, **98**, 100, 109, 110, 120, 136
- Logbook, **124**, 140, 143, 146
- Lognormal distribution, **17-19**, 75, 149, 150, 154, 195, 244, 249-250
- Maps, **29**, 33, 37, 58, 59, 124, 141
- Margin of error, 13
- Mass of a sample, 4, 23, 36, 92, **96-97**, 136, 137, 197-200
- Mean, 14, 17, **18-19**, 40, 165
- Mean square error, **89**, 165
- Measurement: 15-16
 - bias, 23
 - random variability, 23-24
- Median, 17, **19**, 39, 40, 88, 155, 165, 249, 252
- Miniature core sampler, 111-113, 117, **222-223**
- Modified syringe sampler, 111-113, 117, **224**
- Multi-phase mixtures, 98
- Nondetects, 146, 147, 150, 154, **257-258**
- Nonparametric methods, **18**, 83, 150, 153, 165, 252, 255, 256
- Nonprobability sampling, 51, 55, **63**, 193
- Normal distribution, **17-18**, 20, 21, 67, 75, 147, 148, 150, 244
- Normal probability plot, **18**, 147, 148, 290-291
- Nuggets, 92
- Number of samples
 - composite sampling, 80
 - mean, normal distribution, using simple random sampling or systematic sampling, 73, 80
 - mean, normal distribution, using stratified random sampling, 77
 - mean, lognormal distribution, 75
 - percentile or proportion, 81
 - using an exceedance rule, 83
- Optimal design, **50**, 78, 96
- Outliers, 145, 147, **148-149**, 165, 250, 322
- OSHA, 130
- Packaging and shipping, 131
 - sample packaging, 131
 - sample shipping, 133
- Parameter (statistical), 21, 23, 24, 25, 27, **39-40**, 166
- Particle size distribution, 16, **94-95**
- Particle size reduction, 69, 91, 93, 96, 97, 98, **136**, 137, 138, 192, 198, 200
- Particulate, 90, 95, **97**, 134, 137, 317
- Pass or fail data, **18**, 28, 35, 40, 81, 153
- Percentile, 20, **21**, 26-27, 39-40, 45, 81, 151, 153, 166, 253
- Performance-based measurement system (PBMS), 86
- Peristaltic pump, 109-111, 118, 202, **204-205**
- pH, **66**, 173, 174
- Photoionization detector, 60

Index

- Piles:
 elongated, **52**, 138
 staging, **37**, 120
 waste, 16, 37, 104, **106**, 168, 178, 187, 317
Pilot study, 43, 50, **74**, 80, 93, 315
Pipes, 37, 52, 60, 94, 95, 98, 104, 105, **106**, 109-112, 120, 196, 312
Plunger type sampler, 109-111, 118, **232-234**
Point estimate, **21**, 27, 252
Point of (waste) generation, 6, **15**, 33, 37, 39, 52, 73, 76, 82, 104, 106, 171, 193, 255, 295, 299, 300
Point source discharge, **106**, 182, 236, 238
Ponar dredge, 111, 118, **207-209**, 308, 309
Populations, 13, **14-15**, 16, 17, 24, 28, 194, 250
Pore water, **15**, 42, 182
Precision, 11, 14, **22-24**, 25, 26, 52, 58, 64, 65, 69, 70, 74, 80, 125, 134, 166, 194
Preliminary study, *see* pilot study
Preparation error, **94**, 95, 96
Preservation, 92, 94, 96, **123-124**, 131, 180, 308, 309
Probability plot, **18**, 21, 147-149, 245, 255, 257
Process knowledge or knowledge of the waste, 1, **9**, 10, 13, 27, 28, 34, 40, 43, 64, 175, 293
Proving the negative, **11-12**, 13, 295
Proving the positive, **11-12**, 13, 63

Quality assurance project plan (QAPP), 1, 3, 4, 30, 33, 34, 48, 50, 51, **84-87**, 139-142, 144, 146, 166
Quality control, 1, 11, 24, 30, 51, 87, 96, 122, **124-125**, 167, 313
Quick Safety Rule (Pitard's), 97, **198**

Random number, 57
Random variability, 3, 24, 26, **88-89**, 322
Randomization, 51
Range, 17, 41, **43**, 45, 75, 167
Ranked set sampling: 54
 description, 60
 procedure, 61
RCRA:
 summary of regulatory citations, 171-189
Reactivity, 7, 8, 13, 26, 27, 35, 40, 66, **174**
Regulatory threshold, 11, 26, 27, **35**, 63, 72, 82, 124
Relative standard deviation, **97**, 156, 167
Relative variance, **97**, 197, 279
Remediation, 31, 33, 37, 44, **167**, 179
Repeatability, *see* precision
Representative sample, 7, 9, 13, **16**, 17, 168, 173-175, 178, 179, 180, 191
Riffle splitter, 134-135
Rinsate, 96, **168**, 286
Risk assessment, 29, **139**
Roll-off bin or container, 15, 37, 39, 52, 82, 95, 96, 99, 104, **106**, 113, 255
Rotating coring device, 113, 118, 225, **227-228**
Rosner's Test, 149

correct, 96
discrete, 26, **64**, 66, 100
duplicate, 51, 74, 142, **161**
grab, **64**, 66, 73, 80, 163, 176
individual, 47, **64**
random, 19, **57-60**, 67, 77, 79, 80, 243
representative, 7, 9, 13, **16**, 17, 168, 173-175, 178, 179, 180, 191
split, 72, 95, **123**, 125, 135, 168
statistical, 14, **16**, 19, 21, 27, 169
Sample collection design, *see* sampling design
Sampling design, 51
 authoritative, 62
 biased, 64
 judgmental, 63
 probabilistic, 51
 ranked set, 60-61
 simple random, 57
 stratified, 57-58
 systematic, 59-60
Sampling in space and time, 52
Sampling devices, 109-114
 limitations, 102
 selecting, 95
Scientific method, 160, 168
Scoop, 98, 100, 107, 111-113, 118, 135, 137, **239-240**, 315, 319
Sediment, 104, 105, **114**, 121, 133
Segregation error, 91
Sequential sampling, 54, **61-62**
Settleable solids profiler, 109-111, 118, **233-234**
Shapiro-Wilk test, 147, 148, **244-246**
Sheet mixing, 134
Shelby tube, 100
Shipping samples, 133
Short range heterogeneity, 68, **91**, 93, 191
Shovel, 99, 100, 111-113, 119, **239-241**
Significance level, 47
Simple random sampling, 57
Slurry, 52, 106, **111**, 120, 312
Software:
 ASSESS, 275
 DataQUEST, 275
 DEFT, 31, 45, 73, 84, **273**
 DQOPro, 274
 ELIPGRID-PC, 274
 GeoEAS, 29, **273**
 MTCAStat, 275
 UnCensor, 257
 Visual Sample Plan (VSP), 274
Soil:
 background concentrations, 28, 33, 37, **41**
 volatiles in soil, 101
Soil gas, 104, **114**, 121, 310, 312, 313, 314
Solid waste, 1, **8-9**, 13, 15, 16, 26, 173, 174, 178
Solid waste management unit (SWMU), 15, 33, 37, 44, 52, 67, 79, 113, **185**, 277
Spatial correlation, **29**, 68, 68, 80, 163
Spatula, **137**, 138, 239

- Split barrel sampler, 104, 112, 113, 119, **216-217**, 306
- Splitting of samples, 135
- Standard deviation:
 definition, **19-20**, 169
 for composite sampling, 70
 for simple random or systematic sampling, 19-20, 242
 for stratified random sampling, 243
- Standard error of the mean, 21, 242
 description, 21
 for composite sampling, 71
 for simple random or systematic sampling, 21, 242
 for stratified random sampling, 77, 243
- Standard operating procedures (SOPs), **51**, 86, 87, 124, 135, 136, 140, 142, 169
- Statistical intervals, 25
- Statistical methods, 241-261
- Statistical tables, 263-272
- Statistical software, 273-275
- Stratification, 194, 196
 by component, 58
- Stratified random sampling, 53, **57-58**
- Stratum, **57**, 58, 59, 77-79, 169, 194, 195, 243
- Student's t distribution, 248-250, **263**
- Subsampling, 135
 liquids, 136
 mixtures of liquids and solids, 136
 soils and solid media, 136
- Superfund, **2**, 15, 38, 94
- Support, 16
 decision, *see* decision unit
 sample, 94-95
- Swing jar sampler, 109-111, 119, **238**
- Syringe sampler, 109-113, 119, **211-212**
- Systematic sampling, 53, **59-60**
- Tank(s), 7, 37, 52, 104, **105**, 106, 109-111, 115, 117, 120, 121, 129, 182
- Target population, **36**, 37, 53, 57, 58
- t distribution, *see* Student's t distribution
- Thief, 100, 108-113, 116, 117, **217-219**, 230-231
- Thin-walled tube, 112, 113, 119, **219-221**
- Time (sampling over), 52
- Tolerance limit, 27
- Transformations of data, **150**, 249
- Trends, 29, 53, 57, 59, **60**, 91, 150
- Trier, 100, 111-113, 119, **218-219**, 314
- Trowel, 99, 100, 111-113, 119, **239-240**
- Two-sample tests, **28**, 151
- Type I error, **42**, 43, 44, 47, 75, 76, 79, 83, 162, 170
- Type II error, **42**, 43, 44, 47, 75, 76, 78, 83, 155, 162, 170
- Universal treatment standards (UTS), 33, 151, **177**, 256
- Upper confidence limit (UCL), *see* confidence limit
- Used oil, 7, 8, 120, **172**, **189**
- Vadose zone, 107, 114, 121, **170**, 217, 221, 226, 310, 313, 315
- Valved drum sampler, 109, 110, 119, **231-232**
- Variance, **19-20**, 23
 additivity of variances, 89
 for composite samples, 70
 simple random or systematic sampling, 242
 stratified random sampling, 243
- Verification and validation, 2, 87, **139-144**
- Volatiles, sampling, 101
- Volume or mass of a sample, 94, **96-97**, 108
- Walsh's Test, 149
- Waste:
 debris, 10, 58, 94, 97, 104, 106, **107**, 113, 121, 160, 191-196
 investigation derived, 118, **129-130**
 hazardous, 6-10, **171-189**
 heterogeneous, 4, 57, 58, 94, 107, **191-196**
 multi-phase, 98
 nonhazardous, **13**, 34, 38, 58, 82, 129, 194, 255
 one-dimensional, **52**, 56, 95, 96, 98, 102, 138
 three-dimensional, **95**, 96, 99
 two-dimensional, 56, 59, **95**, 99, 102
- Waste analysis plan (WAP), 1, 3, 4, **10**, 30, 50, 84, 85, 139
- Weighting factor, 58, **77-79**, 243
- X-ray fluorescence, 60

Appendix D-4

Letter Correspondence from GHD to Harris County Flood Control District, Titled “Overview of Floodplain Drainage Impact Analysis,” Dated May 6, 2022

Our ref: 11215702-Najda-1 Rev. 2

May 06, 2022

Stephania Najda, PE
Harris County Flood Control District
10555 Northwest Freeway, St 170
Houston, TX 77092

Overview of Floodplain Drainage Impact Analysis

Dear Ms. Najda:

On behalf of International Paper Company (IPC) and McGinnes Industrial Maintenance Corporation (MIMC; collectively the Respondents), GHD appreciates the opportunity to submit to the Harris County Flood Control District (HCFCD) this *Overview of Floodplain Drainage Impact Analysis* for the Northern Impoundment of the San Jacinto Waste Pits Superfund Site (Site). The Remedial Design (RD) for the Site is being conducted under the direction of the United States Environmental Protection Agency (EPA) and in accordance with the *Administrative Settlement Agreement and Order on Consent* (AOC; CERCLA Docket No. 06-02-18).

At the request of the HCFCD in an email to Gary Baumgarten, EPA Remedial Project Manager, dated October 20, 2020, GHD conducted hydrodynamic modelling to assess potential impacts of a proposed cofferdam structure to the surrounding floodplain. The design of the cofferdam structure is part of the Northern Impoundment Pre-Final 90% Remedial Design package due to the EPA in June 2022. Per the 2017 EPA Record of Decision (ROD; EPA, 2017), the selected remedy for the Northern Impoundment includes the installation of a cofferdam around the impoundment, dewatering of river water, and excavation of impacted material for off-Site disposal.

GHD provided an overview of the modelling and drainage impact analysis to the HCFCD in a virtual Teams meeting on February 3, 2022. Based upon that discussion, GHD has prepared this letter to provide a summary of the return events modelled, the outputs of the model, and the implications of the results. This letter also describes the model used and how it compares to the HEC-RAS model typically used by the HCFCD.

1. Objective

The objective of this letter is to summarize the numerical hydrodynamic model used to assess the effect of the planned cofferdam on the river hydrodynamics and the results of the modelling. The model was compared to the existing HEC-RAS 3.0.1 G103-00-00SJ San Jacinto Watershed model downloaded from the Harris County Model and Management (M3) website to provide an assessment of the selected model behavior.

2. Background

The Northern Impoundment is located in the San Jacinto River north of Interstate 10 (I-10) to the east of Houston, Texas, Figure 2.1. According to the HCFCD, projects that may impact the floodplain must be modelled up to and including the 500-year flood event. However, the Site is located within a tidally influenced area and is classified by the United States Geological Society (USGS) as a Tidal Stream (USGS, 2022). This means that flow is influenced by the tide and is considered a coastal Site. Therefore, a 500-year flood assessment is not required and was not conducted. The Site is located within the San Jacinto Watershed. As shown in Figure 2.2.1, the upper San Jacinto River Basin Watershed extends from Huntsville, Texas to Lake Houston and represents ten bayous/creeks. South of Lake Houston, Figure 2.2.2 shows the lower San Jacinto Watershed that represents the flood plain south of Lake Houston for the Site.

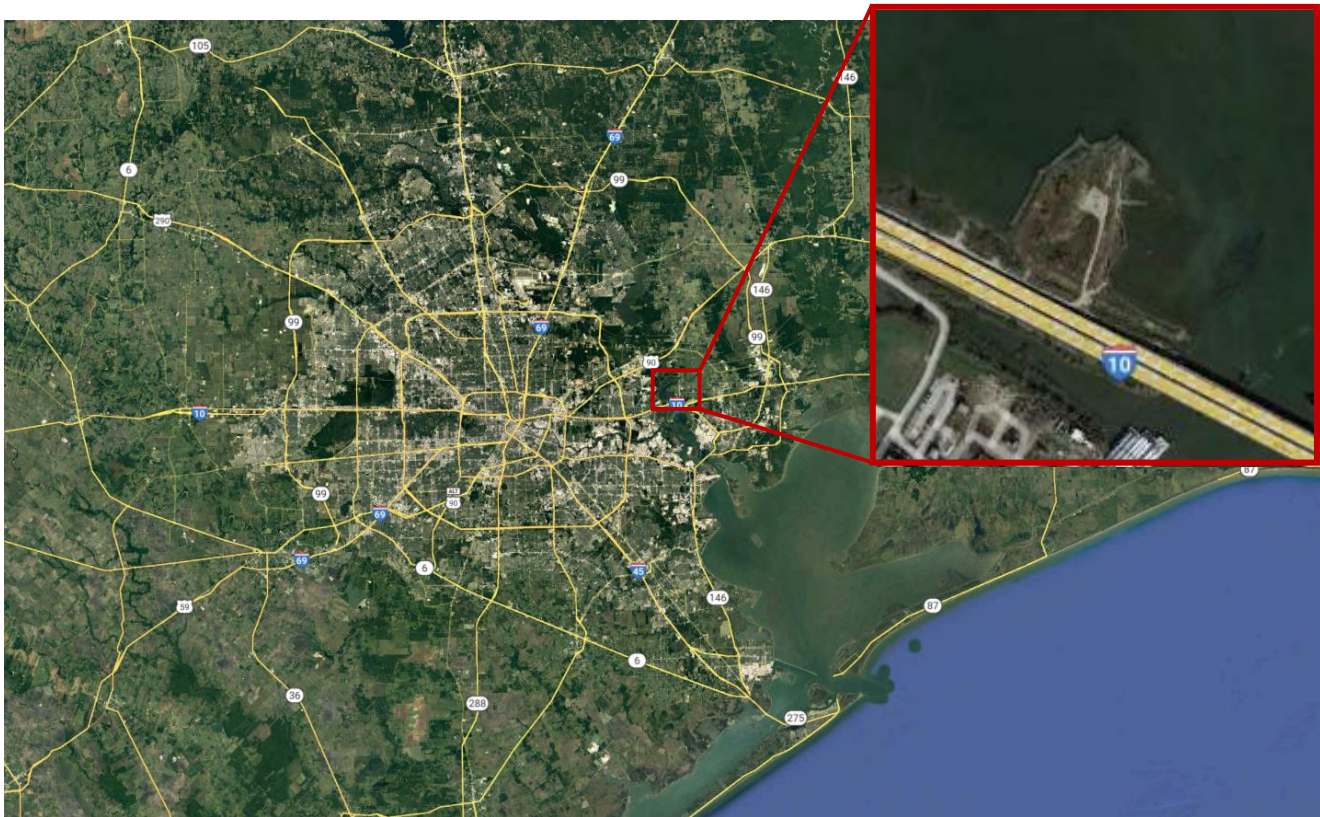

Figure 2.1 Project Location (Site)



Figure 2.2 Project Location Watershed (Green Represents the Upper San Jacinto River Basin Watershed and Blue is the Lower San Jacinto Watershed)

3. EFDC Model

The Environmental Fluid Dynamic Model (EFDC) was used to conduct a numerical hydrodynamic model of the Northern Impoundment. EFDC is a numerical code for 1-, 2- and 3-dimensional hydrodynamic modeling with the ability to calculate sediment and contaminant transport as well as water quality. It has evolved over the past two decades to become one of the most widely used and technically defensible hydrodynamic models in the world. EFDC is used extensively to simulate hydrodynamic and water quality processes in rivers, lakes, estuaries, reservoirs, wetlands, and coastal regions.

The EFDC code solves the three-dimensional primitive variable vertically hydrostatic equations of motion for turbulent flow in a coordinate system which is curvilinear and orthogonal in the horizontal plane and stretched to follow bottom topography and free surface displacement in the vertical direction which is aligned with the gravitational vector. A second moment turbulence closure scheme relates turbulent viscosity and diffusivity to the turbulence intensity and a turbulence length scale. Transport equations for the turbulence intensity and length scale as well as transport equations for salinity, temperature, and suspended sediment are also solved. An equation of state relates density to pressure, salinity, temperature, and suspended sediment concentration.

The EFDC model allows for drying and wetting in shallow areas by a mass conservation scheme for the appropriate representation of marsh and floodplain areas.

A 2-dimensional (2D) depth average EFDC model that simulates flow velocity and water depth in the domain has been developed by Anchor QEA (AQEA, 2012). The EFDC San Jacinto model implementation has been peer reviewed by the US Army Corp of Engineers - Engineer Research and Development Center (ERDC) and approved by EPA for several uses, including hydrodynamic and sediment transport. GHD updated the model for the analysis of the potential impact that the planned cofferdam could have on flooding elevations. The model extends from the Lake Houston Dam south to the Fred Hartman Bridge. A higher resolution grid was implemented near and at the Site, while a lower resolution grid was used in the Houston Ship Channel (HSC), upper San Jacinto River, downstream bays, and down to Fred Hartman bridge.

The bathymetric data used in the AQEA model was updated using the most recent data from the National Oceanic Atmospheric Association (NOAA) National Centers for Environmental Information (NCEI) with the projection set to the State Plane 1983 with horizontal and vertical datums North American Datum of 1983 (NAD83) and North American Vertical Datum of 1988 (NAVD88), respectively. Wind and water levels were downloaded from NOAA's Tides and Currents gauge #8770613 located at Morgan's Point, TX. Morgan's Point is located less than 12 miles from the Site and experiences diurnal and semidiurnal tides (NOAA, 2021).

Flow data for the Lake Houston Dam was obtained from the Coastal Water Authority (CWA) for the years 2007-2011 while the years preceding 2007 were calculated using a rating curve. Streamflow and velocity data for the floodplain south of Lake Houston was downloaded from USGS gauges 08072050, 08074000 and 08073700.

Two stations were used within the model to evaluate results. Both are located less than 800 feet (ft) from the Cofferdam Wall in areas subjected to flooding and drying during the simulation. Station 1 and Station 2 are shown in Figure 3.1.1.

To calculate the impact on the floodplain surrounding the Site, the model was processed using three scenarios, each with and without the cofferdam present. The three flow events processed have return periods of 2-, 10- and 100-years. For all three return periods, the results show that the water height differences expected between "With Cofferdam" and "Without Cofferdam" scenario are less than 0.1 ft as shown in Table .

Table 1 *Water Height Differences*

Return Period	Difference Between With and Without Cofferdam	
	(feet)	(inches)
2-year	0.072	0.864
10-year	0.020	0.24
100-year	0.003	0.036

These results indicate that there should be no adverse effects on the surrounding floodplain caused by the presence of the cofferdam in the river during remedial activities conducted at the Northern Impoundment.

There are no changes in the floodplain inundated areas with or without a cofferdam present. The 2-, 10-, and 100-yr water depth comparison results are shown in Figure 3.23.2, while the calculated water surface elevations at the Site for the three scenarios are shown in Figure 3.33.3.

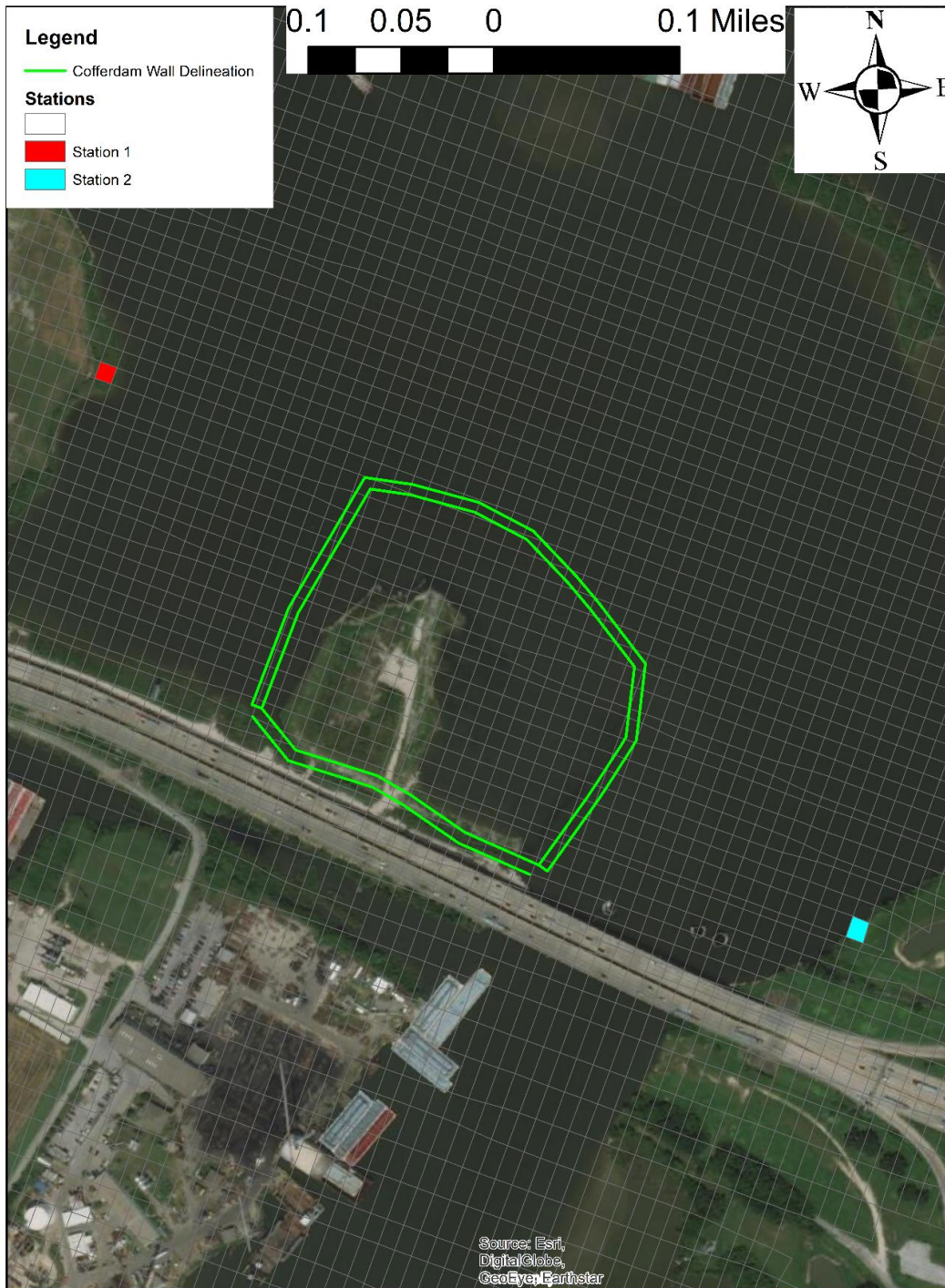

Figure 3.1 Stations for Water Depth Comparisons

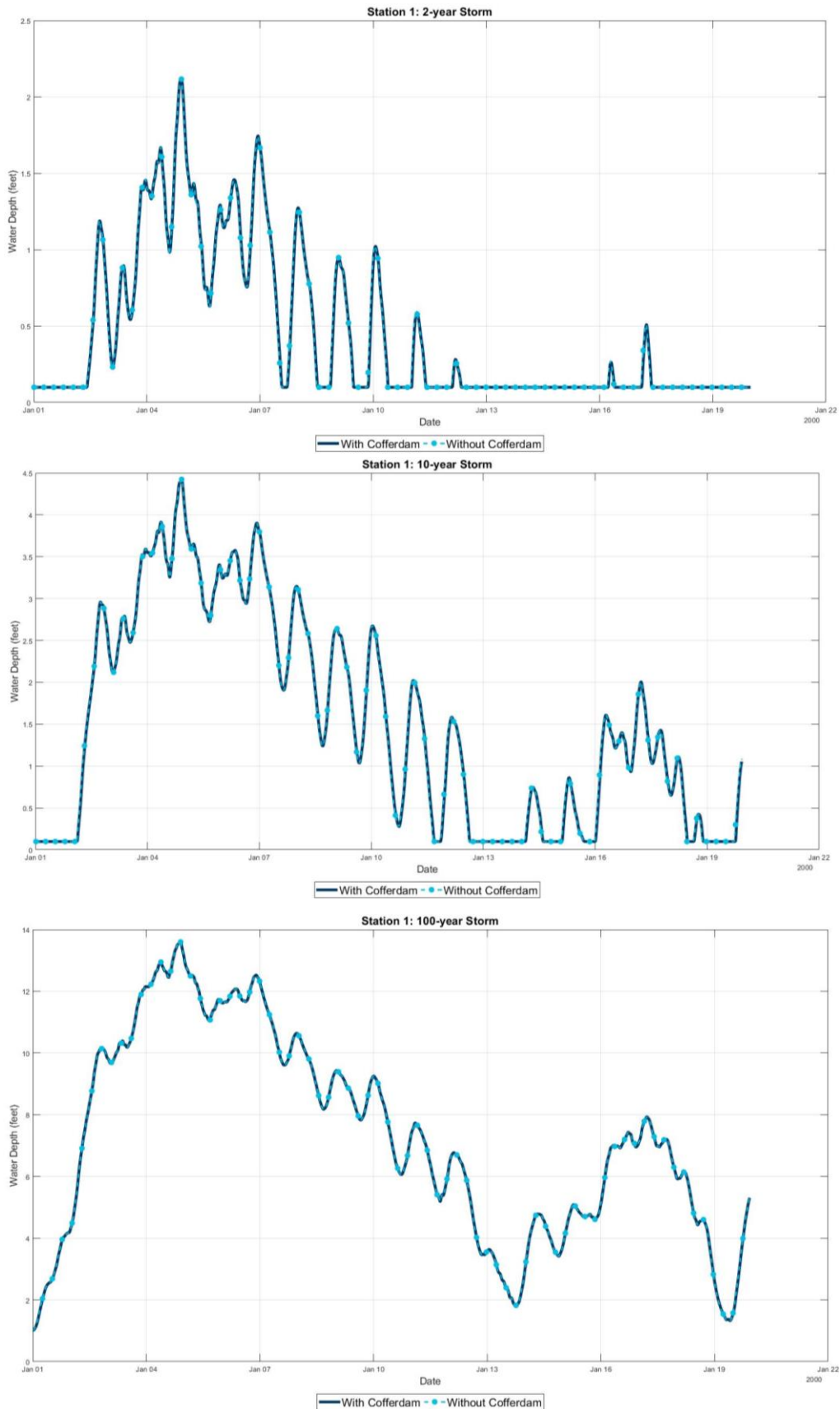

Figure 3.2 Station 1 Water Depth Comparison With and Without Cofferdam Wall for 2-, 10-, and 100-yr Storms

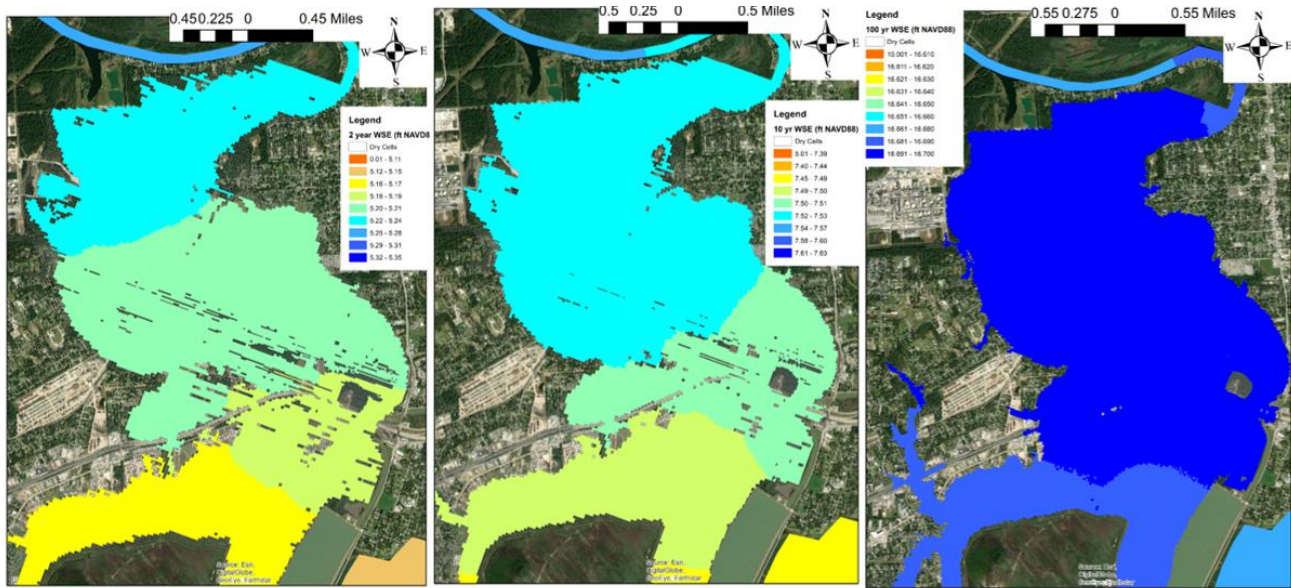

Figure 3.3 Maximum Water Surface Elevations for the 2-, 10- and 100-year Storm

4. HEC-RAS G103-00-00SJ Model

HEC-RAS is an integrated system of software designed to perform one-dimensional and two-dimensional hydraulic calculations for a full network of natural and constructed channels, overbank/floodplain areas, and levee protected areas. The 1D flow calculations are based on the energy equations to solve for steady and unsteady Gradually Varied Flows and can use a solver based on the momentum equation for special cases such as Rapidly Varying Flows or mixed flow regimes. The 2D flow routing capabilities in HEC-RAS have been developed to allow the user to perform 2D or combined 1D/2D modelling. The program solves either the 2D Shallow Water equations (with optional momentum additions for turbulence, wind forces, mud and debris flows, and Coriolis effects) or the 2D Diffusion Wave equations, as selected by the user. The 2D Shallow Water equations are applicable to a wider range of problems and is comparable to the other models used as 2D such as EFDC.

For the San Jacinto River, the G103-00-00SJ data was run through the HEC-RAS 3.0.1 hydraulic model on June 18, 2007, using a steady state flow condition and a vertical datum of NAVD88 (same as EFDC). The HEC-RAS 3.0.1 is a 1-dimensional fluid flow model that computes water surface profiles and floodways for steady, gradually varied flow in channels with the water profile calculated using discharges from the HEC-HMS model.

The data for the San Jacinto River regional watershed was downloaded from the Harris County Flood District Model and M3 System. While all the data sets were pulled for the individual bayous, the data set titled, G103-00-00SJ was compared with the EFDC model results. The G103-00-00SJ data set covers the San Jacinto River from I-10 to the Lake Houston Dam, including the Northern Impoundment location.

5. Model Differences

The key differences between the EFDC model and the HEC-RAS 3.0.1 run model include dimensionality and model boundary conditions. The EFDC model is a 2-dimensional model while the HEC-RAS is 1-dimensional. Additionally, the HEC-RAS model did not take storm surge into account as a boundary condition on the south side of the model boundary which is important as the San Jacinto River is considered a tidally influenced river

The HEC-RAS application assumed normal flow conditions at the downstream boundary of the 1D model neglecting the backwater effect of the storm surge on the area of interest. While the HEC-RAS model was run for the 10-, 50-, 100- and 500-year storm events, the EFDC model was run for the 2-, 10-, and 100-year storm events (the 500-year event was not applicable since the area is considered a coastal area).

6. Result Comparison

Results between the two models were compared from HEC-RAS transect 32 (I-10) upstream to Transect 23 (Bend at Lakeview Terrace/Bluff Gully), as shown boxed in Figure 6.1.1 below.

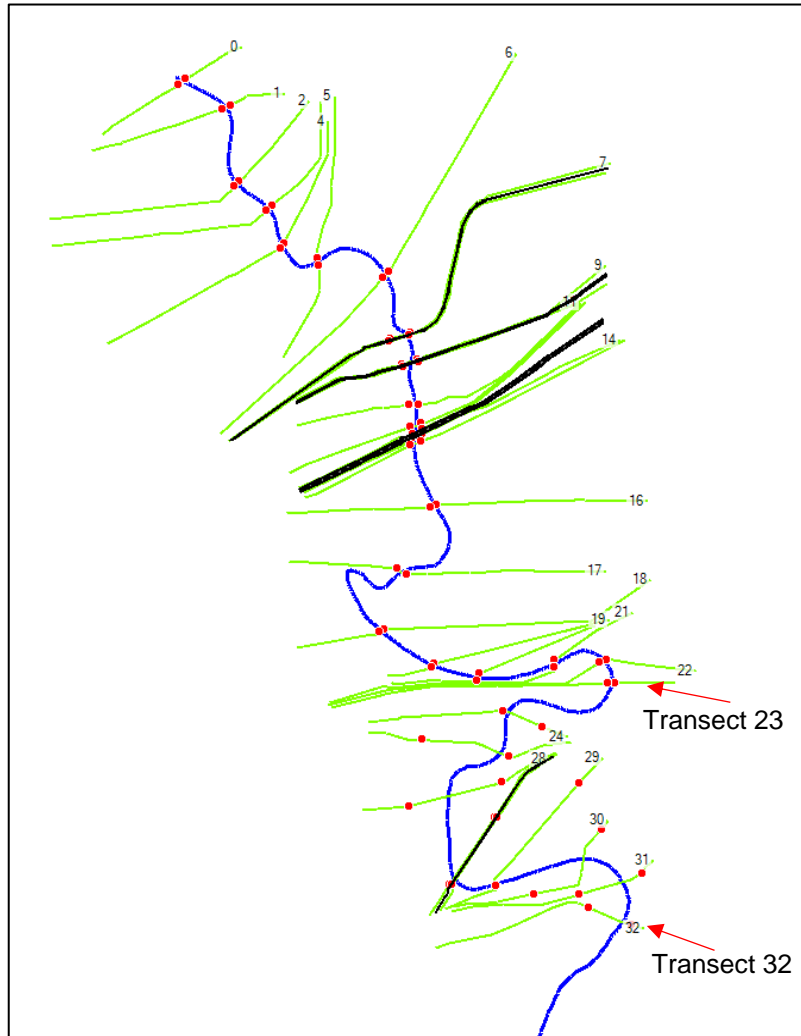

Figure 6.1 G103-00-00SJ River Transect Numbers and Bank Stations (red)

The models were compared for the 10-yr and 100-year return period storm events with results shown in Table 2 below. The EFDC model shows greater water surface elevation at all transect numbers for the 100-yr storm event and for eight of the nine transects for the 10-year storm event. The 23rd transect located north of the Site, has a water surface elevation difference of 0.4-ft or 4.8-inches.

Table 2 G103-00-00SJ River Transects – Model Comparison

Transect Number	River Station	HEC-RAS 10YR	EFDC 10YR	HEC-RAS 50-YR	HEC-RAS 100-YR	EFDC 100-YR
23	93063.22	7.92	7.51-7.52	13.81	16.5	16.661-16.680
24	86250.95	6.80	7.51-7.52	12.76	15.27	16.691-16.7
25	83974.91	6.63	7.51-7.52	12.61	15.11	16.691-16.7
26	79907.59	6.08	7.51-7.52	12.22	14.68	16.691-16.7
27	75450.01	4.96	7.51-7.52	11.51	13.85	16.691-16.7
29	72968.31	4.32	7.51-7.52	11.19	13.43	16.691-16.7
30	67924.46	2.36	7.5-7.51	10.69	12.85	16.691-16.7
31	65261.75	0.36	7.5-7.51	10.21	12.32	16.691-16.7
32	62987.20	-1.24	7.5-7.51	9.33	11.43	16.691-16.7

Given the model differences, the EFDC model is more accurate than the HEC-RAS 3.0.1 model and shows greater water surface elevations at all the transects for the 100-year storm and at eight of the 9 transects for the 10-year storm event. The EFDC model uses storm surge for the water surface elevation, which is crucial, as the Site is located within a tidally influenced section of the San Jacinto River. Additionally, the project is being performed under an AOC under the EPA Superfund program. GHD is confident that the EFDC model gives accurate results that are comparable to what a HEC-RAS 2D application could provide, and with similar results to existing HEC-RAS 1D application in the area with differences mainly related to more accurate boundary conditions enhanced by including storm surge effects.

7. References

San Jacinto River near Sheldon, Texas Monitoring Location 08072050, courtesy of the U.S. Geological Survey. [San Jacinto River near Sheldon, TX - USGS Water Data for the Nation](#). Accessed 11 February 2022.

Model and Map Management (M3) System, Harris County Flood Control District. [Model and Map Management \(M3\) System \(hcfcd.org\)](#). Accessed 11 February 2022.

Hamrick, J. M. (1992) A Three-Dimensional Environmental Fluid Dynamics Computer Code: Theoretical and computational aspects. Special report in applied marine science and ocean engineering; no. 317. Virginia Institute of Marine Science, College of William and Mary.

HEC-RAS River Analysis System. HEC-RAS 2D User's Manual. Version 6.0. Exported - February 2022.

USEPA. 2017. Record of Decision. San Jacinto River Waste Pits. Harris County, Texas. USEPA ID TXN000606611. USEPA Region 6. Dallas TX. October 2017.

Regards,



Hugo Rodriguez
Senior Water Resources & Coast

+1 786 431-2914
hugo.rodriguez@ghd.com

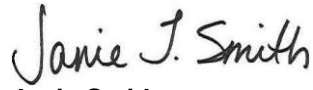

Janie Smith
Project Manager

+1 225 296-6550
janie.smith@ghd.com

JS/kdn/1

Copy to: Todd Miller, HCFCD
Ashley Howard, USEPA
Phil Slowiak, IPC
Brent Sasser, IPC
Judy Armour, MIMC
Charles Munce, GHD

Appendix D-5

**Letter Correspondence from GHD to Texas
Department of Transportation, Titled
“Velocity and Shear Stress Analysis,”
Dated April 11, 2022**

Our Ref.: 11215702-Javadi-1

April 11, 2022

Ms. Jeanne Javadi
Texas Department of Transportation

Velocity and Shear Stress Analysis

Dear Ms. Javadi:

On behalf of International Paper Company (IPC) and McGinnes Industrial Maintenance Corporation (MIMC; collectively the Respondents), GHD Services Inc. (GHD appreciates the opportunity to submit to the Texas Department of Transportation (TxDOT) the enclosed results of a Velocity and Shear Stress Analysis performed in association with the Remedial Design (RD) for the Northern Impoundment of the San Jacinto Waste Pits Superfund Site (Site). The RD for the Site is being conducted under the direction of the United States Environmental Protection Agency (EPA) and in accordance with the *Administrative Settlement Agreement and Order on Consent* (AOC; CERCLA Docket No. 06-02-18).

As part of ongoing RD activities, GHD conducted hydrodynamic modelling to assess potential impacts of a proposed cofferdam structure to the surrounding floodplain. As discussed in a meeting on March 10, 2022, between TxDOT, EPA, Texas Commission on Environmental Quality, United State Army Corps of Engineers, GHD, and the Respondents, and as requested in an email dated March 30, 2022, GHD also utilized the model to evaluate how the presence of the proposed cofferdam may affect the river velocities and associated shear stresses of the San Jacinto River adjacent to the Site. GHD utilized an Environmental Fluid Dynamic Model (EFDC) to process three flow scenarios, each with and without the cofferdam present. The three flow scenarios have return periods of 2-, 10-, and 100-years (including storm surge). Since the RD is not complete, all model outputs should be considered draft and could be subject to modifications in the future.

The enclosed data includes data summary tables and the following figures:

- Velocity:
 - 2-year Median - Existing Conditions (No Cofferdam).
 - 2-year Median - With Cofferdam.
 - 2-year 95% - Existing Conditions (No Cofferdam).
 - 2-year 95% - With Cofferdam.
 - 2-year 95% Difference Plot.
 - 10-year Median - Existing Conditions (No Cofferdam).
 - 10-year Median - With Cofferdam.
 - 10-year 95% - Existing Conditions (No Cofferdam).
 - 10-year 95% - With Cofferdam.
 - 10-year 95% Difference Plot.
 - 100-year Median - Existing Conditions (No Cofferdam).
 - 100-year Median - With Cofferdam.
 - 100-year 95% - Existing Conditions (No Cofferdam).

- 100-year 95% - With Cofferdam.
- 100-year 95% Difference Plot.
- Shear Stress:
 - 2-year Median - Existing Conditions (No Cofferdam).
 - 2-year Median - With Cofferdam.
 - 2-year 95% - Existing Conditions (No Cofferdam).
 - 2-year 95% - With Cofferdam.
 - 2-year 95% Difference Plot.
 - 10-year Median - Existing Conditions (No Cofferdam).
 - 10-year Median - With Cofferdam.
 - 10-year 95% - Existing Conditions (No Cofferdam).
 - 10-year 95% - With Cofferdam.
 - 10-year 95% Difference Plot.
 - 100-year Median - Existing Conditions (No Cofferdam).
 - 100-year Median - With Cofferdam.
 - 100-year 95% - Existing Conditions (No Cofferdam).
 - 100-year 95% - With Cofferdam.
 - 100-year 95% Difference Plot.

Should you have any questions or require additional information regarding this submittal, please contact GHD at (225) 292-9007.

Regards,

GHD

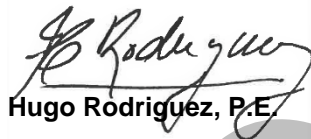

Hugo Rodriguez, P.E.

(786) 431-2914
Hugo.Rodriguez@GHD.com

JTS/jlf/1

Encl.: Summary Tables
Velocity Figures
Shear Stress Figures

cc: Ashley Howard, EPA
Robert Appelt, EPA
Presanna Chebbi, TxDOT
Daniel Copps, LJA
Phil Slowiak, IPC
Brent Sasser, IPC
Judy Armour, MIMC
Charles W. Munce, GHD



Janie T. Smith

(225) 292-9007
Janie.Smith@GHD.com

Summary Tables

DRAFT

Table 1: Shear Stress With and Without the Cofferdam

	Shear Stress (Pa)					
	Existing Conditions (Without Cofferdam)			With Cofferdam		
	2 year	10 year	100 year	2 year	10 year	100 year
Maximum Value of 95th Percentile	0.495	0.420	0.128	0.512	0.457	0.143
Average Value of 95th Percentiles	0.113	0.108	0.044	0.103	0.094	0.034

Table 2: Difference in Shear Stress Between Conditions (With and Without Cofferdam)

	Shear Stress Difference (Pa)		
	2 year	10 year	100 year
Maximum value of 95th percentiles	0.093	0.111	0.045
Average value of 95th percentiles	-0.007	-0.009	-0.006

*These differences do not correlate to the values in Table 1, but represent the maximum and average of the full dataset of differences.

Table 3: Percentage Difference in Shear Stress Between Conditions (With and Without Cofferdam)

	Shear Stress Difference (%)		
	2 year	10 year	100 year
Maximum % Value of 95th Percentiles	19%	26%	35%
Average % Value of 95th Percentiles	-6%	-8%	-13%

Table 4: Velocity With and Without the Cofferdam

	Velocity (ft/s)					
	Existing Conditions (Without Cofferdam)			With Cofferdam		
	2 year	10 year	100 year	2 year	10 year	100 year
Maximum Value of 95th Percentiles	1.248	1.150	0.664	1.379	1.322	0.764
Average Value of 95th Percentiles	0.563	0.568	0.394	0.558	0.542	0.351

Table 5: Difference in Velocity Between Conditions (With and Without Cofferdam)

	Velocity Difference (ft/s)		
	<i>2 year</i>	<i>10 year</i>	<i>100 year</i>
Maximum value of 95th percentiles	0.158	0.214	0.150
Average value of 95th percentiles	-0.021	-0.029	-0.035

*These differences do not correlate to the values in Table 4, but represent the maximum and average of the full dataset of differences.

Table 6: Percentage Difference in Velocity Between Conditions (With and Without Cofferdam)

	Velocity Difference (%)		
	<i>2 year</i>	<i>10 year</i>	<i>100 year</i>
Maximum % value of 95th percentiles	13%	19%	23%
Average % value of 95th percentiles	-4%	-5%	-9%

Velocity Figures

DRAFT

DRAFT

2 year median velocities for existing conditions

Speed (ft/s)



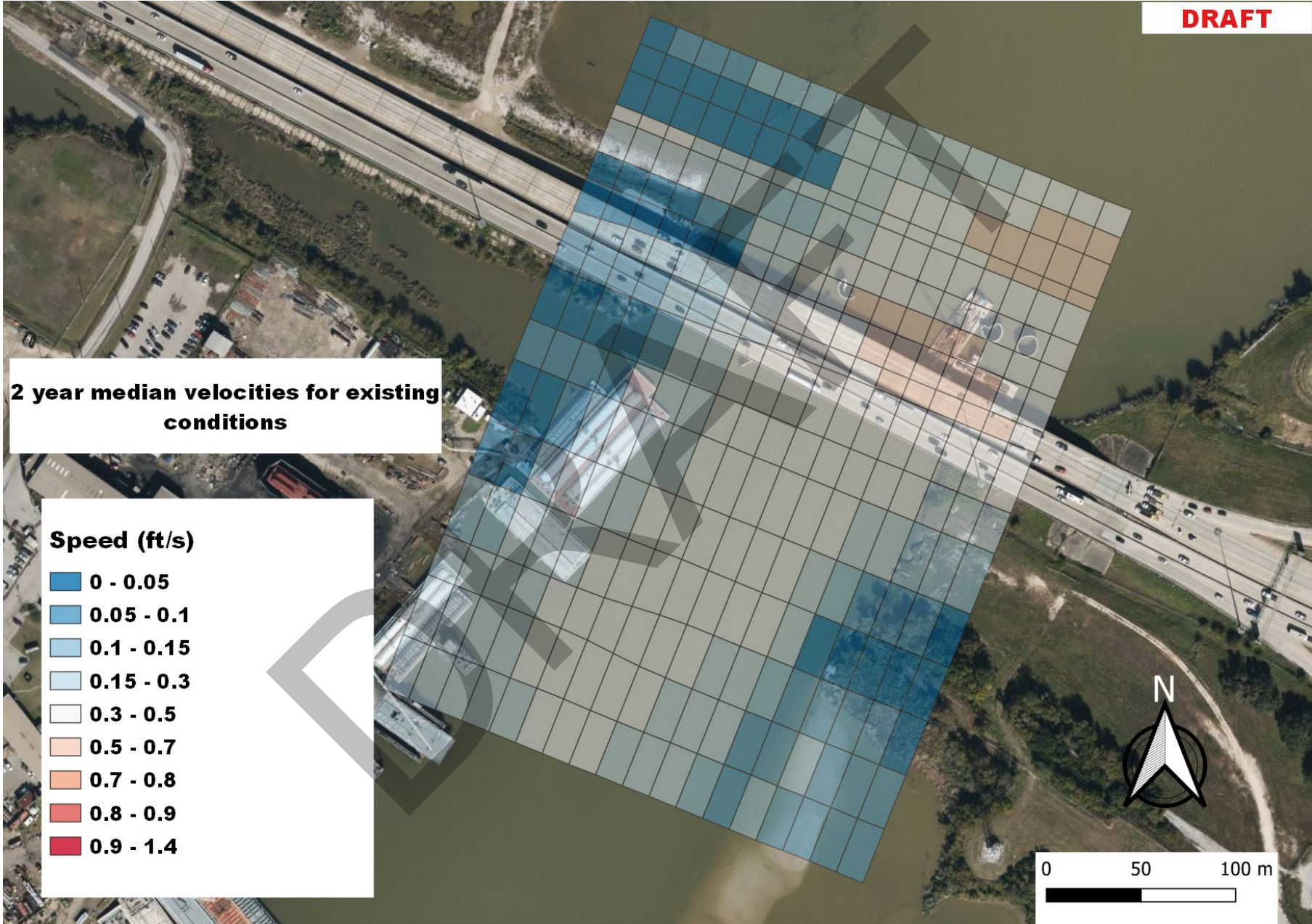
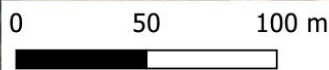





- 0 - 0.05
- 0.05 - 0.1
- 0.1 - 0.15
- 0.15 - 0.3
- 0.3 - 0.5
- 0.5 - 0.7
- 0.7 - 0.8
- 0.8 - 0.9
- 0.9 - 1.4



DRAFT

**2 year median velocities with
Cofferdam**

Speed (ft/s)



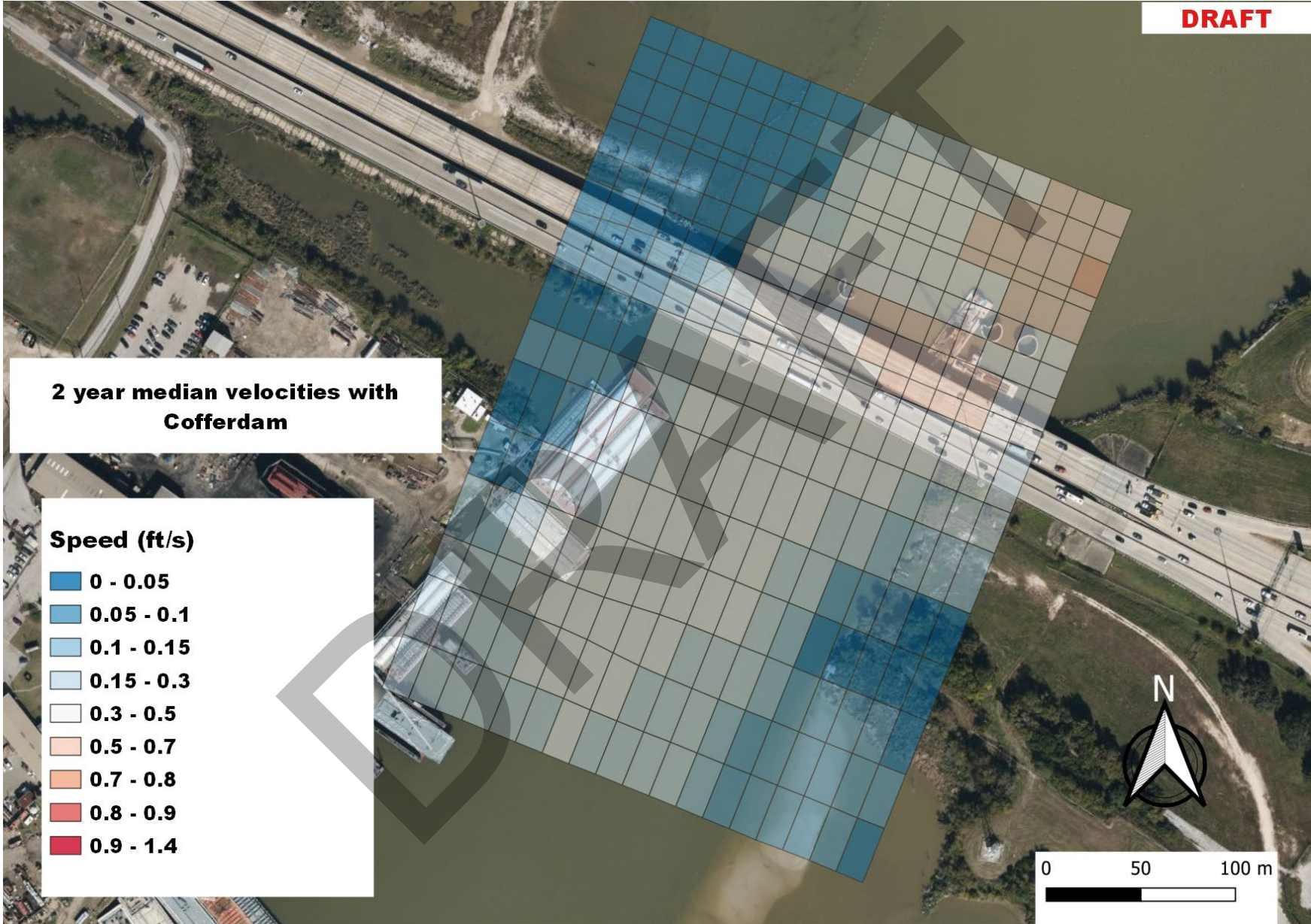
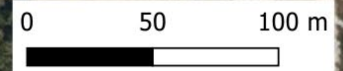





-  0 - 0.05
-  0.05 - 0.1
-  0.1 - 0.15
-  0.15 - 0.3
-  0.3 - 0.5
-  0.5 - 0.7
-  0.7 - 0.8
-  0.8 - 0.9
-  0.9 - 1.4



DRAFT

2 year 95th percentile velocities for existing conditions

Speed (ft/s)

-  0 - 0.05
-  0.05 - 0.1
-  0.1 - 0.15
-  0.15 - 0.3
-  0.3 - 0.5
-  0.5 - 0.7
-  0.7 - 0.8
-  0.8 - 0.9
-  0.9 - 1.4



0 50 100 m



DRAFT

**2 year 95th percentile velocities
with Cofferdam**

Speed (ft/s)



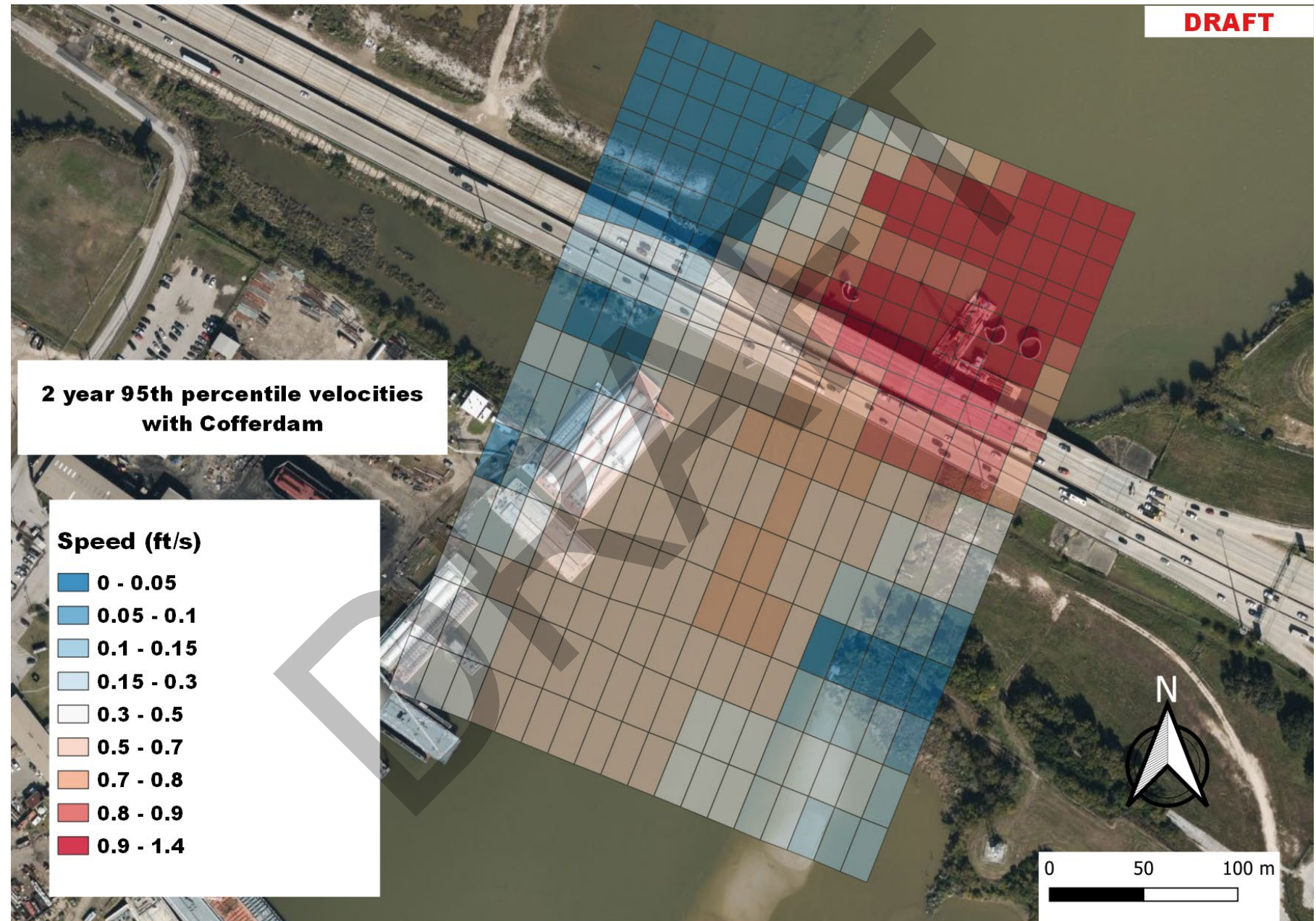
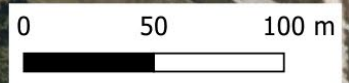

- 0 - 0.05
- 0.05 - 0.1
- 0.1 - 0.15
- 0.15 - 0.3
- 0.3 - 0.5
- 0.5 - 0.7
- 0.7 - 0.8
- 0.8 - 0.9
- 0.9 - 1.4



DRAFT

2 year 95th percentile velocities differences

Speed (ft/s)

-  -0.46 - -0.15
-  -0.15 - -0.05
-  -0.05 - -0.01
-  -0.01 - -0.005
-  -0.005 - 0.005
-  0.005 - 0.01
-  0.01 - 0.1
-  0.1 - 0.15
-  0.15 - 0.22



0 50 100 m

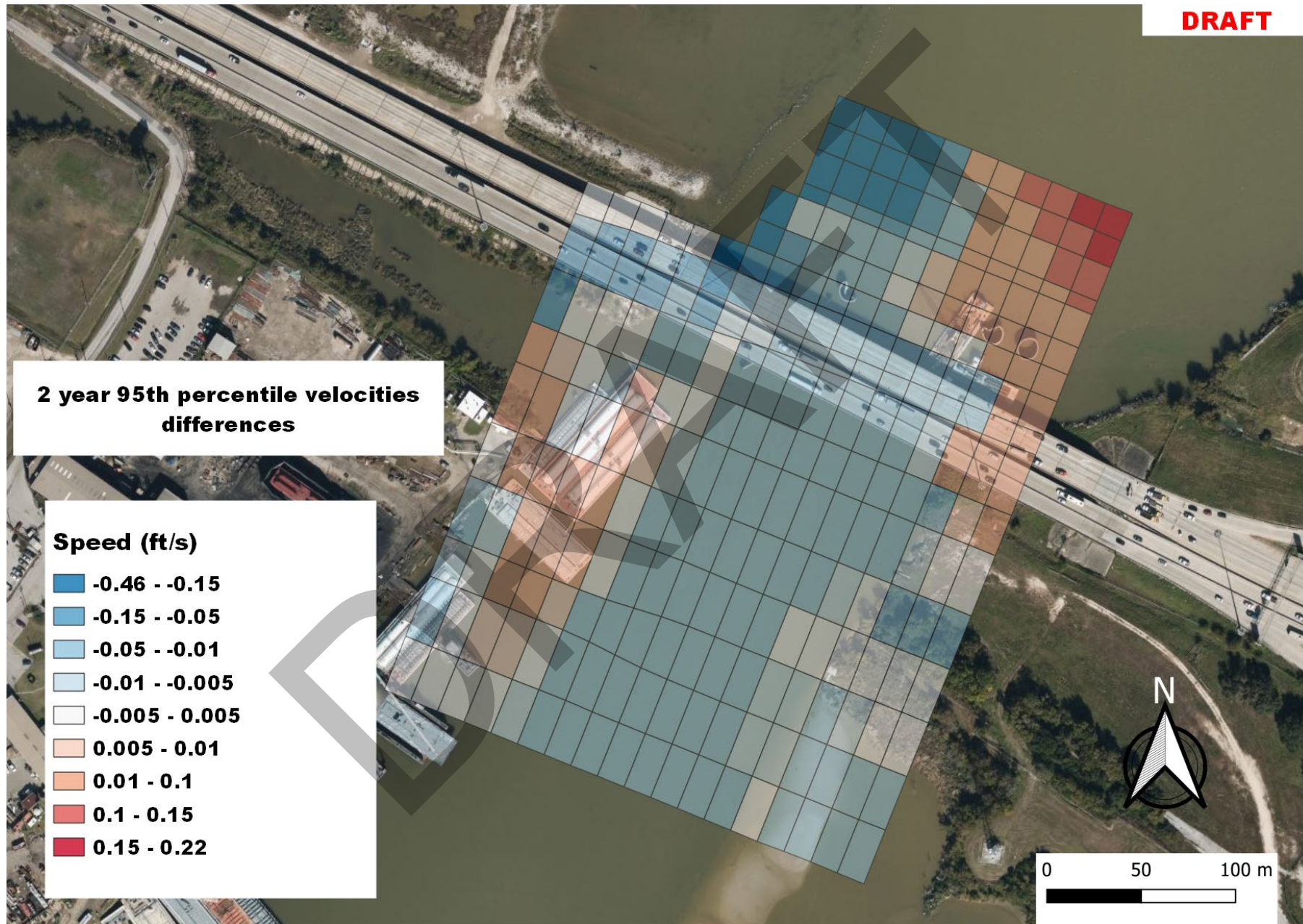

DRAFT

**10 year median velocities for
existing conditions**

Speed (ft/s)











0 50 100 m



DRAFT

**10 year median velocities with
Cofferdam**

Speed (ft/s)

-  0 - 0.05
-  0.05 - 0.1
-  0.1 - 0.15
-  0.15 - 0.3
-  0.3 - 0.5
-  0.5 - 0.7
-  0.7 - 0.8
-  0.8 - 0.9
-  0.9 - 1.4

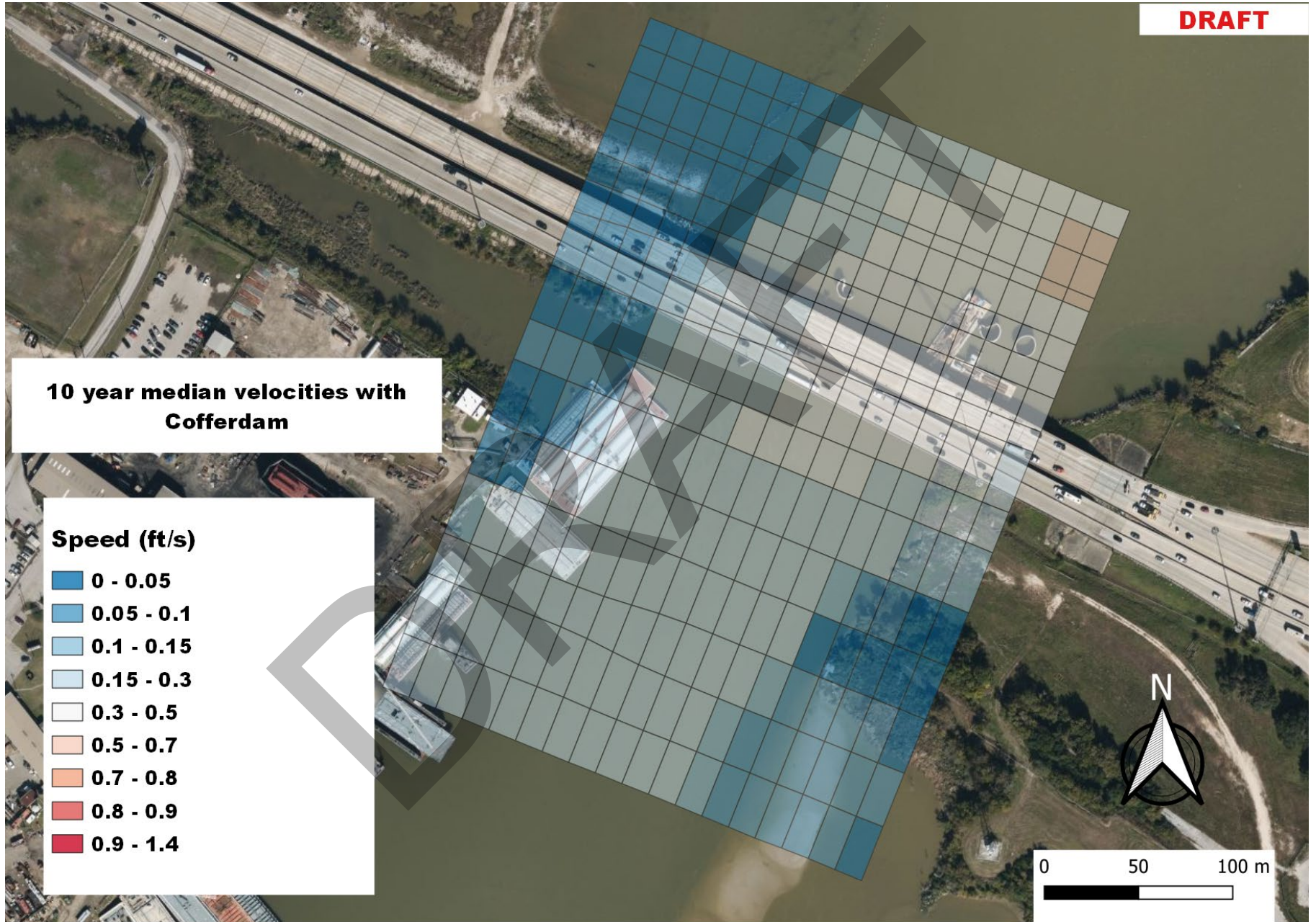

DRAFT

**10 year 95th percentile velocities
for existing conditions**

Speed (ft/s)



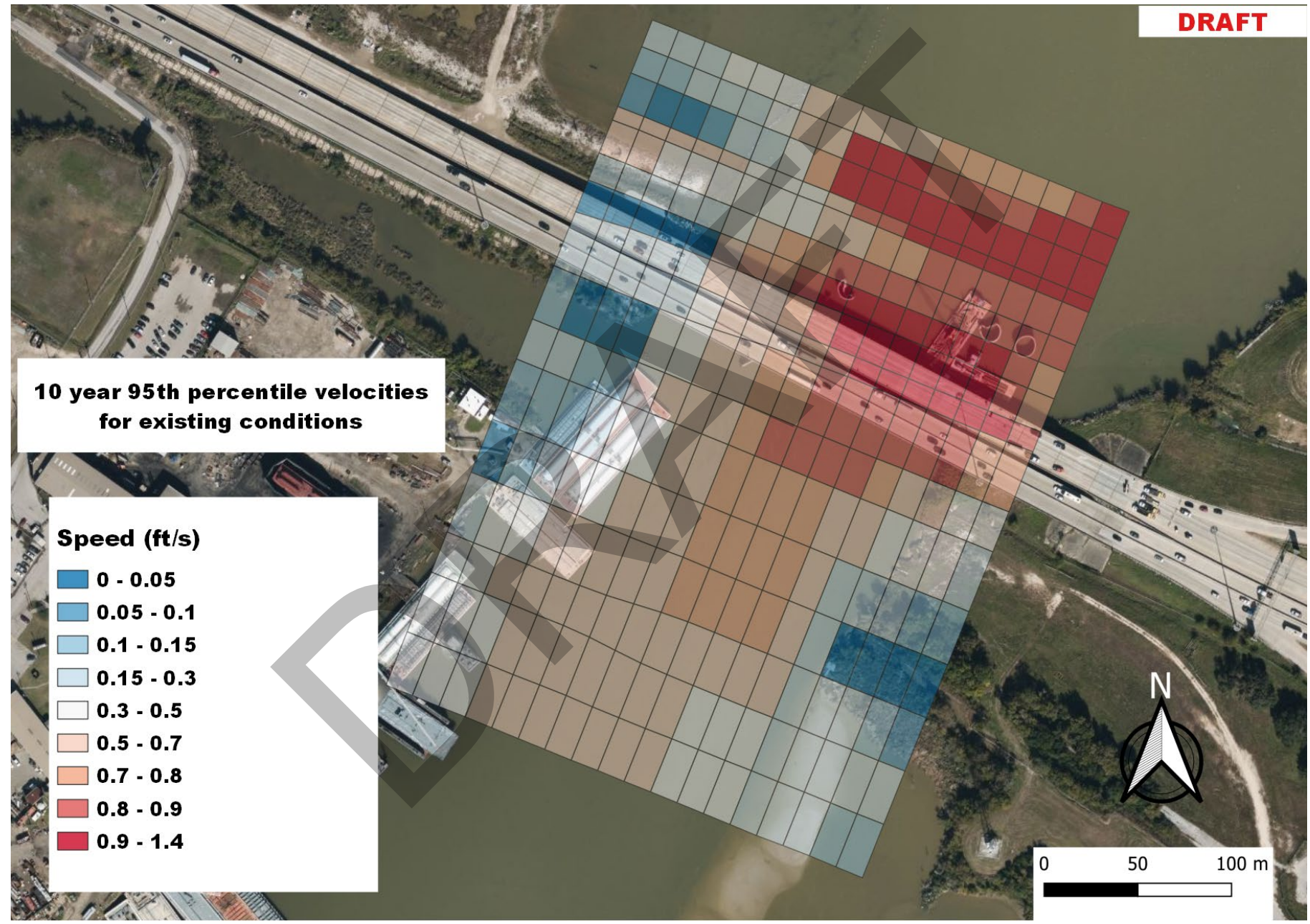
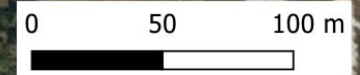





- 0 - 0.05
- 0.05 - 0.1
- 0.1 - 0.15
- 0.15 - 0.3
- 0.3 - 0.5
- 0.5 - 0.7
- 0.7 - 0.8
- 0.8 - 0.9
- 0.9 - 1.4



DRAFT

**10 year 95th percentile velocities
with Cofferdam**

Speed (ft/s)

-  0 - 0.05
-  0.05 - 0.1
-  0.1 - 0.15
-  0.15 - 0.3
-  0.3 - 0.5
-  0.5 - 0.7
-  0.7 - 0.8
-  0.8 - 0.9
-  0.9 - 1.4

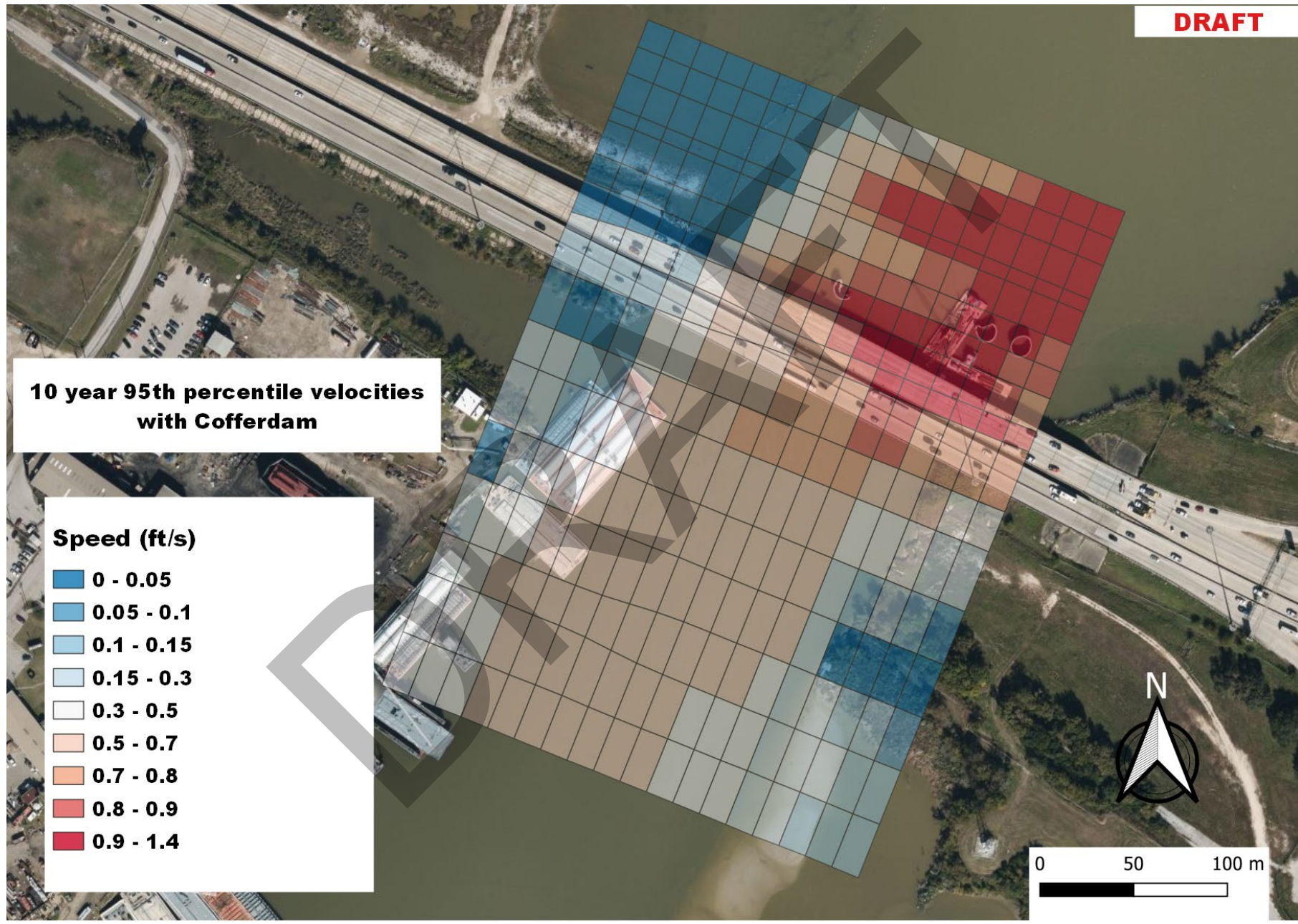

DRAFT

10 year 95th percentile velocities differences

Speed (ft/s)

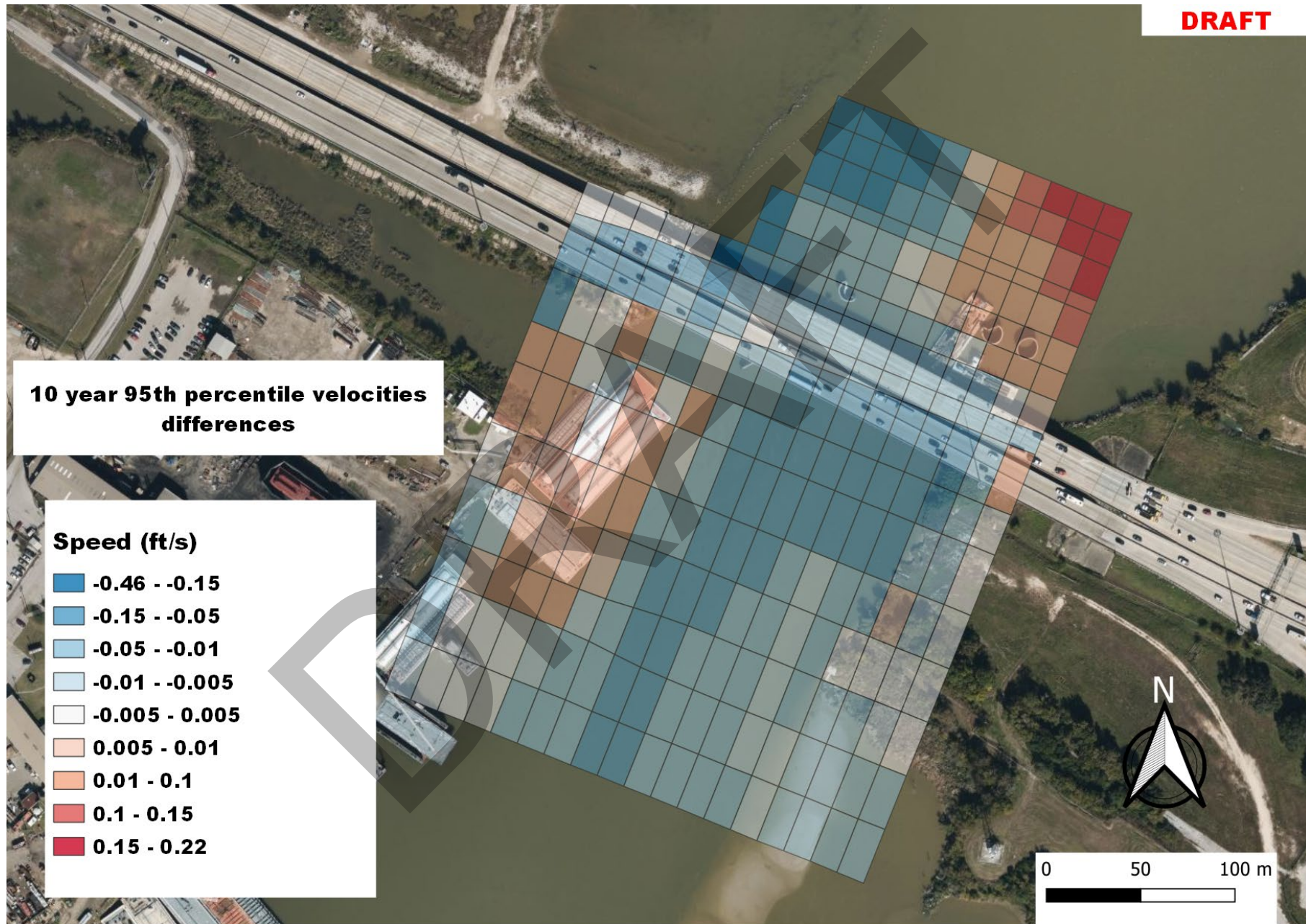
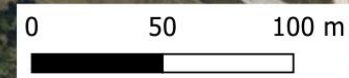

DRAFT

100 year median velocities for existing conditions

Speed (ft/s)

- 0 - 0.05
- 0.05 - 0.1
- 0.1 - 0.15
- 0.15 - 0.3
- 0.3 - 0.5
- 0.5 - 0.7
- 0.7 - 0.8
- 0.8 - 0.9
- 0.9 - 1.4

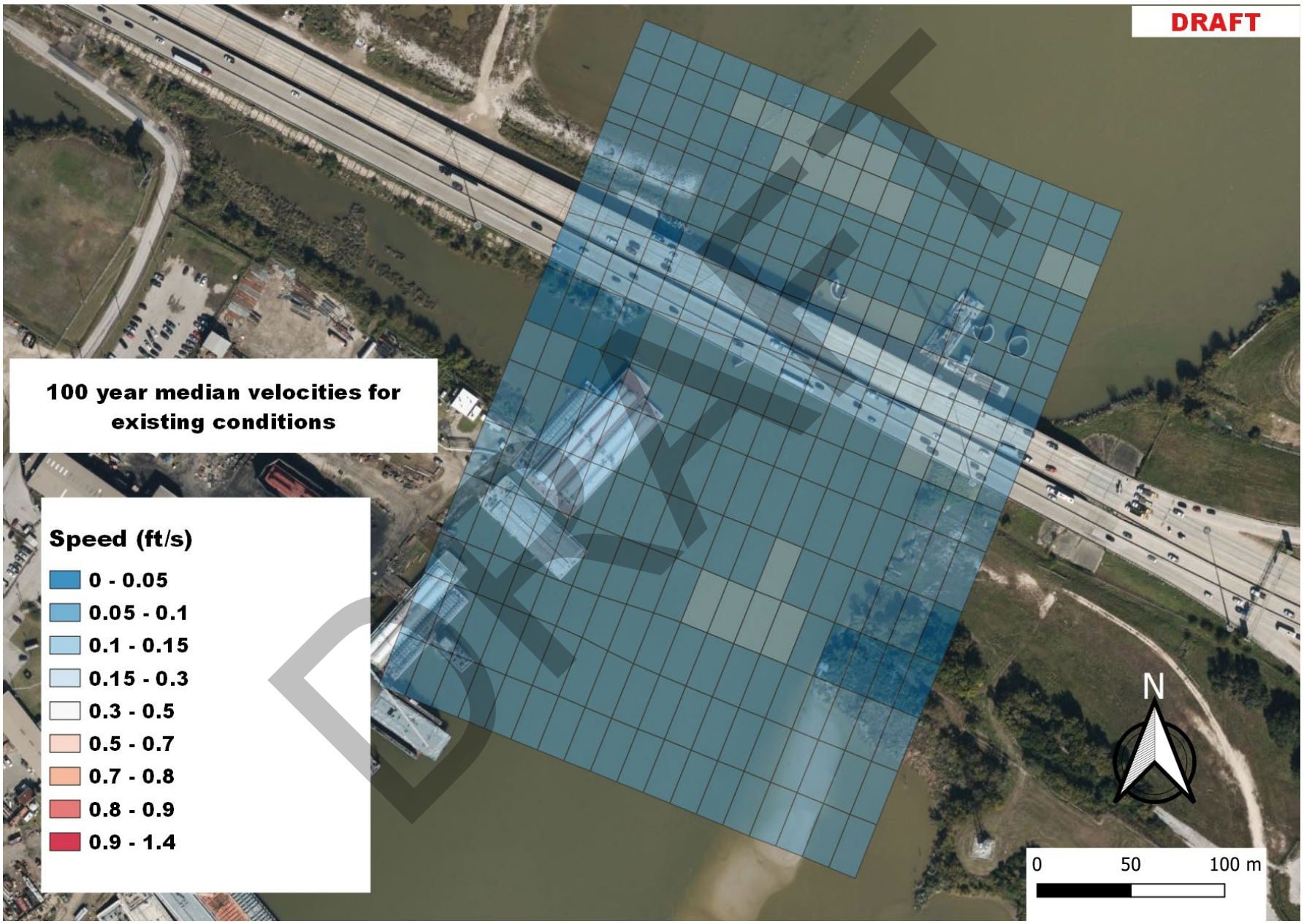
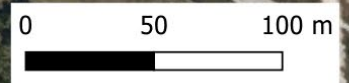

DRAFT

**100 year median velocities with
Cofferdam**

Speed (ft/s)



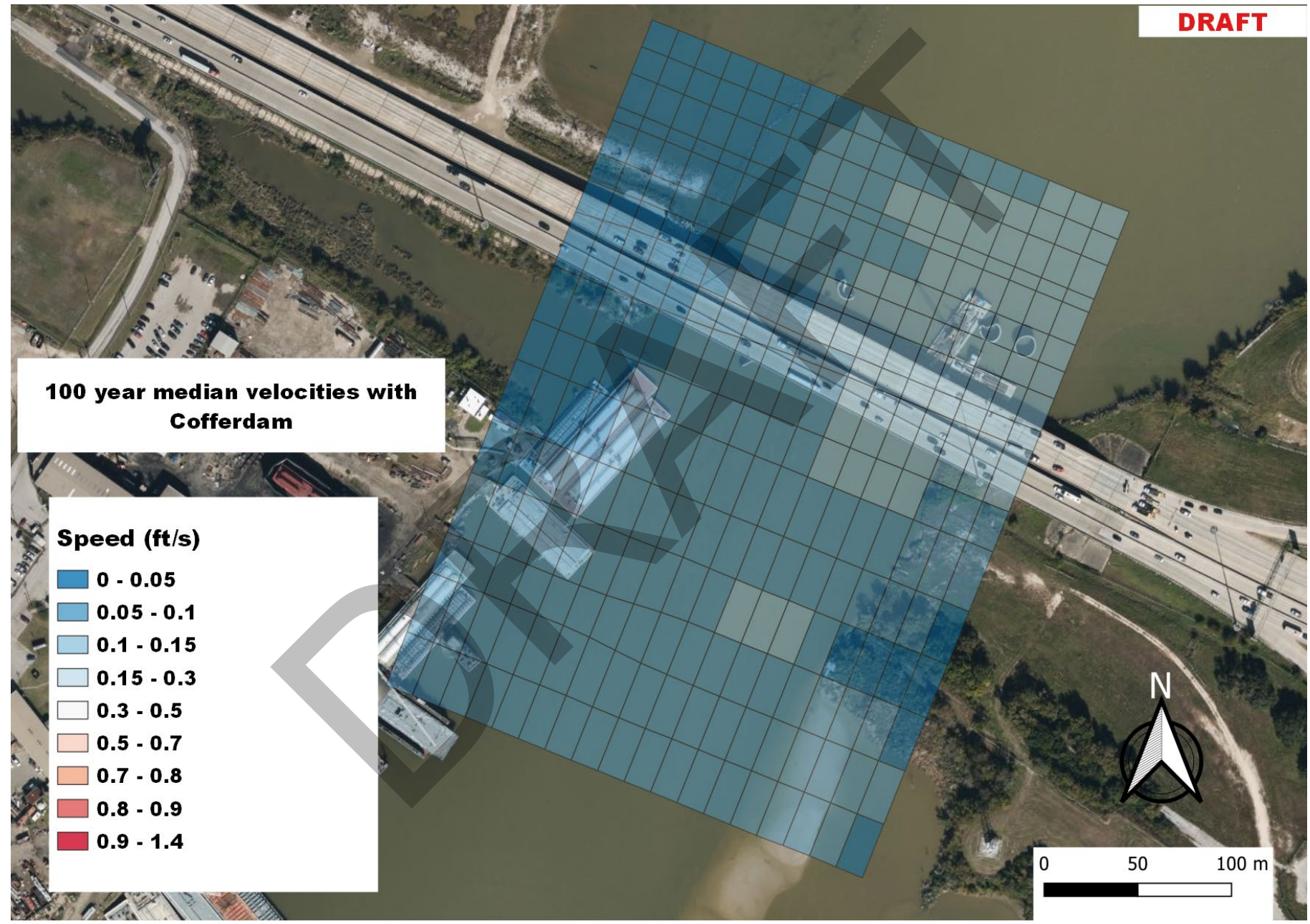





- 0 - 0.05
- 0.05 - 0.1
- 0.1 - 0.15
- 0.15 - 0.3
- 0.3 - 0.5
- 0.5 - 0.7
- 0.7 - 0.8
- 0.8 - 0.9
- 0.9 - 1.4



DRAFT

**100 year 95th percentile velocities
for existing conditions**

Speed (ft/s)

-  0 - 0.05
-  0.05 - 0.1
-  0.1 - 0.15
-  0.15 - 0.3
-  0.3 - 0.5
-  0.5 - 0.7
-  0.7 - 0.8
-  0.8 - 0.9
-  0.9 - 1.4

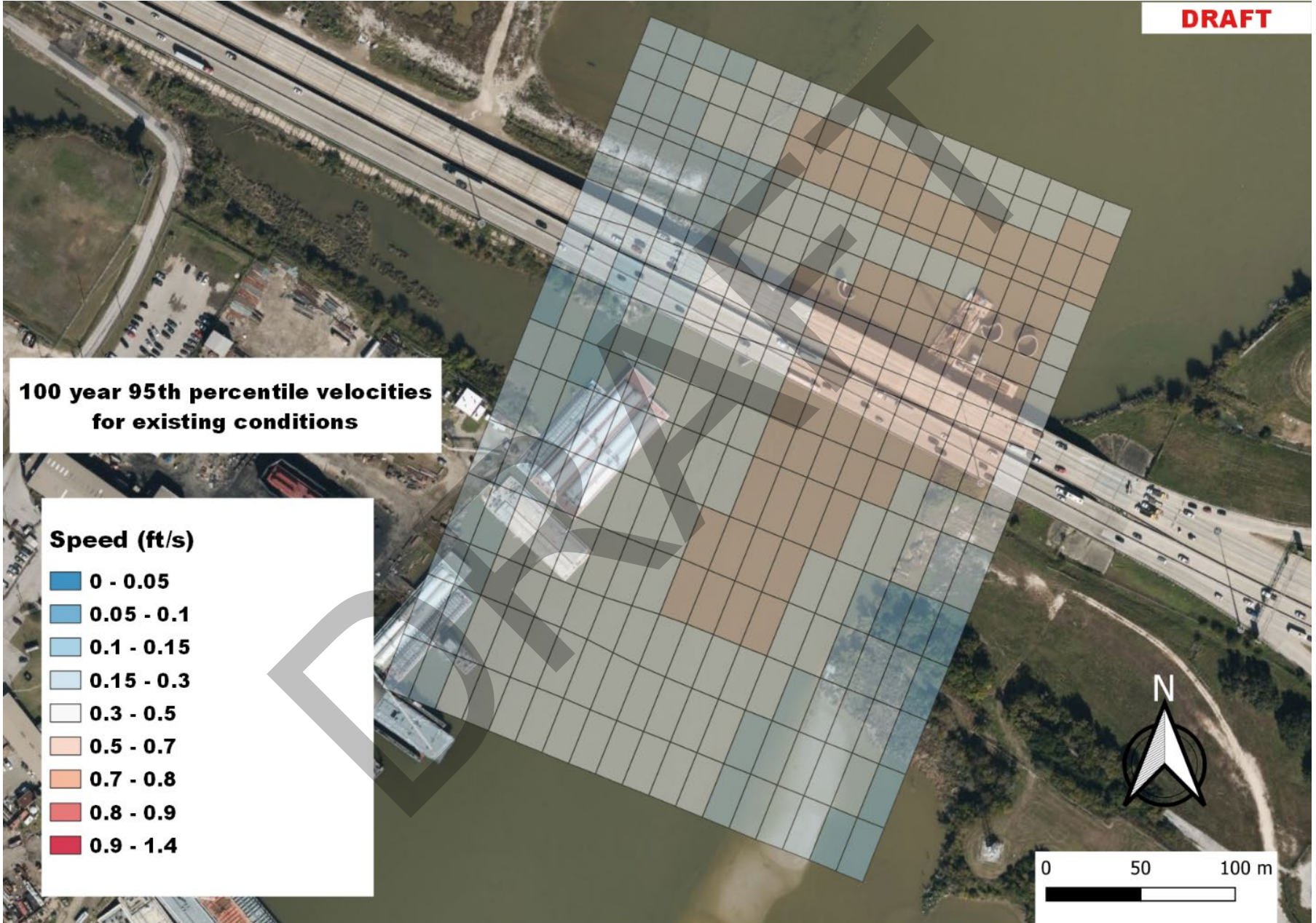
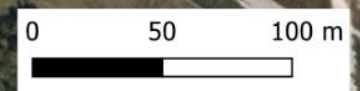

DRAFT

**100 year 95th percentile velocities
with Cofferdam**

Speed (ft/s)



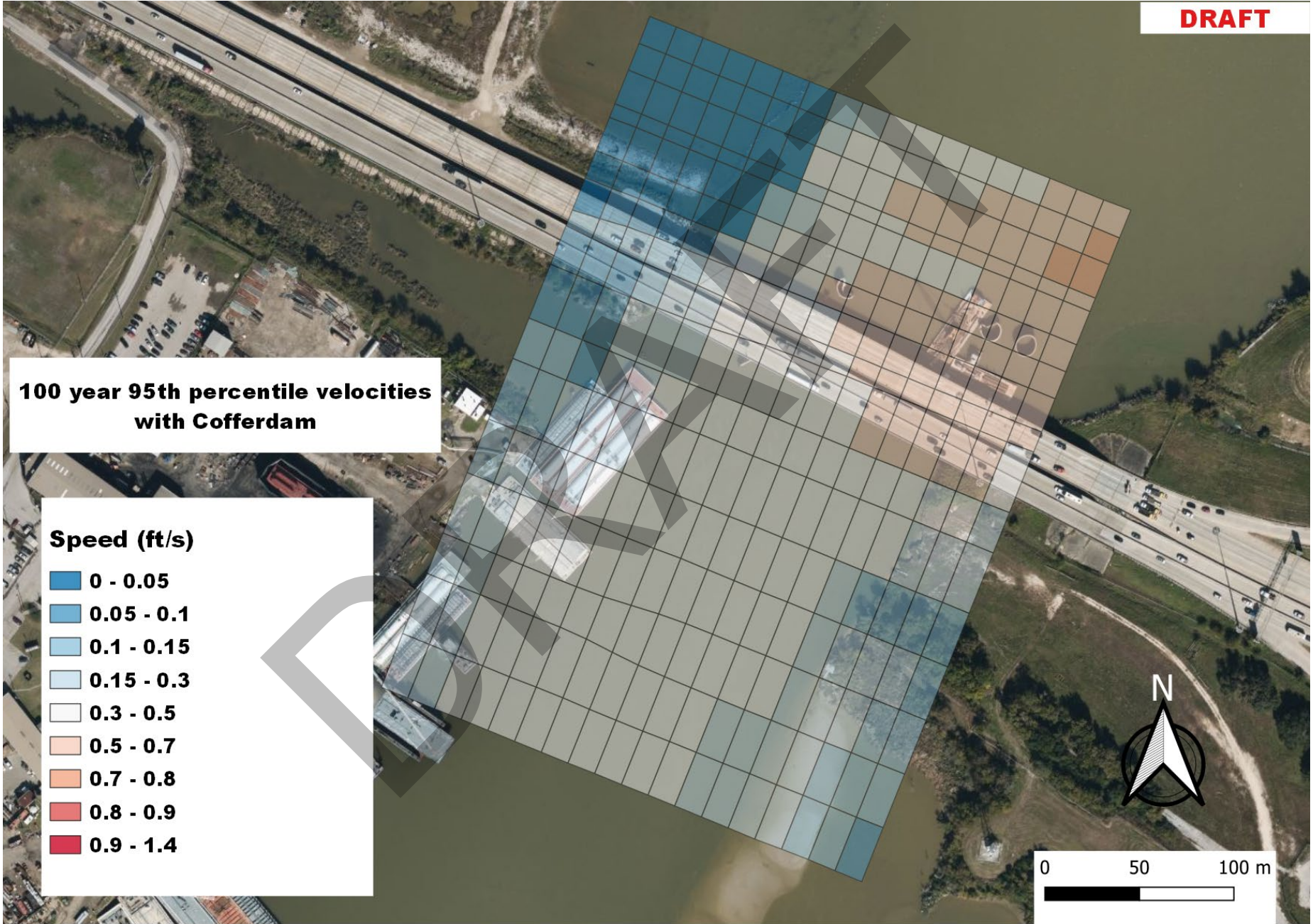





- 0 - 0.05
- 0.05 - 0.1
- 0.1 - 0.15
- 0.15 - 0.3
- 0.3 - 0.5
- 0.5 - 0.7
- 0.7 - 0.8
- 0.8 - 0.9
- 0.9 - 1.4



DRAFT

100 year 95th percentile velocities differences

Speed (ft/s)

-  -0.46 - -0.15
-  -0.15 - -0.05
-  -0.05 - -0.01
-  -0.01 - -0.005
-  -0.005 - 0.005
-  0.005 - 0.01
-  0.01 - 0.1
-  0.1 - 0.15
-  0.15 - 0.22

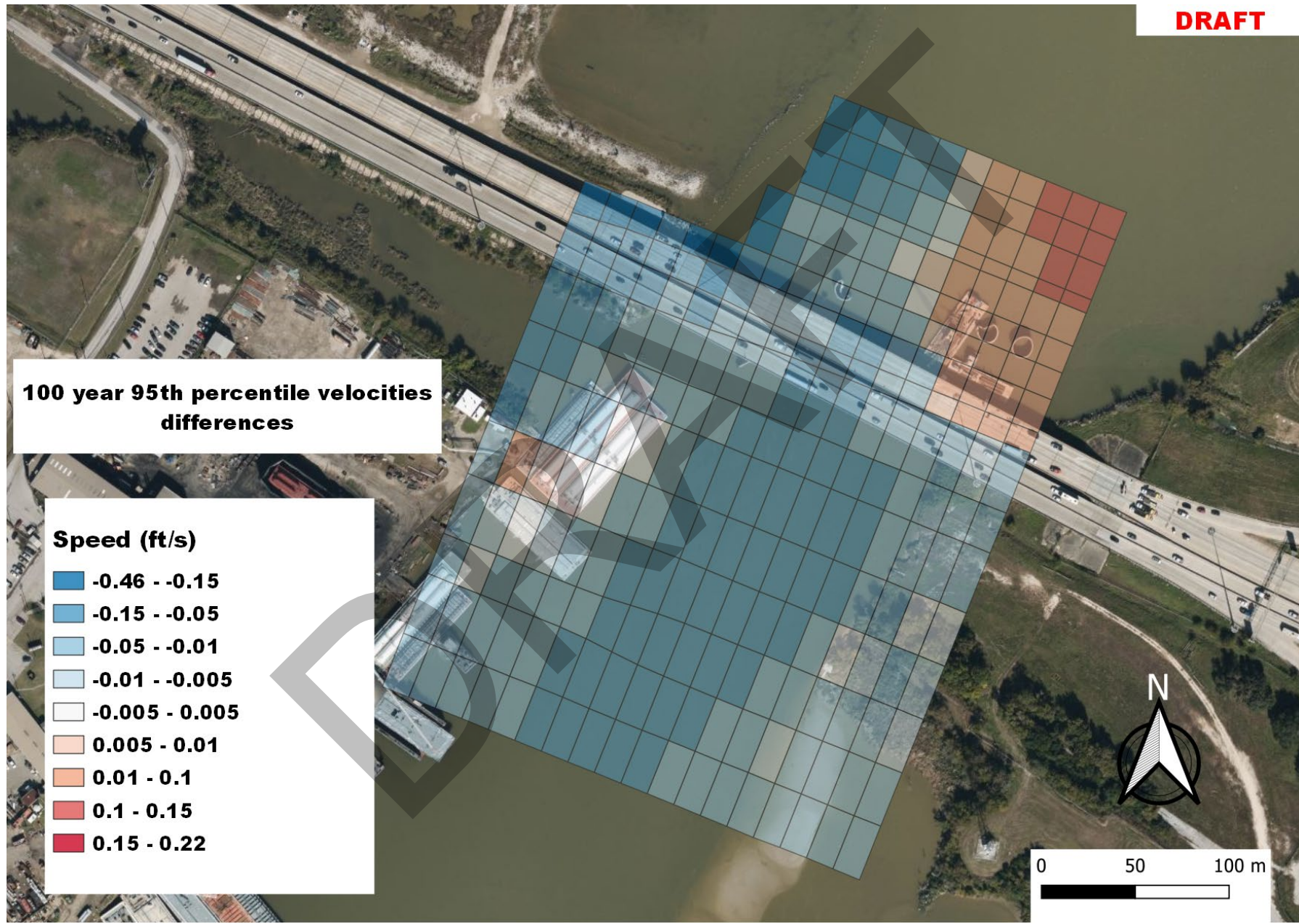
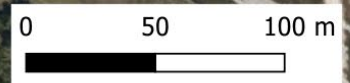









Shear Stress Figures

DRAFT

DRAFT

2 year median shear stress for existing conditions

Shear Stress (Pa)

-  0 - 0.005
-  0.005 - 0.008
-  0.008 - 0.02
-  0.02 - 0.06
-  0.06 - 0.08
-  0.08 - 0.12
-  0.12 - 0.18
-  0.18 - 0.25
-  0.25 - 0.52

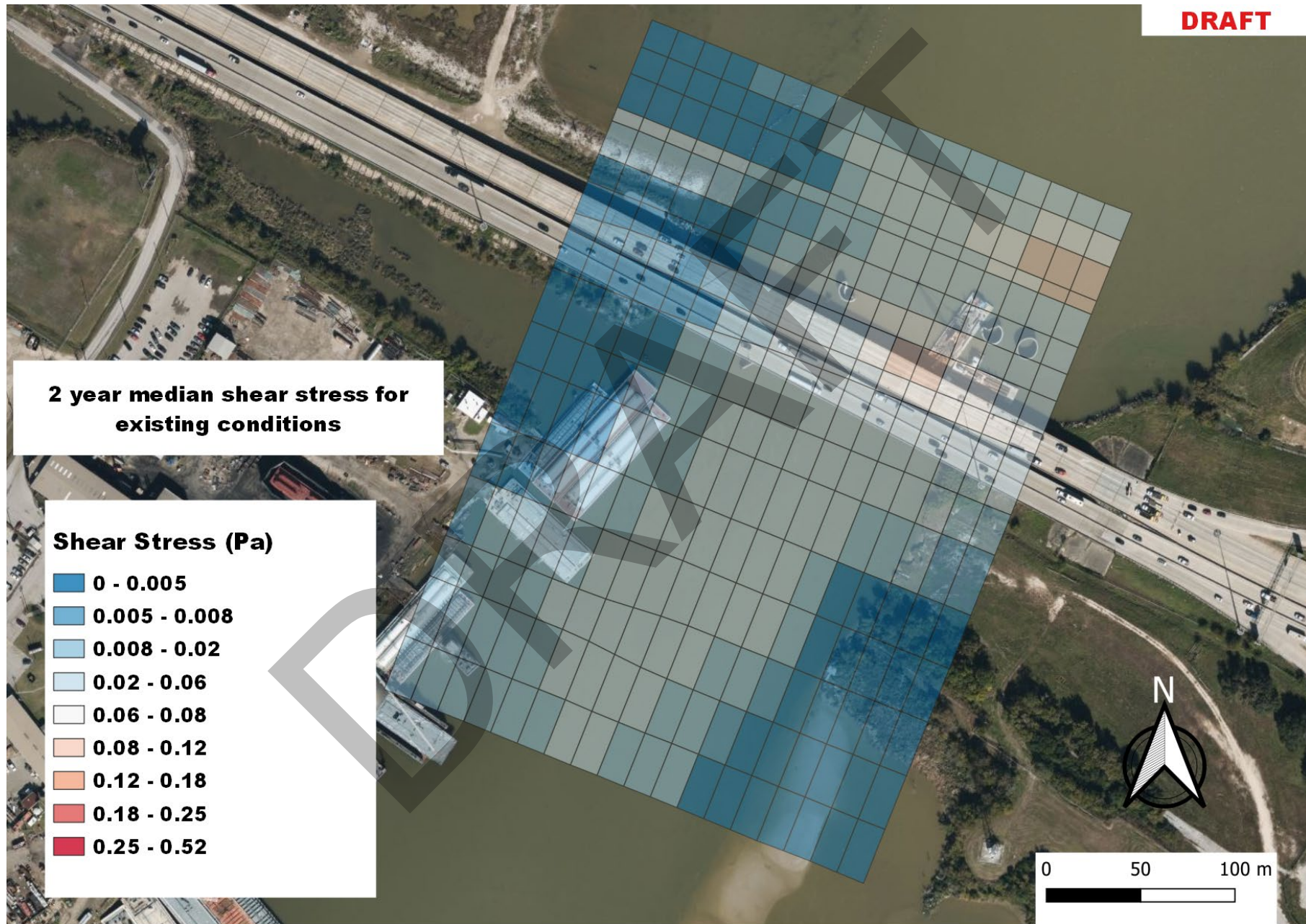
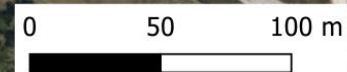

DRAFT

**2 year median shear stress with
Cofferdam**

Shear Stress (Pa)

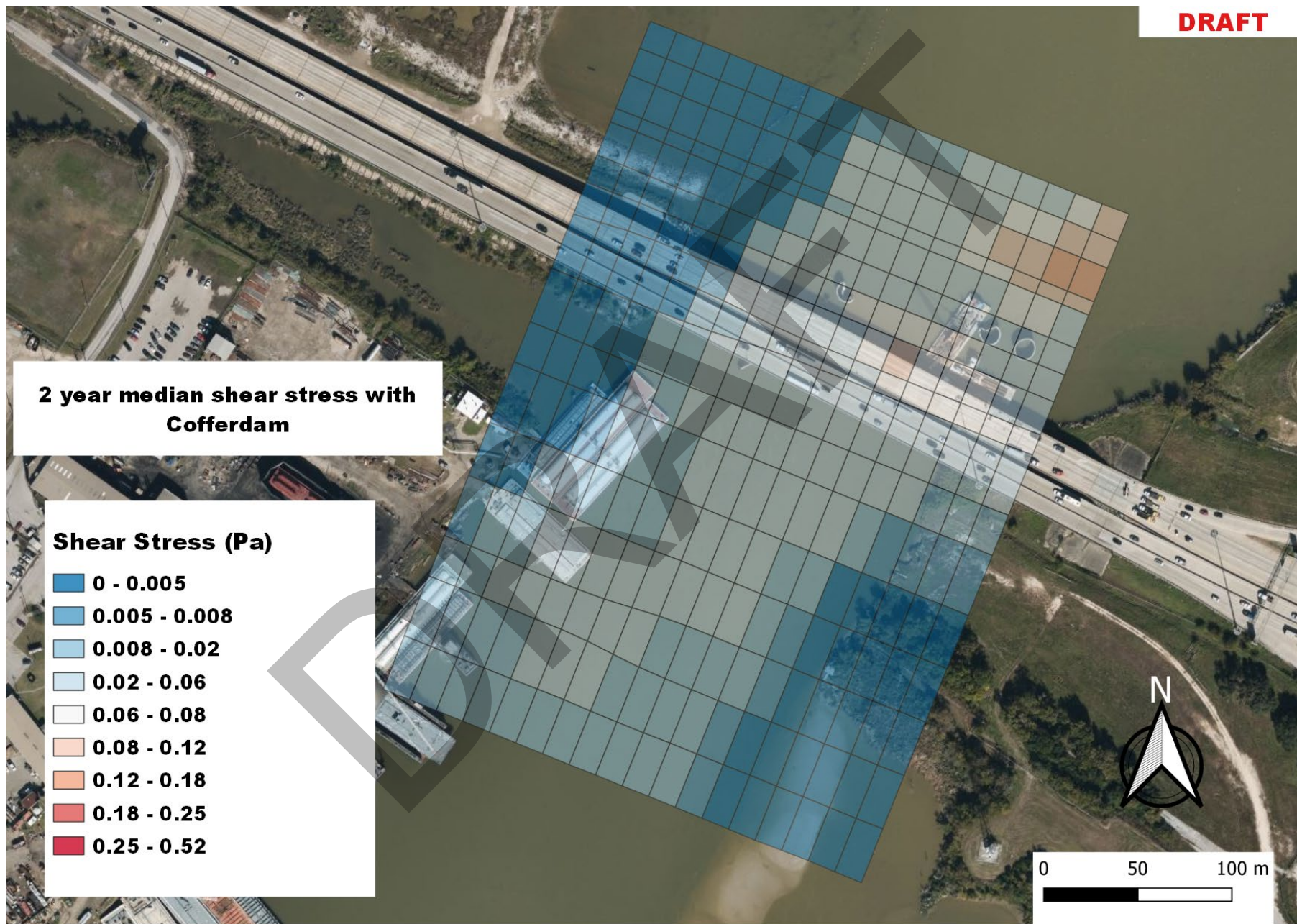
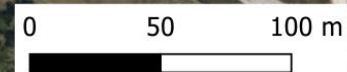
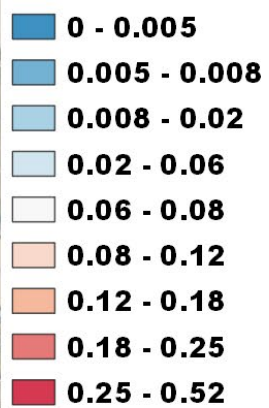

DRAFT

**2 year 95th percentile shear stress
for existing conditions**

Shear Stress (Pa)



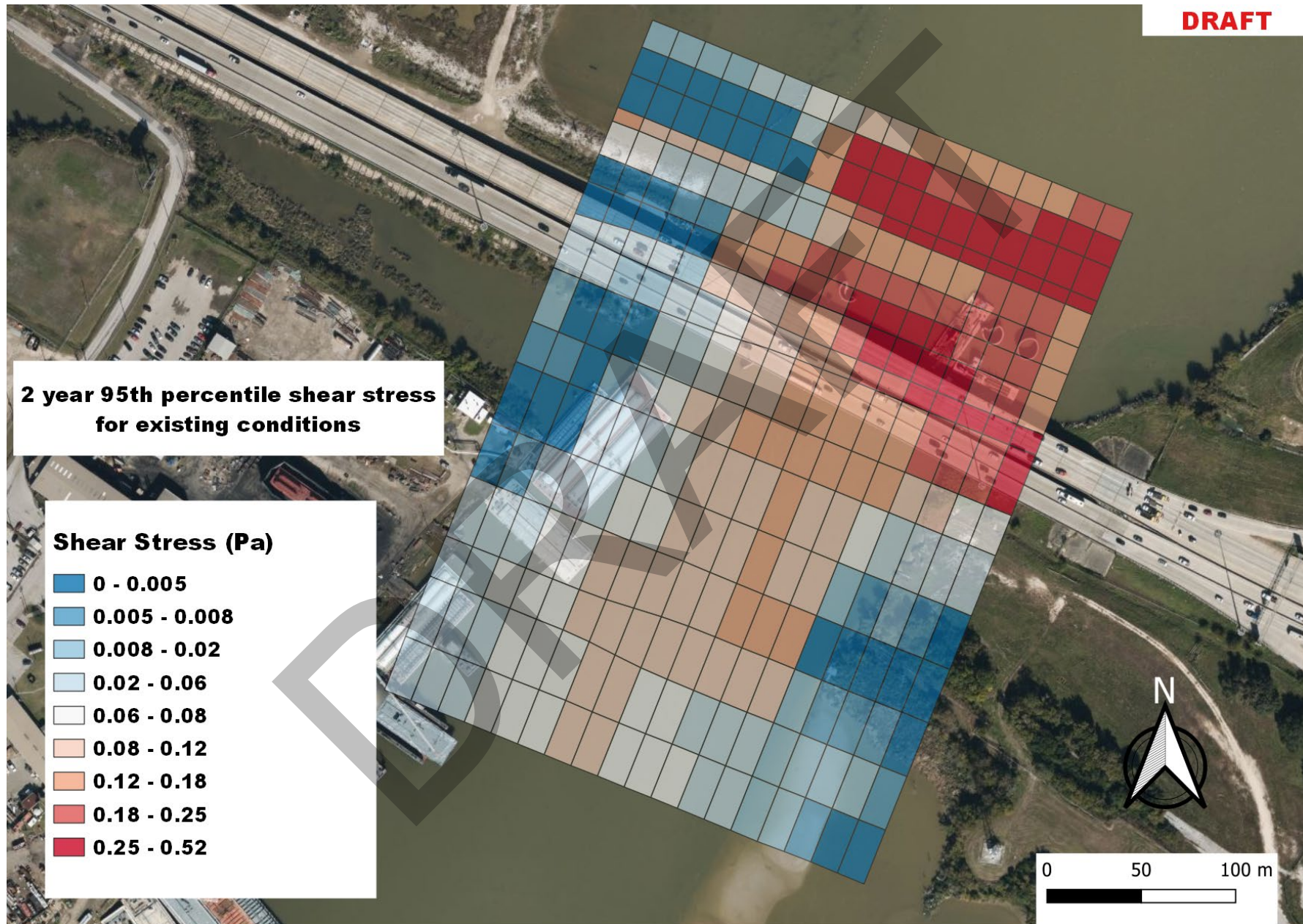





- 0 - 0.005
- 0.005 - 0.008
- 0.008 - 0.02
- 0.02 - 0.06
- 0.06 - 0.08
- 0.08 - 0.12
- 0.12 - 0.18
- 0.18 - 0.25
- 0.25 - 0.52



DRAFT

2 year 95th percentile shear stress with Cofferdam

Shear Stress (Pa)

-  0 - 0.005
-  0.005 - 0.008
-  0.008 - 0.02
-  0.02 - 0.06
-  0.06 - 0.08
-  0.08 - 0.12
-  0.12 - 0.18
-  0.18 - 0.25
-  0.25 - 0.52

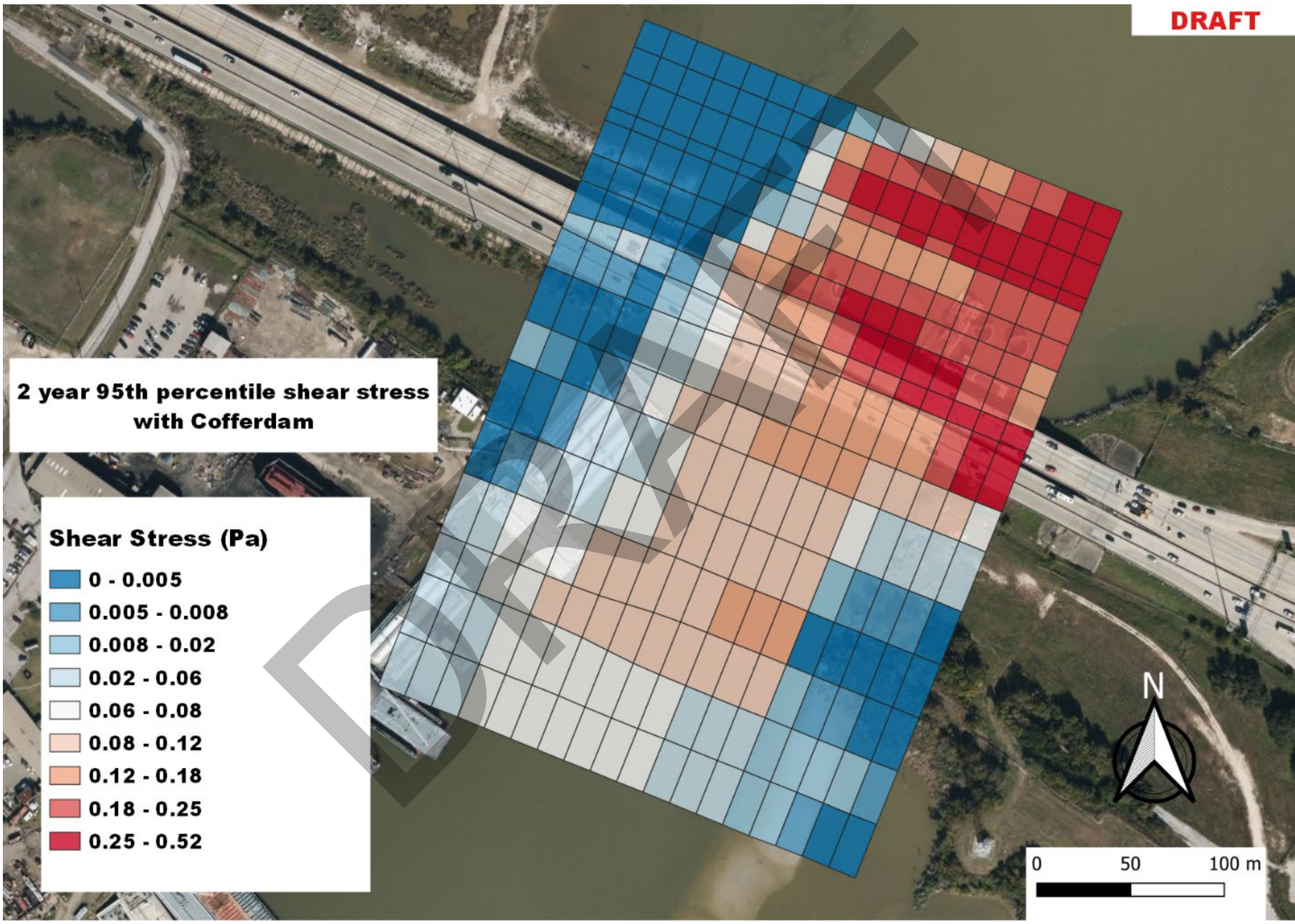
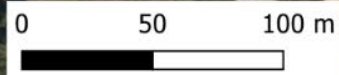

DRAFT

2 year 95th percentile shear stresses differences

Shear Stress (ft/s)

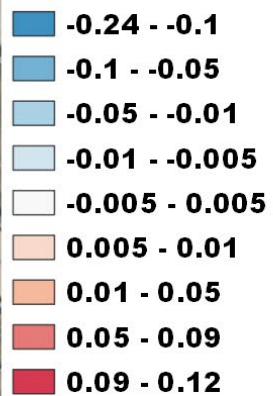

0 50 100 m



DRAFT

10 year median shear stress for existing conditions

Shear Stress (Pa)

- 0 - 0.005
- 0.005 - 0.008
- 0.008 - 0.02
- 0.02 - 0.06
- 0.06 - 0.08
- 0.08 - 0.12
- 0.12 - 0.18
- 0.18 - 0.25
- 0.25 - 0.52

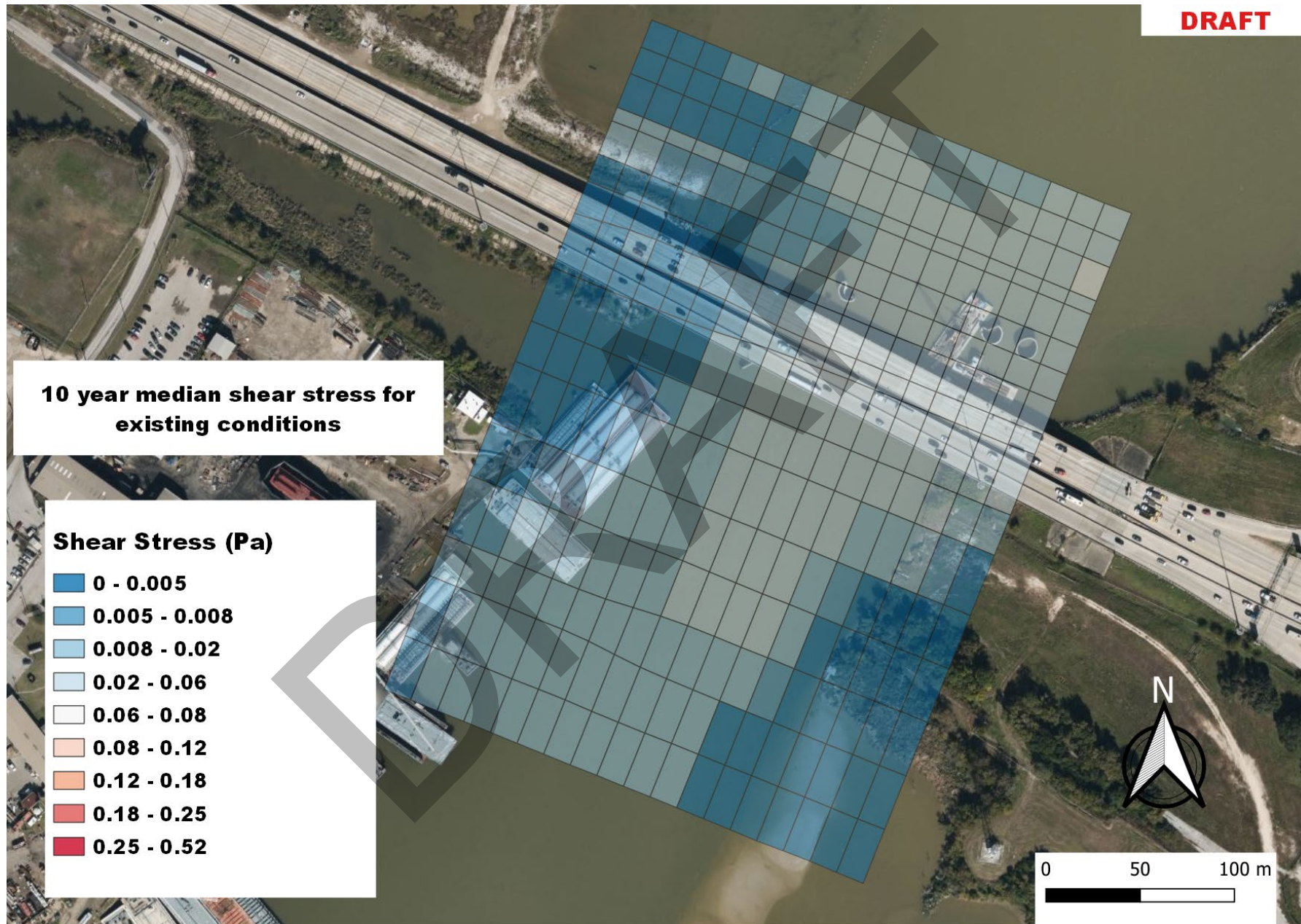
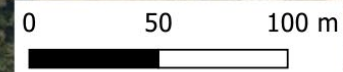

DRAFT

**10 year median shear stress with
Cofferdam**



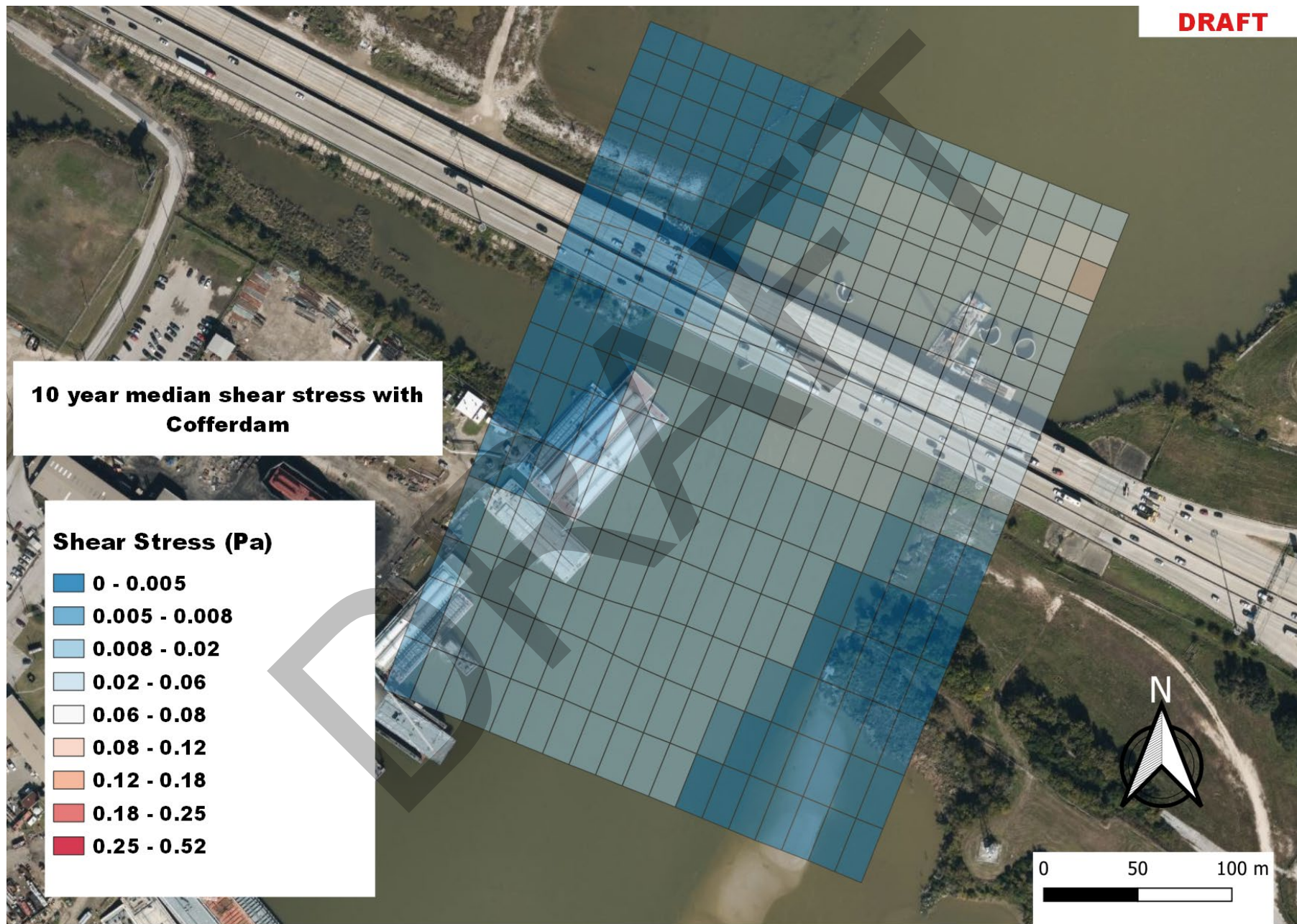
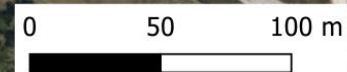
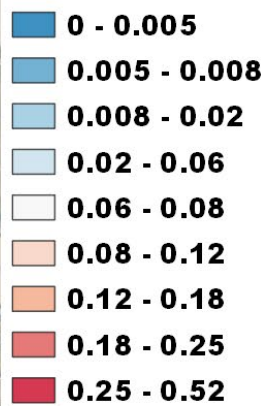





Shear Stress (Pa)



DRAFT

**10 year 95th percentile shear stress
for existing conditions**

Shear Stress (Pa)



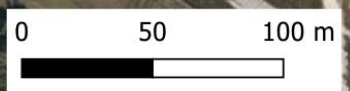
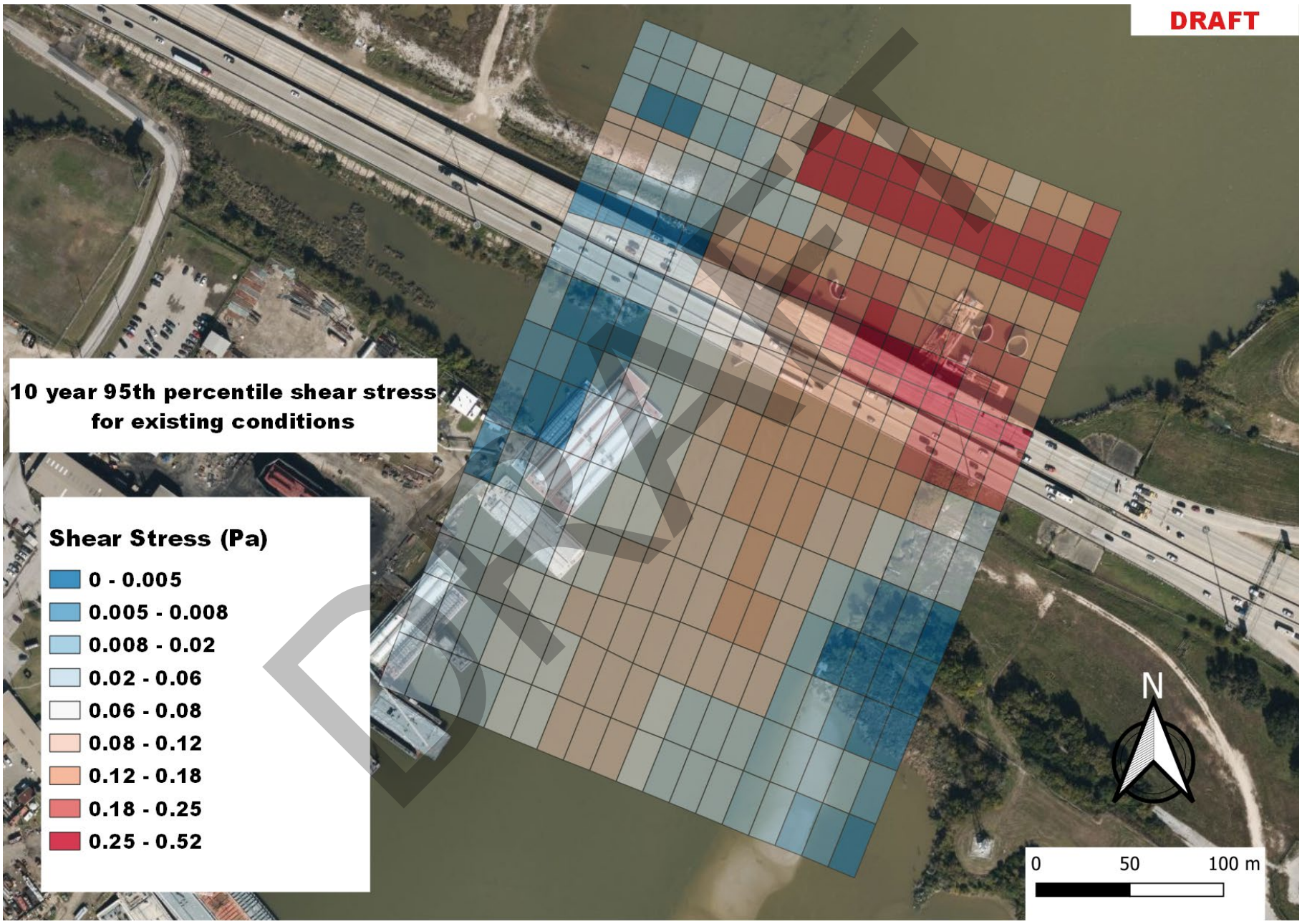





-  0 - 0.005
-  0.005 - 0.008
-  0.008 - 0.02
-  0.02 - 0.06
-  0.06 - 0.08
-  0.08 - 0.12
-  0.12 - 0.18
-  0.18 - 0.25
-  0.25 - 0.52



DRAFT

**10 year 95th percentile shear stress
with Cofferdam**

Shear Stress (Pa)



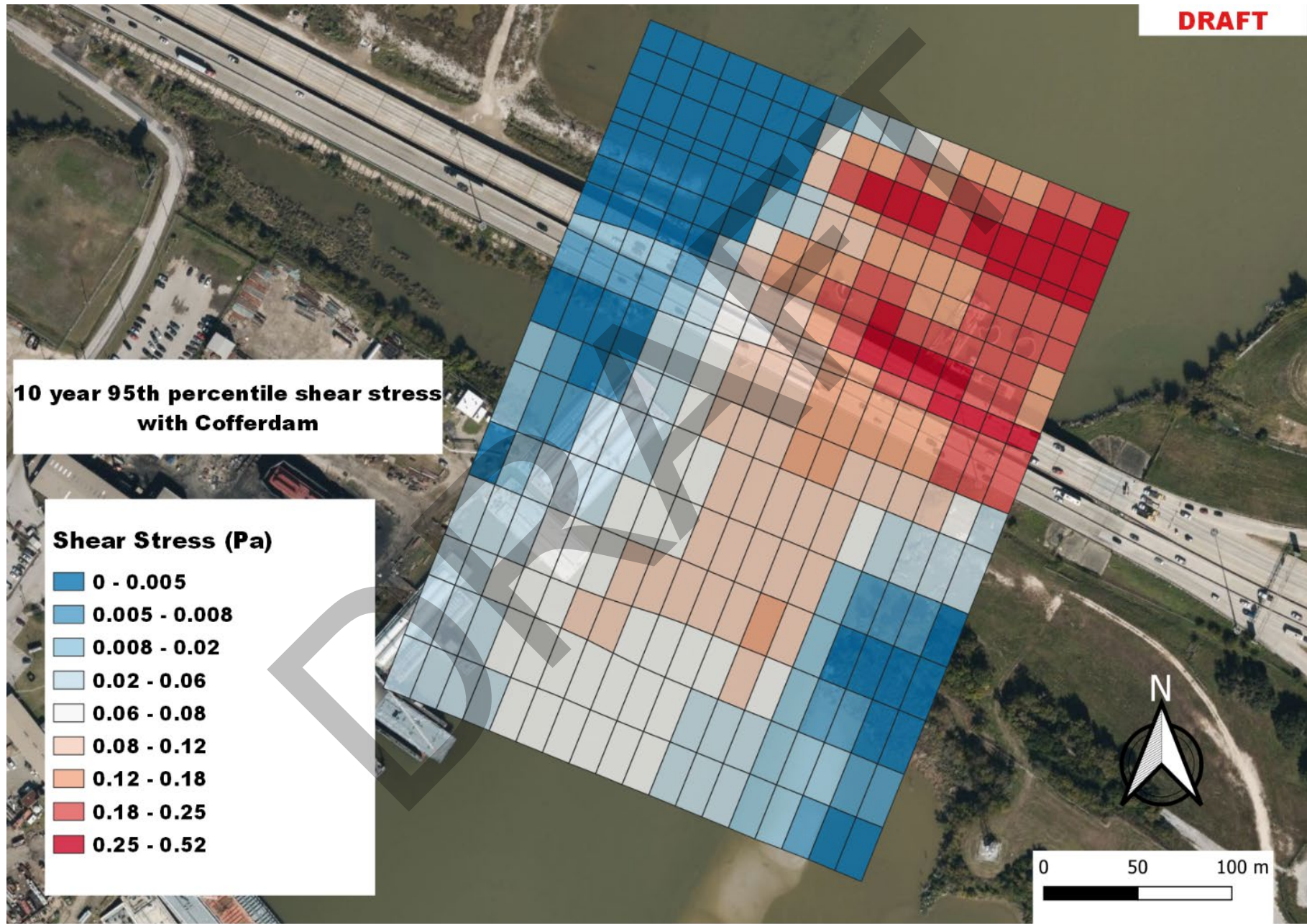
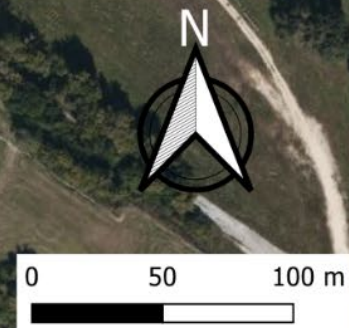





-  0 - 0.005
-  0.005 - 0.008
-  0.008 - 0.02
-  0.02 - 0.06
-  0.06 - 0.08
-  0.08 - 0.12
-  0.12 - 0.18
-  0.18 - 0.25
-  0.25 - 0.52



DRAFT

10 year 95th percentile shear stresses differences

Shear Stress (ft/s)

-  -0.24 - -0.1
-  -0.1 - -0.05
-  -0.05 - -0.01
-  -0.01 - -0.005
-  -0.005 - 0.005
-  0.005 - 0.01
-  0.01 - 0.05
-  0.05 - 0.09
-  0.09 - 0.12

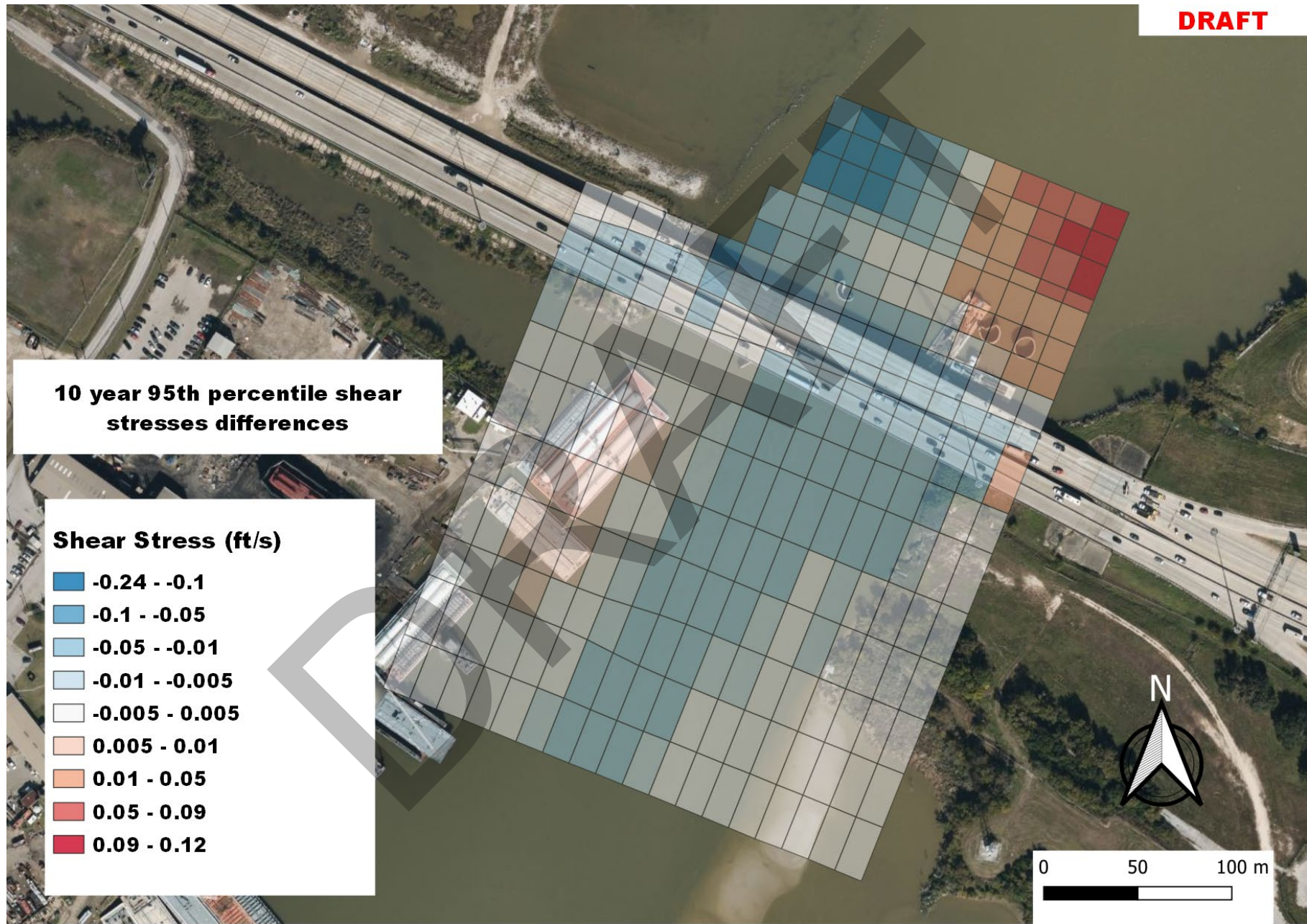

DRAFT

100 year median shear stress for existing conditions

Shear Stress (Pa)

- 0 - 0.005
- 0.005 - 0.008
- 0.008 - 0.02
- 0.02 - 0.06
- 0.06 - 0.08
- 0.08 - 0.12
- 0.12 - 0.18
- 0.18 - 0.25
- 0.25 - 0.52

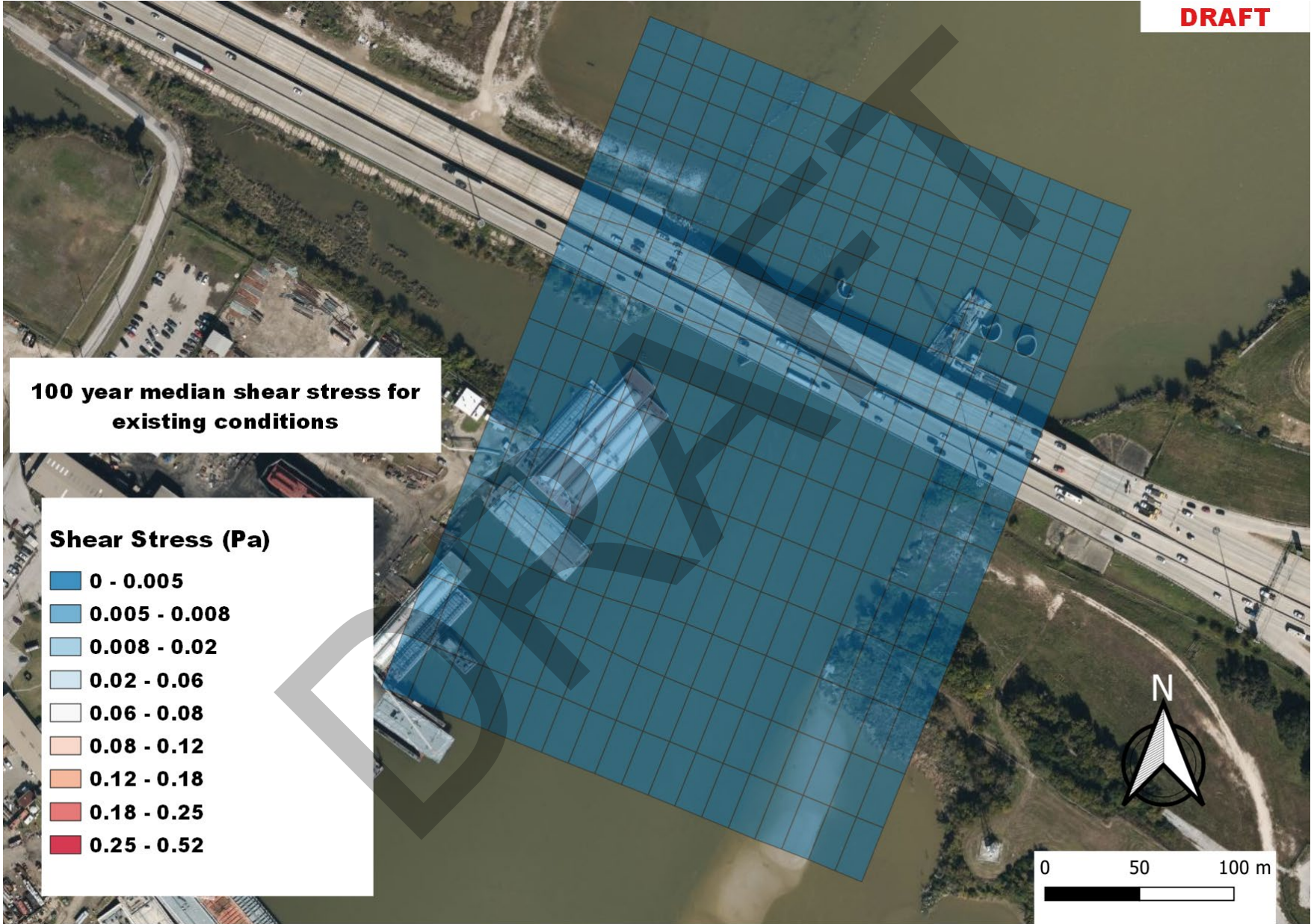

DRAFT

100 year median shear stress with Cofferdam

Shear Stress (Pa)

- 0 - 0.005
- 0.005 - 0.008
- 0.008 - 0.02
- 0.02 - 0.06
- 0.06 - 0.08
- 0.08 - 0.12
- 0.12 - 0.18
- 0.18 - 0.25
- 0.25 - 0.52

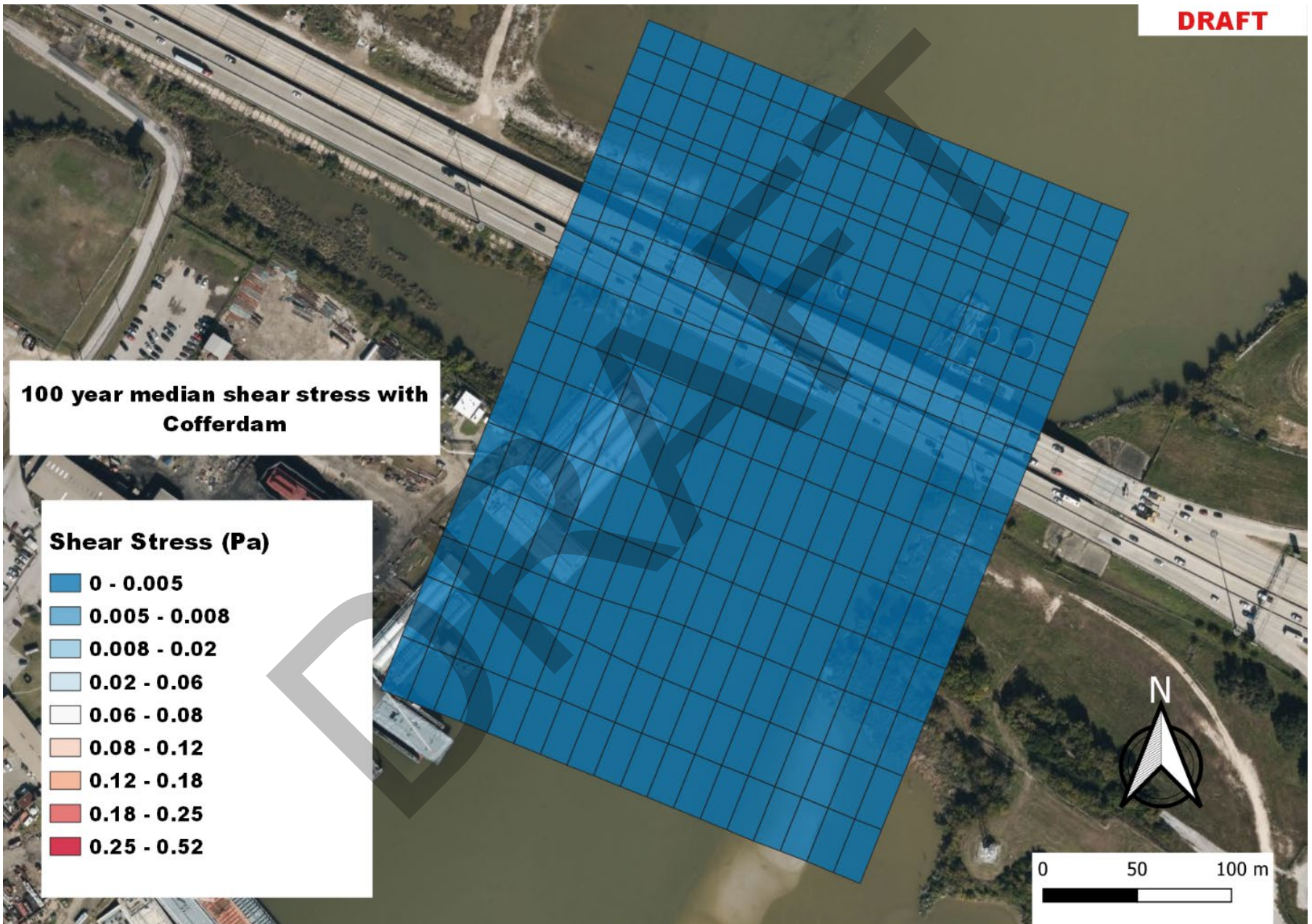
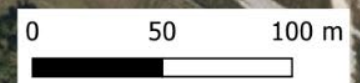

DRAFT

100 year 95th percentile shear stress for existing conditions

Shear Stress (Pa)



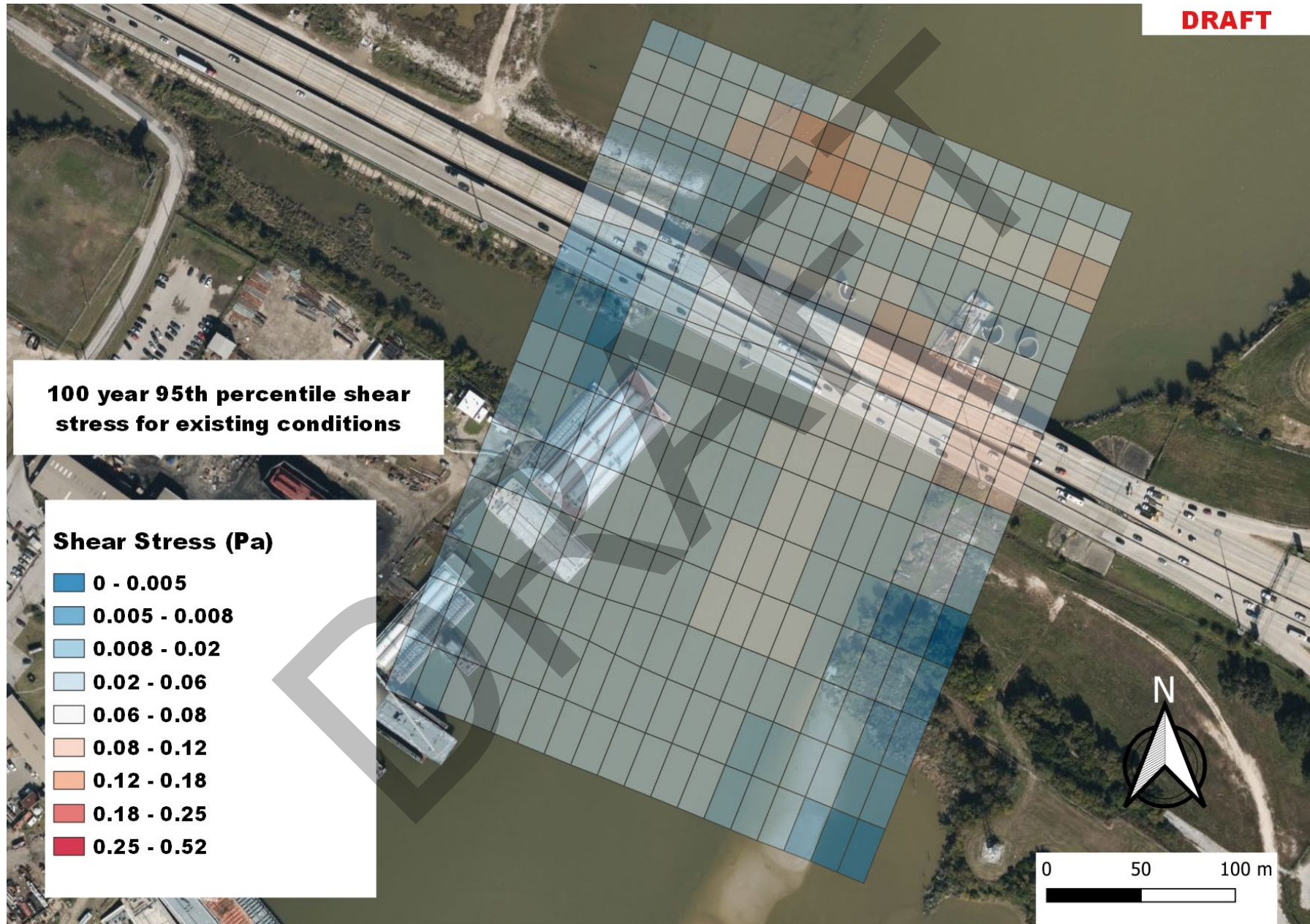
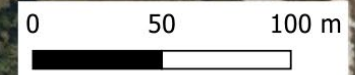





- 0 - 0.005
- 0.005 - 0.008
- 0.008 - 0.02
- 0.02 - 0.06
- 0.06 - 0.08
- 0.08 - 0.12
- 0.12 - 0.18
- 0.18 - 0.25
- 0.25 - 0.52



DRAFT

100 year 95th percentile shear stress with Cofferdam

Shear Stress (Pa)

-  0 - 0.005
-  0.005 - 0.008
-  0.008 - 0.02
-  0.02 - 0.06
-  0.06 - 0.08
-  0.08 - 0.12
-  0.12 - 0.18
-  0.18 - 0.25
-  0.25 - 0.52

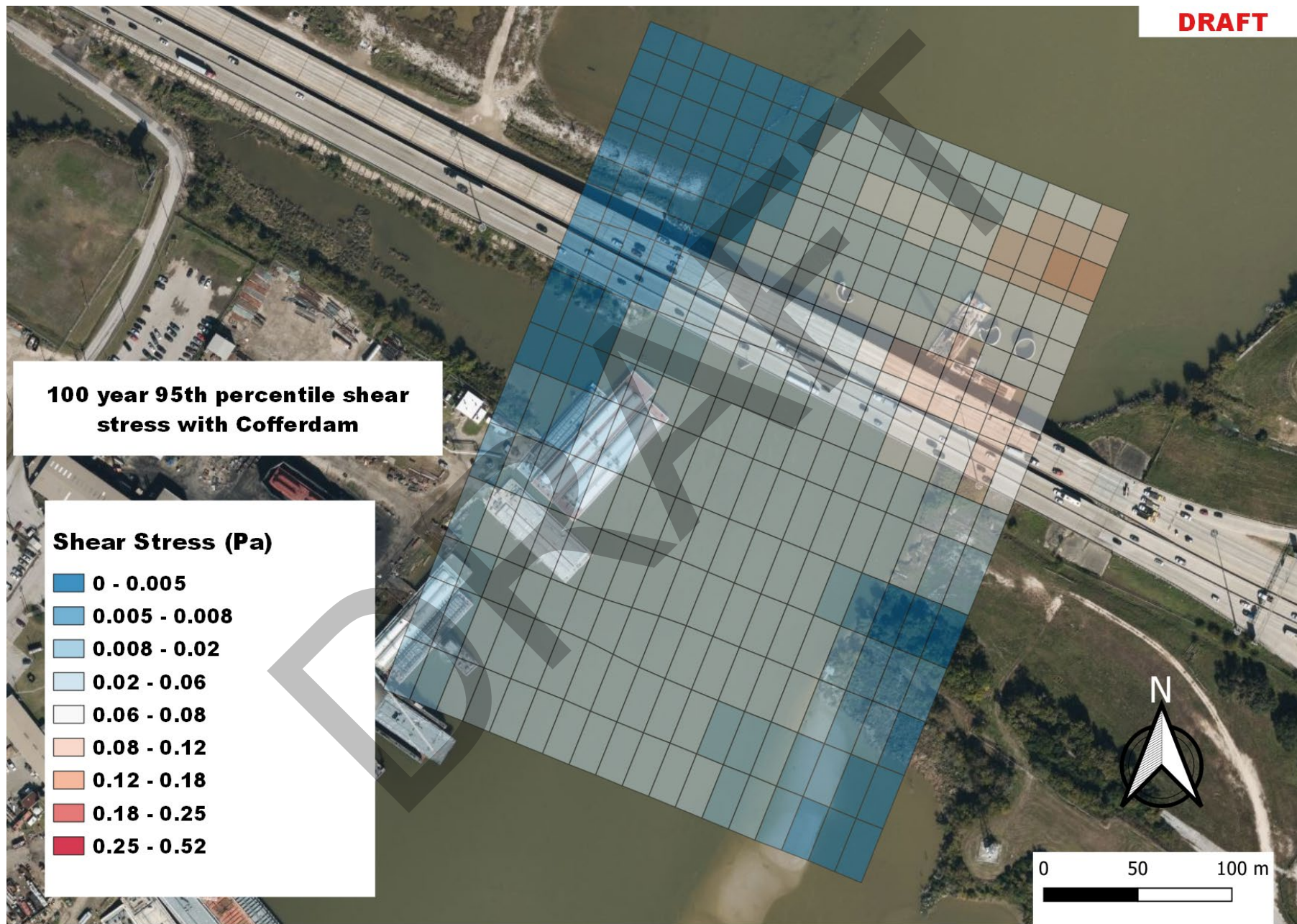
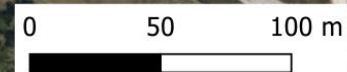

DRAFT

100 year 95th percentile shear stresses differences

Shear Stress (ft/s)

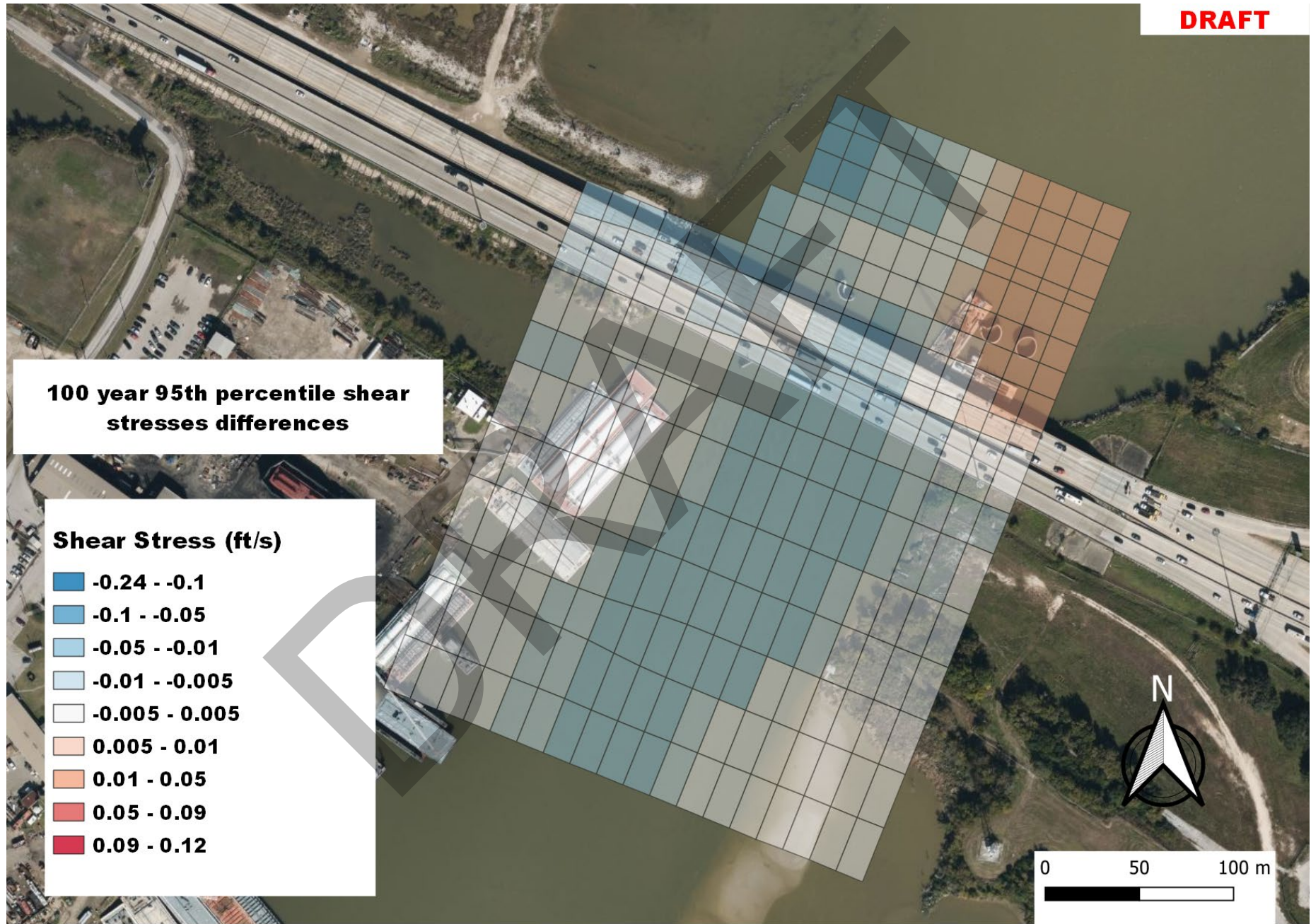
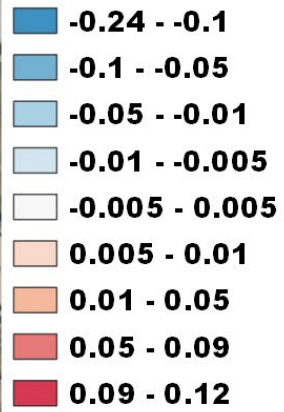

Appendix D-6

**Letter Correspondence from GHD to
U.S. Army Corps of Engineers, titled
“Nationwide Permit 38 Applicability
Review,” Dated December 7, 2022**

1755 Wittington Place Suite 500
Dallas, Texas 75234
United States
www.GHD.com



Our Ref.: 11215702-Cunningham-1

December 7, 2022

Ms. Felicity Cunningham
Regulatory Project Manager
United States Army Corps of Engineers (USACE), Galveston District
2000 Fort Point Road
Galveston, Texas 77550

Nationwide Permit 38 Applicability Review
San Jacinto River Waste Pits Superfund Site - Northern Impoundment
Harris County, Texas

Dear Ms. Cunningham:

On behalf of McGinnes Industrial Maintenance Corporation (MIMC) and International Paper Company (IPC), GHD Services Inc. (GHD) submits this package under Nationwide Permit (NWP) 38 (Clean-Up of Hazardous and Toxic Waste) with respect to Remedial Design (RD) for the Northern Impoundment of the San Jacinto River Waste Pits Superfund Site (hereafter "Project"). This submission is made pursuant to the *Administrative Settlement Agreement and Order on Consent* (AOC) for Remedial Design of the Northern Impoundment, the United States Environmental Protection Agency (EPA) Region 6, Comprehensive Environmental Response, Compensation, and Liability Act (CERCLA) Docket No. 06-02-18 (Order).

Based on GHD's prior discussions with the USACE concerning the Project, the purpose of this submission is to document that the Project will meet the applicable substantive requirements of the NWP 38. As outlined herein and shown on the attached figures, the proposed Project activities fall within the CERCLA scope of work for the Northern Impoundment, as published in the EPA Record of Decision (ROD [EPA ID: TXN000606611]). This letter provides an overview of the proposed Project work and includes figures and supplementary supporting documents as attachments.

1. Project Location

The Project (29°47'29.4" North, 95°04'03.0" West) involves a location in Harris County, Texas, east of the City of Houston and between two unincorporated areas known as Channelview and Highlands. The EPA Superfund Database Identification Number for the San Jacinto River Waste Pits Superfund Site (Site) is TXN000606611.

The preliminary Site perimeter established by EPA for the remedial investigation (RI) encompasses areas known as the Northern and Southern Impoundments and surrounding in-water and upland areas of the San Jacinto River on both sides of Interstate Highway 10 (I-10). This submission is specific to the Northern Impoundment, which is approximately 14 acres in size and located north of I-10, and certain surrounding areas as defined in Attachment 3 as the "Project Area." The EPA published a Record of Decision (ROD) selecting a remedy for the Site in 2017 (EPA, 2017).

2. Project Purpose

The purpose and goals of the remedial action for the Project are as follows (as stated in the ROD):

- Prevent releases of dioxins and furans above clean-up levels from the former waste impoundment to sediments and surface water of the San Jacinto River.
- Reduce human exposure to dioxins and furans from ingestion of fish by remediating sediments to appropriate clean-up levels.
- Reduce human exposure to dioxins and furans from direct contact with or ingestion of paper mill waste, soil, and sediment by remediating affected media to appropriate clean-up levels.
- Reduce exposures of benthic invertebrates, birds, and mammals to paper mill waste derived dioxins and furans by remediating affected media to appropriate clean-up levels.

3. Proposed Work

The remedy selected by the EPA for the Northern Impoundment, as described in the ROD, includes the following:

- Removal of a portion of the existing armored cap material installed as part of the Time Critical Removal Action (TCRA).
- Removal of waste material exceeding the clean-up level of 30 nanograms per kilograms (ng/kg) 2,3,7,8-tetrachlorinated dibenzo-p-dioxin toxicity equivalent that is located beneath the armored cap and its stabilization, as necessary to meet the appropriate requirements for acceptance at a permitted disposal facility.

The remedy selected for the Northern Impoundment, as outlined in the ROD, includes excavation and off-Site disposal of waste material located beneath the armored cap that exceeds the prescribed clean-up level of 30 ng/kg toxicity equivalent. As described in the ROD, the selected remedy is to utilize a Best Management Practice (BMP), such as a cofferdam.

4. Proposed Project Impacts

4.1 Wetlands

The proposed Project may involve 5.20 acres of a palustrine emergent (PEM) wetland at the Project Area, as shown in Attachment 1. Due to the fact that this wetland is located atop the Northern Impoundment and the TCRA armored cap, this wetland does not currently possess high quality functions or values. A complete report detailing the wetland at the Project Area is included in Attachment 2.

Because the proposed Project impacts fall within the CERCLA scope of work, no wetland mitigation is planned.

4.2 Threatened & Endangered Species

As outlined in the Threatened and Endangered Species Habitat Suitability Assessment (Attachment 3), 28 Endangered Species Act (ESA)-listed, proposed, or candidate species were evaluated. Desktop background review and field surveys determined that the Project Area lacks suitable habitat for 26 of the 28 species evaluated. Only two species were determined to be potentially present in or near the Project Area: the West Indian Manatee (Threatened) and the Saltmarsh Topminnow (Not Listed, Under Review).

Given the transient nature and rarity of manatees within the San Jacinto River, it is unlikely that they would be present in the Project Area at any given time during pile driving activities as proposed in the Northern Impoundment RD. However, to minimize the potential for elevated levels of underwater noise to affect any manatees that might be in the immediate vicinity of the Northern Impoundment, conservation measures have been proposed.

As there are no recent records of Saltmarsh Topminnow north of the Trinity Bay drainage, any potential for exposure of this species to elevated underwater noise levels would be highly unlikely. However, to minimize the potential for any disturbance to Saltmarsh Topminnow, if they were to be present in the Project Area, conservation measures have been proposed.

The proposed activities will have no effect on any of the 26 other Federal-listed species. The proposed activities will have no effect on any designated critical habitats. The ROD provides that completion of the proposed Project will improve water quality in the vicinity of the Project Area. The proposed Project is therefore ultimately expected to have a beneficial effect on any listed wildlife in the San Jacinto River that may be present in the vicinity of the Northern Impoundment.

4.3 Cultural Resources

As discussed in the Cultural Resources Desktop Analysis (Attachment 4), the Project Area contains a low potential for containing either pre-historic or historic-period cultural resources. Consequently, further cultural resource investigations are not planned.

Should you have any questions or require additional information regarding this submittal, please contact GHD at (713) 734-3090.

Regards,

GHD



Charles W. Munce, P.E.

(225) 773-5770
Charles.Munce@GHD.com

CWM/jlf/1



Kevin Jani

(972) 331-8555
Kevin.Janni@GHD.com

Encl.: Attachment 1 - Figures
Attachment 2 - Waters & Wetlands Delineation Report
Attachment 3 - Threatened & Endangered Species Habitat Suitability Assessment Report
Attachment 4 - Cultural Resources Desktop Analysis

Copy to: Kristi McMillan, USACE
Brent Sasser, IPC
Judy Armour, MIMC

Attachment 1

Figures



Attachment 2

Waters & Wetlands Delineation Report



Waters & Wetlands Delineation Report

**San Jacinto River Waste Pits Superfund
Site - Northern Impoundment**

McGinnes Industrial Maintenance Corporation &
International Paper Company

December 7, 2022

→ The Power of Commitment

Contents

1. Introduction	1
2. Project Location	1
2.1 Description of Project	1
3. Ecological Setting	1
3.1 EPA Level III Ecoregion	2
3.2 EPA Level IV Ecoregion	2
3.3 TPWD Ecoregion	2
3.4 Topography and Soils	2
3.5 Vegetation	3
3.6 Hydrography	3
3.7 National Wetland Inventory	3
4. On-Site Waters & Wetlands Delineation	3
4.1 Methodology	3
4.2 Results	4
5. Conclusions	4
6. References Cited	4

Appendices

Appendix A	Figures
Appendix B	Photographs
Appendix C	Wetland Determination Data Sheets

1. Introduction

The purpose of this report is to summarize the desktop background review and on-site field delineation of potential waters of the United States, including wetlands, for the Northern Impoundment of the San Jacinto River Waste Pits Superfund Site (hereafter “Project”). This report presents the results of the background review that was utilized to provide contextual information (and to guide the on-site field survey) and the observations made during the on-site survey and the delineation of the spatial extent of waters and wetlands present at the “Project Area,” as defined in Attachment 3. Additionally, this report describes the site conditions, ecological setting, and the waters and wetland approach and methodology. Applicable supporting information is provided in Appendix A (Figures), Appendix B (Photos), and Appendix C (Wetland Determination Data Sheets).

2. Project Location

The Project (29°47'29.3" North, 95°3'58.4" West) is located in Harris County, Texas, east of the City of Houston and between two unincorporated areas known as Channelview and Highlands (see Appendix A, Figure 1). The United States Environmental Protection Agency (EPA) Superfund Database Identification Number is TXN000606611. The EPA published a Record of Decision (ROD) for the clean-up in 2017 (EPA, 2017). This report is specific to the Northern Impoundment, which is approximately 14 acres in size and located north of Interstate Highway 10 (I-10), and certain surrounding areas as defined in Attachment 3 as the “Project Area,” (Appendix A, Figure 1).

2.1 Description of Project

The remedy selected by the EPA for the Northern Impoundment, as described in the ROD (EPA, 2017), includes the following:

- Removal of a portion of the existing armored cap material installed as part of the Time Critical Removal Action (TCRA).
- Removal of waste material exceeding the clean-up level of 30 nanograms per kilograms (ng/kg) 2,3,7,8-tetrachlorinated dibenzo-p-dioxin toxicity equivalent that is located beneath the armored cap and its stabilization, as necessary to meet the appropriate requirements for acceptance at a permitted disposal facility.

The remedy selected for the Northern Impoundment, as outlined in the ROD, includes excavation and off-site disposal of waste material located beneath the armored cap (installed as part of the TCRA) that exceeds the prescribed clean-up level of 30 ng/kg toxicity equivalent. As described in the ROD, the selected remedy is to utilize a Best Management Practice (BMP), such as a cofferdam.

3. Ecological Setting

The following sections describe the ecological setting utilizing data compiled from the desktop background review. These sections cover EPA and Texas Parks and Wildlife Department (TPWD) ecoregions, topography and soils, vegetation, National Hydrography Dataset (NHD) hydrographic data, and National Wetlands Inventory (NWI) wetland and surface water data.

3.1 EPA Level III Ecoregion

The Project is located in the Western Gulf Coastal Plain, Level III ecoregion (Griffith, et al., 2004). This ecoregion is characterized by relatively flat topography and mainly grassland potential natural vegetation. Inland from this region, the plains are older, more irregular, and have mostly forest or savanna-type vegetation potentials. Subsequently, a higher percentage of the land is in cropland than in bordering ecological regions. Rice, grain, sorghum, cotton, and soybeans are the principal crops. Urban and industrial land uses have expanded greatly in recent decades and oil and gas production is common.

3.2 EPA Level IV Ecoregion

The Project is located in the Texas-Louisiana Coastal Marshes, Level IV ecoregion (Griffith, et al., 2004). This ecoregion is characterized by extensive freshwater and saltwater coastal marshes, a lack of barrier islands and fewer bays, and its wetter, more humid climate than adjacent Level IV ecoregions. In Texas, the annual precipitation is 48 to 54 inches. There are many rivers, lakes, bayous, tidal channels, and canals. The streams and rivers that supply nutrients and sediments to this region are primarily from the humid pine belt of South Central Plains Level III ecoregion. Extensive cordgrass marshes occur. The estuarine and marsh complex supports marine life, supplies wintering grounds for ducks and geese, and provides habitat for small mammals and American alligators. Brown shrimp, the most commercially important marine species in Texas, is common along the whole coast, but in this northern coastal zone, white shrimp are also commercially important. Eastern oysters and blue crabs are also common and commercially important in the region. Sport fishery species, such as red drum, black drum, southern flounder, and spotted seatrout occur throughout the coastal bays.

3.3 TPWD Ecoregion

According to the Texas Parks and Wildlife Department (TPWD), the Project is located in the Gulf Prairies and Marshes ecoregion of Texas (TPWD, 2022). The Gulf Coast Prairies and Marshes region is a nearly level, slowly drained plain less than 150 feet in elevation, dissected by streams and rivers flowing into the Gulf of Mexico. The region includes barrier islands along the coast, salt grass marshes surrounding bays and estuaries, remnant tallgrass prairies, oak parklands and oak mottes scattered along the coast, and tall woodlands in the river bottomlands. Average annual rainfall varies from 30 to 50 inches per year distributed uniformly throughout the year. The growing season is usually more than 300 days, with high humidity and warm temperatures. Soils are acidic sands and sandy loams, with clays occurring primarily in the river bottoms. Native vegetation consists of tallgrass prairies and live oak woodlands. Brush species, such as mesquite and acacias are more common now than in the past. Although much of the native habitat has been lost to agriculture and urbanization, the region still provides important habitat for migratory birds and spawning areas for fish and shrimp.

3.4 Topography and Soils

The Project vicinity is relatively level and includes the San Jacinto River and historic fill material now present within the river (i.e., materials beneath the armored cap; Appendix A, Figure 2). Elevations range from approximately 0 to 5 feet above sea level (Appendix A, Figure 3).

Soils in the region are characterized by Holocene alluvial deposits and the Beaumont Formation (Pleistocene deposits, dominated by clays and silts). Within the Northern Impoundment soils are primarily sandy, with a low content of organic materials (EPA, 2017). At the Project Area, soils are entirely comprised of Harris Clay, 0 to 1 percent slopes, frequently flooded, tidal (Appendix A, Figure 4). According to the Natural Resource Conservation Service (NRCS), this soil type is classified as hydric because based on the range of characteristics for the soil series, they will at least in part meet one or more field indicators of hydric soils in the United States or show evidence that the soil meets the definition of hydric soils, the map unit components are frequently ponded for a long duration or very long duration during the growing season, and the map unit components are frequently flooded for a long duration or very long duration during the growing season.

3.5 Vegetation

The TPWD's Texas Ecosystem Analytical Mapper (TEAM) shows that the entire Project Area is classified as Open Water: Gulf Coast Mixing Zone. This mapping system includes open water areas in bays and in the Gulf of Mexico where salinities range from 0 to 0.5 parts per trillion (ppt). In addition to large lakes, rivers, and marine water, ephemeral ponds may be mapped as open water. Some mapped areas may support vegetation with pioneering species, such as black willow (*Salix nigra*), eastern cottonwood (*Populus deltoides*), Chinese tallow (*Triadica sebifera*), seepweeds (*Suaeda* spp.), sea ox-eye daisy (*Borrchia frutescens*), saltwort (*Batis maritima*), rushes (*Juncus* spp.), cattails (*Typha* spp.), and spikerushes (*Eleocharis* spp.).

3.6 Hydrography

The National Hydrography Dataset (NHD) does not show any surface water at the Project Area (Appendix A, Figure 5). The Project is located in the San Jacinto Basin, Buffalo-San Jacinto sub-basin of the Texas-Gulf Region, Galveston Bay-San Jacinto subregion watershed (HUC, 12040104).

3.7 National Wetland Inventory

The United States Fish and Wildlife Service's (USFWS) National Wetland Inventory shows that the Project Area includes Estuarine and Marine Wetland surrounded by Estuarine and Marine Deepwater (Appendix A, Figure 6).

4. On-Site Waters & Wetlands Delineation

4.1 Methodology

For purposes of the Project and this report, GHD Services Inc. (GHD) has defined potential waters of the United States, including wetlands, as those defined in 33 Code of Federal Regulations (CFR) 328.3. As applicable to this effort, 33 CFR 328.3(b) defines wetlands as "those areas that are inundated or saturated by surface or groundwater at a frequency and duration sufficient to support, and that under normal circumstances do support, a prevalence of vegetation typically adapted for life in saturated soil conditions." Hydrophytic vegetation ratings assigned by the National Wetland Plant List (NWPL) indicator ratings for the Atlantic and Gulf Coastal Plain Region were used and include obligate (OBL), facultative wetland (FACW) and facultative (FAC), facultative upland (FACU) and upland (UPL).

GHD followed the methodology for delineating wetlands outlined in the *Corps of Engineers Wetlands Delineation Manual* (Environmental Laboratory, 1987) and the *Regional Supplement to the Corps of Engineers Wetland Delineation Manual: Atlantic and Gulf Coastal Plain Region* (Version 2.0) (USACE, 2010). The delineation of streams, ditches and other waterbodies was recorded at the Ordinary High-Water Mark (OHWM). Per 33 CFR 328.3(e), the OHWM is defined as "(the) line on the shore established by the fluctuations of water and indicated by physical characteristics such as clear, natural line impressed on the bank, shelving, changes in the character of soil, destruction of terrestrial vegetation, the presence of litter and debris, or other appropriate means that consider the characteristics of the surrounding area."

GHD completed the on-site delineation of wetlands and waterbodies on October 7, 2021. Wetland and waterbody boundaries were delineated using a Trimble Global Positioning System (GPS) capable of sub-meter accuracy and photographs were taken in each cardinal direction for every wetland and upland sample point and upstream and downstream for each waterbody (Appendix B). Soil pits were excavated to identify hydric or non-hydric soil characteristics and wetland determination data sheets were completed for each wetland and its corresponding upland location (Appendix C).

4.2 Results

GHD delineated one (1) wetland and no surface waters on the Project Area (Appendix A, Figure 7). The delineated wetland (Wetland 1) was observed as a Palustrine Emergent (PEM) wetland of 5.20 acres in size. Wetland 1 is located in a heavily disturbed area as described in Section 2.2. The location of this wetland corresponds to the location of hydric soils (Harris Clay, 0 to 1 percent slopes, frequently flooded, tidal) shown on the NRCS Soil Survey Map (Appendix A, Figure 4) and the Estuarine and Marine Wetland shown on the NWI map (Appendix A, Figure 6).

Hydrophytic vegetation was observed by a dominance of Facultative Wetland (FACW; Usually occur in wetlands but occasionally found in non-wetlands) plants, specifically tall flatsedge (*Cyperus eragrostis*) and marsh bristlegrass (*Setaria parviflora*). Additional wetland plants observed in non-dominant plant cover include Obligate (OBL; Occur almost always under natural conditions in wetlands) plants, specifically sea oxeye (*Borrchia frutescens*) and southern cattail (*Typha domingensis*) and Facultative (FAC; Equally likely to occur in wetlands and non-wetlands), specifically purple flatsedge (*Cyperus rotundus*) and giant reed (*Arundo donax*).

Primary indicators for hydrology were observed by the presence of surface water and inundation near the outer edges of the wetland near the shoreline, as well as some areas closer to the center of the wetland to the north of the gravel access road. Inundation is also visible on aerial imagery. Hydric soil indicators were observed as a depleted matrix. Upland areas were observed as the gravel road that runs through the approximate middle of the wetland. This area was completely void of vegetation. Soil pits were not excavated because of the impenetrable surface of the road. Wetland Determination Data Sheets are provided in Appendix C.

5. Conclusions

GHD delineated the boundary of one (1) wetland and no surface waters for purposes of the Project. This wetland is a Palustrine Emergent (PEM) of 5.20 acres in size (Wetland 1; Appendix A, Figure 7). The wetland has been significantly disturbed over time and is generally considered to have low-quality functions and values.

6. References Cited

- Environmental Laboratory. 1987. Corps of Engineers Wetlands Delineation Manual. Technical Report Y-87-1, United States Army Engineer Waterways Experiment Stations, Vicksburg, Mississippi.
- United States Environmental Protection Agency (EPA), 2010. Administrative Settlement Agreement and Order on Consent for Removal Action. U.S. Environmental Protection Agency Region 6 CERCLA Docket No. 06-12-10. In the matter of San Jacinto River Waste Pits Superfund Site Pasadena, Harris County, Texas. International Paper Company and McGinnes Industrial Management Corporation, Respondents.
- EPA, 2017. Record of Decision, San Jacinto River Waste Pits. Harris County, Texas. EPA ID: TXN000606611. U.S. Environmental Protection Agency, Region 6. Dallas, Texas. October 2017.
- Griffith, G.E., S.A. Bryce, Omernik, J.A., Comstock, A.C., Rogers, B., Harrison, S.L., Hatch, and D. Bezanson. 2004. Ecoregions of Texas. U.S. Environmental Protection Agency, Corvallis, Organ.
- Texas Parks and Wildlife Department (TPWD). 2022. Texas ecoregions. <https://tpwd.texas.gov/education/hunter-education/online-course/wildlife-conservation/texas-ecoregions>. Accessed May 10, 2022.
- U.S. Army Corps of Engineers. 2020. NWPL-National Wetland Plant List. Available at the following link: https://wetland-plants.sec.usace.army.mil/nwpl_static/v34/home/home.html. Accessed on May 1, 2022.

- U.S. Army Corps of Engineers. 2010. Regional Supplement to the Corps of Engineers Wetland Delineation Manual: Midwest Region (Version 2.0), U.S. Army Corps of Engineers. ERDC/EL TR-10-16. Vicksburg, Mississippi: U.S. Army Engineer Research and Development Center.

Appendices

Appendix A

Figures

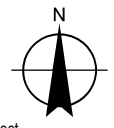
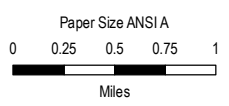

**SAN JACINTO RIVER WASTE PITS
 HARRIS COUNTY, TEXAS
 WETLAND DELINEATION REPORT
 NORTHERN IMPOUNDMENT**

Project No. 11215702
 Date May 17, 2022

Map Projection: Lambert Conformal Conic
 Horizontal Datum: North American 1983
 Grid: NAD 1983 StatePlane Texas South Central FIPS 4204 Feet

SITE VICINITY MAP

FIGURE 1



Legend
 Northern Impoundment

Paper Size ANSI A
 0 250 500 750 1,000
 Feet

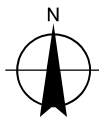

Map Projection: Lambert Conformal Conic
 Horizontal Datum: North American 1983
 Grid: NAD 1983 StatePlane Texas South Central FIPS 4204 Feet

**SAN JACINTO RIVER WASTE PITS
 HARRIS COUNTY, TEXAS
 WETLAND DELINEATION REPORT
 NORTHERN IMPOUNDMENT**

Project No. 11215702
 Date May 17, 2022

USGS TOPOGRAPHIC MAP

FIGURE 2



Legend

- Elevation Contour (ft.)
- ▭ Northern Impoundment

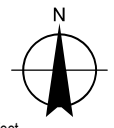
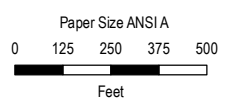

Map Projection: Lambert Conformal Conic
 Horizontal Datum: North American 1983
 Grid: NAD 1983 StatePlane Texas South Central FIPS 4204 Feet

**SAN JACINTO RIVER WASTE PITS
 HARRIS COUNTY, TEXAS
 WETLAND DELINEATION REPORT
 NORTHERN IMPOUNDMENT**

Project No. 11215702
 Date May 17, 2022

LIDAR MAP

FIGURE 3

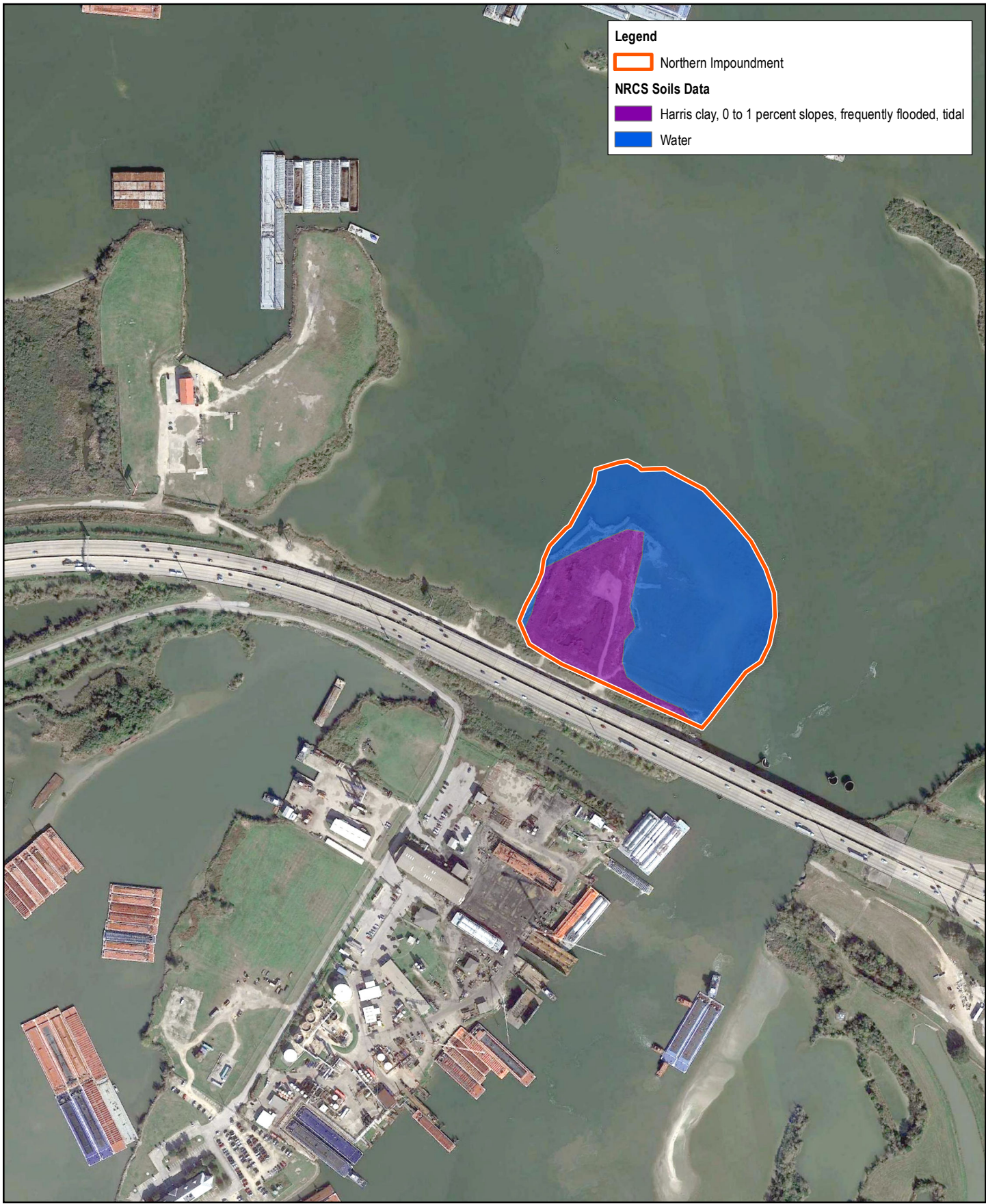

Legend

- Northern Impoundment

NRCs Soils Data

- Harris clay, 0 to 1 percent slopes, frequently flooded, tidal
- Water

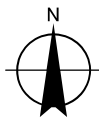
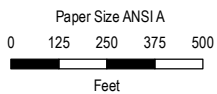

**SAN JACINTO RIVER WASTE PITS
HARRIS COUNTY, TEXAS
WETLAND DELINEATION REPORT
NORTHERN IMPOUNDMENT**

Project No. 11215702
Date May 17, 2022

Map Projection: Lambert Conformal Conic
Horizontal Datum: North American 1983
Grid: NAD 1983 StatePlane Texas South Central FIPS 4204 Feet

NRCS SOIL SURVEY MAP

FIGURE 4



Legend

- Waterbody
- Northern Impoundment

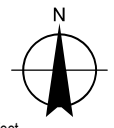
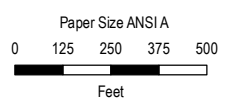

Map Projection: Lambert Conformal Conic
 Horizontal Datum: North American 1983
 Grid: NAD 1983 StatePlane Texas South Central FIPS 4204 Feet

**SAN JACINTO RIVER WASTE PITS
 HARRIS COUNTY, TEXAS
 WETLAND DELINEATION REPORT
 NORTHERN IMPOUNDMENT**

Project No. 11215702
 Date May 17, 2022

**NATIONAL HYDROGRAPHY
 DATASET MAP**

FIGURE 5

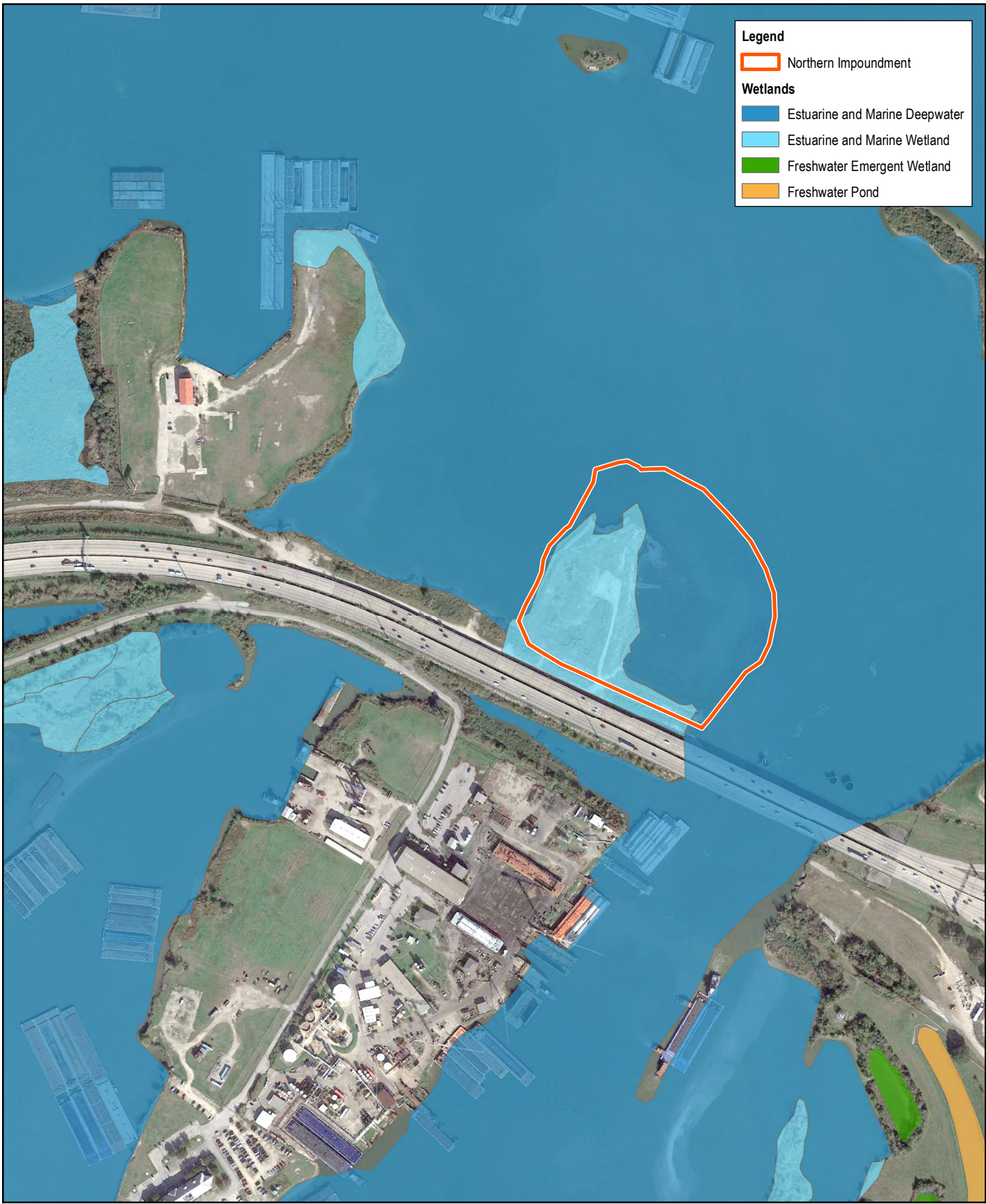

Legend

- Northern Impoundment

Wetlands

- Estuarine and Marine Deepwater
- Estuarine and Marine Wetland
- Freshwater Emergent Wetland
- Freshwater Pond

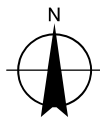
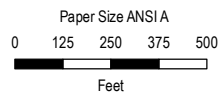

Map Projection: Lambert Conformal Conic
 Horizontal Datum: North American 1983
 Grid: NAD 1983 StatePlane Texas South Central FIPS 4204 Feet

**SAN JACINTO RIVER WASTE PITS
 HARRIS COUNTY, TEXAS
 WETLAND DELINEATION REPORT
 NORTHERN IMPOUNDMENT**

**NATIONAL WETLAND
 INVENTORY MAP**

Project No. 11215702
 Date May 17, 2022

FIGURE 6



Legend
 [Black Outline] Wetland Boundary
 [Orange Outline] Northern Impoundment
5.20 Total Wetland Acreage

Wetland 1
5.20 Acres

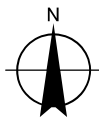
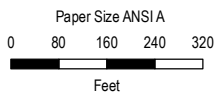

**SAN JACINTO RIVER WASTE PITS
 HARRIS COUNTY, TEXAS
 WETLAND DELINEATION REPORT
 NORTHERN IMPOUNDMENT**

Project No. **11215702**
 Date **May 17, 2022**

Map Projection: Lambert Conformal Conic
 Horizontal Datum: North American 1983
 Grid: NAD 1983 StatePlane Texas South Central FIPS 4204 Feet

WETLAND DELINEATION MAP

FIGURE 7

Appendix B

Photographs

Site Photographs



Photo 1 View of Wetland 1 facing West.



Photo 2 View of Wetland 1 facing North.



Photo 3 *View of Wetland 1 facing East.*



Photo 4 *View of Wetland 1 facing South.*

Appendix C

Wetland Determination Data Sheets

Project/Site: San Jac Waste Pits - Northern Impoundment City/County: Channelview/Harris Sampling Date: 10.8.2021
 Applicant/Owner: MIMC & International Paper State: TX Sampling Point: SP1
 Investigator(s): Kevin Janni Section, Township, Range: N/A
 Landform (hillside, terrace, etc.): flat Local relief (concave, convex, none): none Slope (%): 0
 Subregion (LRR or MLRA): LRR T, MLRA 150A Lat: 29°47'41.40" Long: 95° 3'48.65" Datum: NAD83
 Soil Map Unit Name: Harris clay, 0 to 1 percent slopes, frequently flooded, tidal NWI classification: E2EM1P
 Are climatic / hydrologic conditions on the site typical for this time of year? Yes X No (If no, explain in Remarks.)
 Are Vegetation , Soil , or Hydrology significantly disturbed? Are "Normal Circumstances" present? Yes X No
 Are Vegetation , Soil , or Hydrology naturally problematic? (If needed, explain any answers in Remarks.)

SUMMARY OF FINDINGS – Attach site map showing sampling point locations, transects, important features, etc.

Hydrophytic Vegetation Present? Yes <u>X</u> No <u> </u> Hydric Soil Present? Yes <u>X</u> No <u> </u> Wetland Hydrology Present? Yes <u>X</u> No <u> </u>	Is the Sampled Area within a Wetland? Yes <u>X</u> No <u> </u>
---	--

Remarks:
 E2EM1P - Estuarine and Marine Wetland (NWI Classification); heavily disturbed, large gravel road through middle of wetland, shoreline wetland vegetation around, some ponding nearing edges w/ additional wetland vegetation present.

HYDROLOGY

Wetland Hydrology Indicators: <u>Primary Indicators (minimum of one is required; check all that apply)</u> <input checked="" type="checkbox"/> Surface Water (A1) <input type="checkbox"/> Aquatic Fauna (B13) <input type="checkbox"/> High Water Table (A2) <input type="checkbox"/> Marl Deposits (B15) (LRR U) <input checked="" type="checkbox"/> Saturation (A3) <input type="checkbox"/> Hydrogen Sulfide Odor (C1) <input type="checkbox"/> Water Marks (B1) <input type="checkbox"/> Oxidized Rhizospheres on Living Roots (C3) <input type="checkbox"/> Sediment Deposits (B2) <input type="checkbox"/> Presence of Reduced Iron (C4) <input type="checkbox"/> Drift Deposits (B3) <input type="checkbox"/> Recent Iron Reduction in Tilled Soils (C6) <input type="checkbox"/> Algal Mat or Crust (B4) <input type="checkbox"/> Thin Muck Surface (C7) <input type="checkbox"/> Iron Deposits (B5) <input type="checkbox"/> Other (Explain in Remarks) <input checked="" type="checkbox"/> Inundation Visible on Aerial Imagery (B7) <input type="checkbox"/> Water-Stained Leaves (B9)	<u>Secondary Indicators (minimum of two required)</u> <input type="checkbox"/> Surface Soil Cracks (B6) <input type="checkbox"/> Sparsely Vegetated Concave Surface (B8) <input type="checkbox"/> Drainage Patterns (B10) <input type="checkbox"/> Moss Trim Lines (B16) <input type="checkbox"/> Dry-Season Water Table (C2) <input type="checkbox"/> Crayfish Burrows (C8) <input type="checkbox"/> Saturation Visible on Aerial Imagery (C9) <input type="checkbox"/> Geomorphic Position (D2) <input type="checkbox"/> Shallow Aquitard (D3) <input checked="" type="checkbox"/> FAC-Neutral Test (D5) <input type="checkbox"/> Sphagnum Moss (D8) (LRR T, U)
---	---

Field Observations: Surface Water Present? Yes <u>X</u> No <u> </u> Depth (inches): <u>6</u> Water Table Present? Yes <u> </u> No <u>X</u> Depth (inches): <u>0</u> Saturation Present? Yes <u>X</u> No <u> </u> Depth (inches): <u>1</u> (includes capillary fringe)	Wetland Hydrology Present? Yes <u>X</u> No <u> </u>
---	---

Describe Recorded Data (stream gauge, monitoring well, aerial photos, previous inspections), if available:

Remarks:
 surface water and inundation near outer edges near shoreline

VEGETATION (Five Strata) – Use scientific names of plants.

Sampling Point: SP1

Tree Stratum (Plot size: <u>N/A</u>)	Absolute % Cover	Dominant Species?	Indicator Status
1. _____	_____	_____	_____
2. _____	_____	_____	_____
3. _____	_____	_____	_____
4. _____	_____	_____	_____
5. _____	_____	_____	_____
6. _____	_____	_____	_____
_____ = Total Cover			
50% of total cover: _____		20% of total cover: _____	

Sapling Stratum (Plot size: <u>N/A</u>)	Absolute % Cover	Dominant Species?	Indicator Status
1. _____	_____	_____	_____
2. _____	_____	_____	_____
3. _____	_____	_____	_____
4. _____	_____	_____	_____
5. _____	_____	_____	_____
6. _____	_____	_____	_____
_____ = Total Cover			
50% of total cover: _____		20% of total cover: _____	

Shrub Stratum (Plot size: <u>N/A</u>)	Absolute % Cover	Dominant Species?	Indicator Status
1. _____	_____	_____	_____
2. _____	_____	_____	_____
3. _____	_____	_____	_____
4. _____	_____	_____	_____
5. _____	_____	_____	_____
6. _____	_____	_____	_____
_____ = Total Cover			
50% of total cover: _____		20% of total cover: _____	

Herb Stratum (Plot size: <u>5</u>)	Absolute % Cover	Dominant Species?	Indicator Status
1. <u>Cyperus eragrostis</u>	<u>45</u>	<u>Yes</u>	<u>FACW</u>
2. <u>Setaria parviflora</u>	<u>25</u>	<u>Yes</u>	<u>FACW</u>
3. <u>Cyperus rotundus</u>	<u>20</u>	<u>No</u>	<u>FAC</u>
4. <u>Borrchia frutescens</u>	<u>20</u>	<u>No</u>	<u>OBL</u>
5. <u>Typha domingensis</u>	<u>10</u>	<u>No</u>	<u>OBL</u>
6. <u>Arundo donax</u>	<u>5</u>	<u>No</u>	<u>FAC</u>
7. _____	_____	_____	_____
8. _____	_____	_____	_____
9. _____	_____	_____	_____
10. _____	_____	_____	_____
11. _____	_____	_____	_____
_____ = Total Cover			
50% of total cover: <u>63</u>		20% of total cover: <u>25</u>	

Woody Vine Stratum (Plot size: _____)	Absolute % Cover	Dominant Species?	Indicator Status
1. _____	_____	_____	_____
2. _____	_____	_____	_____
3. _____	_____	_____	_____
4. _____	_____	_____	_____
5. _____	_____	_____	_____
_____ = Total Cover			
50% of total cover: _____		20% of total cover: _____	

Dominance Test worksheet:

Number of Dominant Species That Are OBL, FACW, or FAC: 2 (A)

Total Number of Dominant Species Across All Strata: 2 (B)

Percent of Dominant Species That Are OBL, FACW, or FAC: 100.0% (A/B)

Prevalence Index worksheet:

Total % Cover of:	Multiply by:
OBL species <u>30</u>	x 1 = <u>30</u>
FACW species <u>70</u>	x 2 = <u>140</u>
FAC species <u>25</u>	x 3 = <u>75</u>
FACU species <u>0</u>	x 4 = <u>0</u>
UPL species <u>0</u>	x 5 = <u>0</u>
Column Totals: <u>125</u> (A)	<u>245</u> (B)
Prevalence Index = B/A = <u>1.96</u>	

Hydrophytic Vegetation Indicators:

 1 - Rapid Test for Hydrophytic Vegetation

X 2 - Dominance Test is >50%

X 3 - Prevalence Index is ≤3.0¹

 Problematic Hydrophytic Vegetation¹ (Explain)

¹Indicators of hydric soil and wetland hydrology must be present, unless disturbed or problematic.

Definitions of Five Vegetation Strata:

Tree – Woody plants, excluding woody vines, approximately 20 ft (6 m) or more in height and 3 in. (7.6 cm) or larger in diameter at breast height (DBH).

Sapling – Woody plants, excluding woody vines, approximately 20 ft (6 m) or more in height and less than 3 in. (7.6 cm) DBH.

Shrub - Woody Plants, excluding woody vines, approximately 3 to 20 ft (1 to 6 m) in height.

Herb – All herbaceous (non-woody) plants, including herbaceous vines, regardless of size, and woody plants, except woody vines, less than approximately 3 ft (1 m) in height.

Woody Vine – All woody vines, regardless of height.

Hydrophytic Vegetation Present? Yes X No _____

Remarks: (If observed, list morphological adaptations below.)

SOIL

Sampling Point: SP1

Profile Description: (Describe to the depth needed to document the indicator or confirm the absence of indicators.)								
Depth (inches)	Matrix		Redox Features				Texture	Remarks
	Color (moist)	%	Color (moist)	%	Type ¹	Loc ²		
0-16	7.5YR 4/1	80	7.5YR 5/6	20	D	M	Loamy/Clayey	

¹Type: C=Concentration, D=Depletion, RM=Reduced Matrix, MS=Masked Sand Grains.

²Location: PL=Pore Lining, M=Matrix.

Hydric Soil Indicators: (Applicable to all LRRs, unless otherwise noted.)

- Histosol (A1)
- Histic Epipedon (A2)
- Black Histic (A3)
- Hydrogen Sulfide (A4)
- Stratified Layers (A5)
- Organic Bodies (A6) **(LRR P, T, U)**
- 5 cm Mucky Mineral (A7) **(LRR P, T, U)**
- Muck Presence (A8) **(LRR U)**
- 1 cm Muck (A9) **(LRR P, T)**
- Depleted Below Dark Surface (A11)
- Thick Dark Surface (A12)
- Coast Prairie Redox (A16) **(MLRA 150A)**
- Sandy Mucky Mineral (S1) **(LRR O, S)**
- Sandy Gleyed Matrix (S4)
- Sandy Redox (S5)
- Stripped Matrix (S6)
- Dark Surface (S7) **(LRR P, S, T, U)**
- Polyvalue Below Surface (S8) **(LRR S, T, U)**
- Thin Dark Surface (S9) **(LRR S, T, U)**
- Barrier Islands 1 cm Muck (S12) **(MLRA 153B, 153D)**
- Loamy Mucky Mineral (F1) **(LRR O)**
- Loamy Gleyed Matrix (F2)
- Depleted Matrix (F3)
- Redox Dark Surface (F6)
- Depleted Dark Surface (F7)
- Redox Depressions (F8)
- Marl (F10) **(LRR U)**
- Depleted Ochric (F11) **(MLRA 151)**
- Iron-Manganese Masses (F12) **(LRR O, P, T)**
- Umbric Surface (F13) **(LRR P, T, U)**
- Delta Ochric (F17) **(MLRA 151)**
- Reduced Vertic (F18) **(MLRA 150A, 150B)**
- Piedmont Floodplain Soils (F19) **(MLRA 149A)**
- Anomalous Bright Floodplain Soils (F20) **(MLRA 149A, 153C, 153D)**
- Very Shallow Dark Surface (F22) **(MLRA 138, 152A in FL, 154)**

Indicators for Problematic Hydric Soils³:

- 1 cm Muck (A9) **(LRR O)**
- 2 cm Muck (A10) **(LRR S)**
- Coast Prairie Redox (A16) **(outside MLRA 150A)**
- Reduced Vertic (F18) **(outside MLRA 150A, 150B)**
- Piedmont Floodplain Soils (F19) **(LRR P, T)**
- Anomalous Bright Floodplain Soils (F20) **(MLRA 153B)**
- Red Parent Material (F21)
- Very Shallow Dark Surface (F22) **(outside MLRA 138, 152A in FL, 154)**
- Barrier Islands Low Chroma Matrix (TS7) **(MLRA 153B, 153D)**
- Other (Explain in Remarks)

³Indicators of hydrophytic vegetation and wetland hydrology must be present, unless disturbed or problematic.

Restrictive Layer (if observed):

Type: _____
 Depth (inches): _____

Hydric Soil Present? Yes X No _____

Remarks:



Attachment 3

**Threatened & Endangered Species
Habitat Suitability Assessment**



Threatened & Endangered Species Habitat Suitability Assessment

**San Jacinto Waste Pits Superfund
Site - Northern Impoundment**

McGinnes Industrial Maintenance Corporation &
International Paper Company

December 7, 2022

Contents

1.	Introduction	1
1.1	Project Area Description	1
1.2	Description of the Project	1
1.3	Project Purpose and Goals	1
2.	Baseline Environmental Conditions	2
2.1	Climate	2
2.2	Topography and Soils	2
2.3	Habitat Elements	2
2.3.1	Habitat Access and Connectivity	2
2.3.2	Tidal Influence and Hydrology	2
3.	Background Review of Species and Critical Habitat	3
3.1	Database Searches	3
3.2	Listed Species Under Consideration	3
3.2.1	West Indian Manatee (<i>Trichechus manatus</i>)	7
3.2.1.1	Federal Status	7
3.2.1.2	Critical Habitat	7
3.2.1.3	Life History	7
3.2.1.4	Numbers, Reproduction, and Distribution	7
3.2.1.5	Conservation Needs and Threats	7
3.2.2	Saltmarsh Topminnow (<i>Fundulus jenkinsi</i>)	8
3.2.2.1	Federal Status	8
3.2.2.2	Critical Habitat	8
3.2.2.3	Life History	8
3.2.2.4	Numbers, Reproduction, and Distribution	8
3.2.2.5	Conservation Needs and Threats	8
3.3	Critical Habitat	8
4.	Species Assessments at Project Area	8
4.1	Field Survey Results	8
4.2	West Indian Manatee	9
4.2.1	Project Area Numbers, Reproduction, and Distribution	9
4.2.2	Project Area Conservation Needs and Threats	9
4.3	Salt Marsh Topminnow	9
4.3.1	Project Area Numbers, Reproduction, and Distribution	9
4.3.2	Project Area Conservation Needs and Threats	9
5.	Analysis of Effects	10
5.1	General	10
5.2	Elevated Underwater Noise Levels	10
5.2.1	West Indian Manatee	10
5.2.2	Saltmarsh Topminnow	11
5.3	Temporary Loss of In-Water Habitat and Altered Hydrology	11
5.3.1	West Indian Manatee and Saltmarsh Topminnow	11

Contents

5.4	Cumulative Effects	12
5.5	Effects on Tribal Resources or Interests	12
6.	Potential Conservation Measures	12
6.1	General Measures that Apply to All Species and Essential Fish Habitat	12
6.2	West Indian Manatee	13
6.3	Saltmarsh Topminnow	13
7.	Effects Determination	13
7.1	Species Determination	14
7.2	Critical Habitat Determination	14
8.	Essential Fish Habitat	14
8.1	EFH Within the Project Area	14
8.1.1	EFH and HAPC	14
8.2	Effects to EFH as a Result of the Project	15
9.	Marine Mammal Protection Act	15
10.	Conclusions	15
11.	References	17

Table index

Table 1	Listed or Proposed Species and Critical Habitat Determinations	3
---------	--	---

Appendices

Appendix A	Figures
Appendix B	USFWS & NMFS Species Lists

List of Acronyms

BMP	-	Best Management Practice
CERCLA	-	Comprehensive Environmental Response, Compensation, and Liability Act
CFR	-	Code of Federal Regulations
cfs	-	cubic feet per second
CWA	-	Coastal Water Authority
CY	-	cubic yards
dB	-	decibels
dB _{peak}	-	Peak decibels
dB _{rms}	-	root-mean-squared decibels
DPS	-	Distinct Population Segment
EFH	-	Essential Fish Habitat
EPA	-	U.S. Environmental Protection Agency
ESA	-	Endangered Species Act
FEMA	-	Federal Emergency Management Agency
FMP	-	Fisheries Management Plans
FR	-	Federal Register
FWC	-	Florida Fish and Wildlife Commission
HAPCs	-	Habitat Areas of Particular Concern
HSC	-	Houston Ship Channel
IPaC	-	Information for Planning and Consultation
IPC	-	International Paper Company
kg	-	kilogram
L	-	liter
MIMC	-	McGinnes Industrial Maintenance Corporation
MMPA	-	Marine Mammal Protection Act
MNR	-	Monitored Natural Recovery
MSA	-	Magnuson-Stevens Fishery Conservation and Management Act
NAVD88	-	North American Vertical Datum of 1988
ng	-	nanogram
NLAA	-	Not Likely to Adversely Affect
NMFS	-	National Marine Fisheries Service
NWP	-	Nationwide Permit
PCBs	-	Polychlorinated biphenyls
POHA	-	Port of Houston Authority
POPs	-	persistent organic pollutants
ppt	-	parts per trillion
PSLM	-	Practical Spreading Loss Model
PTS	-	Permanent Threshold Shift
RA	-	Remedial Action
RI	-	Remedial Investigation
RI/FS	-	Remedial Investigation/Feasibility Study
ROD	-	Record of Decision
ROW	-	Right-of-Way
SEL	-	Sound Exposure Level
SSA	-	Sand Separation Area
TCRA	-	Time Critical Removal Action
TPH	-	Total Petroleum Hydrocarbons
TPWD	-	Texas Parks and Wildlife Department
TWG	-	Technical Working Group
TxDOT	-	Texas Department of Transportation
TXNDD	-	Texas Natural Diversity Database
U.S.C.	-	United States Code
µg	-	micrograms
USACE	-	U.S. Army Corps of Engineers
USFWS	-	U.S. Fish and Wildlife Service

1. Introduction

The purpose of this report is to provide technical information regarding the proposed remediation of the Northern Impoundment of the San Jacinto River Waste Pits Superfund Site (hereafter “Project”) in sufficient detail to document the extent to which the proposed Project may affect threatened, endangered, proposed, or candidate species.

GHD Services Inc. (GHD) conducted a site visit at the Northern Impoundment on October 6, 2021. GHD has also conducted a thorough database and literature search. Based on the site visit and the database and literature search, GHD has determined that the Project is located within the potential range of 28 Endangered Species Act (ESA)-listed, proposed, or candidate species. Of these 28 species, two were determined for purposes of the Project to be potentially present in or near the Northern Impoundment (Project Area): the West Indian Manatee and the Saltmarsh Topminnow.

This submittal has been completed to comply with substantive requirements of Section 7 of the ESA (16 United States Code [U.S.C.] §§ 1536) for the Project and to review the Project consistent with requirements established by the U.S. Army Corps of Engineers (USACE) and the United States Environmental Protection Agency (EPA). Section 7 of the ESA provides that, through consultation with the U.S. Fish and Wildlife Service (USFWS) or National Marine Fisheries Service (NMFS), a determination is to be made, as to whether proposed implementation of the Northern Impoundment remedy, as described in the ROD, would jeopardize the continued existence of any threatened, endangered, candidate, or proposed species, or result in the destruction or adverse modification of critical habitat.

1.1 Project Area Description

The Project (29°47'29.3" North, 95°3'58.4" West) is located in Harris County, Texas, east of the City of Houston and between two unincorporated areas known as Channelview and Highlands (see Appendix A, Figure 1).

The EPA Superfund Database Identification Number is TXN000606611. The EPA published a Record of Decision (ROD) for the clean-up in 2017 (EPA, 2017). This report is specific to the Project Area, including the Northern Impoundment, which is approximately 14 acres in size and is located north of Interstate Highway 10 (I-10); (Appendix A, Figure 2).

1.2 Description of the Project

The remedy selected by the EPA for the Northern Impoundment, as described in the ROD (EPA, 2017), includes the following:

- Removal of a portion of the existing armored cap material installed as part of the Time Critical Removal Action (TCRA).
- Removal of waste material exceeding the clean-up level of 30 nanograms per kilograms (ng/kg) 2,3,7,8-tetrachlorinated dibenzo-p-dioxin toxicity equivalent that is located beneath the armored cap and its stabilization, as necessary to meet the appropriate requirements for acceptance at a permitted disposal facility.

The remedy selected for the Northern Impoundment, as outlined in the ROD, includes excavation and off-site disposal of waste material located beneath the armored cap (installed as part of the TCRA) that exceeds the prescribed clean-up level of 30 ng/kg toxicity equivalent. As described in the ROD, the selected remedy is to utilize a Best Management Practice (BMP), such as a cofferdam.

1.3 Project Purpose and Goals

The purpose and goals of the removal action for the Project is as follows (as stated in the ROD (EPA, 2017)):

- Prevent releases of dioxins and furans above clean-up levels from the former waste impoundments to sediments and surface water of the San Jacinto River.

- Reduce human exposure to dioxins and furans from ingestion of fish by remediating sediments to appropriate clean-up levels.
- Reduce human exposure to dioxins and furans from direct contact with or ingestion of paper mill waste, soil, and sediment by remediating affected media to appropriate clean-up levels.
- Reduce exposures of benthic invertebrates, birds, and mammals to paper mill waste derived dioxins and furans by remediating affected media to appropriate clean-up levels.

2. Baseline Environmental Conditions

2.1 Climate

The climate is humid and subtropical, with the Project vicinity receiving approximately 54 inches of rain per year. Large thunderstorms are common to the region. Average temperatures range from a low of 54 degrees Fahrenheit to a high of 85 degrees Fahrenheit (EPA, 2017).

2.2 Topography and Soils

The Project vicinity is relatively level and includes the San Jacinto River and historic fill material within the river and beneath the TCRA armored cap. Elevations in the Northern Impoundment range from approximately 0 to 13 feet (0 to 4 meters) above sea level. Soils in the region are characterized by Holocene alluvial deposits and the Beaumont Formation (Pleistocene deposits, dominated by clays and silts). Within the Project Area, in the limited upland areas within the Northern Impoundment, soils are primarily sandy, with a low content of organic materials (EPA, 2017).

2.3 Habitat Elements

The Project vicinity is dominated by urban, industrial, and residential areas. Within the Project Area, there is little intact native upland vegetation. Only a narrow strip of estuarine riparian and some wetland vegetation along the shoreline outside of the Northern Impoundment is present. A sandy intertidal zone (also narrow) exists in certain locations along the river. The Project is located in the low-gradient tidal estuary, near the confluence of the Houston Ship Channel (HSC) and the San Jacinto River (an area where the river transitions from a fluvial system to a deltaic plain). The HSC experiences a heavy degree of commercial and industrial traffic, from barges to ocean-going vessels, and in-water aquatic habitat features (e.g., sheltering and foraging locations for wildlife) are limited in the Project vicinity. However, the tidally-influenced channel and upper Galveston Bay do provide rearing and spawning habitat for a variety of fish and aquatic invertebrate species (EPA, 2017).

2.3.1 Habitat Access and Connectivity

The San Jacinto River is a wide, linear aquatic feature within an urban-industrial landscape. The River offers some habitat connectivity for aquatic species, between the Houston Dam (to the north at Lake Houston [reservoir]; located about 16 river miles north of the Northern Impoundment) and Galveston Bay (about 27 river miles to the south of the Northern Impoundment). Common, urban-adapted terrestrial wildlife species are likely present and presumably use and disperse through upland habitats (EPA, 2017).

2.3.2 Tidal Influence and Hydrology

The Project Area experiences diurnal tides (tidal ranges average around 2 feet [0.6 meters]), which vary over a 14-day cycle (minimum at neap tides, maximum at spring tides). Average salinity ranges from 10 to 20 parts per trillion (ppt).

The Project Area is within a Federal Emergency Management Agency (FEMA) “VE” floodway zone (within the 100-year flood plain), indicating that it is at risk of inundation from storm produced waves and a one percent annual chance flood event.

3. Background Review of Species and Critical Habitat

3.1 Database Searches

The Texas Natural Diversity Database (TXNDD) Information Request Tool (TXNDD, 2022), list of threatened and endangered species and critical habitats under National Oceanic and Atmospheric Administration (NOAA) Fisheries jurisdiction for the Gulf of Mexico NOAA Fisheries, 2020), and USFWS Information for Planning and Consultation (IPaC) tool (USFWS, 2020) were reviewed and queried for the Project vicinity (1 Quad search: Highlands) on November 4 and November 6, 2020. In addition, citizen science databases, such as eBird and iNaturalist were reviewed for additional local listed species location information (eBird, 2020, iNaturalist, 2020). Official species lists from the USFWS and NOAA Fisheries are provided as Appendix B. Based on these database searches, 28 species were identified as having potential to occur in the Project’s Project Area.

3.2 Listed Species Under Consideration

Table 1 shows the federally listed wildlife and plant species and critical habitat that for purposes of the Project are deemed to have potential to occur in the Project Area based on initial project scoping (IPaC Search; NMFS species list only available at the scale of the Gulf of Mexico). Based on existing scientific literature and technical reports, most species and critical habitat were eliminated from further consideration due to lack of habitat within the Project Area and/or the fact that the Project Area is located outside of the species’ known range (rationale for exclusion noted for each in Table 1). Species with potential to occur in the Project Area are described in the subsections below.

Table 1 Listed or Proposed Species and Critical Habitat Determinations

Common Name	Scientific Name	Federal Status	Determination/Species Potential to Occur in the Project Area	Critical Habitat in the Project Area
Mammals				
Fin Whale ^{a, b}	<i>Balaenoptera physalus</i>	E	No Effect/No Potential. Oceanic species. No documented occurrences from the Project Area or immediate vicinity and no suitable habitat present. Excluded from further consideration.	No Effect. No critical habitat has been designated.
Gulf of Mexico Bryde’s Whale ^a	<i>Balaenoptera edeni</i>	E	No Effect/No Potential. Oceanic species. No documented occurrences from the Project Area or immediate vicinity and no suitable habitat present. Excluded from further consideration.	No Effect. No critical habitat has been designated.
Sei Whale ^{a, b}	<i>Balaenoptera borealis</i>	E	No Effect/No Potential. Oceanic species. No documented occurrences from the Project Area or immediate vicinity and no suitable habitat present. Excluded from further consideration.	No Effect. No critical habitat has been designated.
Sperm Whale ^{a, b}	<i>Physeter macrocephalus</i>	E	No Effect/No Potential. Oceanic species. No documented occurrences from the Project Area or immediate vicinity and no suitable habitat present. Excluded from further consideration.	No Effect. No critical habitat has been designated.

Common Name	Scientific Name	Federal Status	Determination/Species Potential to Occur in the Project Area	Critical Habitat in the Project Area
West Indian Manatee ^{a, b}	<i>Trichechus manatus</i>	T	NLAA/Low Potential. There are a few records of this species from the Houston Shipping Channel; however, these are considered rare transients (two known records since 1995), likely attracted by warm water outfalls from treatment plants (Alexander, 2019, Gonzales, 2019). As the species is highly unlikely to occur in the Project Area, the Project may affect but is not likely to adversely affect this species.	No Effect. Final critical habitat has been designated but does not occur within the Project Area.
Birds				
Red Knot	<i>Calidris canutus rufa</i>	T	No Effect/Low Potential. No suitable wintering/stopover habitat is present and there are no nearby, recent records (species is only seasonally present in the region; does not breed in Texas [Benson and Arnold, 2001]). Records from vicinity associated migrants and wintering birds in areas of sandy beaches and mud flats (eBird, 2020). Based on the lack on suitable habitat and nearby records, the Project will have no effect on this subspecies and it is excluded from further consideration.	No Effect. No critical habitat designated for this subspecies.
Piping Plover	<i>Charadrius melodus</i>	T	No Effect/Low Potential. No suitable wintering/stopover habitat is present and there are no nearby, recent records (species is only seasonally present in the region; does not breed in Texas [Benson and Arnold, 2001]). Records from vicinity associated migrants and wintering birds in areas of sandy beaches and mud flats (eBird, 2020). Based on the lack on suitable habitat and nearby records, the Project will have no effect on this species and it is excluded from further consideration.	No Effect. Final critical habitat has been designated but does not occur within the Project Area.
Southwestern Willow Flycatcher	<i>Empidonax traillii extimus</i>	E	No Effect/No Potential. No recent breeding records from the state (Benson and Arnold, 2001), but subspecies is known occur in Texas during migration (a few records within 3 miles of the Project Area). No suitable breeding or stopover habitat (e.g., cottonwood-willow riparian corridor) present within the Project Area. Based on the lack of suitable habitat (and no potential for occurrence), the Project will have no effect on this subspecies and it is excluded from further consideration.	No Effect. Final critical habitat has been designated but does not occur within the Project Area.
Least Tern, Interior population	<i>Sterna antillarum</i>	E	No Effect/Moderate Potential. Year-round presence possible in aquatic habitat (Benson and Arnold, 2001). No breeding habitat is present (e.g., sparsely vegetated beaches, islands, and salt flats), but numerous recent nearby records of individuals foraging within the San Jacinto River (eBird, 2020). The species has a moderate potential to occur and forage in the Project Area. However, the species was recently delisted due to recovery and is excluded from further consideration.	No Effect. No critical habitat designated for this species.
Reptiles				
Loggerhead Sea Turtle, Northwest Atlantic Ocean DPS	<i>Caretta caretta</i>	T	No Effect/No Potential. This species is known to occur in Galveston Bay where suitable habitat is present (e.g., estuarine habitat, seagrass beds, oyster beds) (Bolt, 2020). The closest recent documented occurrence is from approximately 37 miles south of the Project Area (just offshore of the Bolivar Peninsula) (iNaturalist, 2020). No records are known from further north in the Houston Shipping Channel or San Jacinto River (where suitable habitat is not present). The species has no potential to occur in the Project Area and is excluded from further consideration.	No Effect. Critical habitat has been proposed but does not occur within the Project Area.

Common Name	Scientific Name	Federal Status	Determination/Species Potential to Occur in the Project Area	Critical Habitat in the Project Area
Green Sea Turtle, North Atlantic DPS	<i>Chelonia mydas</i>	T	No Effect/No Potential. This species is known to occur in Galveston and Trinity Bay where suitable habitat is present (e.g., estuarine habitat, seagrass beds, oyster beds) (Bolt, 2020, iNaturalist, 2020). The closest documented occurrences are from approximately 20 miles south of the Project Area (iNaturalist, 2020). No records are known from further north in the Houston Shipping Channel or San Jacinto River (where suitable habitat is not present). The species has no potential to occur in the Project Area and is excluded from further consideration.	No Effect. Final critical habitat has been designated but does not occur within the Project Area.
Leatherback Sea Turtle	<i>Dermochelys coriacea</i>	E	No Effect/No Potential. The Project Area does not contain any suitable marine habitat (seagrass, oyster beds, deep water, upwellings, etc.) suitable for the species. In addition, there are no known recent records of this species (observations or nesting) from the vicinity (including Galveston Bay to the south of the Project Area). The Project will have no effect on this species and it is excluded from further consideration.	No Effect. Final critical habitat has been designated but does not occur within the Project Area.
Hawksbill Sea Turtle	<i>Eretmochelys imbricata</i>	E	No Effect/No Potential. The Project Area does not contain any suitable marine habitat (seagrass, oyster beds, offshore waters and island shelves, coral reefs, etc.) suitable for the species. In addition, there are no known recent records of this species (observations or nesting) from the vicinity (including Galveston Bay to the south of the Project Area). The Project will have no effect on this species and it is excluded from further consideration.	No Effect. Final critical habitat has been designated but does not occur within the Project Area.
Kemp's Ridley Sea Turtle	<i>Lepidochelys kempii</i>	E	No Effect/No Potential. This species is known to occur in Galveston Bay where suitable habitat is present (e.g., estuarine habitat, seagrass beds, oyster beds) (Bolt, 2020, iNaturalist, 2020). The closest documented occurrences are from approximately 35 miles south of the Project Area (iNaturalist, 2020). No records are known from further north in the Houston Shipping Channel or San Jacinto River (where suitable habitat is not present). The species has no potential to occur in the Project Area and is excluded from further consideration.	No Effect. Critical habitat has been proposed but does not occur within the Project Area.
Fish				
Gulf Sturgeon	<i>Acipenser oxyrinchus desotoi</i>	T	No Effect/No Potential. No documented occurrences from the Project Area and Project Area outside the subspecies' current range. Excluded from further consideration.	No Effect. Final critical habitat has been designated but does not occur within the Project Area.
Oceanic Whitetip Shark	<i>Carcharhinus longimanus</i>	T	No Effect/No Potential. Oceanic species. No documented occurrences from the Project Area or immediate vicinity and no suitable habitat present. Excluded from further consideration.	No Effect. No critical habitat designated for this species.
Nassau Grouper	<i>Epinephelus striatus</i>	T	No Effect/No Potential. Oceanic species. No documented occurrences from the Project Area or immediate vicinity and no suitable habitat present. Excluded from further consideration.	No Effect. No critical habitat designated for this species.

Common Name	Scientific Name	Federal Status	Determination/Species Potential to Occur in the Project Area	Critical Habitat in the Project Area
Saltmarsh Topminnow	<i>Fundulus jenkinsi</i>	UR	NLAA/Low Potential. This species has been detected within the Project Area (TXNDD 2020, Fishes of Texas 2020; record from 1953). However, more recent occurrences are known only from the southern portion of Galveston Bay (EIH, 2015). Habitat preferences include low to moderate salinity saltmarsh. Given the lack of suitable saltmarsh habitat within the Project Area, presence is unlikely, and the Project may affect but is not likely to adversely affect the species.	No Effect. No critical habitat designated for this species.
Giant Manta Ray	<i>Manta birostris</i>	T	No Effect/No Potential. Oceanic species. No documented occurrences from the Project Area or immediate vicinity and no suitable habitat present. Excluded from further consideration.	No Effect. No critical habitat designated for this species.
Smalltooth Sawfish, US DPS	<i>Pristis pectinata</i>	E	No Effect/No Potential. No documented occurrences from the Project Area and the Project Area is outside the species' current range. Excluded from further consideration.	No Effect. Final critical habitat has been designated but does not occur within the Project Area.
Coral				
Elkhorn Coral	<i>Acropora palmata</i>	T	No Effect/No Potential. Oceanic species. No documented occurrences from the Project Area or immediate vicinity and no suitable habitat present. Excluded from further consideration.	No Effect. Final critical habitat has been designated but does not occur within the Project Area.
Staghorn Coral	<i>Acropora cervicornis</i>	T	No Effect/No Potential. Oceanic species. No documented occurrences from the Project Area or immediate vicinity and no suitable habitat present. Excluded from further consideration.	No Effect. Final critical habitat has been designated but does not occur within the Project Area.
Pillar Coral	<i>Dendrogyra cylindrus</i>	T	No Effect/No Potential. Oceanic species. No documented occurrences from the Project Area or immediate vicinity and no suitable habitat present. Excluded from further consideration.	No Effect. Critical habitat has been proposed but does not occur within the Project Area.
Rough Cactus Coral	<i>Mycetophyllia ferox</i>	T	No Effect/No Potential. Oceanic species. No documented occurrences from the Project Area or immediate vicinity and no suitable habitat present. Excluded from further consideration.	No Effect. Critical habitat has been proposed but does not occur within the Project Area.
Lobed Star Coral	<i>Orbicella annularis</i>	T	No Effect/No Potential. Oceanic species. No documented occurrences from the Project Area or immediate vicinity and no suitable habitat present. Excluded from further consideration.	No Effect. Critical habitat has been proposed but does not occur within the Project Area.
Mountainous Star Coral	<i>Orbicella faveolata</i>	T	No Effect/No Potential. Oceanic species. No documented occurrences from the Project Area or immediate vicinity and no suitable habitat present. Excluded from further consideration.	No Effect. Critical habitat has been proposed but does not occur within the Project Area.
Boulder Star Coral	<i>Orbicella franksi</i>	T	No Effect/No Potential. Oceanic species. No documented occurrences from the Project Area or immediate vicinity and no suitable habitat present. Excluded from further consideration.	No Effect. Critical habitat has been proposed but does not occur within the Project Area.

Common Name	Scientific Name	Federal Status	Determination/Species Potential to Occur in the Project Area	Critical Habitat in the Project Area
Plants				
Texas Prairie Dawn-flower	<i>Hymenoxys texana</i>	E	No Effect. The Project Area does not contain the requisite habitat (i.e., saline prairies with cryptogamic soils). No impacts are expected to occur to this species and, therefore, it is excluded from further consideration.	No Effect. Critical habitat has not been designated for this species.
Notes: a: Marine Mammal Protection Act (MMPA) Protected. B: MMPA Depleted. DPS: Distinct Population Segment. Federal Status: Federal Endangered (E); Federal Threatened (T); Under Review (UR). Determination: No Effect; May Affect, Not Likely to Adversely Affect (NLAA).				

3.2.1 West Indian Manatee (*Trichechus manatus*)

3.2.1.1 Federal Status

The West Indian Manatee was originally listed as endangered Species Preservation Act of 1966 (32 Code of Federal Register [FR] 4001). The listing was revised in 1970 to include the Caribbean and South American populations (i.e., Antillean Manatee, *Trichechus manatus manatus*) (35 FR 18319). The species was down-listed to threatened status on April 5, 2017 (82 FR 16668).

3.2.1.2 Critical Habitat

Critical habitat was designated in 1976 (50 Code of Federal Regulations [CFR] Part 17.95(a)) and includes habitat specifically in Florida.

3.2.1.3 Life History

There are two subspecies of West Indian Manatee, *Trichechus manatus manatus* and *Trichechus manatus latirostris*. The latter of these subspecies occurs in Florida and the Gulf of Mexico (USFWS, 1999, 2007). Manatees occur in freshwater, brackish and marine environments including coastal river estuaries, sloughs, canals, creeks, and lagoons (USFWS, 1999). The species requires a source of freshwater for drinking (USFWS, 2001). They are not cold-tolerant, preferring waters with temperatures above 20 degrees Celsius (°C), and remaining in warm-water sites during the winter (e.g., warm water springs and power plant outfall sites) (USFWS, 2001, USFWS, 2007). Breeding may occur year-round, although peak breeding is suspected to occur from March through November. Manatees form “mating herds” (one female and multiple males) to breed. The species feeds on submerged and emergent floating vegetation such as seagrass, hydrilla (*Hydrilla verticillata*), and smooth cordgrass (*Spartina alterniflora*) (USFWS, 2001).

3.2.1.4 Numbers, Reproduction, and Distribution

In the United States, manatees are found in tropical and subtropical coastal waters, rivers, estuaries, primarily in Florida and Puerto Rico. Manatees are relatively rare in Texas waters, with known occurrences only from Cow Bayou, Copano Bay, San Jose Island, the Bolivar Peninsula, and the mouth of the Rio Grande. These records are assumed to be migrants from coastal Mexico or Florida, specifically the USFWS’s “Northwest Management Unit” (USFWS, 2007, Texas Tech University, 2020). The current range-wide population estimate for the species is 13,000 individuals. Florida populations are experiencing positive population growth, sufficient reproductive rates, and high adult survival while Puerto Rico populations are stable (USFWS 2007, 2019b).

3.2.1.5 Conservation Needs and Threats

Threats to the species include human-caused mortality (watercraft collisions), interactions with commercial fishing gear, pollution, exposure to cold/loss of warm-water refugia, and red tides (*Gymnodinium breve*) (USFWS, 2007, USFWS, 2014).

3.2.2 Saltmarsh Topminnow (*Fundulus jenkinsi*)

3.2.2.1 Federal Status

The Saltmarsh Topminnow (*Fundulus jenkinsi*) was petitioned for listing under the ESA in 2010 (WildEarth Guardians and Felsen, 2010), and a 90-day finding determined that listing may be warranted (76 FR 49412). The species remains under review at this time.

3.2.2.2 Critical Habitat

As the species is not listed, no critical habitat has been designated.

3.2.2.3 Life History

Saltmarsh Topminnow occur year-round in small meandering intertidal channels of brackish marshes dominated by *Spartina alterniflora* and *Juncus roemerianus*. Channel and marsh salinities typically fall in the range of 1 to 4 parts per thousand (Lopez, et al., 2011). The species favors saltmarsh edge in particular (EIH, 2015). There are no known records of the species outside these habitat types (WildEarth Guardians and S. Felsen, 2010). Saltmarsh Topminnow are reproductively active during the spring and summer months and may spawn more than once per season (i.e., batch spawners) (EIH, 2015). Eggs are deposited within inner marsh habitat during high tides, typically at higher elevations than the surrounding habitat. The eggs are exposed to air and hatch following inundation at the next high tide (Paille, 2019). The species forages on terrestrial and aquatic invertebrates (EIH, 2015).

3.2.2.4 Numbers, Reproduction, and Distribution

The Saltmarsh Topminnow is found in patchy populations occurring along the Gulf Coast from Texas (Galveston Bay) to Florida. Within Galveston Bay, populations are known from West Bay, Trinity Bay, Oyster Bayou, and Dickinson Bayou (Robertson, 2016). Approximately two dozen occupied sites are currently known range-wide (NatureServe, 2021), however, no detailed information is available on total population size or trends.

3.2.2.5 Conservation Needs and Threats

Little is known regarding habitat preferences, reproductive ecology, and local population sizes and trends for this species, which has hampered the identification of conservation needs and threats. However, most threats are likely related to the fact that the species' historic distribution has contracted significantly as a result of coastal development along the southeastern coast of the United States. At this time, assumed threats are coastal development, impacts to water quality, sea level rise, and lack of legal protections (WildEarth Guardians and S. Felsen, 2010). Local populations are also vulnerable to extirpation and recolonization is unlikely (NatureServe, 2021).

3.3 Critical Habitat

No federally designated or proposed critical habitat occurs within the Project's Project Area.

4. Species Assessments at Project Area

4.1 Field Survey Results

GHD performed an on-site visual survey of the Northern Impoundment. During this survey, terrestrial habitats were examined to determine suitability for supporting threatened, endangered, or candidate species. Utilizing the information gathered from database searches and desktop queries, physical characteristics of terrestrial habitats were observed on-site to determine suitability. No aquatic (e.g., in water or underwater) surveys were performed.

Habitats identified on-site included a palustrine emergent wetland (PEM) (Appendix A, Figure 3). This wetland has been significantly disturbed, as described in Sections 2.2.1 and 2.2.2. While this habitat meets the three criteria (hydrophytic vegetation, hydric soils, and hydrology) necessary to be classified as a wetland, significant disturbance has resulted in low-quality wetland functions and values. Consequently, it was determined that this wetland location is not suitable habitat for the species listed in Table 1. Additionally, the wetlands proximity to I-10 (where high noise levels and human activities are present) represents another factor that makes it unsuitable for habitation by threatened, endangered, or candidate species.

4.2 West Indian Manatee

4.2.1 Project Area Numbers, Reproduction, and Distribution

There are a few records of this species from the Houston Shipping Channel (occurrences from months of November and December; one in 1995 and one in 2019); however, these are considered rare transients from Florida or Mexico likely attracted by warm water outfalls from treatment plants (Alexander, 2019, Gonzales, 2019, Texas Tech University, 2020). No reproductive activity occurs within the Project Area (no sites where manatees congregate or raise young, as such sites are limited to Florida and Puerto Rico) (USFWS, 2001, 2007). The potential for transients to occur in the Project Area would be low based on previous records.

4.2.2 Project Area Conservation Needs and Threats

Threats to the species within the Project Area (if present) could include boat strikes, and exposure to pollutants, among others.

4.3 Salt Marsh Topminnow

4.3.1 Project Area Numbers, Reproduction, and Distribution

This species has been detected within the Project Area (TXNDD, 2022, Fishes of Texas, 2020; record from 1953). The detection appears to be from an off-river channel (west side of river) just north of the river confluence with Buffalo Bayou (Robertson, 2016). However, more recent occurrences are known only from Trinity Bay and Galveston Bay, with Trinity Bay drainage containing the highest number of occupied sites (EIH, 2015). From 2014 through 2015, 613 individuals were captured in saltmarsh and tidal channel habitat around Galveston Bay (Robertson, 2016). Occurrences were restricted to saltmarsh and tidal channels along the bay edges (habitat preferences include low to moderate salinity saltmarsh). The species was not detected associating with other open-water fish species (suggesting it does not use that habitat type) (EIH, 2015). Given the lack of suitable saltmarsh and tidal habitat required by the species for spawning, sheltering, and foraging within the Project Area (strictly open-water only), presence of this species in the Project Area is highly unlikely.

4.3.2 Project Area Conservation Needs and Threats

Threats to the species (if present) within the Project Area could include further urbanization in the vicinity of Galveston Bay, which could ultimately result in fragmentation or loss of saltmarsh and tidal channel habitat (NatureServe, 2021).

5. Analysis of Effects

5.1 General

The Project includes removal of contaminated materials and sediment from the Northern Impoundment within the San Jacinto River. Clean-up activities associated with the Project have the potential to affect ESA-listed species, although it is unlikely that they would have any such affect. Potential effects of the proposed Project on listed wildlife could include disturbance or injury to individuals from elevated levels of underwater noise during pile driving, loss of in water habitat (through temporary fill, i.e., within the Project's primary BMP) during the Northern Impoundment RA.

The potential for incidental take (kill, wound, and harm in this instance) under the federal ESA (16 U.S.C. 1531, et seq.) was analyzed for listed species, as to which it was concluded, for purposes of the Project, may occur in the Project Area during Project activities. It is important to note that the effects of an action "may occur later in time and may include consequences occurring outside the immediate area involved in the action" (50 CFR §402.17). Under the ESA, the definitions for kill and wound are self-explanatory (not defined in text). Harm is defined as "an act which actually kills or injures wildlife. Such an act may include significant habitat modification or degradation where it actually kills or injures wildlife by significantly impairing essential behavior patterns, including breeding, feeding, or sheltering" (50 CFR §17.3). Exposure to and consequences of Project construction on each species under consideration are detailed below (see Section 3.2 for species under consideration). The Project, as currently proposed, may result in the following effects to the species if present during construction.

5.2 Elevated Underwater Noise Levels

5.2.1 West Indian Manatee

Transient manatees could occur year-round in the Project Area, with the highest potential for presence during summer and fall outside the November through April construction period that is planned for the Northern Impoundment. The summer and fall is when the species engages in far-ranging movements, although all previous transients in the San Jacinto River watershed were detected during the winter months. If present, an increase in underwater noise levels (associated with pile driving) could potentially affect manatees through permanent injury to hearing, temporary injury to hearing, and masking (through auditory interference) of important communication calls (NOAA, 2016). Since manatees may heavily rely on their hearing for intraspecific communication and navigation, permanent and temporary effects to their hearing could significantly impact individual animals (NMFS, 2018a).

Potential for underwater noise impacts (specifically auditory injury or a Permanent Threshold Shift [PTS]) to manatees were modeled based on the NMFS 2018 Technical Guidance for Assessing the Effects of Anthropogenic Sound on Marine Mammal Hearing (NMFS, 2018a) using the associated 2020 Optional Worksheet (NMFS, 2020). The worksheet currently does not include the option to calculate noise impacts to manatees. This being the case, expected noise effects to pinnipeds (specifically phocids) were used as a proxy for manatees in the Project Area (CBD, 2014, NMFS, 2018a).

The NMFS 2018 Technical Guidance does not include published guidance on marine mammal harassment thresholds (NMFS, 2018a). However, NOAA Fisheries has published general underwater behavioral disturbance guidelines for all marine mammals as 160 root-mean-squared decibels (dBrms) for impulsive noise, such as pile driving (NOAA Fisheries, 2019). These thresholds were input into the NMFS-recommended Practical Spreading Loss Model (PSLM) (NMFS, 2012) to model potential marine mammal underwater noise disturbance isopleths from pile driving.

Based on the NMFS (2020) Optional Worksheet, pile driving noise may affect manatees in the river as far south as Hog Island and as far north as Gilbert Landing. Specifically, pile driving is expected to result in elevated underwater noise levels that may cause auditory injury (PTS) to and disturb manatees within approximately 0.14 miles (220 meters) and 0.31 miles (498 meters) of pile driving activities, respectively. Given the extremely transient nature and rarity of manatees within the San Jacinto River, it is unlikely that they would be present in the Project Area at any

given time during pile driving activities. However, to minimize the potential for elevated levels of underwater noise to affect manatees in the immediate vicinity (if any), conservation measures will be implemented, as detailed in Section 6.

5.2.2 Saltmarsh Topminnow

According to Buehler, et al. (2015), “Little is known regarding the thresholds of behavioral effects of ...sound on fish of the types of behavioral modification that may be considered harm or harassment. It is clear that fish can react to a sudden loud sound with a startle or avoidance response, but they may also quickly habituate to the sound.” There is currently no scientifically supported threshold for the onset of changes in fish behavior resulting from underwater sound (Hastings and Popper, 2005). However, NMFS and USFWS set interim criteria for injury to fish (based on noise associated with pile driving activities) in June 2008. They identify sound pressure levels of 206 peak decibels (dB_{peak}) and 187 decibels (dB) accumulated sound exposure level (SEL) for all fish except for those that are less than 2 grams as potentially causing physical injury. For fish less than two grams in mass, the injury threshold for accumulated SEL is 183 dB. Additionally, SELs greater than 150 dB could cause behavioral effects (Fisheries Hydroacoustic Working Group, 2008). To consider underwater pile driving noise impacts to Saltmarsh Topminnow, the Practical Spreading Loss Model (PSLM), as described above, was used (NMFS, 2012). As Saltmarsh Topminnow typically weigh less than 2 grams in mass (Robertson, 2016), the injury threshold of 183 dB SEL was applied.

Based on PSLM results, no injury would occur to Saltmarsh Topminnow unless they were immediately adjacent to pile driving activities (closer than 5 meters or approximately 16.5 feet). As no suitable habitat is present for this species that close to proposed areas of pile driving, no effect is expected. However, fish present within approximately 1.5 miles (2311 meters) may exhibit behavioral disturbance as a result of elevated underwater noise levels. As there are no recent records of Saltmarsh Topminnow north of the Trinity Bay drainage, any potential for exposure to the effect would be highly unlikely. However, to minimize the potential for any disturbance to Saltmarsh Topminnow in the Project Area, if present, conservation measures such as a “soft start” prior to full-force pile driving could be implemented (see Section 6).

5.3 Temporary Loss of In-Water Habitat and Altered Hydrology

The Project’s BMP (a double-walled cofferdam), as currently proposed, would be a 9 foot (2.7 meters) NAVD88 impermeable barrier located in the San Jacinto River outside the footprint of the Northern Impoundment. Following RA activities, the BMP would be removed. It is expected that this temporary, new fill may alter hydrology in the immediate vicinity during the time that it is in place. In addition, this would serve as a temporary loss of in-water habitat for listed species, to the extent such species may be present.

5.3.1 West Indian Manatee and Saltmarsh Topminnow

Temporary fill and altered hydrology in the Project Area are not expected to affect Salt Marsh Topminnow for the following reasons: no suitable habitat for the topminnow is available in the Project Area (i.e., no saltmarsh habitat present, and the species is not found in the open water habitat of the Project Area) and there are no recent records of this species from the watershed north of Trinity Bay.

Similarly, while manatees may move through the Project Area (heading north upriver), suitable habitat for the species is absent in the Project Area (no foraging or breeding habitat in the vicinity). All recent detections of manatees in the San Jacinto River are assumed to be lost, dispersing individuals, attracted by anthropogenic warm water outfalls in the area. The temporary fill is not a permanent barrier and therefore would not block manatee movement in the channel, if any. This being the case, temporary fill and potential altered hydrology in the Project Area is not expected to adversely affect West Indian Manatees.

5.4 Cumulative Effects

Cumulative effects are “those effects of future State or private activities, not involving Federal activities, that are reasonably certain to occur within the action area of the Federal action subject to consultation” (50 CFR §402.02). ESA consultation procedures specify that “a conclusion of reasonably certain to occur must be based on clear and substantial information, using the best scientific and commercial data available. Factors to consider when evaluating whether activities caused by the proposed action (but not part of the proposed action) or activities reviewed under cumulative effects are reasonably certain to occur include, but are not limited to:

1. Past experiences with activities that have resulted from actions that are similar in scope, nature, and magnitude to the proposed action.
2. Existing plans for the activity.
3. Any remaining economic, administrative, and legal requirements necessary for the activity to go forward” (50 CFR §402.17).

It is expected that work may contribute to elevated noise levels (if pile driving is involved, elevated underwater noise levels are expected) in the Project Area. In addition, improvements at the Lake Houston Dam (external to the Project) are expected alter flow within the San Jacinto River (may also alter in-water turbidity). These effects (noise and turbidity) and the effects of the Project, when considered together, may affect, but are unlikely to adversely affect the West Indian Manatee and Salt Marsh Topminnow. This is specifically due to the extreme transient nature and rarity of the species in the Project Area, very low potential for occurrence, and therefore negligible potential for exposure to the effects.

5.5 Effects on Tribal Resources or Interests

Recreational fishing is known to occur in the Project Area (though extensive signage in the area prohibits it), and some level of subsistence fishing is assumed for purposes of this analysis. However, the Project Area is not considered to be a tribal hunting or fishing site. In addition, no listed species with tribal cultural significance will be affected by the Project. The Project will have no known effect on tribal resources or interests.

6. Potential Conservation Measures

Conservation measures are intended to avoid, minimize, or compensate for environmental impacts to protected species and their habitats. To minimize potential impact on all species, including the two threatened or endangered species identified herein, the remedial contractor(s) (RC) may implement some or all of the measures identified in this Section 6.

6.1 General Measures that Apply to All Species and Essential Fish Habitat

- For pile driving activities, the RC will be encouraged to implement ramp-up/“soft start” procedures prior to starting work each day, after each break of 30 minutes, and if any increase in intensity is required. These procedures involve a slow increase in the pile driving to allow any undetected animals in the area to voluntarily depart. Specifically, the ramp-up procedure requires operators to provide an initial set of three strikes from the impact hammer at 40 percent energy, followed by a 30-second waiting period, then two subsequent 3-strike sets.
- The RC will be encouraged to idle heavy equipment operating from barges or nearshore for 15 minutes prior to using full-force power.
- In addition to the primary Project BMP (assumed cofferdam), the plans for implementation of the Northern Impoundment RA will include stormwater controls, such as silt fences, implemented to prevent entry of

stormwater runoff into tidal waters, the entrainment of excavated contaminated materials leaving the work site, and the entry of impacted stormwater runoff into coastal waters during the transportation and storage of excavated materials.

- The plans will also address the management of construction materials, debris, or dredge material and of stormwater that may contact such materials, and will include measures to address management of any spills, leaks or other release of Total Petroleum Hydrocarbons (TPH) or other deleterious substances to the greatest extent feasible.

6.2 West Indian Manatee

Measures below are adapted from the 2019 USACE guidance on conservation measures for West Indian Manatees (USFWS, 2019a) and Florida Fish and Wildlife Commission (FWC) guidance on in-water work that may affect manatees (FWC, 2011).

- The RC will be encouraged to have a qualified biologist instruct all personnel associated with the Project of the potential presence of manatees, the need to avoid collisions with manatees during a formal environmental awareness training, and of the civil and criminal penalties for harming, harassing, or killing manatees which are protected under the Marine Mammal Protection Act of 1972 and the Endangered Species Act of 1973.
- All personnel should be encouraged to monitor water-related activities for the presence of manatee(s).
- The RC will be encouraged to take extreme care when lowering equipment and materials below the water surface and/or to the water bottom. All such equipment/material may be lowered as slow as possible, to avoid injury to any manatee that may have entered the Project Area undetected.
- The RC will also be encouraged to adopt procedures requiring that pile-driving work should cease if a manatee or marine mammal is observed within 1,000 feet (305 meters) of pile driving activities.
- If manatee(s) are seen within 300 feet (91 meters) of active Project in-water work other than pile driving (i.e., movement of barges, excavation), the RC will be encouraged to implement appropriate precautions intended to provide protections for the manatee. These precautions may include the operation of all moving equipment no closer than 50 feet (15 meters) to a manatee. Operation of any equipment as part of in-water work closer than 50 feet (15 meters) to a manatee may necessitate immediate shutdown of that equipment if feasible. Activities will not resume until the manatee(s) has departed the Project vicinity of its own volition or has not reappeared for 30 minutes.

6.3 Saltmarsh Topminnow

In addition to the measures detailed in Section 6.1, excavation and off-site disposal of impacted material from beneath the TCRA armored cap will occur outside of salt marsh habitat.

7. Effects Determination

This report has been prepared in compliance with Section 7 of the ESA to evaluate the potential adverse effects of the proposed Project on federally listed Endangered or Threatened species. Of the 28 federally listed or proposed species with potential to occur in the Project Area, 26 species (discussed in Table 1) were ruled out from further consideration due to the lack of suitable habitat in the Project Area and/or because the Project Area lies outside of the species' known current geographic range. As previously discussed, one federally listed species and one proposed species have the potential to occur in the Project Area: the West Indian Manatee and Saltmarsh Topminnow. Each of these species has the potential to occasionally enter the Project Area and they were, therefore, assessed. Such rare and transient occurrences would generally preclude the presence of the species in the Project Area during construction, and the lack of suitable habitat within the Project Area to support any stages of the species life cycle (breeding, foraging, etc.) would support a No Effect finding. Even so, a "May Affect, Not Likely to Adversely Affect" finding is

proposed to be applied to account for the low probability of members of these species entering the Project Area during construction. At this time, the finding would apply solely to the ESA-listed West Indian Manatee; the proposed Saltmarsh Topminnow would be included in protections only if elevated to listed or proposed status prior to construction.

7.1 Species Determination

- This Project will have No Effect on the species excluded in Table 1 (see table for rationale).
- Based on the analysis presented herein, it is anticipated that the proposed Project May Affect but is Not Likely to Adversely Affect the West Indian Manatee. Potential effects to this species would be avoided through the implementation of best practices and proposed conservation measures (Section 6).
- The proposed Saltmarsh Topminnow would be included in protections only if elevated to listed or proposed status prior to construction. If elevated to listed or proposed status, based on the analysis herein, it is anticipated that the proposed action May Affect but is Not Likely to Adversely Affect the Saltmarsh Topminnow.

7.2 Critical Habitat Determination

This Project will have No Effect on critical habitat for any of the species in Table 1.

8. Essential Fish Habitat

The Magnuson-Stevens Fishery Conservation and Management Act (MSA), as amended by the 1996 Sustainable Fisheries Act (Public Law 104-297), mandates inter-agency cooperation in achieving protection, conservation, and enhancement of Essential Fish Habitat (EFH). The Act defines EFH as “those waters and substrate necessary to fish for spawning, breeding, feeding, or growth to maturity.” EFH designations serve to highlight the importance of habitat conservation for sustainable fisheries and sustaining valuable fish populations. EFH relates directly to the physical fish habitat and indirectly to factors that contribute to degradation of this habitat. Important features of EFH that deserve attention are adequate water quality, temperature, food source, water depth, and cover/vegetation. EFH is designated for species managed in Fisheries Management Plans (FMP) under the MSA.

8.1 EFH Within the Project Area

EFH applies to species within the Project Area for the proposed Project. The Project Area overlaps with EFH for Coastal Migratory Pelagics, Red Drum, reef fish, shrimp, and Bull Shark. These species/groups are managed under individual FMPs of the same except for the Bull Shark (managed under the Atlantic Highly Migratory Species FMP).

8.1.1 EFH and HAPC

Considerations for EFH and Habitat Areas of Particular Concern (HAPCs) were amended in 1998 and 2005, respectively, to FMPs for coastal migratory pelagics, Red Drum, reef fish, and shrimp. In the 1998 amendment, EFH was defined for estuarine areas as “all estuarine waters and substrates (mud, sand, shell, rock and associated biological communities), including the sub-tidal vegetation (seagrasses and algae) and adjacent inter-tidal vegetation (marshes and mangroves).” The policy objectives of the amendment were to protect and maintain existing productive habitats, restore degraded habitats, and develop new productive habitats (NOAA Fisheries, 1998). The 2005 amendment further defined EFH by species/groups by designating specific geographic areas (NOAA Fisheries, 2005). Bull Shark EFH was addressed in a separate amendment (amendment 10) to the Atlantic Highly Migratory Species FMP in 2017 (NOAA Fisheries, 2017).

8.2 Effects to EFH as a Result of the Project

The Project Area occurs within a low-gradient tidal estuary, where the San Jacinto River transitions from a fluvial system to a deltaic plain. Many elements considered to be EFH (as defined above) for the above listed species or groups are not present. For example, there are no known seagrass beds within Galveston Bay or further north in the San Jacinto River channel; seagrass beds are currently limited to barrier islands outside the Bay (e.g., around Christmas Bay) (Dunton, et al., 2011, Galveston Bay Status and Trends, 2017b). In addition, no remaining saltmarsh marsh or large areas of emergent vegetation are present in the Project Area (i.e., primarily an open channel subject to heavy scour during tropical storms). Other elements such as shellfish beds (e.g., oyster beds) are not present north of San Jacinto Bay (Galveston Bay Status and Trends, 2017a). Mud substrate is present within the Project Area. Project activities will involve excavation and off-site disposal of impacted materials, pile driving, and installation of a temporary structure, BMP, in the channel. Adverse effects to EFH in the Project Area may include the following:

- Temporary increase in turbidity and suspended sediments.
- Temporary displacement from EFH foraging or dispersal areas.
- Temporary loss of in-channel open water habitat.

Due to the nature of the Project, there is a potential for adverse effects to EFH from sediment suspension into the San Jacinto River, as well as temporary fill (i.e., Project's BMP). However, the Project makes up a very small portion of aquatic habitat within the estuarine system and does not include biological features associated with high quality spawning or foraging habitat (i.e., habitat value is primarily limited to a dispersal corridor). The temporary in-water fill would also not completely block or obstruct dispersal or migratory movements up or down river. With implementation of conservation measures (Section 6) to ensure that the Project avoids and/or minimizes potential impacts to water quality described above, the Project is not expected to adversely affect EFH.

9. Marine Mammal Protection Act

The MMPA (16 U.S.C. 1362) of 1972 prohibits the "taking" of marine mammals and restricts the import, export, or sale of marine mammals. Take is defined as "the act of hunting, killing, capture, and/or harassment of any marine mammal; or the attempt at such." Harassment includes disruption of behavioral patterns. Implementation of the MMPA is divided between USFWS (sea otters, walruses, polar bears, manatees, and dugongs) and NOAA Fisheries (pinnipeds including seals and sea lions and cetaceans including dolphins and whales). Incidental Harassment Authorizations (IHA) or Letters of Authorization (LOA) may be issued for certain activities which can result in small amounts of take associated with another activity. Given the location of the Project Area (30 or more miles upriver from the Gulf and within a heavily used shipping channel area), suitable habitat for most MMPA-protected species is absent. There are no recent records of any MMPA-protected species in the vicinity except for two incidental West Indian Manatee occurrence records. Based on the rare and transient nature of manatees within the Project vicinity, it is unlikely that take of marine mammals will occur because of the Project. Consultation under the MMPA should not be required.

10. Conclusions

The following points summarize the conclusions made in the desktop background review and field surveys:

- Twenty-eight Endangered Species Act (ESA)-listed, proposed, or candidate species were evaluated.
- Desktop background review and on-site field surveys determined that the Project Area lacks suitable habitat for 26 of the 28 species evaluated.
- For purposes of the Project, only two species were determined to be potentially present in or near the Project Area: the West Indian Manatee and the Saltmarsh Topminnow.

- Potential effects of the proposed Project on listed wildlife could include disturbance or injury to individuals from elevated levels of underwater noise during pile driving, temporary loss of in water habitat (through temporary fill, i.e., Project’s primary BMP) and improved habitat quality (particularly surface water quality) in the Project Area.
- As a temporary and short-term increase in suspension of in-water sediment is expected to fall within baseline levels (due to the dynamic nature of the Project Area and river system), and federally-listed or proposed species are unlikely to occur in the Project Area during pile driving activities, no adverse effects to manatees or topminnow are expected.
- Given the transient nature and rarity of manatees within the San Jacinto River, it is unlikely that they would be present in the Project Area at any given time during pile driving activities. However, to minimize the potential for elevated levels of underwater noise to affect manatees in the immediate vicinity (if any), conservation measures may be implemented, as detailed in Section 6.
- As there are no recent records of Saltmarsh Topminnow north of the Trinity Bay drainage, any potential for exposure of elevated underwater noise levels would be highly unlikely. However, to minimize the potential for any disturbance to Saltmarsh Topminnow in the Project Area, if present, conservation measures, such as a “soft start” prior to full-force pile driving may be adopted, as detailed in Section 6.
- The temporary fill is not a permanent barrier and therefore would not block manatee movement, if any, in the channel. This being the case, temporary fill and potential altered hydrology in the Project Area is not expected to adversely affect West Indian Manatees.
- Temporary fill and altered hydrology in the Project Area are not expected to affect Salt Marsh Topminnow for the following reasons: no suitable habitat for the topminnow is available in the Project Area (i.e., no saltmarsh habitat present, and the species is not found in the open water habitat of the Project Area) and there are no recent records of this species from the watershed north of Trinity Bay.
- Noise and turbidity effects of the proposed Project may affect but are unlikely to adversely affect the West Indian Manatee and Salt Marsh Topminnow. This is specifically due the extreme transient nature and rarity of the species in the Project Area, very low potential for occurrence, and therefore negligible potential for exposure to the effects.
- Based on the analysis presented herein, it is anticipated that the proposed action May Affect but is Not Likely to Adversely Affect the West Indian Manatee. Potential effects to this species may be addressed through the implementation of proposed conservation measures (Section 6).
- The proposed Saltmarsh Topminnow would be included in protections only if elevated to listed or proposed status prior to construction. If elevated to listed or proposed status, based on the analysis herein, it is anticipated that the proposed Project May Affect but is Not Likely to Adversely Affect the Saltmarsh Topminnow.
- The proposed Project will have No Effect on critical habitat for any of the species in Table 1.
- Due to the nature of the Project, there is a potential for adverse effects to EFH from sediment suspension into the San Jacinto River, as well as temporary fill (i.e., Project’s BMP):
 - However, the Project makes up a very small portion of aquatic habitat within estuarine system and does not include biological features associated with high quality spawning or foraging habitat (i.e., habitat value is primarily limited to a dispersal corridor).
 - The temporary in-water fill would also not completely block or obstruct dispersal or migratory movements up or down river. With implementation of conservation measures (Section 6) to ensure that the Project avoids and/or minimizes potential impacts to water quality described above, the Project is not expected to adversely affect EFH.
- Given the location of the Project Area (30 or more miles upriver from the Gulf and within a heavily used shipping channel area), suitable habitat for MMPA-protected species is absent.
- Ultimately, the Project is expected to have a beneficial effect on listed wildlife in the San Jacinto River, to the extent present.

11. References

- Alexander, H. 2019. Rescue planned for manatee in Trinity Bay. CHRON.com. <<https://www.chron.com/neighborhood/bayarea/news/article/Rescue-planned-for-manatee-in-Trinity-Bay-5915077.php>>. Accessed November 6, 2021.
- Benson, K. L. P., and K. A. Arnold. 2001. The Texas Breeding Bird Atlas. Texas A&M University System, College Station and Corpus Christi, Texas, USA. <<https://txtbba.tamu.edu>>. Accessed November 4, 2021.
- Bolt, A. 2020. Texas A&M-Galveston awarded sea turtle grant - money from Texas Parks and Wildlife will help researchers better understand sea turtle populations, movements and habitat and other key data. Texas A&M Today. <<https://today.tamu.edu/2020/02/07/texas-am-galveston-awarded-sea-turtle-grant/>>. Accessed November 6, 2021.
- Buehler, D., R. Oestman, J. Reyff, K. Pommerench, and B. Mitchell. 2015. Technical guidance for assessment and mitigation of the hydroacoustic effects of pile driving on fish. Report No. CTHWANP-RT-15-306.01.01. California Department of Transportation, Division of Environmental Analysis. Hazardous Waste, Air, Noise, Paleontology Office, Sacramento, California, USA.
- Convention on Biological Diversity [CBD]. 2014. Marine Mammal Hearing and Sensitivity to Acoustic Impacts. <<https://www.cbd.int/doc/meetings/mar/mcbem-2014-01/other/mcbem-2014-01-submission-boem-02-en.pdf>>. Accessed January 4, 2022.
- Dunton, K., Pulich, W., and T. Mutchler. 2011. A seagrass monitoring program for Texas coastal waters: multiscale integration of landscape features with plant and water quality indicators. Prepared for Coastal Bend Bays & Estuaries Program, Corpus Christi, Texas, USA.
- eBird, 2020. eBird: An online database of bird distribution and abundance. Cornell Lab of Ornithology, Ithaca, New York, USA. <<http://www.ebird.org>>. Accessed November 6, 2021.
- Environmental Institute of Houston [EIH]. 2015. Distribution, Abundance, and Habitat Use of the Saltmarsh Topminnow (*Fundulus jenkinsi*). Prepared in cooperation with the Texas Parks and Wildlife Department. EIH, University of Houston - Clear Lake, Houston, Texas, USA. <<https://www.uhcl.edu/environmental-institute/research/publications/documents/15-002saltmarshtopminnowreport.pdf>>. Accessed November 6, 2021.
- Environmental Protection Agency [EPA]. 2010. Administrative Settlement Agreement and Order on Consent for Removal Action. U.S. Environmental Protection Agency Region 6 CERCLA Docket No. 06-12-10. In the matter of: San Jacinto River Waste Pits Superfund Site Pasadena, Harris County, Texas. International Paper Company and McGinnes Industrial Management Corporation, Respondents.
- Environmental Protection Agency [EPA]. 2017. Record of Decision, San Jacinto River Waste Pits. Harris County, Texas. EPA ID: TXN000606611. U.S. Environmental Protection Agency, Region 6. Dallas, Texas, USA.
- Fisheries Hydroacoustic Working Group. 2008. Agreement in principle for interim criteria for injury to fish from pile driving activities. NOAA Fisheries Northwest and Southwest Regions, U.S. Fish and Wildlife Service Regions 1 & 8, California/Washington/Oregon Departments of Transportation, California Department of Fish and Game, and the U.S. Federal Highway Administration.
- Fishes of Texas. 2020. Saltmarsh Topminnow *Fundulus jenkinsi*, collector William Aufferberg, collected 1953. Fishes of Texas, a virtual museum on the state's fish biodiversity, Ichthyology Collection at The University of Texas at Austin, Austin, Texas, USA. <<http://www.fishesoftexas.org/specimen/UF1527>>. Accessed November 6, 2021.
- Florida Fish and Wildlife Conservation Commission [FWC]. 2011. Standard manatee conditions for in-water work. <https://myfwc.com/media/7246/manatee_stdcondin_waterwork.pdf>. Accessed January 4, 2022.
- Galveston Bay Status and Trends. 2017a. Oyster reefs in Galveston Bay. <<https://www.galvbaydata.org/www.galvbaydata.org/Habitat/OysterReefs/tabid/836/Default.html>>. Accessed 4 January 2022.

- Galveston Bay Status and Trends. 2017b. Seagrass in Galveston Bay. <<https://www.galvbaydata.org/www.galvbaydata.org/Habitat/Seagrass/tabid/732/Default.html>>. Accessed 4 January 2022.
- Gonzales, J.R. 2019. In 1995, a manatee made its way up Buffalo Bayou. Houstonians were enthralled. CHRON.com. <<https://www.chron.com/local/bayou-city-history/article/1995-manatee-made-its-way-up-Buffalo-Bayou-14280276.php>>. Accessed November 6, 2021.
- Hastings, M. C. and A. N. Popper. 2005. Effects of sound on fish (No. CA05-0537). Jones & Stokes, Sacramento, California, USA.
- iNaturalist, 2020. Observations. iNaturalist Department, California Academy of Sciences and National Geographic Society, San Francisco, California, USA. <<https://www.inaturalist.org>>. Accessed November 6, 2021.
- Lopez, J. D., M. S. Peterson, J. Walker, G. L. Grammer, and M. S. Woodrey. 2011. Distribution, abundance, and habitat characterization of the saltmarsh topminnow, *Fundulus jenkinsi* (Everman, 1892). *Estuaries and Coasts* 34:148-158.
- National Marine Fisheries Service [NMFS]. 2012. Guidance Document: Sound propagation modeling to characterize pile driving sounds relevant to marine mammals. National Oceanic and Atmospheric Administration, National Marine Fisheries Service, Northwest Region, Seattle, Washington, USA.
- National Marine Fisheries Service [NMFS]. 2018a. 2018 Revision to: Technical Guidance for Assessing the Effects of Anthropogenic Sound on Marine Mammal Hearing (Version 2.0). Underwater thresholds for onset of permanent and temporary threshold shifts. National Marine Fisheries Service, Office of Protect Resources, Silver Spring, Maryland, USA.
- National Marine Fisheries Service [NMFS]. 2020. User Spreadsheet. Version 2.2. Companion to National Marine Fisheries Service: 2018 Revision to: Technical Guidance for Assessing the Effects of Anthropogenic Noise on Marine Mammal Hearing: Underwater Thresholds for Onset of Permanent and Temporary Threshold Shifts (Version 2.2).
- National Oceanic and Atmospheric Administration [NOAA]. 2016. Ocean noise strategy roadmap. <https://cetsound.noaa.gov/Assets/cetsound/documents/Roadmap/ONS_Roadmap_Final_Complete.pdf>. Accessed January 4, 2022.
- National Oceanic and Atmospheric Administration [NOAA] Fisheries. 1998. Generic Amendment Number 3 for Addressing Essential Fish Habitat Requirements, Habitat Areas of Particular Concern, and Adverse Effects of Fishing in the following Fishery Management Plans of the Gulf of Mexico: Shrimp Fishery of the Gulf of Mexico, United States Waters; Red Drum Fishery of the Gulf of Mexico; Reef Fish Fishery of the Gulf of Mexico; Coastal Migratory Pelagic Resources (Mackerels) in the Gulf of Mexico and South Atlantic; Stone Crab Fishery of the Gulf of Mexico; Spiny Lobster in the Gulf of Mexico and South Atlantic; Coral and Coral Reefs of the Gulf of Mexico. Gulf of Mexico Fishery Management Council, Tampa, Florida, USA.
- National Oceanic and Atmospheric Administration [NOAA] Fisheries. 2005. Generic Amendment for Addressing Essential Fish Habitat Requirements in the following Fishery Management Plans of the Gulf of Mexico: Shrimp Fishery of the Gulf of Mexico, United States Waters; Red Drum Fishery of the Gulf of Mexico; Reef Fish Fishery of the Gulf of Mexico; Coastal Migratory Pelagic Resources (Mackerels) in the Gulf of Mexico and South Atlantic; Stone Crab Fishery of the Gulf of Mexico; Spiny Lobster in the Gulf of Mexico and South Atlantic; Coral and Coral Reefs of the Gulf of Mexico. Gulf of Mexico Fishery Management Council, Tampa, Florida, USA.
- National Oceanic and Atmospheric Administration [NOAA] Fisheries. 2017. Amendment 10 to the 2006 Consolidated Atlantic Highly Migratory Species Fishery Management Plan: Essential Fish Habitat. NOAA Fisheries, Office of Sustainable Fisheries Atlantic Highly Migratory Species Management Division, Silver Spring, Maryland, USA.
- National Oceanic and Atmospheric Administration [NOAA] Fisheries. 2019. ESA Section 7 consultation tools for marine mammals on the West Coast. <<https://www.fisheries.noaa.gov/west-coast/endangered-species-conservation/esa-section-7-consultation-tools-marine-mammals-west>>. Accessed January 4, 2022.

- National Oceanic and Atmospheric Administration [NOAA] Fisheries. 2020. Threatened and Endangered Species and Critical Habitats Under NOAA Fisheries Jurisdiction - Gulf of Mexico. <<https://www.fisheries.noaa.gov/southeast/consultations/gulf-mexico>>. Accessed November 4, 2021.
- NatureServe, 2021. NatureServe Explorer: An online encyclopedia of life [web application]. Version 7.1. NatureServe, Arlington, Virginia, USA. <<http://explorer.natureserve.org>>. Accessed January 4, 2022.
- Paille, R. 2019. Looking for the saltmarsh topminnow in coastal Louisiana. USFWS, Southeast Region, Atlanta, Georgia, USA. <<https://www.fws.gov/southeast/articles/looking-for-the-saltmarsh-topminnow-in-coastal-louisiana>>. Accessed November 6, 2021.
- Robertson, J. J. 2016. Distribution, habitat, and life history characteristics of the saltmarsh topminnow (*Fundulus jenkinsi*). Master's Thesis, University of Houston-Clear Lake, Houston, Texas, USA. <<https://www.uhcl.edu/environmental-institute/research/publications/documents/robertson-2016-ms-thesis.pdf>>. Accessed November 6, 2021.
- Texas Natural Diversity Database [TXNDDDB]. 2022. Element Occurrence data export. Wildlife Diversity Program of Texas Parks & Wildlife Department. Texas Parks & Wildlife Department, Austin, Texas, USA.
- Texas Tech University. 2020. West Indian manatee *Trichechus manatus* Linnaeus 1758 in The Mammals of Texas, Seventh Edition by David J. Schmidly and Robert D. Bradley, 3rd edition. Texas Tech University, Natural Science Research Laboratory, Lubbock, Texas, USA. <https://www.depts.ttu.edu/nsrl/mammals-of-texas-online-edition/Accounts_Sirenia/Trichechus_manatus.php#:~:text=Records%20from%20Texas%20probably%20represent,exploited%20as%20a%20food%20source.&text=Manatees%20consume%2030%E2%80%9350%20kg,they%20feed%20on%20sea%20grasses>. Accessed November 6, 2021.
- U.S. Fish and Wildlife Service [USFWS]. 1999. South Florida multi-species recovery plan. USFWS, Southeast Region, Atlanta, Georgia, USA.
- U.S. Fish and Wildlife Service [USFWS]. 2001. Florida manatee recovery plan, (*Trichechus manatus latirostris*), Third Revision. U.S. Fish and Wildlife Service. Atlanta, Georgia, USA.
- U.S. Fish and Wildlife Service [USFWS]. 2007. West Indian manatee (*Trichechus manatus*) 5-year review: summary and evaluation. USFWS, Southeast Region, Jacksonville Ecological Services Office, Jacksonville, Florida, USA.
- U.S. Fish and Wildlife Service [USFWS]. 2014. West Indian manatee (*Trichechus manatus*) Florida stock (Florida subspecies, *Trichechus manatus latirostris*), stock assessment report. USFWS, Jacksonville, Florida, USA.
- U.S. Fish and Wildlife Service [USFWS]. 2019a. Addendum to 2013 Manatee Effects Determination Dichotomous Key. <https://www.fws.gov/verobeach/MammalsPDFs/20190513_letter_ServicetoCorps_ManateeKeyaddendum.pdf>. Accessed January 4, 2022.
- U.S. Fish and Wildlife Service [USFWS]. 2019b. West Indian manatee *Trichechus manatus*. <<https://www.fws.gov/southeast/wildlife/mammals/manatee/#:~:text=Today%2C%20the%20range%2Dwide%20population,estimated%201%2C267%20manatees%20in%20Florida>>. Accessed November 6, 2021.
- U.S. Fish and Wildlife Service [USFWS]. 2020. Information for Planning and Consultation (IPaC) Tool. <<https://ecos.fws.gov/ipac/>>. Accessed November 4, 2021.
- WildEarth Guardians and S. Felsen. 2010. Petition to list the saltmarsh topminnow (*Fundulus jenkinsi*) under the U.S. Endangered Species Act. WildEarth Guardians, Santa Fe, New Mexico, USA.

Appendices

Appendix A

Figures



Legend
 Northern Impoundment

Site

Site

Harris County
Texas

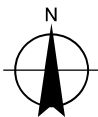
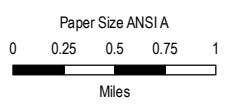

**SAN JACINTO RIVER WASTE PITS
 HARRIS COUNTY, TEXAS
 THREATENED & ENDANGERED SPECIES
 HABITAT SUITABILITY ASSESSMENT
 NORTHERN IMPOUNDMENT**

Project No. 11215702
 Date May 17, 2022

Map Projection: Lambert Conformal Conic
 Horizontal Datum: North American 1983
 Grid: NAD 1983 StatePlane Texas South Central FIPS 4204 Feet

SITE VICINITY MAP

FIGURE 1

G:\GIS\PROJECTS\11215000a\11215702\Threatened & Endangered Species Habitat Suitability (Northern)\11215702_202205_T&ESHA(Northern)_GIS001.mxd

Data source: Sources: Esri, HERE, Garmin, Intermap, increment P Corp., GEBCO, USGS, FAO, NPS, NRCAN, GeoBase, IGN, Kadaster NL, Ordnance Survey, Esri Japan, METI, Esri China (Hong Kong), (c) OpenStreetMap contributors, and the GIS User Community.

Legend
Northern Impoundment

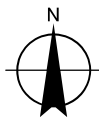
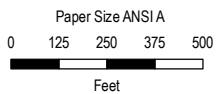

**SAN JACINTO RIVER WASTE PITS
HARRIS COUNTY, TEXAS
THREATENED & ENDANGERED SPECIES
HABITAT SUITABILITY ASSESSMENT
NORTHERN IMPOUNDMENT**

Project No. 11215702
Date Oct 27, 2022

Map Projection: Lambert Conformal Conic
Horizontal Datum: North American 1983
Grid: NAD 1983 StatePlane Texas South Central FIPS 4204 Feet

PROJECT AREA

FIGURE 2

Appendix B

USFWS & NMFS Species Lists



Gulf of Mexico

Threatened and Endangered Species and Critical Habitats Under NOAA Fisheries Jurisdiction

Species	Listing Status	Recovery Plan	Critical Habitat
Green sea turtle	Threatened - North and South Atlantic Distinct Population Segment (81 FR 20057 ; April 6, 2016)	October 1991	63 FR 46693 ; September 2, 1998
Kemp's ridley sea turtle	Endangered (35 FR 18319 ; December 2, 1970)	September 2011	None
Leatherback sea turtle	Endangered (35 FR 8491 ; June 2, 1970)	April 1992	44 FR 17710 ; March 23, 1979
Loggerhead sea turtle	Threatened - Northwest Atlantic Ocean Distinct Population Segment (76 FR 58868 ; September 22, 2011)	December 2008	79 FR 39856 ; July 10, 2014
Hawksbill sea turtle	Endangered (35 FR 8491 ; June 2, 1970)	December 1993	63 FR 46693 ; September 2, 1998
Smalltooth sawfish	U.S. Distinct Population Segment Endangered (68 FR 15674 ; April 1, 2003)	January 2009	72 FR 45353 ; October 2, 2009
Gulf sturgeon	Threatened (56 FR 49653 ; September 30, 1991)	September 1995	68 FR 13370 ; March 19, 2003
Nassau grouper	Threatened (81 FR 42268 ; June 29, 2016)	2018 Recovery Outline	None

Species	Listing Status	Recovery Plan	Critical Habitat
Oceanic whitetip shark	Threatened (83 FR 4153; January 30, 2018)	2018 Recovery Outline	None
Giant manta ray	Threatened (83 FR 2916; January 22, 2018)	December 2019	None
Elkhorn coral	Threatened (71 FR 26852; May 9, 2006)	March 2015	73 FR 72210; November 26, 2008
Staghorn coral	Threatened (71 FR 26852; May 9, 2006)	March 2015	73 FR 72210; November 26, 2008
Boulder star coral	Threatened (79 FR 53851; September 10, 2014)	None	None
Mountainous star coral	Threatened (79 FR 53851; September 10, 2014)	None	None
Lobed star coral	Threatened (79 FR 53851; September 10, 2014)	None	None
Rough cactus coral	Threatened (79 FR 53851; September 10, 2014)	None	None
Pillar coral	Threatened (79 FR 53851; September 10, 2014)	None	None
Sperm whale	Endangered (35 FR 18319; December 2, 1970)	December 2010	None
Rice's whale	Endangered (84 FR 15446, April 15, 2019); Name Change (86 FR 47022; August 23, 2021)	September 2020 Recovery Outline	None

Last updated by [Southeast Regional Office](#) on December 27, 2021



United States Department of the Interior



FISH AND WILDLIFE SERVICE
Texas Coastal Ecological Services Field Office
4444 Corona Drive, Suite 215
Corpus Christi, TX 78411
Phone: (281) 286-8282 Fax: (281) 488-5882
<http://www.fws.gov/southwest/es/TexasCoastal/>
http://www.fws.gov/southwest/es/ES_Lists_Main2.html

In Reply Refer To:
Project Code: 2022-0042923
Project Name: San Jac Waste Pits Habitat Assessment

May 16, 2022

Subject: List of threatened and endangered species that may occur in your proposed project location or may be affected by your proposed project

To Whom It May Concern:

The U.S. Fish and Wildlife Service (Service) field offices in Clear Lake, Tx, and Corpus Christi, Tx, have combined administratively to form the Texas Coastal Ecological Services Field Office. A map of the Texas Coastal Ecological Services Field Office area of responsibility can be found at: <http://www.fws.gov/southwest/es/TexasCoastal/Map.html>. All project related correspondence should be sent to the field office responsible for the area in which your project occurs. For projects located in southeast Texas please write to: Field Supervisor; U.S. Fish and Wildlife Service; 17629 El Camino Real Ste. 211; Houston, Texas 77058. For projects located in southern Texas please write to: Field Supervisor; U.S. Fish and Wildlife Service; P.O. Box 81468; Corpus Christi, Texas 78468-1468. For projects located in six counties in southern Texas (Cameron, Hidalgo, Starr, Webb, Willacy, and Zapata) please write: Santa Ana NWR, ATTN: Ecological Services Sub Office, 3325 Green Jay Road, Alamo, Texas 78516.

The enclosed species list identifies threatened, endangered, proposed and candidate species, as well as proposed and final designated critical habitat, that may occur within the boundary of your proposed project and/or may be affected by your proposed project. The species list fulfills the requirements of the U.S. Fish and Wildlife Service (Service) under section 7(c) of the Endangered Species Act (Act) of 1973, as amended (16 U.S.C. 1531 *et seq.*).

New information based on updated surveys, changes in the abundance and distribution of species, changed habitat conditions, or other factors could change this list. Please feel free to contact us if you need more current information or assistance regarding the potential impacts to federally proposed, listed, and candidate species and federally designated and proposed critical habitat. Please note that under 50 CFR 402.12(e) of the regulations implementing section 7 of the Act, the accuracy of this species list should be verified after 90 days. This verification can be

completed formally or informally as desired. The Service recommends that verification be completed by visiting the ECOS-IPaC website at regular intervals during project planning and implementation for updates to species lists and information. An updated list may be requested through the ECOS-IPaC system by completing the same process used to receive the enclosed list.

The purpose of the Act is to provide a means whereby threatened and endangered species and the ecosystems upon which they depend may be conserved. Under sections 7(a)(1) and 7(a)(2) of the Act and its implementing regulations (50 CFR 402 *et seq.*), Federal agencies are required to utilize their authorities to carry out programs for the conservation of threatened and endangered species and to determine whether projects may affect threatened and endangered species and/or designated critical habitat.

A Biological Assessment is required for construction projects (or other undertakings having similar physical impacts) that are major Federal actions significantly affecting the quality of the human environment as defined in the National Environmental Policy Act (42 U.S.C. 4332(2) (c)). For projects other than major construction activities, the Service suggests that a biological evaluation similar to a Biological Assessment be prepared to determine whether the project may affect listed or proposed species and/or designated or proposed critical habitat. Recommended contents of a Biological Assessment are described at 50 CFR 402.12.

If a Federal agency determines, based on the Biological Assessment or biological evaluation, that listed species and/or designated critical habitat may be affected by the proposed project, the agency is required to consult with the Service pursuant to 50 CFR 402. In addition, the Service recommends that candidate species, proposed species and proposed critical habitat be addressed within the consultation. More information on the regulations and procedures for section 7 consultation, including the role of permit or license applicants, can be found in the "Endangered Species Consultation Handbook" at:

<http://www.fws.gov/endangered/esa-library/pdf/TOC-GLOS.PDF>

Migratory Birds: In addition to responsibilities to protect threatened and endangered species under the Endangered Species Act (ESA), there are additional responsibilities under the Migratory Bird Treaty Act (MBTA) and the Bald and Golden Eagle Protection Act (BGEPA) to protect native birds from project-related impacts. Any activity, intentional or unintentional, resulting in take of migratory birds, including eagles, is prohibited unless otherwise permitted by the U.S. Fish and Wildlife Service (50 C.F.R. Sec. 10.12 and 16 U.S.C. Sec. 668(a)). For more information regarding these Acts see <https://www.fws.gov/birds/policies-and-regulations.php>.

The MBTA has no provision for allowing take of migratory birds that may be unintentionally killed or injured by otherwise lawful activities. It is the responsibility of the project proponent to comply with these Acts by identifying potential impacts to migratory birds and eagles within applicable NEPA documents (when there is a federal nexus) or a Bird/Eagle Conservation Plan (when there is no federal nexus). Proponents should implement conservation measures to avoid or minimize the production of project-related stressors or minimize the exposure of birds and their resources to the project-related stressors. For more information on avian stressors and recommended conservation measures see <https://www.fws.gov/birds/bird-enthusiasts/threats-to-birds.php>.

In addition to MBTA and BGEPA, Executive Order 13186: *Responsibilities of Federal Agencies to Protect Migratory Birds*, obligates all Federal agencies that engage in or authorize activities that might affect migratory birds, to minimize those effects and encourage conservation measures that will improve bird populations. Executive Order 13186 provides for the protection of both migratory birds and migratory bird habitat. For information regarding the implementation of Executive Order 13186, please visit <https://www.fws.gov/birds/policies-and-regulations/executive-orders/e0-13186.php>.

We appreciate your concern for threatened and endangered species. The Service encourages Federal agencies to include conservation of threatened and endangered species into their project planning to further the purposes of the Act. Please include the Consultation Code in the header of this letter with any request for consultation or correspondence about your project that you submit to our office.

Attachment(s):

- Official Species List
 - Migratory Birds
 - Marine Mammals
 - Wetlands
-

Official Species List

This list is provided pursuant to Section 7 of the Endangered Species Act, and fulfills the requirement for Federal agencies to "request of the Secretary of the Interior information whether any species which is listed or proposed to be listed may be present in the area of a proposed action".

This species list is provided by:

Texas Coastal Ecological Services Field Office

4444 Corona Drive, Suite 215

Corpus Christi, TX 78411

(281) 286-8282

Project Summary

Project Code: 2022-0042923

Event Code: None

Project Name: San Jac Waste Pits Habitat Assessment

Project Type: Land Preservation

Project Description: Habitat Assessment

Project Location:

Approximate location of the project can be viewed in Google Maps: <https://www.google.com/maps/@29.79310205,-95.06601068148218,14z>

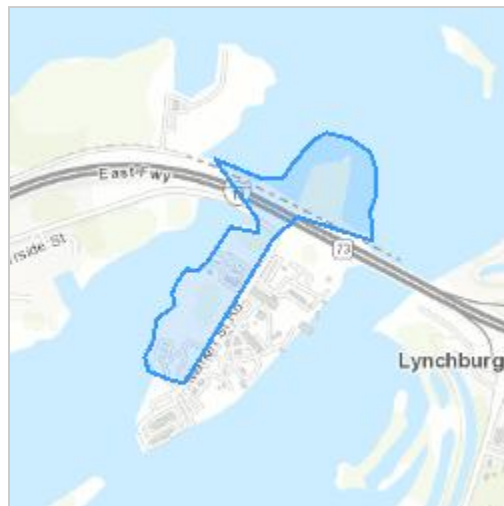

Counties: Harris County, Texas

Endangered Species Act Species

There is a total of 7 threatened, endangered, or candidate species on this species list.

Species on this list should be considered in an effects analysis for your project and could include species that exist in another geographic area. For example, certain fish may appear on the species list because a project could affect downstream species. Note that 2 of these species should be considered only under certain conditions.

IPaC does not display listed species or critical habitats under the sole jurisdiction of NOAA Fisheries¹, as USFWS does not have the authority to speak on behalf of NOAA and the Department of Commerce.

See the "Critical habitats" section below for those critical habitats that lie wholly or partially within your project area under this office's jurisdiction. Please contact the designated FWS office if you have questions.

-
1. [NOAA Fisheries](#), also known as the National Marine Fisheries Service (NMFS), is an office of the National Oceanic and Atmospheric Administration within the Department of Commerce.

Mammals

NAME	STATUS
West Indian Manatee <i>Trichechus manatus</i>	Threatened
<p>There is final critical habitat for this species. The location of the critical habitat is not available. <i>This species is also protected by the Marine Mammal Protection Act, and may have additional consultation requirements.</i> Species profile: https://ecos.fws.gov/ecp/species/4469</p>	

Birds

NAME	STATUS
Eastern Black Rail <i>Laterallus jamaicensis ssp. jamaicensis</i> No critical habitat has been designated for this species. Species profile: https://ecos.fws.gov/ecp/species/10477	Threatened
Piping Plover <i>Charadrius melodus</i> Population: [Atlantic Coast and Northern Great Plains populations] - Wherever found, except those areas where listed as endangered. There is final critical habitat for this species. The location of the critical habitat is not available. This species only needs to be considered under the following conditions: <ul style="list-style-type: none"> ▪ Wind related projects within migratory route. Species profile: https://ecos.fws.gov/ecp/species/6039	Threatened
Red Knot <i>Calidris canutus rufa</i> There is proposed critical habitat for this species. The location of the critical habitat is not available. This species only needs to be considered under the following conditions: <ul style="list-style-type: none"> ▪ Wind related projects within migratory route. Species profile: https://ecos.fws.gov/ecp/species/1864	Threatened
Whooping Crane <i>Grus americana</i> Population: Wherever found, except where listed as an experimental population There is final critical habitat for this species. The location of the critical habitat is not available. Species profile: https://ecos.fws.gov/ecp/species/758	Endangered

Insects

NAME	STATUS
Monarch Butterfly <i>Danaus plexippus</i> No critical habitat has been designated for this species. Species profile: https://ecos.fws.gov/ecp/species/9743	Candidate

Flowering Plants

NAME	STATUS
Texas Prairie Dawn-flower <i>Hymenoxys texana</i> No critical habitat has been designated for this species. Species profile: https://ecos.fws.gov/ecp/species/6471	Endangered

Critical habitats

THERE ARE NO CRITICAL HABITATS WITHIN YOUR PROJECT AREA UNDER THIS OFFICE'S JURISDICTION.

Migratory Birds

Certain birds are protected under the Migratory Bird Treaty Act¹ and the Bald and Golden Eagle Protection Act².

Any person or organization who plans or conducts activities that may result in impacts to migratory birds, eagles, and their habitats should follow appropriate regulations and consider implementing appropriate conservation measures, as described [below](#).

-
1. The [Migratory Birds Treaty Act](#) of 1918.
 2. The [Bald and Golden Eagle Protection Act](#) of 1940.
 3. 50 C.F.R. Sec. 10.12 and 16 U.S.C. Sec. 668(a)

The birds listed below are birds of particular concern either because they occur on the [USFWS Birds of Conservation Concern \(BCC\) list](#) or warrant special attention in your project location. To learn more about the levels of concern for birds on your list and how this list is generated, see the FAQ [below](#). This is not a list of every bird you may find in this location, nor a guarantee that every bird on this list will be found in your project area. To see exact locations of where birders and the general public have sighted birds in and around your project area, visit the [E-bird data mapping tool](#) (Tip: enter your location, desired date range and a species on your list). For projects that occur off the Atlantic Coast, additional maps and models detailing the relative occurrence and abundance of bird species on your list are available. Links to additional information about Atlantic Coast birds, and other important information about your migratory bird list, including how to properly interpret and use your migratory bird report, can be found [below](#).

For guidance on when to schedule activities or implement avoidance and minimization measures to reduce impacts to migratory birds on your list, click on the PROBABILITY OF PRESENCE SUMMARY at the top of your list to see when these birds are most likely to be present and breeding in your project area.

NAME	BREEDING SEASON
American Golden-plover <i>Pluvialis dominica</i> This is a Bird of Conservation Concern (BCC) throughout its range in the continental USA and Alaska.	Breeds elsewhere
American Oystercatcher <i>Haematopus palliatus</i> This is a Bird of Conservation Concern (BCC) throughout its range in the continental USA and Alaska. https://ecos.fws.gov/ecp/species/8935	Breeds Apr 15 to Aug 31

NAME	BREEDING SEASON
<p>Bald Eagle <i>Haliaeetus leucocephalus</i> This is not a Bird of Conservation Concern (BCC) in this area, but warrants attention because of the Eagle Act or for potential susceptibilities in offshore areas from certain types of development or activities. https://ecos.fws.gov/ecp/species/1626</p>	Breeds Sep 1 to Jul 31
<p>Black Skimmer <i>Rynchops niger</i> This is a Bird of Conservation Concern (BCC) throughout its range in the continental USA and Alaska. https://ecos.fws.gov/ecp/species/5234</p>	Breeds May 20 to Sep 15
<p>Gull-billed Tern <i>Gelochelidon nilotica</i> This is a Bird of Conservation Concern (BCC) throughout its range in the continental USA and Alaska. https://ecos.fws.gov/ecp/species/9501</p>	Breeds May 1 to Jul 31
<p>Hudsonian Godwit <i>Limosa haemastica</i> This is a Bird of Conservation Concern (BCC) throughout its range in the continental USA and Alaska.</p>	Breeds elsewhere
<p>King Rail <i>Rallus elegans</i> This is a Bird of Conservation Concern (BCC) throughout its range in the continental USA and Alaska. https://ecos.fws.gov/ecp/species/8936</p>	Breeds May 1 to Sep 5
<p>Lesser Yellowlegs <i>Tringa flavipes</i> This is a Bird of Conservation Concern (BCC) throughout its range in the continental USA and Alaska. https://ecos.fws.gov/ecp/species/9679</p>	Breeds elsewhere
<p>Long-billed Curlew <i>Numenius americanus</i> This is a Bird of Conservation Concern (BCC) only in particular Bird Conservation Regions (BCRs) in the continental USA https://ecos.fws.gov/ecp/species/5511</p>	Breeds elsewhere
<p>Prothonotary Warbler <i>Protonotaria citrea</i> This is a Bird of Conservation Concern (BCC) throughout its range in the continental USA and Alaska.</p>	Breeds Apr 1 to Jul 31
<p>Red-headed Woodpecker <i>Melanerpes erythrocephalus</i> This is a Bird of Conservation Concern (BCC) throughout its range in the continental USA and Alaska.</p>	Breeds May 10 to Sep 10
<p>Reddish Egret <i>Egretta rufescens</i> This is a Bird of Conservation Concern (BCC) throughout its range in the continental USA and Alaska. https://ecos.fws.gov/ecp/species/7617</p>	Breeds Mar 1 to Sep 15
<p>Ruddy Turnstone <i>Arenaria interpres morinella</i> This is a Bird of Conservation Concern (BCC) only in particular Bird Conservation Regions (BCRs) in the continental USA</p>	Breeds elsewhere

NAME	BREEDING SEASON
Sprague's Pipit <i>Anthus spragueii</i> This is a Bird of Conservation Concern (BCC) throughout its range in the continental USA and Alaska. https://ecos.fws.gov/ecp/species/8964	Breeds elsewhere
Swallow-tailed Kite <i>Elanoides forficatus</i> This is a Bird of Conservation Concern (BCC) throughout its range in the continental USA and Alaska. https://ecos.fws.gov/ecp/species/8938	Breeds Mar 10 to Jun 30
Willet <i>Tringa semipalmata</i> This is a Bird of Conservation Concern (BCC) throughout its range in the continental USA and Alaska.	Breeds Apr 20 to Aug 5

Probability Of Presence Summary

The graphs below provide our best understanding of when birds of concern are most likely to be present in your project area. This information can be used to tailor and schedule your project activities to avoid or minimize impacts to birds. Please make sure you read and understand the FAQ "Proper Interpretation and Use of Your Migratory Bird Report" before using or attempting to interpret this report.

Probability of Presence (■)

Each green bar represents the bird's relative probability of presence in the 10km grid cell(s) your project overlaps during a particular week of the year. (A year is represented as 12 4-week months.) A taller bar indicates a higher probability of species presence. The survey effort (see below) can be used to establish a level of confidence in the presence score. One can have higher confidence in the presence score if the corresponding survey effort is also high.

How is the probability of presence score calculated? The calculation is done in three steps:

1. The probability of presence for each week is calculated as the number of survey events in the week where the species was detected divided by the total number of survey events for that week. For example, if in week 12 there were 20 survey events and the Spotted Towhee was found in 5 of them, the probability of presence of the Spotted Towhee in week 12 is 0.25.
2. To properly present the pattern of presence across the year, the relative probability of presence is calculated. This is the probability of presence divided by the maximum probability of presence across all weeks. For example, imagine the probability of presence in week 20 for the Spotted Towhee is 0.05, and that the probability of presence at week 12 (0.25) is the maximum of any week of the year. The relative probability of presence on week 12 is $0.25/0.25 = 1$; at week 20 it is $0.05/0.25 = 0.2$.
3. The relative probability of presence calculated in the previous step undergoes a statistical conversion so that all possible values fall between 0 and 10, inclusive. This is the probability of presence score.

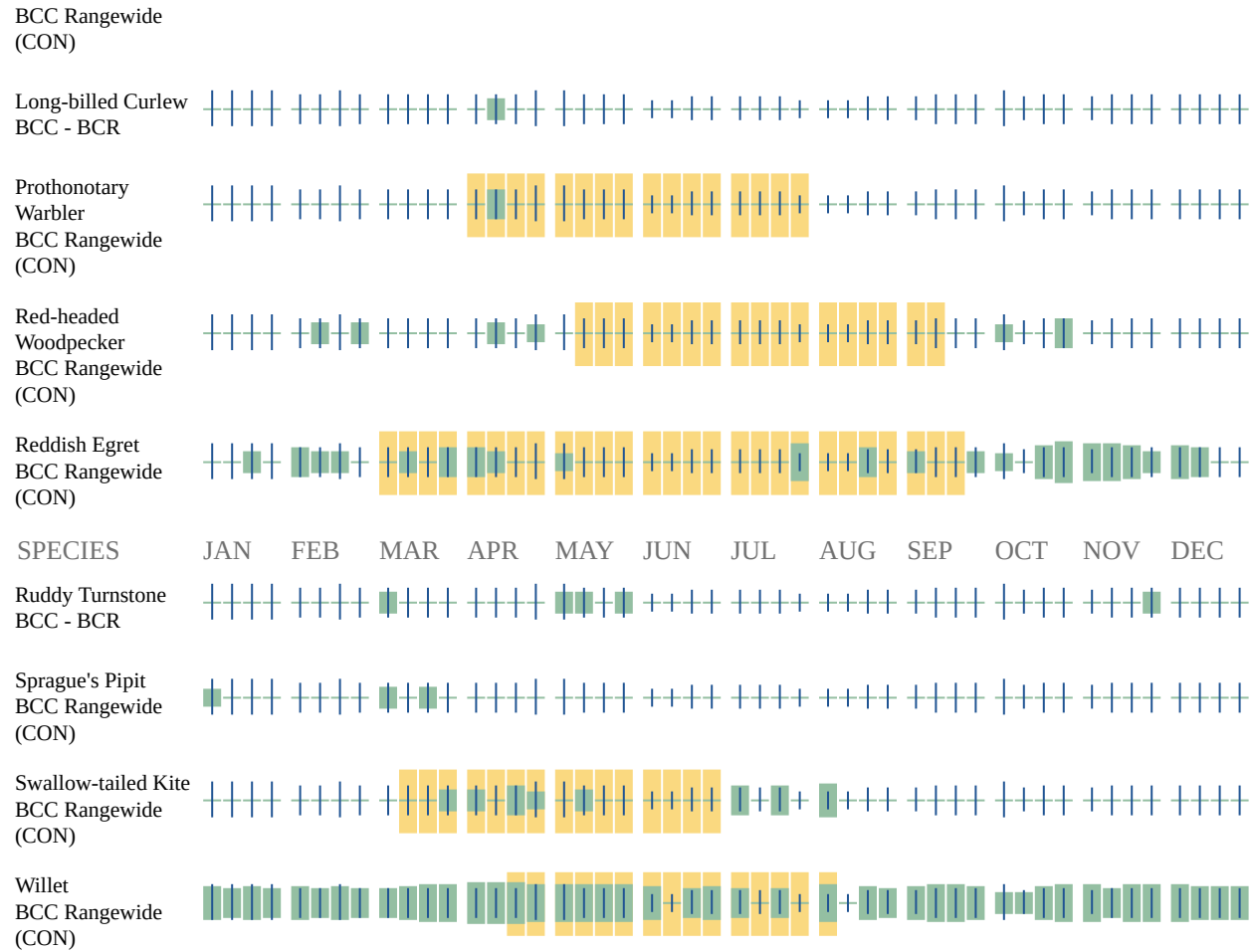

Additional information can be found using the following links:

- Birds of Conservation Concern <https://www.fws.gov/program/migratory-birds/species>
- Measures for avoiding and minimizing impacts to birds <https://www.fws.gov/library/collections/avoiding-and-minimizing-incident-take-migratory-birds>
- Nationwide conservation measures for birds <https://www.fws.gov/sites/default/files/documents/nationwide-standard-conservation-measures.pdf>

Migratory Birds FAQ

Tell me more about conservation measures I can implement to avoid or minimize impacts to migratory birds.

[Nationwide Conservation Measures](#) describes measures that can help avoid and minimize impacts to all birds at any location year round. Implementation of these measures is particularly important when birds are most likely to occur in the project area. When birds may be breeding in the area, identifying the locations of any active nests and avoiding their destruction is a very helpful impact minimization measure. To see when birds are most likely to occur and be breeding in your project area, view the Probability of Presence Summary. [Additional measures](#) or [permits](#)

may be advisable depending on the type of activity you are conducting and the type of infrastructure or bird species present on your project site.

What does IPaC use to generate the migratory birds potentially occurring in my specified location?

The Migratory Bird Resource List is comprised of USFWS [Birds of Conservation Concern \(BCC\)](#) and other species that may warrant special attention in your project location.

The migratory bird list generated for your project is derived from data provided by the [Avian Knowledge Network \(AKN\)](#). The AKN data is based on a growing collection of [survey, banding, and citizen science datasets](#) and is queried and filtered to return a list of those birds reported as occurring in the 10km grid cell(s) which your project intersects, and that have been identified as warranting special attention because they are a BCC species in that area, an eagle ([Eagle Act](#) requirements may apply), or a species that has a particular vulnerability to offshore activities or development.

Again, the Migratory Bird Resource list includes only a subset of birds that may occur in your project area. It is not representative of all birds that may occur in your project area. To get a list of all birds potentially present in your project area, please visit the [AKN Phenology Tool](#).

What does IPaC use to generate the probability of presence graphs for the migratory birds potentially occurring in my specified location?

The probability of presence graphs associated with your migratory bird list are based on data provided by the [Avian Knowledge Network \(AKN\)](#). This data is derived from a growing collection of [survey, banding, and citizen science datasets](#).

Probability of presence data is continuously being updated as new and better information becomes available. To learn more about how the probability of presence graphs are produced and how to interpret them, go to the Probability of Presence Summary and then click on the "Tell me about these graphs" link.

How do I know if a bird is breeding, wintering, migrating or present year-round in my project area?

To see what part of a particular bird's range your project area falls within (i.e. breeding, wintering, migrating or year-round), you may refer to the following resources: [The Cornell Lab of Ornithology All About Birds Bird Guide](#), or (if you are unsuccessful in locating the bird of interest there), the [Cornell Lab of Ornithology Neotropical Birds guide](#). If a bird on your migratory bird species list has a breeding season associated with it, if that bird does occur in your project area, there may be nests present at some point within the timeframe specified. If "Breeds elsewhere" is indicated, then the bird likely does not breed in your project area.

What are the levels of concern for migratory birds?

Migratory birds delivered through IPaC fall into the following distinct categories of concern:

1. "BCC Rangewide" birds are [Birds of Conservation Concern](#) (BCC) that are of concern throughout their range anywhere within the USA (including Hawaii, the Pacific Islands, Puerto Rico, and the Virgin Islands);
-

2. "BCC - BCR" birds are BCCs that are of concern only in particular Bird Conservation Regions (BCRs) in the continental USA; and
3. "Non-BCC - Vulnerable" birds are not BCC species in your project area, but appear on your list either because of the [Eagle Act](#) requirements (for eagles) or (for non-eagles) potential susceptibilities in offshore areas from certain types of development or activities (e.g. offshore energy development or longline fishing).

Although it is important to try to avoid and minimize impacts to all birds, efforts should be made, in particular, to avoid and minimize impacts to the birds on this list, especially eagles and BCC species of rangewide concern. For more information on conservation measures you can implement to help avoid and minimize migratory bird impacts and requirements for eagles, please see the FAQs for these topics.

Details about birds that are potentially affected by offshore projects

For additional details about the relative occurrence and abundance of both individual bird species and groups of bird species within your project area off the Atlantic Coast, please visit the [Northeast Ocean Data Portal](#). The Portal also offers data and information about other taxa besides birds that may be helpful to you in your project review. Alternately, you may download the bird model results files underlying the portal maps through the [NOAA NCCOS Integrative Statistical Modeling and Predictive Mapping of Marine Bird Distributions and Abundance on the Atlantic Outer Continental Shelf](#) project webpage.

Bird tracking data can also provide additional details about occurrence and habitat use throughout the year, including migration. Models relying on survey data may not include this information. For additional information on marine bird tracking data, see the [Diving Bird Study](#) and the [nanotag studies](#) or contact [Caleb Spiegel](#) or [Pam Loring](#).

What if I have eagles on my list?

If your project has the potential to disturb or kill eagles, you may need to [obtain a permit](#) to avoid violating the Eagle Act should such impacts occur.

Proper Interpretation and Use of Your Migratory Bird Report

The migratory bird list generated is not a list of all birds in your project area, only a subset of birds of priority concern. To learn more about how your list is generated, and see options for identifying what other birds may be in your project area, please see the FAQ "What does IPaC use to generate the migratory birds potentially occurring in my specified location". Please be aware this report provides the "probability of presence" of birds within the 10 km grid cell(s) that overlap your project; not your exact project footprint. On the graphs provided, please also look carefully at the survey effort (indicated by the black vertical bar) and for the existence of the "no data" indicator (a red horizontal bar). A high survey effort is the key component. If the survey effort is high, then the probability of presence score can be viewed as more dependable. In contrast, a low survey effort bar or no data bar means a lack of data and, therefore, a lack of certainty about presence of the species. This list is not perfect; it is simply a starting point for identifying what birds of concern have the potential to be in your project area, when they might be there, and if they might be breeding (which means nests might be present). The list helps you know what to look for to confirm presence, and helps guide you in knowing when to implement conservation measures to avoid or minimize potential impacts from your project activities,

should presence be confirmed. To learn more about conservation measures, visit the FAQ "Tell me about conservation measures I can implement to avoid or minimize impacts to migratory birds" at the bottom of your migratory bird trust resources page.

Marine Mammals

Marine mammals are protected under the [Marine Mammal Protection Act](#). Some are also protected under the Endangered Species Act¹ and the Convention on International Trade in Endangered Species of Wild Fauna and Flora².

The responsibilities for the protection, conservation, and management of marine mammals are shared by the U.S. Fish and Wildlife Service [responsible for otters, walruses, polar bears, manatees, and dugongs] and NOAA Fisheries³ [responsible for seals, sea lions, whales, dolphins, and porpoises]. Marine mammals under the responsibility of NOAA Fisheries are **not** shown on this list; for additional information on those species please visit the [Marine Mammals](#) page of the NOAA Fisheries website.

The Marine Mammal Protection Act prohibits the take of marine mammals and further coordination may be necessary for project evaluation. Please contact the U.S. Fish and Wildlife Service Field Office shown.

-
1. The [Endangered Species Act](#) (ESA) of 1973.
 2. The [Convention on International Trade in Endangered Species of Wild Fauna and Flora](#) (CITES) is a treaty to ensure that international trade in plants and animals does not threaten their survival in the wild.
 3. [NOAA Fisheries](#), also known as the National Marine Fisheries Service (NMFS), is an office of the National Oceanic and Atmospheric Administration within the Department of Commerce.

NAME

West Indian Manatee *Trichechus manatus*

Species profile: <https://ecos.fws.gov/ecp/species/4469>

Wetlands

Impacts to [NWI wetlands](#) and other aquatic habitats may be subject to regulation under Section 404 of the Clean Water Act, or other State/Federal statutes.

For more information please contact the Regulatory Program of the local [U.S. Army Corps of Engineers District](#).

Please note that the NWI data being shown may be out of date. We are currently working to update our NWI data set. We recommend you verify these results with a site visit to determine the actual extent of wetlands on site.

ESTUARINE AND MARINE DEEPWATER

- [Estuarine](#)
-

IPaC User Contact Information

Agency: GHD
Name: Kevin Janni
Address: 1755 Wittington Place
Address Line 2: Suite 500
City: Dallas
State: TX
Zip: 75234
Email: kevin.janni@ghd.com
Phone: 9723318555



Attachment 4

Cultural Resources Desktop Analysis



07 April 2022

Kevin Jani, PWS, CE
GHD Services Inc.
1755 Wittington Place, Suite 500
Dallas, Texas 75234

RE: Cultural Resources Desktop Analysis for the San Jacinto River Waste Pits, Harris County, Texas

INTRODUCTION

Integrated Environmental Solutions, LLC (IES), has been contracted by GHD Services Inc. (GHD), to conduct a due diligence cultural resources assessment for the San Jacinto River Waste Pits project within a 36.8-acre (ac) tract or Area of Potential Effects (APE) located on impoundments within the San Jacinto River along Interstate Highway (IH) 10 in Harris County, Texas (**Attachment A, Figure 1**). IES understands that GHD is assisting their client in maintaining compliance with state and federal cultural resources regulations. For these reasons, IES has assessed the proposed project area for compliance with the Antiquities Code of Texas (ACT), National Historic Preservation Act (NHPA), and similar associated state laws.

PERTINENT REGULATIONS

National Historical Preservation Act Section 106

The NHPA (54 U.S. Code [USC] 306101), specifically NHPA Section 106 (54 USC 306108), requires the State Historic Preservation Officer (SHPO), represented by the Texas Historical Commission (THC), to administer and coordinate historic preservation activities, and to review and comment on all actions licensed by the federal government that will have an effect on properties listed in the National Register of Historic Places (NRHP), or eligibility for such listing. Per 36 Code of Federal Regulations Part 800 (36 CFR 800), the federal agency responsible for overseeing the action must make a reasonable and good faith effort to identify cultural resources. Federal actions include, but are not limited to, construction, rehabilitation, repair projects, demolition, licenses, permits, loans, loan guarantees, grants, and federal property transfers. As this project is sponsored by the U.S. Environmental Protection Agency (EPA) and may require a Clean Water Act (CWA) Section 404 permit from the U.S. Army Corps of Engineers (USACE) the project will be subject to Section 106 requirements.

Antiquities Code of Texas

The ACT, as outlined in the 13 Texas Administrative Code (TAC) Part II and 9 Texas Natural Resources Code (TNRC) 191, requires that political subdivisions notify the THC at least 30 days in advance prior to any project that may affect potential or designated archeological sites. While advance project review by the THC is required for undertakings with more than 5 ac or 5,000 cubic yards of ground disturbance, the THC can still request project information and/or an archeological survey in advance of more minor ground disturbances since all publicly sponsored projects must comply with the ACT. If the activity occurs inside a designated historic district, affects a recorded archeological site, or requires on-site investigations, the project will need to be reviewed by the THC, regardless of project size. The Harris County Central Appraisal District details that the entire project area is currently owned by a private entity. Currently, the project is sponsored by the federal government and the proposed project is located solely within private lands; therefore, the project is not subject to the provisions of the ACT.

Texas Health and Safety Code

Under the provisions of the Texas Health and Safety Code (THSC), as amended by Senate Bill (SB) 1630, the owner of a property on which an unknown cemetery is discovered or on which an abandoned cemetery is located may not construct improvements on the property in a manner that would disturb the cemetery until the human remains interred in the cemetery are removed under a written order issued by the state registrar or the state registrar's designee (THSC Section 711.004[f]). A person who discovers an unknown or abandoned cemetery shall file notice of the discovery of the cemetery with the county clerk of the county in which the cemetery is located and concurrently mail notice to the landowner on record in the county appraisal district not later than 10 days after the date of the discovery. The notice must contain a legal description of the land on which the unknown or abandoned cemetery was found and describe the approximate location of the cemetery and the evidence of the cemetery that was discovered.

The county clerk shall send a copy of the notice to the THC and file the notice in the deed records of the county, with an index entry referencing the land on which the cemetery was discovered.

METHODOLOGY

During the background review, a variety of literature and online sources were referenced to determine if potential cultural resources were located within the APE. These sources included U.S. Geological Survey (USGS) topographic maps, the *Soil Survey of Harris County, Texas*, the Geologic Atlas of Texas (Houston Sheet), the U.S. Department of Agriculture (USDA) Natural Resources Conservation Service (NRCS) digital soil database for Harris County, the 1936 Texas State Highway Department map of Harris County, the Texas Historic Overlay georeferenced map database, the Texas Department of Transportation (TxDOT) Potential Archeological Liability Map (PALM) for Harris County, and both past and current aerial photography of the proposed APE. Additionally, a file search of the Texas Archeological Site Atlas (TASA) and Texas Historical Sites Atlas (THSA) were performed for the proposed location and surrounding areas. This review was conducted by Staff Archeologist Joshua McCormick on 28 December 2021.

RESULTS

Topography, Geology, and Soils

Due to the dynamic setting of the APE, in relation to the San Jacinto River, the topographic setting of the APE has changed considerably since the early 20th century. The 1905 USACE Galveston Bay topographic map and 1916 Burnett Bay USGS topographic map illustrates the APE was located within a marsh and along an elevated relic river levee in the floodplain of the San Jacinto River. Historic topographic maps indicate the majority of the APE was within a relic channel that extended from the current river channel to the Old River channel. This setting remained relatively stable until the late 1950s and early 1960s when the terrain was significantly altered and impoundments were constructed north and south of IH 10 for paper mill waste storage. Around this time, water levels within the river increased and a significant portion of the floodplain was permanently submerged. Currently, the Highlands 7.5-minute USGS topographic quadrangle map illustrates that the APE is located on two generally flat peninsulas within the San Jacinto River (**Attachment A, Figure 2**). The APE features an elevation range of sea level to 11 feet (ft) above mean sea level.

The APE is located within the Northern Humid Gulf Coastal Prairies subregion of the Western Gulf Coastal Plains ecoregion (Griffith et al. 2007). This ecoregion is characterized by low, flat plains with low gradient rivers and streams. The regional vegetation community consists of prairie grasslands with some clusters of southern live oak. The APE is underlain by Quaternary-age alluvium (Qal) deposits of sand, silt, clay and gravel (Aronow et al. 1993; USGS 2021; **Attachment A, Figure 3**).

As depicted by the *Soil Survey of Harris County, Texas*, there are two soil map units within the APE (**Table 1; Attachment A, Figure 4**). The entire APE contains soils typical of *alluvial* development and dredge spoils in tidal settings within the South-Central Plains ecoregion. Soil data was reviewed from the USDA NRCS Web Soil Survey (USDA 2021).

Table 1: Soils within the APE

Soil Map Unit Description	Approximate Percentage of the APE
IjmB – Ijam clay, 0 to 2 percent slopes, frequently flooded, tidal - This component is described as clay located on flats and lagoons. Typical Cg subsoil horizon depth is 8 inches (in; 20 centimeters [cm]). Depth to a root restrictive layer or bedrock is greater than 80 in (203 cm). The natural drainage class is poorly drained.	34.9
HarA – Harris clay, 0 to 1 percent slopes, frequently flooded, tidal - This component is described as clay located on coastal plains. Typical Bssg1 subsoil horizon depth is 8 to 19 in (21 to 48 cm). Depth to a root restrictive layer or bedrock is greater than 80 in (203 cm). The natural drainage class is very poorly drained.	15.4
W – Water	49.7

Texas Archeological Sites Atlas Review

A file search within TASA and the THSA databases, maintained by the THC, identified no previously recorded archeological sites, National Register properties, historical markers, or cemeteries located within the APE (TASA 2021; THSA 2021). The TASA records indicated nine previously surveys have been conducted within 1 mile (mi; ~1.6 kilometer [km]) of the APE, including one performed by the USACE in 1994 within the southern portion of the APE (**Table 2**). In addition, seven previously recorded archeological sites were recorded within 1 mi (~1.6 km) of the APE (**Table 3; Attachment A, Figure 5**).

Table 2: Previously Conducted Archeological Surveys within 1 Mile of the APE

Agency	TAP* No.	Firm/Institution	Date	Survey Type	Location (Approximate)
EPA	n/a	Unknown	1977	Linear	0.22-mi southeast of APE
Federal Highway Administration (FHWA)	n/a	Unknown	1988	Linear	0.25-mi southeast of APE
USACE	n/a	Unknown	1994	Area	Overlaps southern portion of APE
EH&A	n/a	Unknown	1995	Area	0.45-mi southeast of APE
Texas Parks and Wildlife Department (TPWD)	n/a	Unknown	1997	Linear	0.97-mi southeast of APE
EPA	n/a	MAC, Inc.	2004	Area	0.76-mi north of APE
Harris County Public Infrastructure Department (HCPID)	4187	MAC, Inc.	2006	Area	0.98-mi southeast of APE
TxDOT	4191	Coastal Environmental	2006	Underwater	Direct east of APE
Harris County	5647	MAC, Inc.	2010	Area	0.98-mi southeast APE
USACE	6265	CRC, International Archaeology & Ecology, LLC	2013	Area	0.98-mi southeast of APE

*Texas Antiquities Permit

Table 3: Recorded Archeological Sites within 1-Mile of the APE.

Site Trinomial	Time Period	Site Type	Site Size	Depth Extent	Cultural Materials	Location (Approximate)
41HR15	Prehistoric	Mound and lithic scatter	n/a	n/a	Debitage	0.9-mi west of APE
41HR27	Prehistoric	n/a	n/a	n/a	n/a	1.0-mi northwest of APE
41HR28	Prehistoric	Midden	30 x 15 feet (ft)	n/a	Shell	0.29-mi northeast of APE
41HR276	Prehistoric	Midden	100 x 100 ft	12 inches (in)	Shell	0.68-mi north of APE
41HR407	Historic	Homesite	100 x 200 ft	12 in	Pearlware, stoneware, glass, square nails	1.0-mi southeast of APE
41HR640	Prehistoric	Midden-Campsite	300 x 300 ft	n/a	Shell, bone, flint, 2 middle archaic points	0.70-mi north of APE
41HR724	Prehistoric	Midden	75 x 20 ft	n/a	Shell, ceramic	0.35-mi north of APE

Disturbance Analysis

Historical maps and aerial photographs indicate the APE and much of the surrounding area was either used for agricultural purposes or left unaltered from its natural setting during the 19th and early 20th centuries. Between 1920 and 1936, Market Street was constructed across the river and through the APE. In the early 1950s, construction of IH 10, including a bridge crossing, began. The three-span Market Street truss bridge remained south of the IH 10 bridge until the late 1970s when it was demolished. Aerial photography from 1957 indicates widespread clearing and terraforming of the marshland occurred south of the newly constructed IH 10. During this time, it appears the natural embankment between the main river channel and Old River Lake was excavated at the southern point of the APE to connect the two water bodies. In the 1960s, impoundments were constructed on the north and south sides of IH 10. The impoundments served to store liquid, pulp, and other paper mill wastes created by the Champion Papers, Inc. paper mill in Pasadena, Texas. By 1973, much of the natural floodplain setting left within and surrounding APE was destroyed by river channel improvements or submerged by rising water levels. An aerial photograph dating to 1981 indicates the southern portions of the APE were further modified for shipping and storage purposes, which resulted in the general shape of the current landform.

Cultural Resources Potential

Prehistoric Resources

The TxDOT PALM examines “the character and classification of the soils and assesses the shallow and deep geoarcheological potential or the likelihood that soils could contain buried cultural materials in reasonable context (i.e., historic/recent disturbances, landscape setting, and soils data) for each soil series” (Abbott 2011:161). The TxDOT PALM model identifies where sites are likely to be preserved in a reasonable context versus indicating where sites are likely to exist (Abbott 2001:154, 2011:179). “The resolution of the PALM is appropriate to the scale of landform mapping (1:24,000)” (Abbott 2011:175). Any analysis of the data beyond the scale of mapping can result in a misunderstanding of the detail of mapping (Abbott 2011). Due to the more detailed evaluation required to accurately evaluate cultural resources potential for field methodology development (typically 1:7,000 or less), the cultural resources potential evaluation, presented in this scope, includes an assessment of the PALM results at a more detailed level to determine if the APE has retained a reasonable degree of contextual integrity, as assumed by the PALM model. A

reasonable context is evaluated through a review of historical and modern aerial photographs to evaluate the level of previous ground disturbance that has transpired within a given area.

The TxDOT PALM for Harris County indicates that the two areas of the APE south of the IH 10 corridor feature a high potential for deeply buried cultural resources within a reasonable context. The area north of the IH-10 corridor has no data available as it is identified as water on the PALM. Through the background review, it was determined that the APE has been extensively disturbed through terraforming, waste pit and impoundment construction, IH 10 expansion, and water erosion. As such, the potential for shallow and deeply buried prehistoric cultural resources is low.

Historic-Period Resources

Historical maps and aerial photographs indicate the APE, due to its marshy floodplain setting, was generally devoid of any buildings and structures prior to 1920. A portion of Market Street, which was constructed between 1920 and 1936, remains parallel to the IH 10 corridor and is the primary roadway used for access to the southern peninsula. Other historic-period resources within the immediate vicinity are associated with the development of the impoundments, shipping yards, and the channelization of the San Jacinto River. Historical and modern aerial photography show the northern and southern peninsulas have been significantly altered through frequent industrial redevelopment and use. Although the paper mill waste impoundments were constructed in the 1960s, the pits have been modified, filled, or permanently submerged by rising river waters. Due to the disturbances associated with the continued use and modification of the land within the APE, there is a low potential for historic-period cultural resources to be present within the APE.

Underwater Resources

A considerable portion of the APE north of IH-10 is located within the San Jacinto River water body. Although rivers can contain shipwrecks and other sunken or inundated cultural resources, the area within this portion of APE was located on dry land or marshes as early as 1905 and as late as 1972. As such, the potential for historic-period shipwrecks or other sunken cultural resources to be present within the APE is negligible.

CONCLUSIONS

Currently, it is assumed that the project is located on private property and will be privately sponsored and will therefore not require compliance with the ACT. It is also assumed that no federal funds will be needed to complete the project. However, as the project is sponsored by the EPA and the topographic setting of the project area indicates CWA Section 404 permitting may be required, it is assumed that the project must comply with NHPA Section 106. Currently, there is no known nexus requiring compliance with the THSC. No additional investigations or agency coordination is required to comply with federal and state laws at this time.

Based on the results of this desktop analysis, the proposed APE has been exposed to significant previous ground disturbances and contains a low potential for containing either prehistoric or historic-period cultural resources. For these reasons, it is the professional opinion of IES that this project be allowed to proceed without the need for cultural resources investigations. However, if any archeological deposits or other cultural resources are encountered during construction, the operators should immediately stop construction activities in the area of the inadvertent discovery, and the project cultural resources consultant should then be contacted to initiate further consultation with the THC prior to resuming construction activities.

If you have any questions, please contact me by telephone at (972) 562-7672 or via email at kstone@intenvsol.com.

Sincerely,

Integrated Environmental Solutions, LLC



Kevin Stone, MA, RPA
Cultural Resources Principal Investigator

IES Project Ref: 04.303.004

REFERENCES

- Aronow, S., W.L. Fisher, J.H. McGowen, and V.E. Barnes
1993 *Geological Atlas of Texas, Houston Sheet*. Bureau of Economic Geology, The University of Texas at Austin.
- Griffith, Glenn, Sandy Bryce, James Omernik, and Anne Rogers
2007 *Ecoregions of Texas*. Texas Commission on Environmental Quality.
- Texas Archeological Site Atlas (TASA)
2021 *Texas Archeological Sites Atlas*. s.v. "Houston County," <http://nueces.thc.state.tx.us/> (accessed December 2021).
- Texas Historic Site Atlas (THSA)
2021 *Texas Historic Sites Atlas*. s.v. "Houston County," <http://nueces.thc.state.tx.us/> (accessed December 2021).
- U.S. Geological Survey (USGS)
2021 U.S. Department of the Interior Mineral Resources On-Line Spatial Data Website.
<http://mrddata.usgs.gov/sgmc/tx.html> (accessed December 2021).
- U.S. Department of Agriculture (USDA)
2021 U.S. Department of Agriculture – National Resources Conservation Service,
<http://websoilsurvey.nrcs.usda.gov/app/HomePage.htm> (accessed December 2021).

ATTACHMENT A

Figures



Figure 1
General Location Map

 Project Area

County: Harris
 State: Texas
 Date map created: 12/29/2021
 Source: (c) 2009 Microsoft Corporation
 and its data suppliers; ESRI
 Streetmap
 IES Project Ref: 04.303.004

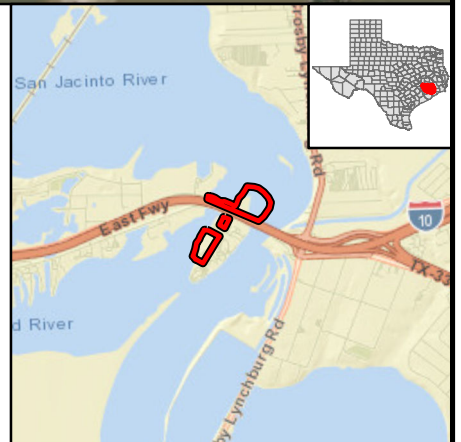
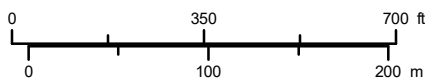

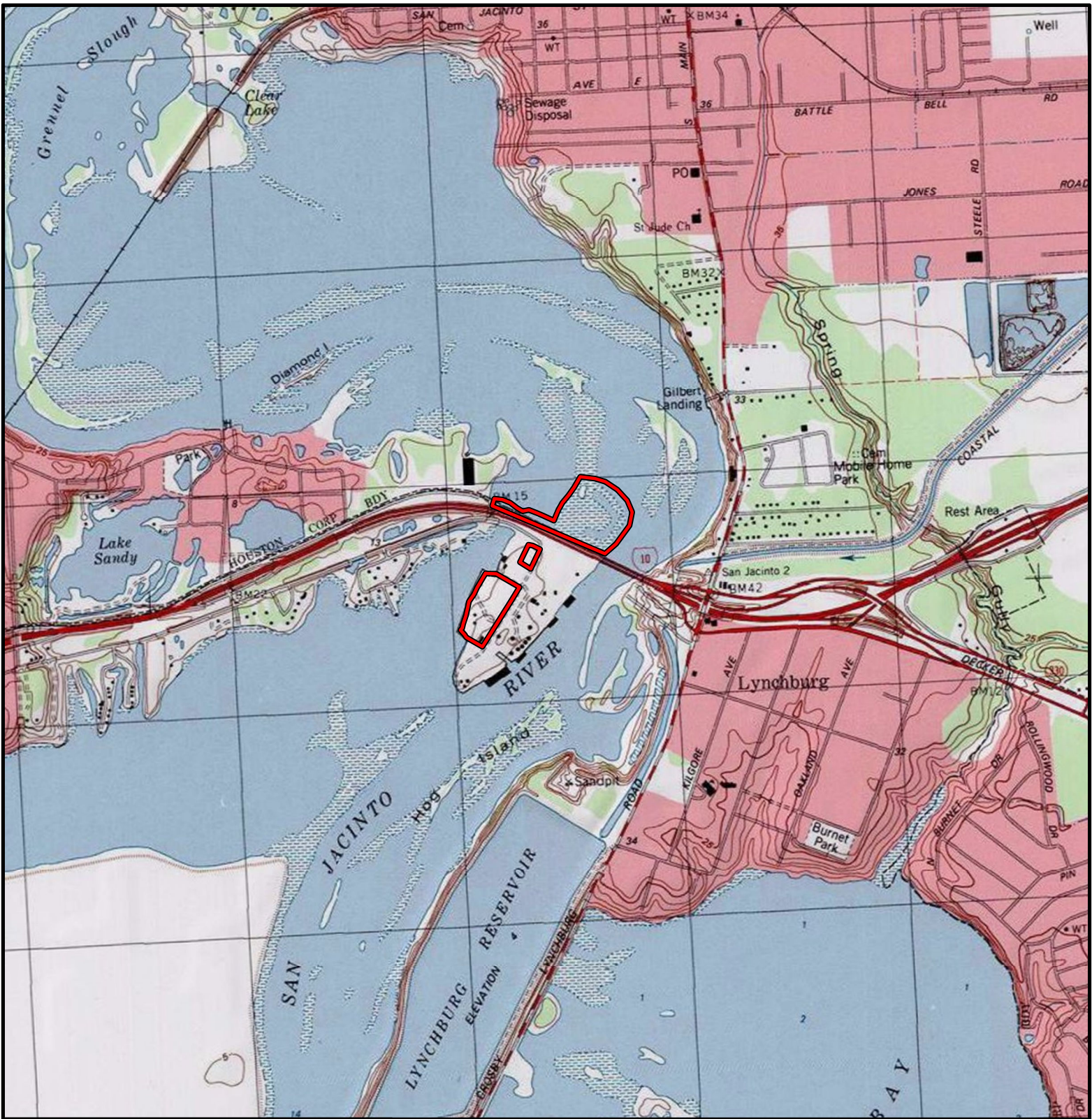

Figure 2
Topographic Setting

 Project Area

County: Harris
 State: Texas
 Date map created: 12/29/2021
 Source: USGS Topographic Map
 7.5' Quadrangle
 Highlands 1983
 IES Project Ref: 04.303.004

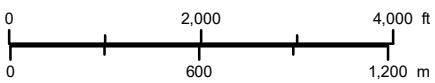





Figure 3
Geologic Setting

 Project Area

Geologic Formation

 Qal - Alluvium

 Qb - bolson deposits

 Wa - Water

County: Harris
 State: Texas
 Date map created: 12/29/2021
 Source: TNRIS Geologic Atlas
 of Texas; Houston Sheet
 IES Project Ref: 04.303.004

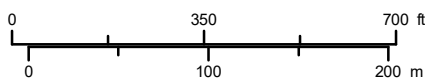

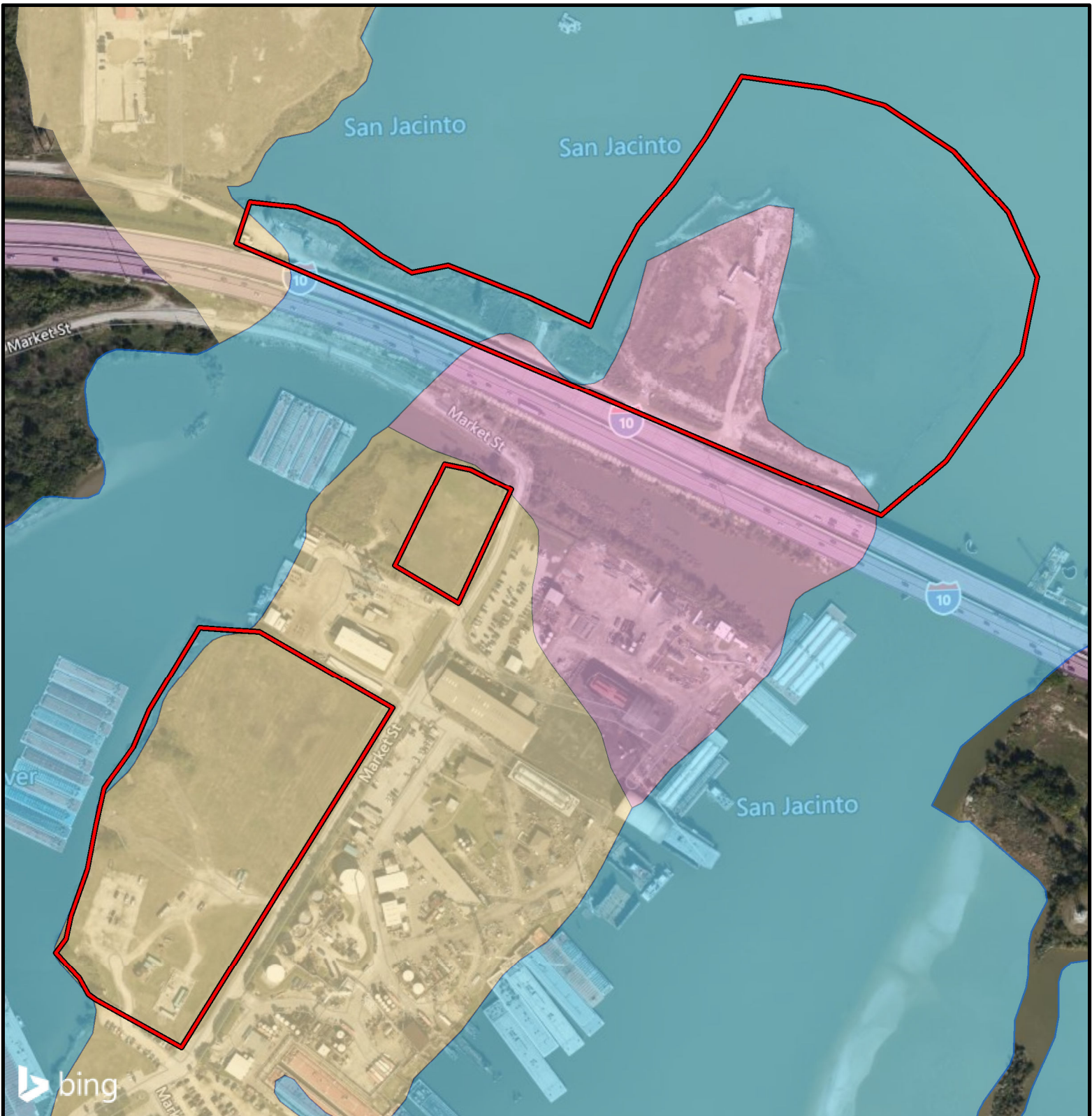
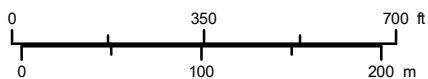





Figure 4
Soil Map Units Located Within and Adjacent to the Project Area

County: Harris
 State: Texas
 Date map created: 12/29/2021
 Source: 2007 USDA
 NRCS Digital Soils Database
 IES Project Ref: 04.303.004



 Project Area

Soil Map Unit (see Table 1)

-  Harris clay, 0 to 1 percent slopes, frequently flooded, tidal
-  Ijam clay, 0 to 2 percent slopes, frequently flooded, tidal
-  Water

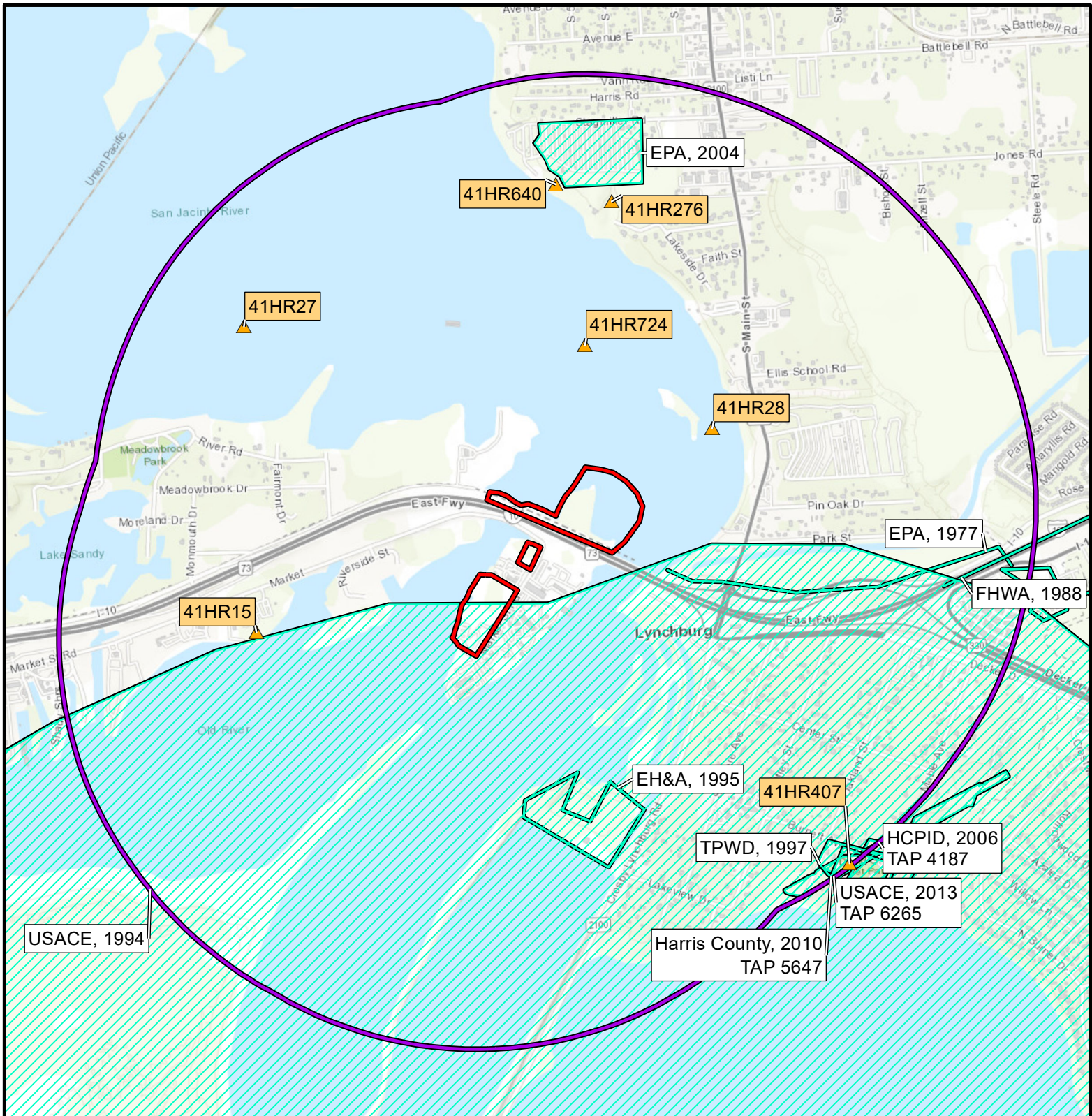
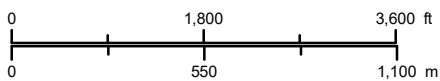

Figure 5
Previous Investigations Within
1 Mile of the Project Area

County: Harris
 State: Texas
 Date map created: 12/29/2021
 Source: (c) 2009 Microsoft Corporation
 and its data suppliers; ESRI; TASA
 IES Project Ref: 04.303.004



- Project Area
- Project Area - 1 Mile Buffer
- Previous Archeological Survey - Area
- Previous Archeological Survey - Line
- ▲ Archeological Site

NOT FOR PUBLIC DISTRIBUTION
Map contains archeological site
locational information