

FINAL SITE-SPECIFIC HEALTH AND SAFETY PLAN

RIVER VALE RADIUM SITE

River Vale, Bergen County, New Jersey

Site Code: A29A

CERCLIS Code: NJN000203321

Prepared by:

Superfund Technical Assessment & Response Team V
Weston Solutions, Inc.
Federal East Division
Edison, New Jersey 08837

Prepared for:

U.S. Environmental Protection Agency, Region II
Superfund and Emergency Management Division
2890 Woodbridge Avenue
Edison, New Jersey 08837

DC No: STARTV-03-F-0004

TD No: TO-0043-0026

EPA CONTRACT No: 68HE0319D0004

July 2021

**REGION II START V HEALTH AND SAFETY PLAN
EMERGENCY RESPONSE/REMOVAL ASSESSMENT/REMOVAL ACTION
(Revised 1 May 2020)**

START V TD No.: TO-0043-0026

Site Name: River Vale Radium

Coordinates: [REDACTED]

Site Address: [REDACTED]
[REDACTED]

Directions to Site: (Attach color map following next page)

1090 King Georges Post Rd

Edison, NJ 08837

**Get on Garden State Pkwy in Fords, Woodbridge Township
from King Georges Post Rd and County Rd 501**

- 6 min (2.4 mi)
-  1. Head west toward King Georges Post Rd

272 ft
 -  2. Turn right onto King Georges Post Rd

0.8 mi
 -  3. Continue onto County Rd 501



0.7 mi
 -  4. Continue onto King Georges Rd



0.2 mi
 -  5. Use the right lane to take the ramp to Garden State Pkwy



0.4 mi
 -  6. Keep left at the fork, follow signs for Garden State Pkwy N and merge onto Garden State Pkwy

0.2 mi

**Follow Garden State Pkwy to Washington Ave in Township
of Washington. Take exit 168 from Garden State Pkwy**

- 39 min (38.0 mi)
-  7. Merge onto Garden State Pkwy
 Toll road

37.8 mi
 -  8. Take exit 168 toward County Rd 502/Washington Westwood/Hohokus
 Toll road

0.2 mi
 -  9. Keep right at the fork, follow signs for Washington/Hillsdale/Westwood and merge onto Washington Ave
 Toll road

141 ft

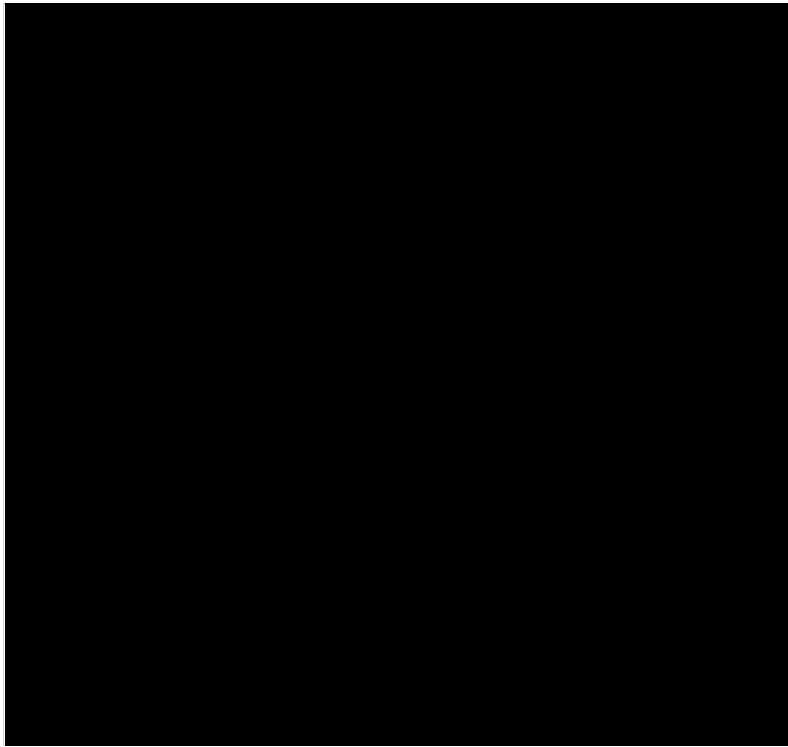

Total Distance: _____

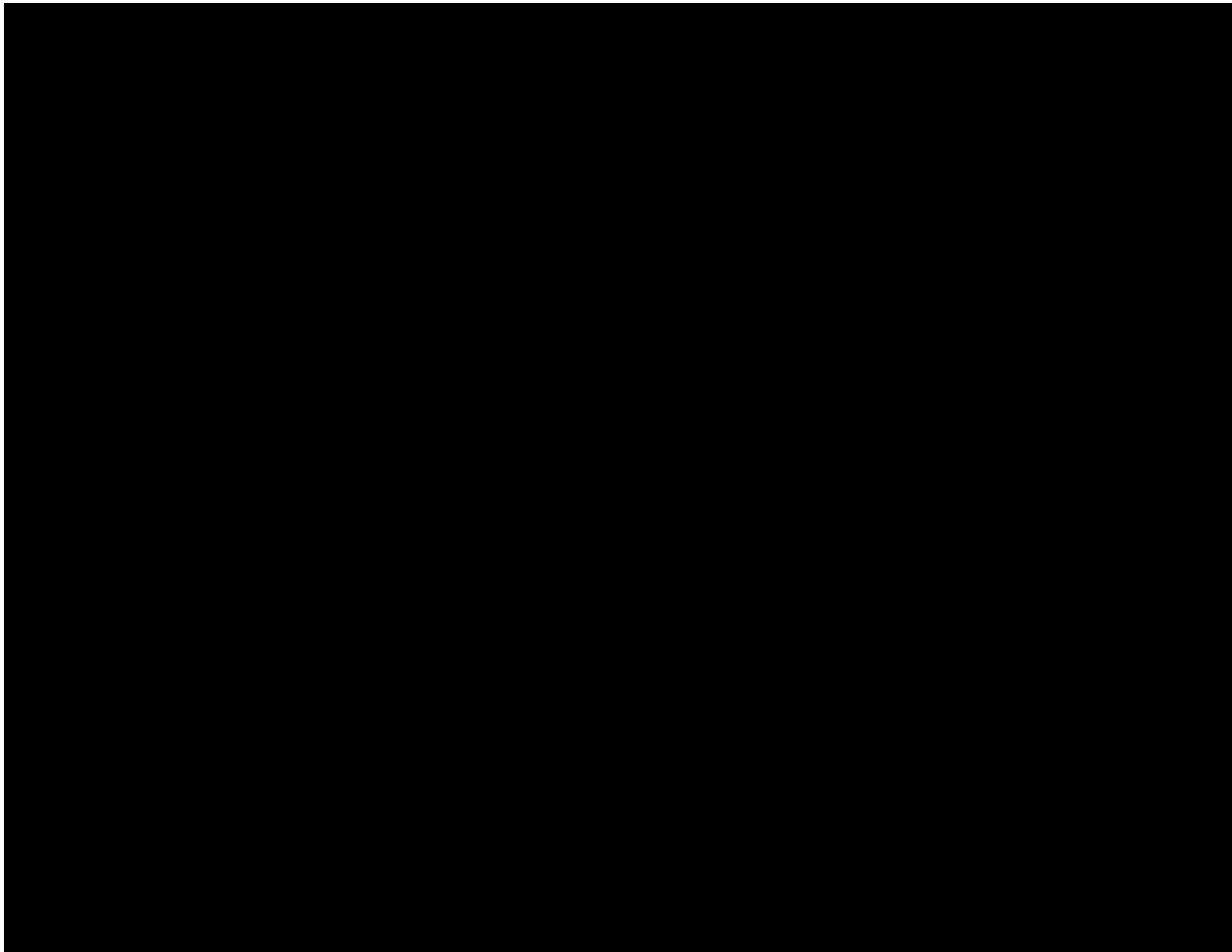

Historical/Current Site Information:

The Nuclear Regulatory Commission (NRC) identified numerous locations throughout the United States where suspected radioactive material was used in generating products made available to the public for sale. The River Vale Radium Site (the Site) has a historical legacy of sharing an address

[REDACTED]
[REDACTED]
[REDACTED]

In December 2017, the New Jersey Department of Environmental Protection (NJDEP) Bureau of Environmental Radiation (BER) conducted an outdoor radiological survey at the Site using a Ludlum 2221 Scaler/Ratemeter with 44-20 (3-inch sodium iodide [NaI]) probe and Trimble Geo7X global positioning system (GPS) unit. Sensor records reflect count rate at approximately 1 foot above ground surface. The front yard area was selected for background reference since measurements with a Ludlum Model 19 were typical of the area (5-15 microrentgen [$\mu\text{R/hr}$]). The NaI background count rate was determined to be 22,441 counts per minute (cpm) with a standard deviation of 2,361 cpm and the NaI survey of the backyard identified four hot spots with count rate ranging from 92,699 to 130,853 cpm. A background surface soil sample was collected at a location reading 21,086 cpm and surface soil samples were collected at three of the four locations with elevated count rates.

In addition to soil samples, discrete objects were recovered as separate samples from two of the four hot spots. Soil analytical results confirm the identification of elevated concentrations of naturally occurring radionuclides, including radium (Ra)-226 and uranium (U)-238. One of the recovered items was identified as a radium painted object and the second item was identified as a piece of uranium ore. The NJDEP BER noted in their Initial Property Survey Report dated March 8, 2018, that the far rear portion of the property which contains a mixture of building debris and natural boulders was not sampled but should be evaluated during characterization.

On August 18 through 20, 2020, the U.S. Environmental Protection Agency, Region II (EPA) and Weston Solutions, Inc., Superfund Technical Assessment & Response Team V (START V) completed Removal Assessment activities at Property P001 [REDACTED] including radiological survey and soil sampling at locations identified as hot spots. The radiological survey was completed in exterior areas of Property P001 using a Ludlum-2241 and 3x3 NaI scintillator setup connected to a GPS unit and EPA's Viper system. Based on radiological survey results, exterior background gamma measurements at Property P001 were 8-10 $\mu\text{R/hr}$. Based on exterior background gamma readings, a total of seven hot spots (P001-SB01, P001-SB02A, P001-SB02B, P001-SB03A, P001-SB03B, P001-SB03C, and P001-SB04) were identified in Property P001, with gamma readings ranging from 15 $\mu\text{R/hr}$ (approximately 2-times [2x] background) to greater than (>) 45 $\mu\text{R/hr}$ (approximately >5x background).

In addition to the Ludlum-2241/3x3 NaI scintillator and Viper system setup, a BNC SAM-940 radioisotope identifier was also utilized at Property P001 to complete the exterior radiological survey. Based on radiological survey results from the SAM-940 gamma scan, gamma reading at the sampled background location (P001-SBKG) was 7.916 $\mu\text{R/hr}$. The seven exterior locations identified as hot spots, and sampled, had elevated gamma readings, including P001-SB01 (156.632 $\mu\text{R/hr}$), P001-SB02A (106.433 $\mu\text{R/hr}$), P001-SB02B (72.356 $\mu\text{R/hr}$), P001-SB03A (106.955 $\mu\text{R/hr}$), P001-SB03B (38.839 $\mu\text{R/hr}$), P001-SB03C (80.931 $\mu\text{R/hr}$), and P001-SB04 (345.931 $\mu\text{R/hr}$). Elevated gamma readings at the hot spots ranged from 38.839 $\mu\text{R/hr}$ (P001-SB03B), approximately 5x background, to 345.931 $\mu\text{R/hr}$ (P001-SB04), approximately 44x background. Based on SAM-940 gamma scan at the background location (P001-SBKG), no radionuclide was

identified; however, Ra-226 was identified in six of the seven hot spots, including P001-SB01, P001-SB02A, P001-SB02B, P001-SB03A, P001-SB03B, and P001-SB03C, and thorium (Th)-232 was identified in P001-SB04.

Investigation of some anomalous and discontinuous gamma exceedance survey data from Property P001 revealed that the gamma exceedance readings were from natural rocks placed within the western fence of the swimming pool by the property owner and natural rocks found near the exterior west wall of the barn. Gamma readings collected with the Ludlum 2241 and 3x3 NaI scintillator outside the western fence of the swimming pool were 8-11 $\mu\text{R/hr}$, gamma readings collected from the rock surfaces within the [REDACTED] were 13-27 $\mu\text{R/hr}$, and gamma readings collected from rock surfaces found near the [REDACTED] were 22-37 $\mu\text{R/hr}$. The gamma readings collected from the rock surfaces were 3x background.

Utilizing non-dedicated stainless steel hand augers, a total of eight borings were advanced at a background location and the seven identified hot spots in Property P001. At each boring location, soil samples were collected in re-sealable plastic bags at 6-inch intervals and scanned at background locations using the Ludlum-2241 and 3x3 NaI scintillator setup. The depths of the soil borings were either 18 or 24 inches below ground surface (bgs), which was determined based on gamma scan results indicating background readings at those depth intervals. Additionally, one discrete object (clear 40 milliliters [mL] glass vial with a black plastic screw cap) was uncovered in one hot spot (P001-SB03A) at depths 0-6 inches bgs. A scan of the 40 mL glass vial with SAM-940 indicated gamma reading at 361 $\mu\text{R/hr}$. One discrete object (clear 4-ounce [oz.] glass jar with black plastic screw cap) was encountered in one hot spot (P001-SB03B) at depths 8-10 inches bgs. A scan of the 4-oz glass jar with SAM-940 and the Ludlum-2241 and 3x3 NaI scintillator setup indicated gamma readings at 1,466 $\mu\text{R/hr}$ and 1,500 $\mu\text{R/hr}$, respectively.

A total of 20 samples comprising 17 grab soil samples, including one field duplicate, two discrete objects, including one 40 mL glass vial, and one 4 oz. glass jar, and one rinsate blank, were collected at Property P001. All the soil samples and discrete objects were collected from eight sampling locations in Property P001 and analyzed by the assigned laboratory for gamma spectroscopy, Ra-226 homogenized for 21-day ingrowth, alpha spectroscopy, and isotopic thorium and uranium via ICP-MS. Since there are no established EPA Site-Specific Action Levels (SSALs) for the target radionuclides, analytical results of the soil samples and two discrete objects were not compared with any regulatory limits. However, when analytical results of the soil samples collected from the hot spot locations are compared with the analytical results of the soil samples collected from the background location, the concentrations of target radionuclides significantly exceed background radionuclide concentrations by at least 3x, or greater.

The EPA determined that the Site is designated as a cultural resource. While the cultural resource designation of the Site was generated in the 1980s when the parcel was of greater size than today, the cultural resource designation did not carry over to other parcels following the subdivision of land. Only P001 was classified as a cultural resource.

On March 16, 2021, EPA, START V, and Richard Grubb & Associates (RGA), START V subcontractor, completed a pedestrian survey as part of a Phase 1A Cultural Resource Survey (CRS) limited to property boundaries of [REDACTED] (Property P001). Additionally, a background research and archaeological sensitivity assessment were also completed as part of the Phase 1A CRS to facilitate verification of the Site's cultural resource designation and ensure compliance with the National Historic Preservation Act (NHPA) of 1966 in view of any potential removal operations at the Site. The Area of Potential Effects (APE) was identified along [REDACTED]

██████████ and consists of four areas comprising approximately 944 square feet within the Site location. The APE contains relatively level topography and includes well-drained soils. Background research did not identify any previously recorded archaeological resources in the APE, although four pre-Contact archaeological sites, three historic archaeological sites, and one unknown site are situated within one mile of the APE. A review of the New Jersey Historic Preservation Office (NJHPO) files found that the APE is located within the boundaries of one historic property listed in the New Jersey Register (NJR) and National Register of Historic Places (NRHP) as an example of one of the Early Stone Houses of Bergen County.

The instances of subsurface disturbance were minimal and localized to the east and south of the APE. These are confined to the twentieth-century ██████████ and driveway. Based on a consideration of environmental variables, background research, and the results of the pedestrian survey, the APE and undisturbed portions of the Site were assessed with high archaeological sensitivity for pre-Contact archaeological resources. The APE was assessed with high sensitivity for historic period resources ██████████ and its association with ██████████. A Phase 1B archaeological survey was recommended within the APE due to its high archaeological sensitivity.

On May 19, 2021, START V and RGA, START V subcontractor mobilized to the Site to conduct a Phase 1B CRS at the Site. The Phase 1B CRS was limited to hot spots that were identified at the Site for possible future excavation. Additionally, START V collected two composite disposal soil samples, including one field duplicate, for full target analyte list (TAL) volatile organic compounds (VOCs), TAL semivolatile organic compounds (SVOCs), TAL pesticides, TAL polychlorinated biphenyls (PCBs), TAL metals including mercury, cyanide, herbicides, toxicity characteristic leaching procedure (TCLP) VOCs, TCLP SVOCs, TCLP pesticides, TCLP herbicides, TCLP metals including mercury, and Resource Conservation and Recovery Act (RCRA) characteristics, analyses.

START V Scope of Work:

START V has been tasked by EPA with providing field support for additional Removal Assessment activities at the Site beginning on July 13, 2021, including clean fill soil sampling and background air monitoring and sampling for particulates. As part of the scope of work, START V will perform baseline community air monitoring for PM₁₀ (particulate matter smaller than 10 microns) using DustTrak particulate monitors, baseline air sampling for particulates using RADĒCO volumetric air samplers with filter media attachment, and fill material sampling. Clean fill soil samples, including quality assurance/quality control (QA/QC) samples, will be submitted to the assigned laboratory for TAL VOCs, TAL SVOCs, TAL pesticides, TAL PCBs, TAL metals including mercury, cyanide, and herbicides, analyses.

Post excavation soil samples will be collected from seven previously identified hot spots on Site. The seven hot spot areas will be excavated by a wheeled excavator that will be operated by a Weston heavy equipment operator. Prior to the start of each day's activities, all heavy equipment mobilized to Site will be inspected to ensure that each machine is in proper working order. Any machine that is deemed to not be in working order will be considered out of service and removed from the Site. Special care will be taken to ensure that there is a line of sight between the equipment operator and field staff. Field staff will not be permitted to walk behind any equipment while it is activated. After each excavation is advanced to the proper depth, contaminated soil will be placed into Super Sacks. Each Super Sack will be moved using a skid steer with a fork attachment. During movement, each Super Sack will be lifted using factory installed lift attachment on each bag and lifted a maximum of two feet off the ground to ensure that the skid steer can remain stable. Field

staff members will not be permitted to be near the skid steer while Super Sack movement is ongoing. Refer to Attachment B: Weston FLDs - FLD 22, Earth Moving Equipment for additional information.

To ensure the safety of field staff on site, START V has established radiation exposure limits. When radiation values on-Site exceed 3x background, field staff will be notified of the hazard, at 300 uR/Hr, START V will reevaluate the area to determine the best course of action, and at levels $\geq 1,000$ uR/Hr START V will exit the area. Refer to Attachment B: Weston FLDs - Information for Radiation Related Field Work for additional information.

In addition, START V will collect post-excavation soil samples from the base of the seven identified hot spot excavations, including QA/QC samples. The soil samples collected will be screened off-Site using a High-Pressure Germanium (HPGe) radiation detector and then submitted to the assigned laboratory for radiochemistry (alpha and gamma spectroscopy), analyses. All Site activities will be conducted in Level D personal protective equipment (PPE) while wearing a face covering up to and including N95 face mask. However, based on air sampling and monitoring results, PPE may be upgraded to level C. All Site activities will be noted in the Site logbook and documented with digital photographs.

Five (5) S.M.A.R.T. Health and Safety Goals for the Project (Simple, Measurable, Actionable, Reasonable, & Timely):

1. Safely navigate (no accidents) while driving vehicle to and from the Site.
2. Maintain social distance of at least 6 feet between personnel while working on Site.
3. Beware of surroundings, including heavy equipment, and walking surfaces to minimize slips, trips, and fall hazards. Line of sight between equipment operators and field staff.
4. Adhere to the Weston Solutions, Inc., Radiation Safety Program during on-site activities, including the use of time, distance, and shielding to limit radiation exposure.
5. All Site work must be conducted in accordance with COVID-19 Protocols to limit the exposure and transmission of SARS-CoV-2.

Incident Type:

- Emergency Response
- Removal Assessment: Beginning on July 13, 2021
- Removal Action
- Residential Sampling/Investigation
- PRP Oversight
- Other

Location Class:

- Industrial
- Commercial
- Urban/Residential

Rural

U.S. EPA OSC: Keith Glenn

Original HASP: Yes

Lead START V: Sean Quinn

Date of Initial Site Activities: 07/13/2021

Site Health & Safety Coordinator: Sean Quinn

Site Health & Safety Alternate: To be determined

Response Activities/Dates of Response (fill in as applicable)

Emergency Response:

- Perimeter Recon
- Site Entry
- Visual Documentation
- Multi-Media Sampling
- Decontamination

Removal Assessment:

- Site Radiation Screening: Beginning on July 13, 2021
- Site Entry: Beginning on July 13, 2021
- Visual Documentation: Beginning on July 13, 2021
- Multi-Media Sampling: Beginning on July 13, 2021
- Decontamination

Removal Action:

- Perimeter Recon
- Site Entry
- Visual Documentation
- Multi-Media Sampling
- Decontamination

Physical Safety Hazards to Personnel:

<input checked="" type="checkbox"/>	Incllement Weather – Attach FLD02	<input checked="" type="checkbox"/>	Heat – Attach FLD05	<input type="checkbox"/>	Cold – Attach FLD06
<input type="checkbox"/>	Confined Space – Attach FLD08	<input type="checkbox"/>	Industrial Trucks – Attach FLD09	<input checked="" type="checkbox"/>	Manual Lifting – Attach FLD10
<input checked="" type="checkbox"/>	Terrain – Attach FLD11	<input type="checkbox"/>	Structural Integrity – Attach FLD13	<input type="checkbox"/>	Site Security – Attach FLD14
<input type="checkbox"/>	Pressurized Containers, Systems – Attach FLD16	<input type="checkbox"/>	Use of Boats – Attach FLD18	<input type="checkbox"/>	Waterways – Attach FLD19
<input type="checkbox"/>	Explosives – Attach FLD21	<input checked="" type="checkbox"/>	Heavy Equipment – Attach FLD22	<input type="checkbox"/>	Aerial Lifts and Manlifts – Attach FLD24
<input type="checkbox"/>	Elevated Surfaces and Fall Protection – Attach FLD25	<input type="checkbox"/>	Ladders – Attach FLD26	<input checked="" type="checkbox"/>	Excavations/Trenching – Attach FLD28
<input type="checkbox"/>	Fire Prevention – Attach FLD31	<input checked="" type="checkbox"/>	Fire Extinguishers – Attach FLD32	<input checked="" type="checkbox"/>	Underground/Overhead Utilities – Attach FLD34
<input checked="" type="checkbox"/>	Hand and Power Tools – Attach FLD38	<input type="checkbox"/>	Illumination – Attach FLD39	<input type="checkbox"/>	Electrical Safety – Attach FLD35
<input type="checkbox"/>	Lead Exposure – Attach FLD46	<input checked="" type="checkbox"/>	Sample Storage – Attach FLD49	<input type="checkbox"/>	Cadmium Exposure – Attach FLD50
<input type="checkbox"/>	Asbestos Exposure – Attach FLD52	<input type="checkbox"/>	Hexavalent Chromium Exposure – Attach FLD 53	<input type="checkbox"/>	Benzene Exposure – Attach FLD 54
<input type="checkbox"/>	Drilling Safety – Attach FLD56	<input type="checkbox"/>	Drum Handling – Attach FLD58	<input type="checkbox"/>	Gasoline Contaminant Exposure – Attach FLD61
<input checked="" type="checkbox"/>	Noise – Attach FLD01	<input checked="" type="checkbox"/>	Walking/Working Surfaces	<input checked="" type="checkbox"/>	Motor Vehicle Safety – Attach FLD 57
<input checked="" type="checkbox"/>	COVID-19 Guidance Document	<input type="checkbox"/>	Nonionizing Radiation	<input checked="" type="checkbox"/>	Ionizing Radiation

Biological Hazards to Personnel:

- Infectious/Medical/Hospital Waste – Attach FLD 44 and 45
- Insects – Attach START V FLD 43B
- Raw Sewage
- Non-domesticated Animals – Attach START V FLD43A
- Poisonous Plants/Vegetation – Attach START V FLD 43D
- Bloodborne Pathogens – Attach FLD 44 and 45

Training Requirements:

- 40-Hour HAZWOPER Training with three days supervised experience
- 8-Hour Annual Refresher Health and Safety Training
- DOT (CMV Training - ERV in Use)
- 8-Hour Management or Supervisor Training in addition to basic training course
- Site Specific Health and Safety Training
- Bio-Medical Collection and Response

Medical Surveillance Requirements:

- Baseline initial physical examination with physician certification
- Site-specific medical monitoring protocol (Radiation, Heavy Metals)
- Annual medical examination with physician certification
- Asbestos worker medical protocol

Vehicle Use Assessment and Selection:

Driving is one of the most hazardous and frequent activities for Weston Employees. As such, Weston Employees are required to adhere to established safe operating practices in order to maintain their eligibility to drive Weston owned, leased, or rented vehicles. Every driver riding in a Weston vehicle, must maintain a commitment for a safe journey. This means being attentive while in the vehicle to notice hazards ahead of and around the vehicle and ensure that they are not distracted from safely operating the vehicle.

A high percentage of vehicle accidents occur when operating in reverse. Anytime a vehicle is operated in reverse, e.g., backing out of a parking area, if there are other individuals available, at least one of them are to assist the driver by acting as a guide person during the reverse movement or during other vehicle operation where it would be prudent to have a guide person(s) participate in the vehicle movement. When practical, the preferred parking method would be to back into the parking area.

At a minimum, each Weston Driver must:

- Possess a current, valid drivers' license
- Current Commercial Motor Vehicle (CMV) card when operating the Emergency Response Vehicle
- Obey posted speed limits and traffic laws
- Wear seat belts at all times while the vehicle is in operation
- Conduct a 360-degree inspection around the vehicle before attempting to drive the vehicle
- Report accidents / incidents immediately and complete a Notice of Incident (NOI)
- Keep vehicles on approved roadways (4WD doesn't guarantee mobility on unapproved surfaces)

All Region II START V personnel are experienced and qualified to drive START V fleet vehicles (Tahoe, Suburban, Minivan/Cargo Van, and Emergency Response Vehicle). However, in the event that vehicle rental is required, each person must take the time to familiarize themselves with that particular vehicle. This familiarization includes adjustment of the dashboard knobs/controls, mirrors, steering wheel, seats, and a 360-degree external inspection of the vehicle.

1. The following vehicles are anticipated to be used on this project:

- | | |
|----------------------------------------------------------------------------------------------------------------------|-----------------------------------------------------------------------------------------------------|
| <input type="checkbox"/> Car | <input type="checkbox"/> Pickup Truck |
| <input type="checkbox"/> Intermediate/Standard SUV (e.g. Chevy Trailblazer, Chevy Tahoe, Ford Explorer, Ford Escape) | <input checked="" type="checkbox"/> Full Size SUV (e.g. Chevy Suburban, Ford Expedition, GMC Yukon) |
| <input checked="" type="checkbox"/> Minivan/Cargo Van (e.g. Chevy Uplander, Chevy Express Van) | <input type="checkbox"/> Box Truck (Size: _____) |
| <input type="checkbox"/> Emergency Response Vehicle (ERV) | <input type="checkbox"/> Other _____ |

2. Are there any on-site considerations that should be noted:

- | | | | |
|--------------------------------------------------------------|-------------------------------------------------------------|----------------------------------------------------------|---------------------------------------------|
| <input checked="" type="checkbox"/> Working/Driving Surfaces | <input checked="" type="checkbox"/> Debris | <input type="checkbox"/> Overhead Clearance | <input type="checkbox"/> Obstructions |
| <input checked="" type="checkbox"/> Tire Puncture Hazards | <input type="checkbox"/> Vegetation | <input checked="" type="checkbox"/> Terrain | <input checked="" type="checkbox"/> Parking |
| <input checked="" type="checkbox"/> Congestion | <input checked="" type="checkbox"/> Site Entry/Exit Hazards | <input checked="" type="checkbox"/> Local Traffic Volume | <input type="checkbox"/> Security |
| <input checked="" type="checkbox"/> Heavy Equipment | <input checked="" type="checkbox"/> Time/Length of Workday | <input type="checkbox"/> Other: | |

Do any of the considerations above require further explanation: No

3. Was the WESTON Environmental Risk Management Tool completed in EHS? No

Was an Environmental Compliance Plan required? No

4. Are there any seasonal considerations that should be noted (e.g., Anticipated Snowy Conditions): No

5. Is a Traffic Control Plan required?

Yes No

Physical Parameters	Chemical Contaminant Radium (See Attachment A)	Chemical Contaminant Radon (See Attachment A)	Chemical Contaminant Thoron (See Attachment A)
Exposure Limits / IDLH Level	____ ppm ____ mg/m ³ PEL ____ ppm ____ mg/m ³ REL ____ ppm ____ mg/m ³ IDLH	____ ppm ____ mg/m ³ PEL ____ ppm ____ mg/m ³ REL ____ ppm ____ mg/m ³ IDLH	____ ppm ____ mg/m ³ PEL ____ ppm ____ mg/m ³ REL ____ ppm ____ mg/m ³ IDLH
Physical Form (Solid/Liquid/Gas)	____ Solid ____ Liquid ____ Gas	____ Solid ____ Liquid ____ Gas	____ Solid ____ Liquid ____ Gas
Color			
Odor			
Flash Point Flammable Limits	____ Degrees F or C ____% UEL ____% LEL	____ Degrees F or C ____% UEL ____% LEL	____ Degrees F or C ____% UEL ____% LEL
Specific Gravity	____ Water = 1	____ Water = 1	____ Water = 1
Solubility			
Incompatible Materials			
Routes of Exposure	____ Inh ____ Abs ____ Con ____ Ing	____ Inh ____ Abs ____ Con ____ Ing	____ Inh ____ Abs ____ Con ____ Ing
Symptoms of Acute Exposure			
First Aid Treatment			
Ionization Potential	____ eV	____ eV	____ eV
Instruments for Detection	____ PID w/ ____ Probe ____ FID ____ CGI ____ RAD ____ Det Tube ____ Other ____ Lumex	____ PID w/ ____ Probe ____ FID ____ CGI ____ RAD ____ Det Tube ____ Other ____ Lumex	____ PID w/ ____ Probe ____ FID ____ CGI ____ RAD ____ Det Tube ____ Other ____ Lumex

Physical Parameters	<u>Chemical Contaminant</u> <u>Uranium</u> (See Attachment A)
Exposure Limits / IDLH Level	____ ppm ____ mg/m ³ PEL ____ ppm ____ mg/m ³ REL ____ ppm ____ mg/m ³ IDLH
Physical Form (Solid/Liquid/Gas)	____ Solid ____ Liquid ____ Gas
Color	
Odor	
Flash Point Flammable Limits	____ Degrees F or C ____% UEL ____% LEL
Specific Gravity	____ Water = 1
Solubility	
Incompatible Materials	
Routes of Exposure	____ Inh ____ Abs ____ Con ____ Ing
Symptoms of Acute Exposure	
First Aid Treatment	
Ionization Potential	____ eV
Instruments for Detection	____ PID w/ ____ Probe ____ FID ____ CGI ____ RAD ____ Det Tube ____ Other ____ Lumex

Control Measures: The Work zones are currently unknown. The appropriate work zones will be determined on-site based on the proposed sampling area.

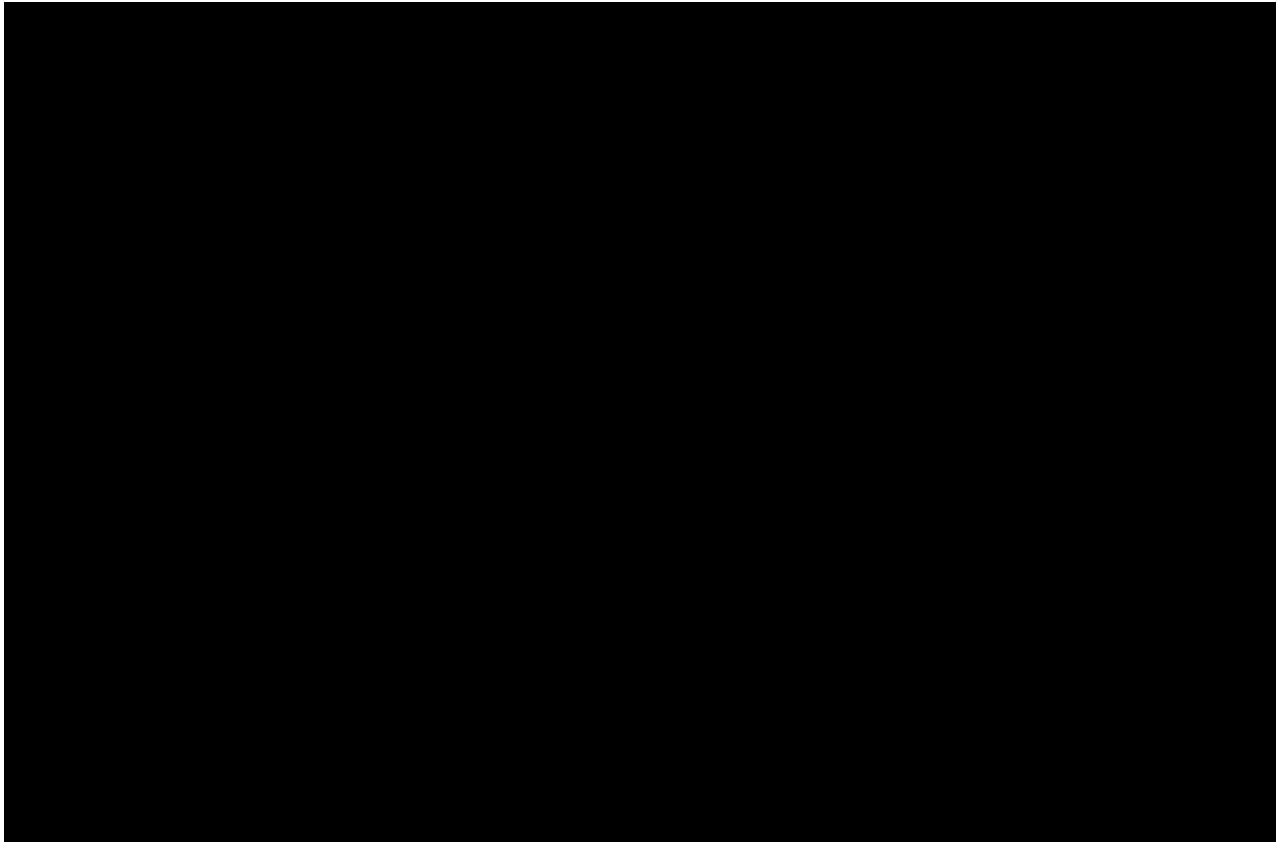

Work Zone Definitions:

Each work/control zone can be described as follows:

Exclusion Zone - the area where contamination is either known or expected to occur and the greatest potential for exposure exists. The outer boundary of the Exclusion Zone, called the Hotline, separates the area of contamination from the rest of the Site.

Contamination Reduction Zone (CRZ) - the area in which decontamination procedures take place. The purpose of the CRZ is to reduce the possibility that the Support Zone will become contaminated or affected by the site hazards.

Support Zone - the uncontaminated area where workers are unlikely to be exposed to hazardous substances or dangerous conditions. The Support Zone is the appropriate location for the command post, medical station, equipment and supply center, field laboratory, and any other administrative or support functions that are necessary to keep site operations running efficiently.

Communications:

- | | | | |
|-------------------------------------|--------------------------|-------------------------------------|-----------------------------|
| <input checked="" type="checkbox"/> | Buddy System | <input type="checkbox"/> | Radio |
| <input type="checkbox"/> | Air Horn for Emergencies | <input checked="" type="checkbox"/> | Hand Signals/Visual Contact |

Personnel Decontamination Procedures:

- Wet Decontamination (procedures as follows)
- Dry Decontamination (procedures as follows)

Baseline air monitoring, clean fill sampling, excavation, and post-excavation soil sampling activities will be conducted in Level D PPE while wearing a face covering up to and including N-95 face mask. However, if it is anticipated that soil disturbance during the any site work will generate fugitive dust, then PPE will be upgraded to Level C (respirator and P100 cartridges). All used disposable PPE will be grossly decontaminated and disposed of in accordance with applicable federal, state, and local regulations.

Equipment Decontamination Procedures:

- None
- Wet Decontamination (procedures as follows)
- Dry Decontamination (procedures as follows)

Dedicated sampling equipment will be utilized for sample collection; therefore, decontamination of sampling equipment will not be necessary.

Adequacy of decontamination determined by: START V Health and Safety Officer

Personal Protective Equipment

ASK TO BE PERFORMED	ANTICIPATED LEVEL OF PROTECTION	TYPE OF CHEMICAL PROTECTIVE COVERALL	INNER GLOVE / OUTER GLOVE / BOOT COVER	APR CARTRIDGE TYPE or SCBA
Baseline air monitoring/sampling	Level C/D+	None/Tyvek*	Nitrile Gloves / Nitrile Gloves / Latex Boot Covers	P100 cartridges/face covering up to and including N95 face mask
Clean fill sampling	Level D+	None/Tyvek	Nitrile Gloves / Nitrile Gloves / Latex Boot Covers	Face covering up to and including N95 face mask
Excavations utilizing heavy equipment	Level C/D+	None/Tyvek	Nitrile Gloves / Nitrile Gloves / Latex Boot Covers	P100 cartridges/face covering up to and including N95 face mask
Documentation/Post-excavation soil sampling	Level D+	None/Tyvek*	Nitrile Gloves / Nitrile Gloves / Latex Boot Covers	Face covering up to and including N95 face mask



Level D+ includes the use of face covering up to and including N-95 face mask
 *Use of Tyvek while in Level D+ PPE is for the protection of personal clothing.

Hazard Task Analysis

RISK LEVEL (High, Medium, Low)	TASK/HAZARD	RECOGNITION/ SYMPTOMS	MITIGATION	LEVEL OF PROTECTION
Low/Medium	<p>Task: Base line air sampling/monitoring and excavation activities.</p> <p>Hazard: Exposure to natural fugitive dust present at the Site.</p>	<ul style="list-style-type: none"> Perform continuous real-time air monitoring and compare readings to background levels. 	<ul style="list-style-type: none"> Wear appropriate PPE during activities that generate dust. 	Level C/D+
Low/Medium	<p>Task: Clean fill sampling and excavations on site.</p> <p>Hazard: Heavy equipment.</p>	<ul style="list-style-type: none"> Wear high visibility clothing and be aware of surroundings. Eye contact with operator. Perform daily inspections on all equipment on Site. 	<ul style="list-style-type: none"> Wear appropriate PPE during activities at the vendor facility. Work with vendor facility to ensure that all working parties are aware of outside personnel on the facility grounds. Maintain visual contact between all operators and field personnel to ensure line of sight is maintained. Maintain proper distance from heavy equipment to eliminate potential contact with equipment. 	Level D+
Low	<p>Task: Documentation and sampling.</p> <p>Hazard: Slips, trips, falls around uneven surfaces.</p>	<ul style="list-style-type: none"> Unsure/unstable/uneven walking/working surfaces. 	<ul style="list-style-type: none"> Visually inspect work areas and mark, barricade, or eliminate slip, trip, and fall hazards. Avoid walking uneven surfaces, if possible. 	Level D+
Low	<p>Task: Tailgate meeting, site documentation and sampling.</p> <p>Hazard: Interaction with persons that may be potentially exposed to COVID-19.</p>	<ul style="list-style-type: none"> Consider all persons, including asymptomatic persons, to be potentially exposed to COVID-19. Perform temperature checks for all field personnel upon arrival and before departing the Site. Normal body temperature >96.4 to <99.5 °F Possible Fever: >100.4 °F 	<ul style="list-style-type: none"> Maintain social distancing of at least 6 ft. between field personnel. Limit meeting to less than 10 people if possible. Wear safety glasses and a face covering up to and including N-95 face mask and avoid hand to face contact. Wear gloves to minimize hand/skin contact with tools/objects/surfaces. Wash hands thoroughly with soap and clean water for at least 40 seconds before eating, drinking, or smoking, and during and after work. Symptomatic persons should stay home and not be allowed on-site 	Level D+
Low	<p>Task: Utilization of field equipment/monitoring instruments/tools.</p> <p>Hazard: Contact with surfaces that may be potentially impacted by COVID-19.</p>	<p>Consider all field equipment/instruments to be potentially impacted by COVID-19.</p>	<ul style="list-style-type: none"> Wear safety glasses and a face covering up to and including N-95 face mask and avoid hand to face contact. Wear gloves and wipe down equipment/instruments tools/objects/surfaces with EPA approved disinfectants. Wash hands thoroughly with soap and clean water for at least 40 seconds or use EPA approved disinfectants after using field equipment/monitoring instruments/tools. 	Level D+
Low	<p>Task: Travel to and from project Site.</p> <p>Hazards: Interaction with persons and contact with surfaces potentially impacted by COVID-19.</p> <p>Vehicular loss of control i.e. swerving or skidding into traffic or pedestrians. Collision with stationary objects.</p>	<ul style="list-style-type: none"> Consider all persons and vehicle surfaces to be potentially impacted by COVID-19. Distraction while driving. Poor driving conditions, i.e., rain. Exhaustion/lack of sleep. 	<ul style="list-style-type: none"> Wipe down controls/steering wheel with EPA approved disinfectants before and after driving. Maintain eyes on road at all times and pull to curb to answer phone calls. Check rear view mirror and side mirrors to ensure line of sight in all directions when backing up and changing lanes. Reduce speed when road condition is slippery. If exhausted stop to take short naps before continuing. 	Seat Belt and Driver Airbags

Level D+ includes N-95 face mask; Refer to Attachment C for COVID-19 Protocols.

Frequency and Types of Air Monitoring:

Continuous  Routine -  Periodic - 

DIRECT READING INSTRUMENTS	EQUIPMENT ID NUMBER	CALIBRATION DATE	START V PERSONNEL	ACTION LEVEL
LUDLUM MODEL 2241 SURVEY METER	EPA Equipment	EPA Equipment	Sean Quinn	≥ 1,000 uR/Hr- Exit Area, Establish Perimeter, Contact START V HSO
LUDLUM MODEL 19 SURVEY METER	EPA Equipment	EPA Equipment	Sean Quinn	≥ 1,000 uR/Hr- Exit Area, Establish Perimeter, Contact START V HSO
LUDLUM MODEL 2211 SURVEY METER	NA	NA	NA	≥ 1,000 uR/Hr- Exit Area, Establish Perimeter, Contact START V HSO
DustTracks Particulate Monitor	EPA Equipment	EPA Equipment	Sean Quinn	< 100 µg/m ³ – continue monitoring ≥ 100 µg/m ³ – begin dust suppression ≥ 150 µg/m ³ – stop work, contact OSC

Emergency Telephone Numbers

Emergency Contact	Location / Address	Telephone Number	Notified
Hospital	Hackensack Meridian Health Pascack Valley Medical Center 250 Old Hook Rd, Westwood, NJ 07675	(201) 383-1035	No
Ambulance	Old Tappan Volunteer First Aid Corps 4 Russell Ave, Old Tappan, NJ 07675	(201) 666-9030 or call 911	No
Police	Old Tappan Police Department 21 Russell Ave, Old Tappan, NJ 07675	(201) 664-1221 or call 911	No
Fire Department	River Vale Fire Department North Firehouse 620 Rivervale Rd, River Vale, NJ 07675	(201) 358-7776 or call 911	No

Chemical Trauma Capability?

If no, closest backup: Yes No Phone:

Directions to Hospital (Attach Color Map Following This Page):

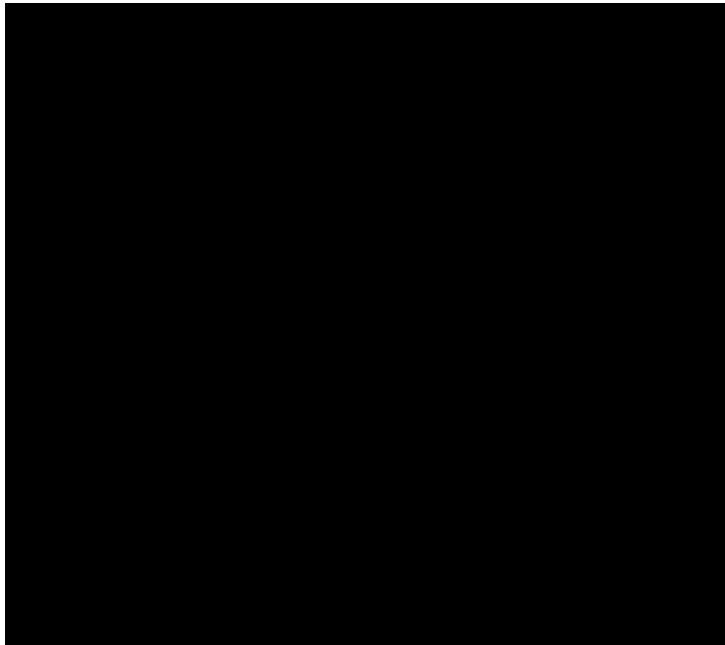

Total Estimated Distance: XXXXXXXXXX

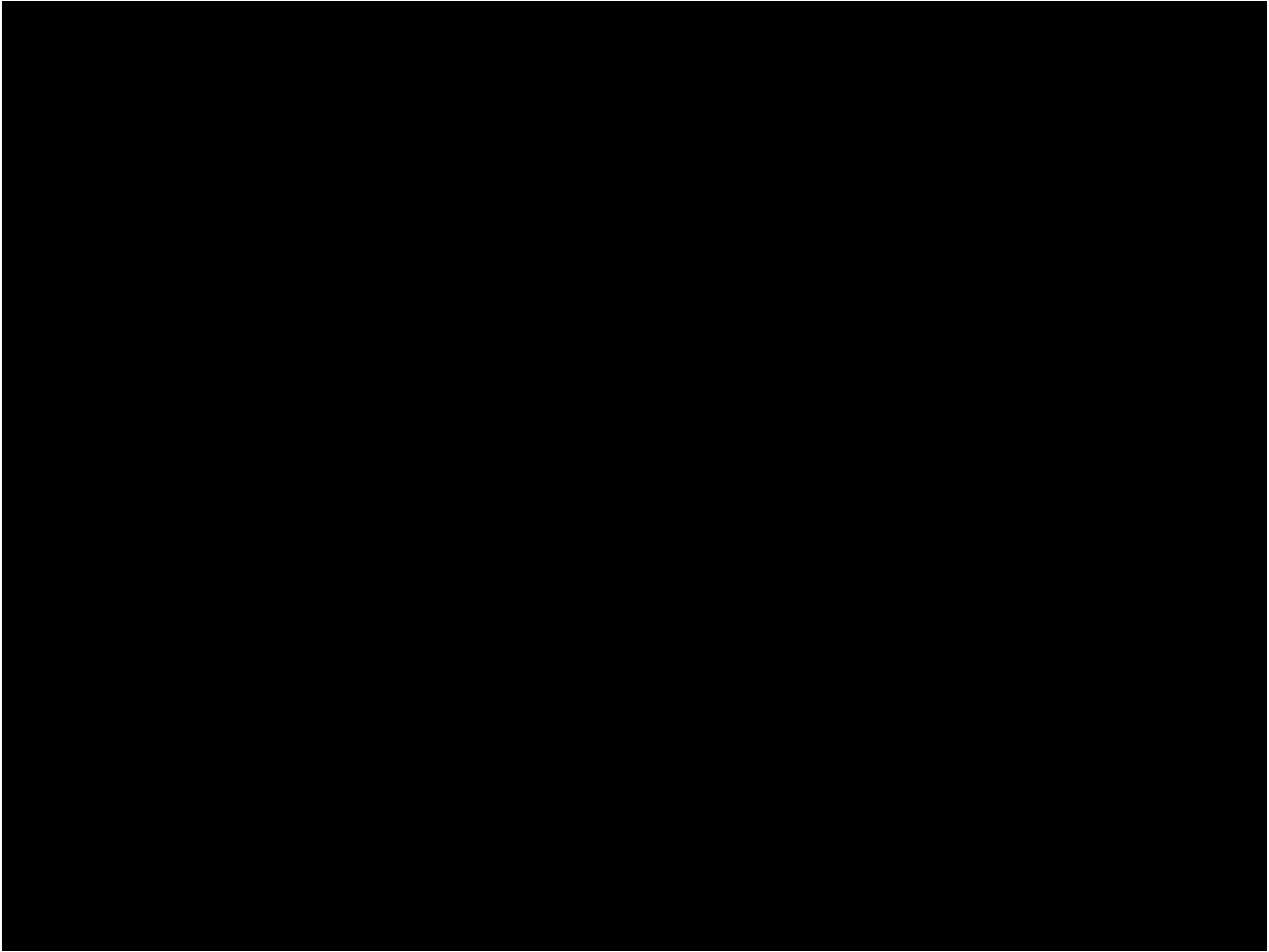

Route verified by: Sean Quinn

Date: 6/29/2021

Additional Emergency Telephone Contacts

WESTON Medical Emergency Service Dr. Peter Greaney, Medical Director WorkCare 300 South Harbor Blvd, Suite 600 Anaheim, California 92805	800-455-6155 Regular Business Hours (9AM to 7:30PM) Dial 0 or Ext. 175 for Michelle Bui to request the on-call clinician. 800-455-6155 After Hours (Weekdays 7:31PM to 8:59AM, Weekends, Holidays) Dial 3 to reach the after-hours answering service. Request that the service connect you with the on-call clinician or the on-call clinician will return your call within 30 minutes.
Chemtrec	800-424-9300
ATSDR	404-639-0615
ATF (explosives information)	800-424-9555
National Response Center	800-424-8802
National Poison Control Center	800-764-7661
Chemtel	800-255-3924
DOT	800-424-8802
CDC	800-232-0124

Pre-Response Approval

HASP prepared by: Sean Quinn

Date: 07/12/2021

Pre-Response/Entry Approval by: _____



Date: 07/12/2021

Tasks Conducted	Level of Protection/Specific PPE Used
Baseline air monitoring/sampling	Level C/D+: respirator and P100 cartridges/safety glasses/steel toe boots/Tyvek/N-95 face mask
Clean fill sampling	Level D+: safety glasses/steel toe boots/Tyvek/N-95 face mask
Excavations utilizing heavy equipment	Level C/D+: respirator and P100 cartridges/safety glasses/steel toe boots/Tyvek/N-95 face mask/ High Visibility Clothing/Hard Hats
Documentation/Post-excavation soil sampling	Level D+: safety glasses/steel toe boots/Tyvek/N-95 face mask

Hazardous Waste Site and Environmental Sampling Activities

Off Site: Yes No

On Site: Yes No

Describe types of samples and methods used to obtain samples:

All field sampling activities will be conducted in accordance with EPA's Environmental Response Team (ERT)/Scientific, Engineering, Response, and Analytical Services (SERAS) contractor's Standard Operating Procedure (SOP) Number (No.) 2001: *General Field Sampling Guidelines*.

Clean Fill Sampling:

Clean fill sampling for full TAL analyses will be performed in accordance with *NJDEP Site Remediation Program, Fill Material Guidance for SRP Sites* (April 2015). Clean fill samples will be collected from stockpiles located on the fill material vendor's facility. Up to two grab samples, including one field duplicate of clean fill for TAL VOCs analysis will be collected directly from sampling locations selected on each stockpile using three Encore™ samplers per sample. For all other analyses, clean fill samples will be collected with dedicated disposable plastic scoops, homogenized in plastic bags, and transferred to the appropriate sample containers for TAL SVOCs, TAL PCBs, TAL pesticides, herbicides, TAL metals including mercury, and cyanide, analyses. New nitrile gloves will be donned at each stockpile location. For quality control (QC) purposes, additional sample volumes designated for matrix spike/matrix spike duplicate (MS/MSD) analyses will be collected. All sample information will be entered into the Site-Specific Scribe sample management database from which chain of custody (COC) record and sample labels will be printed using the Scribe software.

Post-Excavation Soil Sampling for Radiochemistry Analyses:

Post-excavation soil sampling will be performed in accordance with EPA's ERT/SERAS contractor's SOP No. 2012: *Soil Sampling* and EPA's *Multi-Agency Radiation Survey and Site Investigation Manual* (MARSSIM). Excavation activities will be performed by a Weston heavy equipment operator. At a minimum, post-excavation soil samples will be collected at a frequency of one sidewall soil sample per 30 linear feet of the excavation perimeter and one bottom soil sample at a frequency of one per 900 square feet (sq. ft). Post-excavation samples will be collected using dedicated disposable scoops, and fresh nitrile gloves will be donned between each sampling location. Prior to sample collection at each location, the bottom of the scoop will be used to scrape each area of the sidewall and floor, in order to expose fresh soil which will then be collected, placed directly into re-sealable plastic bags, homogenized in the plastic bags, and then placed into polyurethane or glass sample containers. Since dedicated sampling equipment will be utilized, rinsate blank samples will not be required. The samples will be analyzed off-site at the assigned laboratory. Samples designated for laboratory analysis will be collected for definitive data and QA/QC purposes. All sample information will be entered into the Site-Specific Scribe sample management database from which a COC record and sample labels will be printed using the Scribe software. The post-excavation soil samples selected for laboratory analysis will be submitted to the assigned laboratory for confirmatory radiochemistry (gamma spectroscopy and alpha spectroscopy) analyses.

Air Sampling:

Baseline air sampling will be conducted prior to initiating intrusive Site activities (excavation). Air sampling will be conducted at each air monitoring station using RADēCO (Model H-810) volumetric air samplers calibrated by the manufacturer and equipped with replaceable filter media. Each air sampler contains a 2-inch filter holder with a RADēCO (0750-37) glass fiber air filter. The air samplers will be set to collect air filter samples at a flow rate of 5 cubic feet per minute (cfm) for a target volume of 2,400 cubic feet (cf) over an approximately 8-hour period. Each day, the air samplers will be calibrated using the RADēCO Air Calibrator (Model D-828) prior to being deployed. Calibration readings will be recorded using the RADēCO Model H-810 Calibration Functional Check Form F001 or documented in the Site logbook. Calibration forms/information will be reviewed and maintained on-site by the EPA Health Physicist (HP) prior to air sampler being used in the field.

Each RADēCO unit will be mounted on a tripod stand, powered with an electric generator, and positioned in an opposing wind direction. Air filter samples will be collected from perimeter air monitoring locations. All air filter samples collected will be placed in a glassine envelop before being placed in a re-sealable plastic bag. Air sampling information, including date, start and stop time, start and ending flow rates, and total volume will be entered into the Site-Specific Scribe sample management database from which sample labels and COC record will be generated using the Scribe software. The sample label will be placed on the re-sealable plastic bag for each air sample, and documentation associated with the samples, including COCs, will be kept with the samples until relinquished to the field measurement personnel.

This sampling design is based on information currently available and may be modified on-site in light of field screening results and other acquired information.

Was laboratory notified of potential hazard level of samples? Yes No

Note: The nature of the work assignment may require the use of the following procedures/programs which will be included as attachments to this Health and Safety Plan (HASP) as applicable: Emergency Response Plan and Spill Containment Program.

Disclaimer: This HASP was prepared for work to be conducted under the START V Contract 68HE0319D0004. Use of this HASP by WESTON and its subcontractors is intended to fulfill the OSHA requirements found in 29 CFR 1910.120. Items not specifically covered in this HASP are included by reference to 29 CFR 1910 and 1926.

The signatures below indicate that the individuals have read and understood this Health and Safety Plan.

PRINTED NAME	SIGNATURE	AFFILIATION	DATE
Keith Glenn		US EPA	07-13-2021

Post-Response Approval

Final Submission of HASP by:		Date:
Post Response Approval by:		Date:
START V HSO Review by:		Date:

Air Monitoring Summary Log

Date: / /

Data Collected by: _____

Station/Location	CGI / O₂ Meter / CL₂ / H₂S	Radiation Meter	PID	FID / TVA-1000	Other (<u>PDR</u>)

ATTACHMENT A

RADIUM, RADON, THORIUM & URANIUM FACT SHEETS



EPA Facts about Radium

What is radium?

Radium is a naturally occurring radioactive metal that exists as one of several isotopes. It is formed when uranium and thorium decay in the environment. In the natural environment, radium is found at low levels in soil, water, rocks, coal, plants, and food.

What are the uses of Radium?

In the early 1900s, radium was wrongly used to treat rheumatism and mental disorders and as a general tonic. Radium was also used to make luminous paints for watch dials, clocks, glow in the dark buttons, and military instruments. The use of radium for these purposes was discontinued because of the health hazards from these types of exposures. Radium has also been widely used in radiation treatment of cancer, but this use has largely been replaced by other radioactive materials or methods. Radium-226 has also been used in medical equipment, gauges, and calibrators, and in lightning rods. Alpha emitters such as radium and plutonium can be used as components of a neutron generator.

How does radium change in the environment?

Radium is not a stable element. As radium decays, it releases radiation and forms decay products. Like radium, many of these decay products also release radiation and form other elements. The decay process continues until a stable, nonradioactive decay product is formed.

Radiation is released during the decay process in the form of alpha particles, beta particles, and gamma radiation. Alpha particles can travel only short distances and cannot penetrate human skin. Beta particles are generally absorbed in the skin and do not pass through the entire body. Gamma radiation, however, can penetrate the body.

Isotopes of radium decay to form radioactive isotopes of radon gas. The time required for a radioactive substance to lose 50 percent of its radioactivity by decay is known as the half-life. The half lives are 3.5 days for radium-224, 1,600 years for radium-226, and 6.7 years for radium-228, the most common isotopes of radium, after which each forms an isotope of radon. Radon is known to accumulate in homes and buildings.

How are people exposed to radium?

Since radium is present at relatively low levels in the natural environment, everyone has some level of exposure from it. However, individuals may be exposed to higher levels of radium and its associated external gamma radiation if they live in an area where there is an elevated level of radium in soil. In addition, radium is particularly hazardous because it continuously produces radon, which can diffuse into nearby homes.

An individual can be exposed to radium through contact with waste from ore at former radium processing facilities, former radium dial facilities, or radium dials. In addition, exposure to radium can occur if radium is released into the air from burning coal or other fuels, or if drinking water

taken from a source that is high in natural radium is used. Individuals may also be exposed to higher levels of radium if they work in a mine or in a plant that processes ores. Phosphate rocks, which can contain relatively high levels of uranium and radium, are also a potential source of exposure. The concentration of radium in drinking water is generally low, but there are specific geographic regions in the United States where higher concentrations of radium may occur as a result of geologic sources.

Radium exposure therefore can be from gamma radiation from radium decay products, lung exposure from radon gas and its decay products, and inhalation and ingestion exposure.

How does radium get into the body?

Radium can enter the body when it is inhaled or swallowed. Radium breathed into the lungs may remain there for months; but it will gradually enter the blood stream and be carried to all parts of the body, with a portion accumulating in the bones.

If radium is swallowed in water or with food, most of it (about 80 percent) will promptly leave the body in the feces. The other 20 percent will enter the blood stream and be carried to all parts of the body. Some of this radium will then be excreted in the feces and urine on a daily basis; however, a portion will remain in the bones throughout the person's lifetime.

Is there a medical test to determine exposure to radium?

Urinalysis and bone biopsy tests are sometimes used to determine if individuals have ingested a source of radioactivity such as radium. Radon, a

decay product of radium, can also be measured in air that is exhaled from the body. Another technique, gamma spectroscopy, can measure the amount of radioactivity in portions of the body. These tests require special equipment and cannot be done in a doctor's office. There is no test that can detect external exposure to radium's gamma radiation alone.

How can radium affect people's health?

Exposure to radium over a long period may result in many different harmful effects. If inhaled as dust or ingested as a contaminant, risk is increased for several diseases, including lymphoma, bone cancer, and hematopoietic (blood-formation) diseases, such as leukemia and aplastic anemia. These effects take years to develop. If exposed externally to radium's gamma radiation, risk of cancer is increased in essentially all tissues and organs, though to varying degrees. However, in the environment, the greatest risk associated with radium is actually posed by its direct decay product radon. Radon has been shown to cause lung cancer.

What recommendations has the U.S. Environmental Protection Agency made to protect human health?

Please note that the information in this section is limited to recommendations EPA has made to protect human health from exposure to radium. General recommendations EPA has made to protect human health at Superfund sites (the 10^{-4} to 10^{-6} cancer risk range), which cover all radionuclides including radium, are summarized in the fact sheet "Primer on Radionuclides Commonly Found at Superfund Sites."

For uranium mill tailing sites with radium contamination, EPA has established a radium level of 5 picoCuries per gram (pCi/g) above background as a protective health-based level for cleanup of soil in the top 15 centimeters. These regulations under 40 Code of Federal Regulations (CFR) Part 192.12 are often Applicable or Relevant and Appropriate Requirements (ARARs) at Superfund sites. The EPA document “Use of Soil Cleanup Criteria in 40 CFR Part 192 as Remediation Goals for CERCLA Sites” provides guidance to EPA staff regarding when the use of 5 picoCuries per gram (pCi/g) is an ARAR or otherwise recommended cleanup level for any 15 centimeters of subsurface radium-contaminated soil other than the first 15 centimeters. This document is available online at:

<http://www.epa.gov/superfund/health/contaminants/radiation/pdfs/umtrcagu.pdf>.

If regulations under 40 CFR Part 192.12 are an ARAR for radium in soil at a Superfund site, then Nuclear Regulatory Commission regulations for uranium mill tailing sites under 10 CFR Part 40 Appendix A, I, Criterion 6(6), may be an ARAR at the same site. Criterion 6(6) requires that the level of radiation, called a “benchmark dose,” that an individual would receive be estimated after that site was cleaned up to the radium soil regulations under 40 CFR Part 192.12. This benchmark dose then becomes the maximum level of radiation that an individual may be exposed to from all radionuclides, except radon, in both the soil and buildings at the site. The EPA document “Remediation Goals for Radioactively Contaminated CERCLA Sites Using the Benchmark Dose Cleanup Criterion 10 CFR Part 40 Appendix A, I, Criterion 6(6)” provides

guidance to EPA staff regarding how Criterion 6(6) should be implemented as an ARAR at Superfund sites, including using a radium soil cleanup level of 5 pCi/g in both the surface and subsurface in estimating a benchmark dose. This document is available online at:

<http://www.epa.gov/superfund/health/contaminants/radiation/pdfs/part40.pdf>.

EPA has established a Maximum Contaminant Level (MCL) of 5 picoCuries per liter (pCi/L) for any combination of radium-226 and radium-228 in drinking water. EPA has also established a MCL of 15 pCi/L for alpha particle activity, excluding radon and uranium, in drinking water. Radium-226 is covered under this MCL.

For more information about how EPA addresses radium at Superfund sites

Contact Stuart Walker of EPA:

(703) 603-8748 or walker.stuart@epa.gov,

or visit EPA’s Superfund Radiation Webpage:

<http://www.epa.gov/superfund/resources/radiation/>

BASIC RADON FACTS

The U.S. Surgeon General recommends ALL homes be tested for radon gas.

Breathing radon in your home can cause lung cancer

Radon is a naturally occurring radioactive gas released in rock, soil and water that can build up to dangerous levels inside any home; this means new and old homes, well sealed and drafty homes, and homes with or without a basement. Radon gas is odorless and invisible and the only way to know if your home has a radon problem is to test for it.

Breathing radon can increase your risk of lung cancer. Radon is the number one cause of lung cancer among people who do not smoke. It is the second leading cause of lung cancer for people who do. EPA estimates that radon causes more than 20,000 deaths from lung cancer each year in the U.S. If you smoke and your home has a high radon level, your risk of lung cancer can increase even more.

Radon has been found in every state

Homes with high levels of radon have been found in every state. In fact, radon levels can vary greatly from home to home--even levels next door can be very different.

Radon is measured in picocuries per liter of air (pCi/L), a measurement of radioactivity. In the United States, the average indoor radon level is about 1.3 pCi/L. The average outdoor level is about 0.4 pCi/L. The U.S. Surgeon General and EPA recommend fixing homes with radon levels at or above 4 pCi/L. EPA also recommends that people think about fixing their homes for radon levels between 2 pCi/L and 4 pCi/L.

You should test for radon

Testing your house for radon is easy. If your house has a radon problem, it can be fixed. Fixing a radon problem reduces the risk of lung cancer for you and your family.

A simple test will tell you if your home has a high radon level. Most radon tests last between 2 and 7 days. It's as easy as opening a package, and putting the test kit in the right place. After sending the test kit back to the address in the package, the company will send your radon test results in about 2 weeks.

Radon is a serious health risk. It can be reduced easily and cost-effectively. Take action today. Encourage your friends and family members to do the same!

Many local home improvement or hardware stores sell test kits. Test kits can be ordered online too. Sometimes you can get a test kit from your state radon office. You also can hire a qualified tester to do a radon test for you. Your state radon program may keep a list of these professionals.

Kansas State University, under a cooperative agreement with EPA, provides national radon program services, including selling radon test kits and answering toll-free radon hotlines. For more information about radon testing call 1-800-SOS-RADON (1-800-767-7236) or visit <https://www.epa.gov/radon/find-radon-test-kit-or-measurement-and-mitigation-professional>.

You can fix a radon problem

Help is available to fix a radon problem. You can call your state radon office to find qualified radon mitigators in your area. Also local companies with radon mitigators are in the phone book or online. The cost to reduce radon depends on how your home was built and how you use it. Most homes can be fixed for about the same cost as other common home repairs.

New homes can be built with radon-resistant features

Building new homes with simple and cost-effective radon-resistant features can reduce radon entry. Contact your builder or visit <https://www.epa.gov/radon/radon-resistant-construction-basics-and-techniques> for more information.

Every home should be tested before, or soon after, you move in. Even homes built with radon-resistant construction features should be tested. If high radon levels are found, it is easier and costs less to reduce radon levels in homes that are built radon-resistant.

The space below can be used for local contact or business information.

	Place Logo Here
--	-----------------

How to Get Radon Test Kits

To get an easy-to-use radon test kit, you can:

- Buy a test kit online or at your local home improvement or hardware store. Many kits are priced under \$25.00.
- Order a test kit at www.sosradon.org or by calling 1-800-SOS-RADON (1-800-767-7236).
- Request a test kit from your state radon program, which also has information on radon testing companies and laboratories in your area. Visit <https://www.epa.gov/radon/find-information-about-local-radon-zones-and-state-contact-information>.



EPA Facts about Thorium

What is thorium?

Thorium is a naturally occurring radioactive metal that is found at low levels in soil, rocks, water, plants, and animals. Almost all naturally occurring thorium exists in the form of either radioactive isotope thorium-232, thorium-230, and thorium-228. There are more than 10 other thorium isotopes that can be artificially produced. Smaller amounts of these isotopes are usually produced as decay products of other radionuclides and as unwanted products of nuclear reactions.

What are the uses of thorium?

Thorium is used to make ceramics, lantern mantles, welding rods, camera and telescope lenses, and metals used in the aerospace industry.

How does thorium change in the environment?

Thorium-232 is not a stable isotope. As thorium-232 decays, it releases radiation and forms decay products that include radium-228 and thorium-228. The decay process continues until a stable, nonradioactive decay product is formed. In addition to thorium-232, thorium-228 is present naturally in background. Thorium-228 is a decay product of radium-228, and thorium-228 decays into radium-224.

The radiation from the decay of thorium and its decay products is in the form of alpha and beta particles and gamma radiation. Alpha particles

can travel only short distances and cannot penetrate human skin. Beta particles are generally absorbed in the skin and do not pass through the entire body. Gamma radiation, however, can penetrate the body.

The time required for a radioactive substance to lose 50 percent of its radioactivity by decay is known as the half-life. The half-life of thorium-232 is very long at about 14 billion years. As a result of the extremely slow rate of decay, the total amount of natural thorium in the earth remains fairly constant, but it can be moved from place to place by natural processes and human activities.

How are people exposed to thorium?

Since thorium is present at very low levels almost everywhere in the natural environment, everyone is exposed to it in air, food, and water. Normally, very little of the thorium in lakes, rivers, and oceans is absorbed by the fish or seafood that a person eats. The amounts in the air are usually small and do not constitute a health hazard.

Exposure to higher levels of thorium may occur if a person lives near an industrial facility that mines, mills, or manufactures products with thorium.

Thorium-232 on the ground is of a health risk because of the rapid build-up of radium-228 and its associated gamma radiation. Thorium-232 is typically present with its decay product radium-224, which will produce radon-220 gas, also known as thoron, and its decay products that result in lung exposure. Thorium-230 is part of

the uranium-238 decay series. Thorium- 230 is typically present with its decay product radium-226, and it is therefore a health risk from gamma radiation from radium-226 decay products, lung exposure from radon-222 gas and its decay products, and inhalation and ingestion exposure.

How does thorium get into the body?

Thorium can enter the body when it is inhaled or swallowed. In addition, radium can come from thorium deposited in the body. Thorium enters the body mainly through inhalation of contaminated dust. If a person inhales thorium into the lungs, some may remain there for long periods of time. In most cases, the small amount of thorium left in the lungs will leave the body in the feces and urine within days.

If thorium is swallowed in water or with food, most of it will promptly leave the body in the feces. The small amount of thorium left in the body will enter the bloodstream and be deposited in the bones, where it may remain for many years.

Is there a medical test to determine exposure to thorium?

Special tests that measure the level of radioactivity from thorium or thorium isotopes in the urine, feces, and exhaled air can determine if a person has been exposed to thorium. These tests are useful only if administered within a short period of time after exposure. They require special equipment and cannot be done in a doctor's office.

How can thorium affect people's health?

Studies of workers have shown that inhaling thorium dust will cause an increased risk of developing lung disease, including lung cancer, or pancreatic cancer. Liver disease and some types of cancer have been found in people injected in the past with thorium to take special X-rays. Bone cancer is also a potential health effect through the storage of thorium in the bone.

What recommendations has the U.S. Environmental Protection Agency made to protect human health?

Please note that the information in this section is limited to recommendations EPA has made to protect human health from exposure to thorium. General recommendations EPA has made to protect human health at Superfund sites (the 10^{-4} to 10^{-6} cancer risk range), which cover all radionuclides including thorium, are summarized in the fact sheet "Primer on Radionuclides Commonly Found at Superfund Sites."

For uranium mill tailing sites, EPA has established 5 picoCuries per gram (pCi/g) of radium as a protective health based level for cleanup of the top 15 centimeters of soil. Since thorium decays into radium, these regulations for radium under 40 Code of Federal Regulations (CFR) Part 192.12 have often been used as Applicable or Relevant and Appropriate Requirements (ARARs) at Superfund sites for thorium-contaminated soil. The EPA document "Use of Soil Cleanup Criteria in 40 CFR Part 192 as Remediation Goals for CERCLA Sites" provides guidance to EPA staff regarding when 5 pCi/g of

thorium is an ARAR or otherwise recommended cleanup level for any 15 centimeters of subsurface soil contaminated by thorium other than the first 15 centimeters. This document is available online at:

<http://www.epa.gov/superfund/health/contaminants/radiation/pdfs/umtrcagu.pdf>.

If regulations under 40 CFR Part 192.12 are an ARAR for radium in soil at a Superfund site, then Nuclear Regulatory Commission (NRC) regulations for uranium mill tailing sites under 10 CFR Part 40 Appendix A, I, Criterion 6(6), may be an ARAR at the same site.

Criterion 6(6) requires that the level of radiation, called a “benchmark dose,” that an individual would receive be estimated after that site was cleaned up to the radium soil regulations under 40 CFR Part 192.12. This benchmark dose then becomes the maximum level of radiation that an individual may be exposed to from all radionuclides, except radon, in both the soil and buildings at the site. The EPA document “Remediating Goals for Radioactively Contaminated CERCLA Sites Using the Benchmark Dose Cleanup Criterion 10 CFR Part 40 Appendix A, I, Criterion 6(6)” provides guidance regarding how Criterion 6(6) should be implemented as an ARAR at Superfund sites, including using a radium soil cleanup level of 5 pCi/g in both the surface and subsurface when estimating a benchmark dose. This document is available online at:

<http://www.epa.gov/superfund/health/contaminants/radiation/pdfs/part40.pdf>.

EPA has established a Maximum Contaminant Level (MCL) of 15 picoCuries per liter (pCi/L) for alpha particle activity, excluding radon and

uranium, in drinking water. Thorium is covered under this MCL.

For more information about how EPA addresses thorium at Superfund sites

Contact Stuart Walker of EPA:

(703) 603-8748 or walker.stuart@epa.gov,

or visit EPA’s Superfund Radiation Webpage:

<http://www.epa.gov/superfund/resources/radiation/>

the 1990s, the number of people with a mental health problem has increased in the UK (Mental Health Act 1983, 1990).

There is a growing awareness of the need to improve the lives of people with mental health problems. The Department of Health (1999) has set out a vision of a new mental health system, which will be based on the following principles:

- People with mental health problems should be treated as individuals, with their own needs and wishes.
- People with mental health problems should be given the opportunity to participate in decisions about their care and treatment.
- People with mental health problems should be given the opportunity to live as fully as possible in their own homes and communities.

There is a growing awareness of the need to improve the lives of people with mental health problems.

The Department of Health (1999) has set out a vision of a new mental health system, which will be based on the following principles:

- People with mental health problems should be treated as individuals, with their own needs and wishes.
- People with mental health problems should be given the opportunity to participate in decisions about their care and treatment.
- People with mental health problems should be given the opportunity to live as fully as possible in their own homes and communities.

There is a growing awareness of the need to improve the lives of people with mental health problems.

The Department of Health (1999) has set out a vision of a new mental health system, which will be based on the following principles:

- People with mental health problems should be treated as individuals, with their own needs and wishes.
- People with mental health problems should be given the opportunity to participate in decisions about their care and treatment.
- People with mental health problems should be given the opportunity to live as fully as possible in their own homes and communities.

There is a growing awareness of the need to improve the lives of people with mental health problems.

The Department of Health (1999) has set out a vision of a new mental health system, which will be based on the following principles:

- People with mental health problems should be treated as individuals, with their own needs and wishes.
- People with mental health problems should be given the opportunity to participate in decisions about their care and treatment.
- People with mental health problems should be given the opportunity to live as fully as possible in their own homes and communities.



EPA Facts about Uranium

What is uranium?

Uranium is a radioactive metal that is present in low amounts in rocks, soil, water, plants, and animals. Uranium and its decay products contribute to low levels of natural background radiation in the environment. Significant concentrations of uranium occur naturally in some substances such as phosphate deposits and uranium-enriched ores.

How does uranium change in the environment?

Natural uranium is found in the environment in three forms, called isotopes: uranium-234, uranium-235, and uranium-238. Ninety-nine percent of natural uranium occurring in rock is uranium-238. Uranium-235 accounts for just 0.72 percent of natural uranium, but it is more radioactive than uranium-238. Uranium-234 is the least abundant uranium isotope in rock.

Uranium is not a stable element. As uranium decays, it releases radiation and forms decay products. Uranium-238 decay products include uranium-234, radium-226, and radon-222. See “EPA Facts about Radon and Radium” for additional information on these radionuclides.

Natural uranium releases alpha particles and low levels of gamma rays. Alpha particles can travel only short distances and cannot penetrate human skin. Gamma radiation, however, can penetrate the body.

The time required for a radioactive substance to lose 50 percent of its radioactivity by decay is

known as the half-life. The half-life for uranium-238 is about 4.5 billion years, uranium-235 is 710 million years, and uranium-234 is 250,000 years. Because of the slow rate of decay, the total amount of natural uranium in the earth stays almost the same, but radionuclides can move from place to place through natural processes or by human activities. Rain can wash soil containing uranium into rivers and lakes. Mining, milling, manufacturing, and other human activities also release uranium to the environment.

What are the uses of uranium?

Uranium-235 is used in nuclear weapons and nuclear reactors. Depleted uranium (natural uranium in which almost all of the uranium-235 has been removed) is used to make ammunition for the military, guidance devices and compasses, radiation shielding material, and X-ray targets. Uranium dioxide is used to extend the lives of incandescent lamps used for photography and motion pictures. Very small amounts of other uranium compounds are used in photography for toning, in the leather and wood industries for stains and dyes, and in the wool industries. Uranium has also been used in the past in ceramics as a coloring agent.

How are people exposed to uranium?

Uranium-238 and members of its decay chain, which include uranium-234, radium-226, and radon-220, are present in nature. The members of the decay chain in undisturbed soil are present, often at concentrations that approximate that of the parent uranium-238.

Uranium ore contains all the daughter elements of uranium-238 and uranium-235, but the uranium-238, uranium-234, and uranium-235 are extracted and chemically separated during processing. This concentrated uranium product, which is generated at uranium mill tailing sites and uranium processing facilities, is a potential source of exposure to individuals and the environment and is a primary concern for cleanup of these sites. Potential individual exposure at these sites may be from different pathways, but the groundwater pathway is of particular concern because of the mobility of uranium.

How does uranium get into the body?

Uranium can enter the body when it is inhaled or swallowed or through cuts in the skin. About 99 percent of the uranium ingested in food or water will leave a person's body in the feces, and the remainder will enter the blood. Most of this uranium will be removed by the kidneys and excreted in the urine within a few days. A small amount of the uranium in the bloodstream will be deposited in a person's bones, where it will remain for several years.

Alpha particles released by uranium cannot penetrate the skin, so natural uranium that is outside the body is less harmful than that which is inhaled, swallowed, or enters through the skin. When uranium gets inside the body, radiation and chemical damage can lead to cancer or other health problems, including kidney damage.

Is there a medical test to determine exposure to uranium?

Tests are available to measure the amount of uranium in a urine or stool sample. These tests are useful if a person is exposed to a larger-than-normal amount of uranium, because most uranium leaves the body in the feces within a few days. Uranium can be found in the urine for up to several months after exposure. However, the amount of uranium in the urine and feces does not always accurately show the level of uranium exposure. Since uranium is known to cause kidney damage, urine tests are often used to determine whether kidney damage has occurred.

How can uranium affect people's health?

In addition to the risks of cancer posed by uranium and all other radionuclides, uranium is associated with noncancer effects, and the major target organ of uranium's chemical toxicity is the kidney. Radioactivity is a health risk because the energy emitted by radioactive materials can damage or kill cells. The level of risk depends on the level of uranium concentration.

What recommendations has the U.S. Environmental Protection Agency made to protect human health?

Please note that the information in this section is limited to recommendations EPA has made to protect human health from exposure to uranium. General recommendations EPA has made to protect human health at Superfund sites (the 10^{-4} to 10^{-6} cancer risk range), which cover all radionuclides including uranium, are

summarized in the fact sheet “Primer on Radionuclides Commonly Found at Superfund Sites.”

EPA has established a Maximum Contaminant Level (MCL) of 30 micrograms per liter ($\mu\text{g}/\text{liter}$) for uranium in drinking water. For uranium mill tailing sites, EPA has established 30 picoCuries per liter (pCi/L) for uranium-234 and -238 as standards for protecting groundwater. The EPA document "Use of Uranium Drinking Water Standards under 40 CFR 141 and 40 CFR 192 as Remediation Goals for Groundwater at CERCLA Sites" provides guidance regarding how these two standards should be implemented as an Applicable or Relevant and Appropriate Requirement (ARAR) at Superfund sites. This document is available online at:

http://www.epa.gov/superfund/health/contaminants/radiation/pdfs/9283_1_14.pdf.

Also for uranium mill tailing sites, EPA has established 5 picoCuries per gram (pCi/g) of radium as a protective health-based level for the cleanup of the top 15 centimeters of soil. These regulations under 40 Code of Federal Regulations (CFR) Part 192.12 are often ARARs at Superfund sites. The EPA document “Use of Soil Cleanup Criteria in 40 CFR Part 192 as Remediation Goals for CERCLA Sites” provides guidance to EPA staff regarding when 5 pCi/g is an ARAR or otherwise recommended cleanup level for any 15 centimeters of subsurface soil contaminated by radium other than the first 15 centimeters. This document is available online at:

<http://www.epa.gov/superfund/health/contaminants/radiation/pdfs/umtrcagu.pdf>.

If regulations under 40 CFR Part 192.12 are an ARAR for radium in soil at a Superfund site, then Nuclear Regulatory Commission (NRC) regulations for uranium mill tailing sites under 10 CFR Part 40 Appendix A, I, Criterion 6(6), may be an ARAR at the same site, particularly if uranium-234 or uranium-238 is a contaminant at the site.

Criterion 6(6) requires that the level of radiation, called a “benchmark dose,” that an individual would receive be estimated after that site was cleaned up to the radium soil regulations under 40 CFR Part 192.12. This benchmark dose then becomes the maximum level of radiation that an individual could be exposed to from all radionuclides, except radon, in both the soil and buildings at the site. The EPA document “Remediating Goals for Radioactively Contaminated CERCLA Sites Using the Benchmark Dose Cleanup Criterion 10 CFR Part 40 Appendix A, I, Criterion 6(6)” provides guidance regarding how Criterion 6(6) should be implemented as an ARAR at Superfund sites, including using a radium soil cleanup level of 5 pCi/g in both the surface and subsurface when estimating a benchmark dose. This document is available online at:

<http://www.epa.gov/superfund/health/contaminants/radiation/pdfs/part40.pdf>.

For more information about how EPA addresses uranium at Superfund sites

Contact Stuart Walker of EPA:

(703) 603-8748 or walker.stuart@epa.gov,

or visit EPA's Superfund Radiation Webpage:

<http://www.epa.gov/superfund/resources/radiation/>

ATTACHMENT B

WESTON FLDS

	Weston Solutions, Inc.		Doc No:	FLD01-0411
			Initial Issue Date:	April 2011
FLD01 Occupational Noise and Hearing Conservation Program			Revision Date:	Initial Version
			Revision No.:	0
Preparation: CEHS			Next Revision Date:	Annual Review
			Authority: CEHS Director	Issuing Dept: CEHS

7.0 OCCUPATIONAL NOISE AND HEARING CONSERVATION PROGRAM

Noise can cause sudden traumatic temporary or permanent hearing loss, long-term slowly occurring sensory-neural and irreversible hearing loss, disruption of communication, and masking of warning devices and alarms. Additional concerns include increased stress levels and effects on the cardiovascular and nervous systems. This Program describes the process for controlling, reducing, and minimizing noise exposure.

WESTON's OMP will assist in compliance with this Program through evaluation of clinics, verification of baseline exams, and employee audiogram evaluation. The OMP will advise the appropriate Safety Officer and, if necessary, the CEH&S Director of any problems associated with medical compliance or occupationally related hearing loss in workers.

The need for noise-monitoring equipment, noise dosimeters or hearing protection devices must be addressed in the planning stages of a project. Some of the sources of noise at hazardous materials sites, demolition operations, construction and industrial sites which can cause hearing damage are: earth moving equipment (front end loader, bull dozer), material handling equipment (cranes, industrial trucks), power units (compressors, generators drill rig engines), impact devices (pile drivers, chipping hammers), and other powered devices (saws, needle guns, drills, vibrating equipment).

7.1 NOISE EVALUATION AND SURVEILLANCE PROCEDURES

OSHA in 29 CFR 1910.95, establishes a PEL, time weighted average (TWA) of 90 dBA for an 8-hour work day and a TWA of 85 dBA as the trigger point (action level or AL) for establishing a Hearing Conservation Program (HCP). The HCP includes baseline and annual hearing tests, and hearing conservation training.

Noise exposure can also be compared to the American Conference of Governmental Industrial Hygienists (ACGIH) Threshold Limit Value (TLV). The TLVs for noise are arranged in a scale in dBs related to time periods. For an 8-hour work period the TWA TLV is 85 dBA, and the AL is 80 dBA. The ACGIH numbers are more conservative and realistically reflect current scientific knowledge on the human effects from noise exposure. Therefore, WESTON will use the ACGIH TLVs and Guidance and the 3 dB exchange rate as the basis for WESTON's HCP to provide a higher level of protection for our employees than that offered by compliance with the OSHA requirements which are several dB higher.

Noise exposure assessment is performed only by qualified personnel with properly calibrated and functional noise measuring equipment. If the HASP or the FSO indicates that the site, or activity, requires an instrumentation survey then the area will be screened with an A-weighted sound level meter (Area Monitoring). If deemed necessary a more in depth evaluation utilizing a noise dosimeter may be performed (Personnel Monitoring). Both types of monitoring, if needed, will be accomplished in accordance with requirements established in 29 CFR 1910.95(d).

In the absence of sound level measuring instrumentation, any noise preventing normal vocal discussion between two individuals at arm's length distance ("arms-length rule") will dictate the need for hearing protection. WESTON guidelines require the use of hearing protection on an immediate basis under the "arms-length rule". Exceptions may be granted based upon evaluation of a specific task and duration with consultation with an industrial hygienist.

	Weston Solutions, Inc.		Doc No:	FLD01-0411
			Initial Issue Date:	April 2011
FLD01 Occupational Noise and Hearing Conservation Program			Revision Date:	Initial Version
			Revision No.:	0
			Next Revision Date:	Annual Review
Preparation: CEHS	Authority: CEHS Director	Issuing Dept: CEHS	Page:	Page 2 of 5

Long-term work efforts at fixed locations (e.g., water treatment plants, incinerators) require an evaluation of noise levels. Re-monitoring may be necessary when changes in equipment, processes, or activities result in modification of the noise level.

If impact noise is present, the peak noise levels and the frequency of the impacts should be determined. OSHA and AGCIH recommendations and/or qualified personnel should be consulted if questions arise regarding impact or impulse noise.

7.2 NOISE CONTROL METHODS

Engineering Controls

The primary means of reducing or eliminating personnel exposure to noise is through engineering controls. Engineering controls are defined as any modification or replacement of equipment, or related physical change at the noise source or along the sound transmission path that will reduce the noise level to the employee's ear. Engineering controls include items such as; mufflers on heavy equipment or motors, sound baffles, and enclosures.

Administrative Controls

Administrative controls may include changes in the work schedule or operations to reduce noise exposure, increasing worker distance from the noise source, and rotation of jobs to reduce time limits of exposure. Administrative time control is not a preferable method for preventing noise exposure since extreme noise for a short duration can cause severe, permanent hearing loss. Administrative controls may be utilized in accordance with the TLV Table ACGIH TLVs and Biological Exposure Indices (BEIs), 2007 Edition. Administrative controls may not be utilized for exposures greater than 100 dBA, regardless of the exposure time.

Hearing Protection

Hearing protection devices are utilized whenever engineering controls prove to be infeasible or cost prohibitive. Various types of ear muffs and ear plugs are available. Hearing protector attenuation is intended to reduce employee exposures below 80 dBA for employees with standard threshold shifts and below 85 dBA for all other employees.

WESTON personnel and WESTON subcontractors must wear hearing protection devices (HPDs) when required and where signs are posted requiring their use. Hearing protection devices are strongly recommended in any noisy environment, but are mandatory in the following situations:

- The 8-hour average may equal or exceed 85 dBs.
- Any employee exposed to greater than or equal to 85 dBs and who have experienced a standard threshold shift in their hearing.
- Any noise equal to greater than 100 dBs impact, continuous or intermittent.
- Anywhere a "HEARING PROTECTION REQUIRED" sign is posted. These signs are to be posted in all mandatory situations listed above.

	Weston Solutions, Inc.		Doc No:	FLD01-0411
			Initial Issue Date:	April 2011
FLD01 Occupational Noise and Hearing Conservation Program			Revision Date:	Initial Version
			Revision No.:	0
			Next Revision Date:	Annual Review
Preparation: CEHS	Authority: CEHS Director	Issuing Dept: CEHS	Page:	Page 3 of 5

In addition when noise levels equal or exceed 80 dBA employees must have:

- Availability of hearing protectors.
- Information and training on effects of noise.
- Availability of audiometric testing where there is a risk to health.

Not all hearing protection devices have the same noise reduction rating (NRR). Verification of all NRR values must be made by referring to the manufacturers' specifications. The proper hearing protection is selected using results from a properly calibrated sound level meter in accordance with ACGIH TLVs and BEIs, 2007 Edition.

Additional information regarding the selection, use, maintenance, and control of hearing protection devices is provided in the WESTON Personal Protective Equipment Program (Section 5.0).

NRR will be adjusted using the following to estimate the attenuation afforded to a noise-exposed employee in a work environment by muffs, plugs, or a combination of both:

Single Protection

A common formula used to estimate exposure for **single protection** (either muffs or plugs) follows:

1. Determine the laboratory-based noise attenuation provided by the HPD. This is referred to as the NRR and is listed on the packaging.
2. Subtract the NRR from the C-weighted TWA workplace noise level, as follows:

$$\text{Estimated Exposure (dBA)} = \text{TWA (dBC)} - \text{NRR}$$

If C-weighted noise level data are not available, A-weighted data can be used by subtracting a 7 dB correction factor from the NRR, as follows:

$$\text{Estimated Exposure (dBA)} = \text{TWA (dBA)} - (\text{NRR} - 7)$$

Example:

TWA=100 dBA, muff NRR=19 dB

Estimated Exposure = 100 - (19-7) = 88 dBA

Dual Protection

A common formula used to estimate exposure for **dual protection** (ear muffs and plugs are used simultaneously) follows:

1. Determine the laboratory-based NRR for the **higher** rated protector (NRR_h).
2. Subtract 7 dB from NRR_h if using A-weighted sound level data.
3. Add 5 dB to the field-adjusted NRR to account for the use of the second hearing protector.

	Weston Solutions, Inc.		Doc No:	FLD01-0411
			Initial Issue Date:	April 2011
FLD01 Occupational Noise and Hearing Conservation Program			Revision Date:	Initial Version
			Revision No.:	0
			Next Revision Date:	Annual Review
Preparation: CEHS	Authority: CEHS Director	Issuing Dept: CEHS	Page:	Page 4 of 5

4. Subtract the remainder from the TWA as follows:

Estimated Exposure (dBA) = TWA (dBC) - (NRR_h + 5) or

Estimated Exposure (dBA) = TWA (dBA) - [(NRR_h - 7) + 5]

Example:

TWA=110 dBA, plug NRR=29, and muff NRR=25 dB

Estimated Exposure = 110 - [(29 - 7) + 5] = 83 dBA

7.3 MEDICAL SURVEILLANCE

Compliance with the HCP is required when an employee's exposure to noise is in excess of 85 dBA. Employees who work with drill rigs, heavy construction equipment, or noisy client operations are candidates for the HCP and medical surveillance requirements thereof. Supervisors of any employees who do not meet these categories but who work around excessive noise (e.g., treatment plant operations, print shop, maintenance personnel) must perform noise surveys to determine the need for those employees to participate in the HCP, and advise the safety officer who will notify the OMP.

WESTON's OMP will make the final determination of employee involvement in the medical surveillance component of the HCP. Audiometric testing is performed annually to evaluate the hearing of all individuals who are routinely exposed to 8-hour TWA exposures of 85 dBA or greater (including compliance with the "arms-length rule"). WESTON's OMP is responsible for assuring local clinic compliance with the audiometric testing component of the standard.

7.4 TRAINING

Training is regularly provided during WESTON's initial and refresher courses under 29 CFR 1910.120 (HAZWOPER). Alternative training will be given to employees who are included in the HCP but are not required to have HAZWOPER training. Initial and annual training shall be given to each employee included in the HCP and address the following:

- The effects of noise on hearing.
- The purpose of hearing protection, advantages, disadvantages, attenuation of various types, and the selection, fitting, use, and care of protectors.
- The purpose of audiometric tests and explanation of test procedures.
- Recognition of hazardous noise.

7.5 PROGRAM EVALUATION

Periodic program evaluations will be conducted to assess compliance with 29 CFR 1910.95. WESTON's OMP is responsible for assisting in this evaluation by providing information relative to employee exposure and medical surveillance data.

	Weston Solutions, Inc.		Doc No:	FLD01-0411
			Initial Issue Date:	April 2011
FLD01 Occupational Noise and Hearing Conservation Program			Revision Date:	Initial Version
			Revision No.:	0
			Next Revision Date:	Annual Review
Preparation: CEHS	Authority: CEHS Director	Issuing Dept: CEHS	Page:	Page 5 of 5

7.6 RECORDKEEPING

Employee exposure measurements are retained for a minimum of two years and audiometric test records are retained for the duration of the employee's employment, plus 30 years.

7.7 REFERENCES

29 CFR 1910.95, Occupational Noise Exposure

American Conference of Governmental Industrial Hygienists (ACGIH), Threshold Limit Value (TLV) for Chemical Substances and Physical Agents, 2007

FLD 02 INCLEMENT WEATHER

Hot weather (ambient temperatures over 70°F), cold weather (ambient temperatures below 40°F), rain, snow, ice, and lightning are examples of inclement weather that may be hazardous or add risk to work activities. Extremes of heat, cold, and humidity, as well as rain, snow, and ice, can adversely affect monitoring instrument response and reliability, respiratory protection performance, and chemical protective clothing materials.

RELATED FLDs AND OP

FLD 05 – Heat Stress Prevention and Monitoring

FLD 06 – Cold Stress

OP 05-03-008 – Inclement Weather & Business Disruption Policy

PROCEDURE

The potential for exacerbating the impact of physical hazards must be considered for tasks that expose personnel to inclement weather. Risk assessment and hazards analysis should be accomplished during the planning stages of a project for the most likely inclement weather conditions that may be encountered, i.e., rain and lightning in late spring, summer, and early fall, or lightning prone areas; cold, snow, and ice in winter. The Field Safety Officer (FSO) must determine the proper safety procedures and recommend them to the site manager. Each worker must evaluate the risk associated with his/her work and be actively alert to these hazards. Managers and workers must be familiar with the requirements of FLD 05 and FLD 06.

A pre-site activity risk assessment must be completed when inclement weather occurs. Weather conditions that affect instruments and personal protective equipment (PPE) function must be conveyed to site workers who should monitor function and integrity of PPE and be alert to changing weather conditions. A decision must be made on the proper safety procedures to use if work must continue, or to stop work if the risk is too great. The appropriate Safety Professional **must be notified of all instances of the need to stop work for safety reasons, including inclement weather.**

Heat

Hot, dry weather increases risk of soil drying, erosion, and dust dispersion, which may present or increase risk of exposure and environmental impact from toxic hazards. Hot weather will increase pressure on closed containers and the rate of volatilization, thereby potentially increasing the risk of exposure to toxic, flammable, or explosive atmospheres.

Prevention and Protective Measures

Employees must be protected from airborne contaminants using engineering controls such as wetting dry soil to prevent particle dispersion, and providing local ventilation to reduce volatile air contaminants to safe levels, or if engineering controls are infeasible, using prescribed PPE. Wind shifts and velocity should be measured where change may result in dispersion of airborne contaminants into the work area.

Rain, Wet Weather, and High Humidity

Wet conditions resulting from rain and wet weather increase slipping and tripping hazards, braking distances of vehicles, the potential for vehicle skidding, or difficulties in handling powered devices such as augers and drills. Rain fills holes, obscures trip and fall hazards, and increases risk of electrical shock

when working with electrical equipment. Changes in soil conditions caused by rain can impact trenching and excavating activities, creating the potential for quicksand formation, wall collapse, and cave-in. Vehicles become stuck in mud, and tools and personnel can slip on wet surfaces. Rain and wet conditions may decrease visibility (especially for personnel wearing respiratory protection) and limit the effectiveness of certain direct-reading instruments (e.g., photoionization detectors [PIDs]).

Feet that become wet and are allowed to remain wet can lead to serious problems under both heat and cold conditions. Activities that may result in wet feet include extended work in chemical protective clothing and wading in water/liquid during biological assessments. Trench foot, paddy foot, and immersion foot are terms associated with foot ailments resulting from feet being wet for long periods of time. All have similar symptoms and effects. Initial symptoms include edema (swelling), tingling, itching, and severe pain. These may be followed by more severe symptoms including blistering, death of skin tissue, and ulceration. (NOTE: The following Preventive and Protective Measures also apply to Cold, Snow, and Ice.)

Preventive and Protective Measures

Walkways, stairs, ladders, elevated workplaces, and scaffold platforms must be kept free of mud, ice, and snow. Employees shall be prohibited from working on scaffolds covered with snow, ice, or other slippery material except as necessary for removal of such materials.

Vehicles used in rain or cold weather must have working windshield wipers and defrosters, and windows must be kept clear of obstruction.

Drivers must observe traffic laws, including maintaining speed within limits safe for weather conditions, and wearing seat belts at all times. Note that this may mean operating below the posted speed limit.

When walking, workers should use a walking stick or probe to test footing ahead where there is standing water, snow, or ice to protect the walker against stepping into potholes or onto puncture hazards, buried containers, or other potential structurally unsound surfaces.

Prior to using vehicles or equipment in off-road work, workers should walk the work area or intended travelway when puddles or snow may obscure potholes, puncture hazards, or buried containers, or other potential structurally unsound surfaces.

Project managers should arrange to have winches, come-alongs, or other mechanical assistance available when vehicles are used in areas where there is increased risk of getting stuck. Cable or rope and mechanical equipment used for pulling stuck vehicles must be designed for the purpose, of sufficient capacity for the load, and be inspected regularly and before use to ensure safety. **Manually pushing stuck vehicles is to be avoided.**

Prevention methods are required when work is performed in wet conditions or when conditions result in sweating, causing the feet to become and remain wet. Proper hygiene is critical. Workers must dry their feet and change socks regularly to avoid conditions associated with wet feet. Use of foot talc or powder can additionally assist in prevention of this type of condition.

Cold, Snow, and Ice

Cold weather affects vehicle operation by increasing difficulty in starting and braking. Ice, frost, and snow can accumulate on windows and reduce vision. Cold, wet weather can cause icing of roadways,

driveways, parking areas, general work places, ladders, stairs, and platforms. Ice is not always as obvious to see as snow or rain, and requires special attention, especially when driving or walking.

Snow and ice increase the risk of accidents such as slipping when walking, climbing steps and ladders, or working at elevation, and the risk of accidents when driving vehicles or operating heavy equipment. Heavy snow and ice storms may cause electric lines to sag or break, and the use of electrical equipment in snow increases the risk of electric shock. Snow can hide potholes and mud, which can result in vehicles getting stuck or persons falling when stepping into hidden holes. Snow also may cover water, drums or other containers, sharp metal objects, debris, or other objects that can cause falls or punctures.

Preventive and Protective Measures

WESTON personnel are cautioned against operating motor vehicles such as cars or trucks on ice under any circumstances. If traveling in icy conditions, WESTON personnel should follow all public service advisories that curtail driving activities.

Personnel performing activities that require working over ice should be aware of minimal ice thickness safety guidelines as follows:

- 4-inch minimum: activities such as walking or skating.
- 6-inch minimum: activities such as snowmobiling or the use of equipment with the same weight and cross-sectional area as a snowmobile.

Personnel should always be aware that these measurement guidelines are under ideal conditions and that snow cover, conditions on rivers, ponds, or lakes with active currents, and other environmental factors impact the safety of working on ice. Clear ice typically is the strongest, while ice that appears cloudy or honeycombed (contains entrained air) is not as structurally strong. Measurements made by drilling or cutting through the ice should be made every few feet to verify safe conditions. Provisions for rescue (e.g., ladders or long poles and effective communications) must be available at the work site.

Lightning

Lightning represents a hazard of electrical shock that is increased when working in flat open spaces, elevated work places, or near tall structures or equipment such as stacks, radio towers, and drill rigs. Lightning has caused chemical storage tank fires and grass or forest fires. Static charges associated with nearby electrical storms can increase risk of fire or explosion when working around flammable materials, and can adversely affect monitoring instruments.

Lightning is the most dangerous and frequently encountered weather hazard people experience each year. Lightning affects all regions. **Florida, Michigan, Pennsylvania, North Carolina, New York, Ohio, Texas, Tennessee, Georgia, and Colorado** have the most lightning deaths and injuries.

Preventive and Protective Measures

Prior to working in areas or beginning projects when or where there is an increased potential for lightning striking personnel, steps must be taken to predict the occurrence of lightning strikes. Recommendations include:

- Check with client management to determine if there are any patterns or noted conditions that can help predict lightning or if there are structures that are prone to lightning strikes. Arrange for

client notification when there is increased potential for lightning activities. Ensure that clients include WESTON workers in lightning contingency plans.

- Monitor weather reports.
- Note weather changes and conditions that produce lightning.
- Stop work in open areas, around drill rigs or other structures that may attract lightning, on or in water and in elevated work places when lightning strikes are sighted or thunder is heard near a work site.
- Ensure all personnel are provided with safe areas of refuge. Prevent personnel from standing in open areas, under lone trees, or under drill rigs.
- Observe the “30-30” Rule. If you see lightning and thunder is heard within 30 seconds (approximately 6 miles), seek shelter. If you hear thunder, but did not see the lightning, you can assume that lightning is within 6 miles and you should seek shelter. Remain in the sheltered location for 30 minutes following the last lightning strike.
- Use a hand held static potential meter (lightning detection device) to monitor the potential difference between a cloud and the ground. When the measured potential is greater than 2 kV/m, there is a potential for a lightning strike – seek shelter.

High Wind and Tornado Safety

High Winds

Many construction workers have died due to wind-related accidents and injuries. A ladder that seems secure under normal circumstances can become unstable during windy conditions and cause you to fall. Scaffolding that is improperly secured can rip free during strong winds and kill bystanders. The risk of injury for construction workers increases during strong winds. Keep in mind that changing weather conditions can affect your daily work tasks, and make sure you have a game plan to prevent proper damage and personal injury.

Stay Informed: With today’s modern technology available at the touch of a button, you should keep up to date with the latest local weather reports. Visit weatherbug.com or weather.gov to stay informed in case of wind warnings, watches, and advisories. Larger projects may have their own weather station on site to provide instant weather data. Use daily hazard assessments to determine if working conditions have changed or will change throughout the day.

Be Prepared: When you know the weather will be windy, secure loose building materials, scaffolding and fencing that could be picked up or torn loose by strong winds and thrown onto surrounding streets, structures, vehicles, or bystanders.

Know the Limits of Your Equipment: When operating any equipment, take time to read the operator’s manual and become familiar with the wind specifications. Many crane manufacturers have high-wind guidelines to prevent you from operating a crane in unsafe weather. You should also check safety equipment such as fall protection to determine if it is adequate for windy conditions.

Know the Terminology

Severe Thunderstorm Watch

A Severe Thunderstorm Watch means that strong thunderstorms capable of producing winds of 58 mph or higher and/or hail 3/4 inches in diameter or larger are possible. If you are in the area of a Severe Thunderstorm Watch, you should be prepared to take shelter from thunderstorms. Severe Thunderstorm Watches are generally issued for 6-hour periods.

Severe Thunderstorm Warning

A Severe Thunderstorm Warning means that thunderstorms capable of strong winds and/or large hail are occurring or could form at any time. If you are in the area of a severe thunderstorm, you should take shelter indoors immediately, avoid windows, and be prepared for high winds and hail. Severe Thunderstorm Warnings are generally in effect for an hour or less.

High Wind Watch

A High Wind Watch is issued when sustained winds exceeding 40 mph and/or frequent gusts over 60 mph are likely to develop in the next 24 to 48 hours. For summit areas, high wind watches are issued when sustained winds are expected to exceed 45 mph and/or frequently gust over 60 mph. If you are in an area for which a High Wind Watch has been issued you should secure loose objects outdoors that may blow about and avoid outdoor activity that exposes you to high winds.

High Wind Warning

A High Wind Warning is issued when sustained winds exceeding 40 mph and/or frequent gusts over 60 mph are occurring or imminent. For summit areas, warnings are issued for winds exceeding 45 mph and/or frequently gusting over 60 mph. Wind warnings may issued up to 24 hours ahead of the onset of high winds and remain in effect for 6 to 12 hours. If you are in an area where a high wind warning is in effect you should avoid activities that expose you to high winds. Loose objects may be blown around. Tree limbs may break and fall. Power lines may be blown down.

Wind Advisory

A Wind Advisory is issued when sustained winds of 30 to 39 mph and/or frequent gusts to 50 mph or greater are occurring or imminent. Wind advisories may be in effect for 6 to 12 hours. If you are in an area where a wind advisory is in effect you should secure loose objects that may be blown about outdoors and limit activity that may expose you to high winds.

Work Safely: If you will be working on a windy day, you should be alert and protected. Wear eye protection to prevent dust and other particles from entering or striking your eyes. Keep your hard hat on at all times to prevent injuries from falling or flying objects. The likelihood of falls from heights is greatly increased by strong winds. Wear the necessary PPE to ensure your safety.

To avoid flying debris and to minimize damage during high winds:

- Shut down outdoor activities involving work at elevation on ladders, scaffolding, aerial lifts, etc.; handling large tarps and plastic sheeting when wind speeds exceed 25 mph; including work with radioactive materials and highly toxic materials that could be dispersed by the winds.
- At 13 - 18 mph wind will raise dust. Follow the dust action level.

- Move mobile items stored outside to indoor storage.
- Secure any items that cannot be moved inside.
- Be careful opening exterior doors.
- Be cautious about downed power lines, tree limbs, and debris on roads.
- Be alert for animals who have escaped from farms and zoos.

Stay Away from Power Lines: High winds can cause tree limbs to fall on power lines resulting in electrocution hazards or loss of power. Your best bet is to keep your distance.

Tornados

What is a TORNADO?

A tornado is a violent windstorm characterized by a twisting, funnel-shaped cloud. It is spawned by a thunderstorm or as a result of severe weather associated with hurricanes. A funnel cloud is formed as cool air overrides a layer of warm air, forcing the warm air to rise rapidly. The damage from a tornado results from high wind velocity and wind blown debris.

Tornado Safety

When a tornado approaches, you have only a brief amount of time to make life-or-death decisions. Advance planning and quick response are the keys to surviving a tornado.

Purchase a NOAA Weather Alert radio with an alert feature. When tuned to the proper frequency, these weather radios remain silent until a weather emergency occurs. Once they pick up the alarm tone, they will begin broadcasting emergency weather information so that citizens can protect themselves and their property. Some models of the NOAA weather radio incorporate the Specific Area Message Encoder technology, allowing users to target only those warnings that affect their immediate geographic area.

Conduct tornado drills. Designate an area to serve as your safe area, and practice having team members assemble there in response to a mock tornado warning.

Emergency Communications Plan. Develop an emergency communications plan in case team members are separated from one another when a tornado warning goes into effect. Designate an emergency coordinator. Instruct everyone to contact this coordinator in a weather emergency for instructions on what to do during the storm and where to reassemble after the emergency has passed. Design contingency plans to be consistent with client contingency plans. When possible use client warning and alerting systems and confirm that team members have access to shelters and know how to get to them.

Know the Difference between a Tornado Watch and a Tornado Warning

Tornado Watch: Issued by the National Weather Service when tornadoes are possible in your area. You should remain alert for approaching storms. Remind family members of where the safe areas are within your home, and carefully monitor radio or television reports for further developments.

Tornado Warning: Indicates that a tornado has been sighted in your area, or is indicated on weather radar. You should proceed to safe shelter immediately.

When A Tornado Warning Goes In Effect, Put Your Safety Plans In Action.

In Your Automobile: Motor vehicles are easily overturned by tornado winds. Leave your vehicle and seek shelter in a sturdy building. As a last resort, seek shelter in a ditch or culvert. Do not try to outrun or outmaneuver a tornado! Use the time to seek appropriate shelter outside your vehicle.

Office Buildings, Hotels, and Shopping Centers: Take shelter in an interior hallway on a lower floor. A closet, bathroom or other small room with short, stout walls will give some protection from collapse and flying debris. Otherwise, get under heavy furniture and stay away from windows. Many tornado deaths have occurred in large buildings due to the collapse of a roof or wide span wall. A corner area, away from a window, is safer than the middle of a wide span wall.

Out In Open Country: When severe weather approaches, seek inside shelter immediately. The chances of encountering falling trees, downed power lines and lightning are far greater than encountering a tornado itself. If a tornado approaches, lie flat in the nearest depression, such as a culvert or ditch, and cover your head with your arms.

**BE ALERT TO CHANGING WEATHER CONDITIONS
HAVE AN EMERGENCY WEATHER PLAN IN PLACE
REHEARSE YOUR CONTINGENCY PLANS PERIODICALLY
KNOW WHERE TO GO WHEN A TORNADO THREATENS.**

FLD 05 HEAT STRESS PREVENTION AND MONITORING

Heat stress may occur at any time work is performed at elevated temperatures. If the body's physiological processes fail to maintain a normal body temperature because of excessive heat, a number of physical reactions can occur such as fatigue, irritability, anxiety, and decreased concentration or dexterity, and possibly death. Because heat stress is one of the most common and potentially serious illnesses at field sites, regular monitoring and other preventive measures are vital to ensure worker safety. Wearing chemical protective clothing often decreases natural body heat loss (cooling) and increases the risk of heat stress.

Employees who are taking prescription or over-the-counter medications should consult with their personal physician prior to working in high-temperature environments to see if their medication would impair their ability to handle heat stress.

REFERENCES

OSHA 29 CFR 1910 and 1926

RELATED FLDs

FLD 02 – Inclement Weather

FLD 03 – Hot Processes – Steam, Low Temperature Thermal Treatment Unit, and Transportable Incinerator

FLD 08 – Confined Space Entry Program

FLD 36 – Welding/Cutting/Brazing/Radiography

FLD 37 – Pressure Washers/Sandblasting

PROCEDURE

Heat Stress Symptoms and Treatment

Heat Rash

Heat rash, also known as prickly heat, may occur in hot and humid environments where sweat is not easily removed from the surface of the skin by evaporation and is aggravated by chafing clothes. When extensive or complicated by infection, heat rash can be so uncomfortable that it inhibits sleep and impairs a worker's performance.

Symptoms – Mild red rash, especially in areas of the body that come into contact with protective gear.

Treatment – Decrease amount of time spent working in protective gear and provide body powder to help absorb moisture and decrease chafing. Heat rash can be prevented by showering, resting in a cool place, and allowing the skin to dry.

Heat Cramps

Heat cramps are caused by inadequate electrolyte intake. The individual may be receiving adequate water; however, if not combined with an adequate supply of electrolytes, the blood can thin to the point where it seeps into the active muscle tissue, causing cramping.

Symptoms – Acute painful spasms of voluntary muscles, most notably the abdomen and extremities.

Treatment – Move the victim to a cool area and loosen clothing. Have the victim drink 1 to 2 cups of cool potable water or diluted commercial electrolyte solution (e.g., Gatorade, Quench) immediately, and then every 20 minutes thereafter until symptoms subside. Electrolyte supplements can enhance recovery; however, it is best to double the amount of water required by the dry mix package directions or add water to the liquid form.

Heat Exhaustion

Heat exhaustion is a state of weakness or exhaustion caused by the loss of fluids from the body. Heat exhaustion is not as dangerous as heat stroke, but if not properly managed in the field it may lead to heat stroke.

Symptoms – Pale, clammy, and moist skin, profuse perspiring, and extreme weakness. Body temperature is normal, pulse is weak and rapid, and breathing is shallow. The person may have a headache, may vomit, may feel dizzy, and may be irritable or confused.

Treatment – Move the victim to a cool, air-conditioned or temperature-controlled area, loosen clothing, place in a position with the head lower than the feet (shock prevention), and allow the victim to rest. Consult a physician. Ensure that the victim is not nauseated or vomiting. If not nauseated or vomiting, give the victim small sips of cool water or diluted electrolyte replenishment solution (one to one dilution with water, or if mixing from powder, double the water added). If this is tolerated, have the victim drink 1 to 2 cups of fluid immediately, and every 20 minutes thereafter until symptoms subside. Seek medical attention at the advice of the consulting physician.

Heat Stroke

Heat stroke is an acute and dangerous reaction to heat stress caused by a failure of the body's heat regulating mechanisms, i.e., the individual's temperature control system (sweating) stops working correctly. Body temperature rises so high that brain damage and death may result if the person is not cooled quickly.

Symptoms – Red, hot, dry skin (although the person may have been sweating earlier); nausea, dizziness, confusion, extremely high body temperature (i.e., 104°F or greater as measured with an oral thermometer), rapid respiratory and pulse rate, seizures or convulsions, unconsciousness or coma.

Treatment – Immediately call for emergency medical assistance. Remove the victim from the source of heat and cool the victim quickly. If the body temperature is not brought down quickly, permanent brain damage or death may result. Remove all PPE and as much personal clothing as decency permits. Fan the person while sponging or spraying with cool or tepid water. Apply ice packs (if available) to the back of the neck, armpits, groin area, or behind the knees. Place the victim flat on their back or with head and shoulders slightly elevated. If conscious, and not nauseated or vomiting, the victim may be provided sips of cool water. Do not give the victim coffee, tea, or alcoholic beverages. Emergency medical personnel will take over treatment when they arrive.

Recognition and Risk Assessment

In the planning stages of a project, the potential for heat stress disorders must be considered as a physical hazard in the site-specific Health and Safety Plan (HASP). Risk assessment can be accomplished in the development stages of a project by listing in the HASP the most likely heat stress disorders that may occur. The Field Safety Officer (FSO) must make decisions on the proper safety procedures and recommend them to the site manager. Each worker must evaluate the risk associated with his or her work and be actively alert to these hazards. Any site worker may stop work if safety procedures are not

followed or the risk is too great. In addition, all site personnel must be aware of these symptoms in both themselves and their co-workers.

Prevention and Protection Programs

Heat stress is affected by several interacting factors including, but not limited to, age, obesity, physical condition, substance abuse, level of personal protective equipment (PPE) worn, and environmental conditions (temperature, shade, and humidity). Site workers must learn to recognize and treat the various forms of heat stress. The following recommendations should be followed to prevent heat stress:

- The most important measure to prevent heat-related illness is adequate fluid intake. Workers should drink 1/2 to 1 quarts of liquids per hour in high heat conditions. Most of this liquid should be water. Under heavy work and heat conditions, the body may lose up to 2 gallons of fluids per day. To prevent heat stress symptoms, the individual must ensure replacement of this fluid.
- Provide disposable cups that hold about 4 ounces, and water that is maintained at 50 to 60°F. Workers should drink 16 ounces of water before beginning work, and a cup or two at each break period.
- Provide a shaded area for rest breaks. Ensure that adequate shelter is available to protect personnel against heat and direct sunlight. When possible, shade the work area.
- Discourage the intake of caffeinated drinks during working hours.
- Monitor for signs of heat stress.
- Encourage workers to maintain a good diet during these periods. In most cases, a balanced diet and lightly salted foods should help maintain the body's electrolyte balance. Bananas are especially good for maintaining the body's potassium level.
- If utilizing commercial electrolyte mixes, double the amount of water called for in the package directions. Indications are that "full-strength" preparations taken under high heat stress conditions may actually decrease the body's electrolytes.
- Acclimate workers to site work conditions by slowly increasing workloads (i.e., do not begin work activities with extremely demanding tasks).
- Rotate shifts of workers who are required to wear impervious clothing in hot weather.
- Encourage workers to wear lightweight, light-colored, loose-fitting clothing.
- In extremely hot weather, conduct field activities in the early morning and evening.
- Provide cooling devices to aid natural body heat regulation. These devices, however, add weight and their use should be balanced against worker efficiency. An example of a cooling aid is long cotton underwear, which acts as a wick to absorb moisture and protect the skin from direct contact with heat-absorbing protective clothing.
- Good hygienic standards must be maintained by frequent showering and changes of clothing.
- Clothing should be permitted to dry during rest periods.
- Whenever working in the sun, provide employees with sunscreen with both UVA and UVB protection.
- Persons who notice skin problems should immediately consult medical personnel.

Heat Stress Monitoring and Work Cycle Management

When strenuous field activities are part of on-going site work conducted in hot weather, the following guidelines should be used to monitor the body's physiological response to heat, and to manage the work cycle, even if workers are not wearing impervious clothing. These procedures should be instituted when the temperature exceeds 70°F and the tasks/risk analysis indicates an increased risk of heat stress problems. Consult the HASP and a safety professional (e.g., Division EHS Manager, FSO) if questions arise as to the need for specific heat stress monitoring. In all cases, the site personnel must be aware of the signs and symptoms of heat stress and provide adequate rest breaks and proper aid as necessary.

Measure Heart Rate – Heart rate should be measured by the radial pulse for 30 seconds as early as possible in the rest period. The heart rate at the beginning of the rest period should not exceed 110 beats per minute. If the heart rate is higher, the next work period should be shortened by 33%, while the length of the rest period stays the same. If the pulse rate still exceeds 110 beats per minute at the beginning of the next rest period, the following work cycle should be further shortened by 33%. The procedure is continued until the rate is maintained below 110 beats per minute.

Measure Body Temperature – When ambient temperatures are over 90°F, body temperatures should be measured with a clinical thermometer as early as possible in the rest period. If the oral temperature exceeds 99.6°F (or 1 degree change from baseline) at the beginning of the rest period, the following work cycle should be shortened by 33%. The procedure is continued until the body temperature is maintained below 99.6°F (or 1 degree change from baseline). Under no circumstances should a worker be allowed to work if their oral temperature exceeds 100.6°F.

Measure Body Water Loss – Body water loss greater than 1.5% of total body weight is indicative of a heat stress condition. Body weight is measured before PPE is donned and after the PPE is removed following a work cycle. Body water loss can be measured with an ordinary bathroom scale; however, the scale must be sensitive to one-half pounds increments. A worker is required to drink additional fluids and rest if their body water loss is greater than 1.5%.

NOTE: For purposes of this operating practice, a break is defined as a 15-minute period and/or until an individual's vital signs are within prescribed guidelines.

A physiological monitoring schedule is determined by following the steps below:

- Measure the air temperature with a standard thermometer.
- Estimate the fraction of sunshine by judging what percent the sun is out (refer to Table 1).
- Calculate the adjusted temperature based on the following formula:
Adjusted Temperature = Actual Temperature + 13 X (where X = sunshine fraction from Table 1)
- Using Table 2, determine the physiological monitoring schedule for fit and acclimated workers for the calculated adjusted temperature.

The length of work period is governed by frequency of physiological monitoring (Table 2). The length of the rest period is governed by physiological parameters (heart rate and oral temperature).

**Table 1. Percent Sunshine Factors
Heat Stress Prevention and Monitoring**

Percent Sunshine (%)	Cloud Cover	Sunshine fraction
100	No cloud cover	1.0
50	50% cloud cover	0.5
0	Full cloud cover	0.0

**Table 2. Physiological Monitoring Schedule
Heat Stress Prevention and Monitoring**

Adjusted Temperature	Level D (Permeable clothing)	Level C, B, or A (Nonpermeable clothing)
90°F (32.2°C) or above	After each 45 minutes of work	After each 15 minutes of work
87.5°F (30.8° - 32.2°C)	After each 60 minutes of work	After each 30 minutes of work
82.5° - 87.5°F (28.1° - 32.2°C)	After each 90 minutes of work	After each 60 minutes of work
77.5° - 82.5°F (25.3° - 28.1°C)	After each 120 minutes of work	After each 90 minutes of work
72.5° - 77.5°F (22.5° - 25.3°C)	After each 150 minutes of work	After each 120 minutes of work

Example: Site personnel anticipate wearing level C (impermeable clothing) during site activities. The air temperature is 80°F and there are no clouds in the sky (100% sunshine). The adjusted temperature is calculated in the following manner:

$$\text{Adjusted Temperature (Adj T } ^\circ\text{F)} = \text{Actual Temperature (Amb T } ^\circ\text{F)} + (13 \times \text{sunshine fraction})$$

$$\text{Adj T } ^\circ\text{F} = 80^\circ\text{F} + (13 \times 1.0)$$

$$\text{Adj T } ^\circ\text{F} = 93^\circ\text{F}$$

Using Table 2, the pulse rate, oral temperature and body water loss monitoring would be conducted after each 15 minutes of work. The adjusted temperature may need to be redetermined if the percent sunshine and ambient temperature changes drastically during site work.

If an individual's heart rate exceeds 110 beats per minute at the beginning of the rest period, that individual will continue to rest until his or her heart rate drops to baseline; the next work period is then decreased by 33%.

FLD 10 MANUAL LIFTING AND HANDLING OF HEAVY OBJECTS

Improper lifting can result in cuts, pinches, crushing, and serious injury to back, abdomen, arm and leg muscles, and joints. Even relatively light objects, lifted improperly, can contribute to injury. Muscle and joint injuries occur when objects to be lifted are too heavy or awkward, are lifted improperly, or in areas where access is restricted. Lifting tasks which are awkward and repetitive, even if involving only light objects, can lead to nerve and joint damage.

At the project level, the need for manual lifting or handling of heavy objects must be identified as a physical hazard in the planning stages of a project Health and Safety Plan (HASP).

MANUAL LIFTING

Plan any manual lifting task noting the following:

Contact hazards. Check each object before lifting for presence of splinters, splinters, sharp edges or parts, cracks and loose joints, which can result in cuts. Signs of biological hazards, and chemical or radioactive material contamination.

- **Weight of object.** Unless involved in weight training, recommended safe lifting weights for an average man or woman are 50 and 35 pounds, respectively.
- **Size and shape of object.** Large and oddly shaped objects are more difficult to lift, even within safe weight limits, due to imbalanced center of gravity.
- **Area in which lifting is to be done.** Heavy objects can pinch or crush fingers, toes, arms, and legs between the object and nearby objects (e.g., walls, tables, counters, or railings). Check for pinch points such as other objects close by and ensure there is room for safe lifting.
- **Conditions under which lifting is to be accomplished.** Check for wet or slippery surfaces. Consider level of protection to be used. Level B or A protection may add up to 40 lbs. To be lifted, as well as restricting range of motion and adding to area restriction by increasing bulk.

Route to be traveled, if lifting includes carrying. Check walking and working surfaces for slip and trip hazards, note ramps, changes in level of elevation, and ladders or stairways that need to be negotiated.

Manual Lifting - Prevention and Protection

- Before lifting, identify the potential for contact hazards on objects to be lifted. Check each object before lifting, remove any noted hazards as feasible, and wear gloves (cotton, at a minimum, or leather, kevlar, or chemical resistant material, depending on the nature of the hazard).
- Avoid contact with, or cover cracks or loose joints to reduce hazards of pinching.
- Workers must know their lifting limitations, plan before lifting, keep themselves in good physical condition, and get help if uncertain that they can lift safely. Managers must plan and allow for safe lifting.
- When lifting an object from the floor:
 - Determine that the object is within the safe weight limit.
 - Check for contact hazards.
 - Walk the intended route of travel to identify and remove slip and fall hazards.
 - Identify changes in elevation, steps, ramps, stairs and ladders that must be negotiated.

- To lift square or rectangular objects:
 - Avoid reaching as you lift.
 - Set feet firmly, placing one foot alongside the load and the other slightly behind the load.
 - Keep objects close to the body.
 - Squat in front of the load.
 - Grasp one of the top corners away from the body and the opposite bottom corner closest to the body.
 - Tilt the object slightly away from the body, tilt forward at the hips, keep the back straight and tuck in the chin.
 - Straighten the legs, keeping the spine straight, pull the object into the body and stand up slowly and evenly without jerking or twisting.

If turning or change of direction is required, turn with feet without twisting the torso and step in the direction of travel

To set an object down, reverse the sequence, being sure not to trap the bottom hand between the object and the surface on which the object is set.

Workers must be trained and have the opportunity to use the above steps with lighter objects before performing heavy lifting. **For odd-shaped objects, the only modification needed should be hand-hold position.** When two or more persons are lifting, have a plan and a set of signals so lifting occurs simultaneously.

Do not carry objects in a manner which obstructs vision in the line of travel.

Carry objects so one hand is free to hold the handrail on stairs and that there is an unobstructed view of footing. Carry objects in a manner to permit use of both hands while climbing a ladder.

MANUAL HANDLING OF HEAVY OBJECTS

Manual handling of heavy objects, even when not lifting, can pose the same hazards as lifting including cuts, pinches, bruises, crushing, muscle and joint strain, and contact with hazardous materials and biological hazards.

Drums and other containers which must be maneuvered for access to information or sampling locations, that are inaccessible to mechanical handling equipment, require manual handling and special precautions. When handling of heavy objects does not involve lifting, workers can handle heavier objects safely, even those weighing several hundred pounds, if proper techniques are used. In many instances, the procedures involve balancing and taking advantage of the shape of the object.

Manual Handling - Prevention and Protection

Prior to performing manual handling, it must be determined that it can be done safely and that mechanical assistance is infeasible. Mechanical equipment or assistance such as dollies, carts, come-alongs or rollers are to be used whenever possible. Mechanical assistance must be of proper size, have wheels sized for the terrain, and be designed to prevent pinching or undue stress on wrists. Objects to be moved must be secured to prevent falling and properly balanced to prevent tipping.

The minimum protection for manual handling is heavy cotton or leather gloves, safety boots, and coveralls. Metatarsal guards, chemical protective clothing, and metal mesh or kevlar gloves must be used as risk increases of heavy items falling, hazardous materials contact and sharp edges, splinters or slivers.

Workers must be aware of and work within their weight-handling capabilities.

Objects to be manually handled must be checked for contact hazards before handling, and to ensure handling will not trap hands, arms, legs, or feet between the object and other objects, walls, or railings.

Properly trained personnel may roll heavy objects with a round base such as 55-gallon drums or compressed gas cylinders, if rolling will not damage the structural integrity. Rolling must be controlled by chutes, tag-lines, or other means of limiting acceleration. Use of the legs for pushing and tag-line control of rolled objects must be stressed.

Only properly trained personnel may move cylindrical objects which must remain upright by hand. Cylindrical objects, such as drums that must remain upright, are handled manually by slightly tilting the object, using the legs for control, and balancing the object on the bottom edge. The handler then walks beside the object, with the object tilted toward the body, positioning the hands on the top edge away from the body and moving so they do not cross, thus maintaining balance and a steady controlled forward motion.

Prior to moving cylindrical objects in this way, the route of travel must be walked to identify any changes of elevation, pot holes, or other obstructions that could cause the object to snag, tip, or get out of control.

Flat, square, or rectangular objects are most easily handled using make-shift rollers or skids to break the friction with the resting surface and pushing, using the legs.

FLD 11 ROUGH TERRAIN/ATV USE

RELATED FLDs

FLD 02 – Inclement Weather

FLD 05 – Heat Stress Prevention and Monitoring

FLD 06 – Cold Stress

FLD 22 – Heavy Equipment Operation

FLD 47 – Clearing, Grubbing, and Logging Operations

FLD 57 – Motor Vehicle Safety

HAZARD

Physical hazards associated with rough terrain include vehicle accidents, heavy equipment incidents, falling, slipping, and tripping.

Driving vehicles on uneven surfaces creates a possibility of the vehicle rolling, getting stuck in mud or ditches, or of an accident due to flat tires or striking obstacles and other vehicles.

When working on foot, steep inclines and heavy or downed vegetation can hide holes or breaks in the terrain, increasing the risk of slips, trips, and falls.

RECOGNITION AND RISK ASSESSMENT

Rough terrain complicates work activities and adds to or increases risk. In the planning stages of a project, rough terrain must be considered as a physical hazard and identified in the site-specific health and safety plan (HASP). Risk assessment is usually accomplished from site history information (i.e., site topography) and on site by the Field Safety Officer (FSO).

HAZARD PREVENTION AND PROTECTION PROGRAMS

Safety on Foot

Personnel working on rough terrain should maintain a high level of physical conditioning due to increased body stress and exertion.

The site crew should be alert and observe terrain while walking to minimize slips, trips, and falls.

Boots should be ankle high or higher to provide additional support and stability.

Work will be completed in adequate natural light or sufficient illumination will be maintained.

Site personnel will conduct an initial walkover and the “buddy system” will be implemented.

Emergency communications such as a cell phone or two-way radio should be carried at all times.

Personnel should be aware of potential hazards and ensure the availability of first-aid supplies and knowledge of the location of the nearest medical assistance.

VEHICLE SAFETY

Vehicle drivers and passengers will wear seatbelts at all times.

Hazards can be prevented by ensuring regular maintenance is performed on vehicles and all safety features are working. Have brakes and wheel bearings of vehicles used off road or in four wheel drive inspected at increased frequency (suggest inspections at twice the manufacturer's recommended frequency).

In order to minimize accidents, site surveillance on foot may be required to ensure clear driving paths.

Minimize side hill travel. Travel straight up and down hills whenever possible. Passengers will not be allowed when side hill travel is required.

Take into account loads or superstructure of vehicles which raise the center of gravity and increase risk of tipping.

Cross streams, small logs or other passable (there is adequate clearance of the undercarriage) obstructions at right angles.

Four wheel drive vehicles should be used if terrain conditions are wet, frozen, broken, or otherwise deemed unsafe for two wheel drive vehicles by the FSO. Use of vehicles off-road will be specifically addressed in the HASP and personnel operating vehicles will be checked for proficiency.

- Before moving a vehicle in the field, first walk the route of travel, inspecting for depressions, stumps, gullies, ruts, and similar obstacles.
- Always check the brakes of a vehicle before traveling, particularly on rough, uneven, or hilly ground.
- Check the complete drive train of a carrier at least weekly for loose or damaged bolts, nuts, studs, shafts, and mountings.
- Engage the all wheel drive when traveling off highway on hilly terrain.
- Increase tire pressures before traveling in hilly terrain (do not exceed rated tire pressure).
- Use the assistance of someone on the ground as a guide when lateral or overhead clearance is close.
- After the vehicle/equipment has been moved to a new site, set all brakes and/or locks. When grades are steep, block the wheels.

Definitions

Class I, All-terrain vehicle (ATV): A motorized off-highway vehicle, 50 in. (127 cm) or less in width, having dry weight of 800 lbs (362.9 kg) or less, and traveling on three or more low pressure tires (10 lbs [4.5 kg] psi or less), with a seat designed to be straddled by the operator.

Class I, Category G, ATV: An ATV intended for general recreational and utility use.

Class I, Category U, ATV: An ATV intended primarily for utility use.

Class II, ATV: A motorized off-highway vehicle with a width which exceeds 50 in. (127 cm) or having a dry weight that exceeds 800 lbs (362.9 kg), traveling on four or more low-profile, low-pressure tires (10 lbs [4.5 kg] psi or less) and having a bench seat.

NOTE: Utility Vehicles are designed to perform off-road utility tasks such as passenger and cargo transportation and are addressed separately below. Examples are Rangers, Rhino, M-Gators, Gators, and Mules.

Rollover Protective Structure (ROPS). A cab or frame that provides a safe environment for the tractor operator in the event of a rollover.

ALL TERRAIN VEHICLES (ATVS)

Qualifications

ATV operators will have completed a nationally recognized accredited ATV training course (such as provided by the Specialty Vehicles Institute of America or in-house resources that have been certified as trainers by an accredited organization) prior to operation of the vehicle.

The operator must pass an operating skills test prior to being allowed to operate an ATV. Proof of completion of this training will be maintained.

Equipment

All ATVs shall be equipped with:

- An operable audible warning device (horn);
- Headlights (if it will be used during hours of darkness);
- Taillights; and
- Brake lights.
- Mufflers and spark arresters.

All Class II ATVs will be equipped with ROPS and seatbelts

Operation

Only Class I and Class II ATVs with four or more wheels may be used. Class III ATV's may not be used.

The manufacturer's recommended payload will not be exceeded at any time.

Gloves and an approved motorcycle helmet with full-face shield or goggles will be worn at all times while operating a Class I ATV.

An ATV will not be driven on public roadways except to cross the roadway, and it will only be driven on a public roadway at designated crossing points or with a road guard (no paved road use unless allowed by the manufacturer).

A copy of the operator's manual will be kept on the vehicle and protected from the elements (if practicable).

Tires shall be inflated to the pressures recommended by the manufacturer.

Passengers are prohibited on Class I ATVs.

UTILITY VEHICLES

Utility vehicles are defined as specialty Class II ATVs designed to perform off-road utility tasks such as passenger and cargo transportation. Examples are Rangers, Rhino, M-Gators, Gators, and Mules.

Utility vehicle operators shall be trained and familiar with the use of all controls; understand proper moving, stopping, turning and other operating characteristics of the vehicle. Operators must review all training materials provided by the manufacturer for the specific vehicles, and training should be in accordance with appropriate manufacturer recommendations. A copy of the operator's manual shall be kept on the vehicle at all times and protected from the elements. At a minimum, training should address:

- Basic riding tips from the manufacturer's published literature for each vehicle.
- Reading terrain.
- Climbing hilly terrain.
- Descending a hill.
- Traversing a slope.
- Riding through water.
- Cargo carriers and accessories.
- Loading and unloading.
- Troubleshooting.
- Proper preventative maintenance, (i.e., oil levels, tire pressure requirements and scheduled maintenance requirements according to the manufacturer's guidelines.).

Utility vehicles shall be equipped with:

- Operable audible warning device (horn).
- Headlights.
- Taillights.
- Brake lights.
- Seatbelts.
- ROPS.

Occupancy in utility vehicles is limited to manufacturer designated seating that has built-in seatbelts. Passengers may not ride in the vehicle's back cargo area unless the vehicle is otherwise equipped. Note: When used for emergency response, medical litters may be placed in the back cargo area but must be secured as described below.

The manufacturer's recommended load carrying capacity, personnel capacity, or maximum safe vehicle speed shall not be exceeded at any time.

Cargo items will be secured as necessary to prevent movement/tipping. All loads over fifty pounds (to include medical litters) must be securely strapped to cargo tie-downs in the rear and to the cargo shelf in the front.

Seatbelts will be worn by operators and passengers of specialty vehicles where installed by the manufacturer. Operators and passengers shall wear goggles at all times when a utility vehicle, not equipped with a windshield, is in motion.

Utility vehicles will not normally be driven on public roadways except to cross the roadway, and will only be driven on a public roadway at designated crossing points or with a road guard. Utility vehicles that are allowed to operate outside a controlled work area and/or on public roads will meet the minimum vehicle safety standards in accordance with 49 CFR 571.5, to include ROPs, seatbelts and placement of “Slow Moving Vehicle” emblems where required.

Manufacturer-installed safety equipment will be maintained in working order and used in compliance with the requirement of this regulation and in accordance with manufacturer’s recommendations.

RULES

Observe the following practices to help prevent accidents:

- Do not misuse utility vehicles.
- Reduce speed and exercise extreme caution on slopes or on rough ground.
- Do not overload vehicle and avoid shifting loads. Reduce load when operating over rough or hilly terrain.
- Do not stop or start suddenly when going uphill or downhill. Be especially cautious when changing direction on slopes.
- Stay alert for holes, rocks, and other hidden hazards in the terrain.
- Keep away from drop-offs, ditches, embankments, as well as ponds and other bodies of water. The machine could suddenly turn over if a wheel is over the edge of a cliff or ditch, or if an edge caves in.
- Keep front wheels straight at crest of hill or going over bumps.
- When descending a hill, remove foot from accelerator and apply brakes to reduce speed and maintain control.

Transport Loads Safely

- Be sure load is evenly distributed.
- Do not load above the load guard.
- Securely anchor all loads in cargo box.
- Reduce cargo box capacity when operating on rough or hilly terrain.
- Use existing trails. Avoid terrain such as dangerous slopes and impassable swamps. Watch carefully for sharp bumps, holes, ruts, or obstacles.
- Look ahead at terrain. Know what is coming and be prepared to react. Be alert for hazards.
- Keep front wheels straight at the crest of a hill or going over bumps.
- Reduce speed according to trail, terrain, and visibility conditions.
- The passenger should always use the hand holds.

Climbing or Descending a Hill

- Always use the brakes when going down slopes, the utility vehicle can speed up (freewheel) going down a slope. Engine or clutch braking effect is minimal.
- Balance loads evenly and secure them. Braking could shift the load and affect vehicle stability.
- Sit on the center of the seat and keep both feet within the foot platform.
- Never drive past the limit of visibility. Slow down near the crest of a hill until getting a clear view of the other side.
- If the vehicle stops or loses power going up a hill, lock the park brake to hold the vehicle on slope. Maintain direction of travel and release the brake slowly. Back straight down hill slowly while maintaining control. Do not turn the vehicle sideways. The vehicle is more stable in a straight forward or rearward position.
- If the utility vehicle begins to tip, turn the front wheel downhill to gain control before proceeding.

Riding Through Water

- Avoid water whenever possible. If the drive belt becomes wet, slippage will occur and the vehicle will lose power.
- Never cross any body of water where the depth may be unknown to the operator. As an operational guideline, deep water is considered anything in excess of 152 mm (6 in.) in depth. Tires may float, making it difficult to maintain control.
- Choose a course within the waterway where both banks have a gradual incline. Cross at a point known to be safe.
- Proceed at a slow steady speed to avoid submerged obstacles and slippery rocks.
- Avoid water crossings where the operation of a utility vehicle may cause damage to waterway beds or erode waterway shoreline.

FLD 22 EARTH MOVING EQUIPMENT/MATERIAL HANDLING EQUIPMENT

REFERENCES

29 CFR Part 1926 Subparts 600-602

RELATED FLDs

FLD 23 – Cranes, Rigging, and Slings

FLD 24 – Aerial Lifts/Manlifts

FLD 34 – Utilities

FLD 35 – Electrical Safety

PROCEDURE

These rules apply to the following types of earthmoving equipment: scrapers, loaders, crawler or wheel tractors, bulldozers, off-highway trucks, graders, agricultural and industrial tractors, and similar equipment.

Machinery and Mechanized Equipment Safety

Before any machinery or mechanized equipment is placed in use, it will be inspected and tested by a competent mechanic and certified to be in safe operating condition.

WESTON will designate a competent person to be responsible for the inspection of all machinery and equipment daily and during use to make sure it is in safe operating condition. Tests will be made at the beginning of each shift during which the equipment is to be used to determine that the brakes and operating systems are in proper working condition.

Preventative maintenance procedures recommended by the manufacturer will be followed.

Any machinery or equipment found to be unsafe shall be removed from service and its use prohibited until unsafe conditions have been repaired or corrected.

Inspections or determinations of road conditions and structures will be made in advance to ensure that clearances and load capacities are safe for the passing or placement of any machinery or equipment.

Machinery and mechanized equipment will be operated only by designated personnel. Equipment deficiencies observed at any time that affect safe operation will be corrected before continuing operation.

Seat belts shall be provided on all equipment covered by this section and shall meet the requirements of the Society of Automotive Engineers (J386-1969) and Seat Belts for Construction Equipment. Seat belts for agricultural and light industrial tractors shall meet the seat belt requirements of Society of Automotive Engineers (J333a-1970), Operator Protection for Agricultural and Light Industrial Tractors.

Seat belts shall be worn when provided by the manufacturer. Passengers shall not be allowed to ride on equipment unless equipment is designed with additional seats with safety belts.

Audible alarms. All bi-directional machines, such as rollers, compacters, front-end loaders, bulldozers, and similar equipment, shall be equipped with a horn, distinguishable from the surrounding noise level, which shall be operated as needed when the machine is moving in either direction. The horn shall be maintained in an operative condition.

Getting off or on any equipment while it is in motion is prohibited.

Machinery or equipment requiring an operator will not be permitted to run unattended.

Machinery or equipment will not be operated in a manner that will endanger persons or property, nor will the safe operating speeds or loads be exceeded.

All machinery or equipment will be shut down and positive means taken to prevent its operation while repairs or manual lubrications are being done. The only exemption is equipment designed to be serviced or maintained while running.

All repairs on machinery or equipment will be made at a location that will provide protection from traffic or other hazards to maintenance personnel.

Machinery and equipment, or parts thereof, that are suspended or held apart by slings, hoists, or jacks also will be substantially blocked or cribbed before personnel are permitted to work underneath or between them.

Bulldozer and scraper blades, front end-loader buckets, dump bodies, and similar equipment will be either fully lowered or blocked when being repaired or when not in use. All controls will be in a neutral position, with the engines stopped and brakes set, unless work being performed on the machine requires otherwise.

Stationary machinery and equipment will be placed on a firm foundation and secured before being operated.

All points requiring lubrication during operation will have fittings so located or guarded to be accessible without hazardous exposure.

When necessary, all mobile equipment and the operating area will be adequately illuminated while work is in progress.

Mechanized equipment will be shut down prior to and during fueling operations. Closed systems, with automatic shutoff that will prevent spillage if connections are broken, may be used to fuel diesel powered equipment left running.

All towing devices used on any combinations of equipment will be securely mounted and structurally adequate for the weight drawn.

Persons will not be permitted to get between a piece of towing equipment and the item being towed until the towing equipment has come to a complete stop.

All equipment with windshields will be equipped with powered wipers. Vehicles that operate under conditions that cause fogging or frosting of windshields will be equipped with operable defogging or defrosting devices.

All equipment left unattended at night, adjacent to a highway in normal use, or adjacent to construction areas where work is in progress, will have lights or reflectors, or barricades equipped with lights or reflectors, to identify the location of the equipment.

Whenever the equipment is parked, the parking brake will be set. Equipment parked on inclines will have the wheels chocked or track mechanism blocked and the parking brake set. Equipment such as lift trucks and stackers will have the rated capacity posted on the vehicle so as to be clearly visible to the operator. When auxiliary removable counterweights are provided by the manufacturer, corresponding alternate rated capacities also will be clearly shown on the vehicle. The ratings will not be exceeded.

Steering or spinner knobs will not be attached to the steering wheel unless the steering mechanism prevents road reactions from causing the steering hand wheel to spin. When permitted, the steering knob will be mounted within the periphery of the wheel.

All industrial trucks in use will meet the requirements of design, construction, stability, inspection, testing, maintenance, and operation, defined in American National Standards Institute (ANSI) B56.1, Safety Standards for Powered Industrial Trucks.

The installation of live booms on material and personnel hoists is prohibited.

The controls of loaders, excavators, or similar equipment with folding booms or lift arms will not be operated from a ground position unless so designed.

Personnel will not work or pass under the buckets or booms of loaders in operation.

Cranes and any other equipment used for lifting must be inspected as required and records of inspection must be maintained.

Drill Rigs

See FLD 56, *Drilling Safety*

FLD 34 UNDERGROUND UTILITIES

REFERENCES

29 CFR 1926.651, *Specific Excavation Requirements*
ANSI Standard Z 535.1, *American National Standard for Safety Color Code*

RELATED FLDs

FLD 42 – Lockout/Tagout

This Field Operation Procedure (FLD) provides requirements for identification, location, and avoidance of underground utilities, appurtenances, and structures during intrusive activities. These requirements are applicable to all Weston Solutions, Inc. (WESTON) operations. The procedures address the requirements and recommendations for identifying and locating, working around, and encountering or contacting underground utilities. The FLD also addresses actions to be taken in response to encountering or contacting underground utilities.

DEFINITIONS

Aggressive Methods

The use of mechanized equipment such as (but not limited to) excavators, backhoes, drill rigs, directional drilling, Geoprobe operations (including all direct push techniques), or road saws.

Buffer Zone

As defined in this procedure, the area around a utility where only non-aggressive excavation methods may be utilized, unless specific conditions are met.

The definition cited above, and the excavation requirements and restrictions associated with it, will vary depending on the particular state regulations. WESTON requires the imposition of a **three-foot** Buffer Zone on all sides of the utility as measured from the outside edges of the utility, both horizontally and vertically. State and/or local buffer zone requirements must be verified by consulting the applicable state regulations in the event buffer zones greater than three feet are required.

The term “Buffer Zone” may be referred to as the “Tolerance Zone”, “Safety Zone”, or “Approximate Location of Underground Utilities” in some jurisdictions.

Competent Person

A Competent Person has the ability to recognize hazards associated with underground utilities and the authority to stop or direct operations to ensure the safety of personnel and conformance with this procedure. The Competent Person has an understanding of this procedure, and the “One-Call” system requirements for the jurisdiction where excavation is occurring. The Competent Person must be capable of notifying One-Call agencies and maintaining and tracking One-Call Locate Numbers. Additionally, they must have knowledge of methods and work practices for excavation work and the identification, avoidance, and protection of underground utilities.

The designation of a Competent Person will be made by the Site Manager (SM) or Project Manager (PM) and documented in the site-specific Health and Safety Plan (HASP) or attachment to the HASP. Each WESTON Competent Person is required to successfully complete WESTON’s internal training program on the use and application of this FLD and possess appropriate and relevant field experience.

The names of Subcontractor Competent Persons will be documented in the Site-Specific *Subcontractor Acknowledgment: Supervisor Personnel, Competence of Personnel, and Task Understanding* form. Subcontractor Competent Persons will be expected to follow this FLD or their company's procedures, whichever is more restrictive.

Damage

Damage may be considered as any undesired impact or unanticipated removal of support from an underground utility as a result of excavation or demolition. Damage may be as simple as minor contact (by any means) resulting in displacement of protective coating. The utility owner must be contacted regarding any damage or question of damage.

De-Energize

As applicable to a utility, to physically eliminate and/or prevent the presence, transmission, flow, or release of energy or materials which may cause harm to personnel or property.

Excavation (Intrusive Activity)

An operation using mechanized equipment for the purpose of movement or removal of earth, rock, or the materials in the ground, including but not limited to: digging, blasting, augering, test boring, drilling, pile driving, directional drilling, grading, plowing-in, hammering (including hammer-drill soil gas sampling tube installation), pulling-in, jacking-in, trenching, tunneling, structural demolition, milling, scraping, tree and root removal (grubbing), and fence or sign post installation. Note that in some States or jurisdictions, excavation may include hand augering or use of other hand tools.

Jurisdiction

The Authority having legal jurisdiction for establishing and/or enforcing regulations and requirements for notification of excavation activities and associated identification and marking of underground utilities. In the United States, the States have jurisdiction, and most consider the regulations applicable when excavation is to be performed in any location, including any public or private way, any company right-of-way or easement, or any public or privately owned land or way. Note: One caveat to remember – Jurisdiction may flow to the “owner” on private or government-owned property because the State One-Call Agencies may not clear utilities on such facilities.

Note that easement boundaries may require differing methods for compliance assurance. Railroads and certain above ground utilities have easements that require specific procedures for excavation (including shoring and shielding of both the utility as well as for the track and/or poles). In these cases it may be required that an inspector or representative of the railroad or utility is present at all phases of the activity.

Locate

To indicate the existence of a utility by establishing a mark through the use of flags, pins, stakes, paint, or some other customary manner, that *approximately* determines the location of a line or facility.

Locate Request

A communication between an entity performing intrusive activities and a utility marking agency (One-Call, etc).

Non-Aggressive Methods

Non-Aggressive methods involve the use of manual methods such as hand digging with shovels or by potholing or daylighting methods.

Observer

The person assigned to visually monitor and, as needed, signal the operator during mechanized intrusive activity when the activity is occurring within three feet of the outside edge of the buffer zone. The observer remains in close communication with the equipment operator(s) and will stop the activity if needed.

One-Call Agency

An entity that administers a system through which a person can notify owners/operators of underground lines or utilities of the intent to perform intrusive activities in proposed public areas. **It is important to note that not all underground utility owners may be required to join the One-Call system. Additionally, some underground utility owners may not comply with State registration requirements.** The SM or Competent Person is responsible to determine additional utilities that may need to be contacted individually.

Positive Response

Verification prior to the intrusive activity, to ensure that all contacted (typically via the One-Call Agency) owner/operators have located and marked the underground utilities. The SM or Competent Person is responsible to determine/verify ownership of the property where the intrusive activity will occur, including any easements.

Potholing or Daylighting

The practice of exposing an underground facility by safe, *non-aggressive* excavation methods in order to determine the precise horizontal and vertical position and orientation of underground lines or utilities. potholing or daylighting are terms used to describe the excavating of buried facilities using an air or water “knife” coupled with vacuum excavation that exposes underground utilizes to the “daylight” – a positive and safe means of identification and confirmation of exact utility location.

Target Rich Environment

Areas where multiple utilities are known or suspected of being located, areas where utility locations are in question and/or difficult to obtain information on, or areas with known or suspect high-risk utilities. **Note: Military Bases (active or inactive) are to be considered “Target Rich Environments”.**

Underground Utility

An underground or submerged conductor, pipe, or structure used in transporting or providing electric, communications service, gas, oil or oil product, sewage, storm drainage, water, or other service and appurtenances thereto. As used in this procedure, utility includes all underground appurtenances and structures.

The following are examples of the types of underground utilities that may be present in a given location:

- Natural gas pipelines
- Electric cables

- Water pipelines
- Fiber optic telecommunications lines
- Telephone cable lines
- Steam pipelines
- Gasoline, oil, or other fuels
- Sewer pipelines
- Vents for sewer and gasoline/diesel fueling systems
- Underground Storage Tanks (USTs)
- Abandoned underground structures containing hazardous materials, hazardous wastes, and radioactive materials

Underground Utility Owner

Any person, utility, municipality, authority, political subdivision or other person or entity who owns, operates, or controls the operation of an underground line/facility.

White Lining

The practice whereby the person (in this case WESTON or a Subcontractor) who intends to perform intrusive activities, pre-marks the site with an outline of the area where intrusive activities will occur. This involves the use of white paint, flags, stakes, or a combination thereof to mark the extent of where work is to be performed. The marking may vary depending on what intrusive activities are to be conducted. For example, for general excavation, an areal outline of the excavation shall be marked, while for drilling, the individual boreholes shall be marked. Studies have shown that pre-marking is a practice that does prevent utility contact incidents. Check State or local regulatory requirements to ensure compliance.

RESPONSIBILITIES

Competent Person

The Competent Person shall be responsible for:

- Obtaining a copy of, and understanding the applicable regulations for the state of jurisdiction where the excavation activities are to be performed.
- Contacting the appropriate One-Call Agency or private locating service, as applicable.
- Recording One-Call locate numbers.
- If necessary, renewing One-Call locate numbers before expiration.
- Ensuring that white-lining of the area to be excavated is performed; if another equal or better protective measure is necessary because of the nature of the work, state/local regulation, or client requirements, the HASP should be amended to reflect the change.
- Ensuring that a “positive response” has been received from every utility owner/operator identified by the One-Call Agency (and any non-member utility as necessary) and that they have located their underground utilities and have appropriately marked any potential conflicts with the areas of planned intrusive activities prior to the start of intrusive work.

- Ensuring that appropriate means for supporting and protecting any exposed utility have been discussed with the utility owner and such means are available on-site.
- Ensuring that above-ground utilities and other appurtenances will not create a problem, or be impacted by WESTON activities. In all cases provisions for protection of any utility, structure, or appurtenance must be made.
- Ensuring that provisions for emergency actions and emergency shut-off/mitigation of utilities have been discussed with utility owners and field personnel.
- Ensuring that pictures are taken before, during, and after intrusive activities and placing such pictures in the project file. Pictures should provide visual documentation of actual site conditions, including but not limited to exposed utilities, methods used for bracing utilities and markings placed on the surface by utility locating services. Consideration should also include placing of a known object in the picture field to provide a “scale” for size/distance comparison.
- Completion and maintenance of the Underground Utilities Locating and Marking Checklist (Attachment A) and the Underground Utilities Management Checklist (Attachment B).
- Reviewing applicable Activity Hazard Analyses (AHAs) with all project members before work begins.
- Conducting training on communication protocols to be used by the excavation observer and equipment operator.
- Ensuring implementation of appropriate work practices during intrusive activities (including maintaining the prescribed buffer zone for use of aggressive methods).
- Conducting daily or more frequent (due to changes in conditions) inspections of the excavation area to make sure that all markings are intact.
- Providing the Field Safety Officer (FSO) with all required documentation on a daily basis.

Observer

Whenever intrusive operations with mechanized equipment are being conducted *within three feet of the outside edge of the buffer zone*, horizontally and vertically, an observer must be assigned to monitor the activities. The observer is responsible for:

- Maintaining a safe vantage point relative to digging machinery, excavation edge, and proximity to the hazard posed by the utility.
- Observing the operation to ensure that the operator stops operations if utilities are observed.
- Reviewing hand signals and other forms of communication with the operator. Note: hand signals should be as those identified under ANSI, OSHA, or the Corps of Engineers for Crane Hand Signals, or another, equally effective and understood system.
- Properly signaling the operator.
- Stopping the operation immediately if the observer’s attention must be diverted even momentarily.
- Stopping the operation immediately if a hand signal or other directive is not followed. Operations will not resume until the observer and operator mutually agree that the reason(s) for not complying with the directive(s) are/is identified and fully corrected.
- Maintaining required records, such as logbook entries, or other, as requested by line management.

Line Management

The PM or SM shall be responsible for:

- Establishing the site culture with the assistance of the FSO that ensures compliance with this FLD, as well as providing the leadership to “do the right thing” whenever unanticipated circumstances arise.
- Providing the necessary resources, including sufficient schedule for compliance with this FLD.
- Designating a Competent Person or ensuring that a subcontractor Competent Person is designated, prior to the start of work.
- Discussing intrusive activity liability with the Client prior to the start of work. Best practices for identification of underground utilities must be included with the proposal and/or HASP, as well as WESTON’s requirement for Client sign-off (if the Client is the property owner or if the Client selects the drilling/intrusive action location) when identifying specific work locations for intrusive activities. In cases where the client, such as EPA, will or cannot sign off on liability or provide indemnification, discussions with the appropriate client representatives on intrusive activities will be documented in the project file.

Note: In any ‘target-rich’ work environment, best practices must include the requirement for potholing/daylighting or careful hand-digging – whenever possible (at least 5 feet below grade) – since these are recognized processes for visually verifying the exact location of underground utilities while minimizing the potential for utility damage.

- **For excavations using aggressive methods in target-rich environments**, consideration should be given for establishing an agreement with an Emergency Response Contractor and/or the specific utility owner prior to the start of intrusive activities. This agreement should include specific emergency notification procedures for each utility identified to ensure that timely response can be accomplished in the event of a utility strike.
- Determining/verifying ownership of the property where the intrusive activity will occur, including any easements.
- Contacting all utilities not notified directly by the utility notification center, including those known to local personnel and the property owner.
- Obtaining Profit Center Manager approval for any deviations from this FLD, including best practices, or for addressing any set of circumstances not specifically addressed in this FLD that may place WESTON or its employees at risk.

Environmental, Health, and Safety Personnel

The FSO shall be responsible for:

- Providing oversight on the implementation of the requirements contained in this FLD.
- Consulting with the PM, SM, Competent Person, and the appropriate Division Environmental, Health, and Safety Manager (DEHSM) (or Corporate EHS) on underground utility issues.
- Acting as the Competent Person or Observer as necessary and qualified.

Procedure

The following sections provide the requirements and recommendations, which are intended to prevent injury to personnel, damage to infrastructure, and associated indirect effects associated with encountering

or contacting underground utilities during intrusive work. Underground utilities present multiple potential hazards that must be recognized before and during work which occurs near them, therefore, this procedure is divided into sections addressing underground utility identification and location, working around or near underground utilities, and actions to be taken in the event that underground utilities are encountered or contacted. Hazards that may be presented by underground utilities include explosion and fire, electrocution, toxic exposures, pathogens, and drowning.

Identifying and Locating Underground Utilities

The potential for underground utilities or other subsurface feature (e.g., subsurface mines) must be evaluated as early as possible in the planning phase for any project which involves intrusive activities. The following sections describe various methods for identifying and locating utilities on a site. The *Underground Utilities Locating and Marking Checklist* (Attachment A) and the *Underground Utilities Management Checklist* (Attachment B) must be completed before any activities meeting the definition of excavation are conducted. Attachment A is intended to be used as a guide during the process of locating and marking utilities in the area to be excavated. Attachment B is intended to be used as a guide in the overall process of underground utilities management during the course of the project.

Note: Attachments A and B or their equivalents must be used to document compliance with this FLD and will be subject to audit.

Prior to excavation all underground utilities must be located and identified by at least two of the following:

- The Utility Owner
- The Property Owner
- A Private or Public Utility Locating Service
- Review of the most current utility drawing, maps or other available records by an approved WESTON Competent Person
- Use of utility locating technology by a WESTON Competent Person or subcontractor – this includes the use of potholing or daylighting in a “target-rich” work environment or whenever a full clearance (without restrictions) cannot be obtained from a utility locating service.

As an aid in determining the potential for or existence of utilities follow the criteria outlined in Attachment C (Utilities Research Options).

Pre-Planning and the Site HASP

The site-specific HASP developed for the project must:

- Identify the location and types of underground utilities that are believed to be present on the site.
- Reference this procedure (FLD 34), and describe how it will be implemented on the project.
- Contain an AHA in which the hazards associated with underground utilities are identified, as well as the measures used to control them.
- Contain any site or contract-specific requirements (e.g., Corps of Engineers, EM 385-1-1, Section 25) that may be applicable.
- Contain clear and concise procedures to be followed in the event that contact with underground utilities occurs.

- Address underground utilities and potential associated scenarios in the emergency response section of the HASP.

“One-Call” Locating and Marking Services

Every state has utility marking service programs that have various names such as “One-Call”, “Dig-Safe”, “Call-Before-You-Dig”, “Dig-Safely”, and many others. These services will identify the types and locations of any utility that may exist in an area to be excavated, as long as the property is in the public domain.

- The appropriate One-Call service for the jurisdiction where the project is located must be contacted prior to beginning excavation work. The One-Call Agency should be given as detailed a description of the property as possible; address, cross street, utility pole numbers, physical description, etc.
- Notification to the One-Call service shall allow sufficient lead-time for the Agency to mark the utilities before excavation begins. The lead times vary, but range from two to ten days, depending on the state of jurisdiction.
- In the event the State or Local One-Call service number is in question call "811" (the Federal Call before You Dig Number) for access to the appropriate locator service.
- A complete listing of One-Call agencies and telephone numbers for all states is available in the “*Call-Before-You-Dig Call Center Directory*”, which can be accessed on the Internet at the WebPage (<http://underspace.com/index.htm>) sponsored by “*Underground Focus*” magazine.
- Once notified, the One-Call Agency will provide the contractor with a unique “locate number” or “reference number”. This reference number must be kept in the project files by the Competent Person or designee. Additionally, the reference numbers have expiration dates, which may vary depending on the particular One-Call Agency. The valid period of the locate number and required renew notification date shall be requested from the One-Call Agency.
- On a project with multiple contractors, each contractor must request a separate locate number. Under no circumstances will any other contractor or entity be allowed to “work under our locate number”. Subcontractors to WESTON may excavate under the locate number secured by WESTON, provided that they are excavating within the area which was previously white-lined by WESTON and subsequently marked. **However, the One-Call Agency must be contacted and notified of this arrangement so that the subcontractor can be recorded as working under the existing locate number.** If a WESTON subcontractor will be excavating in an area not white-lined by WESTON, then the WESTON subcontractor must request a new locate. **Note: State and local requirements must be checked for local application of this procedure.**
- The area where work is to be performed shall be white-lined before the locating service goes to the site.
- It is good practice to arrange a pre-excavation meeting at the project site with the personnel performing the utility location and marking. This meeting will facilitate communications, coordinate the marking with actual excavation, and assure identification of high-priority utilities.
- The One-Call Agency should provide the identities of the utility owners that will be notified of the locate request. This information shall be recorded on the Underground Utilities Locating and Marking Checklist (Appendix A) and maintained in the project files. The contact person and phone number for each utility owner shall also be recorded. **Note that all utility owners are not members of the One-Call system.** This does not eliminate the need to contact a non-member owner if you have knowledge or suspect that excavation will impact their utility.

- The utility owners should provide a “positive response” relative to the locate request, which can consist of two types of action by the utility owner. The facility owner or operator is required to 1) mark its underground utilities with stakes, paint, or flags, or 2) notify the excavator that the utility owner/operator has no underground utilities in the area of the excavation.
- The positive responses shall be recorded on the Underground Utilities Locating and Marking Checklist (Attachment A) and crosschecked with the list of utility owners that the One-Call Agency stated they would notify. If it is discovered that a utility owner has not provided a positive response, then the One-Call Agency must be notified.
- Excavation shall not be conducted until positive responses have been received from all utility owners identified by the One-Call Agency as having underground utilities on the property.
- Before beginning excavation, the excavator must verify that the location marked was correct, and the distinct, color-coded markings of all utility owners are present.
- Examine the site to check for any visible signs of underground utilities that have not been located and marked such as pedestals, risers, meters, warning signs, manholes, pull boxes, valve boxes, patched asphalt or concrete pavement, areas of subsidence, fresh sod or grass, lack of grass or vegetation, and new trench lines.
- The markings placed by the utility owners should be documented by WESTON using a still, digital, or video camera, whenever practical and reasonable. The photo-documentation shall be maintained with the project files.
- The markings placed by the utility owners or marking services typically follow the American Public Works Association Uniform Color Code as described in ANSI Standard Z 535.1. This code follows:

American Public Works Association Uniform Color Code

Red		Electric Power Lines, Cables, Conduit
Orange		Communications, Telephone, Cable TV
Yellow		Gas, Oil, Steam, Petroleum or Gaseous Materials
Green		Sewers and Drains
Blue		Potable Water Systems
Purple		Reclaimed Water, Irrigation, Slurry Lines
Pink		Temporary Survey Markings
White		Proposed Excavation

Note: Unless otherwise specified in the utility clearance, such clearance will not be considered valid after 30 days from the date it was issued.

Private Utility Locating and Marking Services

- **One-Call agencies arrange for the identification and marking of underground utilities only on public property, up to the point of contact with private property.** In the event that activities are to be conducted on non-public properties, the presence, location, depth, and orientation of all underground utilities shall be ascertained through records review, including any site plot plans, utility layout plans, and as-built drawings available from the property owner, as well as through interviews with knowledgeable personnel associated with the property (See Attachment C). Additionally, for excavations using aggressive methods in target-rich

environments or other situations where utility locations are in question, the information gathered from these sources shall be verified by physical detection methods (non-aggressive), performance of a geophysical survey, or by procuring the services of a private utility locating and marking service. If any detection methods are to be self-performed, the requirements within this FLD must be followed. **A list of vendors providing this service can be found in the “Network of Underground Damage Prevention Professionals” which can be accessed on the Internet at the “Underspace” WebPage (<http://underspace.com/index.htm>).**

Self-Performance of Utility Locating and Marking

The techniques and instruments used to locate and characterize underground utilities can be extremely complicated and difficult to use effectively. Additionally, interpretation of the data generated by this instrumentation can be difficult. The utility marking services, as previously described are staffed by well-trained, experienced professionals who perform locating activities on a regular basis. For these reasons, it is most desirable that these professional services are used for utility location and marking on projects.

- In some instances on private property or in other areas not served by One-Call agencies (e.g., long-term projects where excavation is a primary task, and the presence of underground utilities is extensive) it may be prudent to self-perform locating and marking activities.
- If locating and marking is to be self-performed, all personnel using instrumentation will be trained on the use of the equipment that will be used, and the interpretation of the data.
- There are a variety of locating methods which may be utilized for self-performance of utility locating as categorized below:
 - Magnetic field-based locators or path tracers
 - Buried electronic marker systems (EMS)
 - Ground penetration radar-based buried –structure detectors
 - Acoustics-based plastic pipe locators
 - Active probes, beacons, or sondes for non-metallic pipes
 - Magnetic polyethylene pipe
- Before self-performing any underground utility locating on a project, approval must be obtained from the appropriate WESTON DEHSM or the Corporate EHS Director.

Working Near or Around Underground Utilities

After the site has been properly evaluated for the presence of aboveground utilities, underground utilities, and other appurtenances, intrusive activities may begin. Because there is no perfect way of eliminating the hazards presented by underground utilities, an effort must be made to perform the tasks following the direction and guidance as described by the following best practices that should be implemented during the execution of the project.

Work Site Review

Before beginning intrusive activities, a meeting shall be held between all members of the project team. This shall consist of a review of the marked utility locations with the equipment operators, observers, laborers, etc.

Preservation of Marks

During excavation, efforts must be made to preserve the markings placed by the utility owners until they are no longer required. If any markings are obliterated, the One-Call Agency must be contacted for re-marking. No intrusive activities are to take place if markings are not visible.

Excavation Observer

Whenever intrusive operations are being conducted within three feet of the edge of the buffer zone, an observer must be assigned to monitor the activities. The observer will be designated each day, and a review of hand signals and other forms of communication between the observer and operator will be conducted. The directives of the observer will be followed precisely and immediately by those operating equipment.

Excavation Within The Buffer Zone

Mechanical means of excavation may not be used within 36 inches (see Buffer Zone) of any marked or suspect utility until the utility has been exposed. Mechanical methods may be used, as necessary, for initial penetration and removal of pavement, rock or other materials requiring use of mechanical means of excavation provided a spotter is used. Once the underground utility has been exposed, further excavation must be performed, employing reasonable precautions to avoid damage to the utility, including but not limited to any substantial weakening of structural or lateral support, or penetration or destruction of the utility or its protective coatings. For purposes of this section, “mechanical means of excavation” means excavation using any device or tool powered by an engine except air vacuum or like methods of excavation.

A request to utilize aggressive excavation methods in the buffer zone may be made if:

- There is no other appropriate and reasonable alternative to using aggressive methods in the buffer zone; and
- The utility has been de-energized (and purged if necessary), verified as de-energized, and locked-out; or
- The depth and orientation of the utility has been adequately and visually determined through the use of non-aggressive methods such as air/hydro/vacuum excavation, potholing, probing, hand-digging, or a combination thereof; and
- For utilities containing electrical energy, the depth of the existing water table is below the location of the utility; and
- Request for the exemption has been submitted to the appropriate DEHSM and Profit Center Manger for approval.

The following conditions will apply to this request:

- Aggressive methods may be used in the buffer zone only to the extent allowed by the applicable state or other jurisdictional regulations.
- Appropriate physical protection measures for exposed utilities shall be implemented to eliminate the potential for equipment contact with utilities.
- The extent of the project excavation area to be covered by the exemption request must be specified in the request for exemption.
- When evaluating the use of aggressive excavation methods in the buffer zone, the DEHSM will consider the type of utility involved and the associated risk potential. Based on this evaluation, the Profit Center Manager and/or DEHSM may impose further conditions and requirements. Even if the above exemption conditions are met, the DEHSM has authority to deny the request.

Unless exempted according to the above provisions of this procedure, only non-aggressive methods may be used within the buffer zone. These methods are used in order to prevent mechanical contact with underground utilities, which could result in damage to the utility and create the potential for personal injury and property damage. Following are examples of non-aggressive excavation methods:

- Hand-digging
 - Non-conductive hand tools must be used when digging within the buffer zone surrounding underground electrical utilities.
 - If conductive hand tools must be used near electrical lines, then the FSO and/or DEHSM shall be consulted to determine additional requirements relative to safe electrical practices, procedures, and equipment.
- Hydro-excavation (water pressure).
- Air excavation (air pressure).
- Vacuum extraction (soil excavation/removal).
- Air excavation/vacuum extraction combination.
- Aggressive methods may be used for the removal of pavement over a utility, if allowed by the state regulations.

Protection of Underground Utilities

It is very important that consideration be given to the protection of underground utilities when performing adjacent intrusive activities. This is necessary not only to prevent physical damage and associated indirect effects, but also to prevent the potential for injury to employees and the public.

- When using aggressive excavation methods within the buffer zone around exposed underground utilities, physical protection must be used as required by OSHA in 29 CFR 1926.651. Basically, this involves creation of a physical barrier between the mechanized operation and the utility. The following are some possible types of physical protective measures:
 - Heavy timbers, similar to swamp or crane mats.
 - Sheets of plywood.
 - Blasting mats.
- Once exposed, underground utilities no longer have the support provided by surrounding soil and may need to be physically supported to prevent shifting, bending, separation, or collapse, which could result in damage to the utility, and possibly personnel. Following are suggested support methods:
 - Timber shoring underneath the utility.
 - Timbers or girders over the top of the excavation fitted with hangers that support the utility.
 - Design by a Professional Engineer for complicated or large applications.
- Utilities must also be protected from objects that may fall into the excavation such as rocks and equipment. This can be accomplished by following these guidelines:
 - Cast spoils as far away from the excavation as possible. Excavated and loose materials shall be kept a minimum of two feet from the edge of excavations.
 - Relocate large rocks, cobbles, and boulders away from the excavation and sloped spoils piles.

- When vehicles and machinery are operating adjacent to excavations, warning systems such as soil berms, stop logs or barricades shall be utilized to prevent vehicles from entering the excavation or trench.
- Scaling or barricades shall be used to prevent rock and soils from falling into the excavation.
- Barriers shall be provided to prevent personnel from inadvertently falling into an excavation.

De-Energizing Utilities

Utilities can carry many types of potential energy, including electricity, flowing liquids, liquids under pressure, or gasses under pressure. A release may happen if a utility conveyance is compromised and could result in personal injury, property damage, and other indirect effects. If the white lines of the proposed excavation area overlaps or extends into the buffer zone of a known underground utility, then if at all possible, that utility should be de-energized to physically prevent the transmission, flow, or release of energy. Conversely, if the buffer zone of the known utility lies outside of the white-lined, proposed excavation area, then de-energizing is not required.

- The owner of the utility shall be contacted to determine the feasibility and methodology of de-energizing the utility. Plenty of lead-time should be provided for this since it may take utility companies weeks to de-energize some utilities.
- Depending on the utility and the material being conveyed, isolation points which may be suitable for de-energizing include but are not limited to the following:
 - Electrical circuit breakers
 - Slide gate
 - Disconnect switches
 - Piping flanges
 - Other similar devices
- When utilities are de-energized, it must be verified by demonstration. This can be accomplished by methods such as, testing equipment, switching on a machine or lighting, or opening a valve. For any current-carrying electrical equipment, such as cables or electrical panels, successful de-energizing must be certified through the use of appropriate electrical testing equipment and qualified personnel.
- Whenever a utility is de-energized, a means of ensuring that the energy isolation device and equipment cannot be operated until the device is removed must be provided.
- When de-energizing and locking out of utilities is practiced, the provisions of FLD 42 Lockout/Tagout shall be followed, as applicable.

Damage Discovery

During excavation, utility damage may be discovered which is pre-existing or otherwise not related to a known contact. Disclosure to the utility owner is very important because the possibility of utility failure or endangerment of the surrounding population increases when damage has occurred. The utility may not immediately fail as a result of damage, but the utility owner or operator must be afforded the opportunity to inspect the utility and make a damage assessment and effect repairs if necessary. The following guidance applies:

- Observe and photograph the utility from a safe distance and determine if there is damage. Damage would be all breaks, leaks, nicks, dents, gouges, grooves, or other damages to utility lines, conduits, coatings, or cathodic protection systems.

- The owner of the affected utility must be contacted immediately.
- The One-Call Agency or private location service must be contacted immediately.
- A Notification of Incident (NOI) Report will be used to document such a discovery.

Encountering Unexpected Underground Utilities

It is possible that underground utilities will be encountered in locations that have previously been “cleared” of having underground utilities by the locating service, or are found outside of the area, which has been marked as having underground utilities. In either case, if this occurs, the following applies:

- Site personnel must be warned and moved to a safe location; equipment engines and ignition sources should be turned off, if possible, as the operator is exiting his/her equipment.
- Intrusive activities must be stopped.
- The owner of the affected utility must be immediately contacted.
- The One-Call Agency or private location service must be contacted immediately.
- The PM, SM, and FSO must be notified.
- No further intrusive activities may be conducted until:
 - The One-Call Agency/private location service and/or the subject utility owner visit the site;
 - Identification of the utility owner and the type of material/energy being conveyed by the utility has been made; and
 - The orientation and depth of the subject utility has been determined and suitably marked.
- A NOI Report must be completed. The report should be accompanied by photographs clearly showing the marking(s), and the actual location, with a distance gauge to document how far off the mark the utility was encountered.

Contacting Underground Utilities

If excavation or other equipment being used for intrusive activities makes contact with an underground utility, the following guidelines apply:

- Site personnel must be warned and moved to a safe location; equipment engines and ignition sources should be turned off, if possible, as the operator is exiting his/her equipment.
- Intrusive activities must be stopped immediately.
- Observe the utility from a safe distance and determine if there is damage. Damage would be all breaks, leaks, nicks, dents, gouges, grooves, scratched coatings, cathodic protection compromise, material leakage, obvious electrical energy.
- Move all personnel to the evacuation meeting point as described in the HASP.

EXCEPTION: *If an electrical line has been contacted and it is your belief that equipment (such as an excavator) is electrically energized, do not approach the equipment. Order the operator to remain in the equipment until emergency personnel can de-energize the source (unless the equipment is on fire, at which time the operator should jump off of the vehicle and shuffle along the ground to a safe area). Shuffling is required because current flows outward through the soil in a ripple pattern called a power gradient, creating a pattern of high and low potential, Shuffling decreases the chance that these gradients could be bridged, causing current to flow through the body, resulting in electrocution.*

- Secure the area to prevent the public from entering.
- Contact emergency responders as specified in the HASP.
- Immediately contact the One-Call Agency or if known, the utility owner.
- Notify the PM, SM, FSO and DEHSM.
- No further intrusive activities may be conducted until:
 - The utility owner inspects the scene and after repairs, verifies that all danger has passed.
 - The orientation and depth of the subject utility has been determined and suitably marked.
 - Permission from the emergency responders to resume work has been given.
- A WESTON NOI Report must be completed. The report should be accompanied by photographs clearly showing the marking(s), and the actual location, with a distance gauge to document how far off the mark the utility was encountered.
- State and Local regulations must be reviewed to determine if reporting to any additional agencies is required.

ATTACHMENTS

Attachment A – Underground Utilities Locating and Marking Checklist

Attachment B – Underground Utilities Management Checklist

Attachment C – Utilities Research Options

Attachment D – Sources of Information

Informational Addendum 16 June 2010

**ATTACHMENT A
UNDERGROUND UTILITIES LOCATING AND MARKING CHECKLIST**

Weston Solutions, Inc.

To be Completed by PM and/or “Competent Person”
Complete Form as Location/Marking Progresses and Maintain in Site Files

PROJECT INFORMATION:	Location:
Project Name:	Task/Activity:
WESTON Competent Person:	Start Date of Work:
WESTON Subcontractor: <input type="checkbox"/> No <input type="checkbox"/> Yes:	Private Locating Service Required: <input type="checkbox"/> Yes <input type="checkbox"/> No
Subcontractor Competent Person:	If Not, Explain:
Property Owner:	
NOTIFICATION:	
Locating Service Name:	Locating Service Tel. Number:
Date Locating Service Notified:	Locate Ticket Number:
Address of Property to be Marked:	Locate Ticket Expiration Date:
Nearest Intersecting Street:	
Are There Any Utilities on the Properties That the Locating Service Will Not Contact? <input type="checkbox"/> Yes <input type="checkbox"/> No	
Specify:	

Enter Utility Information in Table 1 Below. In Addition to Utility Locating Services, Consult Client, Utility Owners, Drawings, Facility Personnel, Maintenance Personnel, Municipalities (See Appendix C).

Table 1. On-Site Utility Information

Name of Utility Company	Type of Utility	Color Code	Utility Present On-Site?	Emergency Phone Number	Date Marks Completed
	Electric	RED			
	Communications, Phone, CATV	ORANGE			
	Gas, Oil, Steam, Petroleum	YELLOW			
	Sewers, Drains	GREEN			
	Potable Water	BLUE			
	Reclaimed Water, Irrigation	PURPLE			
	Temporary Survey Markings	PINK			
To be performed by excavator prior to utility mark-out.	Proposed Excavation	WHITE			

White-Lining Completed?

No Explain: _____ Yes: Date: _____ By Whom? _____

LOCATING AND MARKING:

Have All Utilities Identified in Table 1 Been Marked?

Yes No (If No, Contact Locating Service for Resolution)

Problem(s) With Markings?

Yes No No Marks Incorrect Location Too Wide

Other: _____ Not All Utilities Marked Per Table 1 (notify marking service)

Measurements Taken: Yes No

Documentation of Marks: Photos Video Other: _____

EXCAVATION:

Utilities Accurately Marked? Yes No

If no, describe: _____

Were Unmarked or Mis-Marked Utilities Encountered? Yes No

If Yes, Specify: _____

Locating Service Notified? Yes No

Will Excavation Continue Past Locate Number Expiration? Yes No

If Yes, Locate Number Renewed? Yes No New Expiration Date: _____

Any Other Problems/Concerns? Specify: _____

Form Completed By:	Signature:	Date:
--------------------	------------	-------

**ATTACHMENT B
UNDERGROUND UTILITIES MANAGEMENT CHECKLIST**

Weston Solutions, Inc.

To be Completed by PM and/or “Competent Person”

Complete Form as Project Progresses and Maintain in Site Files.

PHASE	TASK	YES	NO	NA	COMMENTS	
					Required if Response is No or NA. (Reference Item Number)	
Pre-Planning	1	Excavation/Best Practices in Work Scope?				
	2	Underground Utilities Identified?				
	3	Competent Person Assigned?				
	4	Has a Copy of the Applicable State Regulations Been Obtained, Read, Understood?				
	5	EHS Plan Addresses Underground Utilities? (AHAs, Contingency Plan, State Regulations Appendix)				
Identifying, Locating and Marking	6	Locating and Marking Checklist Initiated? (Attachment A)				
	7	Identification and Address of Property Determined, Including Nearest Intersection?				
	8	One-Call Agency Contacted?				
	9	Additional Locating and Marking Required on Property? (One-Call agency marks to public property line only)				
	10	Additional Marker/Locator Identified?				
	11	Additional Marker/Locator Qualified?				
	12	Weston Self-Performing Location and Marking?				
	13	If Yes to 12 Above, Approval From Division EHS Manager?				
	14	Area of Excavation “White-Lined” by WESTON?				
	15	WESTON Present When Markings Completed?				
	16	All Utilities Marked? (Refer to Attachment A, Table 1)				
	17	All Markings Photo/Video Documented?				

PHASE	TASK		YES	NO	NA	COMMENTS Required if Response is No or NA. (Reference Item Number)
Identifying, Locating and Marking – Continued	18	Area Checked for Signs of Previous Excavation? (Subsidence, new grass, patching, etc)				
	19	All Applicable Information Recorded on Attachment A?				
	20	Multiple Contractors Excavating On-Site?				
	21	Separate Locate Requests for All Contractors?				
	22	WESTON Subcontractors Excavating in WESTON White-Lined Area(s)?				
	23	If Yes to 22 Above, One-Call Agency Contacted to Determine if WESTON Subcontractor Can be Added to Existing Locate Ticket?				
Excavation Activities	24	Meeting and Site Walkover Conducted with Project Personnel? (Managers, Equipment Operators, Laborers, Competent Person, Excavation Observer, etc)				
	25	AHA and HASP Review Conducted With Personnel?				
	26	Do Site Activities Have Potential to Obliterate Utility Markings?				
	27	If Yes to 26 Above, Have Provisions Been Made to Preserve Markings?				
	28	Has an Excavation Observer Been Designated to Monitor Excavation When Occurring within 3 Feet of the Buffer Zone?				
	29	Have Operator and Observer Reviewed Commands and Signals?				
	30	Has WESTON-Required Buffer Zone Been Marked on Either Side of Markings Placed by Locator?				

PHASE	TASK		YES	NO	NA	COMMENTS
						Required if Response is No or NA. (Reference Item Number)
Excavation Within Buffer Zone	31	Is Excavation Within The Buffer Zone Absolutely Necessary?				
	32	If Yes to 31 Above, Can Non-Aggressive Methods Be Used For Excavation In The Buffer Zone? If Yes, Identify Appropriate Non-Aggressive Methods.				
	33	If No to 32 Above, Has a Buffer Zone Exemption Request Been Approved? If No, then Aggressive Methods May Not Be Used in The Buffer Zone.				
	34	If Yes to 33 Above, Has the Utility Been De-Energized, Purged, Verified/Tested, and Locked-Out? Or, Has The Depth and Orientation of the Utility Been Adequately and Visually Determined Through The Use of Non-Aggressive Methods?				
	35	If Yes to 34 Above, Have All of The Following Conditions Been Met? For Utilities Containing Electrical Energy, Is The Depth of The Water Table Below The Depth of The Utility? Have Regulations Been Consulted to Determine Specific State Requirements Relative to Excavating in The Buffer Zone? Have Appropriate Physical Protection Measures Been Implemented to Prevent Equipment Contact With Utilities and to Prevent Damage to Utilities? If No to Any of The Above Conditions, Then Only Non-Aggressive Excavation Methods May Conducted in The Buffer Zone, Since The Conditions of The Exemption Have Not Been Satisfied.				
Working Around Exposed Utilities	36	If Necessary, Have Provisions Been Made to Support the Utility During Work Activities?				
	37	Have Spoils Been Placed as far Away From the Excavation as Feasible?				

PHASE	TASK		YES	NO	NA	COMMENTS
						Required if Response is No or NA. (Reference Item Number)
Working Around Exposed Utilities – Continued	38	Has the Utility Been De-Energized? (If Any Portion of the Buffer Zone around a Utility is Inside of the White-Lined Area)				
	39	Has the Isolation Point for the De-Energized Utility Been Physically Locked-Out?				
	40	If No to 39 Above, Has a Spotter Been Assigned to Monitor Isolation Point?				
	41	If Yes to 40 Above, Does the Spotter Have Adequate Communications? (Radio, Telephone, etc)				
	42	Has the Isolation Point Been Tagged?				
Damage Discovery	43	Has Pre-Existing Damage to a Utility Been Discovered During Excavation?				
	44	If Yes to 43 Above, Has the One-Call Agency and/or Utility Owner Been Notified?				
	45	If Yes to 43 Above, Have Photographs Been taken?				
Encountering or Contacting Underground Utilities	46	Have Utilities Been Encountered in Locations That Have Not Been Marked?				
	47	If Yes to 46 Above, Has the One-Call Agency or Other Locating Service Been Contacted?				
	48	If Yes to 46 Above, Has the PM and Appropriate DSM Been Notified?				
	49	If Yes to 46 Above, Has a WESTON Notification of Incident (NOI) Report Been Completed? (Include Photographs)				
	50	Have Excavation Equipment Come In Contact With Underground utilities?				
	51	If Yes to 50 Above, Were Intrusive Activities Immediately Curtailed?				

PHASE	TASK		YES	NO	NA	COMMENTS
						Required if Response is No or NA. (Reference Item Number)
Encountering or Contacting Underground Utilities – Continued	52	If Yes to 50 Above, Has a Damage Determination Been Made From a Safe Distance?				
	53	If Yes to 50 Above, Has the Area Been Secured?				
	54	If Yes to 50 Above, Have Emergency Responders Been Notified?				
	55	If Yes to 50 Above, Has the Locating Agency and/or Utility Owner Been Notified?				
	56	If Yes to 50 Above, Have State and Local Reporting Requirements Been Met?				
	57	If Yes to 50 Above, Were Intrusive Activities Curtailed Until Inspection From Utility Owner, Orientation and Depth of Utility Was Determined and Marked, Permission From Emergency Responders Given?				
	58	If Yes to 50 Above, Has a WESTON Notification of Incident (NOI) Report Been Completed? (Include Photographs)				

CHECKLIST COMPLETED BY:

NAME

SIGNATURE

DATE

NAME

SIGNATURE

DATE

**ATTACHMENT C
UTILITY RESEARCH OPTIONS**

In the course of determining and verifying underground utility location it is expected that a minimum of two resources will be used. As a means of assisting the search for sources, the following is offered.

Records Sources:

- Utility Section of the State DOT or other Public Agency
- One-Call Center
- Public Service Commission or similar organization
- County Clerks Office
- Landowner
- Internet or Computer database
- Visual Site Inspection
- Utility Owner

From the Above Collect:

- Previous construction plans in the area
- Conduit maps
- Direct-Buried Cable records
- Distribution maps
- Service record maps
- As-built and record drawings
- Field notes
- County, city, utility owner or other geographic information system database
- Circuit diagrams
- Oral histories (current or previous employees, residents).

Review Records and Obtain Information For:

- Indications of additional and/or other available records
- Duplicate information that lends credibility to data
- Any additional need for clarifications from owners/others

ATTACHMENT D SOURCES OF INFORMATION

Organizations

- Common Ground Alliance
<http://www.commongroundalliance.com/wc.dll?cga~toppage>
- Center for Subsurface Strategic Action (CSSA)
<http://underspace.com/cs/index.htm>
- DigSafely
<http://www.digsafely.com/digsafely/default.asp>
- National Utility Contractors Association (NUCA)
<http://www.nuca.com/>
- National Utility Locating Contractors Association (NULCA)
<http://underspace.com/nu/index.htm>
- Underground Focus Magazine
<http://underspace.com/uf/index.htm>
- NUCA State Listing of One-Call centers
<http://www.nuca.com/>
- Utility Safety Magazine
<http://www.utilitysafety.com/>

Vendors and Commercial Sites

- RadioDetection, Inc. (Detection Instruments)
<http://www.radiodee.com/>
- Heath Consultants (Detection Instruments)
<http://www.heathus.com/>
- Ben Meadows Company (Detection Instruments)
<http://www.benmeadows.com/cgi-bin/SoftCart.exe/index.html?E+scstore>
- So-Deep, Inc. (Complete Utilities Services)
<http://www.sodeep.com/>
- Concept Engineering Group, Inc. (Air Excavation Equipment)
<http://www.air-spade.com/index.html>
- Rycom Instruments, Inc. (Detection Instruments)
<http://www.rycominstruments.com/>

- Schonstedt Instrument Company (Detection Instruments)
<http://www.schonstedt.com/>
- Forestry Suppliers, Inc. (Fiberglass Probe – “Fiberglass Tile Probe”, Part #77543, Approx. \$20.00, Telephone 800-647-5368)
<http://www.forestry-suppliers.com/>

REFERENCES

Common Ground Study of One-Call Systems and Damage Prevention Best Practices, August 1999, Sponsored by US DOT.

INFORMATIONAL ADDENDUM
16 JUNE 2010

Overview of Underground Utility Detection Methods

Induction Utility Locators

Induction utility locators operate by locating either a background signal or by locating a signal introduced into the utility line using a transmitter. There are three sources of background signals that can be located. A utility line can act like a radio antenna, transmitting electromagnetic signals that can be picked up with a receiver. AC power lines have a 50HZ signal associated with them. This signal occurs in all active AC power lines regardless of voltage. Utilities in close proximity to AC power lines or used as grounds may also have a 50HZ signal that can be located with a receiver. A signal can be indirectly induced onto a utility line by placing the transmitter above the line. Through a process of trial and error, the exact above position can be determined. A direct induced signal can be generated using an induction clamp. The inductor clamp induces a signal on specific utilities. This is the preferred method of tracing, where possible. By virtue of the closed loop, there is little chance of interference with the resulting signals. When access can be gained to a conduit, a flexible insulated trace wire can be used. The resulting signal loop can be traced. This is very useful for non-metallic conduits. Finally, these signals can be located horizontally on the surface using a receiver. The receiver is moved across the estimated location of the utility line until the highest signal strength is achieved. This is the approximate horizontal location of the utility. The receiver is then rotated until minimal signal strength is achieved. This will give the approximate orientation of the utility. Vertical depth, however, derived from this equipment is subject to gross error.

Magnetic Locators

Ferrous Metal or Magnetic locators operate by indicating the relative amounts of buried ferrous metals. They have limited application to locating and identifying utility lines but can be very useful for locating underground storage tanks (UST's) and buried manhole covers or other subsurface objects with a large ferrous metal content.

Electromagnetic Surveys

Electromagnetic survey equipment is used to locate metallic utilities. This method pulses the ground and records the signal retransmitted back to the unit from subsurface metal. Particularly useful for locating metal pipelines and conduit, this device also can help locate other subsurface objects such as UST's, buried foundations (that contain structural steel), and pilings and pile caps (that also contain steel).

Ground Penetrating Radar

Ground Penetrating Radar (GPR) is an electromagnetic method that detects interfaces between subsurface materials with differing dielectric constants (a term that describes an electrical parameter of a material). The GPR system consists of an antenna, which houses the transmitter and receiver; and a profiling recorder, which processes the received signal and produces a graphic display of the data. The transmitter radiates repetitive short-duration EM signals into the earth from an antenna moving across the ground surface. Electromagnetic waves are reflected back to the receiver by interfaces between materials with differing dielectric constants. The intensity of the reflected signal is a function of the contrast in the dielectric constant at the interface, the conductivity of the material, which the wave is traveling through, and the frequency of the signal. Subsurface features which may cause such reflections are: 1) natural geologic conditions such as changes in sediment composition, bedding and cementation horizons, voids, and water content; or 2) man-introduced materials or changes to the subsurface such as soil backfill, buried debris, tanks, pipelines, and utilities. The profiling recorder receives the signal from the antennae and produces a continuous cross section of the subsurface interface reflections, referred to as reflectors.

Depth of investigation of the GPR signal is highly site specific, and is limited by signal attenuation (absorption) of the subsurface materials. Signal attenuation is dependent upon the electrical conductivity of the subsurface materials. Signal attenuation is greatest in materials with relatively high electrical conductivity such as clays and brackish groundwater, and lowest in relatively low conductivity materials such as unsaturated sand or rock. Maximum depth of investigation is also dependent on antennae frequency and generally increases with decreasing frequency; however, the ability to identify smaller features is diminished as frequency decreases.

The various GPR antennas used are internally shielded from aboveground interference sources. Accordingly, the GPR signal is minimally affected by nearby aboveground conductive objects such as metal fences, overhead power lines, and vehicles.

A GPR survey is performed by towing an antenna across the ground along predetermined transect lines. The antennae is either pulled by a person or towed behind a vehicle. Preliminary GPR transects are performed over random areas of the site to calibrate the GPR equipment and characterize overall site conditions. The optimum time range settings are selected to provide the best combination of depth of investigation and data resolution for the subsurface conditions at the site. Ideally, the survey is performed along a pre-selected system of perpendicular or parallel transect lines. The configuration of the transect lines is designed based on the geometry and size of the target and the dimensions of the site. The beginning and ending points of the transect lines and grid intersection points, or nodes, are marked on the ground with spray paint or survey flags. A grid system is used to increase the probability of crossing the short axis of a target providing a more definitive signature in the data. The location of the antenna along a transect line is electronically marked on the cross section at each grid intersection point to allow correlation of the data to actual ground locations. The location of the targets can be marked on the ground surface using spray paint or survey flags.

Acoustic Location Methods

Acoustic location methods generally apply to waterlines. A highly sensitive Acoustic Receiver listens for background sounds of water flowing; (at joints, leaks, etc.) or to sounds introduced into the water main using a transducer. This method may have good identification results, but can be inaccurate. Acoustics can also be utilized to determine the location of plastic gas lines.

FLD 38 HAND AND POWER HAND TOOLS

REFERENCES

29 CFR 1926 Subpart I

29 CFR 1910 Subpart P

ANSI Standard A10.3-1970, Safety Requirements for Explosive-Actuated Fastening Tools

RELATED FLDs

FLD 06 – Cold Stress

FLD 10 – Manual Lifting and Handling of Heavy Objects

FLD 16 – Pressure Systems: Compressed Gas Systems

FLD 35 – Electrical Safety

INTRODUCTION

Injuries from hand tools are often caused by improper use, using the wrong tool for the job, or from using a defective tool. Workers often assume that they know how to use a common hand tool. Working with something other than the simplest non-powered hand tools shall be performed only by those persons competent or qualified through formal training or documented experience.

Like all tools, hand and power tools must be maintained properly for effective use and safety. This Field Operating Procedure describes general safety guidelines for the four major categories of hand tools: cutting tools, torsion tools, impact tools, and power tools.

The use of any machinery, tool, material, or equipment which is not in compliance with any applicable OSHA 1910/1926 requirement is prohibited. Any tools or equipment identified as unsafe or defective will be “tagged or locked-out.” Controls shall be applied rendering the unsafe or defective tool or equipment inoperable. Any damaged or defective equipment shall be removed from its place of operation. Weston shall be responsible for the safe condition of tools and equipment used by employees, including tools and equipment that may be furnished by employees.

Tags shall be used as a means to prevent accidental injury or illness to employees who are exposed to hazardous or potentially hazardous conditions, equipment or operations, which are out of the ordinary, unexpected, or not readily apparent. Tags shall be used until the identified hazard is eliminated or the hazardous operation is completed. Tags need not be used where signs, guarding, or other positive means of protection are being used.

GENERAL SAFETY RULES – APPLICABLE TO USE OF ALL TOOLS

- Tools will be inspected prior to each use. Tools found to be unsafe will be tagged by the inspector “Do Not Use” and either repaired or removed from the site.
- Keep the work area clear of clutter.
- Keep the work area properly illuminated.
- Maintain and keep tools sharpened, oiled, and stored in a safe, dry place.
- Wear ear and eye protection when cutting, sawing, drilling, or grinding.
- Supervisor should instruct everyone using equipment on safe procedures before they use them.
- Inspect tools, cords, and accessories regularly and document any repairs.

- Repair or replace problem equipment immediately.
- Electric power tools must have a 3-wire cord plugged into a grounded receptacle, be double-insulated or powered by a low-voltage isolation transformer, and fitted with guards and safety switches.
- Machine guards must be in-place and not removed during equipment operation.
- Do not alter factory-supplied safety features on tools.
- Install and repair equipment only if you are qualified.
- Use the right tool for the job; for instance, do not use a screwdriver as a chisel or a wrench as a hammer.
- Carry a sharp tool pointed downward or place in a tool belt or toolbox.
- Protect a sharp blade with a shield.
- Store tools in drawers or chests with cutting edge down.
- When using power tools, wear long hair in a protective manner, do not wear jewelry or loose clothing, use safety glasses, respiratory protection, hard hats, etc., as needed/specified by the manufacturer. Note that protective gloves should not be worn when operating powered woodworking tools because of the possibility of the work piece snagging the glove and pulling the hand to the cutting surface.
- All hand-held power-driven tools must be equipped with one of the following: a constant pressure switch that shuts off the power upon release (e.g., circular saws, hand-held power drills, chain saws) or an on-off switch (e.g., routers, planers scrolls saws, jigsaws).
- Never leave a running tool unattended.
- All workers using hand and power tools must be properly trained, and training must be documented.
- Tools of a non-sparking material must be used if fire/explosion hazards exist.
- All fuel-operated tools shall be stopped and allowed to cool prior to being refueled, serviced, or maintained, and proper ventilation provided when used in enclosed spaces.
- Bench grinders shall be properly grounded. Work rests must be kept at a distance not to exceed 1/8 inch from the grinding wheel surface.
- All persons using grinders or abrasive wheels shall use approved eye-protective devices.
- Hand held grinders shall have grinding wheel guards in place during operation.
- Train personnel to recognize that tasks involving lifting, repetitive motion, excess pressure, vibration, awkward positions, and remaining stationary for prolonged periods and work in cold conditions increase the risk of musculoskeletal injury. Procedures for avoiding or minimizing risk include: using mechanical devices for lifting, following procedures in FLD 10 when manual lifting is necessary, using shock absorbing gloves when using vibrating tools, choosing tools that reduce gripping force and align joints in a neutral position or holding tools in an ergonomically neutral position, taking breaks or alternating repetitive jobs, and following procedures in FLD 06.
- Hand tools such as chisels and punches, which develop mushroomed heads during use must be taken out of service and reconditioned by qualified persons or replaced, as necessary.
- Broken or fractured handles on hammers, axes and similar equipment must be replaced promptly.
- Worn or bent wrenches must be replaced.

- Handles designed for use on files and similar tools must be used.
- Jacks must be checked periodically to ensure they are in good operating condition

TORSION TOOLS

Torsion tools are used to grip, fasten, and turn. These include wrenches, pliers, screwdrivers, vises, and clamps. There is a variety of each type of these tools. Selection is very important. Here are a few safety precautions for common torsion tools:

- Wrenches should always be pulled and not pushed. Pushing a wrench can cause a loss of control if there is a sudden release of pressure. A short, steady pull should be used rather than quick, jerky motions. Where available, use a socket wrench instead of an adjustable or open-ended wrench. Socket wrenches are generally easier to control, are more convenient, and are less likely to damage a bolt or nut. When using an adjustable wrench, the pressure should be applied to the fixed jaw
- Pipe wrenches can easily slip on pipes or fittings, causing injury. To prevent slipping, make sure that the pipe or fitting is clean and the wrench jaws are sharp and kept clean of oil and debris.
- Pliers should never be substituted for a wrench. They do not have the same gripping power and can easily slip on a tight object. When using cutting pliers, the object being cut can fly off and cause injury. Wear safety glasses when cutting with pliers.
- Screwdrivers are often misused. They should not be used for prying, or as punches or wedges. These misuses can damage the head of the screwdriver. A dull tip can cause the screwdriver to slip. The tip must be flat at the tip and tapered for a snug fit on the screw.
- When using vises, make sure that the vise is bolted solidly to a base (e.g., work bench). When cutting material in a vise, try to cut as close to the vise as possible to minimize vibration.
- Oil vises regularly.

Screwdrivers

- Most screwdrivers are not designed to be used on electrical equipment. Use an insulated screwdriver.
- Do not hold an object in the palm of one hand and press a screwdriver into it; place the object on a bench or a table.
- Never hammer with a screwdriver.
- Check for broken handles, bent blade, etc.
- Select a screwdriver of the proper size to fit the screw.
- Screwdrivers with a split or splintered handle shall not be used.
- The point shall be kept in proper shape with a file or grinding wheel.
- Screwdrivers shall not be used as a substitute punch, chisel, nail-puller, etc.

Pliers

- Do not use pliers as a substitute for hammers or wrenches.
- Use insulated pliers when doing electrical work.

- Inspect pliers frequently to make certain that they are free of breaks or cracks.
- Pliers shall be kept free from grease and oil and- the teeth or cutting edges shall be kept clean and sharp.
- The fulcrum pin, rivet or bolt shall be snug but not tight.

Wrenches

- Select the correct size of wrench for the job.
- Never use a piece of pipe or another wrench as a wrench handle extension.
- Too much leverage can ruin a tool and cause injury.
- To avoid sudden slips, stand in a balanced position and always pull on the wrench instead of pushing against the fixed jaw.
- Only wrenches in good condition shall be used; a bent wrench, if straightened, has been weakened and shall not be used.
- Watch for sprung jaws on adjustable wrenches.
- Always pull toward yourself, never push, since it is easier to brace against a sudden lunge toward you should the tool slip or break.
- When using a wrench on a tight nut - first use some penetrating oil, use the largest wrench available that fits the nut, when possible pull on the wrench handle rather than pushing, and when possible apply force to the wrench with both hands while both feet are firmly placed. Always assume that you may lose your footing - check the place where you may fall for sharp objects.
- Keep all pipe wrenches clean and in good repair. The jaws of pipe wrenches should be wire brushed frequently to prevent an accumulation of dirt and grease that would otherwise build up and cause wrenches to slip.
- Never use pipe wrenches in place of a rod holding device.
- Replace hook and heel jaws when they become visibly worn.
- Position your hands so that your fingers will not be smashed between the wrench handle and the ground or other work surface; when breaking joints the wrench may slip or the joint may suddenly let go.

IMPACT TOOLS

Impact tools include various types of hammers such as riveting hammers, carpenter's claw hammers, and sledgehammers. The main hazard associated with all these tools is damage to the hands and arms. The following safety procedures should be employed when using hammers:

- The handle shall be securely fitted and suited for the type of job and type of hammerhead. The striking face of the hammer shall be kept well dressed according to the application.
- The handle shall be smooth and free of oil to prevent slippage.
- Safety goggles shall be worn at all times when hammering to protect from flying nails, wood chips, and metal or plastic fragments.

- To properly drive a nail, hold the hammer near the end of the handle and start off with a light blow. Increase power after the nail is set.
- To avoid chipping or spalling of the hammerhead, use the lightest swing possible, hammer straight and not on an angle. Inspect the head of the hammer for potential chipping and spalling.

Hammers

- Use the correct hammer for the type of work to be done.
- Have an unobstructed swing when using a hammer and watch for overhead interference.
- Check for defects before using.
- The head of a hammer shall be wedged securely and squarely on the handle and neither the head nor the handle shall be chipped or broken.

CUTTING TOOLS

The main hazard associated with cutting tools is tool slippage. A dull tool or poor tool technique can cause a slip, which can redirect the cutting part of the tool toward the body. In addition, a sudden release or change in the force applied to a tool can throw the user off balance, possibly falling into another object, which may cause injury. To prevent slippage, tools shall be kept sharp and handled in such a way that, if a slip occurs, the direction of force will be away from the body. In addition, cutting along the grain of a material can help prevent changes in the pressure applied to the tool, thereby preventing slippage.

Chisels

- Always wear safety goggles or a face shield when using a chisel.
- Drive wood chisel outward and away from your body.
- Do not use chisels to pry.
- Keep edges sharp for most effective work and protect when not in use.

Knives

- Always cut away from the body.
- Keep hands and body clear of the knife stroke.
- Use a locking blade knife when possible.
- Keep blades sharp.
 - Knives and other sharp or edged tools must be maintained in proper condition. A sharp edged tool, used properly, is safer than a dull or improperly maintained tool.
 - When not in immediate use edged tools must be properly secured via, sheathing, closing, capping or covering.
 - Any task involving the use of an edged tool must be properly evaluated, alternatives to edged tools reviewed and training in the proper use, maintenance and handling verified by management and/or the site safety officer.
 - Knives, box cutters or like tools will not be authorized for cutting plastic wire ties or tubing. Use appropriately shaped and sized wire cutters or snips.
 - Remove knives from carry on luggage and place in checked baggage.

POWERED TOOLS

- Portable power tools shall be carefully inspected before use and shall be kept repaired.
- Switches and plugs must operate properly, and the cords must be clean and free from defects.
- Portable powered tools capable of receiving guards and/or designed to accommodate guards shall be equipped with guards to prevent the operator from having any part of his body in the danger zone during the operating cycle.
- Electric powered portable tools with exposed conducting parts shall be grounded. Portable tools protected by an approved system of double insulation, or its equivalent, need not be grounded. Where such an approved system is employed, the equipment shall be distinctively marked.
- Hand-held powered tools of a hazardous nature such as circular saws having a blade diameter greater than two inches, chain saws, percussion tools, drills, tappers, fasteners, drivers, grinders with wheels greater than two inches in diameter, disc sanders, belt sanders, reciprocating saws, saber scroll saws and jig saws with blade shanks greater than one-fourth inch, and other similarly operating powered tools shall be equipped with a constant pressure switch or control ("dead-man switch") that will shut the power off when the pressure is released.
- Portable circular saws having a blade diameter over two inches shall be equipped with guards or hoods which will automatically adjust themselves to the work when the saw is in use, so that none of the teeth are exposed to contact above the work. When withdrawn from the work, the guard shall completely cover the saw to at least the depth of the teeth. The saw shall not be used without a shoe or guide.
- Pneumatic powered portable tools shall be equipped with automatic air shut-off valves that stop the tool when the operators hand is no longer in contact with the tool. Safety clips, retainers, or other effective means shall be installed on pneumatic tools to prevent the tools from accidentally misfiring.
- Abrasive wheels with a diameter of more than two inches shall be used only on machines provided with safety guards. The guards shall cover the spindle end, nut, and flange projections. Guards on operations where the work provides a suitable measure of protection to the operator may be so constructed that the spindle end, nut, and other flanges are exposed.
- Explosive-actuated fastening tools' muzzle ends shall have a protective shield or guard designed to confine any flying fragments or particles. The tool shall be so designed that it cannot be fired unless it is equipped with a protective shield or guard. Weston Solutions, Inc. employees are not permitted to use a power-actuated tool until properly trained as prescribed by the manufacturer.

Extension Cords

See FLD 35, Electric Safety, for requirements and procedures for using extension cords.

SPECIALTY TOOLS

Pneumatic Powered Tools

Tools powered by air must be inspected and maintained as described above. Hose or tubing used to deliver air to pneumatic tools must be used as required and according to procedures in FLD 16, Pressure Systems: Compressed Gas Systems.

Powder-Actuated Tools

- Only employees who have been trained in the operation of the particular tool in use shall be allowed to operate a powder-actuated tool.
- Powder-actuated tools shall be tested each day before loading to see that safety devices are in proper working condition. The method of testing shall be in accordance with the manufacturer's recommended procedure.
- Any tool found not in proper working order, or that develops a defect during use, shall be immediately removed from service and not used until properly repaired.
- Personal protective equipment shall be selected in accordance with manufacturer's recommendations and in consideration of the potential hazards of the task.
- Tools shall not be loaded until just prior to the intended firing time. Neither loaded nor empty tools are to be pointed at any employees. Hands shall be kept clear of the open barrel end.
- Loaded tools shall not be left unattended.
- Fasteners shall not be driven into very hard or brittle materials including, but not limited to, cast iron, glazed tile, surface-hardened steel, glass block, live rock, face brick, or hollow tile.
- Driving into materials easily penetrated shall be avoided unless such materials are backed by a substance that will prevent the pin or fastener from passing completely through and creating a flying missile hazard on the other side.
- No fastener shall be driven into a spalled area caused by an unsatisfactory fastening.
- Tools shall not be used in an explosive or flammable atmosphere.
- All tools shall be used with the correct shield, guard, or attachment recommended by the manufacturer.
- Powder-actuated tools used by employees shall meet all other applicable requirements of American National Standards Institute, A10.3-1970, Safety Requirements for Explosive-Actuated Fastening Tools.

RST 3 FLD 43A ANIMALS

Animals represent hazards because of their poisons or venoms, size and aggressiveness, diseases transmitted, or the insects they may carry.

Feral Animals

Landfills and abandoned buildings often attract stray or abandoned dogs. These animals often become pack-oriented, very aggressive, and represent serious risk of harm to unprotected workers.

Workers entering abandoned buildings should be alert for such animals and avoid approaching them since this may provoke aggressive behavior. Avoidance and protection protocols include watching for animal dens, using good housekeeping, and using repellents.

Dangerous Wild Animals

Work in remote areas inhabited by wild animals that have been known to cause injury and kill human beings, requires that companies working in these areas carefully plan for wildlife encounters. This FLD outlines actions that, when properly implemented, should provide a high degree of protection for WESTON employees and wildlife.

See Wildlife Hazard Recognition and Protection Procedure (Attached).

Venomous Snakes and Lizards

Venomous Snakes

Venomous snakes are common around the world. The major variables are the likelihood of encounter and the snake that is likely to be encountered. Encounters with snakes may be caused by moving containers, reaching into holes, or just walking through high grass, swampy areas, or rocks. **Do not attempt to catch any snakes.**

Symptom of venomous snake bites:

- Bloody wound discharge, blurred vision, burning, convulsions, diarrhea, dizziness, excessive sweating, fainting, fang marks in the skin, fever, increased thirst, local tissue death, loss of muscle coordination, nausea and vomiting, numbness and tingling, rapid pulse, severe pain, skin discoloration, swelling at the site of the bite, weakness.

Venom from venomous snakes and lizards can be divided into three types of toxins, however, there are some indications that snake venom may have more than one toxin and characteristics may change as a snake ages. The three types of toxins and their effects are:

Hemotoxins destroy blood cells and affect the circulatory system. The site of the bite rapidly becomes swollen, discolored, and painful. This is usually accompanied by swelling, discoloration, and pain progressing toward the heart.

Neurotoxins affect the nervous system and symptoms vary from foggy vision, dizziness, and other comparatively mild symptoms to rigid or flaccid paralysis, shortness of breath, weakness or paralysis of the lower limbs, double vision, inability to speak or swallow, drooping eyelids, and involuntary tremors of the facial muscles. Death can occur in as little as ten minutes, usually due to abrupt cessation of respiration.

Myotoxins destroy cells and cause muscle necrosis.

In the US, with the exception of the coral snakes which tend to have neuron-toxic venom, most venomous snakes have been categorized as having hemotoxic venom (in some areas Mojave rattlesnakes are found to have neuron-toxic venom). There is some indication that some species of rattlesnakes have both hemotoxic and neuron-toxic venom. It is also reported that venom of younger snakes may be more neuron-toxic

There are many highly venomous snakes worldwide, some are deadly and most can be deadly without proper care.

Geographical Listing of Venomous Snakes

Following is a list of poisonous snakes by geographic area. This list is extensive but may not be all inclusive. In planning for work around the world, also contact local agencies to determine whether there may be additional venomous snakes or lizards.

North America

Copperheads (Broad-banded, Northern, Osage, Southern, Trans-Pecos)

Rattlesnakes Diamondback (eastern and western), Massasauga (eastern and western)

Cottonmouth or water moccasin (Eastern)

Prevention of Bites

Key factors to working safely in areas where snakes or lizards may be encountered include:

- Be alert
- Use care when reaching into or moving containers
- Use sticks or long-handled tools when reaching where you cannot see
- Be familiar with the habits and habitats of snakes in the vicinity of an incident or site
- In areas or activities where encounters with snakes are likely, wear sturdy leather or rubber work boots and snake chaps
- Do not attempt to catch snakes unless required and qualified

A snake bite warrants medical attention after administration of proper first-aid procedures. It is important to contact local medical facilities to determine where anti-venoms are located.

First-Aid

1. Keep the person calm. Restrict movement, and keep the affected area below heart level to reduce the flow of venom.
2. Remove any rings or constricting items because the affected area may swell. Create a loose splint to help restrict movement of the area.
3. If the area of the bite begins to swell and change color, the snake was probably venomous.
4. Monitor the person's vital signs -- temperature, pulse, rate of breathing, and blood pressure if possible. If there are signs of shock (such as paleness), lay the person flat, raise the feet about a foot, and cover the person with a blanket.
5. Get medical help immediately.
6. Try to photograph or identify the snake. Do not waste time hunting for the snake, and do not risk another bite. Be careful of the head of a dead snake. A snake can actually bite for up to an hour after it is dead (from a reflex).
 - DO NOT allow the person to become over-exerted. If necessary, carry the person to safety.
 - DO NOT apply a tourniquet.
 - DO NOT apply cold compresses to a snake bite.
 - DO NOT cut into a snake bite with a knife or razor.
 - DO NOT try to suction the venom by mouth.
 - DO NOT give stimulants or pain medications unless instructed to do so by a doctor.
 - DO NOT give the person anything by mouth.
 - DO NOT raise the site of the bite above the level of the person's heart
 - Transport the victim to medical attention immediately

Animal Borne Diseases

Rabies

Animal borne diseases include rabies (generally found in dogs, skunks, raccoons, bats, and foxes). Rabies varies from area to area as do the animals most likely to be rabid.

Questions and Answers about Rabies

Q. What is Rabies and how is it transmitted?

A. Rabies is a viral infection most often transmitted by bites of animals infected with the virus.

Q. What animals are most likely to be infected?

A. Skunks, raccoons, foxes, and bats are wild animals most frequently found to be infected with rabies; however, any warm blooded animal can be infected. Squirrels, groundhogs, horses, cattle, and rabbits have been tested positive for rabies. Dogs and cats are frequently rabies-infected if not immunized.

Q. How can you tell if an animal is rabies-infected?

A. Rabies infection is not always apparent. Signs to look for in wild animals are over-aggressiveness or passivity. Spotting animals which are normally nocturnal (active at night) during the day and being able to approach them would be an example of unusual behavior. Finding a bat alive and on the ground is abnormal. The best precaution, however, is to observe wild animals from a safe distance, even if they are injured. Avoid dogs and cats that you do not know.

Q. What should you do if bitten by an animal you suspect is infected with rabies?

A. As quickly as possible, wash the bite area with soap and water, then disinfect with 70% alcohol and seek medical attention for follow-up. Try to capture the animal. Avoid being bitten again or contacting the mouth or any saliva of the animal. Keep the animal under surveillance and call the police for assistance to capture it. Have the animal tested.

A dead animal believed to be infected should be preserved and tested for rabies. Health departments are often sources where information can be found regarding testing.

Q. Is there a cure for rabies?

A. Rabies is preventable, even after being bitten, if treatment is begun soon enough. Getting prompt medical attention and confirming the rabies infection of an animal are very important. **Rabies is not curable once symptoms or signs of rabies appear.**

There are vaccines available that should be considered if a work assignment involves trapping animals likely to carry rabies. Medical consultants must be involved in decisions to immunize workers against rabies.

Hantavirus

WESTON employees or contractors/subcontractors conducting field work in areas where there is evidence of a rodent population should be aware of an increased level of concern regarding the transmission of “Hantavirus”-associated diseases. Hantavirus is associated with rodents, especially the deer mouse (*Peromyscus manicularis*) as a primary reservoir host. Hantavirus has resulted in several deaths in the U.S.

The Hantavirus can be transmitted by infected rodents through their saliva, urine, and feces. Human infection may occur when infected wastes are inhaled as a result of aerosols produced directly from the animals. They also may come from dried materials introduced into broken skin or onto mucous membranes. Infections in humans occur most in adults and are associated with

activities that provide contact with infected rodents in rural/semi-rural areas. Hantavirus begins with one or more flu-like symptoms (i.e., fever, muscle aches, headache, and/or cough) and progresses rapidly to severe lung disease. Early diagnosis and treatment are vital.

Prevention

Personnel involved in work areas where rodents and the presence of the Hantavirus are known or suspected will need to take personal protective measures and to develop an expanded site safety plan.

Field personnel involved in trapping or contacting rodents or their waste products will need to wear respirators with high-efficiency particulate air (HEPA) filters, eye protection, Tyvek coveralls, chemical-resistant gloves, and disposable boot covers. Strict decontamination requirements are needed. Double-bag, label, and specific handling, packaging, shipping, storage, and analytical procedures are required to minimize the risks of exposure from collected mice. More detailed procedures can be obtained from WESTON Corporate Health and Safety.

For employees and facilities in rural/semi-rural areas, the following risk-reduction strategies are appropriate:

- Eliminate rodents and reduce availability of food sources and nesting sites used by rodents.
- Store trash/garbage in rodent-proof metal or thick plastic containers with tight lids.
- Cut all grass/underbrush in proximity to buildings.
- Prevent rodents from entering buildings (e.g., use steel wool, screen, etc., to eliminate openings).

Plague

Described under Insects (Fleas)

Anthrax

Anthrax is an acute infectious disease caused by the spore-forming bacterium *Bacillus anthracis*. Anthrax most commonly occurs in wild and domestic lower vertebrates (cattle, sheep, goats, and other herbivores), but it can also occur in humans when they are exposed to infected animals or tissue from infected animals.

Anthrax is most common in agricultural regions where it occurs in animals. When anthrax affects humans, it is usually due to an occupational exposure to infected animals or their products. Workers who are exposed to dead animals and animal products from other countries where anthrax is more common may become infected with *B. anthracis* (industrial anthrax). Anthrax in wild livestock has occurred in the U.S.

Anthrax infection can occur in three forms: cutaneous (skin), inhalation, and gastrointestinal. *B. anthracis* spores can live in the soil for many years, and humans can become infected with anthrax by handling products from infected animals or by inhaling anthrax spores from contaminated animal products. Anthrax can also be spread by eating undercooked meat from infected animals. It is rare to find infected animals in the U.S.

Cutaneous: Most (about 95%) anthrax infections occur when the bacterium enters a cut or abrasion on the skin, such as when handling contaminated wool, hides, leather, or hair products (especially goat hair) of infected animals. Skin infection begins as a raised itchy bump that resembles an insect bite but within 1-2 days develops into a vesicle and then a painless ulcer, usually 1-3 cm in diameter, with a characteristic black necrotic (dying) area in the center. Lymph glands in the adjacent area may swell. About 20% of untreated cases of cutaneous anthrax will result in death. Deaths are rare with appropriate antimicrobial therapy.

Inhalation: Initial symptoms may resemble a common cold. After several days, the symptoms may progress to severe breathing problems and shock. Inhalation anthrax is usually fatal.

Intestinal: The intestinal disease form of anthrax may follow the consumption of contaminated meat and is characterized by an acute inflammation of the intestinal tract. Initial signs of nausea, loss of appetite, vomiting, and fever are followed by abdominal pain, vomiting of blood, and severe diarrhea. Intestinal anthrax results in death in 25% to 60% of cases.

Anthrax is not known to spread from one person to another person. Communicability is not a concern in managing or visiting patients with inhalation anthrax.

Prevention

In countries where anthrax is common and vaccination levels of animal herds are low, humans should avoid contact with livestock and animal products and avoid eating meat that has not been properly slaughtered and cooked. Also, an anthrax vaccine has been licensed for use in humans. The vaccine is reported to be 93% effective in protecting against anthrax.

Doctors can prescribe effective antibiotics. To be effective, treatment should be initiated early. If left untreated, the disease can be fatal.

Direct person-to-person spread of anthrax is extremely unlikely; however, a patient's clothing and body may be contaminated with anthrax spores. Effective decontamination of people can be accomplished by a thorough wash down with anti-microbe effective soap and water. Waste water should be treated with bleach or other anti-microbial agent. Effective decontamination of articles can be accomplished by boiling contaminated articles in water for 30 minutes or longer and using common disinfectants. Chlorine is effective in destroying spores and vegetative cells on surfaces. Burning the clothing is also effective. After decontamination, there is no need to immunize, treat, or isolate contacts of people ill with anthrax unless they also were also exposed to the same source of infection. Early antibiotic treatment of anthrax is essential—delay seriously lessens chances for survival. Treatment for anthrax infection and other bacterial infections

includes large doses of intravenous and oral antibiotics, such as fluoroquinolones, like ciprofloxacin (cipro), doxycycline, erythromycin, vancomycin, or penicillin. In possible cases of inhalation anthrax exposure to unvaccinated personnel, early antibiotic prophylaxis treatment is crucial to prevent possible death.

No skin, especially if it has any wounds or scratches, should be exposed. Disposable personal protective equipment is preferable, but if not available, decontamination can be achieved by washing any exposed equipment in hot water, bleach and detergent. Disposable personal protective equipment and filters should be burned and buried. The size of *Bacillus anthracis* bacilli ranges from 0.5 μm to 5.0 μm . Anyone working with anthrax in a suspected or confirmed victim should wear respiratory equipment capable of filtering this size of particle or smaller. The U.S. National Institute for Occupational Safety and Health (NIOSH) and Mine Safety and Health Administration (MSHA) approved high efficiency-respirator, such as a half-face disposable respirator with a HEPA filter, is recommended. All possibly contaminated bedding or clothing should be isolated in double plastic bags and treated as possible bio-hazard waste. Dead victims that are opened and not burned provide an ideal source of anthrax spores; the victim should be sealed in an airtight body bag. Cremating victims is the preferred way of handling body disposal. No embalming or autopsy should be attempted without a fully equipped biohazard lab and trained and knowledgeable personnel.

Delays of only a few days may make the disease untreatable and treatment should be started even without symptoms if possible contamination or exposure is suspected. Animals with anthrax often just die without any apparent symptoms. Initial symptoms may resemble a common cold – sore throat, mild fever, muscle aches and malaise. After a few days, the symptoms may progress to severe breathing problems and shock and ultimately death. Death can occur from about two days to a month after exposure with deaths apparently peaking at about 8 days after exposure. [8] Antibiotic-resistant strains of anthrax are known.

Aerial spores can be trapped by a simple HEPA or P100 filter. Inhalation of anthrax spores can be prevented with a full-face mask using appropriate filtration. Unbroken skin can be decontaminated by washing with simple soap and water. All of these procedures do not kill the spores which are very hard to kill and require extensive treatment to eradicate them. Filters, clothes, etc. exposed to possible anthrax contaminated environments should be treated with chemicals or destroyed by fire to minimize the possibility of spreading the contamination.

In recent years there have been many attempts to develop new drugs against anthrax; but the existing supply still works fine if treatment is started soon enough.

Prevention can also be accomplished through early detection. In response to the U.S. Postal Service (USPS) anthrax attacks of October 2001, the USPS has installed BioDetection Systems (BDS) in their large-scale mail cancellation facilities. BDS response plans have been formulated by the USPS in conjunction with local responders including fire, police, hospitals, and public health. Employees of these facilities have been educated about anthrax, response actions and prophylactic medication. Because of the time delay inherent in getting final verification that anthrax has been used, prophylactic antibiotics for possibly exposed personnel should commence as soon as possible.

The ultimate in prevention is vaccination against infection but this has to be done well in advance of exposure.

Anthrax spores can survive for long periods of time in the environment after release. Methods for cleaning anthrax contaminated sites commonly use oxidizing agents such as peroxides, ethylene Oxide, Sandia Foam, chlorine dioxide (used in the Hart Senate office building), and liquid bleach products containing sodium hypochlorite. These agents slowly destroy bacterial spores. A bleach solution for treating hard surfaces has been approved by the EPA and can be prepared by mixing one part bleach (5.25%-6.00%) to one part white vinegar to eight parts water. Bleach and vinegar must not be combined together directly, rather some water must first be added to the bleach (e.g., two cups water to one cup of bleach), then vinegar (e.g., one cup), and then the rest of the water (e.g., six cups). The pH of the solution should be tested with a paper test strip; and treated surfaces must remain in contact with the bleach solution for 60 minutes (repeated applications will be necessary to keep the surfaces wet).

Chlorine dioxide has emerged as the preferred biocide against anthrax-contaminated sites, having been employed in the treatment of numerous government buildings over the past decade. Its chief drawback is the need for *in situ* processes to have the reactant on demand.

To speed the process, trace amounts of a non-toxic catalyst composed of iron and tetra-amido macrocyclic ligands are combined with sodium carbonate and bicarbonate and converted into a spray. The spray formula is applied to an infested area and is followed by another spray containing tertiary-butyl hydroperoxide

Using the catalyst method, a complete destruction of all anthrax spores takes 30 minutes. A standard catalyst-free spray destroys fewer than half the spores in the same amount of time. They can be heated, exposed to the harshest chemicals, and they do not easily die.

Brucellosis

Brucellosis, also called undulant fever or Malta fever, is a zoonosis (infectious disease transmitted from animals to humans) caused by bacteria of the genus *Brucella*. It is primarily a disease of domestic animals (goats, pigs, cattle, dogs, etc.) and humans and has a worldwide distribution.

Although brucellosis can be found worldwide, it is more common in countries that do not have good standardized and effective public health and domestic animal health programs. Areas currently listed as high risk include the Caribbean.

The disease is transmitted either through contaminated or untreated milk (and its derivatives) or through direct contact with infected animals, which may include dogs, pigs, camels, and ruminants, primarily sheep, goats, cattle, and bison. This also includes contact with their carcasses.

Leftovers from parturition are also extremely rich in highly virulent brucellae. Brucellae, along with leptospira have the unique property of being able to penetrate through intact human skin, so infection by mere hand contact with infectious material is likely to occur.

The disease is now usually associated with the consumption of un-pasteurized milk and soft cheeses made from the milk of infected animals and with occupational exposure of veterinarians and slaughterhouse workers. Some vaccines used in livestock, most notably *B. abortus* strain 19 also cause disease in humans if accidentally injected. Problems with vaccine induced cases in the United States declined after the release of the RB-51 strain developed in the 1990s and the relaxation of laws requiring vaccination of cattle in many states.

The incubation period of brucellosis is, usually, of one to three weeks, but some rare instances may take several months to surface.

Brucellosis induces inconstant fevers, sweating, weakness, anemia, headaches, depression and muscular and bodily pain.

The symptoms are like those associated with many other febrile diseases, but with emphasis on muscular pain and sweating. The duration of the disease can vary from a few weeks to many months or even years. In first stage of the disease, septicaemia occurs and leads to the classic triad of undulant fevers, sweating (often with characteristic smell, likened to wet hay) and migratory arthralgia and myalgia.

Prevention

The main way of preventing brucellosis is by using fastidious hygiene in producing raw milk products, or by pasteurization of all milk that is to be ingested by human beings, either in its pure form or as a derivate, such as cheese.

Provide protection from skin contact when handling potentially infected animals.

Q fever

Q fever is caused by infection with *Coxiella burnetii*. This organism is uncommon but may be found in cattle, sheep, goats and other domestic mammals, including cats and dogs. The infection results from inhalation of contaminated particles in the air, and from contact with the vaginal mucus, milk, feces, urine or semen of infected animals. The incubation period is 9-40 days. It is considered possibly the most infectious disease in the world, as a human being can be infected by a single bacterium.

The most common manifestation is flu-like symptoms with abrupt onset of fever, malaise, profuse perspiration, severe headache, myalgia (muscle pain), joint pain, loss of appetite, upper respiratory problems, dry cough, pleuritic pain, chills, confusion and gastro-intestinal symptoms such as nausea, vomiting and diarrhea. The fever lasts approximately 7-14 days.

During the course, the disease can progress to an atypical pneumonia, which can result in a life threatening acute respiratory distress syndrome (ARDS), whereby such symptoms usually occur during the first 4-5 days of infection.

Less often the Q fever causes (granulomatous) hepatitis which becomes symptomatic with malaise, fever, liver enlargement (hepatomegaly), pain in the right upper quadrant of the abdomen and jaundice (icterus).

The chronic form of the Q fever is virtually identical with the inflammation of the inner lining of the heart (endocarditis), which can occur after months or decades following the infection. It is usually deadly if untreated. However, with appropriate treatment this lethality is around 10%.

The common way of infection is inhalation of contaminated dust, contact with contaminated milk, meat, wool and particularly birthing products. Ticks can transfer the pathogenic agent to other animals. Transfer between humans seems extremely rare and has so far been described in very few cases.

Prevention

Q fever is effectively prevented by intradermal vaccination with a vaccine composed of killed *Coxiella burnetii* organisms. Skin and blood tests should be done before vaccination to identify preexisting immunity; the reason is that vaccinating subjects who already have immunity can result in a severe local reaction. After a single dose of vaccine, protective immunity lasts for many years. Revaccination is not generally required. Annual screening is typically recommended.

Wear appropriate PPE when handling potentially infected animals or materials.

Leptospirosis

Leptospirosis is a bacterial disease that affects humans and animals. It is caused by bacteria of the genus *Leptospira*.

The time between a person's exposure to a contaminated source and becoming sick is 2 days to 4 weeks. Illness usually begins abruptly with fever and other symptoms. Leptospirosis may occur in two phases; after the first phase, with fever, chills, headache, muscle aches, vomiting, or diarrhea, the patient may recover for a time but become ill again. If a second phase occurs, it is more severe; the person may have kidney or liver failure or meningitis. This phase is also called Weil's disease.

The illness lasts from a few days to 3 weeks or longer. Without treatment, recovery may take several months. In rare cases death occurs.

Many of these symptoms can be mistaken for other diseases. Leptospirosis is confirmed by laboratory testing of a blood or urine sample.

Leptospira organisms have been found in cattle, pigs, horses, dogs, rodents, and wild animals. Humans become infected through contact with water, food, or soil containing waste from these infected animals. This may happen by consuming contaminated food or water or through skin contact, especially with mucosal surfaces, such as the eyes or nose, or with broken skin. The disease is not known to be spread from person to person.

Leptospirosis occurs worldwide but is most common in temperate or tropical climates. It is an occupational hazard for many people who work outdoors or with animals, for example, farmers, sewer workers, veterinarians, fish workers, dairy farmers, or military personnel. It is a recreational hazard for campers or those who participate in outdoor sports in contaminated areas and has been associated with swimming, wading, and whitewater rafting in contaminated lakes and rivers. The incidence is also increasing among urban children.

The risk of acquiring leptospirosis can be greatly reduced by not swimming or wading in water that might be contaminated with animal urine.

Protective clothing or footwear should be worn by those exposed to contaminated water or soil because of their job or recreational activities.

Prevention

Avoid risky foods and drinks.

Buy it bottled or bring it to a rolling boil for 1 minute before drink it. Bottled carbonated water is safer than non-carbonated water.

Ask for drinks without ice unless the ice is made from bottled or boiled water. Avoid popsicles and flavored ices that may have been made with contaminated water.

Eat foods that have been thoroughly cooked and that are still hot and steaming

Avoid raw vegetables and fruits that cannot be peeled. Vegetables like lettuce are easily contaminated and are very hard to wash well. When eating raw fruit or vegetables that can be peeled, peel them yourself. (Wash your hands with soap first.) Do not eat the peelings.

Avoid foods and beverages from street vendors. It is difficult for food to be kept clean on the street, and many travelers get sick from food bought from street vendors.

Leptospirosis is treated with antibiotics, such as doxycycline or penicillin, which should be given early in the course of the disease. Intravenous antibiotics may be required for persons with more severe symptoms. Persons with symptoms suggestive of leptospirosis should contact a health care provider.

Ebola

Ebola is both the common term used to describe a group of viruses belonging to genus Ebolavirus, family Filoviridae, and the common name for the disease which they cause, Ebola hemorrhagic fever. Ebola viruses are morphologically similar to the Marburg virus, also in the family Filoviridae, and share similar disease symptoms. Ebola has caused a number of serious and highly publicized outbreaks since its discovery.

Despite considerable effort by the World Health Organization, no animal reservoir capable of sustaining the virus between outbreaks has been identified. However, it has been hypothesized that the most likely candidate is the fruit bat.

Ebola hemorrhagic fever is potentially lethal and encompasses a range of symptoms including fever, vomiting, diarrhea, generalized pain or malaise, and sometimes internal and external bleeding. Mortality rates are extremely high, with the human case-fatality rate ranging from 50% - 89%, according to viral subtype.^[2] The cause of death is usually due to hypovolemic shock or organ failure.

Because Ebola is potentially lethal and since no approved vaccine or treatment is available, Ebola is classified as a biosafety level 4 agent, as well as a Category A bioterrorism agent by the Centers for Disease Control and Prevention.

Symptoms are varied and often appear suddenly. Initial symptoms include high fever (at least 38.8°C), severe headache, muscle joint, or abdominal pain, severe weakness and exhaustion, sore throat, nausea, and dizziness. Before an outbreak is suspected, these early symptoms are easily mistaken for malaria, typhoid fever, dysentery, influenza, or various bacterial infections, which are all far more common and less reliably fatal.

Ebola may progress to cause more serious symptoms, such as diarrhea, dark or bloody feces, vomiting blood, red eyes due to distention and hemorrhage of sclerotic arterioles, petechia, maculopapular rash, and purpura. Other secondary symptoms include hypotension (less than 90 mm Hg systolic /60 mm Hg diastolic), hypovolemia, tachycardia, organ damage (especially the kidneys, spleen, and liver) as a result of disseminated systemic necrosis, and proteinuria. The interior bleeding is caused by a chemical reaction between the virus and the platelets which creates a chemical that will cut cell sized holes into the capillary walls.

Among humans, the virus is transmitted by direct contact with infected body fluids, or to a lesser extent, skin or mucus membrane contact. The incubation period can be anywhere from 2 to 21 days, but is generally between 5 and 10 days.

Although airborne transmission between monkeys has been demonstrated by an accidental outbreak in a laboratory located in Virginia, USA, there is very limited evidence for human-to-human airborne transmission in any reported epidemics.

The infection of human cases with Ebola virus has been documented through the handling of infected chimpanzees, and gorillas--both dead and alive.

So far, all epidemics of Ebola have occurred in sub-optimal hospital conditions, where practices of basic hygiene and sanitation are often either luxuries or unknown to caretakers and where disposable needles and autoclaves are unavailable or too expensive. In modern hospitals with disposable needles and knowledge of basic hygiene and barrier nursing techniques, Ebola rarely spreads on such a large scale.

Prevention

Prevention methods include good hygiene in medical settings and awareness of the virus in travel areas. There is no known effective vaccine for humans.

Prevention efforts should concentrate on avoiding contact with host or vector species. Travelers should not visit locations where an outbreak is occurring. Contact with rodents should be avoided. Minimize exposure to arthropod bites by using permethrin-impregnated bed nets and insect repellents.

Strict compliance with infection control precautions (i.e., use of disposable gloves, face shields, and disposable gowns to prevent direct contact with body fluids and splashes to mucous membranes when caring for patients or handling clinical specimens; appropriate use and disposal of sharp instruments; hand washing and use of disinfectants) is recommended to avoid health care-associated infections.

Contact with dead primates should be avoided.

Bird and Bat Borne or Enhanced Diseases

See also under Molds and Fungus

Histoplasmosis

Histoplasmosis is a fungal infection which enters the body through the lungs. The infection enters the body through the lungs. The fungus grows as a mold in the soil, and infection results from breathing in airborne particles. Soil contaminated with bird or bat droppings are known to have a higher concentration of histoplasmosis.

There may be a short period of active infection, or it can become chronic and spread throughout the body. Most people who do develop symptoms will have a flu-like syndrome (acute-fever, chills cough, and chest pain; chronic-chest pain, cough with blood, fever, shortness of breath, sweating) and lung complaints related to pneumonia or other lung involvement. Approximately 10% of the population will develop inflammation in response to the initial infection. This can affect the skin, bones or joints, or the lining of the heart (pericardium). These symptoms are not due to fungal infection of those body parts, but due to inflammation.

In a small number of patients, histoplasmosis may become widespread (disseminated) and involve the blood, brain, adrenal glands, or other organs. Very young or old are at a higher risk for

disseminated histoplasmosis. Symptoms include fevers, headache, neck stiffness, mouth sores, skin lesions.

Histoplasmosis may be prevented by reducing dust exposure in areas containing bird or bat droppings. Wear PPE and respirator when working within this environment. Institute work practices and dust control measures, i.e. moist/wet area, that eliminate or reduce dust generation which will reduce risks of infection and subsequent development of disease.

Treatment

The main treatment for histoplasmosis is antifungal drugs. Amphotericin B, itraconazole, and ketoconazole are the usual treatments. Long-term treatment with antifungal drugs may be needed.

Psittacosis

Psittacosis is a disease caused by a bacteria that is found in bird droppings and other secretions (often carried by pet birds). The bacteria is found worldwide.

Symptoms of psittacosis infection may include a low-grade fever that often becomes worse as the disease progresses, including anorexia, sore throat, light sensitivity, and a severe headache.

Ammonia and sodium hypochlorite based disinfectants are effective disinfectants for Psittacosis.

Where it is necessary to remove bat droppings from buildings prior to renovation or demolition it is prudent to assume infection and use the following precautions:

- Avoid areas that may harbor the bacteria, e.g., accumulations of bird or bat droppings.
- Areas known or suspected of being contaminated by *the organisms causing* Psittacosis such as bird roosts, attics, or even entire buildings that contain accumulations of bat or bird manure, should be posted with signs warning of the health risk. The building or area should be secured
- Before an activity is started that may disturb any material that might be contaminated by Psittacosis, workers should be informed in writing of the personal risk factors that increase an individual's chances of developing these diseases. Such a written communication should include a warning that individuals with weakened immune systems are at the greatest risk of developing severe forms of these diseases become infected. These people should seek advice from their health care provider about whether they should avoid exposure to materials that might be contaminated with these organisms.

The best way to prevent exposure is to avoid situations where material that might be contaminated can become aerosolized and subsequently inhaled. A brief inhalation exposure

highly contaminated dust may be all that is needed to cause infection and subsequent development of psittacosis. Therefore, work practices and dust control measures that eliminate or reduce dust generation during the removal of bat manure from a building will also reduce risks of infection and subsequent development of disease. For example, instead of shoveling or sweeping dry, dusty material, carefully wetting it with a water spray can reduce the amount of dust aerosolized during an activity. Adding a surfactant or wetting agent to the water might reduce further the amount of aerosolized dust.

Once the material is wetted, it can be collected in double, heavy-duty plastic bags, a 55-gallon drum, or some other secure container for immediate disposal. An alternative method is use of an industrial vacuum cleaner with a high-efficiency filter to *bag* contaminated material. Truck-mounted or trailer-mounted vacuum systems are recommended for buildings with large accumulations of bat or bird manure. These high-volume systems can remove tons of contaminated material in a short period. Using long, large-diameter hoses, such a system can also remove contaminated material located several stories above its waste hopper. This advantage eliminates the risk of dust exposure that can happen when bags tear accidentally or containers break during their transfer to the ground.

The removal of all material that might be contaminated from a building and immediate waste disposal will eliminate any further risk that someone might be exposed to aerosolized spores. Air sampling, surface sampling, or the use of any other method intended to confirm that no infectious agents remain following removal of bat manure is unnecessary in most cases. However, before a removal activity is considered finished, the cleaned area should be inspected visually to ensure that no residual dust or debris remains.

Spraying 1:10 bleach to water mixture on droppings and allowing it to dry is also a recommended practice for the psittacosis organisms.

Because work practices and dust control measures to reduce worker exposures to these organisms have not been fully evaluated, using personal protective equipment is still necessary during some activities. During removal of an accumulation of bat or bird manure from an enclosed area such as an attic, dust control measures should be used, but wearing a NIOSH-approved respirator and other items of personal protective equipment is also recommended to reduce further the risk of exposure to the organisms that cause Psittacosis.

Treatment

Psittacosis is often hard to diagnose and while a concern, it does not occur with great frequency. Knowledge of the symptoms and of potential exposure is important when seeking medical follow-up for potential exposure.

There are various medical treatments for psittacosis based on extent of infection. The sooner the disease is diagnosed and treatment is begun the more effective the treatment will be.

APPENDIX A

Dangerous Animals - Wildlife Hazard Recognition and Protection

GENERAL

Work in remote areas inhabited by wild animals that have been known to cause injury and kill human beings, requires that companies working in these areas carefully plan for wildlife encounters. This procedure outlines actions that when properly implemented should provide a high degree of protection for employees and wildlife.

These procedures apply to employees who prepare Health and Safety Plans or perform fieldwork in environments in which wild animals may be encountered. However, due to the unpredictable nature of wild animals this single document cannot possibly cover all potential risks or protective measures. Therefore, prior to entering remote areas inhabited by dangerous wildlife, contact local wildlife agencies to gather additional information concerning local risks and protective measures.

ATTACHMENTS

Attachments 1 and 2 outline behavioral characteristics of and outline controls that will minimize human injury, loss of property, and unnecessary destruction of wildlife, while ensuring a safe work environment.

WILDLIFE AVOIDANCE AND BASIC PROTECTIVE MEASURES

The best protective measure is simply avoidance. Large numbers of humans present deterrence to wild animals; therefore, whenever possible teams in the field should work together in groups of four or more. Whenever practical, fieldwork should be scheduled around the seasonal cycles of wildlife in the area. When wild animal avoidance cannot be achieved through scheduling, personnel involved in field activities in which encounters with wild animals may result, will take the following steps and will be equipped and trained, as set forth below.

CLEAR THE AREA

Evaluate and control the area before entry by

- Determine areas of recent sightings through local Fish and Game, state troopers, etc.;
- Conduct a site observation from an off-site elevated point, if possible;
- Conduct a controlled walk through in the area by a trained observer;
- Arrange a briefing by a local specialist, e. g., Fish and Game, etc.; and
- Utilizing appropriate noisemakers.

BASIC EQUIPMENT

Employees entering an environment where encounters with wild animals are possible should be provided, as a minimum:

- Noisemakers, such as air horns, bells, etc.; and
- Bear spray of not less than 16-ounce capacity (with holster), equivalent to capsicum pepper (red pepper extract), which is capable of spraying at least 15 feet. (Notes: Normally cannot be transported in side aircraft passenger compartments and may be

considered a hazardous material, check with airlines and hazardous material shippers for current information).

TRAINING

Prior to entering and / or working in areas inhabited by dangerous wildlife each employee should receive training as outlined in this procedure. At a minimum, training must include information related to:

- Wildlife present, habitat, behavior patterns, including when wild animals are most active, etc.
- Warning signs, such as tracks, bedding areas, scat, claw marks, offspring, paths, etc.,
- Avoidance measures
- Other hazards, precautions, and protective measures as outlined in the Attachments,
- (At the jobsite) spray demonstration and safety instructions which include location of and persons designated as “bear watch”

An outline of the training content should be reviewed and approved by the Divisional EHS manager and should be documented. A record of the training will be maintained at the job site, filed with the SSHSP and in the employee’s training records.

VEHICLE SAFETY

Use extreme caution, particularly in darkness, when operating vehicles in areas where wild animals may be present. Collisions with large animals have been known to cause significant property damage and personal injuries to vehicle passengers, including fatalities.

ATTACHMENT 1

BEAR SAFETY – HAZARD RECOGNITION AND PRECAUTIONS

On occasion fieldwork may be conducted in a location where bears may be encountered. The following technical information, precautions, and guidelines for operations in which bears could be encountered are based on experience and conditions for field work. Bears are intelligent, wild animals and are potentially dangerous, and would rather be left alone. The more bears are understood the less they will be feared. This attachment is intended to provide information that will enable Weston to plan for bear encounters and to properly address face-to-face encounters.

Bear Life History

Although bears are creatures of habit, they are also intelligent, and each has its own personality. The way a bear reacts is often dictated by what it has learned from its mother, the experience it has had on its own, and the instincts nature has provided. Like other intelligent animals, we can make general statements about bears, but few people can accurately predict their behavior.

Bears have an incredible sense of smell, and seem to trust it more than any other sense. Hearing and sight are also important, but to a lesser degree. A bear's hearing is probably better than ours, but not as keen as a dog's hearing. Their sight is probably comparable to that of a human. Black bears tend to favor forested habitats.

Bears are opportunists, relying on their intelligence and their senses to find food. They use different habitats throughout the year, depending on the availability of food and other necessities. The area a bear covers in a given year is partially dependent on how far it has to go to satisfy these basic needs. In some areas, individual bears have home ranges of less than a square mile; in other areas ranges can encompass hundreds of square miles. Males usually range over larger areas than females.

In spring, bears begin coming out of hibernation. Males are usually the first bears to emerge, usually in April, and females with new cubs are usually the last, sometimes as late as late June. When bears emerge from their dens, they are lethargic for the first few days, frequently sleeping near their dens and not eating. When they do start eating, they seek carrion (deer, etc.), roots, and emerging vegetation. In coastal areas, beaches become travel corridors as bears seek these foods.

In early summer, bears eat new grasses and forage as they develop in higher elevations. In coastal areas, salmon are the most important food from June through September. This period is one of the few times that bears are found in large groups, and it is the time that most people see bears. Bears often travel, eat, and sleep along streams for weeks at a time.

Other summer foods for bears include grasses and ground squirrels. When bears kill or scavenge large prey, they commonly cover the portions they cannot eat with sticks and duff. A bear may remain near a food cache for days and it will defend it from intruders.

During the late summer and early fall, bears move inland and consume large amounts of blueberries, and other succulent fruits. As the seasons progress towards winter, a bear's diet becomes more varied. This is the time that bears are adding final deposits of fat before their long winter naps.

In October and November, bears move into their denning areas and begin preparing a suitable den. Black bears usually den in holes under large trees or rock outcrops, or in small natural cavities. Dens are just large enough for the bears to squeeze into. Bears rarely eat, drink, urinate, or defecate while they are denning. They sleep deeply, but do not truly hibernate, and they can be awakened by loud noises or disturbances.

Cubs are born in the den, usually in January. Black bear cubs usually stay with their mothers for a year and a half. Black bears are sexually mature at age 2. Mating season is in the spring (May or June) and both species are polygamous (multiple mates). Black bears can live for 25 – 30 years, although most live less than 20 years.

BEAR AND HUMAN INTERACTIONS

Bears generally prefer to be left alone, but they share their homes with other creatures, including humans, who intrude on virtually every aspect of the bear's life. Bears are normally tolerant of these activities and generally find a secure way to avoid them. Humans can help bears make a graceful retreat and avoid many close encounters by letting them know we are coming. Walking in groups, talking, and wearing noise making devices, such as bear bells, all serve to warn a bear of your approach. When possible, avoid hiking and camping in areas where bears are common, such as bear trails through heavy brush or along salmon streams. Always keep an eye out for bears and bear signs. If you happen upon a dead animal, especially one that is covered with sticks and duff (a bear cache), immediately retreat the way you came, but do not run, and make a detour around the area. If you see a cub up a tree or a small bear walking alone, immediately retreat and detour around the area. Like all young animals, cubs wander away from their mothers, but females are furiously protective when they believe their cubs are threatened. Even if we do everything possible to avoid meeting a bear, sometimes bears come to us.

Bears are both intelligent and opportunistic, and they express these qualities through their curiosity. This curiosity frequently brings them into "human habitat." When this happens, we often feel vulnerable, and the bear is sometimes viewed as a threat or nuisance. In most cases, a curious bear will investigate a "human sign," perhaps test it out (chew on a raft, bite into some cans, etc.), and leave, never to return. If the bear was rewarded during his investigation by finding something to eat, it is hard to stop them from returning once they have had a food-reward. That is why we emphasize the importance of keeping human food and garbage away from bears. When in bear country, always think about the way you store, cook, and dispose of your food. **Never feed bears!** This is both illegal and foolish. Food should be stored in airtight containers, preferably away from living and sleeping areas. Garbage should be thoroughly incinerated as soon as possible. Fish and game should be cleaned well away from camp, and clothing that smells of fish and game should be stored away from sleeping areas. Menstruating women should take extra precautions to keep themselves as clean as possible, and soiled tampons and pads should

be treated as another form of organic garbage. Once a bear has obtained food from people, it may continue to frequent areas occupied by people. If a bear does not find food or garbage after the next few tries, it may give up and move back into a more natural feeding pattern. Occasionally, though, the bear will continue to seek human foods and can become a “problem bear.” Some bears become bold enough to raid campsites and break into cabins to search for human food. Shooting bears in the rump with cracker shells, flares, rubber bullets, and birdshot are common methods of “aversive conditioning.” These are also very dangerous techniques, because they may seriously injure a bear if not done properly and/or they may cause a bear to attack the shooter.

BLACK BEARS

Black Bear Identification: Black bears are the smallest and most abundant of the bear species. They are five to six feet long and stand about two to three feet high at the shoulders. They weigh from 200 to 500 pounds. While they are most commonly black, other color phases include brown (cinnamon), and, rarely, gray (blue), and white. Muzzles are usually brown. Black bears can be distinguished from brown bears by:

- Their head shape (a black bear’s nose is straight in profile, a brown bear’s is dished);
- Their claws (black bear’s claws are curved and smaller, brown bears are relatively straight and longer);
- Their body shape (when standing, a black bear’s rump seems to be higher than its shoulders; a brown bear’s shoulders are usually higher than its rump); and

Typical Habitat: Black bears occupy a wide range of habitats, but seem to be most common in forested areas.

AVOIDING BEAR ENCOUNTERS WHEN

- The Bear sees you but you do not know the bear is around: The bear will likely avoid detection people and will simply move away when they sense a human.
- You see a bear and it does not know you are there: Move away slowly. Avoid intercepting the bear if it is walking. If possible, detour around the bear. If the bear is close to you, stand where you are or back away slowly. Do not act threateningly toward the bear, it may know you are there but it has chosen to ignore you as long as you are not a threat.
- You see the bear and the bear sees you: Do not act threateningly, but let the bear know you are human. Wave your arms slowly, talk in a calm voice, and walk away slowly in a lateral direction, keeping an eye on the bear. Unless you are very close to a car or a building, never run from bears. In a bear’s world, when something runs it is an open invitation to chase it. Bears will chase a running object even if they have no previous intention of catching it. Bears can run as fast as a racehorse, so humans have little or no chance of outrunning a bear.
- You see a bear; the bear sees you and stands on its hind legs: This means that the bear is seeking more information. Bears stand on their hind legs to get a better look, or smell, at something they are uncertain of. It is your cue to help it figure

out what you are. Help the bear by waving your arms slowly and talking to it. Standing is not a precursor to an attack. Bears do not attack on their hind legs. It is also important to remember that when a bear goes back down on all fours from a standing position, it may come towards you a few steps. This is normal, and probably not an aggressive act.

- The bear sees you, recognizes you as a human, but continues to come towards you slowly: This may mean several things, depending on the bear and the situation. It may mean that the bear does not see you as a threat, and just wants to get by you (especially if the bear is used to humans, as in a National Park); the bear wants to get food from you (if it has gotten food from people before); the bear wants to test your dominance (it views you as another bear); or may be stalking you as food (more common with black bear, but a rare occurrence). In all cases, your reaction should be to back off the trail very slowly, stand abreast if you are in a group, talk loudly, and/or use a noise-making device. If the bear continues to advance, you should stop. At this point, it is important to give the bear the message that if he continues to advance it will cost him. Continue to make loud noises and present a large visual image to the bear (standing abreast, open your coat). In bear language, bears assert themselves by showing their size. If an adult brown bear continues to come at you, climbing 20 feet or higher up a tree may also be an option if one is next to you (remember, never run from bears). Keep in mind, though, black bears can climb trees.
- The bear recognizes you as a human and acts nervous or aggressive: When bears are nervous or stressed they can be extremely dangerous. This is when it is important to try to understand what is going on in the bears mind. Nervous bears growl, woof, make popping sounds with their teeth, rock back and forth on their front legs, and often stand sideways to their opponent. A universal sign of a nervous bear is excessive salivation (sometimes it looks like they have white lips). When a bear shows any of these signs, stand where you are and talk in a calm voice. Do not try to imitate bear sounds, this may only serve to confuse and further agitate the bear. If you are in a group, stand abreast.
- The bear charges: If all other signals fail, a bear will charge. Surprisingly, most bear charges are just another form of their language. The majority of these are “bluff charges,” that is; the bear stops before making contact with their opponent. There are many different types of bluff charges ranging from a loping uncertain gait to a full-blown charge. If a bear charges, stand still.
- The bear attacks: When all else fails, a bear may attack. Attacks may be preceded by all of the behaviors previously described or they may be sudden. Seemingly unprovoked attacks are often the result of a bear being surprised (and feeling threatened), a bear defending its food cache, or a female defending her cubs. When a bear attacks, it typically runs with its body low to the ground, legs are stiff, ears are flattened, hair on the nape of the neck is up, and the bear moves in a fast, determined way. Front paws are often used to knock the opponent down and jaws are used to subdue it.

AFTER A BEAR ENCOUNTER

Black bears have been known to view humans as prey, and if you struggle with the attacking black bear, it will probably go elsewhere for its meal.

- Bear Sprays: Are easy to carry and use, little risk of permanent damage to bears and humans, effective in many situations. However, using a spray may change a false charge into a real charge, they are ineffective at ranges greater than 20 feet, ineffective in windy conditions, dangerous if accidentally discharged in a closed area such as an aircraft cockpit.

The most effective tool you have against an attacking bear is your brain. Although bears are intelligent animals, we are smarter and can often think our way out of a bad situation if we try.

ATTACHMENT 2

HAZARDS AND PRECAUTIONS – DEER

The following technical information, precautions, and guidelines for operations in which Deer may be encountered. The more the species are understood, the easier it will be to avoid contact with them thus preventing injury to ourselves and to the animals. All big game species are unpredictable and can be dangerous under certain conditions. This attachment is intended to provide information that will enable Weston to plan for encounters and to properly address face-to-face encounters.

WHITE-TAILED DEER

The White-tailed deer found throughout the eastern and western part of the United States have been known to attack people on many occasions. It is unknown whether Black-tailed deer have made any such attacks, but it is possible for someone to be injured by an irate buck in the breeding season (late fall). Deer are well equipped to injure humans. They are very fast. Bucks have sharp antlers and can clear amazingly high obstacles with graceful, arching leaps. They can run with remarkable speed, even in dense cover, and have excellent camouflage. When working in areas populated with deer, it is just common sense not to approach any large wild animal too closely. It is unlikely that an attack from a deer would be fatal but it is possible and serious injury is likely.

APPENDIX B - PICTURES OF POISONOUS SNAKES AND LIZARDS

Americas



American copperhead



Cotton Mouth – East and Southeast US



Timber Rattlesnake – Eastern US

FLD 43 B INSECTS

Sting and Biting Insects

Contact with stinging insects may result in site personnel experiencing adverse health affects that range from being mildly uncomfortable to being life threatening. Therefore, stinging insects present a serious hazard to site personnel and extreme caution must be exercised whenever site and weather conditions increase the risk of encountering stinging insects. These include the following:

- Bees ("Killer" bees, honeybees, bumble bees, wasps, and hornets and wingless wasps)
- Scorpions
- Fire ants
- Spiders

Bees, Wasps, Hornets and Yellow Jackets

The severity of an insect sting reaction varies from person to person. A normal reaction will result in pain, swelling and redness confined to the sting site. Simply disinfect the area (washing with soap and water will do) and apply ice to reduce the swelling.

A large local reaction will result in swelling that extends beyond the sting site. For example, a sting on the forearm could result in the entire arm swelling twice its normal size.

Although alarming in appearance, this condition is often treated the same as a normal reaction. An unusually painful or very large local reaction may need medical attention. Because this condition may persist for two to three days, antihistamines and corticosteroids are sometimes prescribed to lessen the discomfort.

Yellow jackets, hornets and wasps can sting repeatedly. Honeybees have barbed stingers that are left behind in their victim's skin. These stingers are best removed by a scraping action, rather than a pulling motion, which may actually squeeze more venom into the skin.

Personnel should be very cautious of "killer" bees. They have the appearance of the typical honeybee, however, they are very aggressive. These Africanized honeybees (AHB) defend their colonies much more vigorously than typical bees. The colonies are easily disturbed (sometimes just by being nearby). When they do sting, many more bees may participate, so there is a danger of receiving more stings. This can make them life threatening, especially to people allergic to stings, or with limited capacity to escape (the young, old, and handicapped).

Scorpions

Scorpion stings are a major public health problem in many underdeveloped tropical countries. For every person killed by a poisonous snake, 10 are killed by a poisonous scorpion. In Mexico, 1000 deaths from scorpion stings occur per year. In the United States, only 4 deaths in 11 years have occurred as a result of scorpion stings. Furthermore, scorpions can be found outside their

normal range of distribution, ie, when they accidentally crawl into luggage, boxes, containers, or shoes and are unwittingly transported home via human travelers.

Out of 1500 scorpion species, 50 are dangerous to humans. Scorpion stings cause a wide range of conditions, from severe local skin reactions to neurologic, respiratory, and cardiovascular collapse.

Almost all of these lethal scorpions, except the *Hemiscorpius* species, belong to the scorpion family called the Buthidae. The Buthidae family is characterized by a triangular-shaped sternum, as opposed to the pentagonal-shaped sternum found in the other 5 scorpion families. In addition to the triangular-shaped sternum, poisonous scorpions also tend to have weak-looking pincers, thin bodies, and thick tails, as opposed to the strong heavy pincers, thick bodies, and thin tails seen in nonlethal scorpions. The lethal members of the Buthidae family include the genera of *Buthus*, *Parabuthus*, *Mesobuthus*, *Tityus*, *Leiurus*, *Androctonus*, and *Centruroides*. These lethal scorpions are found generally in the given distribution:

<i>Centruroides</i> - Southwest USA, Mexico, Central America	<i>Tityus</i> - Central and South America, Caribbean
<i>Buthus</i> - Mediterranean area	<i>Androctonus</i> - Northern Africa to Southeast Asia
<i>Leiurus</i> - Northern Africa and Middle East	<i>Mesobuthus</i> - Asia
<i>Parabuthus</i> - Western and Southern Africa	

A scorpion has a flattened elongated body and can easily hide in cracks. It has 4 pairs of legs, a pair of claws, and a segmented tail that has a poisonous spike at the end. Scorpions vary in size from 1-20 cm in length.

However, scorpions may be found outside their habitat range of distribution when inadvertently transported with luggage and cargo.



Centruroides (Southwest USA, Mexico)



Hemiscorpious (Middle East) cytotoxic



Fat Tail Scorpion (Middle East) neurotoxic



Death Stalker *Leiurus quinquestriatus* (Africa Southwest and North) neurotoxic



Black Scorpion (Middle East) deadly neurotoxin

Prevention

Preventive measures include awareness of scorpions, shaking out clothing and boots before putting them on looking before reaching into likely hiding places and wearing gloves, long sleeved shirts and pants.

Symptoms

In mild cases, the only symptom may be a mild tingling or burning at site of sting.

In severe cases, symptoms may include:

- Eyes and ears - Double vision
- Lungs - Difficulty breathing, No breathing, Rapid breathing,
- Nose, mouth, and throat – Drooling, Spasm of the voice box, Thick-feeling tongue
- Heart and blood - High blood pressure, Increased or decreased heart rate, Irregular heartbeat
- Kidneys and bladder Urinary incontinence, Urine output, decreased
- Muscles and joints - Muscle spasms
- Nervous system – Paralysis, Random movements of head, eye, or neck, Restlessness, Seizures, Stiffness
- Stomach and intestinal tract - Abdominal cramps, Fecal incontinence
- Other -Convulsions

Treatment

1. Recognize scorpion sting symptoms:
2. Wash the area with soap and water.
3. Apply a cool compress on the area of the scorpion sting. Ice (wrapped in a washcloth or other suitable covering) may be applied to the sting location for 10 minutes. Remove compress for 10 minutes and repeat as necessary.
4. Call the Poison Control Center. If you develop symptoms of a poisonous scorpion sting, go to the nearest emergency care facility.
5. Keep your tetanus shots and boosters current.

Fire Ants

Fire ants are aggressive, reddish-brown to black ants that are 1/8 inch to 1/4 inch long. They construct nests, which are often visible as dome-shaped mounds of soil, sometimes as large as 3 feet across and 1 1/2 feet in height. In sandy soils, mounds are flatter and less visible. Fire ants usually build mounds in sunny, open areas such as lawns, pastures, cultivated fields and meadows, but they are not restricted to these areas. Mounds or nests may be located in rotting logs, around trees and stumps, under pavement and buildings, and occasionally indoors.

Fire ants use their stingers to immobilize or kill prey and to defend ant mounds from disturbance by larger animals, such as humans. Any disturbance sends hundreds of workers out to attack anything that moves. The ant grabs its victim with its mandibles (mouthparts) and then inserts its stinger. The process of stinging releases a chemical, which alerts other ants, inducing them to sting. In addition, one ant can sting several times without letting go with its mandibles.

Once stung, humans experience a sharp pain that lasts a couple of minutes, then after a while the sting starts itching and a welt appears. Fire ant venom contains alkaloids and a relatively small amount of protein. The alkaloids kill skin cells; this attracts white blood cells, which form a pustule within a few hours of being stung. The fluid in the pustule is sterile, but if the pustule is broken, the wound may become infected. The protein in the venom can cause allergic reactions that may require medical attention.

Some of the factors related to stinging insects that increase the risk associated with accidental contact are:

- The nests for these insects are frequently found in remote wooded or grassy areas and hidden in cavities
- The nests can be situated in trees, rocks, bushes or in the ground, and are usually difficult to see
- Accidental contact with these insects is highly probable, especially during warm weather conditions when the insects are most active
- If a site worker accidentally disturbs a nest, the worker may be inflicted with multiple stings, causing extreme pain and swelling which can leave the worker incapacitated and in need of medical attention
- Some people are hypersensitive to the toxins injected by a sting, and when stung, experience a violent and immediate allergic reaction resulting in a life-threatening condition known as anaphylactic shock
- Anaphylactic shock manifests itself very rapidly and is characterized by extreme swelling of the body, eyes, face, mouth and respiratory passages
- The hypersensitivity needed to cause anaphylactic shock, can in some people, accumulate over time and exposure, therefore, even if someone has been stung previously, and not experienced an allergic reaction, there is no guarantee that they will not have an allergic reaction if they are stung again

With these things in mind, and with the high probability of contact with stinging insects, use the following safe work practices:

- If a worker knows that he is hypersensitive to bee, wasp or hornet stings, inform the site Safety officer of this condition prior to participation in site activities
- All site personnel will be watchful for the presence of stinging insects and their nests, and will advise the Site Safety officer if a stinging insect nest is located or suspected in the area
- Any nests located on site will be flagged off and site personnel will be notified of its presence
- If attacked, site personnel will immediately seek shelter and stay there. Do not jump in water (bees will still be in the area when you come up). Once safe, remove stings from your skin, it does not matter how you do it, but do it as quickly as possible to reduce the amount of venom they inject. Obtain first aid treatment and contact the safety officer who will observe for signs of allergic reaction

Treatment for fire ant stings is aimed at preventing secondary bacterial infection, which may occur if the pustule is scratched or broken. Clean the blisters with soap and water to prevent secondary infection. Do not break the blister. Topical corticosteroid ointments and oral antihistamines may relieve the itching associated with these reactions.

Site personnel with a known hypersensitivity to stinging insects will keep required emergency medication on or near their person at all times

Spiders

A large variety of spiders may be encountered during site activities. Extreme caution must be used when lifting logs and debris, since spiders are typically found in these areas.

While most spider bites merely cause localized pain, swelling, reddening, and in some cases, tissue damage, there are a few spiders that, due to the severity of the physiological affects caused by their venom, are dangerous. The UXOSO will brief site personnel as to the identification and avoidance of these dangerous spiders. These species include the black widow and the brown or violin spiders.

The black widow is a coal-black bulbous spider 3/4 to 1 1/2 inches in length, with a bright red hourglass on the under side of the abdomen. The black widow is usually found in dark moist locations, especially under rocks, rotting logs and may even be found in outdoor toilets where they inhabit the underside of the seat. Victims of a black widow bite may exhibit the following signs or symptoms:

- Sensation of pinprick or minor burning at the time of the bite
- Appearance of small punctures (but sometimes none are visible)
- After 15 to 60 minutes, intense pain is felt at the site of the bite which spreads quickly, and is followed by profuse sweating, rigid abdominal muscles, muscle spasms, breathing difficulty, slurred speech, poor coordination, dilated pupils and generalized swelling of face and extremities

The brown or violin spider is brownish to tan in color, rather flat, and 1/2 to 5/8 inches long. However, unlike the typical species, this spider has been encountered without a violin or “fiddle” shaped mark on the top of the head. Of the brown spider, there are three varieties found in the United States that present a problem to site personnel. These are the brown recluse, the desert violin and the Arizona violin. These

spiders may be found in a variety of locations including trees, rocks or in dark locations. Victims of a brown or violin spider bite may exhibit the following signs or symptoms:

- Blistering at the site of the bite, followed by a local burning at the site 30 to 60 minutes after the bite
- Formation of a large, red, swollen, postulating lesion with a bull's-eye appearance
- Systemic affects may include a generalized rash, joint pain, chills, fever, nausea and vomiting
- Pain may become severe after 8 hours, with the onset of tissue necrosis

There is no effective first aid treatment for either of these bites. Except for very young, very old or weak victims, spider bites are not considered to be life threatening. However, medical treatment must be sought to reduce the extent of damage caused by the injected toxins.

Brown Recluse Spider



Black Widow Spider



First aid should include:

- If possible, catch the spider to confirm its identity. Even if the body is crushed, save it for identification
- Clean the bitten area with soap and water or rubbing alcohol
- To relieve pain, place an ice pack over the bite
- Keep the victim quiet and monitor breathing

Seek immediate medical attention

Sensitivity Reaction to Insect Stings or Bites

A sensitivity reaction is one of the more dangerous and acute effects of insect bites or stings. It is the most common cause of fatalities from bites, particularly from bees, wasps, and spiders. Anaphylactic shock due to stings can lead to severe reactions in the circulatory, respiratory, and central nervous system. This can also result in death.

Site personnel must be questioned regarding their allergic reaction to insect bites. Anyone knowingly allergic should be required to carry and know how to use a response kit. First aid providers must be instructed on how to use the kit also. The kit must be inspected to ensure it is updated.

Administer first aid and observe persons reporting stings for signs of allergic reaction, such as unusual swelling, nausea, dizziness, and shock. At the first sign of these symptoms, take the individual to a medical facility for attention.

Insect Borne Diseases

Diseases that are spread by insects include the following: Rocky Mountain Spotted Fever or Lyme Disease (tick); Bubonic and other forms of Plague (fleas); Malaria, West Nile Virus and Equine Encephalitis (mosquito) and Leshmaniasis (Sand Flies)

Tick Borne Diseases

Lyme disease is the second most rapidly spreading disease in the U.S.

Lyme Disease

1. Facts

Definition:

- Bacterial infection transmitted by the bite of an infected black-legged tick more popularly known as the deer tick.
- Prevalence (nationwide and other countries).
- Three stages/sizes of deer ticks:
 - Larvae
 - Nymph
 - Adult

Tick season is May through October.

Not all ticks transmit Lyme disease (Black legged or deer tick [upper] compared to the Lone Star tick [lower])

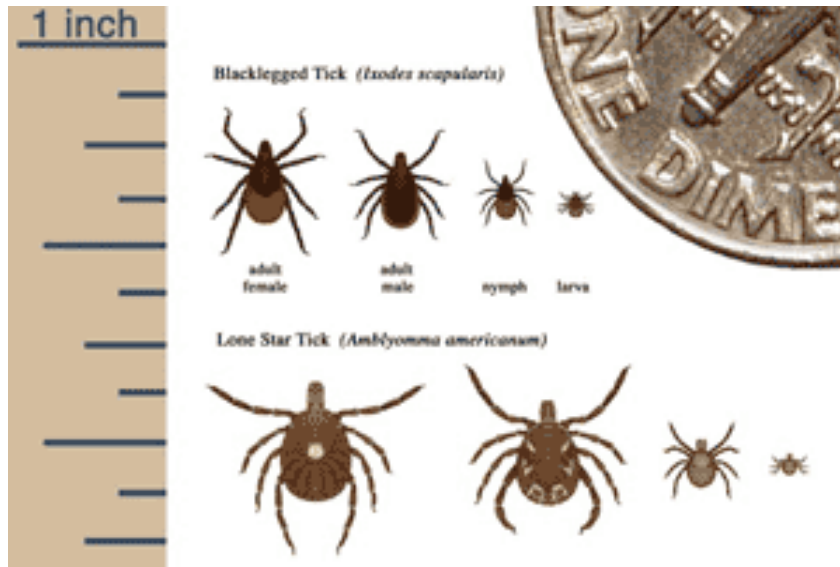

- Ticks must be attached for several hours before Lyme disease can be transmitted.
- Being bitten by a tick does not mean you will get Lyme disease.

2. Prevention and Protection:

- Wear light-colored, tight-knit clothing.
- Wear long pants and long-sleeved shirts.
- Tuck pant legs into shoes or boots.
- Wear a hat.
- Use insect repellent containing DEET (follow manufacturer's instructions for use on exposed skin).
- Use Permethrin-based repellent applied to clothing (follow manufacturer's instructions for use). This product kills and repels ticks. **DO NOT APPLY TO EXPOSED SKIN.**
- Check yourself daily for ticks after being in grassy, wooded areas.
- Request information from the Health and Safety Medical Section regarding Lyme disease.

3. If Bitten:

- Remove the tick immediately with fine-tipped tweezers. Grasp the tick as close to the skin as possible. Pull gently but firmly without twisting or crushing the tick.
- Wash your hands and dab the bite with an antiseptic.

- Save the tick in a jar in some alcohol. Label the jar with the date of the bite, the area where you picked up the tick and the spot on your body where you were bitten.
- Monitor the bite for any signs of infection or rash.

4. Symptoms:

Early Signs (may vary from person to person)

- Expanding skin rash.
- Flu-like symptoms during summer or early fall that include the following:
 - Chills, fever, headache, swollen lymph nodes.
 - Stiff neck, aching joints, and muscles.
 - Fatigue.
- Later signs
 - Nervous system problems.
 - Heart problems.
 - Arthritis, especially in knees.

5. Upon Onset of Symptoms:

- Notify your Safety Officer (SO) and your supervisor.

Rocky Mountain Spotted Fever

The Center for Disease Control (CDC) has noted the increase of Rocky Mountain Spotted Fever (RMSF) which is caused by bites from infected ticks that live in and near wooded areas, tall grass and brush.

RMSF has occurred in 36 states, with the heaviest concentrations in Oklahoma, North Carolina, South Carolina, and Virginia. Rocky Mountain spotted fever is the most severe and most frequently reported rickettsial illness in the United States. It also occurs in Mexico and in Central and South America. It is caused by Rocky Mountain Wood Ticks and Dog Ticks that have become infected with rickettsia. Both are black in color.

The disease is caused by *Rickettsia rickettsii*, a species of bacteria that is spread to humans by ixodid (hard) ticks.

Initial signs and symptoms of the disease include sudden onset of fever, headache, and muscle pain, followed by development of rash. The disease can be difficult to diagnose in the early stages, and without prompt and appropriate treatment it can be fatal.

Prevention procedures are the same as for Lyme disease.

Ehrlichiosis

Ehrlichiosis is the general name used to describe several bacterial diseases that affect animals and humans. These diseases are caused by the organisms in the genus *Ehrlichia*. Worldwide, there are currently four ehrlichial species that are known to cause disease in humans.

In the United States, ehrlichiae are transmitted by the bite of an infected tick. The lone star tick (*Amblyomma americanum*), the blacklegged tick (*Ixodes scapularis*), and the western blacklegged tick (*Ixodes pacificus*) are known vectors of ehrlichiosis in the United States. *Ixodes ricinus* is the primary vector in Europe.

The symptoms of ehrlichiosis may resemble symptoms of various other infectious and non-infectious diseases. These clinical features generally include fever, headache, fatigue, and muscle aches. Other signs and symptoms may include nausea, vomiting, diarrhea, cough, joint pains, confusion, and occasionally rash. Symptoms typically appear after an incubation period of 5-10 days following the tick bite. It is possible that many individuals who become infected with ehrlichiae do not become ill or they develop only very mild symptoms.

Most cases of ehrlichiosis are reported within the geographic distribution of the vector ticks (see map below). Occasionally, cases are reported from areas outside the distribution of the tick vector. In most instances, these cases have involved persons who traveled to areas where the diseases are endemic, and who had been bitten by an infected tick and developed symptoms after returning home. Therefore, if you traveled to an ehrlichiosis-endemic area 2 weeks prior to becoming ill, you should tell your doctor where you traveled.

Figure 20. Areas where human ehrlichiosis may occur based on approximate distribution of vector tick species

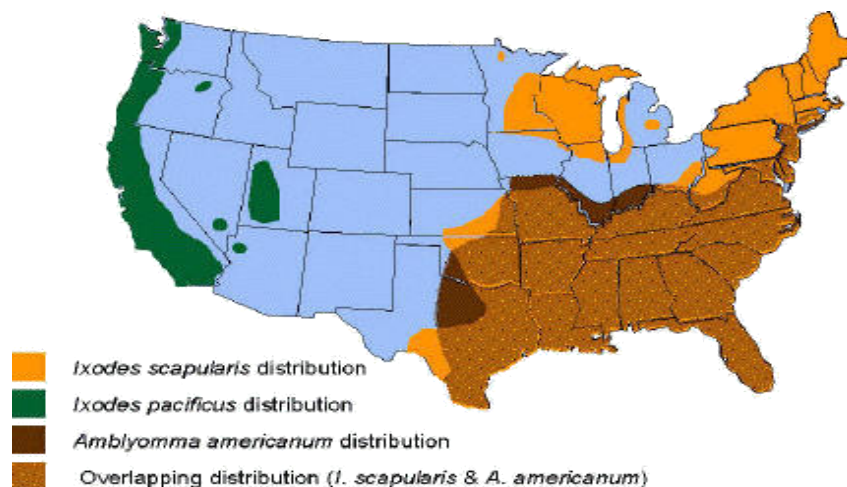

A diagnosis of ehrlichiosis is based on a combination of clinical signs and symptoms and confirmatory laboratory tests. Blood samples can be sent to a reference laboratory for testing. However, the availability of the different types of laboratory tests varies considerably. Other laboratory findings indicative of ehrlichiosis include low white blood cell count, low platelet count, and elevated liver enzymes.

Ehrlichiosis is treated with a tetracycline antibiotic, usually doxycycline.

Very little is known about immunity to ehrlichial infections. Although it has been proposed that infection with ehrlichiae confers long-term protection against reinfection, there have been occasional reports of laboratory-confirmed reinfection. Short-term protection has been described in animals infected with some *Ehrlichia* species and this protection wanes after about 1 year. Clearly, more studies are needed to determine the extent and duration of protection against reinfection in humans.

Limiting exposure to ticks reduces the likelihood of infection in persons exposed to tick-infested habitats. Prompt careful inspection of your body and removal of crawling or attached ticks is an important method of preventing disease. It may take 24–48 hours of attachment before microorganisms are transmitted from the tick to you.

Preventive measures - Follow protection protocols for Lyme disease

Babesiosis

Babesiosis is an intraerythrocytic parasitic infection caused by protozoa of the genus *Babesia* and transmitted through the bite of the *Ixodes* tick, the same vector responsible for transmission of Lyme disease. While most cases are tick-borne, transfusion and transplacental transmission have been reported. In the United States, babesiosis is usually an asymptomatic infection in healthy individuals. Several groups of patients become symptomatic, and, within these subpopulations, significant morbidity and mortality occur. The disease most severely affects patients who are elderly, immunocompromised, or asplenic. Among those symptomatically infected, the mortality rate is 10% in the United States and 50% in Europe.

The primary vectors of the parasite are ticks of the genus *Ixodes*. In the United States, the black-legged tick, *Ixodes scapularis* (also known as *Ixodes dammini*) is the primary vector for the parasite; in Europe, *Ixodes ricinus* appears to be the primary tick vector. In each location, the *Ixodes* tick vector for *Babesia* is the same vector that locally transmits *Borrelia burgdorferi*, the agent implicated in Lyme disease. The primary US animal reservoir is the white-footed mouse, *Peromyscus leucopus*. Additionally, white-tailed deer serve as transport hosts for the adult tick vector, *I. scapularis*. In Europe, the primary animal reservoir is cattle.

The Ixodid ticks ingest *Babesia* during feeding from the host, multiply the protozoa in their gut wall, and concentrate it in their salivary glands. The tick inoculates a new host when feeding again. The parasite then infects red blood cells (RBCs) and differentiated and undifferentiated trophozoites are produced. The former produce 2-4 merozoites that disrupt the RBC and go on to invade other RBCs. This leads to hemolytic anemia, thrombocytopenia, and atypical lymphocyte formation. Alterations in RBC membranes cause decreased conformability and increased red cell adherence, which can lead to development of acute respiratory distress syndrome (ARDS) among those severely affected.

The first US case of babesiosis was reported on Nantucket Island in 1966. An increasing trend over the past 30 years may be the result of restocking of the deer population, curtailment of hunting, and an increase in outdoor recreational activities. Between 1968 and 1993, more than 450 cases of *Babesia* infections were confirmed in the United States. However, the actual prevalence of this disease is unknown because most infected patients are asymptomatic.

The first case of human babesiosis was reported in 1957 from the former Yugoslavia in an asplenic farmer. Approximately 40 cases have been reported since then, mostly in Ireland, the United Kingdom, and France. Sporadic case reports of babesiosis in Japan, Korea, China, Mexico, South Africa, and Egypt have also been documented.

The signs and symptoms mimic malaria and range in severity from asymptomatic to septic shock.

Symptoms include: Generalized weakness, fatigue, depression, fever, anorexia and weight loss, CNS - Headache, photophobia, neck stiffness, altered sensorium, pulmonary - Cough, shortness of breath, GI - Nausea, vomiting, abdominal pain, Musculoskeletal - Arthralgia and myalgia and Renal - Dark urine

Prevention

Prevention measures are the same as for Lyme and other insect borne diseases

Tularemia

Tularemia (also known as "rabbit fever") is a serious infectious disease caused by the bacterium *Francisella tularensis*. The disease is endemic in North America, and parts of Europe and Asia. The primary vectors are ticks and deer flies, but the disease can also be spread through other arthropods. Animals such as rabbits, prairie dogs, hares and muskrats serve as reservoir hosts. The disease is named after Tulare County, California.

Depending on the site of infection, tularemia has six characteristic clinical syndromes: ulceroglandular, glandular, oropharyngeal, pneumonic, oculoglandular, and typhoidal.

The disease has a very rapid onset, with headache, fatigue, dizziness, muscle pains, loss of appetite and nausea. Face and eyes redden and become inflamed. Inflammation spreads to the lymph nodes, which enlarge and may suppurate (mimicking bubonic plague). Lymph node involvement is accompanied by a high fever. Death may result.

Francisella tularensis is one of the most infective bacteria known; fewer than ten organisms can cause disease leading to severe illness. The bacteria penetrate into the body through damaged skin and mucous membranes, or through inhalation. Humans are most often infected by tick bite or through handling an infected animal. Ingesting infected water, soil, or food can also cause infection. Tularemia can also be acquired by inhalation; hunters are at a higher risk for this

disease because of the potential of inhaling the bacteria during the skinning process. Tularemia is not spread directly from person to person.

No vaccine is available to the general public The best way to prevent tularemia infection is to wear rubber gloves when handling or skinning rodents or lagomorphs (as rabbits), avoid ingesting uncooked wild game and untreated water sources, and wearing long-sleeved clothes and using an insect repellent to prevent tick bites.

Prevention

No vaccine is available to the general public The best way to prevent tularemia infection is to wear rubber gloves when handling or skinning rodents or lagomorphs (as rabbits), avoid ingesting uncooked wild game and untreated water sources, and wearing long-sleeved clothes and using an insect repellent to prevent tick bites.

Flea Borne Diseases

Plague

- **Bubonic plague:** enlarged, tender lymph nodes, fever, chills and prostration
- **Septicemic plague:** fever, chills, prostration, abdominal pain, shock and bleeding into skin and other organs
- **Pneumonic plague:** fever, chills, cough and difficulty breathing; rapid shock and death if not treated early

Introduction: Plague is an infectious disease of animals and humans caused by a bacterium named *Yersinia pestis*.

People usually get plague from being bitten by a rodent flea that is carrying the plague bacterium or by handling an infected animal. Millions of people in Europe died from plague in the Middle Ages, when human homes and places of work were inhabited by flea-infested rats. Today, modern antibiotics are effective against plague, but if an infected person is not treated promptly, the disease is likely to cause illness or death.

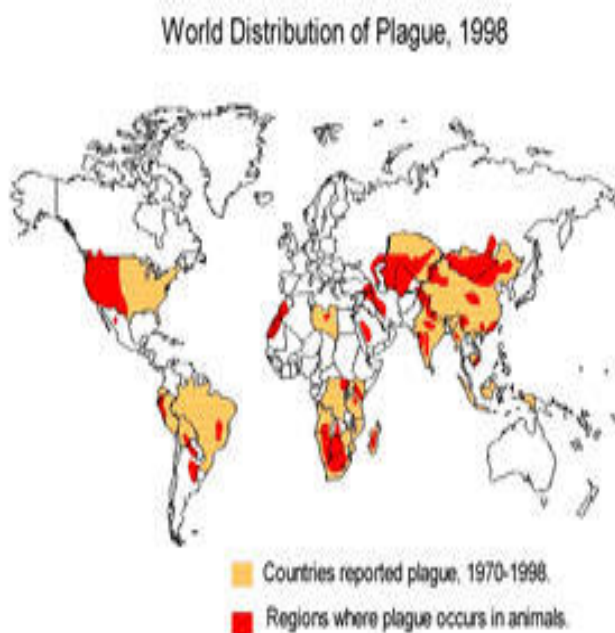

Risk: Wild rodents in certain areas around the world are infected with plague. Outbreaks in people still occur in rural communities or in cities. They are usually associated with infected rats and rat fleas that live in the home. In the United States, the last urban plague epidemic occurred in Los Angeles in 1924-25. Since then, human plague in the United States has occurred as mostly scattered cases in rural areas (an average of 10 to 15 persons each year). Globally, the

World Health Organization reports 1,000 to 3,000 cases of plague every year. In North America, plague is found in certain animals and their fleas from the Pacific Coast to the Great Plains, and from southwestern Canada to Mexico. Most human cases in the United States occur in two regions: 1) northern New Mexico, northern Arizona, and southern Colorado; and 2) California, southern Oregon, and far western Nevada. Plague also exists in Africa, Asia, and South America (see map).

Diagnosis: The typical sign of the most common form of human plague is a swollen and very tender lymph gland, accompanied by pain. The swollen gland is called a "bubo." Bubonic plague should be suspected when a person develops a swollen gland, fever, chills, headache, and extreme exhaustion, and has a history of possible exposure to infected rodents, rabbits, or fleas.

A person usually becomes ill with bubonic plague 2 to 6 days after being infected. When bubonic plague is left untreated, plague bacteria invade the bloodstream. As the plague bacteria multiply in the bloodstream, they spread rapidly throughout the body and cause a severe and often fatal condition. Infection of the lungs with the plague bacterium causes the pneumonic form of plague, a severe respiratory illness. The infected person may experience high fever, chills, cough, and breathing difficulty and may expel bloody sputum. If plague patients are not given specific antibiotic therapy, the disease can progress rapidly to death. About 14% (1 in 7) of all plague cases in the United States are fatal.

Prevention and Control

Risk reduction: Attempts to eliminate fleas and wild rodents from the natural environment in plague-infected areas are impractical. However, controlling rodents and their fleas around places where people live, work, and play is very important in preventing human disease. Therefore, preventive measures are directed to home, work, and recreational settings where the risk of acquiring plague is high. A combined approach using the following methods is recommended: environmental sanitation educating the public on ways to prevent plague exposures preventive antibiotic therapy

Environmental Sanitation: Effective environmental sanitation reduces the risk of persons being bitten by infectious fleas of rodents and other animals in places where people live, work, and recreate. It is important to remove food sources used by rodents and make homes, buildings, warehouses, or feed sheds rodent-proof. Applying chemicals that kill fleas and rodents is effective but should usually be done by trained professionals. Rats that inhabit ships and docks should also be controlled by trained professionals who can inspect and, if necessary, fumigate cargoes.

Public Health Education: In the western United States, where plague is widespread in wild rodents, people living, working, or playing where the infection is active face the greatest threat. Educating the general public and the medical community about how to avoid exposure to disease-bearing animals and their fleas is very important and should include the following preventive recommendations:

- Watch for plague activity in rodent populations where plague is known to occur. Report any observations of sick or dead animals to the local health department or law enforcement officials.
- Eliminate sources of food and nesting places for rodents around homes, work places, and recreation areas; remove brush, rock piles, junk, cluttered firewood, and potential-food supplies, such as pet and wild animal food. Make your home rodent-proof.
- If you anticipate being exposed to rodent fleas, apply insect repellents to clothing and skin, according to label instructions, to prevent flea bites. Wear gloves and tyvek coveralls when handling potentially infected animals.
- If you live in areas where rodent plague occurs, treat pet dogs and cats for flea control regularly and not allow these animals to roam freely.
- Health authorities may use appropriate chemicals to kill fleas at selected sites during animal plague outbreaks.

Prophylactic (preventive) antibiotics: Health authorities advise that antibiotics be given for a brief period to people who have been exposed to the bites of potentially infected rodent fleas (for example, during a plague outbreak) or who have handled an animal known to be infected with the plague bacterium. Such experts also recommend that antibiotics be given if a person has had close exposure to a person or an animal (for example, a house cat) with suspected plague pneumonia.

Persons who must be present in an area where a plague outbreak is occurring can protect themselves for 2 to 3 weeks by taking antibiotics. The preferred antibiotics for prophylaxis against plague are the tetracyclines or the sulfonamides.

Other diseases primarily transmitted by Arthropods (Ticks, mites, lice etc.)

Rickettsial Infections

Description

Many species of *Rickettsia* can cause illnesses in humans (Table below). The term “rickettsiae” conventionally embraces a polyphyletic group of microorganisms in the class Proteobacteria, comprising species belonging to the genera *Rickettsia*, *Orientia*, *Ehrlichia*, *Anaplasma*, *Neorickettsia*, *Coxiella*, and *Bartonella*. These agents are usually not transmissible directly from person to person except by blood transfusion or organ transplantation, although sexual and placental transmission has been proposed for *Coxiella*. Transmission generally occurs via an infected arthropod vector or through exposure to an infected animal reservoir host.

Some of the diseases transmitted in this manner (Typhus, Rocky Mountain Spotted Fever, Q Fever, Ehrlichiosis:) are discussed in detail in this and other Biological Hazard FLDs. A summary of these diseases is included in Attachment 1.

Typhus (Not to be confused with Typhoid Fever [discussed in these FLDs])

For the unrelated disease caused by Salmonella typhi, see Typhoid fever. For the unrelated disease caused by Salmonella paratyphi, please refer to Paratyphoid fever. For the monster of Greek mythology, see Typhus (monster).

Typhus is any one of several similar diseases caused by louse-borne bacteria. The name comes from the Greek *typhos*, meaning smoky or lazy, describing the state of mind of those affected with typhus. *Rickettsia* is endemic in rodent hosts, including mice and rats, and spreads to humans through mites, fleas and body lice. The arthropod vector flourishes under conditions of poor hygiene, such as those found in prisons or refugee camps, amongst the homeless, or until the middle of the 20th century, in armies in the field. In tropical countries, typhus is often mistaken for dengue fever

Epidemic typhus

Epidemic typhus (also called "Jail Fever", "Hospital Fever", "Ship fever", "Famine fever", "Petechial Fever", and "louse-borne typhus") is so named because the disease often causes epidemics following wars and natural disasters. The causative organism is *Rickettsia prowazekii*, transmitted by the human body louse (*Pediculus humanus corporis*). Feeding on a human who carries the bacillus infects the louse. *R. prowazekii* grows in the louse's gut and is excreted in its feces. The disease is then transmitted to an uninfected human who scratches the louse bite (which itches) and rubs the feces into the wound. The incubation period is one to two weeks. *R. prowazekii* can remain viable and virulent in the dried louse feces for many days. Typhus will eventually kill the louse, though the disease will remain viable for many weeks in the dead louse.

The symptoms set in quickly, and are among the most severe of the typhus family. They include severe headache, a sustained high fever, cough, rash, severe muscle pain, chills, falling blood pressure, stupor, sensitivity to light, and delirium. A rash begins on the chest about five days after the fever appears, and spreads to the trunk and extremities but does not reach the palms and soles. A symptom common to all forms of typhus is a fever which may reach 39°C (102°F).

The infection is treated with antibiotics. Intravenous fluids and oxygen may be needed to stabilize the patient. The mortality rate is 10% to 60%, but is vastly lower if antibiotics such as tetracycline are used early. Infection can also be prevented via vaccination. Brill-Zinsser disease is a mild form of epidemic typhus which recurs in someone after a long period of latency (similar to the relationship between chickenpox and shingles). This type of recurrence can also occur in immunosuppressed patients.

Endemic typhu

Endemic typhus (also called "flea-borne typhus" and "murine typhus" or "rat flea typhus") is caused by the bacteria *Rickettsia typhi*, and is transmitted by the fleas that infest rats. Less often, endemic typhus is caused by *Rickettsia felis* and transmitted by fleas carried by cats or possums.

Symptoms of endemic typhus include headache, fever, chills, myalgia, nausea, vomiting, and cough.

Endemic typhus is highly treatable with antibiotics. Most people recover fully, but death may occur in the elderly, severely disabled or patients with a depressed immune system.

Scrub typhus

Scrub typhus (also called "chigger-borne typhus") is caused by *Orientia tsutsugamushi* and transmitted by chiggers, which are found in areas of heavy scrub vegetation. Symptoms include fever, headache, muscle pain, cough, and gastrointestinal symptoms. More virulent strains of *O. tsutsugamushi* can cause hemorrhaging and intravascular coagulation.

Prevention

Limiting exposures to vectors or animal reservoirs remains the best means for reducing the risk for disease. Travelers and persons working in areas where organisms may be present should implement prevention based on avoidance of vector-infested habitats, use of repellents and protective clothing, prompt detection and removal of arthropods from clothing and skin, and attention to hygiene.

Typhus fever was categorized by the Center for Disease Control (CDC) as a Category B biological weapons agent. *Rickettsia prowazekii* is highly infectious and could be fatal but cannot be passed from person to person.

Encephalitis Arboviral Encephalitides

Perspectives

Arthropod-borne viruses, i.e., arboviruses, are viruses that are maintained in nature through biological transmission between susceptible vertebrate hosts by blood feeding arthropods (mosquitoes, psychodids, ceratopogonids, and ticks). Vertebrate infection occurs when the infected arthropod takes a blood meal. The term 'arbovirus' has no taxonomic significance. Arboviruses that cause human encephalitis are members of three virus families: the *Togaviridae* (genus *Alphavirus*, *Flaviviridae*, and *Bunyaviridae*).

All arboviral encephalitides are zoonotic, being maintained in complex life cycles involving a nonhuman primary vertebrate host and a primary arthropod vector. These cycles usually remain undetected until humans encroach on a natural focus, or the virus escapes this focus via a secondary vector or vertebrate host as the result of some ecologic change. Humans and domestic animals can develop clinical illness but usually are "dead-end" hosts because they do not produce significant viremia, and do not contribute to the transmission cycle. Many arboviruses that cause encephalitis have a variety of different vertebrate hosts and some are transmitted by more than one vector. Maintenance of the viruses in nature may be facilitated by vertical transmission (e.g., the virus is transmitted from the female through the eggs to the offspring).

Arboviral encephalitides have a global distribution, but there are four main virus agents of encephalitis in the United States: eastern equine encephalitis (EEE), western equine encephalitis (WEE), St. Louis encephalitis (SLE) and La Crosse (LAC) encephalitis, all of which are transmitted by mosquitoes. Another virus, Powassan, is a minor cause of encephalitis in the northern United States, and is transmitted by ticks. A new Powassan-like virus has recently been isolated from deer ticks. Its relatedness to Powassan virus and its ability to cause disease has not been well documented. Most cases of arboviral encephalitis occur from June through September, when arthropods are most active. In milder (i.e., warmer) parts of the country, where arthropods are active late into the year, cases can occur into the winter months.

There is expanded discussion of several of these diseases (West Nile and Eastern Equine Encephalitis elsewhere in this document. A more general discussion is found in Attachment 2.

Mosquito Borne Diseases

Malaria

Malaria is a mosquito-borne disease caused by a parasite. Four kinds of malaria parasites can infect humans: *Plasmodium falciparum*, *P. vivax*, *P. ovale*, and *P. malariae*.



People with malaria often experience fever, chills, and flu-like illness. Left untreated, they may develop severe complications and die. Each year 350-500 million cases of malaria occur worldwide, and over one million people die, most of them young children in sub-Saharan Africa. Infection with any of the malaria species can make a person feel very ill; infection with *P. falciparum*, if not promptly treated, may be fatal. Although malaria can be a fatal disease, illness and death from malaria are largely preventable.

This sometimes fatal disease can be prevented and cured. Bed nets, insecticides, and anti-malarial drugs are effective tools to fight malaria in areas where it is transmitted. Travelers to a malaria-risk area should avoid mosquito bites and take a preventive anti-malarial drug. Malaria was eradicated from the United States in the early 1950s. However, malaria is common in many developing countries and travelers who visit these areas risk getting malaria.

Returning travelers and arriving immigrants could also reintroduce the disease in the United States if they are infected with malaria when they return. The mosquito that transmits malaria, *Anopheles*, is found throughout much of the United States. If local mosquitoes bite an infected person, those mosquitoes can, in turn, infect local residents (*introduced malaria*).

Because the malaria parasite is found in red blood cells, malaria can also be transmitted through blood transfusion, organ transplant, or the shared use of needles or syringes contaminated with blood. Malaria may also be transmitted from a mother to her fetus before or during delivery ("congenital" malaria).

Malaria is not transmitted from person to person like a cold or the flu. You cannot get malaria from casual contact with malaria-infected people.

Prevention and control

You can prevent malaria by:

- keeping mosquitoes from biting you, especially at night
- taking anti-malarial drugs to kill the parasites
- eliminating places where mosquitoes breed
- spraying insecticides on walls to kill adult mosquitoes that come inside
- sleeping under bed nets - especially effective if they have been treated with insecticide,
- wearing insect repellent and long-sleeved clothing if out of doors at night

The surest way for you and your health-care provider to know whether you have malaria is to have a diagnostic test where a drop of your blood is examined under the microscope for the presence of malaria parasites. If you are sick and there is any suspicion of malaria (for example, if you have recently traveled in a malaria-risk area) the test should be performed without delay.

The disease should be treated early in its course, before it becomes severe and poses a risk to the patient's life. Several good anti-malarial drugs are available, and should be administered early on. The most important step is to think about malaria, so that the disease is diagnosed and treated in time.

West Nile Virus

West Nile virus (WNV) is a potentially serious illness. Experts believe WNV is established as a seasonal epidemic in North America that flares up in the summer and continues into the fall. This fact sheet contains important information that can help you recognize and prevent WNV.

The easiest and best way to avoid WNV is to prevent mosquito bites.

- When you are outdoors, use insect repellent containing an EPA-registered active ingredient. Follow the directions on the package.
- Many mosquitoes are most active at dusk and dawn. Be sure to use insect repellent and wear long sleeves and pants at these times or consider staying indoors during these hours.
- Make sure you have good screens on your windows and doors to keep mosquitoes out.
- Get rid of mosquito breeding sites by emptying standing water from buckets, barrels and drainage ditches.

About one in 150 people infected with WNV will develop severe illness. The severe symptoms can include high fever, headache, neck stiffness, stupor, disorientation, coma, tremors, convulsions, muscle weakness, vision loss, numbness and paralysis. These symptoms may last several weeks, and neurological effects may be permanent.

Up to 20 percent of the people who become infected have symptoms such as fever, headache, and body aches, nausea, vomiting, and sometimes swollen lymph glands or a skin rash on the

chest, stomach and back. Symptoms can last for as short as a few days, though even healthy people have become sick for several weeks.

Approximately 80 percent of people (about 4 out of 5) who are infected with WNV will not show any symptoms at all.

Most often, WNV is spread by the bite of an infected mosquito. Mosquitoes become infected when they feed on infected birds. Infected mosquitoes can then spread WNV to humans and other animals when they bite.

In a very small number of cases, WNV also has been spread through blood transfusions, organ transplants, breastfeeding and even during pregnancy from mother to baby.

WNV is not spread through casual contact such as touching or kissing a person with the virus.

Symptoms typically develop between 3 - 14 days after being bitten by an infected mosquito.

There is no specific treatment for WNV infection. In cases with milder symptoms, people experience symptoms such as fever and aches that pass on their own, although even healthy people have become sick for several weeks. In more severe cases, people usually need to go to the hospital where they can receive supportive treatment including intravenous fluids, help with breathing and nursing care.

Milder WNV illness improves on its own, and people do not necessarily need to seek medical attention for this infection though they may choose to do so. If you develop symptoms of severe WNV illness, such as unusually severe headaches or confusion, seek medical attention immediately. Severe WNV illness usually requires hospitalization. Pregnant women and nursing mothers are encouraged to talk to their doctor if they develop symptoms that could be WNV. People over the age of 50 are more likely to develop serious symptoms of WNV if they do get sick and should take special care to avoid mosquito bites.

The more time you're outdoors, the more time you could be bitten by an infected mosquito. Pay attention to avoiding mosquito bites if you spend a lot of time outside, either working or playing.

All donated blood is checked for WNV before being used. The risk of getting WNV through blood transfusions and organ transplants is very small, and should not prevent people who need surgery from having it. If you have concerns, talk to your doctor.

Equine Encephalitis

Eastern equine encephalitis (EEE) is a mosquito-borne viral disease. EEE virus (EEEV) occurs in the eastern half of the United States where it causes disease in humans, horses, and some bird species. Because of the high mortality rate, EEE is regarded as one of the most serious mosquito-borne diseases in the United States.

EEEV is transmitted to humans through the bite of an infected mosquito. It generally takes from

3 to 10 days to develop symptoms of EEE after being bitten by an infected mosquito. The main EEEV transmission cycle is between birds and mosquitoes.

Many species of mosquitoes can become infected with EEEV. The most important mosquito species in maintaining the bird-mosquito transmission cycle is *Culiseta melanura*, which reproduces in freshwater hardwood swamps. *Culiseta melanura*, however, is not considered to be an important vector of EEEV to horses or humans because it feeds almost exclusively on birds.

Transmission to horses or humans requires mosquito species capable of creating a “bridge” between infected birds and uninfected mammals such as some *Aedes*, *Coquillettidia*, and *Culex* species.

Horses are susceptible to EEE and some cases are fatal. EEEV infections in horses, however, are not a significant risk factor for human infection because horses are considered to be “dead-end” hosts for the virus (i.e., the amount of EEEV in their bloodstreams is usually insufficient to infect mosquitoes).

Eastern equine encephalitis virus is a member of the family *Togaviridae*, genus *Alphavirus* closely related to Western equine encephalitis virus and Venezuelan equine encephalitis virus

Many persons infected with EEEV have no apparent illness. In those persons who do develop illness, symptoms range from mild flu-like illness to inflammation of the brain, coma and death.

The mortality rate from EEE is approximately one-third, making it one of the most deadly mosquito-borne diseases in the United States.

There is no specific treatment for EEE; optimal medical care includes hospitalization and supportive care (for example, expert nursing care, respiratory support, prevention of secondary bacterial infections, and physical therapy, depending on the situation).

Approximately half of those persons who survive EEE will have mild to severe permanent neurologic damage.

Incidence rate includes:

- Approximately 220 confirmed cases in the US 1964-2004, Average of 5 cases/year, with a range from 0-15 cases
- States with largest number of cases are Florida, Georgia, Massachusetts, and New Jersey.
- EEEV transmission is most common in and around freshwater hardwood swamps in the Atlantic and Gulf Coast states and the Great Lakes region.
- Human cases occur relatively infrequently, largely because the primary transmission cycle takes place in and around swampy areas where human populations tend to be limited.

Risk Groups:

- Residents of and visitors to endemic areas (areas with an established presence of the virus)
- People who engage in outdoor work and recreational activities in endemic areas.
- Persons over age 50 and younger than age 15 seem to be at greatest risk for developing severe EEE when infected with the virus.

Prevention

- A vaccine is available to protect equines.
- People should avoid mosquito bites by employing personal and workplace protection measures, such as using an EPA-registered repellent according to manufacturers' instructions, wearing protective clothing, avoiding outdoor activity when mosquitoes are active (some bridge vectors of EEEV are aggressive day-biters), and removing standing water that can provide mosquito breeding sites.
- There are laboratory tests to diagnosis EEEV infection including serology, especially IgM testing of serum and cerebrospinal fluid (CSF), and neutralizing antibody testing of acute- and convalescent-phase serum.

Yellow Fever

Yellow fever is an acute viral disease. It is an important cause of hemorrhagic illness in many African and South American countries despite existence of an effective vaccine. The *yellow* refers to the jaundice symptoms that affect some patients.

Yellow fever is caused by an arbovirus of the family Flaviviridae, a positive single-stranded RNA virus. Human infection begins after deposition of viral particles through the skin in infected arthropod saliva. The mosquitoes involved are *Aedes simpsoni*, *A. africanus*, and *A. aegypti* in Africa, the *Haemagogus* genus in South America.

The virus remains silent in the body during an incubation period of three to six days. There are then two disease phases. While some infections have no symptoms the first, *acute* phase is normally characterized by fever, muscle pain (with prominent backache), headache, shivers, loss of appetite, and nausea or vomiting. The high fever is often paradoxically associated with a slow pulse (known as Faget's sign). After three or four days most patients improve and their symptoms disappear.

Fifteen percent of patients, however, enter a *toxic phase* within 24 hours. Fever reappears and several body systems are affected. The patient rapidly develops jaundice and complains of abdominal pain with vomiting. Bleeding can occur from the mouth, nose, eyes, and stomach. Once this happens, blood appears in the vomit and feces. Kidney function deteriorates; this can range from abnormal protein levels in the urine (proteinuria) to complete kidney failure with no

urine production (anuria). Half of the patients in the "toxic phase" die within fourteen days. The remainder recover without significant organ damage.

Yellow fever is difficult to recognize, especially during the early stages. It can easily be confused with malaria, typhoid, rickettsial diseases, haemorrhagic viral fevers (e.g. Lassa), arboviral infections (e.g. dengue), leptospirosis, viral hepatitis and poisoning (e.g. carbon tetrachloride). A laboratory analysis is required to confirm a suspect case.

Prevention

There is a vaccine for yellow fever that gives a ten-year or more immunity from the disease and effectively protects people traveling to affected areas. The vaccination may be required for entry to some countries, however, the vaccine may be contra-indicated for person over 60 years of age.

Use precautions as for other mosquito borne diseases. Avoid mosquito bites by employing personal and workplace protection measures, such as using an EPA-registered repellent according to manufacturers' instructions, wearing protective clothing, avoiding outdoor activity when mosquitoes are active and removing standing water that can provide mosquito breeding sites.

Meningitis

Meningitis is a viral disease that can affect the central nervous system.

Meningitis is encountered in agricultural regions of Asia.

Meningitis is transmitted through the bite from an infected mosquito.

Symptoms can be nonexistent or severe and flu-like, with fever, chills, tiredness, headache, nausea and vomiting. If not treated promptly the disease can be fatal.

Prevention

- A vaccine is available. It's 80% effective after a single dose and 97.5% effective after a second dose.

Use precautions as for other mosquito borne diseases. Avoid mosquito bites by employing personal and workplace protection measures, such as using an EPA-registered repellent according to manufacturers' instructions, wearing protective clothing, avoiding outdoor activity when mosquitoes are active and removing standing water that can provide mosquito breeding sites.

Sand Flies

Leishmaniasis



Sand Fly and Mosquito



Sand Fly

Leishmaniasis (LEASH-ma-NIGH-a-sis) is a parasitic disease spread by the bite of infected sand flies. There are several different forms of leishmaniasis. The most common forms are **cutaneous leishmaniasis**, which causes skin sores, and **visceral leishmaniasis**, which affects some of the internal organs of the body (for example, spleen, liver, bone marrow).

People who have cutaneous leishmaniasis have one or more sores on their skin. The sores can change in size and appearance over time. They often end up looking somewhat like a volcano, with a raised edge and central crater. Some sores are covered by a scab. The sores can be painless or painful. Some people have swollen glands near the sores (for example, under the arm if the sores are on the arm or hand).

People who have visceral leishmaniasis usually have fever, weight loss, and an enlarged spleen and liver (usually the spleen is bigger than the liver). Some patients have swollen glands. Certain blood tests are abnormal. For example, patients usually have low blood counts, including a low red blood cell count (anemia), low white blood cell count, and low platelet count.

The number of new cases of cutaneous leishmaniasis each year in the world is thought to be about 1.5 million. The number of new cases of visceral leishmaniasis is thought to be about 500,000.

Leishmaniasis is found in parts of about 88 countries. Approximately 350 million people live in these areas. Most of the affected countries are in the tropics and subtropics. The settings in which leishmaniasis is found range from rain forests in Central and South America to deserts in West Asia. More than 90 percent of the world's cases of visceral leishmaniasis are in India, Bangladesh, Nepal, Sudan, and Brazil.

Leishmaniasis is found in some parts of the following areas:

- in Mexico, Central America, and South America -- from northern Argentina to Texas (not in Uruguay, Chile, or Canada)
- southern Europe (leishmaniasis is not common in travelers to southern Europe)
- Asia (not Southeast Asia)
- the Middle East
- Africa (particularly East and North Africa, with some cases elsewhere)

Leishmaniasis is not found in Australia or Oceania (that is, islands in the Pacific, including Melanesia, Micronesia, and Polynesia).

It is possible but very unlikely that you would get leishmaniasis in the United States. Very rarely, people living in Texas have developed skin sores from cutaneous leishmaniasis.

No cases of visceral leishmaniasis are known to have been acquired in the United States.

Leishmaniasis is spread by the bite of some types of phlebotomine sand flies. Sand flies become infected by biting an infected animal (for example, a rodent or dog) or person. Since sand flies do not make noise when they fly, people may not realize they are present. Sand flies are very small and may be hard to see; they are only about one-third the size of typical mosquitoes. Sand flies usually are most active in twilight, evening, and night-time hours (from dusk to dawn). Sand flies are less active during the hottest time of the day. However, they will bite if they are disturbed, such as when a person brushes up against the trunk of a tree where sand flies are resting. Rarely, leishmaniasis is spread from a pregnant woman to her baby. Leishmaniasis also can be spread by blood transfusions or contaminated needles.

People of all ages are at risk for leishmaniasis if they live or travel where leishmaniasis is found. Leishmaniasis usually is more common in rural than urban areas; but it is found in the outskirts of some cities. The risk for leishmaniasis is highest from dusk to dawn because this is when sand flies are the most active. All it takes to get infected is to be bitten by one infected sand fly. This is more likely to happen the more people are bitten, that is, the more time they spend outside in rural areas from dusk to dawn.

People with cutaneous leishmaniasis usually develop skin sores within a few weeks (sometimes as long as months) of when they were bitten.

People with visceral leishmaniasis usually become sick within several months (rarely as long as years) of when they were bitten.

The skin sores of cutaneous leishmaniasis will heal on their own, but this can take months or even years. The sores can leave ugly scars. If not treated, infection that started in the skin rarely spreads to the nose or mouth and causes sores there (**mucosal leishmaniasis**). This can happen with some of the types of the parasite found in Central and South America. Mucosal leishmaniasis might not be noticed until years after the original skin sores healed. The best way to prevent mucosal leishmaniasis is to treat the cutaneous infection before it spreads.

If not treated, visceral leishmaniasis can cause death. It is very rare for travelers to get visceral leishmaniasis.

If you think you might have leishmaniasis, report to your Safety Officer to ensure appropriate follow-up. The first step is to find out if you have traveled to a part of the world where leishmaniasis is found. The health care provider will ask you about any signs or symptoms of leishmaniasis you may have, such as skin sores that have not healed. If you have skin sores, the health care provider will likely want to take some samples directly from the sores. These samples can be examined for the parasite under a microscope, in cultures, and through other means. A blood test for detecting antibody (immune response) to the parasite can be helpful, particularly for cases of visceral leishmaniasis. However, tests to look for the parasite itself should also be done. Diagnosing leishmaniasis can be difficult. Sometimes the laboratory tests are negative even if a person has leishmaniasis.

The health care provider can talk with CDC staff about whether a case of leishmaniasis should be treated, and, if so, how. Most people who have cutaneous leishmaniasis do not need to be hospitalized during their treatment.

Prevention

The best way prevent leishmaniasis is by protecting against sand fly bites. Vaccines and drugs for preventing infection are not yet available. To decrease risk of being bitten:

- Stay in well-screened or air-conditioned areas as much as possible. Avoid outdoor activities, especially from dusk to dawn, when sand flies are the most active.
- When outside, wear long-sleeved shirts, long pants, and socks. Tuck your shirt into your pants.
- Apply insect repellent on uncovered skin and under the ends of sleeves and pant legs. Follow the instructions on the label of the repellent. The most effective repellents are those that contain the chemical DEET (N,N-diethylmetatoluamide). The concentration of DEET varies among repellents. Repellents with DEET concentrations of 30-35% are quite effective, and the effect should last about 4 hours. Lower concentrations should be used for children (no more than 10% DEET). Repellents with DEET should be used sparingly on children from 2 to 6 years old and not at all on children less than 2 years old.
- Spray clothing with permethrin-containing insecticides. The insecticide should be reapplied after every five washings.
- Spray living and sleeping areas with an insecticide to kill insects.
- If you are not sleeping in an area that is well screened or air-conditioned, use a bed net and tuck it under your mattress. If possible, use a bed net that has been soaked in or sprayed with permethrin. The permethrin will be effective for several months if the bed net is not washed. Keep in mind that sand flies are much smaller than mosquitoes and therefore can get through

smaller holes. Fine-mesh netting (at least 18 holes to the inch; some sources say even finer) is needed for an effective barrier against sand flies. This is particularly important if the bed net has not been treated with permethrin. However, it may be uncomfortable to sleep under such a closely woven bed net when it is hot.

NOTE: Bed nets, repellents containing DEET, and permethrin may need to be purchased before traveling and can be found in hardware, camping, and military surplus stores.

Deer Flies (See Tularemia above)

ATTACHMENT 1

RICKETTSIAL INFECTIONS

Rickettsial Infections

Description

Many species of *Rickettsia* can cause illnesses in humans (Table below). The term “rickettsiae” conventionally embraces a polyphyletic group of microorganisms in the class Proteobacteria, comprising species belonging to the genera *Rickettsia*, *Orientia*, *Ehrlichia*, *Anaplasma*, *Neorickettsia*, *Coxiella*, and *Bartonella*. These agents are usually not transmissible directly from person to person except by blood transfusion or organ transplantation, although sexual and placental transmission has been proposed for *Coxiella*. Transmission generally occurs via an infected arthropod vector or through exposure to an infected animal reservoir host. However, sennetsu fever is acquired following consumption of raw fish products. The clinical severity and duration of illnesses associated with different rickettsial infections vary considerably, even within a given antigenic group. Rickettsioses range in severity from diseases that are usually relatively mild (rickettsialpox, cat scratch disease, and African tick-bite fever) to those that can be life-threatening (epidemic and murine typhus, Rocky Mountain spotted fever, scrub typhus and Oroya fever), and they vary in duration from those that can be self-limiting to chronic (Q fever and bartonellosis) or recrudescent (Brill-Zinsser disease). Most patients with rickettsial infections recover with timely use of appropriate antibiotic therapy.

Travelers may be at risk for exposure to agents of rickettsial diseases if they engage in occupational or recreational activities which bring them into contact with habitats that support the vectors or animal reservoir species associated with these pathogens.

The geographic distribution and the risks for exposure to rickettsial agents are described below and in the Table below.

Epidemic Typhus and Trench Fever

Epidemic typhus and trench fever, which are caused by *Rickettsia prowazkeii* and *Bartonella quintana*, respectively, are transmitted from one person to another by the human body louse. Contemporary outbreaks of both diseases are rare in most developed countries and generally occur only in communities and populations in which body louse infestations are frequent, especially during the colder months when louse-infested clothing is not laundered. Foci of trench fever have also been recognized among homeless populations in urban centers of industrialized countries. Travelers who are not at risk of exposure to body lice or to persons with lice are unlikely to acquire these illnesses. However, health-care workers who care for these patients may be at risk for acquiring louse-borne illnesses through inhalation or inoculation of infectious louse feces into the skin or conjunctiva. In the eastern United States, campers, inhabitants of wooded areas, and wildlife workers can acquire sylvatic epidemic typhus if they come in close contact with flying squirrels, their ectoparasites, or their nests, which can be made in houses, cabins, and tree-holes.

Murine Typhus and Cat-Flea Rickettsiosis

Murine typhus, which is caused by infection with *Rickettsia typhi*, is transmitted to humans by rat fleas, particularly during exposure in rat-infested buildings (3). Flea-infested rats can be found throughout the year in humid tropical environments, especially in harbor or riverine environments. In temperate regions, they are most common during the warm summer months. Similarly, cat-flea rickettsiosis, which is caused by infection with *Rickettsia felis*, occurs worldwide from exposure to flea-infested domestic cats and dogs, as well as peridomestic animals, and is responsible for a murine typhus-like febrile disease in humans.

Scrub Typhus

Mites (“chiggers”) transmit *Orientia tsutsugamushi*, the agent of scrub typhus, to humans. These mites occur year-round in a large area from South Asia to Australia and in much of East Asia, including Japan, China, Korea, Maritime Provinces and Sakhalin Island of Russia, and Tajikistan. Their prevalence, however, fluctuates with temperature and rainfall. Infection may occur on coral atolls in both the Indian and Pacific Oceans, in rice paddies and along canals and fields, on oil palm plantations, in tropical to desert climates and in elevated river valleys. Humans typically encounter the arthropod vector of scrub typhus in recently disturbed habitat (e.g., forest clearings) or other persisting mite foci infested with rats and other rodents.

Tick-Borne Rickettsioses

Tick-borne rickettsial diseases are most common in temperate and subtropical regions. These diseases include numerous well-known classical spotted fever rickettsioses and an expanding group of newly recognized diseases (Table below). In general, peak transmission of tick-borne rickettsial pathogens occurs during spring and summer months. Travelers who participate in outdoor activities in grassy or wooded areas (e.g., trekking, camping, or going on safari) may be at risk for acquiring tick-borne illnesses, including those caused by *Rickettsia*, *Anaplasma*, and *Ehrlichia* species (see below).

TABLE Epidemiologic features and symptoms of rickettsial diseases

ANTIGENIC GROUP	DISEASE	AGENT	PREDOMINANT SYMPTOMS*	VECTOR OR ACQUISITION MECHANISM	ANIMAL RESERVOIR	GEOGRAPHIC DISTRIBUTION OUTSIDE THE US
Typhus fevers	Epidemic typhus, Sylvatic typhus	<i>Rickettsia prowazekii</i>	Headache, chills, fever, prostration, confusion, photophobia, vomiting, rash (generally starting on trunk)	Human body louse, squirrel flea and louse	Humans, flying squirrels (US)	Cool mountainous regions of Africa, Asia, and Central and South America
	Murine typhus	<i>R. typhi</i>	As above, generally less severe	Rat flea	Rats, mice	Worldwide
Spotted fevers	African tickbite fever	<i>R. africae</i>	Fever, eschar(s), regional adenopathy,	Tick	Rodents	Sub-Saharan Africa

ANTIGENIC GROUP	DISEASE	AGENT	PREDOMINANT SYMPTOMS*	VECTOR OR ACQUISITION MECHANISM	ANIMAL RESERVOIR	GEOGRAPHIC DISTRIBUTION OUTSIDE THE US
			maculopapular or vesicular rash subtle or absent			
	Aneruptive fever	<i>R. helvetica</i>	Fever, headache, myalgia	Tick	Rodents	Old World
	Australian spotted fever	<i>R. marmionii</i>	Fever, eschar, maculopapular or vesicular rash, adenopathy	Tick	Rodents, reptiles	Australia
	Cat flea rickettsiosis	<i>R. felis</i>	As murine typhus, generally less severe	Cat and dog fleas	Domestic cats, opossums	Europe, South America
	Far Eastern spotted fever	<i>R. heilongjiangensis</i>	Fever, eschar, macular or maculopapular rash, lymphadenopathy, enlarged lymph nodes	Tick	Rodents	Far East of Russia, Northern China
	Flinders Island spotted fever, Thai tick typhus	<i>R. honei</i>	Mild spotted fever, eschar and adenopathy are rare	Tick	Not defined	Australia, Thailand
	Lymphangitis associated rickettsiosis	<i>R. sibirica</i> subsp. <i>mongolotimonae</i>	Fever, multiple eschars, regional adenopathy and lymphangitis, maculopapular rash	Tick	Rodents	Southern France, Portugal, Asia, Africa
	Maculatum infection	<i>R. parkeri</i>	Fever, eschar, rash maculopapular to vesicular	Tick	Rodents	Brazil, Uruguay
	Mediterranean spotted fevers‡	<i>R. conorii</i>	Fever, eschar, regional adenopathy, maculopapular rash on extremities	Tick	Dogs, rodents	Africa, India, Europe, Middle East, Mediterranean
	North Asian tick typhus	<i>R. sibirica</i>	Fever, eschar(s), regional adenopathy, maculopapular rash	Tick	Rodents	Russia, China, Mongolia
	Oriental spotted fever	<i>R. japonica</i>	As above	Tick	Rodents	Japan
	Queensland tick	<i>R. australis</i>	Fever, eschar,	Tick	Not defined	Australia,

ANTIGENIC GROUP	DISEASE	AGENT	PREDOMINANT SYMPTOMS*	VECTOR OR ACQUISITION MECHANISM	ANIMAL RESERVOIR	GEOGRAPHIC DISTRIBUTION OUTSIDE THE US
	typhus		regional adenopathy, rash on extremities			Tasmania
	Rickettsialpox	<i>R. akari</i>	Fever, eschar, adenopathy, disseminated vesicular rash	Mite	House mice	Russia, South Africa, Korea, Turkey, Balkan countries
	Rocky Mountain spotted fever, Sao Paulo exanthematic typhus, Minas Gerais exanthematic typhus, Brazilian spotted fever	<i>R. rickettsii</i>	Headache, fever, abdominal pain, macular rash progressing into papular or petechial (generally starting on extremities)	Tick	Rodents	Mexico, Central, and South America
	Tick-borne lymphadenopathy (TIBOLA), Dermacentor-borne necrosis and lymphadenopathy (DEBONEL)	<i>R. slovaca</i>	Necrosis erythema, cervical lymphadenopathy and enlarged lymph nodes, rare maculopapular rash	Tick	Lagomorphs, rodents	Europe, Asia
	Unnamed rickettsiosis	<i>R. aeschlimannii</i>	Fever, eschar, maculopapular rash	Tick	Domestic and wild animals	Africa
Orientia	Scrub typhus	<i>Orientia tsutsugamushi</i>	Fever, headache, sweating, conjunctival injection, adenopathy, eschar, rash (starting on trunk), respiratory distress	Mite	Rodents	South, Central, Eastern, and Southeast Asia and Australia
Coxiella	Q fever	<i>Coxiella burnetii</i>	Fever, headache, chills, sweating, pneumonia, hepatitis, endocarditis	Most human infections are acquired by inhalation of infectious aerosols; tick	Goats, sheep, cattle, domestic cats, other	Worldwide

ANTIGENIC GROUP	DISEASE	AGENT	PREDOMINANT SYMPTOMS*	VECTOR OR ACQUISITION MECHANISM	ANIMAL RESERVOIR	GEOGRAPHIC DISTRIBUTION OUTSIDE THE US
Bartonella	Cat-scratch disease	<i>Bartonella henselae</i>	Fever, adenopathy, neuroretinitis, encephalitis	Cat flea	Domestic cats	Worldwide
	Trench fever	<i>B. quintana</i>	Fever, headache, pain in shins, splenomegaly, disseminated rash	Human body louse	Humans	Worldwide
	Oroya fever	<i>B. bacilliformis</i>	Fever, headache, anemia, shifting joint and muscle pain, nodular dermal eruption	Sand fly	Unknown	Peru, Ecuador, Colombia
Ehrlichia	Ehrlichiosis	<i>Ehrlichia chaffeensis</i> [‡]	Fever, headache, nausea, occasionally rash	Tick	Various large and small mammals, including deer and rodents	Worldwide
Anaplasma	Anaplasmosis	<i>Anaplasma phagocytophilum</i> [#]	Fever, headache, nausea, occasionally rash	Tick	Small mammals, and rodents	Europe, Asia, Africa
Neorickettsia	Sennetsu fever	<i>Neorickettsia sennetsu</i>	Fever, chills, headache, sore throat, insomnia	Fish, fluke	Fish	Japan, Malaysia

This represents only a partial list of symptoms. Patients may have different symptoms or only a few of those listed.

‡ Includes 4 different subspecies that can be distinguished serologically and by PCR assay, and respectively are the etiologic agents of Boutonneuse fever and Mediterranean tick fever in Southern Europe and Africa (*R. conorii* subsp. *conorii*), Indian tick typhus in South Asia (*R. conorii* subsp. *indica*), Israeli tick typhus in Southern Europe and Middle East (*R. conorii* subsp. *israelensis*), and Astrakhan spotted fever in the North Caspian region of Russia (*R. conorii* subsp. *caspiæ*).

Organisms antigenically related to these species are associated with ehrlichial diseases outside the continental United States.

Rickettsialpox

Rickettsialpox is generally an urban, mite-vector disease associated with *R. akari*-infected house mice, although feral rodent-mite reservoirs also have been described (3). Outbreaks of this illness have occurred shortly after rodent extermination programs or natural viral infections that depleted rodent populations and caused the mites to seek new hosts. *R. akari*-infected rodents have been found in urban centers in the former Soviet Union, South Africa, Korea, Croatia, and the United States. Travelers may be at risk for exposure to rodent mites when staying in old urban hostels and cabins.

Anaplasmosis and Ehrlichiosis

Human ehrlichiosis and anaplasmosis are acute tick-borne diseases, associated with the lone star tick, *Amblyomma americanum*, and *Ixodes* ticks, respectively. Because one tick may be infected with more than one tick-borne pathogen (e.g. *Borrelia burgdorferi*, the causative agent of Lyme disease, or various *Babesia* species, agent of human babesiosis), patients may present with atypical clinical symptoms that complicate treatment. Ehrlichiosis and anaplasmosis are characterized by infection of different types of leukocytes, where the causative agent multiplies in cytoplasmic membrane-bound vacuole called morulae. Morulae can sometimes be detected in Giemsa-stained blood smears.

Q FEVER

Q fever occurs worldwide, most often in persons who have contact with infected goat, sheep, cat and cattle, particularly parturient animals (especially farmers, veterinarians, butchers, meat packers, and seasonal workers). Travelers who visit farms or rural communities can be exposed to *Coxiella burnetii*, the agent of Q fever, through airborne transmission (via animal-contaminated soil and dust) or less commonly through consumption of unpasteurized milk products or by exposure to infected ticks. These infections may initially result in only mild and self-limiting influenza-like illnesses, but if untreated, infections may become chronic, particularly in persons with preexisting heart valve abnormalities or with prosthetic valves. Such persons can develop chronic and potentially fatal endocarditis.

Cat-Scratch Disease and Oroya Fever

Cat-scratch disease is contracted through scratches and bites from domestic cats, particularly kittens, infected with *Bartonella henselae*, and possibly from their fleas (3,4). Exposure can therefore occur wherever cats are found. Oroya fever is transmitted by sandflies infected with *B. bacilliformis*, which is endemic in the Andean highlands.

Symptoms

Clinical presentations of rickettsial illnesses vary (Table above), but common early symptoms, including fever, headache, and malaise, are generally nonspecific. Illnesses resulting from infection with rickettsial agents may go unrecognized or are attributed to other causes. Atypical presentations are common and may be expected with poorly characterized non-indigenous agents, so appropriate samples for examination by specialized reference laboratories should be obtained. A diagnosis of rickettsial diseases is based on two or more of the following: 1) clinical symptoms and an epidemiologic history compatible with a rickettsial disease, 2) the development of specific convalescent-phase antibodies reactive with a given pathogen or antigenic group, 3) a positive polymerase chain reaction test result, 4) specific immunohistologic detection of rickettsial agent, or 5) isolation of a rickettsial agent. Ascertaining the likely place and the nature of potential exposures is particularly helpful for accurate diagnostic testing.

Prevention

With the exception of the louse-borne diseases described above, for which contact with infectious arthropod feces is the primary mode of transmission (through autoinoculation into a wound, conjunctiva, or inhalation), travelers and health-care providers are generally not at risk for becoming infected via exposure to an ill person. Limiting exposures to vectors or animal reservoirs remains the best means for reducing the risk for disease. Travelers and persons working in areas where organisms may be present should implement prevention based on avoidance of vector-infested habitats, use of repellents and protective clothing, prompt detection and removal of arthropods from clothing and skin, and attention to hygiene.

Q fever and *Bartonella* group diseases may pose a special risk for persons with abnormal or prosthetic heart valves, and *Rickettsia*, *Ehrlichia*, and *Bartonella* for persons who are immunocompromised.

ATTACHMENT 2

ENCEPHALITIS ARBOVIRAL ENCEPHALITIDES

Encephalitis Arboviral Encephalitides

Perspectives

Arthropod-borne viruses, i.e., arboviruses, are viruses that are maintained in nature through biological transmission between susceptible vertebrate hosts by blood feeding arthropods (mosquitoes, psychodids, ceratopogonids, and ticks). Vertebrate infection occurs when the infected arthropod takes a blood meal. The term 'arbovirus' has no taxonomic significance. Arboviruses that cause human encephalitis are members of three virus families: the *Togaviridae* (genus *Alphavirus*, *Flaviviridae*, and *Bunyaviridae*).

All arboviral encephalitides are zoonotic, being maintained in complex life cycles involving a nonhuman primary vertebrate host and a primary arthropod vector. These cycles usually remain undetected until humans encroach on a natural focus, or the virus escapes this focus via a secondary vector or vertebrate host as the result of some ecologic change. Humans and domestic animals can develop clinical illness but usually are "dead-end" hosts because they do not produce significant viremia, and do not contribute to the transmission cycle. Many arboviruses that cause encephalitis have a variety of different vertebrate hosts and some are transmitted by more than one vector. Maintenance of the viruses in nature may be facilitated by vertical transmission (e.g., the virus is transmitted from the female through the eggs to the offspring).

Arboviral encephalitides have a global distribution, but there are four main virus agents of encephalitis in the United States: eastern equine encephalitis (EEE), western equine encephalitis (WEE), St. Louis encephalitis (SLE) and La Crosse (LAC) encephalitis, all of which are transmitted by mosquitoes. Another virus, Powassan, is a minor cause of encephalitis in the northern United States, and is transmitted by ticks. A new Powassan-like virus has recently been isolated from deer ticks. Its relatedness to Powassan virus and its ability to cause disease has not been well documented. Most cases of arboviral encephalitis occur from June through September, when arthropods are most active. In milder (i.e., warmer) parts of the country, where arthropods are active late into the year, cases can occur into the winter months.

The majority of human infections are asymptomatic or may result in a nonspecific flu-like syndrome. Onset may be insidious or sudden with fever, headache, myalgias, malaise and occasionally prostration. Infection may, however, lead to encephalitis, with a fatal outcome or permanent neurologic sequelae. Fortunately, only a small proportion of infected persons progress to frank encephalitis.

Experimental studies have shown that invasion of the central nervous system (CNS), generally follows initial virus replication in various peripheral sites and a period of viremia. Viral transfer from the blood to the CNS through the olfactory tract has been suggested. Because the arboviral encephalitides are viral diseases, antibiotics are not effective for treatment and no effective antiviral drugs have yet been discovered.

Prevention

Arboviral encephalitis can be prevented in two major ways: personal protective measures and public health measures to reduce the population of infected mosquitoes. Personal measures include reducing time outdoors particularly in early evening hours, wearing long pants and long sleeved shirts and applying mosquito repellent to exposed skin areas. Public health measures often require spraying of insecticides to kill juvenile (larvae) and adult mosquitoes.

Selection of mosquito control methods depends on what needs to be achieved; but, in most emergency situations, the preferred method to achieve maximum results over a wide area is aerial spraying. In many states aerial spraying may be available in certain locations as a means to control nuisance mosquitoes. Such resources can be redirected to areas of virus activity. When aerial spraying is not routinely used, such services are usually contracted for a given time period. Financing of aerial spraying costs during large outbreaks is usually provided by state emergency contingency funds. Federal funding of emergency spraying is rare and almost always requires a federal disaster declaration. Such disaster declarations usually occur when the vector-borne disease has the potential to infect large numbers of people, when a large population is at risk and when the area requiring treatment is extensive. Special large planes maintained by the United States Air Force can be called upon to deliver the insecticide(s) chosen for such emergencies. Federal disaster declarations have relied heavily on risk assessment by the CDC.

There are no commercially available human vaccines for these U.S. diseases. There is a Japanese encephalitis vaccine available in the U.S. A tick-borne encephalitis vaccine is available in Europe. An equine vaccine is available for EEE, WEE and Venezuelan equine encephalitis (VEE).

La Crosse Encephalitis

La Crosse (LAC) encephalitis was discovered in La Crosse, Wisconsin in 1963. Since then, the virus has been identified in several Midwestern and Mid-Atlantic states. During an average year, about 75 cases of LAC encephalitis are reported to the CDC. Most cases of LAC encephalitis occur in children under 16 years of age. LAC virus is a Bunyavirus and is a zoonotic pathogen cycled between the daytime-biting treehole mosquito, *Aedes triseriatus*, and vertebrate amplifier hosts (chipmunks, tree squirrels) in deciduous forest habitats. The virus is maintained over the winter by transovarial transmission in mosquito eggs. If the female mosquito is infected, she may lay eggs that carry the virus, and the adults coming from those eggs may be able to transmit the virus to chipmunks and to humans.

Historically, most cases of LAC encephalitis occur in the upper Midwestern states (Minnesota, Wisconsin, Iowa, Illinois, Indiana, and Ohio). Recently, more cases are being reported from states in the mid-Atlantic (West Virginia, Virginia and North Carolina) and southeastern (Alabama and Mississippi) regions of the country. It has long been suspected that LAC encephalitis has a broader distribution and a higher incidence in the eastern United States, but is under-reported because the etiologic agent is often not specifically identified.

LAC encephalitis initially presents as a nonspecific summertime illness with fever, headache, nausea, vomiting and lethargy. Severe disease occurs most commonly in children under the age of 16 and is characterized by seizures, coma, paralysis, and a variety of neurological sequelae after recovery. Death from LAC encephalitis occurs in less than 1% of clinical cases. In many clinical settings, pediatric cases presenting with CNS involvement are routinely screened for herpes or enteroviral etiologies. Since there is no specific treatment for LAC encephalitis, physicians often do not request the tests required to specifically identify LAC virus, and the cases are reported as aseptic meningitis or viral encephalitis of unknown etiology. Also found in the United States, Jamestown Canyon and Cache Valley viruses are related to LAC, but rarely cause encephalitis.

Eastern Equine Encephalitis

Eastern equine encephalitis (EEE) is also caused by a virus transmitted to humans and equines by the bite of an infected mosquito. EEE virus is an alphavirus that was first identified in the 1930's and currently occurs in focal locations along the eastern seaboard, the Gulf Coast and some inland Midwestern locations of the United States. While small outbreaks of human disease have occurred in the United States, equine epizootics can be a common occurrence during the summer and fall.

It takes from 4-10 days after the bite of an infected mosquito for an individual to develop symptoms of EEE. These symptoms begin with a sudden onset of fever, general muscle pains, and a headache of increasing severity. Many individuals will progress to more severe symptoms such as seizures and coma. Approximately one-third of all people with clinical encephalitis caused by EEE will die from the disease and of those who recover, many will suffer permanent brain damage with many of those requiring permanent institutional care.

In addition to humans, EEE virus can produce severe disease in: horses, some birds such as pheasants, quail, ostriches and emus, and even puppies. Because horses are outdoors and attract hordes of biting mosquitoes, they are at high risk of contracting EEE when the virus is present in mosquitoes. Human cases are usually preceded by those in horses and exceeded in numbers by horse cases which may be used as a surveillance tool.

EEE virus occurs in natural cycles involving birds and *Culiseta melanura*, in some swampy areas nearly every year during the warm months. Where the virus resides or how it survives in the winter is unknown. It may be introduced by migratory birds in the spring or it may remain dormant in some yet undiscovered part of its life cycle. With the onset of spring, the virus reappears in the birds (native bird species do not seem to be affected by the virus) and mosquitoes of the swamp. In this usual cycle of transmission, virus does not escape from these areas because the mosquito involved prefers to feed upon birds and does not usually bite humans or other mammals.

For reasons not fully understood, the virus may escape from enzootic foci in swamp areas in birds or bridge vectors such as *Coquilletidia perturbans* and *Aedes sollicitans*. These species feed on both birds and mammals and can transmit the virus to humans, horses, and other hosts. Other mosquito species such as *Ae. vexans* and *Culex nigripalpus* can also transmit EEE virus.

When health officials maintain surveillance for EEE virus activity, this movement out of the swamp can be detected, and if the level of activity is sufficiently high, can recommend and undertake measures to reduce the risk to humans.

Western Equine Encephalitis

The alphavirus western equine encephalitis (WEE) was first isolated in California in 1930 from the brain of a horse with encephalitis, and remains an important cause of encephalitis in horses and humans in North America, mainly in western parts of the USA and Canada. In the western United States, the enzootic cycle of WEE involves passerine birds, in which the infection is inapparent, and culicine mosquitoes, principally *Cx. tarsalis*, a species that is associated with irrigated agriculture and stream drainages. The virus has also been isolated from a variety of mammal species. Other important mosquito vector species include *Aedes melanimon* in California, *Ae. dorsalis* in Utah and New Mexico and *Ae. campestris* in New Mexico.

Expansion of irrigated agriculture in the North Platte River Valley during the past several decades has created habitats and conditions favorable for increases in populations of granivorous birds such as the house sparrow, *Passer domesticus*, and mosquitoes such as *Cx. tarsalis*, *Aedes dorsalis* and *Aedes melanimon*. All of these species may play a role in WEE virus transmission in irrigated areas. In addition to *Cx. tarsalis*, *Ae. dorsalis* and *Ae. melanimon*, WEE virus also has been isolated occasionally from some other mosquito species present in the area. Two confirmed and several suspect cases of WEE were reported from Wyoming in 1994. In 1995, two strains of WEE virus were isolated from *Culex tarsalis* and neutralizing antibody to WEE virus was demonstrated in sera from pheasants and house sparrows. During 1997, 35 strains of WEE virus were isolated from mosquitoes collected in Scotts Bluff County, Nebraska.

Human WEE cases are usually first seen in June or July. Most WEE infections are asymptomatic or present as mild, nonspecific illness. Patients with clinically apparent illness usually have a sudden onset with fever, headache, nausea, vomiting, anorexia and malaise, followed by altered mental status, weakness and signs of meningeal irritation. Children, especially those under 1 year old, are affected more severely than adults and may be left with permanent sequelae, which is seen in 5 to 30% of young patients. The mortality rate is about 3%.

St. Louis Encephalitis

In the United States, the leading cause of epidemic flaviviral encephalitis is St. Louis encephalitis (SLE) virus. SLE is the most common mosquito-transmitted human pathogen in the U.S. While periodic SLE epidemics have occurred only in the Midwest and southeast, SLE virus is distributed throughout the lower 48 states. Since 1964, there have been 4,437 confirmed cases of SLE with an average of 193 cases per year (range 4 - 1,967). However, less than 1% of SLE viral infections are clinically apparent and the vast majority of infections remain undiagnosed. Illness ranges in severity from a simple febrile headache to meningoencephalitis, with an overall case-fatality ratio of 5-15 %. The disease is generally milder in children than in adults, but in those children who do have disease, there is a high rate of encephalitis. The elderly are at highest risk for severe disease and death. During the summer season, SLE virus is maintained in a mosquito-bird-mosquito cycle, with periodic amplification by peridomestic birds and *Culex*

mosquitoes. In Florida, the principal vector is *Cx. nigripalpus*, in the Midwest, *Cx. pipiens pipiens* and *Cx. p. quinquefasciatus* and in the western United States, *Cx. tarsalis* and members of the *Cx. pipiens* complex.

Powassan Encephalitis

Powassan (POW) virus is a flavivirus and currently the only well documented tick-borne transmitted arbovirus occurring in the United States and Canada. Recently a Powassan-like virus was isolated from the deer tick, *Ixodes scapularis*. Its relationship to POW and its ability to cause human disease has not been fully elucidated. POW's range in the United States is primarily in the upper tier States. In addition to isolations from man, the virus has been recovered from ticks (*Ixodes marxi*, *I. cookei* and *Dermacentor andersoni*) and from the tissues of a skunk (*Spilogale putorius*). It is a rare cause of acute viral encephalitis. POW virus was first isolated from the brain of a 5-year-old child who died in Ontario in 1958. Patients who recover may have residual neurological problems.

Venezuelan Equine Encephalitis

Like EEE and WEE viruses, Venezuelan equine encephalitis (VEE) is an alphavirus and causes encephalitis in horses and humans and is an important veterinary and public health problem in Central and South America. Occasionally, large regional epizootics and epidemics can occur resulting in thousands of equine and human infections. Epizootic strains of VEE virus can infect and be transmitted by a large number of mosquito species. The natural reservoir host for the epizootic strains is not known. A large epizootic that began in South America in 1969 reached Texas in 1971. It was estimated that over 200,000 horses died in that outbreak, which was controlled by a massive equine vaccination program using an experimental live attenuated VEE vaccine. There were several thousand human infections. A more recent VEE epidemic occurred in the fall of 1995 in Venezuela and Colombia with an estimated 90,000 human infections. Infection of man with VEE virus is less severe than with EEE and WEE viruses, and fatalities are rare. Adults usually develop only an influenza-like illness, and overt encephalitis is usually confined to children. Effective VEE virus vaccines are available for equines.

Enzootic strains of VEE virus have a wide geographic distribution in the Americas. These viruses are maintained in cycles involving forest dwelling rodents and mosquito vectors, mainly *Culex (Melanoconion)* species. Occasional cases or small outbreaks of human disease are associated with these viruses, the most recent outbreaks were in Venezuela in 1992, Peru in 1994 and Mexico in 1995-96.

Other Arboviral Encephalitides

Many other arboviral encephalitides occur throughout the world. Most of these diseases are problems only for those individuals traveling to countries where the viruses are endemic.

Japanese Encephalitis

Japanese encephalitis (JE) virus is a flavivirus, related to SLE, and is widespread throughout Asia. Worldwide, it is the most important cause of arboviral encephalitis with over 45,000 cases reported annually. In recent years, JE virus has expanded its geographic distribution with outbreaks in the Pacific. Epidemics occur in late summer in temperate regions, but the infection is enzootic and occurs throughout the year in many tropical areas of Asia. The virus is maintained in a cycle involving culicine mosquitoes and waterbirds. The virus is transmitted to man by *Culex* mosquitoes, primarily *Cx. tritaeniorhynchus*, which breed in rice fields. Pigs are the main amplifying hosts of JE virus in peridomestic environments.

The incubation period of JE is 5 to 14 days. Onset of symptoms is usually sudden, with fever, headache and vomiting. The illness resolves in 5 to 7 days if there is no CNS involvement. The mortality in most outbreaks is less than 10%, but is higher in children and can exceed 30%. Neurologic sequelae in patients who recover are reported in up to 30% of cases. A formalin-inactivated vaccine prepared in mice is used widely in Japan, China, India, Korea, Taiwan and Thailand. This vaccine is currently available for human use in the United States, for individuals who might be traveling to endemic countries.

Tick-Borne Encephalitis

Tick-borne encephalitis (TBE) is caused by two closely related flaviviruses which are distinct biologically. The eastern subtype causes Russian spring-summer encephalitis (RSSE) and is transmitted by *Ixodes persulcatus*, whereas the western subtype is transmitted by *Ixodes ricinus* and causes Central European encephalitis (CEE). The name CEE is somewhat misleading, since the condition can occur throughout much of Europe. Of the two subtypes, RSSE is the more severe infection, having a mortality of up to 25% in some outbreaks, whereas mortality in CEE seldom exceeds 5%.

The incubation period is 7 to 14 days. Infection usually presents as a mild, influenza-type illness or as benign, aseptic meningitis, but may result in fatal meningoencephalitis. Fever is often biphasic, and there may be severe headache and neck rigidity, with transient paralysis of the limbs, shoulders or less commonly the respiratory musculature. A few patients are left with residual paralysis. Although the great majority of TBE infections follow exposure to ticks, infection has occurred through the ingestion of infected cows' or goats' milk. An inactivated TBE vaccine is currently available in Europe and Russia.

West Nile Encephalitis

Discussed elsewhere in this document

FLD 43 D HAZARDOUS PLANTS

A number of hazardous plants may be encountered during field operations. The ailments associated with these plants range from mild hay fever to contact dermatitis. Plants that present the greatest risk to site workers are those that produce allergic reactions and tissue injury.

Plants That Cause Skin and Tissue Injury

Contact with sharp leaves and thorns are of special concern to site personnel. This concern stems from the fact that punctures, cuts, and even minor scrapes caused by accidental contact may result in skin lesions and the introduction of fungi or bacteria through the skin. This is especially important in light of the fact that the warm moist environment created inside protective clothing is ideal for the propagation of fungal and bacterial infection. Personnel receiving any of the injuries listed above, even minor scrapes shall report immediately for continued observation and care. Keeping the skin covered as much as possible (i.e., long pants and long sleeved shirts) in areas where these plants are known to exist will limit much of the potential exposure.

Plants That Cause an Allergic Reaction

The poisonous plants of greatest concern are poison ivy, poison oak, and poison sumac. Contact with the poisonous sap of these plants produces a severe rash characterized by redness, blisters, swelling, and intense burning and itching. The victim also may develop a high fever and may be very ill. Ordinarily, the rash begins within a few hours after exposure, but it may be delayed for 24 to 48 hours.

The most distinctive features of poison ivy and poison oak are their leaves, which are composed of three leaflets each. In certain seasons, both plants also have greenish-white flowers and berries that grow in clusters. Poison sumac is a tall shrub or small tree with 6 to 12 leaflets arranged in pairs with a single leaflet at the end. This plant grows in wooded, swampy areas.

Poison Ivy/Poison Oak/Poison Sumac

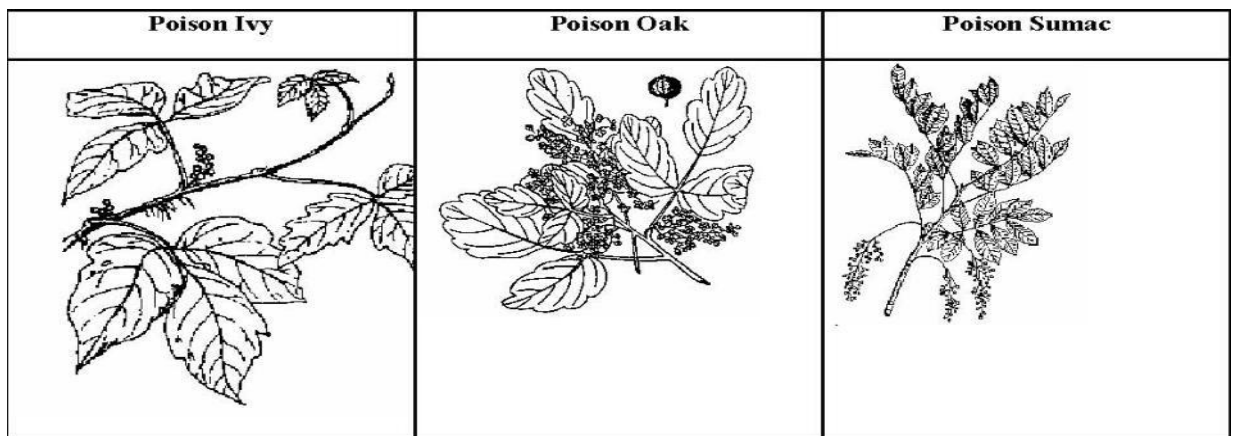

The reaction associated with exposure to these plants will generally cause the following signs and symptoms:

- Blistering at the site of contact, usually occurring within 12 to 48 hours after contact
- Reddening, swelling, itching and burning at the site of contact
- Pain, if the reaction is severe
- Conjunctivitis, asthma, and other allergic reactions if the person is extremely sensitive to the poisonous plant toxin

If the rash is scratched, secondary infections can occur. Preventive measures that are effective for most site personnel include:

- Avoid contact with any poisonous plants on site, and keep a steady watch to identify, report and mark poisonous plants found on site
- Wash hands, face or other exposed areas at the beginning of each break period and at the end of each workday
- Avoid contact with, and wash on a daily basis, contaminated tools, equipment and clothing
- Barrier creams, detoxification/wash solutions and orally administered desensitization may prove effective and should be tried to find the best preventive solution

Keeping the skin covered as much as possible (i.e., long pants and long sleeved shirts) in areas where these plants are known to exist will limit much of the potential exposure.

Plants That are Poisonous

There are a number of plants worldwide beside poison ivy, oak and sumac which have poisonous properties. In many cases consumption of these plants or parts of these plants can result in poisoning. In other cases, contact with the plants may be poisonous. The following is a listing with pertinent information on poisonous properties and locations of a number of plants.

In general, when working in the outdoors or where you may come in contact with household plants or where your families may come in contact with these plants, it is important that as soon as possible after contact the area or areas should be thoroughly washed and hands must be thoroughly washed before eating drinking, smoking or any other hand to mouth contact.

In keeping with our 24/7 BBS concept, it is important to remember that children are particularly vulnerable to many of the poisonous parts of these plants. Many of these poisonous parts resemble non-poisonous food items such as berries and are attractive.

As with most lists there is extensive information but the list may not include all poisonous plants.

It is important to remember that this document is a starting point to be supplemented with local information. The majority of this information is from a list found in Wikipedia an on line Dictionary readily accessible via Google. The website has pictures of these plants as well as links to other information sources.

POISONOUS PLANTS

From Wikipedia,

This is a list of plants containing poisonous parts that pose a serious risk of illness, injury, or death to humans.

Poisonous Food Plants

- Apple (*Malus domestica*) **Found worldwide in cooler climates.** Seeds contain cyanogenic glycosides; although the amount found in most apples won't kill a person.
- Cherry (*Prunus cerasus*), as well as other species (*Prunus spp*) such as peach (*Prunus persica*), plum (*Prunus domestica*), almond (*Prunus dulcis*) and apricot (*Prunus armeninaca*). **There are around 430 species of *Prunus*, spread throughout the northern temperate regions of the globe.** Leaves and seeds contain cyanogenic glycosides
- Rhubarb (*Rheum rhaponticum*) **Found worldwide.** Leaves, but not stems, contain oxalic acid salts, causing kidney disorders, convulsions, and coma. Rarely fatal.
- Tomato (*Solanum lycopersicum*) **Found worldwide.** Foliage and vines contain alkaloid poisons which cause digestive upset and nervous excitement.

Other Poisonous Plants

- Autumn crocus. **Found in North America.** The bulbs are poisonous and cause nausea, vomiting, diarrhea. **Can be fatal.**
- Azalea **Found Worldwide.** All parts of the plant are poisonous and cause nausea, vomiting, depression, breathing difficulties, and coma. Rarely fatal.
- Bittersweet nightshade **Naturalized in North America.** All parts are poisonous, containing solanine and causing fatigue, paralysis, convulsions and diarrhea. Rarely fatal.
- Bleeding heart / Dutchman's breeches. **Found in North America.** Leaves and roots are poisonous and cause convulsions and other nervous symptoms.
- Black locust. **Naturalized in North America.** Pods are toxic
- Caladium / Elephant ear. **Ornamental plants in North America.** All parts of the plant are poisonous. Symptoms are generally irritation, pain, and swelling of tissues. If the mouth or tongue swells, breathing may be fatally blocked.

- Castor Oil Plant (*Ricinus communis*) Castor Oil Plant. **Found Worldwide.** The phytotoxin is **ricin**, an extremely toxic water soluble protein, which is concentrated in the seed. Also present are ricinine, an alkaloid, and an irritant oil. Causes burning in mouth and throat, convulsions, and is **often fatal**.
- Daffodil. **Found worldwide.** The bulbs are poisonous and cause nausea, vomiting, and diarrhea. **Can be fatal.**
- Daphne (*Daphne sp.*) **Ornamental plant worldwide.** The berries (either red or yellow) are poisonous, causing burns to mouth and digestive tract, followed by coma. **Often fatal.**
- Darnel/Poison Ryegrass (*Lolium temulentum*) **Usually grows in the same production zones as wheat and is considered a weed.** The seeds and seed heads of this common garden weed may contain the alkaloids temuline and loline. Some experts also point to the fungus ergot or fungi of the genus endoconidium both of which grow on the seed heads of rye grasses as an additional source of toxicity.
- Deadly nightshade (*Atropa belladonna*) **Naturalized in parts of North America.** All parts of the plant contain the toxic alkaloid atropine. The young plants and seeds are especially poisonous, causing nausea, muscle twitches, paralysis; **often fatal.**
- Dumbcane / dieffenbachia. **Found in tropical areas and popular as house plants.** All parts are poisonous, causing intense burning, irritation, and immobility of the tongue, mouth, and throat. Swelling can be severe enough to block breathing leading to death.
- Ivy. **Native to North America** where winters are not severe. The leaves and berries are poisonous, causing stomach pains, labored breathing, possible coma.
- Jerusalem cherry **United States** All parts, especially the berries, are poisonous, causing nausea and vomiting. **Looks like a cherry tomato.** It is occasionally fatal, especially to children.
- Lilies **Worldwide** There are some 3500 species that comprise the lily (Lilaceae) family. Some are beneficial including (foods such as onion, shallot, garlic, chives [all *Allium* spp] and asparagus) and some with medicinal uses (colchicine and red squill) Many produce alkalids which are poisonous, especially to cats.
- Manchineel (*Hippomane mancinella*) **Native to the Caribbean (including Puerto Rico and the Virgin Islands).** It is one of the most poisonous trees in the world All parts of this tree including the fruit contain toxic phorbol esters typical of the Euphorbiacea. Sap may cause burning of the skin and smoke from burning may cause eye irritation and blindness. Fruits, which are similar in appearance to an apple, are green or greenish-yellow when ripe.
- Oak Worldwide Most species foliage and acorns are mildly poisonous, causing digestive upset, heart trouble, contact dermatitis. Rarely fatal.

- Poison-ivy (*Toxicodendron radicans*), Poison-oak (*T. diversilobum*), and Poison Sumac (*T. vernix*) **North America** All parts of these plants contain a highly irritating oil with urushiol (this is actually not a poison but an allergen). Skin reactions can include blisters and rashes. It spreads readily to clothes and back again, and has a very long life. Infections can follow scratching.
- Pokeweed (*Phytolacca sp.*) **Native to North America.** Leaves, berries and roots contain phytolaccatoxin and phytolaccigenin - toxin in young leaves is reduced with each boiling and draining.

FLD 49 SAFE STORAGE OF SAMPLES

REFERENCE

DOT Emergency Response Guide (ERG)

To ensure that multi-media samples collected in the course of WESTON work assignments are not stored in a manner that creates undue hazard to WESTON employees or others.

PROCEDURE

Samples that are transported from a WESTON work location must be classified and packaged in compliance with U.S. Department of Transportation (DOT) regulations or alternatively in accordance with International Air Transport Association (IATA) regulations. WESTON's manual of Procedures for Shipping and Transporting Dangerous Goods must be consulted to determine if the samples will be classified as either "environmental" or "hazardous materials" samples.

Environmental Samples

Environmental samples are not subject to DOT or IATA dangerous goods regulations and must be packaged to protect their integrity during transportation and temporary storage and should have appropriate chain-of-custody documentation. These samples may be brought to a WESTON office location or rented space to verify sample documentation and repackaging (e.g., with ice or cold packs). Minor spill clean-up capability is required.

Once secured for shipment, these samples can be temporarily stored for the next day ground or air shipment pick-up. Under no circumstances are samples to be stored beyond the time necessary to arrange for transportation to a laboratory.

Hazardous Materials Samples

These samples are subject to DOT and/or IATA dangerous goods regulations and must be packaged and labeled according to the appropriate regulations, including completed chain-of-custody documentation prior to being transported from the WESTON work site. WESTON drivers must have the documentation for the samples and a DOT Emergency Response Guide (ERG) readily available in the vehicle. The ERG is available on-line at: <http://hazmat.dot.gov/pubs/erg/gydebook.htm> and appropriate sections can be copied to accompany samples being transported by vehicles driven by WESTON employees.

Under normal circumstances these samples should be shipped from the field and never brought back to a WESTON office location or into a rented space. If it is not possible to ship the samples from the field during the same day they are collected, a properly packaged, labeled, and sealed sample shipping container may be brought back to a WESTON office location for shipment to a laboratory the next business day - provided the temporary storage location is secure from access by any personnel who are not trained in shipping hazardous materials. Under no circumstances are samples to be stored in rented space; if necessary, secure temporary storage in a locked vehicle may be authorized. Note that some office leases do not permit the storage of hazardous materials and the lease will govern whether such materials can be stored overnight.

INSPECTION FOLLOW-UP

Shipping procedures for samples should be included in the site-specific health and safety plan (HASP) and reviewed for compliance with these procedures prior to approval. EHS audits will include a review to sample shipping and storage procedures.

FLD 57 – MOTOR VEHICLE SAFETY

RELATED OP AND FLD

OP 11-01-017 – Motor Vehicle Safety

FLD 11 – Rough Terrain

This FLD applies to vehicles other than passenger vehicles that are operated when performing WESTON activities/operations. WESTON personnel safe driving requirements must be included in site-specific health and safety plans and accident prevention plans.

SAFE VEHICLE OPERATION

The vehicle operator is responsible for the vehicle, and for ensuring that the vehicle is in good working condition before use. WESTON employees must not operate a vehicle with any mechanical defect which endangers the safety of the driver, passengers, or the public. Before use, the vehicle operator must ensure that the vehicle is safe to operate and free from apparent damage that could result in failure while in use. The vehicle operator documents the inspection of the Equipment/Trucking Inspection Checklist available on the Weston EHS Portal.

Vehicle operators are responsible for observing the procedure established in *OP 11-01-017 Motor Vehicle Safety* and the following requirements:

- comply with all state and local traffic laws
- drive defensively
- comply with client requirements regarding motor vehicle operation
- use seat belts at all times when the vehicle is in motion
- ensure that all passengers are using seat belts at all times when the vehicle is in motion
- use caution when driving through congested areas, or near where personnel and equipment are working
- use a spotter for backing vehicles, if possible.

Vehicle operators must observe the following prohibited actions:

- DO NOT operate a motor vehicle under the influence of alcohol or drugs.
- DO NOT leave keys in an unattended vehicle.
- DO NOT leave the driver's seat of a vehicle while the motor is running.
- DO NOT operate a motor vehicle when abnormally tired.
- DO NOT drive beyond any barricades or into any area posted with designations, such as "NO TRESPASSING," "RESTRICTED AREA," or "DO NOT ENTER."
- DO NOT allow riders on the outside of a vehicle while it is in motion.

SAFETY DURING TRAVEL

- Know the traveling height (overhead clearance), width, length, and weight of the vehicle and know highway and bridge load, width and overhead limits, making sure these limits are not exceeded with an adequate margin.
- Never move a vehicle unless the vehicle brakes are in sound working order.
- Allow for any overhang when cornering or approaching other vehicles or structures.
- Be aware that the canopies of service stations and motels may be too low for a high-profile vehicle.
- Watch for low hanging electrical lines, particularly at the entrances to work sites, restaurants, motels, or other commercial sites.
- Remove all ignition keys when a drill rig is left unattended.
- For off-road travel, refer to FLD 11.

LOADING AND UNLOADING

The following guidelines should be followed, as applicable, when loading and unloading vehicles.

Tractors and/or trailers must be chocked during loading and unloading. Deck plates and positive anchor systems must be used for delivery to elevated platforms at trailer floor level if unloaded by fork lifts. Trailers detached from tractors must have additional support if fork lifts will enter or if instability of load presents a hazard of front wheels collapsing.

When loading or unloading a vehicle (such as a drill rig) or other “large” equipment on a trailer or a truck:

- Use ramps of adequate design that are solid and substantial enough to bear the weight of the vehicle or equipment with carrier - including tooling.
- Load and unload on level ground.
- Use the assistance of someone on the ground as a guide.
- Check the brakes on the vehicle or carrier before approaching loading ramps.
- Distribute the weight of the vehicle or carrier, and tools on the trailer so that the center of weight is approximately on the centerline of the trailer and so that some of the trailer load is transferred to the hitch of the pulling vehicle. Refer to the trailer manufacturer's weight distribution recommendations.

Secure the vehicle/equipment and tools to the hauling vehicle with ties, chains, and/or load binders of adequate capacity.

INSPECTION AND PRECAUTIONS

Tires

Vehicle tires must be checked daily for safety and during extended travel for loss of air, and maintained and/or repaired in a safe manner. If tires are deflated to reduce ground pressure for movement on soft ground, the tires must be reinflated to normal pressures before movement on firm or hilly ground or on streets, roads, and highways. Under-inflated tires are not as stable on firm ground as properly inflated

tires. Air pressures should be maintained for travel on streets, roads, and highways according to the manufacturer's recommendations. During tire checks, inspect for:

- Missing or loose wheel lugs.
- Objects wedged between duals or embedded in the tire casing.
- Damage to or poorly fitting rims or rim flanges.
- Abnormal or uneven wear and cuts, breaks, or tears in the casing.

The repair of truck and off-highway tires should only be made with required special tools and following the recommendations of a tire manufacturer's repair manual.

Batteries

Batteries contain strong acid. Use extreme caution when inspecting or charging batteries.

- Service batteries in a ventilated area while wearing safety glasses.
- When charging a battery with a battery charger, turn off the power source to the battery before either connecting or disconnecting charger loads to the battery posts. Cell caps should be loosened prior to charging to permit the escape of gas.
- Spilled battery acid can burn your skin and damage your eyes. Immediately flush spilled battery acid off of your skin with lots of water. Should battery acid get into someone's eyes, flush immediately with large amounts of water and see a medical physician at once.
- To avoid battery explosions, keep the cells filled with electrolyte, use a flashlight (not an open flame) to check electrolyte levels, and avoid creating sparks around the battery by shorting across a battery terminal. Keep lighted smoking materials and flames away from batteries.
- When a battery is removed from a vehicle or service unit, disconnect the battery ground clamp first.
- Secure batteries when transporting to prevent tip over.
- When installing a battery, connect the battery ground clamp last.

Fuel

Special precautions must be taken for handling fuel and refueling vehicles. Vehicles should not be fueled from open cans or by other makeshift methods, as there is great danger of flash fire from hot engines.

- Engines should be shut off while fueling.
- Only use the type and quality of fuel recommended by the engine manufacturer.
- Refuel in a well-ventilated area.
- Do not fill fuel tanks while the engine is running. Turn off all electrical switches.
- Do not spill fuel on hot surfaces. Clean any spillage before starting an engine.
- Wipe up spilled fuel with cotton rags or cloths - do not use wool or metallic cloth.
- Keep open lights, lighted smoking materials, and flames or sparking equipment well away from the fueling area.
- Turn off heaters in carrier cabs when refueling the carrier.

- Do not fill portable fuel containers completely full to allow expansion of the fuel during temperature changes.
- Keep the fuel nozzle in contact with the tank being filled to prevent static sparks from igniting the fuel.
- Do not transport portable fuel containers in the vehicle or carrier cab with personnel.
- Keep fuel containers and hoses in contact with a metal surface during travel to prevent the buildup of static charge.

Conversions: 1,000 μ R/hour = 1.0 mR/hour = 0.001 R/hour

1 Becquerel (Bq) = 1 disintegration per second (dps) = 2.7×10^{-11} curies (Ci)

1 Ci = 3.7×10^{10} Bq = 37 GBq

1 Sievert (Sv) = 100 rem

1 rem = .01 Sv

1 Gray (gy) = 100 radiation absorbed dose (rad) = approximately 100 roentgens (R) for gamma only

Human Radiation Dose = Roentgen Equivalent Man (rem)

Radiation Dose Rate = Roentgen per Hour (R/Hour)

Radioactivity (amount) = Curie

ALARA = As Low As Reasonably Achievable

Engineering Protection Factors: Time, Distance, and Shielding

Six Radiation Survey Objectives for radiation ERs:

Rad or No Rad

Determine External Exposure Rate (Micro or mR/hr)

Determine Type of Radiation (Alpha, beta, gamma)

Determine if Rad is airborne

Determine if Rad is loose or fixed

Identify gamma emitters

Weston Solutions, Inc., Region 1 START Radiation Dose/Dose Rate Limit Information For
Radiation-Related Responses (With Certified Health Physicist (CHP)/Radiation
Professional Oversight And Dosimetry)

Dose Limits (rem = Roentgen equivalent man)

Weston Administrative Dose Limit: 100 millirem/year (mrem/yr)
50 mrem/quarter

Weston/START Dose Limit (under specific conditions): 500 mrem/yr

EPA Administrative Dose Limit: 500 mrem/yr

EPA Emergency/NRC Radiation Worker Dose Limit: 5,000 mrem/yr and higher

Normal Background Levels

Background Gamma Dose Rate: 0.010-0.020 milliRoentgens/hour (mR/hr)

Background Alpha Count Rate (Ludlum 43-5): 0 to 1 count per minute (cpm)

Combined Background Dose Rate (alpha, beta, gamma): Approx. 60-80 cpm
(Ludlum Model 2241 W/Pancake Probe)

Exposure Limits (milliRoentgen/hour -mR/hour)

Weston/START Alert Level (rad source present) > 3X Background

Weston/START Call Back Gamma Dose Rate #1 0.3 mR/hr (300 μ R/hr)

Weston/START Call Back Gamma Dose Rate #2 1.0 mR/hr

Weston/START Turn Back Gamma Dose Rate 10.0 mR/hr

RADIATION SAFETY

THE APPROVAL SIGNATURES ARE KEPT ON FILE
WITH WESTON'S POLICIES AND PRACTICES

Document Number: OP 11-01-022
Type of Document: Operating Practice
Effective Date: 12/01/07
Revision Number: 03

Initiated by: R.P. Schoenfelder
Legal Review: D.B. Bauer
Approved by: O.B. Douglass

1.0 PURPOSE

It is the policy of Weston Solutions, Inc. (WESTON®) that all managers and employees will conduct radiological work activities in a manner that keeps radiation exposures as low as reasonably achievable (ALARA), and in compliance with the requirements of WESTON's source material licenses and applicable regulations as specified in Section 2.

WESTON and its subcontractors will take all reasonable precautions in planning and conducting work activities at sites actually or potentially contaminated with radioactive materials to minimize exposures to workers and the public, and to prevent the spread of contamination to the environment. WESTON will maintain this policy by implementing project designs, field engineering controls, administrative exposure limits, and work practices in accordance with guidance provided in this operating practice. WESTON may adopt as policy the recommendations of the International Commission of Radiological Protection (ICRP) and the National Council on Radiation Protection and Measurements (NCRP) to the extent that they are consistent with existing corporate policy and regulatory requirements. In addition, WESTON and its subcontractors shall conduct work activities in compliance with applicable Federal, state and local regulations.

This operating practice defines the WESTON radiation safety organization and the administrative health and safety responsibilities of project personnel.

It provides guidance for radiological projects from conceptual design through field implementation. It specifies criteria for complying with regulatory standards, and describes radiological protection program components, guidelines for storage and transportation of radioactive materials, and administrative limits applicable to radiological operations. It is intended to provide uniformity in WESTON's approach to field projects involving potential exposures to ionizing radiation.

2.0 STANDARDS AND REGULATIONS

WESTON and its subcontractors will comply with all applicable Federal, state, and local radiation safety regulations and requirements including, but not limited to, those established by the Occupational Safety and Health Administration (OSHA) and the U.S. Nuclear Regulatory Commission (NRC). Special attention should be given to the regulations listed below. Other requirements may apply at facilities owned or regulated by other Federal departments or state agencies.

- 29 CFR Part 1910, "Occupational Safety and Health Standards."

- 49 CFR Parts 172-174, “Transportation of Hazardous Materials.”
- 10 CFR Part 20, “Standards for Protection Against Radiation.”
- 10 CFR Part 835, Chapter 3 – Department of Energy “Occupational Radiation Protection.”

3.0 RADIATION EXPOSURE STANDARDS AND WESTON ADMINISTRATIVE LIMITS

To ensure compliance with applicable radiation exposure standards, WESTON institutes administrative limits for WESTON employees and subcontractors that are more restrictive than the regulatory limits provided in 29 CFR 1910.1096. These administrative limits are 100 millirem (mrem) per calendar year dose to the whole body from internal and external sources, and 10 percent of the applicable limits for inhalation and ingestion. The applicable limits for inhalation and ingestion will be taken from 10 CFR 20 Subpart C when no other regulatory limits apply. The administrative limits will not be exceeded without prior approvals in accordance with the following provisions:

- Exposures ranging from the administrative limit of 100 mrem per year up to 500 mrem per year and 30 percent of the 10 CFR 20 Appendix B, Table I limits may be approved by the Profit Center Manager or Project Manager only if affected employees have received site-specific training that describes the potential exposure levels and health risks associated with the project or emergency response action involving nuclear, biological and/or chemical materials, appropriate health physics monitoring is conducted under the supervision of a professional health physicist (with appropriate experience), and a task-specific ALARA program has been reviewed by a health physicist and implemented for the project.
- Planned exposures above 500 mrem per year, including emergency response operations that have the potential for exposures up to a maximum of 5000 mrem per year or 3000 mrem per calendar quarter (the maximum radiation dose allowed per 29 CFR 1910.1096), are permitted after a Project/Program-specific Radiation Safety Plan has been developed and reviewed by the Director, Corporate Environmental Health and Safety (CEHS) and/or the Corporate Radiation Safety Officer (CRSO). Weston employees or subcontractors shall not participate in work activities for any duration where the work exposures (dose equivalents) have the potential to exceed 3000 mrem per quarter or 5000 mrem in one year, not even on a voluntary basis for emergency response activities. A Project/Program-specific Radiation Safety Plan provides details as to personnel qualifications, instrumentation, monitoring protocols, personal protective equipment (PPE), respiratory protection, and radiation safety training requirements. It also identifies local/regional professional health physics resources that will directly supervise operations utilizing ALARA principles. Exposures that may approach 5000 mrem per year or high dose-rate environments (e.g., 100 mrem/hour or greater) must be conducted under the direction and guidance of a Certified Health Physicist (CHP), or similarly qualified professional health physicist, possessing relevant experience.
- Documented doses in excess of 100 mrem per year or 50 mrem per calendar quarter without the prior approvals described above must be reported immediately to the Director, CEHS and CRSO. **NOTE:** Exposures in excess of 5000 mrem per year or 3000 mrem per calendar quarter must be immediately reported to the Director, CEHS and CRSO, as well as the NRC or other responsible agency.

- The annual occupational dose limits for minors are 10 percent of the annual dose limits specified for adults. In addition, the dose to a woman who has declared herself to be pregnant must be less than 500 mrem during the entire gestation period. Work activities must not increase exposures to individuals in unrestricted areas above 100 mrem per year. These regulatory and administrative limits exclude exposures due to natural background and medical sources.

4.0 RADIATION SAFETY PROGRAM ORGANIZATION AND RESPONSIBILITIES

The Radiation Safety Program is administered by WESTON's CEHS Department. The corporate programs are implemented by the Division Managers. The Profit Center Managers and Project Managers implement specific programs and procedures associated with radioactive materials licenses and radiological projects. Individual responsibilities are described in the following subsections.

4.1 Director, Corporate Environmental Health and Safety and Quality Assurance

The Director, CEHS, has overall responsibility for establishing and managing the programs of the CEHS Department. The CEHS Director's duties in maintaining the Radiation Safety Program include the following:

- Revise this operating practice and radiation safety guidance documents when required to ensure compliance with regulatory changes.
- Develop and maintain supplemental guidance documents for WESTON's radiation safety programs.
- Inform the Division Managers of the Radiation Safety Program requirements, as necessary.
- Organize and manage a central recordkeeping file to maintain the personnel radiation dose records and other data required by this operating practice.
- Approve or deny requests for variances from the guidelines of this operating practice and requests to exceed administrative limits.
- Ensure that radiation safety training is provided to employees as needed, and in compliance with license requirements.

4.2 Division Manager

The Division Manager is ultimately responsible for implementing the policy and procedures associated with health and safety. The day-to-day management and implementation are normally delegated to the Profit Center Manager or Project Manager.

4.3 Profit Center Manager

The Profit Center Manager is responsible for approving requests and applications for radioactive material licenses and ensuring that radiation safety programs are established and maintained to ensure compliance with license conditions. Specific responsibilities include the following:

- Sign license applications to indicate the company's agreement to meet commitments described in the application.
- Ensure that license fees are paid in a timely manner.
- Ensure that radiation safety programs, source inventories, personnel monitoring, and inspections are conducted as required by licenses.
- Ensure that documentation and recordkeeping are completed as required by regulations and license requirements.

4.4 Project Manager

The Project Manager is responsible for establishing and maintaining radiation safety programs on projects that involve radiological hazards. Specific responsibilities include the following:

- Develop, approve, and implement a project-specific health and safety plan that describes detailed requirements for the project Radiation Safety Program.
- Ensure that professional health physics support is provided to the project during planning and field activities.
- Document the results of radiological measurements, contamination monitoring, and personnel dosimetry and place them into the permanent project files.
- Provide personnel dosimetry results to the Director, CEHS for inclusion in the corporate database.

4.5 WESTON Employees and WESTON Subcontractors

All employees of WESTON and WESTON subcontractors who work on radiological projects have health and safety responsibilities that include the following:

- Read and become familiar with health and safety plans for projects in which they are involved.
- Abide by applicable radiation safety policies and procedures, and state and Federal regulations.
- Help ensure that their radiation doses and doses received by their co-workers are as low as reasonably achievable.
- Report all unsafe radiological conditions to the Site Manager and suggest improvement in operations to minimize exposures of personnel.

5.0 GENERAL REQUIREMENTS

The Director, CEHS maintains guidance documents that provide specific radiation safety program requirements. General guidance for addressing radioactive materials licenses, acquiring radioactive sources, and responding to radiological incidents is provided in the following subsections.

5.1 Licensing, Permitting, and Legal Correspondence

All correspondence that addresses licensing, permitting, or other legal or regulatory matters will be generated and signed by the Profit Center Manager whose operations require the license and are affected by the regulations. The Profit Center Manager is responsible for ensuring that adequate resources are provided to maintain radiation safety programs that will ensure compliance with license requirements. A co-signature of the appropriate Division Manager may also be required where certain commitments of corporate funds or policy are expressed. Copies of radioactive material licenses and related correspondence must be provided to the CEHS Director for maintenance in corporate files.

5.2 Purchasing

All purchases of regulated radioactive materials must have the approval of the Profit Center Manager whose operations require the materials. The Profit Center Manager is responsible for ensuring that licenses are acquired and maintained as necessary to allow possession and use of radioactive materials, or that proper precautions are in place for using radioactive materials that may be acquired without a license.

5.3 Incident Records and Notification Procedure

Radiological incidents will be handled as specified in the emergency procedures section of the project health and safety plan. The Project Manager will follow corporate accident/injury reporting requirements as specified by the CEHS and Risk Management Departments. Additional notification and reporting requirements will be followed as required by Federal, state, or local regulations.

5.4 Transportation, Storage, and Disposal of Radioactive Materials

WESTON and its subcontractors will comply with applicable Federal and state regulations regarding transportation of radioactive contaminated materials. Prior to transport of such materials, the radionuclides and activities involved will be estimated to determine the appropriate procedures and precautions to be followed. Persons shipping or transporting radioactive materials are responsible for ensuring that regulations are met and must comply with Corporate dangerous goods shipping procedures. For more detailed guidance, project-specific requirements will be developed and provided in the health and safety plan.

Radioactive materials will be stored in a manner to maintain exposures to personnel ALARA and to prevent the spread of contamination. Radioactive materials will be disposed in compliance with license requirements and applicable regulations.

5.5 Emergency Response

Emergency response procedures will be developed as part of the site-specific health and safety plans to address the radiological aspects of potential accidents, spills, and contaminating events. Procedures will emphasize the importance of containing radioactive materials on the site, and will designate an individual to oversee cleanup activities and conduct contamination surveys in case of a contaminating event. Emergency response agencies will be informed of the radiological hazards that exist at the project site. Guidelines for emergency response will include notification of appropriate regulatory agencies and radiation safety personnel.

6.0 IMPLEMENTATION

The Director, CEHS, or his/her designee, is responsible for interpreting this operating practice.

ATTACHMENT C
COVID-19 Protocols

WESTON SOLUTIONS, INC., START V

**CORONAVIRUS/COVID-19 SAFETY INFORMATION AND BEST
PRACTICES**

Introduction and Content

Coronavirus/COVID-19 as a personal health issue (PHI) has the potential to impact our employees and their ability to perform their jobs and/or expose others to Coronavirus/COVID-19. In light of the global pandemic, WESTON is implementing additional procedures and safety measures that must be implemented on project sites until further notice. This Attachment includes the following items that require implementation:

1. COVID-19 Best Practice Safety Procedures for WESTON Field Personnel and Subcontractors
 - a. Identifies common safety measures to serve as best practices for WESTON operations and should be included as discussion items in daily tailgate/toolbox meetings.
2. Quick Tips for the Use of Cloth Face Coverings to Help Slow the Spread of COVID-19
3. Workspace/Office/Trailer Cleaning and Disinfection Recommendations
4. Informational flyers that may be posted/displayed onsite and should be discussed during daily tailgate/toolbox meetings.
 - a. [Employee Guidance Regarding COVID-19](#)
 - b. [CDC Poster: Signs and symptoms that you are sick](#)
 - c. [CDC Poster: Stop the Spread of Germs](#)
 - d. [CDC Poster: Wash your Hands](#)
 - e. [CDC Poster: Use of Cloth Face Coverings to Help Slow the Spread of COVID-19](#)

The Coronavirus situation is very dynamic, and WESTON's protocols and as well as government directives may change during the project. As a result, frequent communication with the project team is imperative during the pandemic, especially if conditions change.

Please carefully read through all of the materials included in this attachment.

COVID-19 Best Practice Safety Procedures for WESTON Field Personnel and Subcontractors

WESTON places the safety and security of our employees and related stakeholders as the highest priority. As such, Weston has developed COVID-19 Best Practice Safety Procedures to be implemented during field activities and review of these practices will be included in your daily tailgate/toolbox safety meeting. Employees will follow the guidance from the Project/Site Manager, Site Safety Officer, and relevant government entities regarding prevention of contracting the Coronavirus. Coronavirus instructions and protocols will work in tandem with WESTON's normal health and safety policies, practices, and project safety plans.

WESTON and subcontractor personnel are encouraged to follow current [CDC guidance](#) and updates regarding the COVID-19 outbreak. Post CDC posters included in this attachment at your jobsite as appropriate, and review with site personnel and field teams, regarding signs, symptoms, and controls. These materials can be found [here](#) on the WESTON Portal. Below is a list of best practices for WESTON operations:

Stay Home When Sick

- Sick is sick – do not report to work if you are experiencing any symptoms of illness. Contact your supervisor and healthcare provider for further direction and seek medical attention if advised.
- On a project-specific basis/at the request of the client, temperature checks may be initiated at the beginning of each workday for all team members including subcontractors. If implementing temperature checks, follow the WESTON guidance on Employee Health Symptoms Surveys/Employee Temperature Checks.

Personal Hygiene

- Follow all CDC guidance regarding personal hygiene and handwashing. Wash hands thoroughly with soap and clean water (preferably hot) for at least 20 seconds before eating, drinking, or smoking, and during and after work. Wash hands after touching any surfaces or objects.
- Avoid hand to face contact, including touching eyes, nose, and mouth.
- Wear gloves, as practical, to minimize hand/skin contact with objects/surfaces. Wash hands when gloves are removed.
- If soap and water are not readily available, use an alcohol-based hand sanitizer with at least 60% alcohol. Always wash hands with soap and water if hands are visibly dirty.

Site Sanitation

- Ensure that your project site has permanent/temporary bathroom and handwashing facilities in accordance with the Sanitation standards found in 29 CFR 1910 and 29 CFR 1926.
- Employees should have facilities in which they can wash their hands with potable water and an appropriate cleansing agent. Facilities must be maintained through regular cleaning and trash removal, and should be stocked with enough soap, paper towels, and toilet paper.
- Your project HASP or APP should address site sanitation and personal hygiene. The EHS Team will review and revise the existing HASP template to ensure HASP preparers are prompted to include information regarding site sanitation.

- Clean and disinfect frequently touched objects and surfaces using a regular household cleaning spray or wipe.

Social Distancing

- Practice social distancing in accordance with CDC guidelines by maintaining a 6 ft. distance between team members while performing work tasks.
- Practice social distancing when in office space, trailers, and break areas, as well as during morning meetings/toolbox talks (conduct group meetings outdoors, in open space) and while driving (1 person per vehicle unless approved by EHS Manager).
- Drive to project sites rather than flying, if feasible – coordinate with PM/RCO if this would result in additional costs requiring approval
- It may be necessary to change how work is executed, to maintain social distancing when operating equipment or performing site specific tasks.

Consult the [Coronavirus Information page](#) on the WESTON Portal for more information.

For all Weston Site-Specific HASPs please reference the following COVID-19 guidance documents:

- 1.) COVID-19 Scenarios and Actions updated 2020-04-17
- 2.) Employee Temperature Check 2020-06-02
- 3.) Required Use of Face Coverings

If you have any questions or concerns, reach out to your EHS Manager.

COVID-19 Scenarios and Actions

Weston strives to maintain safe working conditions for all employees (EE), subcontractors and other stakeholders. We have a combined responsibility to value and protect the health of each other when making decisions on reporting to work. Abiding by CDC recommendations, we can achieve the best possible health and safety outcomes for our work force.

If ill, regardless of symptoms (cough, cold, shortness of breath, fever, runny nose, vomiting, diarrhea, body aches), we will abide by the sick-is-sick policy to stay home, notify your supervisor and contact your health care professional (HCP) for direction. If diagnosed with an illness other than COVID-19 return to work when released by HCP and symptom free for 24-hours without medication. Remember during this time of required social distancing, working from home (WFH) is the Weston standard. This minimizes spread of any illness!

The matrix below is intended to guide managers in helping employees make good decisions if they experience a COVID-19 event in their personal or business life. Please contact Coronavirus.Inquiries@westonsolutions.com (CV) if additional guidance is needed.

Scenario	(EE) Actions	EE Direct Contact(s) Actions	Supervisor Actions	PM Actions	Office/Trailer Actions
1. EE is COVID-19 compromised (1)	<ul style="list-style-type: none"> Stay home Call supervisor Contact HCP Isolate at home for a minimum of 7 days and until symptom-free without medication for 72 hours 	If no symptoms of illness. <ul style="list-style-type: none"> Daily temperature check AM and PM Wear face mask always beginning 14 days from last exposure Social distance; WFH when possible Frequently clean/disinfect workspace 	<ul style="list-style-type: none"> Notify CV hotline Work with employee to identify direct contacts 	<ul style="list-style-type: none"> Notify client/project teams, as needed 	<ul style="list-style-type: none"> Sanitize/disinfect space
2. EE family member or other direct contact with COVID-19 compromised (1)	If no symptoms of illness: <ul style="list-style-type: none"> Daily temperature check AM and PM Wear face mask always beginning 14 days from last exposure Social distance; WFH when possible Frequently clean/disinfect workspace 	<ul style="list-style-type: none"> Isolation is recommended but not required Social distance; WFH when possible Monitor for symptoms 	<ul style="list-style-type: none"> Notify CV hotline Work with employee to understand details of event 	<ul style="list-style-type: none"> No Action 	<ul style="list-style-type: none"> No Action
3. Subcontractor reports their onsite EE is COVID-19 compromised (1)	No action unless a primary contact (see Scenario 2)		<ul style="list-style-type: none"> Sick-is-sick – remove EE from site Notify CV hotline Notify subcontractor management Stop work to gather information Initiate subcontractor COVID-19 plan 	<ul style="list-style-type: none"> In coordination with CV Task Force, collect details of event and keep client updated with current information Coordinate with Weston EHS to determine resumption of work 	<ul style="list-style-type: none"> As needed

(1) COVID-19 Compromised:

- a. COVID-19 positive test – CDC laboratory confirmed COVID positive test.
- b. COVID-19 positive – Tested positive for COVID through a local/state agency or other medical establishment.
- c. COVID-19 Diagnosis by HCP – HCP determines COVID-19 diagnosis using testing to rule out more common sicknesses.
- d. COVID Symptomatic – Employee has symptoms of COVID (primary symptoms, fever, cough, shortness of breath). Contacts HCP who diagnoses COVID-19.

Vaughn, Gina

From: Weston Reporter
Sent: Tuesday, June 02, 2020 3:11 PM
Subject: Employee Temperature Monitoring



As states begin to ease restrictions and re-open many of their businesses, temperature checks are fast becoming the new normal. After reviewing many of the state specific guidelines, Weston is implementing a standard approach to employee self-monitoring of temperatures before entering project sites or offices to ensure the continued health and welfare of all employees, subcontractors and clients.

Effective immediately, employees are expected to self-monitor body temperatures as follows:

- Take your temperature before traveling to any Weston project site or office. If your temperature reading is above 100.4 F, follow Weston's [COVID-19 Scenarios and Actions](#) chart to determine required actions.
- Documentation of temperature tracking is recommended but not required. **Note:** *Weston will soon be rolling out a mobile phone application to document daily information including elevated temperature and contacts with impacted individuals. This data will help in making decisions to assure a healthy workplace.*
- If documenting information, it should be kept confidential and will not be collected by any Weston representative unless required by our client, work site, or office rules.
- Thermometers will not be provided by Weston. You may use your personal home thermometer or procure one of your choice. The home office stipend provided through July can assist in covering this expense.
- Sick is sick. If your temperature reading is normal but you are exhibiting other symptoms of illness, **STAY HOME.**

As a reminder, this protocol is specifically for individuals who choose to work in an office, client location or Weston project site. You are not required to monitor body temperature if you work from home. It is in everyone's best interest to be proactive in making your best decisions to protect the health of our co-workers, clients and families during this time.

If you have any questions regarding this or other COVID-19 guidance, talk to your EHS Manager or send your question to the COVID hotline at Coronavirus.Inquiries@westonsolutions.com.

Vaughn, Gina

From: Weston Reporter
Sent: Tuesday, April 07, 2020 4:24 PM
Subject: Required Use of Cloth Face Coverings to Prevent the Spread of Coronavirus/COVID-19 in Weston Workspaces



To manage the transmission of the Coronavirus/COVID-19 from those who may be contagious, **Weston is requiring the use of cloth face coverings in accordance with [CDC recommendations](#) in public spaces (offices and project sites), common work spaces, common areas, locations where unplanned/uncontrolled contact may occur, and locations where safe work distancing is not possible.**

Disposable masks, cloth masks or ones made from available material such as a bandana would be the minimum required. Good hygiene (hand washing) and social distancing will be stringently practiced as the primary defense and the cloth mask is a secondary control.

How to properly wear a cloth face covering can be viewed on the CDC site [Use of Cloth Face Coverings to Help Slow the Spread of COVID-19](#).

This requirement includes Weston employees and subcontractors (including lower tier subcontractors) to support the effort to meet state directives, client requirements, and [CDC recommendations](#). Project/Program managers should communicate this directly to their subcontractors as part of new guidelines established by the CDC and added into the execution of their services.

Quick Tips for Face Coverings Related to COVID-19

[As per CDC, face coverings limit community Coronavirus transmission](#) by reducing [respiratory droplets and aerosols generated by the wearer into ambient air](#). Face coverings are not meant to protect the wearer. Cloth face coverings or surgical style masks do not meet the OSHA definition of air purifying respirators (e.g. N95). Regarding COVID-19, N95 masks are only to be used by health care professionals, emergency responders, and others who work directly with infectious individuals.

- **Face coverings in the field:**

- Paper surgical/disposable face masks
 - Can be ordered from RES
- When required?
 - DOD property, installations, and facilities
 - Weston project sites where 6 feet of social distancing cannot be maintained
 - Weston employees and contractors/subcontractors (contractors/subcontractors must supply own)
- Wash hands before donning, before doffing, and after doffing
- Dispose of on-site (or with investigation derived waste) after use
- Do not leave the site with a used mask

- **Face coverings in the office:**

- Cloth face covering
 - Fashioned from household items or made at home from common materials
 - [CDC Do-It Yourself-cloth-face-coverings](#)
- When required:
 - When 6 feet of social distancing cannot be maintained
- Wash hands before donning, before doffing, and after doffing
- Wash as needed, and with the frequency that you would wash any personal item

Remember, your cloth face covering contains your OWN germs more than anyone else's

- **General best practices for everyone (summary):**

- Sick is sick – do not report to work if you are experiencing any symptoms of illness
- Wash hands thoroughly before eating, drinking, smoking, and after touching any surfaces or objects
 - If soap and water are not available, use an alcohol-based hand sanitizer
- Avoid hand to face contact. Wear gloves, as practical, to minimize hand/skin contact with objects/surfaces. Wash hands when gloves are removed
- Practice social distancing by maintaining a 6 ft. distance
- Clean and disinfect frequently touched objects and surfaces using a regular household cleaning spray or wipe
- Consult the [Coronavirus Information page](#) on the WESTON Portal and the EHS [Coronavirus Page](#) on the CEHS SharePoint site, or the [CDC Coronavirus Webpage](#) for more information

Workspace/Office/Trailer/Environmental Cleaning and Disinfection Recommendations:

Rooms or areas with suspected or confirmed COVID - 19

<https://www.cdc.gov/coronavirus/2019-ncov/community/organizations/cleaning-disinfection.html>

1.0 BACKGROUND/SUPPORTING INFORMATION

Based on what is currently known about the [novel coronavirus 2019](#) (COVID-19), spread from person-to-person happens most frequently among close contacts (within about 6 feet, for periods > 10 mins.):

1. The primary route of exposure and transmission occurs via respiratory spray/droplets.
2. This procedure is for cleaning areas where there is no active transmission of Coronavirus/COVID-19.
3. There is some evidence that a person may get COVID-19 by touching a surface or object that has the virus on it and then touching their own mouth, nose, or their eyes, but this is not thought to be the main route of transmission. Good hygiene practices are the primary control and preventative measure to avoid transmission through this route.
4. Cleaning of visibly dirty surfaces followed by disinfection is a best practice for prevention of COVID-19 and other viral respiratory illnesses in community settings.

2.0 PURPOSE

This guidance provides recommendations for cleaning and disinfection of rooms or areas where an individual suspected or with confirmed COVID-19 may have worked.

These guidelines are focused on spaces that are not continuously occupied for overnight stays. These guidelines do not address healthcare facilities.

2.1 DEFINITIONS

1. **Community facilities** – (e.g., schools, daycares centers, businesses) most non-healthcare settings that are visited by the general public outside of a household.
2. **Cleaning** - removal of dirt and impurities, including germs, from surfaces. Cleaning alone does not kill germs. But by removing the germs, it decreases their number and therefore minimizing risk of spreading infection.

3. **Disinfecting** - using chemicals to kill germs on surfaces. This process does not necessarily clean dirty surfaces or remove germs. Killing germs that remain on a surface after cleaning further reduces any risk of spreading infection.

3.0 CLEANING AND DISINFECTION AFTER PERSONS SUSPECTED/CONFIRMED TO HAVE COVID-19 HAVE BEEN IN THE FACILITY

3.1 TIMING AND LOCATION OF CLEANING AND DISINFECTION OF SURFACES

At offices or other facilities that do not house people overnight:

1. Close off areas used by the ill persons and wait as long as practical before beginning cleaning and disinfection to minimize potential for exposure to respiratory droplets.
2. Open external doors and/or windows if present.
3. Spray the room with a sanitizing disinfecting aerosol spray (e.g., Lysol, Odo-Ban, Micro-Ban, etc.) as directed by manufacturer label on container. If possible, wait up to 24 hours before beginning surface cleaning and disinfection.
4. In areas outside the space to be cleaned, open outside doors and windows to increase air circulation in the area.
5. Cleaning staff should clean and disinfect all areas (e.g., offices, bathrooms, and common areas) used by the ill persons, focusing especially on frequently touched surfaces (e.g. doorknobs, light switches, door handles, workspace surfaces, etc.)

3.2 HOW TO CLEAN AND DISINFECT

3.2.1 SURFACES

1. Maintain good housekeeping daily:
 - a. Dispose of all items that can't be wiped down such as: Newspapers, magazines, etc.
2. Identify the cleaning solutions to be used (e.g. bleach, alcohol, [EPA approved sanitizing agent](#))
3. Obtain the Safety Data Sheet (SDS) for the cleaning/disinfecting product that will be used and review the personal protective equipment (PPE) section to

that will specify eye protection, glove type (e.g. rubber, nitrile, butyl, etc.), and aprons/coveralls specified by the manufacture.

4. Gloves are to be used when cleaning. Gloves are to be discarded after each cleaning. If reusable gloves are used, those gloves should be cleaned after each use and dedicated for cleaning and disinfection of surfaces for COVID-19 and are not be used for other purposes.
5. When identifying surface to wipe focus on those with frequent contact:
 - a. Doorknobs and handles
 - b. Side and edges of door
 - c. Light switches and pulls
 - d. Refrigerator surfaces and doors
 - e. Desk/filing cabinet tops/drawers
 - f. Tools and utensils used in cooking/eating (e.g. microwave, coffee maker, etc.)
 - g. Clipboards
 - h. Office tools; stapler, tape dispenser, etc.
6. Bag and dispose of personal use items that have been touched or sneezed/cough on such as:
 - a. Pens/Pencils
 - b. Disposable plates, cups, utensils, napkins, paper towels, etc.
 - c. Desktop items, e.g. paper clips, paper surfaces that can be disposed
 - d. Newspapers, magazines, etc.
7. Dirty surfaces prior to disinfection are to be:
 - a. First, cleaned using a detergent or soap and water (detergent/soap and water mixture ratio as per manufacturers' labels) wash.
 - b. Second, a clean water rinse.
8. For disinfection use:
 - a. diluted household bleach solutions:
 - i. diluted household bleach solutions (see bullet #9 below) are to be used as per manufacturer's instructions. If the label does not provide guidance how to use as a disinfecting agent do not use that product.

- ii. May only be used in a space that can be ventilated (e.g. open doors, windows, fan that circulates air from an external source, etc.)
 - b. Alcohol solutions with at least 70% alcohol, or
 - c. [Listed EPA-registered](#) household disinfectants.
 - i. Follow the manufacturer's instructions for all cleaning and disinfection products
(e.g., concentration, application method and contact time, etc.).
9. How to prepare a bleach solution:
- a. Never mix household bleach with ammonia or any other cleanser.
 - b. Mix 5 tablespoons (1/3rd cup) bleach per gallon of water or
 - c. 4 teaspoons bleach per quart of water
10. For soft (porous) surfaces such as carpeted floor, rugs, and drapes, remove visible contamination/dirt (use of a standard dry vacuum is not recommended, any vacuum used is to have an inline HEPA filter). Preferred method would be to wet scrape, wet wipe, or any other method that does not generate dust.
- a. Use cleaners indicated (see manufactures approved cleaners) for use on these surfaces. After cleaning of solid material:
 - i. If the items can be laundered, launder items in accordance with the manufacturer's instructions using the warmest appropriate water setting for the items and then dry items completely or
Use [EPA-approved](#) products for viral pathogens that are suitable for porous surfaces

322 LINENS, CLOTHING, AND OTHER ITEMS THAT GO IN THE LAUNDRY

1. Do not shake dirty laundry; this minimize the possibility of dispersing virus through the air.
2. Wash items as in accordance with the manufacturer's instructions.
3. Uses the hottest/warmest water possible and use detergent as per manufacturer's directions.
4. Clean and disinfect hampers or other carts for transporting laundry according to guidance above for hard or soft surfaces.

3.3 PERSONAL PROTECTIVE EQUIPMENT (PPE) AND HAND HYGIENE:

1. Cleaning staff should wear safety glasses, disposable gloves, aprons, coveralls, and/or gowns (dermal PPE) for all tasks in the cleaning process, including handling trash.
 - a. Dermal PPE shall be compatible with the disinfectant products being used.
 - b. Additional PPE might be required based on the cleaning/disinfectant products being used and whether there is a risk of splash. Reference SDS. At a minimum, ANSI- approved safety glasses are required.
 - c. Dermal PPE is to be removed so the external/outer sides do not come in contact with the wearers skin or other surfaces (e.g. when taking off roll inside out)
 - d. Final step will be wash and sanitize **hands** after removing gloves.
2. Cleaning staff should immediately report breaches in PPE (e.g., tear in gloves) or any potential exposures to their supervisor.
3. Cleaning staff and others should clean hands often, including immediately after removing gloves by washing hands with soap and water for 20 seconds. If soap and water are not available and hands are not visibly dirty, an alcohol-based hand sanitizer that contains 60%-95% alcohol may be used.
4. Follow normal preventive actions while at work and home, including cleaning hands and avoiding touching eyes, nose, or mouth with unwashed hands

Onsite Informational Posting

In light of the global pandemic, there will onsite informational postings at jobsites that address COVID exposure and control which will be discussed during the initial site safety meeting and in daily toolbox meetings. This discussion shall direct employees to the location where this information will be posted and include a review of the following as it pertains to scope of work and job task:

- 1) All COVID-19 postings that are maintained onsite provide guidance regarding:
 - a. [Employee Guidance Regarding COVID-19](#)
 - b. [CDC Poster: Signs and symptoms that you are sick](#)
 - c. [CDC Poster: Stop the Spread of Germs](#)
 - d. [CDC Poster: Wash your Hands](#)
 - e. [CDC Poster: Use of Cloth Face Coverings to Help Slow the Spread of COVID-19](#)

These documents are included at the end of this attachment and should be posted at the project site, if feasible.

We rely on individuals to self-monitor, practice social responsibility, and adhere to government guidance and directives to protect themselves and those working around them.

EMPLOYEE GUIDANCE FOR AN IMMEDIATE RESPONSE TO CORONAVIRUS CONCERNS, 03/13/2020

Due to a number of questions from employees regarding coronavirus (COVID-19) and their work, the WESTON Coronavirus Task Force has set up a Steering Committee to provide the following guidelines and to answer any questions from managers responsible for ensuring compliance with the guidelines and other WESTON Health & Safety protocols.

STEERING COMMITTEE

Herold Hannah, Office Phone: 610-701-3024, Mobile Phone: 412-303-1199

Joe Hockenberry, Office Phone: 610-701-3692, Mobile Phone: 484-288-9793

Larry Bove, Office Phone: 610-701-3020. Mobile Phone: 610-999-3031

GENERAL INSTRUCTIONS

Employees who have had direct exposure to someone diagnosed with coronavirus OR who are feeling sick and have any of the symptoms of coronavirus should self-quarantine at home and notify their manager. The manager will notify one of the members of the Coronavirus Steering Committee in order to maintain a complete and accurate record of where and how the coronavirus is affecting our employees and operations.

Those employees who self-quarantine at home will be interviewed and evaluated by a member of the Health and Safety team regarding symptoms, contacts with coronavirus diagnosed individuals, and contacts with other Weston employees, clients, subcontractors, vendors and the public.

The Steering Committee will make a decision about the requirements for the individual and office or work site team members, based on the EHS evaluation, CDC guidelines, local community rules, and pertinent personal and business risks. The manager will coordinate with the employee on any work-related issues.

OTHER INFORMATION SOURCES

- ✓ Centers for Disease Control: <https://www.cdc.gov/coronavirus/2019-nCoV/index.html>
- ✓ The Mayo Clinic: <https://www.mayoclinic.org/diseases-conditions/coronavirus/symptoms-causes>
- ✓ Your city, county and state public health departments

This page is left intentionally blank

Patients with COVID-19 have experienced mild to severe respiratory illness.

Symptoms* can include

FEVER



COUGH



*Symptoms may appear 2-14 days after exposure.

Seek medical advice if you develop symptoms, and have been in close contact with a person known to have COVID-19 or if you live in or have recently been in an area with ongoing spread of COVID-19.

SHORTNESS OF BREATH



For more information: www.cdc.gov/COVID19-symptoms

STOP THE SPREAD OF GERMS

Help prevent the spread of respiratory diseases like **COVID-19**.

Avoid close contact with people who are sick.



Cover your cough or sneeze with a tissue, then throw the tissue in the trash.



Avoid touching your eyes, nose, and mouth.

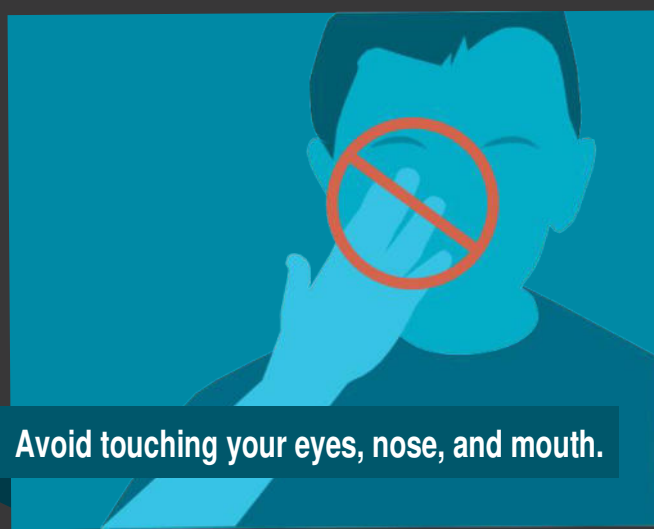

Clean and disinfect frequently touched objects and surfaces.



Stay home when you are sick, except to get medical care.



Wash your hands often with soap and water for at least 20 seconds.



For more information: www.cdc.gov/COVID19



Hands that look clean can still have icky germs!



Y>UR



U.S. Department of Health and Human Services
Centers for Disease Control and Prevention

Use of Cloth Face Coverings to Help Slow the Spread of COVID-19

How to Wear Cloth Face Coverings

Cloth face coverings should—

- fit snugly but comfortably against the side of the face
- be secured with ties or ear loops
- include multiple layers of fabric
- allow for breathing without restriction
- be able to be laundered and machine dried without damage or change to shape

CDC on Homemade Cloth Face Coverings

CDC recommends wearing cloth face coverings in public settings where other social distancing measures are difficult to maintain (e.g., grocery stores and pharmacies), **especially** in areas of significant community-based transmission.

CDC also advises the use of simple cloth face coverings to slow the spread of the virus and help people who may have the virus and do not know it from transmitting it to others. Cloth face coverings fashioned from household items or made at home from common materials at low cost can be used as an additional, voluntary public health measure.

Cloth face coverings should not be placed on young children under age 2, anyone who has trouble breathing, or is unconscious, incapacitated or otherwise unable to remove the cloth face covering without assistance.

The cloth face coverings recommended are not surgical masks or N-95 respirators. Those are critical supplies that must continue to be reserved for healthcare workers and other medical first responders, as recommended by current CDC guidance.

Should cloth face coverings be washed or otherwise cleaned regularly? How regularly?

Yes. They should be routinely washed depending on the frequency of use.

How does one safely sterilize/clean a cloth face covering?

A washing machine should suffice in properly washing a cloth face covering.

How does one safely remove a used cloth face covering?

Individuals should be careful not to touch their eyes, nose, and mouth when removing their cloth face covering and wash hands immediately after removing.

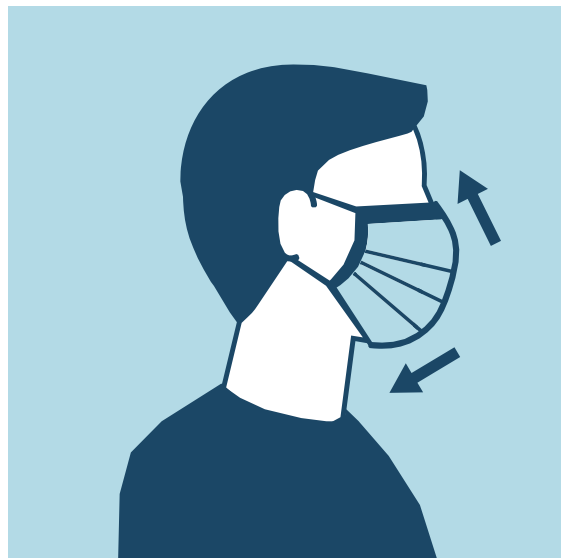

Sewn Cloth Face Covering

Materials

- Two 10"x6" rectangles of cotton fabric
- Two 6" pieces of elastic (or rubber bands, string, cloth strips, or hairties)
- Needle and thread (or bobby pin)
- Scissors
- Sewing machine

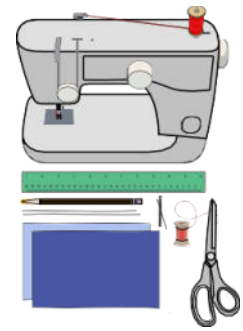

Tutorial

1. Cut out two 10-by-6-inch rectangles of cotton fabric. Use tightly woven cotton, such as quilting fabric or cotton sheets. T-shirt fabric will work in a pinch. Stack the two rectangles; you will sew the cloth face covering as if it was a single piece of fabric.

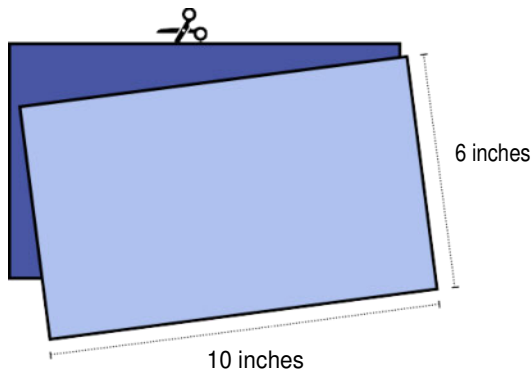

2. Fold over the long sides $\frac{1}{4}$ inch and hem. Then fold the double layer of fabric over $\frac{1}{2}$ inch along the short sides and stitch down.

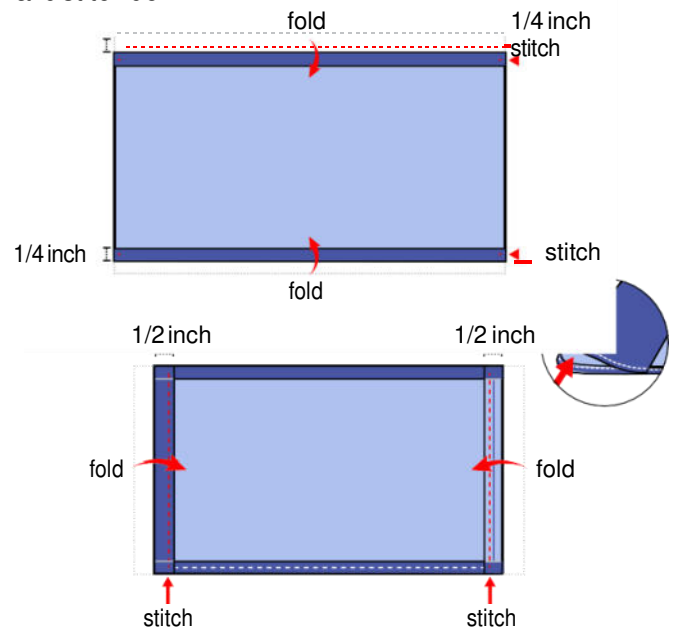

3. Run a 6-inch length of $\frac{1}{8}$ -inch wide elastic through the wider hem on each side of the cloth face covering. These will be the ear loops. Use a large needle or a bobby pin to thread it through. Tie the ends tight. Don't have elastic? Use hair ties or elastic head bands. If you only have string, you can make the ties longer and tie the cloth face covering behind your head.

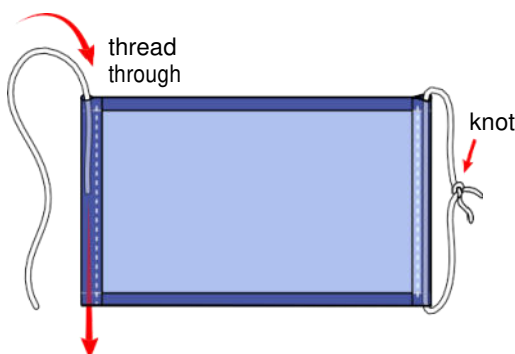

4. Gently pull on the elastic so that the knots are tucked inside the hem. Gather the sides of the cloth face covering on the elastic and adjust so the cloth face covering fits your face. Then securely stitch the elastic in place to keep it from slipping.

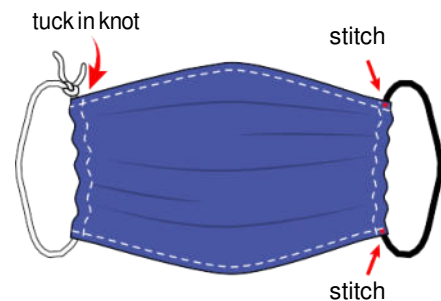

Quick Cut T-shirt Cloth Face Covering (no sew method)

Materials

- T-shirt
- Scissors

Tutorial

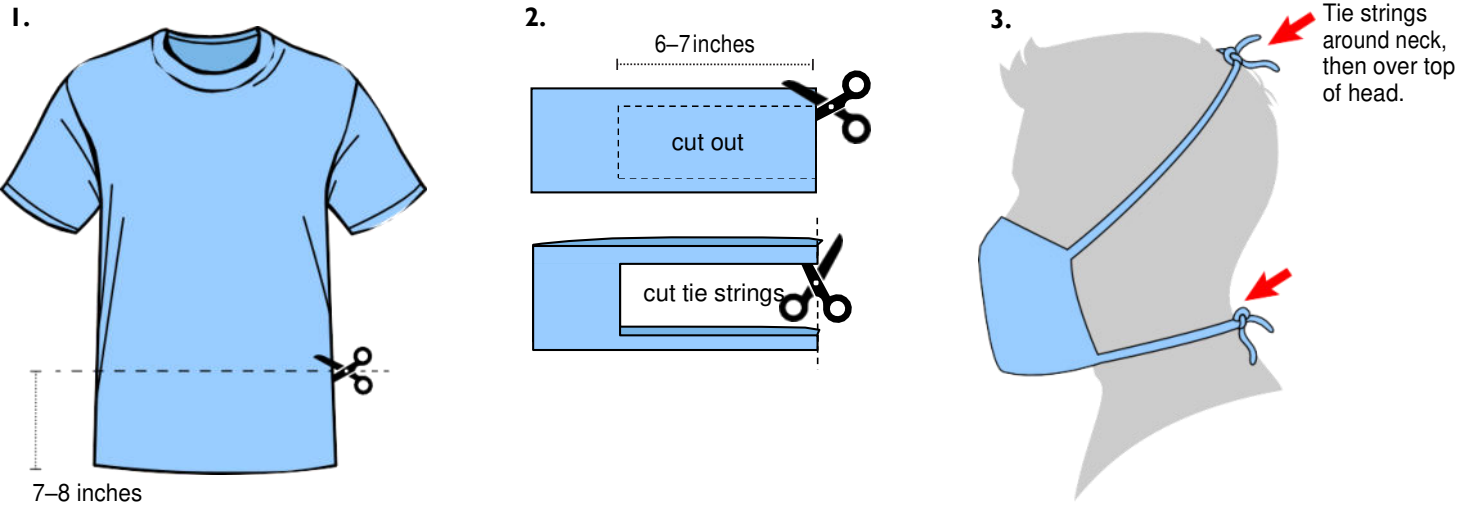

Bandana Cloth Face Covering (no sew method)

Materials

- Bandana (or square cotton cloth approximately 20"x20")
- Coffee filter
- Rubber bands (or hair ties)
- Scissors (if you are cutting your own cloth)

Tutorial

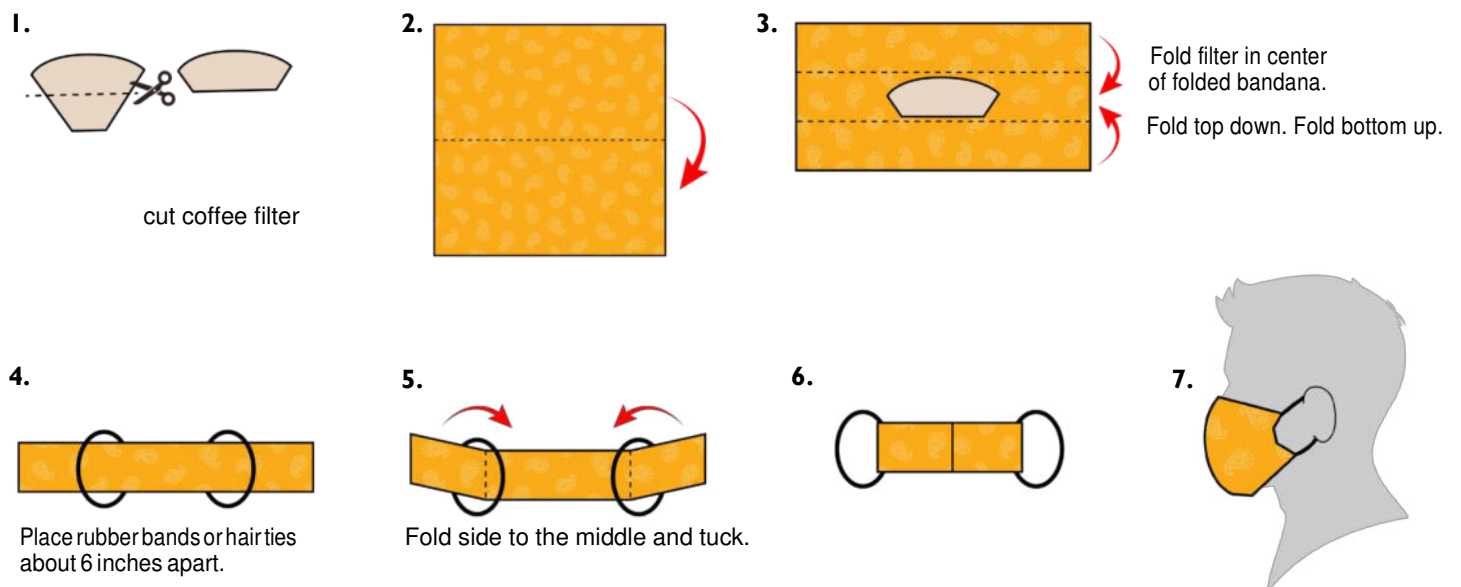

Interim EPA COVID-19 Health & Safety Guidelines for Field Activities – July 6, 2020

Introduction and Applicability

These COVID-19¹ Health and Safety (H&S) Guidelines for Field Activities² represent an integrated set of safety and health guidance that provide timely and consistent information for employees conducting field activities. These Guidelines merge several Agency program-specific COVID-19 H&S guidance documents into an overall document to address COVID-19 safety concerns applicable to field activities.

These guidelines are specific to COVID-19 only and are not intended to supersede existing health and safety requirements or hazard assessments, such as Health and Safety Plans (HASP), the [Emergency Responder Health and Safety Manual](#), [Personal Protective Equipment \(PPE\) hazard assessment guidelines](#), [Job Hazard Analysis \(JHA\)](#), [Job Safety Analysis \(JSA\)](#), and [mobile/vessel laboratory Chemical Hygiene Plans \(CHP\)](#).

These H&S Guidelines for Field Activities are a supplement to the national COVID-19 official guidance provided by the Centers for Disease Control and Prevention (CDC), the National Institute for Occupational Safety and Health (NIOSH), Occupational Safety and Health Administration (OSHA), and Federal Emergency Management Agency (FEMA). This document was developed based on the current COVID-19 guidance from [CDC](#), including [NIOSH](#), and [OSHA](#), as of the date of this document. It is intended for internal use by EPA employees and may apply to EPA contractors and grantees depending on program or contract requirements. These Guidelines may be provided to federal, state, local, territorial and tribal organizations and applies as per existing agreements. The Agency will review and update these Guidelines when new information is received or the COVID-19 situation changes.

In addition, management should incorporate the U.S. Equal Employment Opportunity Commission (EEOC) Technical Assistance Questions and Answers document -- "[What you Should Know about COVID-19 and the ADA, the Rehabilitation Act, and Other EEO Laws](#)" -- into their safety and health decisions.

The management decision to conduct field work during the COVID-19 public health emergency should be made pursuant to applicable program guidance. All such field work is then conducted consistent with these Guidelines. These Guidelines should be integrated into existing field health and safety planning. These Guidelines are not intended to apply to work inside EPA facilities.

The main body of the H&S Guidelines for Field Activities are arranged in the following order:

1. [Respiratory Protection](#)
2. [Safety Training and Medical Clearance](#)
3. [Pre-Travel Considerations](#)
4. [Travel Related Recommendations](#)
5. [Additional General Recommendations](#)

¹ The term "COVID-19" will be used throughout this document even though in some cases it is referring to the virus (SARS-CoV-2) that causes the disease (COVID-19).

² In general, field activities are defined as EPA program activities that are conducted by EPA employees outside of EPA administered facilities (EPA Order 1440.2). Consult with the local Safety, Health and Environmental Management Program Manager to determine applicability to the Region's or Program's field activities. These Guidelines do not apply to field work performed in support of a criminal investigation or the protective service detail.

6. [Workplace Illness and Injuries](#)
7. [Resources, including the EPA COVID-19 Job Hazard Analysis/Job Safety Analysis Template](#)

The appendices provide specific recommendations applicable to various EPA programs and supplement the main body of these guidelines. The respective appendices are:

- [Appendix A – Civil Inspections, On-site Compliance Monitoring, Compliance and Technical Assistance for all programs except programs covered in Appendix B](#)
- [Appendix B – Conducting Superfund Site, Resource Conservation and Recovery Act \(RCRA\) Corrective Actions, Oil, and Emergency Response Work](#)

1. Respiratory Protection³

For on-going Agency work, all PPE previously required to safely conduct work during normal circumstances (prior to the current COVID-19 health emergency) is still required as outlined in other official Agency [PPE hazard assessments](#). If an EPA-coordinated work activity involves direct contact to a known COVID-19 source or presents a high potential for exposure to a COVID-19 source ([OSHA defined high risk for COVID-19](#)), field staff, supervisors, and the local Safety, Health and Environmental Management Program (SHEMP) managers should follow OSHA guidelines, which have been integrated into this document, for conducting a hazard assessment⁴ to determine if respirator usage or additional PPE is required (See the EPA COVID-19 Job Hazard Analysis/Job Safety Analysis Template found in the [Resources Section](#)).

[Table 1](#) summarizes the various OSHA requirements for the use of respirators, disposable surgical masks and cloth face coverings when required by the Agency or used voluntarily, and either provided by the employer or provided by the employee.

a. Disposable Surgical Masks and Cloth Face Coverings

- i. EPA requires the use of cloth face coverings or disposable surgical masks for EPA employees where state or local jurisdictions or facilities require their use. When a hazard assessment shows respirator use is not required and at least six feet social distancing cannot be easily and consistently maintained, EPA requires face coverings or disposable surgical masks for all operations (indoor and outdoor). Disposable surgical masks or cloth face coverings may not be used when a respirator is required.
- ii. Cloth face coverings and the use of disposable surgical masks (in lieu of cloth face coverings) for source control are not considered PPE. However, Agency-required disposable surgical masks used for worker protection during specific tasks are considered PPE and have additional training requirements (see [Table 1](#) below). [CDC is advising the use of cloth face coverings](#) to slow the spread of the virus by helping people who may have the virus and do not know it from transmitting it to others.
- iii. Employees should consult with their supervisors about acquiring clear masks for interaction with others who may need to lipread to communicate. More information is

³ Adapted from the June 19, 2020 EPA Safety, Health and Environmental Management Program – Interim Guidance on the Employee Use of Respiratory Protection Equipment During the COVID-19 Pandemic.

⁴ “Hazard assessment” will be used throughout the document as the term to encompass job hazard analysis (JHA), job safety analysis, task hazard analysis, activity hazard analysis and any other formal workplace safety hazard assessment and risk analysis.

available through the [Job Accommodation Network \(JAN\)](#), including free, expert, and confidential guidance on workplace accommodations.

- iv. A cloth face covering is not a substitute for social distancing, so employees wearing cloth face coverings should continue to maintain at least six feet between themselves and others. Face coverings (or respirators used as face coverings) with an exhalation valve may not minimize the potential transmission of COVID-19. [Cloth face coverings](#) can be fashioned from household items or made from common materials (multiple layers of fabric) at low cost and are now readily available for purchase and do not require training or medical clearance. [Cloth face coverings should be laundered after each use](#), if possible.
- v. Face coverings or disposable surgical masks should not be worn when they create a new hazard (e.g., heat and physical stress while performing strenuous work). In that case, they should be replaced with different PPE that provides protection (e.g., face shields), administrative and/or engineering controls. Additionally, if face coverings or disposable surgical masks become wet, soiled or visibly contaminated during a work shift, they should be exchanged for clean items. At the end of the work shift or when leaving the Site, employees should remove the face covering or disposable surgical mask and don clean ones.

b. N95 Respirators

- i. An N95 respirator represents one of the nine types of [NIOSH-approved filtering facepiece respirators \(FFR\)](#). Recommendations and requirements outlined in this document for N95 respirators also apply to the use of other filtering facepiece respirators. Disposable surgical masks or face coverings are not N95 respirators. An N95 respirator is certified by NIOSH to filter at least 95 percent of airborne particles and may or may not possess an exhalation valve depending on the specific respirator.
- ii. As a respirator, required use of an N95 respirator by EPA employees as part of their assigned duties requires enrollment in the Agency's Respiratory Protection Program (RPP), medical clearance, fit testing and proper training prior to use. (Note that in the case of employees who maintain facial hair either based on a disability or religious practice, supervisors should be prepared to offer such employees a reasonable accommodation, which may include supplying the employee with an alternative respirator that fits properly over facial hair, e.g. Powered Air Purifying Respirators (PAPRs)).
- iii. N95 respirators should not be recommended for use without being identified through a hazard assessment. Based on the hazard assessment, N95s or other types of respirators may be appropriate, such as during some emergency response operations or missions directly involving COVID-19.
- iv. Voluntary use of a respirator is defined as the use of respirators by employees even when an exposure/hazard assessment shows respirator use is not required. Voluntary use of N95 respirators in atmospheres which are not considered hazardous does not require fit testing, medical clearance, or other components of the agency's RPP to be in place. Voluntary use of an N95 filtering facepiece respirator and other FFRs by an employee is covered under [Appendix D of the OSHA Respiratory Protection Standard](#). Before an employee can voluntarily use a respirator, the Agency must ensure that the respirator is cleaned, stored, and maintained so that its use does not present a health

hazard to the user ([1910.134\(c\)\(2\)\(ii\)](#)), whether or not the respirator was provided by the employer or provided by the employee. Voluntary use of an employee-provided N95 respirator requires pre-approval by the local SHEMP manager.

- To meet the requirements of Appendix D of the OSHA Respiratory Protection Standard, EPA's Safety and Sustainability Division (SSD) has developed online training that employees must take. The training is available at [U.S. EPA Voluntary Filtering Facepiece \(e.g. N95 Respirator\) User Training](#). The training includes all the requirements found in Appendix D of the OSHA Respiratory Protection Standard.
- v. For decontamination and reuse of N95 respirators and other FFRs, see [OSHA's Enforcement Guidance on Decontamination of Filtering Facepiece Respirators in Healthcare During the COVID-19 Pandemic](#) and the [Enforcement Guidance for Respiratory Protection and the N95 Shortage Due to the COVID-19 Pandemic](#).
- Extended use or reuse of N95 respirators may be permitted if the respirator maintains its "structural and functional integrity and the filter material is not physically damaged, soiled, or contaminated." The primary hazard of extended use and reuse of respirators is risk of contact transmission during donning and doffing; therefore, it is important that the user follows the [NIOSH guidance for extended use and limited reuse of N95 respirators](#).

c. Air Purifying Respirators (APRs) and Powered Air Purifying Respirators (PAPRs)

- Many EPA field employees, Special Agents, and emergency responders are enrolled in the RPP and are medically cleared to wear a respirator. Some of these EPA employees have been fit tested, trained and provided elastomeric APRs and PAPRs as part of their duties. Voluntary use of an employee-provided elastomeric respirator requires pre-approval by the local SHEMP manager, medical clearance and [U.S. EPA Voluntary Filtering Facepiece User Training](#).
- When used in conjunction with the proper filtering cartridge (e.g., P100), these types of respirators offer the wearer superior protection over wearing N95 respirators. However, unlike an N95 respirator without an exhalation valve, a standard APR or PAPR with a P100 cartridge does not provide filtration upon exhalation, so if the wearer is already infected with COVID-19 and is contagious, that person may potentially expose those around them to the virus. Wearing a respirator is not a substitute for social distancing, so employees should continue to maintain at least six feet between themselves and others whenever possible while wearing a respirator.

d. EPA Recommendations

- For most field activities, the use of a cloth face covering or a disposable surgical mask is sufficient. Respirators generally are not needed to meet the [CDC recommendations for COVID-19 protection](#) and the [OSHA Guidance on Preparing Workplaces for COVID-19](#). EPA will follow OSHA guidance for identifying COVID-19 risk levels in the workplace and determining appropriate control measures, including reserving the use of N95 respirators for high exposure risk jobs to COVID-19 (e.g., an EPA Emergency Support

Function (ESF)-10 COVID-19 related response or Special Agents in close personal contact to individuals).

- EPA employees should be assigned respirators (e.g., N95s, APRs or PAPRs) for a specific field activity if the hazard assessment indicates respirator use is necessary. However, the employee must meet all the OSHA regulatory prerequisites. As previously noted, there are many EPA employees who already meet the prerequisites to wear specific respirators; therefore, no further action is needed to use their assigned respirators.
- Do not cover an exhalation valve or place a face covering/disposable surgical mask over the respirator since this can alter the function of the respirator.
- Task specific hazard assessments must be completed by the field employee, supervisor, and the local SHEMP manager, following the [OSHA Guidance on Preparing Workplaces for COVID-19](#), which have been incorporated into this document, and using the EPA COVID-19 Job Hazard Analysis/Job Safety Analysis Template found in the [Resources Section](#).

TABLE 1 - OSHA Requirements for Respirators, Surgical Masks and Cloth Face Coverings

	Respirator N95, APR, PAPR Agency Provided and Required Use	Respirator N95, APR, PAPR Employee Provided and Voluntary Use	Surgical Mask FDA or non-FDA Approved Agency Provided and Required Use	Surgical Mask FDA or non-FDA Approved Agency Provided and Voluntary Use	Surgical Mask FDA or non-FDA Approved Employee Provided and Voluntary Use	Cloth Face Covering Agency or Employee Provided, Voluntary or Required Use
Medical Clearance Required (OSHA)	Yes	No (N95 filtering facepiece/dust mask) Yes (Elastomeric facepiece, APR/PAPR)	No	No	No	No
User Training Required (OSHA)	Yes Doffing/Donning Minimize Cross Contamination	Yes ⁵ Supply OSHA Appendix D and SSD Training	Yes Minimize Cross Contamination	No Recommended correct use	No Recommended correct use	No
Respirator Fit Test Required (OSHA)	Yes	No (N95 filtering facepiece/dust mask) No (Elastomeric facepiece, APR/PAPR)	No	No	No	No
Job/Hazard Analysis (OSHA)	Yes	No ⁶	Yes	Yes	No	No

⁵ OSHA does not require training; however, EPA is requiring the SSD Online training for the voluntary use of all respirators.

⁶ Although not required for employee provided voluntary use under the OSHA Respiratory Protection Standard, EPA still requires field work to have a hazard assessment / JHA completed as per the OSHA PPE Standard.

2. Safety Training and Medical Clearance for Field Activities

Field personnel must be properly trained for field activities:

- a. Field Health and Safety Training: Initial 24-hour Field Health and Safety Training is required. If the annual 8-hour Field Health and Safety Refresher Training could not be completed due to the COVID-19 Public Health Emergency, annual certifications are temporarily extended by six months as determined by EPA in consultation with OSHA.
- b. HAZWOPER Regulated Activities: Initial 24-hour or 40-hour HAZWOPER training is required for field personnel working on Superfund and RCRA Corrective Action Sites and for field personnel responding to the release or threat of release of hazardous substances. If the annual 8-hour HAZWOPER Refresher Training could not be completed due to the COVID-19 Public Health Emergency, annual certifications were also temporarily extended by six months.

Some field personnel may also need medical clearances:

- a. Medical Clearance: Field employees enrolled in the Occupational Medical Surveillance Program (OMSP) had their medical clearances temporarily extended by six months from date of expiration due to the COVID-19 public health emergency as determined by EPA in consultation with the Office of Federal Occupational Health (FOH). If an employee's health status changes significantly during the extended clearance period, the employee is expected to self-report the change to the SHEMP manager and their supervisor.
- b. RPP Enrollment: Field employees who are enrolled in the RPP must also receive a respiratory medical clearance. These clearances have been temporarily extended by six months. [Annual respiratory protection training and current respirator fit tests are also extended by six months for FFRs.](#)
- c. Vaccinations: Currently, there is no vaccine or medical prophylaxis for COVID-19. Check with local SHEMP manager for any other vaccine requirements.

3. Pre-Travel Considerations

- a. [Local, state, territorial or tribal governments may have more stringent requirements](#) than those found in these guidelines (e.g., 14-day quarantine upon arrival). Field staff traveling to areas outside their home jurisdictions should check for additional requirements and include them in their field work planning and in the hazard assessment process.
- b. Follow the steps outlined in the [EPA Self-Assessment to Stop the Spread of COVID-19](#) tool to make sure employees are not ill or symptomatic. Please perform this self-assessment prior to departing and daily before reporting to work.
- c. [CDC Interim Guidance for Businesses and Employers Responding to Coronavirus Disease 2019 \(COVID-19\), May 2020](#) also provides **guidance for general workers who may have had a potential exposure to COVID-19 but are asymptomatic.** If field employees believe they were exposed to COVID-19 (close personal contact with a person symptomatic or confirmed positive for COVID-19), follow the [CDC Public Health Recommendations for Community-Related Exposure](#):
 - Stay home until 14 days after last exposure and maintain social distance (at least six feet) from others at all times.
 - [Self-monitor for symptoms.](#)

- Check temperature twice a day.
 - Avoid contact with [people at higher risk for severe illness](#).
 - Follow [CDC guidance](#) if symptoms develop.
 - Follow the [CDCs Discontinuation of Isolation for Persons with COVID -19 Not in Healthcare Settings Guidance](#) prior to conducting field work if were previously ill.
- d. For emergency response and Superfund/RCRA corrective action site work, CDC has issued Interim Guidance for [Implementing Safety Practices for Critical Infrastructure Workers Who May Have Had Exposure to a Person with Suspected or Confirmed COVID-19](#). This CDC **guidance applies to critical workers, including hazardous material responders from government and private sector, who may have been potentially exposed to COVID-19**. To ensure continuity of operations of essential functions, CDC advises that critical infrastructure workers may be permitted to continue work following potential exposure to COVID-19, provided they remain asymptomatic and additional precautions are implemented to protect them and the community. A potential exposure means being a household contact or having close contact within six feet of an individual with confirmed or suspected COVID-19. The timeframe for having contact with an individual includes the period of 48 hours before the individual became symptomatic. See [Appendix B](#) for specific practices and screening information.
- e. COVID-19 is a new disease and there is limited definitive information regarding risk factors. Based on currently available information and clinical expertise, [older adults and people of any age who have serious underlying medical conditions](#) might be at higher risk for severe illness from COVID-19. Consider underlying medical conditions during field activity assignments. Any health screening of personnel must be compliant with [CDC guidance](#) and [EEOC guidance](#). [Follow Health Insurance Portability and Accountability Act of 1996 \(HIPAA\) requirements to safeguard medical and personal identifiable information \(PII\)](#). General recommendations for employees and supervisors handling protected medical information include:
- If possible, rely on self-assessments/self-reporting and do not record the information.
 - If documentation is required, only record the needed information (e.g. COVID-19 symptom status, temperature checks).
 - All records that are created must be kept on a password protect computer or under lock and key. After completion of field activities, consult local records management specialists for retention of records.
- f. Prior to performing field work at a specific location, the field staff, their supervisor and the local SHEMP manager must perform a supplemental hazard assessment addressing COVID-19. An example of such a supplemental hazard assessment is provided in the [Resources Section](#) below. If an EPA-coordinated work activity involves direct contact with a known COVID-19 source or presents a high potential for exposure to a COVID-19 source the supervisor and local SHEMP manager must follow OSHA guidelines for conducting a hazard assessment to determine if respirator usage or additional PPE is required. [OSHA Guidance on Preparing Workplaces for COVID-19](#) provides four exposure risk categories. The level of risk depends in part on the industry type, need for contact within six feet of people known to be, or suspected of being, infected, and the need for repeated or extended contact with persons known to be, or suspected of being, infected. To help employers determine

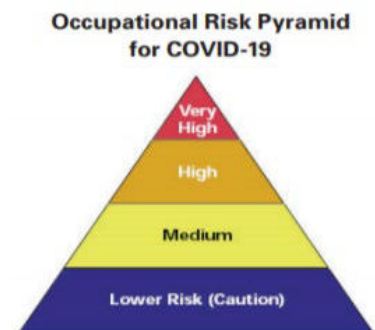

appropriate precautions, OSHA has divided job tasks into four risk exposure levels: very high, high, medium, and lower risk. **Most EPA field activities will likely fall in the lower exposure risk (caution) category** and, less frequently, will fall into the medium risk category in areas where there is ongoing community transmission and contact with the general public. Review the EPA COVID-19 Job Hazard Analysis/Job Safety Analysis Template found in the [Resources Section](#) and integrate, as appropriate, into existing safety plans and JHAs.

- g. Prior to travel, assess the prevalence of COVID-19 in the area(s) that employees are traveling to or performing field work.
 - Specific COVID-19 information can be found on state/territorial/local government and health department websites. Available sources include the [CDC State, Territorial, Local and Tribal Health Department Search Tool](#), [CDC COVID-19 Tracker](#), [Johns Hopkins University Coronavirus Resource Center](#)⁷, the [COVID Tracking Project](#)⁷, the [U.S. Census Bureau's Coronavirus \(COVID-19\) Pandemic Site](#) and other expert sources.
 - EPA also developed the [EPA Facility Status Dashboard](#) to aid in facility reopening decisions. The Dashboard provides information on the status of each gating criterion in the commuting area surrounding our facility locations.
 - Consider both work-related and community exposure potential. Further information for considering ongoing community transmission of COVID-19 is contained in the EPA COVID-19 Job Hazard Analysis/Job Safety Analysis Template found in the [Resources Section](#).
- h. Consult with the SHEMP manager to determine what additional PPE may be required, such as gloves, Tyvek suits, eye protection, and, if necessary, respiratory protection.
- i. Cloth face coverings or disposable surgical masks are required to be worn in the field when social distancing cannot be maintained and/or when respiratory protection is not being worn to address field hazards. When planning field work, a sufficient number of cloth face coverings or disposable surgical masks should be available to the field employee to account for required change-out at the end of the shift and if they become wet, dirty or contaminated.
- j. PPE should be selected to address all hazards present, including COVID-19.
- k. Employees should identify and obtain all PPE needed to complete the task. Employees should not use or wear shared or borrowed PPE (e.g. flame-retardant coveralls supplied by a facility).
- l. Nitrile or similar disposable gloves may afford some COVID-19 protection for the employee when hand sanitizer is not available, or when hand washing is not feasible.
- m. All EPA staff should take extra care not to touch their faces, especially after any time they touch a known or potentially contaminated surface.

4. Travel Related Recommendations

- a. Supervisors and SHEMP managers should encourage all personnel to drive rather than fly when possible. Consider staffing field work with personnel that can get to the site by vehicle, because it affords additional flexibility to adjust plans based on changing conditions in the local area or work site. Attempt to maintain one person per vehicle; if not practical, consider separating passengers in the vehicle as much as possible (e.g., front seat/back seat) and don face

⁷ Non-federal sites are included for informational purposes only and do not constitute any endorsement by EPA or its employees.

coverings. Ensure that face coverings do not impair visibility when driving. Maximize fresh air flow in the vehicle.

- b. If driving to the site/facility is practical, EPA employees may wish to use their personally owned vehicle (POV) to minimize the need to disinfect fleet or rental car vehicles. This also may be more efficient if it eliminates the need for field staff to travel to a downtown location to pick up a fleet or rental car. Per recent Office of General Counsel determination, employees driving POVs should be able to claim the higher mileage rate even if a rental or fleet vehicle was available.
- c. Field staff should:
 1. Review criteria in the [EPA Self-Assessment to Stop the Spread of COVID-19](#) tool daily while on travel or conducting field work.
 2. Prior to departing, obtain [EPA COVID-19 registered disinfectants](#)⁸ and [FDA approved hand sanitizers](#)⁹. Use EPA's [List N Tool: COVID-19 Disinfectants web-based tool](#) to quickly identify disinfectant products that meet EPA's criteria. Read and follow the label instructions on these products, for example disinfectant contact times, PPE requirements, etc.
 3. Prior to travel by air, review and follow all airline-specific and Transportation Security Administration (TSA) requirements and guidance. This could include required use of face coverings during the entire flight, social distancing while seated, and the use of disinfectants. See the [TSA COVID-19 information](#) for details.
 4. Disinfect vehicles (wipe down commonly-touched surfaces, such as the steering wheel, door handles, touch screens, etc.) prior to checking out or renting a vehicle. See the EPA Office of Mission Support (OMS)-SSD Vehicle Utilization, Cleaning and Disinfection Recommendations in the [Resources Section](#) for more information.
 5. Seek out lodging facilities with in-room food storage and food preparation options (e.g., refrigerator, microwave oven, etc.).
 6. Disinfect hotel room. Use the "No Housekeeping" sign to limit access to hotel room.
 7. Avoid hotel breakfast buffets or only consume unopened food items (wash any fresh fruit prior to eating).
 8. Minimize trips to the grocery stores and cook meals in the hotel room with in-room food storage and food preparation options (e.g., refrigerator, microwave oven, etc.). If in-room facilities are not available, consider a meal delivery service, takeout, or curbside pickup. Consider alternatives to indoor seating at restaurants if possible.
 9. Change out field clothing and launder in hot water immediately upon returning home.
 10. Keep any work-related gear that cannot be easily laundered (e.g., safety boots, high visibility vests, coats, hard hats, etc.) outside the residence or lodging (e.g., in a plastic bag in a vehicle or garage) and consider donning disposable coveralls (e.g., Tyvek) to reduce clothing contamination. Work-related gear or equipment that cannot be easily

⁸ "Disinfectant" and "Disinfect" will be used throughout the document and refers to use of products found on the [EPA List N: Disinfectants for Use Against SARS-CoV-2 \(COVID-19\)](#).

⁹ "Hand sanitizer" will be used throughout the document and refers to [FDA approved hand sanitizers](#) or alcohol-based hand sanitizer that contains at least 60 percent alcohol (also referred to as ethanol or ethyl alcohol).

disinfected should remain bagged for three to seven days in an unoccupied area when possible based on similar guidance.

5. Additional General Recommendations for Staff to Follow While in the Field

- a. Avoid large crowds or groups.
- b. Practice social distancing – maintain six-foot distance from others.
- c. If field employees encounter a potentially unsafe situation (e.g., improper social distancing, large crowds, areas with ongoing COVID-19 transmission, etc.), they should remove themselves from that situation, if possible, and contact their supervisor and SHEMP manager for additional guidance.
- d. Make sure all personnel wash their hands frequently, prior to taking a break, prior to eating, after use of the bathroom, upon leaving the field for the day, etc. Encourage adherence to prescribed handwashing guidelines, see the [CDC handwashing guidance](#).
- e. Augment field handwashing equipment. Ensure that soap and water handwashing facilities are available in the field. If handwashing facilities are not immediately available, use hand sanitizer that contains at least 60% alcohol.
- f. Limit restroom use in convenience stores, gas stations and public facilities.
- g. Do not use shared coolers for field hydration fluids. Encourage employees to bring and use their own coolers for drinking water.
- h. Do not shake hands. Use other forms of non-contact greeting.
- i. Avoid sharing items (e.g., pens, cameras, clipboards, tape measure) with others as much as possible. Do not pass around a clipboard and pen.
- j. Conduct [initial check-in/screening](#) for all personnel entering the site. Use one person to log in personnel or use virtual tools that may be available in MS Teams, SharePoint, etc.
- k. Keep meetings to a minimum; update federal partners, state, local, territorial and tribal personnel via conference calls/emails rather than site (face-to-face) visits.
- l. If the field activities involve work at multiple different locations, doff PPE and disinfect prior to moving to the next location.
- m. When field equipment is handled by multiple people, disinfect the equipment, following manufacturer recommendations, between uses.
- n. Follow manufacturer's instructions and use an approved disinfectant when cleaning sensitive equipment such as air monitoring instrumentation.
- o. Clean or disinfect work areas daily or as needed based on use. Focus cleaning on common touchpoints.
- p. Disinfect vehicles (wipe down the steering wheel, door handles, touchpoints, etc.) daily, including when checking the vehicle out and when returning. During fueling operations, consider disinfecting touch screens and pump handles, or use hand sanitizer post fueling. See the EPA OMS-SSD Vehicle Utilization, Cleaning and Disinfection Recommendations in the [Resources Section](#) for more information.
- q. Respiratory aerosols, secretions, perspiration, and other potentially infected body fluids can accumulate in PPE. Coach crews to pay closer attention to disinfecting respirators. Emphasize social distancing while donning and doffing PPE and a thorough hand, arm, and face wash after each entry. Attempt to don PPE without an attendant. If an attendant is necessary, the attendant should don respiratory protection or a face covering and protective gloves.

- r. In general, used cleaning supplies (wipes, paper towels, etc.) and PPE used solely for COVID-19 protection are not considered regulated medical waste. These items are typically disposed as municipal solid waste. Review and follow the waste disposal procedures listed on the disinfectant/cleaning product label. Review and follow any special waste disposal procedures found in the field specific HASP. See the [CDC Waste Disposal Guidance](#) for further details.

6. Workplace Illness and Injuries

The following procedures should be followed for illness or injuries (COVID-19 and non-COVID-19 related):

- a. Contractors and employees should call 911 immediately if they are experiencing a life-threatening medical emergency.
- b. If a contractor or employee becomes ill or is injured while on travel, he or she must follow the procedures listed in the HASP or other field work safety document.
- c. Contractors and employees should contact their supervisors/safety officers (SHEMP manager) to report their illness status. EPA supervisors and SHEMP managers should follow [EPA COVID-19 Guidance for Contact Tracing and Employee Notifications for EPA Managers and Supervisors](#).
- d. EPA personnel, who require medical treatment from a workplace injury or illness, should seek initial emergency medical assistance immediately and contact supervisor and local SHEMP manager as soon as possible. The [Department of Labor \(DOL\) Form CA-16](#) is completed by supervisor, local SHEMP manager, or site supervisor and submitted to the medical facility to initiate payment for work-related injury or illness. Most medical facilities now have these forms electronically or the supervisor or the Agency can provide a hard copy. The employee should not provide their private health insurance to the medical provider when a DOL Form CA-16 is used.
- e. If field employees experience symptoms related to COVID-19, they should self-isolate at home or in their hotel room until given instructions to do otherwise (Contact the supervisor and medical provider). **If an employee is ill or experiencing symptoms of COVID-19, he or she should return to work only after following [CDC guidelines](#) or as advised by a physician.** Follow [CDC guidance](#) as required. EPA employees should refer to [EPA COVID-19 intranet site](#) for Agency-specific procedures.
- f. If symptoms become severe, such as shortness of breath or respiratory distress, the individual should contact 911 or proceed immediately to the nearest hospital.
- g. EPA employees experiencing symptoms of an illness that may be workplace-related should contact their supervisors immediately. Employee and supervisors should complete the [OSHA/EPA 301 – Accident, Illness and Near Miss Report](#), in consultation with their SHEMP manager.
- h. If an employee returns from field work and begins to experience COVID-19 symptoms, they should contact their primary care physician for instructions and notify his or her supervisor. It is required to self-isolate at home (avoiding close contact with family members). EPA employees should not report to an FOH clinic (who would likely refer the individual to his or her personal physician or local health department in accordance with CDC guidance.)

OSHA recordkeeping requirements (29 CFR Part 1904) mandate covered employers record certain work-related injuries and illnesses on their OSHA 300 log.

Under OSHA’s recordkeeping requirements, COVID-19 is a recordable illness, and employers are responsible for recording cases of COVID-19, if:

1. The case is a confirmed case of COVID-19 (see CDC information on persons under investigation and presumptive positive and laboratory-confirmed cases of COVID-19);
2. The case is work-related, as defined by 29 CFR 1904.5; and
3. The case involves one or more of the general recording criteria set forth in 29 CFR 1904.7 (e.g. medical treatment beyond first-aid, days away from work).

Determining whether an employee who contracted COVID-19 did so due to exposures at work may be difficult. Employees should contact their SHEMP manager to determine if a COVID-19 illness is recordable on their OSHA 300 log.

DOL Information on Federal Employees’ Compensation Act (FECA) Coverage for COVID-19

DOL has created new procedures to specifically address COVID-19 claims. Employees filing a claim for workers' compensation coverage as a result of COVID-19 should file [Form CA-1, Federal Employee's Notice of Traumatic Injury and Claim for Continuation of Pay/Compensation](#), and FECA has provided guidance for [Federal Employees Contracting COVID-19 in Performance of Duty](#).

All federal employees who develop COVID-19 while in the performance of their federal duties are entitled to workers' compensation coverage pursuant to FECA.

An employee or their supervisor with questions about a potential worker’s compensation claim related to COVID-19, should contact their [Worker’s Compensation Coordinator](#) in their Office or Region.

7. Resources

- EPA COVID-19 Job Hazard Analysis/Job Safety Analysis Template (includes a list of considerations to assess local conditions prior to travel and an example JHA)
- [EPA OMS-SSD Vehicle Utilization, Cleaning, and Disinfecting Recommendations 4/27/20](#)
- [U.S. EPA Voluntary Filtering Facepiece \(e.g. N95 Respirator\) User Training](#)
- [OSHA Guidance](#)

Appendix A

Civil Inspections, On-site Compliance Monitoring, Compliance and Technical Assistance

Applicability

Appendix A applies to EPA employees and contractors, states, tribes, and Senior Environmental Employees (SEE) grantees and other entities as follows:

- Anyone with EPA inspector credentials performing an inspection. Such persons are designated as “credentialed EPA inspectors” in this Appendix.
- Any EPA employee conducting other non-inspection compliance activities, including on-site compliance monitoring activities, and on-site compliance (or technical) assistance, such as Drinking Water sanitary surveys and other site visits. Such persons are designated as EPA compliance staff in this Appendix.

This Appendix applies to both routine compliance field work and non-routine field work, such as responding to an acute situation to address a potential or known imminent and substantial threat to human health or the environment.

Identifying Appropriate Inspections and Inspectors

The management decision to do an inspection should be consistent with applicable Agency priorities, which include:

- 1 To address acute threats to human health or the environment where there is a risk of, or a known acute or imminent threat to human health or the environment and an inspection is necessary to understand the problem and address it.
- 2 Statutory requirements.
- 3 Regional Strategic Plans.
- 4 [National Compliance Initiative \(NCI\) Strategies](#);
- 5 One of the five [Compliance Monitoring Strategies](#);
- 6 Agreements with states pursuant to [Office of Enforcement and Compliance Assurance’s \(OECA\) Partnership Policy](#), including both periodic inspection planning and more immediate requests from our partners;
- 7 Tips and complaints from the public.
8. Inspector training: Senior inspectors providing inspectors-in-training with their required on the job training so they can become credentialed, or senior inspectors training junior inspectors.
9. Priorities established by other National Program Managers with inspection authority and resources

A site-specific hazard assessment shall be conducted before an employee is sent into the field following the EPA COVID-19 Job Hazard Analysis/Job Safety Analysis Template provided in the [Resources Section](#) above. If the site-specific hazard assessment shows that respirator usage or additional PPE is required, then the supervisor should confirm that the on-site activity (e.g., inspection) is still necessary or whether off-site compliance monitoring or other alternatives may be more appropriate. If an on-site activity is still warranted, EPA compliance staff must meet all the prerequisites (medical clearance, fit testing, training, etc.) to use that PPE. If the employee does not

meet all requirements for use of the required PPE, then the supervisor should identify a different employee who does meet all the requirements. If the employee is part of a high-risk group as defined by the CDC and has any reservations about conducting the on-site activity, those situations should be addressed by the supervisor on an individual basis.

Facility Notification of Inspection or Other Compliance Related Site Visit

At least 24 hours before the expected start of the compliance field work, EPA compliance staff should contact the facility unless there is a compelling reason not to, or it is not practical (e.g., stormwater construction inspections). This advance communication is intended for EPA to determine what COVID-related risks may be at the facility, such as whether the facility is practicing social distancing, using face coverings for their employees and had recent confirmed COVID-19 cases among its employees on-site. EPA can also inform the facility that EPA will be taking precautions as well. EPA should ask the facility what protective measures the facility is using for its employees and visitors so that EPA can know in advance whether these are reasonable requests and, if reasonable, how EPA can follow the requests.

Facility Access for Inspections and other compliance visits (including health screens and protective equipment)

EPA is not changing its long-standing policy on facility access and PII for inspections. With limited exceptions, EPA compliance staff shall not provide any PII as a condition to gaining entry to a facility to conduct field work.¹⁰ Credentialed EPA inspectors are expected only to show their EPA-issued inspector credentials to gain access to a facility to conduct an inspection. Further, per EPA Order 3510, credentialed EPA inspectors are prohibited from relinquishing physical control of these credentials to another entity, such as allowing facilities to make copies of their credentials.

The [May 2020 CDC guidance](#) states that employers opening their business should consider conducting daily in-person or virtual health checks (e.g., symptom and/or temperature screening) of employees before they enter the facility, in accordance with state and local public health authorities and, if available, occupational health services.

If a facility requests a COVID-related health screening of EPA compliance staff prior to granting access to enter its facility and this request is the same health screen the facility applies to all its employees or visitors, then EPA compliance staff should comply with this request, if reasonable. If the screening is more rigorous for EPA than for employees or visitors who enter the facility, then the EPA compliance staff may decline the screening (after consulting with his or her supervisor) and consider this a denial of access. If the EPA compliance staff is not comfortable with completing the standard COVID-19 health screening that the facility uses for all its employees/visitors, then the EPA compliance staff may choose not to conduct the inspection/site visit after discussing the situation with his or her supervisor and this is not considered a denial of access.

If the facility requests that the EPA compliance staff take specific protective measures to reduce the spread of COVID-19, such as use a cloth face covering, wear gloves, sanitize their hands upon entering the facility and periodically thereafter, or use PPE, the EPA compliance staff should comply with these requests if such requests are consistent with practices done for all visitors and staff, and the facility

¹⁰ There may be limited exceptions when additional information is necessary for inspections at federal facilities. Updated guidance from OECA for federal facility inspections will be available in late June 2020 with additional protocols to follow at federal facilities with military, intelligence, nuclear-related functions or other special security and access requirements necessitated by their mission.

provided EPA with advance notice of this requirement. In general, EPA compliance staff should not share PPE. EPA compliance staff, in certain circumstances, have discretion to use facility-provided hand sanitizer and don clean/disinfected PPE in certain sterile/cleanroom environments. EPA compliance staff should consult with supervisor and SHEMP manager for additional guidance.

Site Safety Plan

As required with all inspections, credentialed EPA inspectors shall complete an ECAD Site Safety Plan. Considerations for COVID-19 should be placed in the Biological Hazards section of the Site Safety Plan. See the [National Quality Assurance Field Activity Procedures SharePoint site](#) for more information on each region's Site Safety Plan.

For wastewater facility inspections and other compliance visits, EPA compliance staff should review and follow the [CDC compiled wastewater operator workplace safety information](#) as required.

For non-inspection compliance visits, such as Drinking Water Sanitary Surveys, there has not been a National expectation for completing a Site Safety Plan. If the EPA COVID-19 Job Hazard Analysis indicates that the COVID-19 exposure risk is above the low exposure level, as described in [OSHA Guidance on Preparing Workplaces for COVID-19](#), the SHEMP manager may require a Site Safety Plan.

General Recommended Inspection and Other Compliance Visit Precautions

1. EPA compliance staff (such as the inspector) should consider conducting opening and closing conferences by conference call, video conference or outdoors, rather than in confined spaces where social distancing may not be possible (make sure to document time and date in field notes if they take place apart from the on-site field work). EPA compliance staff may conduct the opening conference, or elements of it, in advance, of the inspection.
2. To the extent practicable, the EPA compliance staff should review relevant facility documents prior to an inspection. If the EPA compliance staff must review paperwork on-site, they should come prepared with questions and avoid reviewing documents in a small confined space that does not promote social distancing, when possible. EPA compliance staff should wash their hands or use hand sanitizer after touching any documents, files or materials provided by the facility.
3. The EPA compliance staff should plan in advance to limit the number of personnel present during the compliance site visit from EPA, the facility, and other parties to a minimum and talk with the facility in advance how to do such meetings outdoors or in large indoor spaces where social distancing of at least six feet.

Appendix B

Conducting Superfund Site, RCRA Corrective Actions, Oil, and Emergency Response Work

EPA recommends that its field staff and contractor personnel follow these practices while responding to emergency incidents, oil spills and conducting work on Superfund and RCRA Corrective Action sites. To start, all field staff and supervisors should review the [Office of Land and Emergency Management \(OLEM\)/OECA Interim Guidance on Site Field Work Decisions Due to Impacts of COVID-19](#) prior to planning field activities.

CDC has issued interim guidance on [Implementing Safety Practices for Critical Infrastructure Workers Who May Have Had Exposure to a Person with Suspected or Confirmed COVID-19](#). This guidance applies to critical workers, including hazardous material responders from government and the private sector, who may have been potentially exposed to COVID-19.

To ensure continuity of operations of essential functions, CDC advises that critical infrastructure workers may be permitted to continue work following potential exposure to COVID-19, provided they remain asymptomatic and additional precautions are implemented to protect them and the community.

A potential exposure means being a household contact or having close contact within six feet of an individual with confirmed or suspected COVID-19. The timeframe for having contact with an individual includes the period of 48 hours before the individual became symptomatic.

Hazardous material responders from government and the private sector (Critical Infrastructure Workers) who have had an exposure but remain asymptomatic should adhere to the following practices prior to and during their work shift:

1. **Pre-screen:** Employers should measure the employee's temperature and assess symptoms prior to them starting work. Ideally, [temperature checks](#) should happen before the individual enters the facility ([Follow HIPAA requirements to safeguard medical and other PII](#)).
2. **Regular monitoring:** If the employee doesn't have an elevated temperature or symptoms, he or she should self-monitor under the supervision of the employer's occupational health program.
3. **Wear a face covering:** The employee should always wear a face covering while in the workplace for 14 days after last exposure. Employers can issue face coverings or can approve employees' supplied cloth face coverings in the event of shortages.
4. **Social distance:** The employee should maintain at least six feet and practice social distancing as work duties permit in the workplace.
5. **Disinfect and clean workspaces:** Clean and disinfect all areas, such as offices, bathrooms, common areas, and shared electronic equipment, routinely.

Monitor for Illness and Enforce Safety Measures

It is critical that all response personnel are continuously monitored daily and strictly follow the site HASP. Depending on the size, duration, scope of the hazards, and number of personnel involved with the site, an effort should be made to have an Emergency Medical Technician (EMT) or access to an EMT on site. Possible sources of personnel with EMT training include response contractors, the U.S.

Coast Guard (USCG) Strike Team, and local fire departments. The EMT or Site Safety Officer should make daily observations of COVID-19 safety compliance and consider monitoring response workers for symptoms.

Additional Considerations and Safety Best Practices

1. Suspend after-hours recreational activities involving gathering of others (no cookouts, sports, etc.).
2. Mobilize bathroom facilities even if Site activities are a short duration.
3. Do not hold in-person public meetings. Cancel, postpone or reschedule face-to-face meetings, or consider the use of virtual meeting tools if meetings are necessary. See the [Comprehensive Environmental Response, Compensation, and Liability Act \(CERCLA\) Interim Guidance on Public Engagement During COVID-19](#) for details.
4. Secure a large place or area to facilitate social distancing during briefings. Break up safety and other operational briefings into small groups. Use MS Teams, Skype or other virtual communication tools for Unified Command meetings.
5. For incidents involving numerous response personnel, consider assigning a special safety team that focuses on health status screening, social distancing, handwashing protocol compliance, and other COVID-19 risk reduction protocols. Consider staffing a healthcare professional on this designated special safety team.
6. If trailers are needed, use multiple office trailers/command posts to aid in social distancing as needed. Maximize outside air flow. Consider multiple trailers for EPA and contractors to separate workers.
7. Clean or disinfect site trailers, command posts, porta johns, handwash stations, etc. daily and as needed. Focus on common touchpoints.
8. Do not share respirators (PAPRs, SCBAs, SARs). Issue the PAPRs, SCBAs, SARs to personnel for the duration of the response. All site workers must be fit tested on the specific respirator they are issued. Conduct thorough decontamination and disinfection, following manufacturer recommendations, and inspect respirator components for cracked, damaged and missing parts prior to returning equipment.
9. EPA's Chemical Management Advisory Division (CMAD) has developed additional information on precautions, PPE, decontamination, cleanup and waste management: SARS-CoV-2 Information for On-Scene-Coordinators. This document is located on [CMAD's 2019 Novel Coronavirus Information](#) for OSCs, on Response.epa.gov.
10. [CDC has developed coronavirus waste management information that is listed on their website.](#)

Residential Site Work and Emergency Response Safety Best Practices

Consider these best practices, in addition to all other discussed previously, when site work or emergency response activities require direct interaction with the public.

1. Ensure that only essential personnel enter homes and/or communities, keep the personnel resources to a minimum.
2. Limit face-to-face interactions to only those necessary.
3. Maintain at least six feet distance.
4. Call via phone instead of knocking/ringing doorbell if possible. When knocking on doors, knock, and step back from the door entryway at least six feet. Consider temporarily removing any face coverings/respirator while introductions are made.

5. It is preferred that written documents, such as an access agreement, are acquired via email. If this is not possible, place completed documents into a plastic bag and disinfect the outer plastic bag.
6. During the actual removal/remedial action, if the resident needs to engage with the crew, do it from a safe distance.
7. Final building/property walk-throughs should be cancelled unless the property owner wants to meet to talk about something. If everything is satisfactory, consider using email to document approval.
8. If relocation is recommended, encourage relocation with family or friends with whom the residents have already had close contact. Consult with the Agency for Toxic Substances and Disease Registry or public health officials on relocation guidelines.



Guidance on Preparing Workplaces for COVID-19

OSHA 3990-03 2020

Occupational Safety and Health Act of 1970

“To assure safe and healthful working conditions for working men and women; by authorizing enforcement of the standards developed under the Act; by assisting and encouraging the States in their efforts to assure safe and healthful working conditions; by providing for research, information, education, and training in the field of occupational safety and health.”

This guidance is not a standard or regulation, and it creates no new legal obligations. It contains recommendations as well as descriptions of mandatory safety and health standards. The recommendations are advisory in nature, informational in content, and are intended to assist employers in providing a safe and healthful workplace. The Occupational Safety and Health Act requires employers to comply with safety and health standards and regulations promulgated by OSHA or by a state with an OSHA-approved state plan. In addition, the Act’s General Duty Clause, Section 5(a)(1), requires employers to provide their employees with a workplace free from recognized hazards likely to cause death or serious physical harm.

Material contained in this publication is in the public domain and may be reproduced, fully or partially, without permission. Source credit is requested but not required.

This information will be made available to sensory-impaired individuals upon request. Voice phone: (202) 693-1999; teletypewriter (TTY) number: 1-877-889-5627.

Guidance on Preparing Workplaces for COVID-19

U.S. Department of Labor
Occupational Safety and Health Administration

OSHA 3990-03 2020



U.S. Department of Labor

Contents

Introduction	3
About COVID-19	4
How a COVID-19 Outbreak Could Affect Workplaces	6
Steps All Employers Can Take to Reduce Workers' Risk of Exposure to SARS-CoV-2	7
Classifying Worker Exposure to SARS-CoV-2	18
Jobs Classified at Lower Exposure Risk (Caution): What to Do to Protect Workers	20
Jobs Classified at Medium Exposure Risk: What to Do to Protect Workers	21
Jobs Classified at High or Very High Exposure Risk: What to Do to Protect Workers	23
Workers Living Abroad or Travelling Internationally	25
For More Information	26
OSHA Assistance, Services, and Programs	27
OSHA Regional Offices	29
How to Contact OSHA	32

Introduction

Coronavirus Disease 2019 (COVID-19) is a respiratory disease caused by the SARS-CoV-2 virus. It has spread from China to many other countries around the world, including the United States. Depending on the severity of COVID-19's international impacts, outbreak conditions—including those rising to the level of a pandemic—can affect all aspects of daily life, including travel, trade, tourism, food supplies, and financial markets.

To reduce the impact of COVID-19 outbreak conditions on businesses, workers, customers, and the public, it is important for all employers to plan now for COVID-19. For employers who have already planned for influenza pandemics, planning for COVID-19 may involve updating plans to address the specific exposure risks, sources of exposure, routes of transmission, and other unique characteristics of SARS-CoV-2 (i.e., compared to pandemic influenza viruses). Employers who have not prepared for pandemic events should prepare themselves and their workers as far in advance as possible of potentially worsening outbreak conditions. Lack of continuity planning can result in a cascade of failures as employers attempt to address challenges of COVID-19 with insufficient resources and workers who might not be adequately trained for jobs they may have to perform under pandemic conditions.

The Occupational Safety and Health Administration (OSHA) developed this COVID-19 planning guidance based on traditional infection prevention and industrial hygiene practices. It focuses on the need for employers to implement engineering, administrative, and work practice controls and personal protective equipment (PPE), as well as considerations for doing so.

This guidance is intended for planning purposes. Employers and workers should use this planning guidance to help identify risk levels in workplace settings and to determine any appropriate control measures to implement. Additional guidance may be needed as COVID-19 outbreak conditions change, including as new information about the virus, its transmission, and impacts, becomes available.

The U.S. Department of Health and Human Services' Centers for Disease Control and Prevention (CDC) provides the latest information about COVID-19 and the global outbreak: www.cdc.gov/coronavirus/2019-ncov.

The OSHA COVID-19 webpage offers information specifically for workers and employers: www.osha.gov/covid-19.

This guidance is advisory in nature and informational in content. It is not a standard or a regulation, and it neither creates new legal obligations nor alters existing obligations created by OSHA standards or the *Occupational Safety and Health Act* (OSH Act). Pursuant to the OSH Act, employers must comply with safety and health standards and regulations issued and enforced either by OSHA or by an OSHA-approved State Plan. In addition, the OSH Act's General Duty Clause, [Section 5\(a\)\(1\)](#), requires employers to provide their employees with a workplace free from recognized hazards likely to cause death or serious physical harm. OSHA-approved State Plans may have standards, regulations and enforcement policies that are different from, but at least as effective as, OSHA's. Check with your [State Plan](#), as applicable, for more information.

About COVID-19

Symptoms of COVID-19

Infection with SARS-CoV-2, the virus that causes COVID-19, can cause illness ranging from mild to severe and, in some cases, can be fatal. Symptoms typically include fever, cough, and shortness of breath. Some people infected with the virus have reported experiencing other non-respiratory symptoms. Other people, referred to as *asymptomatic cases*, have experienced no symptoms at all.

According to the CDC, symptoms of COVID-19 may appear in as few as 2 days or as long as 14 days after exposure.

How COVID-19 Spreads

Although the first human cases of COVID-19 likely resulted from exposure to infected animals, infected people can spread SARS-CoV-2 to other people.

The virus is thought to spread mainly from person-to-person, including:

- Between people who are in close contact with one another (within about 6 feet).
- Through respiratory droplets produced when an infected person coughs or sneezes. These droplets can land in the mouths or noses of people who are nearby or possibly be inhaled into the lungs.

Medium exposure risk jobs include those that require frequent and/or close contact with (i.e., within 6 feet of) other people who may be infected with SARS-CoV-2.

It may be possible that a person can get COVID-19 by touching a surface or object that has SARS-CoV-2 on it and then touching their own mouth, nose, or possibly their eyes, but this is not thought to be the primary way the virus spreads.

People are thought to be most contagious when they are most symptomatic (i.e., experiencing fever, cough, and/or shortness of breath). Some spread might be possible before people show symptoms; there have been reports of this type of asymptomatic transmission with this new coronavirus, but this is also not thought to be the main way the virus spreads.

Although the United States has implemented public health measures to limit the spread of the virus, it is likely that some person-to-person transmission will continue to occur.

The CDC website provides the latest information about COVID-19 transmission: www.cdc.gov/coronavirus/2019-ncov/about/transmission.html.

How a COVID-19 Outbreak Could Affect Workplaces

Similar to influenza viruses, SARS-CoV-2, the virus that causes COVID-19, has the potential to cause extensive outbreaks. Under conditions associated with widespread person-to-person spread, multiple areas of the United States and other countries may see impacts at the same time. In the absence of a vaccine, an outbreak may also be an extended event. As a result, workplaces may experience:

- **Absenteeism.** Workers could be absent because they are sick; are caregivers for sick family members; are caregivers for children if schools or day care centers are closed; have at-risk people at home, such as immunocompromised family members; or are afraid to come to work because of fear of possible exposure.
- **Change in patterns of commerce.** Consumer demand for items related to infection prevention (e.g., respirators) is likely to increase significantly, while consumer interest in other goods may decline. Consumers may also change shopping patterns because of a COVID-19 outbreak. Consumers may try to shop at off-peak hours to reduce contact with other people, show increased interest in home delivery services, or prefer other options, such as drive-through service, to reduce person-to-person contact.
- **Interrupted supply/delivery.** Shipments of items from geographic areas severely affected by COVID-19 may be delayed or cancelled with or without notification.

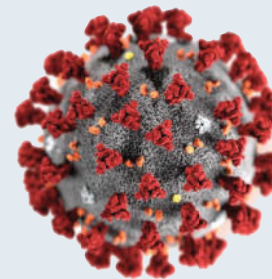

This illustration, created at the Centers for Disease Control and Prevention (CDC), reveals ultrastructural morphology exhibited by the 2019 Novel Coronavirus (2019-nCoV). Note the spikes that adorn the outer surface of the virus, which impart the look of a corona surrounding the virion, when viewed electron microscopically. This virus was identified as the cause of an outbreak of respiratory illness first detected in Wuhan, China.

Photo: CDC / Alissa Eckert & Dan Higgins

Steps All Employers Can Take to Reduce Workers' Risk of Exposure to SARS-CoV-2

This section describes basic steps that every employer can take to reduce the risk of worker exposure to SARS-CoV-2, the virus that causes COVID-19, in their workplace. Later sections of this guidance—including those focusing on jobs classified as having low, medium, high, and very high exposure risks—provide specific recommendations for employers and workers within specific risk categories.

Develop an Infectious Disease Preparedness and Response Plan

If one does not already exist, develop an infectious disease preparedness and response plan that can help guide protective actions against COVID-19.

Stay abreast of guidance from federal, state, local, tribal, and/or territorial health agencies, and consider how to incorporate those recommendations and resources into workplace-specific plans.

Plans should consider and address the level(s) of risk associated with various worksites and job tasks workers perform at those sites. Such considerations may include:

- Where, how, and to what sources of SARS-CoV-2 might workers be exposed, including:
 - The general public, customers, and coworkers; and
 - Sick individuals or those at particularly high risk of infection (e.g., international travelers who have visited locations with widespread sustained (ongoing) COVID-19 transmission, healthcare workers who have had unprotected exposures to people known to have, or suspected of having, COVID-19).
- Non-occupational risk factors at home and in community settings.

- Workers' individual risk factors (e.g., older age; presence of chronic medical conditions, including immunocompromising conditions; pregnancy).
- Controls necessary to address those risks.

Follow federal and state, local, tribal, and/or territorial (SLTT) recommendations regarding development of contingency plans for situations that may arise as a result of outbreaks, such as:

- Increased rates of worker absenteeism.
- The need for social distancing, staggered work shifts, downsizing operations, delivering services remotely, and other exposure-reducing measures.
- Options for conducting essential operations with a reduced workforce, including cross-training workers across different jobs in order to continue operations or deliver surge services.
- Interrupted supply chains or delayed deliveries.

Plans should also consider and address the other steps that employers can take to reduce the risk of worker exposure to SARS-CoV-2 in their workplace, described in the sections below.

Prepare to Implement Basic Infection Prevention Measures

For most employers, protecting workers will depend on emphasizing basic infection prevention measures. As appropriate, all employers should implement good hygiene and infection control practices, including:

- Promote frequent and thorough [hand washing](#), including by providing workers, customers, and worksite visitors with a place to wash their hands. If soap and running water are not immediately available, provide alcohol-based hand rubs containing at least 60% alcohol.
- Encourage workers to [stay home if they are sick](#).
- Encourage [respiratory etiquette](#), including covering coughs and sneezes.

- Provide customers and the public with tissues and trash receptacles.
- Employers should explore whether they can establish [policies and practices](#), such as flexible worksites (e.g., telecommuting) and flexible work hours (e.g., staggered shifts), to increase the physical distance among employees and between employees and others if state and local health authorities recommend the use of social distancing strategies.
- Discourage workers from using other workers' phones, desks, offices, or other work tools and equipment, when possible.
- Maintain regular housekeeping practices, including routine cleaning and disinfecting of surfaces, equipment, and other elements of the work environment. When choosing cleaning chemicals, employers should consult information on Environmental Protection Agency (EPA)-approved disinfectant labels with claims against emerging viral pathogens. Products with EPA-approved emerging viral pathogens claims are expected to be effective against SARS-CoV-2 based on data for harder to kill viruses. Follow the manufacturer's instructions for use of all cleaning and disinfection products (e.g., concentration, application method and contact time, PPE).

Develop Policies and Procedures for Prompt Identification and Isolation of Sick People, if Appropriate

- Prompt identification and isolation of potentially infectious individuals is a critical step in protecting workers, customers, visitors, and others at a worksite.
- Employers should inform and encourage employees to self-monitor for signs and symptoms of COVID-19 if they suspect possible exposure.
- Employers should develop policies and procedures for employees to report when they are sick or experiencing symptoms of COVID-19.

- Where appropriate, employers should develop policies and procedures for immediately isolating people who have [signs and/or symptoms](#) of COVID-19, and train workers to implement them. Move potentially infectious people to a location away from workers, customers, and other visitors. Although most worksites do not have specific isolation rooms, designated areas with closable doors may serve as isolation rooms until potentially sick people can be removed from the worksite.
- Take steps to limit spread of the respiratory secretions of a person who may have COVID-19. Provide a face mask, if feasible and available, and ask the person to wear it, if tolerated. Note: A face mask (also called a surgical mask, procedure mask, or other similar terms) on a patient or other sick person should not be confused with PPE for a worker; the mask acts to contain potentially infectious respiratory secretions at the source (i.e., the person's nose and mouth).
- If possible, isolate people suspected of having COVID-19 separately from those with confirmed cases of the virus to prevent further transmission—particularly in worksites where medical screening, triage, or healthcare activities occur, using either permanent (e.g., wall/different room) or temporary barrier (e.g., plastic sheeting).
- Restrict the number of personnel entering isolation areas.
- Protect workers in close contact with (i.e., within 6 feet of) a sick person or who have prolonged/repeated contact with such persons by using additional engineering and administrative controls, safe work practices, and PPE. Workers whose activities involve close or prolonged/repeated contact with sick people are addressed further in later sections covering workplaces classified at medium and very high or high exposure risk.

Develop, Implement, and Communicate about Workplace Flexibilities and Protections

- Actively encourage sick employees to stay home.
- Ensure that sick leave policies are flexible and consistent with public health guidance and that employees are aware of these policies.
- Talk with companies that provide your business with contract or temporary employees about the importance of sick employees staying home and encourage them to develop non-punitive leave policies.
- Do not require a healthcare provider's note for employees who are sick with acute respiratory illness to validate their illness or to return to work, as healthcare provider offices and medical facilities may be extremely busy and not able to provide such documentation in a timely way.
- Maintain flexible policies that permit employees to stay home to care for a sick family member. Employers should be aware that more employees may need to stay at home to care for sick children or other sick family members than is usual.
- Recognize that workers with ill family members may need to stay home to care for them. See CDC's Interim Guidance for Preventing the Spread of COVID-19 in Homes and Residential Communities: www.cdc.gov/coronavirus/2019-ncov/hcp/guidance-prevent-spread.html.
- Be aware of workers' concerns about pay, leave, safety, health, and other issues that may arise during infectious disease outbreaks. Provide adequate, usable, and appropriate training, education, and informational material about business-essential job functions and worker health and safety, including proper hygiene practices and the use of any workplace controls (including PPE). Informed workers who feel safe at work are less likely to be unnecessarily absent.

- Work with insurance companies (e.g., those providing employee health benefits) and state and local health agencies to provide information to workers and customers about medical care in the event of a COVID-19 outbreak.

Implement Workplace Controls

Occupational safety and health professionals use a framework called the "hierarchy of controls" to select ways of controlling workplace hazards. In other words, the best way to control a hazard is to systematically remove it from the workplace, rather than relying on workers to reduce their exposure. During a COVID-19 outbreak, when it may not be possible to eliminate the hazard, the most effective protection measures are (listed from most effective to least effective): engineering controls, administrative controls, safe work practices (a type of administrative control), and PPE. There are advantages and disadvantages to each type of control measure when considering the ease of implementation, effectiveness, and cost. In most cases, a combination of control measures will be necessary to protect workers from exposure to SARS-CoV-2.

In addition to the types of workplace controls discussed below, CDC guidance for businesses provides employers and workers with recommended SARS-CoV-2 infection prevention strategies to implement in workplaces: www.cdc.gov/coronavirus/2019-ncov/specific-groups/guidance-business-response.html.

Engineering Controls

Engineering controls involve isolating employees from work-related hazards. In workplaces where they are appropriate, these types of controls reduce exposure to hazards without relying on worker behavior and can be the most cost-effective solution to implement. Engineering controls for SARS-CoV-2 include:

- Installing high-efficiency air filters.
- Increasing ventilation rates in the work environment.
- Installing physical barriers, such as clear plastic sneeze guards.

- Installing a drive-through window for customer service.
- Specialized negative pressure ventilation in some settings, such as for aerosol generating procedures (e.g., airborne infection isolation rooms in healthcare settings and specialized autopsy suites in mortuary settings).

Administrative Controls

Administrative controls require action by the worker or employer. Typically, administrative controls are changes in work policy or procedures to reduce or minimize exposure to a hazard. Examples of administrative controls for SARS-CoV-2 include:

- Encouraging sick workers to stay at home.
- Minimizing contact among workers, clients, and customers by replacing face-to-face meetings with virtual communications and implementing telework if feasible.
- Establishing alternating days or extra shifts that reduce the total number of employees in a facility at a given time, allowing them to maintain distance from one another while maintaining a full onsite work week.
- Discontinuing nonessential travel to locations with ongoing COVID-19 outbreaks. Regularly check CDC travel warning levels at: www.cdc.gov/coronavirus/2019-ncov/travelers.
- Developing emergency communications plans, including a forum for answering workers' concerns and internet-based communications, if feasible.
- Providing workers with up-to-date education and training on COVID-19 risk factors and protective behaviors (e.g., cough etiquette and care of PPE).
- Training workers who need to use protecting clothing and equipment how to put it on, use/wear it, and take it off correctly, including in the context of their current and potential duties. Training material should be easy to understand and available in the appropriate language and literacy level for all workers.

Safe Work Practices

Safe work practices are types of administrative controls that include procedures for safe and proper work used to reduce the duration, frequency, or intensity of exposure to a hazard. Examples of safe work practices for SARS-CoV-2 include:

- Providing resources and a work environment that promotes personal hygiene. For example, provide tissues, no-touch trash cans, hand soap, alcohol-based hand rubs containing at least 60 percent alcohol, disinfectants, and disposable towels for workers to clean their work surfaces.
- Requiring regular hand washing or using of alcohol-based hand rubs. Workers should always wash hands when they are visibly soiled and after removing any PPE.
- Post handwashing signs in restrooms.

Personal Protective Equipment (PPE)

While engineering and administrative controls are considered more effective in minimizing exposure to SARS-CoV-2, PPE may also be needed to prevent certain exposures. While correctly using PPE can help prevent some exposures, it should not take the place of other prevention strategies.

Examples of PPE include: gloves, goggles, face shields, face masks, and respiratory protection, when appropriate. During an outbreak of an infectious disease, such as COVID-19, recommendations for PPE specific to occupations or job tasks may change depending on geographic location, updated risk assessments for workers, and information on PPE effectiveness in preventing the spread of COVID-19. Employers should check the [OSHA](https://www.osha-slc.gov) and [CDC](https://www.cdc.gov) websites regularly for updates about recommended PPE.

All types of PPE must be:

- Selected based upon the hazard to the worker.
- Properly fitted and periodically refitted, as applicable (e.g., respirators).

- Consistently and properly worn when required.
- Regularly inspected, maintained, and replaced, as necessary.
- Properly removed, cleaned, and stored or disposed of, as applicable, to avoid contamination of self, others, or the environment.

Employers are obligated to provide their workers with PPE needed to keep them safe while performing their jobs. The types of PPE required during a COVID-19 outbreak will be based on the risk of being infected with SARS-CoV-2 while working and job tasks that may lead to exposure.

Workers, including those who work within 6 feet of patients known to be, or suspected of being, infected with SARS-CoV-2 and those performing aerosol-generating procedures, need to use respirators:

- National Institute for Occupational Safety and Health (NIOSH)-approved, N95 filtering facepiece respirators or better must be used in the context of a comprehensive, written respiratory protection program that includes fit-testing, training, and medical exams. See OSHA's Respiratory Protection standard, 29 CFR 1910.134 at www.osha.gov/laws-regs/regulations/standardnumber/1910/1910.134.
- When disposable N95 filtering facepiece respirators are not available, consider using other respirators that provide greater protection and improve worker comfort. Other types of acceptable respirators include: a R/P95, N/R/P99, or N/R/P100 filtering facepiece respirator; an air-purifying elastomeric (e.g., half-face or full-face) respirator with appropriate filters or cartridges; powered air purifying respirator (PAPR) with high-efficiency particulate arrestance (HEPA) filter; or supplied air respirator (SAR). See CDC/NIOSH guidance for optimizing respirator supplies at: www.cdc.gov/coronavirus/2019-ncov/hcp/respirators-strategy.

- Consider using PAPRs or SARs, which are more protective than filtering facepiece respirators, for any work operations or procedures likely to generate aerosols (e.g., cough induction procedures, some dental procedures, invasive specimen collection, blowing out pipettes, shaking or vortexing tubes, filling a syringe, centrifugation).
- Use a surgical N95 respirator when both respiratory protection and resistance to blood and body fluids is needed.
- Face shields may also be worn on top of a respirator to prevent bulk contamination of the respirator. Certain respirator designs with forward protrusions (duckbill style) may be difficult to properly wear under a face shield. Ensure that the face shield does not prevent airflow through the respirator.
- Consider factors such as function, fit, ability to decontaminate, disposal, and cost. OSHA's Respiratory Protection eTool provides basic information on respirators such as medical requirements, maintenance and care, fit testing, written respiratory protection programs, and voluntary use of respirators, which employers may also find beneficial in training workers at: www.osha.gov/SLTC/etools/respiratory. Also see NIOSH respirator guidance at: www.cdc.gov/niosh/topics/respirators.
- Respirator training should address selection, use (including donning and doffing), proper disposal or disinfection, inspection for damage, maintenance, and the limitations of respiratory protection equipment. Learn more at: www.osha.gov/SLTC/respiratoryprotection.
- The appropriate form of respirator will depend on the type of exposure and on the transmission pattern of COVID-19. See the NIOSH "Respirator Selection Logic" at: www.cdc.gov/niosh/docs/2005-100/default.html or the OSHA "Respiratory Protection eTool" at www.osha.gov/SLTC/etools/respiratory.

Follow Existing OSHA Standards

Existing OSHA standards may apply to protecting workers from exposure to and infection with SARS-CoV-2.

While there is no specific OSHA standard covering SARS-CoV-2 exposure, some OSHA requirements may apply to preventing occupational exposure to SARS-CoV-2. Among the most relevant are:

- OSHA's Personal Protective Equipment (PPE) standards (in general industry, 29 CFR 1910 Subpart I), which require using gloves, eye and face protection, and respiratory protection. See: www.osha.gov/laws-regs/regulations/standardnumber/1910#1910_Subpart_I.
 - When respirators are necessary to protect workers or where employers require respirator use, employers must implement a comprehensive respiratory protection program in accordance with the Respiratory Protection standard (29 CFR 1910.134). See: www.osha.gov/laws-regs/regulations/standardnumber/1910/1910.134.
- The General Duty Clause, Section 5(a)(1) of the Occupational Safety and Health (OSH) Act of 1970, 29 USC 654(a)(1), which requires employers to furnish to each worker "employment and a place of employment, which are free from recognized hazards that are causing or are likely to cause death or serious physical harm." See: www.osha.gov/laws-regs/oshact/completeoshact.

OSHA's Bloodborne Pathogens standard (29 CFR 1910.1030) applies to occupational exposure to human blood and other potentially infectious materials that typically do not include respiratory secretions that may transmit SARS-CoV-2. However, the provisions of the standard offer a framework that may help control some sources of the virus, including exposures to body fluids (e.g., respiratory secretions) not covered by the standard. See: www.osha.gov/laws-regs/regulations/standardnumber/1910/1910.1030.

The OSHA COVID-19 webpage provides additional information about OSHA standards and requirements, including requirements in states that operate their own OSHA-approved State Plans, recordkeeping requirements and injury/illness recording criteria, and applications of standards related to sanitation and communication of risks related to hazardous chemicals that may be in common sanitizers and sterilizers. See: www.osha.gov/SLTC/covid-19/standards.html.

Classifying Worker Exposure to SARS-CoV-2

Worker risk of occupational exposure to SARS-CoV-2, the virus that causes COVID-19, during an outbreak may vary from very high to high, medium, or lower (caution) risk. The level of risk depends in part on the industry type, need for contact within 6 feet of people known to be, or suspected of being, infected with SARS-CoV-2, or requirement for repeated or extended contact with persons known to be, or suspected of being, infected with SARS-CoV-2. To help employers determine appropriate precautions, OSHA has divided job tasks into four risk exposure levels: very high, high, medium, and lower risk. The Occupational Risk Pyramid shows the four exposure risk levels in the shape of a pyramid to represent probable distribution of risk. Most American workers will likely fall in the lower exposure risk (caution) or medium exposure risk levels.

**Occupational Risk Pyramid
for COVID-19**

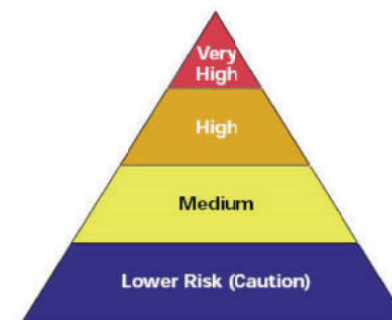

Very High Exposure Risk

Very high exposure risk jobs are those with high potential for exposure to known or suspected sources of COVID-19 during specific medical, postmortem, or laboratory procedures.

Workers in this category include:

- Healthcare workers (e.g., doctors, nurses, dentists, paramedics, emergency medical technicians) performing aerosol-generating procedures (e.g., intubation, cough induction procedures, bronchoscopies, some dental procedures and exams, or invasive specimen collection) on known or suspected COVID-19 patients.
- Healthcare or laboratory personnel collecting or handling specimens from known or suspected COVID-19 patients (e.g., manipulating cultures from known or suspected COVID-19 patients).
- Morgue workers performing autopsies, which generally involve aerosol-generating procedures, on the bodies of people who are known to have, or suspected of having, COVID-19 at the time of their death.

High Exposure Risk

High exposure risk jobs are those with high potential for exposure to known or suspected sources of COVID-19. Workers in this category include:

- Healthcare delivery and support staff (e.g., doctors, nurses, and other hospital staff who must enter patients' rooms) exposed to known or suspected COVID-19 patients. (Note: when such workers perform aerosol-generating procedures, their exposure risk level becomes *very high*.)
- Medical transport workers (e.g., ambulance vehicle operators) moving known or suspected COVID-19 patients in enclosed vehicles.
- Mortuary workers involved in preparing (e.g., for burial or cremation) the bodies of people who are known to have, or suspected of having, COVID-19 at the time of their death.

Medium Exposure Risk

Medium exposure risk jobs include those that require frequent and/or close contact with (i.e., within 6 feet of) people who may be infected with SARS-CoV-2, but who are not known or suspected COVID-19 patients. In areas without ongoing community transmission, workers in this risk group may have frequent contact with travelers who may return from international locations with widespread COVID-19 transmission. In areas where there *is* ongoing community transmission, workers in this category may have contact with the general public (e.g., schools, high-population-density work environments, some high-volume retail settings).

Lower Exposure Risk (Caution)

Lower exposure risk (caution) jobs are those that do not require contact with people known to be, or suspected of being, infected with SARS-CoV-2 nor frequent close contact with (i.e., within 6 feet of) the general public. Workers in this category have minimal occupational contact with the public and other coworkers.

Jobs Classified at Lower Exposure Risk (Caution): What to Do to Protect Workers

For workers who do not have frequent contact with the general public, employers should follow the guidance for "[Steps All Employers Can Take to Reduce Workers' Risk of Exposure to SARS-CoV-2](#)," on page 7 of this booklet and implement control measures described in this section.

Engineering Controls

Additional engineering controls are not recommended for workers in the lower exposure risk group. Employers should ensure that engineering controls, if any, used to protect workers from other job hazards continue to function as intended.

Administrative Controls

- Monitor public health communications about COVID-19 recommendations and ensure that workers have access to that information. Frequently check the CDC COVID-19 website: www.cdc.gov/coronavirus/2019-ncov.
- Collaborate with workers to designate effective means of communicating important COVID-19 information.

Personal Protective Equipment

Additional PPE is not recommended for workers in the lower exposure risk group. Workers should continue to use the PPE, if any, that they would ordinarily use for other job tasks.

Jobs Classified at Medium Exposure Risk: What to Do to Protect Workers

In workplaces where workers have medium exposure risk, employers should follow the guidance for “[Steps All Employers Can Take to Reduce Workers’ Risk of Exposure to SARS-CoV-2](#),” on page 7 of this booklet and implement control measures described in this section.

Engineering Controls

- Install physical barriers, such as clear plastic sneeze guards, where feasible.

Administrative Controls

- Consider offering face masks to ill employees and customers to contain respiratory secretions until they are able leave the workplace (i.e., for medical evaluation/care or to return home). In the event of a shortage of masks, a reusable face shield that can be decontaminated may be an acceptable method of protecting against droplet transmission. See CDC/NIOSH guidance for optimizing respirator supplies, which discusses the use of surgical masks, at: www.cdc.gov/coronavirus/2019-ncov/hcp/respirators-strategy.

- Keep customers informed about symptoms of COVID-19 and ask sick customers to minimize contact with workers until healthy again, such as by posting signs about COVID-19 in stores where sick customers may visit (e.g., pharmacies) or including COVID-19 information in automated messages sent when prescriptions are ready for pick up.
- Where appropriate, limit customers’ and the public’s access to the worksite, or restrict access to only certain workplace areas.
- Consider strategies to minimize face-to-face contact (e.g., drive-through windows, phone-based communication, telework).
- Communicate the availability of medical screening or other worker health resources (e.g., on-site nurse; telemedicine services).

Personal Protective Equipment (PPE)

When selecting PPE, consider factors such as function, fit, decontamination ability, disposal, and cost. Sometimes, when PPE will have to be used repeatedly for a long period of time, a more expensive and durable type of PPE may be less expensive overall than disposable PPE. Each employer should select the combination of PPE that protects workers specific to their workplace.

Workers with medium exposure risk may need to wear some combination of gloves, a gown, a face mask, and/or a face shield or goggles. PPE ensembles for workers in the medium exposure risk category will vary by work task, the results of the employer’s hazard assessment, and the types of exposures workers have on the job.

High exposure risk jobs are those with high potential for exposure to known or suspected sources of COVID-19.

Very high exposure risk jobs are those with high potential for exposure to known or suspected sources of COVID-19 during specific medical, postmortem, or laboratory procedures that involve aerosol generation or specimen collection/handling.

In rare situations that would require workers in this risk category to use respirators, see the PPE section beginning on [page 14](#) of this booklet, which provides more details about respirators. For the most up-to-date information, visit OSHA's COVID-19 webpage: www.osha.gov/covid-19.

Jobs Classified at High or Very High Exposure Risk: What to Do to Protect Workers

In workplaces where workers have high or very high exposure risk, employers should follow the guidance for “[Steps All Employers Can Take to Reduce Workers’ Risk of Exposure to SARS-CoV-2](#),” on page 7 of this booklet and implement control measures described in this section.

Engineering Controls

- Ensure appropriate air-handling systems are installed and maintained in healthcare facilities. See “Guidelines for Environmental Infection Control in Healthcare Facilities” for more recommendations on air handling systems at: www.cdc.gov/mmwr/preview/mmwrhtml/rr5210a1.htm.
- CDC recommends that patients with known or suspected COVID-19 (i.e., person under investigation) should be placed in an airborne infection isolation room (AIIR), if available.
- Use isolation rooms when available for performing aerosol-generating procedures on patients with known or suspected COVID-19. For postmortem activities, use autopsy suites or other similar isolation facilities when performing aerosol-generating procedures on the bodies of people who are known to have, or suspected of having, COVID-19 at the time of their death. See the CDC postmortem guidance at: www.cdc.gov/coronavirus/2019-ncov/hcp/guidance-postmortem-specimens.html. OSHA also provides guidance for postmortem activities on its COVID-19 webpage: www.osha.gov/covid-19.

- Use special precautions associated with Biosafety Level 3 when handling specimens from known or suspected COVID-19 patients. For more information about biosafety levels, consult the U.S. Department of Health and Human Services (HHS) “Biosafety in Microbiological and Biomedical Laboratories” at www.cdc.gov/biosafety/publications/bmbl5.

Administrative Controls

If working in a healthcare facility, follow existing guidelines and facility standards of practice for identifying and isolating infected individuals and for protecting workers.

- Develop and implement policies that reduce exposure, such as cohorting (i.e., grouping) COVID-19 patients when single rooms are not available.
- Post signs requesting patients and family members to immediately report symptoms of respiratory illness on arrival at the healthcare facility and use disposable face masks.
- Consider offering enhanced medical monitoring of workers during COVID-19 outbreaks.
- Provide all workers with job-specific education and training on preventing transmission of COVID-19, including initial and routine/refresher training.
- Ensure that psychological and behavioral support is available to address employee stress.

Safe Work Practices

- Provide emergency responders and other essential personnel who may be exposed while working away from fixed facilities with alcohol-based hand rubs containing at least 60% alcohol for decontamination in the field.

Personal Protective Equipment (PPE)

Most workers at high or very high exposure risk likely need to wear gloves, a gown, a face shield or goggles, and either a face mask or a respirator, depending on their job tasks and exposure risks.

Those who work closely with (either in contact with or within 6 feet of) patients known to be, or suspected of being, infected with SARS-CoV-2, the virus that causes COVID-19, should wear respirators. In these instances, see the PPE section beginning on [page 14](#) of this booklet, which provides more details about respirators. For the most up-to-date information, also visit OSHA's COVID-19 webpage: www.osha.gov/covid-19.

PPE ensembles may vary, especially for workers in laboratories or morgue/mortuary facilities who may need additional protection against blood, body fluids, chemicals, and other materials to which they may be exposed. Additional PPE may include medical/surgical gowns, fluid-resistant coveralls, aprons, or other disposable or reusable protective clothing. Gowns should be large enough to cover the areas requiring protection. OSHA may also provide updated guidance for PPE use on its website: www.osha.gov/covid-19.

NOTE: Workers who dispose of PPE and other infectious waste must also be trained and provided with appropriate PPE.

The CDC webpage "Healthcare-associated Infections" (www.cdc.gov/hai) provides additional information on infection control in healthcare facilities.

Workers Living Abroad or Travelling Internationally

Employers with workers living abroad or traveling on international business should consult the "Business Travelers" section of the OSHA COVID-19 webpage (www.osha.gov/covid-19), which also provides links to the latest:

- CDC travel warnings: www.cdc.gov/coronavirus/2019-ncov/travelers
- U.S. Department of State (DOS) travel advisories: travel.state.gov

Employers should communicate to workers that the DOS cannot provide Americans traveling or living abroad with medications or supplies, even in the event of a COVID-19 outbreak.

As COVID-19 outbreak conditions change, travel into or out of a country may not be possible, safe, or medically advisable. It is also likely that governments will respond to a COVID-19 outbreak by imposing public health measures that restrict domestic and international movement, further limiting the U.S. government's ability to assist Americans in these countries. It is important that employers and workers plan appropriately, as it is possible that these measures will be implemented very quickly in the event of worsening outbreak conditions in certain areas.

More information on COVID-19 planning for workers living and traveling abroad can be found at: www.cdc.gov/travel.

For More Information

Federal, state, and local government agencies are the best source of information in the event of an infectious disease outbreak, such as COVID-19. Staying informed about the latest developments and recommendations is critical, since specific guidance may change based upon evolving outbreak situations.

Below are several recommended websites to access the most current and accurate information:

- Occupational Safety and Health Administration website: www.osha.gov
- Centers for Disease Control and Prevention website: www.cdc.gov
- National Institute for Occupational Safety and Health website: www.cdc.gov/niosh

OSHA Assistance, Services, and Programs

OSHA has a great deal of information to assist employers in complying with their responsibilities under OSHA law. Several OSHA programs and services can help employers identify and correct job hazards, as well as improve their safety and health program.

Establishing a Safety and Health Program

Safety and health programs are systems that can substantially reduce the number and severity of workplace injuries and illnesses, while reducing costs to employers.

Visit www.osha.gov/safetymanagement for more information.

Compliance Assistance Specialists

OSHA compliance assistance specialists can provide information to employers and workers about OSHA standards, short educational programs on specific hazards or OSHA rights and responsibilities, and information on additional compliance assistance resources.

Visit www.osha.gov/complianceassistance/cas or call 1-800-321-OSHA (6742) to contact your local OSHA office.

No-Cost On-Site Safety and Health Consultation Services for Small Business

OSHA's On-Site Consultation Program offers no-cost and confidential advice to small and medium-sized businesses in all states, with priority given to high-hazard worksites. On-Site consultation services are separate from enforcement and do not result in penalties or citations.

For more information or to find the local On-Site Consultation office in your state, visit www.osha.gov/consultation, or call 1-800-321-OSHA (6742).

Under the consultation program, certain exemplary employers may request participation in OSHA's **Safety and Health Achievement Recognition Program (SHARP)**. Worksites that receive SHARP recognition are exempt from programmed inspections during the period that the SHARP certification is valid.

Cooperative Programs

OSHA offers cooperative programs under which businesses, labor groups and other organizations can work cooperatively with OSHA. To find out more about any of the following programs, visit www.osha.gov/cooperativeprograms.

Strategic Partnerships and Alliances

The OSHA Strategic Partnerships (OSP) provide the opportunity for OSHA to partner with employers, workers, professional or trade associations, labor organizations, and/or other interested stakeholders. Through the Alliance Program, OSHA works with groups to develop compliance assistance tools and resources to share with workers and employers, and educate workers and employers about their rights and responsibilities.

Voluntary Protection Programs (VPP)

The VPP recognize employers and workers in the private sector and federal agencies who have implemented effective safety and health programs and maintain injury and illness rates below the national average for their respective industries.

Occupational Safety and Health Training

OSHA partners with 26 OSHA Training Institute Education Centers at 37 locations throughout the United States to deliver courses on OSHA standards and occupational safety and health topics to thousands of students a year. For more information on training courses, visit www.osha.gov/otiec.

OSHA Educational Materials

OSHA has many types of educational materials to assist employers and workers in finding and preventing workplace hazards.

All OSHA publications are free at www.osha.gov/publications and www.osha.gov/ebooks. You can also call 1-800-321-OSHA (6742) to order publications.

Employers and safety and health professionals can sign-up for *QuickTakes*, OSHA's free, twice-monthly online newsletter with the latest news about OSHA initiatives and products to assist in finding and preventing workplace hazards. To sign up, visit www.osha.gov/quicktakes.

OSHA Regional Offices

Region 1

Boston Regional Office
(CT*, ME*, MA, NH, RI, VT*)
JFK Federal Building
25 New Sudbury Street, Room E340
Boston, MA 02203
(617) 565-9860 (617) 565-9827 Fax

Region 2

New York Regional Office
(NJ*, NY*, PR*, VI*)
Federal Building
201 Varick Street, Room 670
New York, NY 10014
(212) 337-2378 (212) 337-2371 Fax

Region 3

Philadelphia Regional Office
(DE, DC, MD*, PA, VA*, WV)
The Curtis Center
170 S. Independence Mall West, Suite 740 West
Philadelphia, PA 19106-3309
(215) 861-4900 (215) 861-4904 Fax

Region 4

Atlanta Regional Office
(AL, FL, GA, KY*, MS, NC*, SC*, TN*)
Sam Nunn Atlanta Federal Center
61 Forsyth Street, SW, Room 6T50
Atlanta, GA 30303
(678) 237-0400 (678) 237-0447 Fax

Region 5

Chicago Regional Office
(IL*, IN*, MI*, MN*, OH, WI)
John C. Kluczynski Federal Building
230 South Dearborn Street, Room 3244
Chicago, IL 60604
(312) 353-2220 (312) 353-7774 Fax

Region 6

Dallas Regional Office
(AR, LA, NM*, OK, TX)
A. Maceo Smith Federal Building
525 Griffin Street, Room 602
Dallas, TX 75202
(972) 850-4145 (972) 850-4149 Fax

Region 7

Kansas City Regional Office
(IA*, KS, MO, NE)
Two Pershing Square Building
2300 Main Street, Suite 1010
Kansas City, MO 64108-2416
(816) 283-8745 (816) 283-0547 Fax

Region 8

Denver Regional Office
(CO, MT, ND, SD, UT*, WY*)
Cesar Chavez Memorial Building
1244 Speer Boulevard, Suite 551
Denver, CO 80204
(720) 264-6550 (720) 264-6585 Fax

Region 9

San Francisco Regional Office
(AZ*, CA*, HI*, NV*, and American Samoa,
Guam and the Northern Mariana Islands)
San Francisco Federal Building
90 7th Street, Suite 2650
San Francisco, CA 94103
(415) 625-2547 (415) 625-2534 Fax

Region 10

Seattle Regional Office
(AK*, ID, OR*, WA*)
Fifth & Yesler Tower
300 Fifth Avenue, Suite 1280
Seattle, WA 98104
(206) 757-6700 (206) 757-6705 Fax

*These states and territories operate their own OSHA-approved job safety and health plans and cover state and local government employees as well as private sector employees. The Connecticut, Illinois, Maine, New Jersey, New York and Virgin Islands programs cover public employees only. (Private sector workers in these states are covered by Federal OSHA). States with approved programs must have standards that are identical to, or at least as effective as, the Federal OSHA standards.

Note: To get contact information for OSHA area offices, OSHA-approved state plans and OSHA consultation projects, please visit us online at www.osha.gov or call us at 1-800-321-OSHA (6742).

How to Contact OSHA

Under the Occupational Safety and Health Act of 1970, employers are responsible for providing safe and healthful workplaces for their employees. OSHA's role is to help ensure these conditions for America's working men and women by setting and enforcing standards, and providing training, education and assistance. For more information, visit www.osha.gov or call OSHA at 1-800-321-OSHA (6742), TTY 1-877-889-5627.

**For assistance, contact us.
We are OSHA. We can help.**





U.S. Department of Labor

For more information:

OSHA[®] Occupational
Safety and Health
Administration

www.osha.gov (800) 321-OSHA (6742)