



SDMS DocID **47203**

October 1997

SITE 7.5.HS
FILE
COPY

Report on the Effects of the Hot Spot Dredging Operations
New Bedford Harbor Superfund Site
New Bedford, Massachusetts



Originals in color.

Report on the Effects of the Hot Spot Dredging Operations
New Bedford Harbor Superfund Site

Table of Contents

I.	Executive Summary	1-1
II.	Summary of the Environmental Effects of the Hot Spot Dredging Program	2-1
	A. Introduction	2-1
	B. Methods	2-1
	C. Results and Discussion	2-12
	D. Conclusions	2-10
III.	Summary of the Effects of Dredging and CDF Disposal on Air Quality	3-1
	A. Introduction	3-1
	B. Methods	3-1
	C. Results and Discussion	3-4
	D. Conclusions	3-9
IV.	Summary of the Effects of CDF Effluent on Water Quality...	4-1
	A. Introduction	4-1
	B. Methods	4-1
	C. Results and Discussion	4-6
	D. Conclusions	4-10
V.	References	5-1
VI.	Appendices	
	A. Biological Toxicity Testing Data	
	B. Airborne PCB Data Base	
	C. PCB, Cu and Pb Water Quality Data Presented Graphically	

**Report on the Effects of the Hot Spot Dredging Operations
New Bedford Harbor Superfund Site**

List of Figures

Figure 2-1.	New Bedford Harbor Monitoring Stations	2-2
Figure 2-2.	Multi-point Sampling Array at the Coggeshall Street Bridge	2-8
Figure 2-3.	Net Transport of PCBs Under the Coggeshall Street Bridge	2-13
Figure 2-4.	Comparison of Actual Transport During the Hot Spot Remediation with the Maximum Allowable Under the Decision Criteria	2-14
Figure 2-5.	Mean PCB Concentrations in Blue Mussels Deployed for 28 Days at Station NBH-2	2-17
Figure 2-6.	Mean PCB Concentrations in Blue Mussels Deployed for 28 Days at Station NBH-4	2-18
Figure 2-7.	Mean PCB Concentrations in Blue Mussels Deployed for 28 Days at Station NBH-5	2-19
Figure 2-8.	Mean PCB Concentrations in Day-0 Blue Mussels Collected From the East Sandwich Salt Marsh ..	2-20
Figure 3-1.	Location of Ambient Air Monitoring Sites	3-2
Figure 4-1.	Areal Schematic of the Hot Spot CDF	4-2
Figure 4-2.	Hot Spot CDF Discharge Limits	4-3
Figure 4-3.	Hot Spot Water Treatment Plant Schematic	4-5
Figure 4-4.	Hot Spot Treatment Plant PCB Discharges	4-6
Figure 4-5.	Hot Spot Treatment Plant Copper Discharges	4-7
Figure 4-6.	Hot Spot Treatment Plant Lead Discharges	4-8

List of Tables

Table 2-1.	PCB Congeners Measured in the Water Column and Biota in this Study	2-10
Table 2-2.	Synthesis of Toxicity Test Results Relative to Biological Decision Criteria	2-15
Table 2-3.	Mean PCB Concentrations in Mussels Deployed for 28 days at Stations NBH-2, -4 and -5	2-15
Table 3-1.	Airborne PCB Action Levels and Corrective Measures	3-5
Table 3-2.	Summary of Airborne PCB Sampling Results	3-6
Table 3-3.	Typical Percent Composition of Some Commercial PCB Mixtures	3-8
Table 3-4.	Vapor Pressures of Some PCB Congeners	3-8

**Report on the Effects of the Hot Spot Dredging Operations
New Bedford Harbor Superfund Site**

List of Figures

Figure 2-1.	New Bedford Harbor Monitoring Stations	2-2
Figure 2-2.	Multi-point Sampling Array at the Coggeshall Street Bridge	2-8
Figure 2-3.	Net Transport of PCBs Under the Coggeshall Street Bridge	2-13
Figure 2-4.	Comparison of Actual Transport During the Hot Spot Remediation with the Maximum Allowable Under the Decision Criteria	2-14
Figure 2-5.	Mean PCB Concentrations in Blue Mussels Deployed for 28 Days at Station NBH-2	2-17
Figure 2-6.	Mean PCB Concentrations in Blue Mussels Deployed for 28 Days at Station NBH-4	2-18
Figure 2-7.	Mean PCB Concentrations in Blue Mussels Deployed for 28 Days at Station NBH-5	2-19
Figure 2-8.	Mean PCB Concentrations in Day-0 Blue Mussels Collected From the East Sandwich Salt Marsh ..	2-20
Figure 3-1.	Location of Ambient Air Monitoring Sites	3-2
Figure 4-1.	Areal Schematic of the Hot Spot CDF	4-2
Figure 4-2.	Hot Spot CDF Discharge Limits	4-3
Figure 4-3.	Hot Spot Water Treatment Plant Schematic	4-5
Figure 4-4.	Hot Spot Treatment Plant PCB Discharges	4-6
Figure 4-5.	Hot Spot Treatment Plant Copper Discharges	4-7
Figure 4-6.	Hot Spot Treatment Plant Lead Discharges	4-8

List of Tables

Table 2-1.	PCB Congeners Measured in the Water Column and Biota in this Study	2-10
Table 2-2.	Synthesis of Toxicity Test Results Relative to Biological Decision Criteria	2-15
Table 2-3.	Mean PCB Concentrations in Mussels Deployed for 28 days at Stations NBH-2, -4 and -5	2-15
Table 3-1.	Airborne PCB Action Levels and Corrective Measures	3-5
Table 3-2.	Summary of Airborne PCB Sampling Results	3-6
Table 3-3.	Typical Percent Composition of Some Commercial PCB Mixtures	3-8
Table 3-4.	Vapor Pressures of Some PCB Congeners	3-8

I. Executive Summary

Industrial development surrounding New Bedford Harbor in southeastern Massachusetts has resulted in the harbor sediments becoming contaminated with high concentrations of many compounds, including polychlorinated biphenyls (PCBs) to greater than 100,000 ppm (Nelson et al., 1996). As a consequence of this contamination, the harbor and 17,000 acres of adjacent area in Buzzards Bay were finalized on the U.S. Environmental Protection Agency's (EPA's) National Priority List as a Superfund site in 1983. Among other remedial studies, a pilot dredging and disposal study conducted in 1988-1989 determined that hydraulic cutterhead dredging was effective in reducing sediment PCB concentrations and minimizing the release and transport of contaminants to acceptably low levels (USACE, 1990). In 1990, dredging was selected to remove the most contaminated sediments, approximately 5 acres referred to as the hot spots (USEPA, 1990).

Dredging of these hot spot sediments occurred from April 1994 through September 1995. Approximately 14,000 cy of sediments were hydraulically dredged and pumped via floating pipeline to an interim shoreline confined disposal facility (CDF) located about one mile away (Figure 2-1). In order to verify that dredging operations did not present undue risks to human health or the environment, extensive air and water quality monitoring was performed throughout project implementation. This report summarizes the results of these monitoring programs, and reviews the overall adverse effects, or lack thereof, associated with the dredging operations as demonstrated by a comparison of the monitoring results with pre-established control criteria.

The hot spot sediments were situated in a shallow tidal estuarine area where the Acushnet River merges with upper New Bedford Harbor (Figure 2-1). These sediments are generally a fine-sandy silt with some clay, and by definition contained greater than 4,000 ppm (0.4%) total PCBs. Cadmium, chromium, copper and lead were also present at high levels. Removal of the hot spot sediment was estimated to result in removal of approximately 45% of the total mass of PCBs in the harbor (Ebasco, 1989 at ES-2 and 2-6; USEPA, 1990 at 8).

The air and water quality monitoring results discussed herein were reviewed continually throughout implementation to ensure a safe project, and to make operational adjustments as appropriate. In summary, while little if any adverse impacts to the marine ecosystem were found, some issues with air quality arose that were addressed through changes in operation or through engineering controls. Only 10 of over 4,000 airborne PCB samples (0.25%), taken at 16 separate monitoring stations, exceeded the 1 ug/m³ recommended exposure limit (REL) for each individual Aroclor (NIOSH, 1994).

The Record of Decision for this first operable unit at the site originally called for on-site incineration of the dredged hot spot sediments. However, due to a vehement and congressionally supported reversal in public support for incineration at about the mobilization stage, EPA terminated the incineration component of the remedy. EPA is currently developing an alternative treatment or disposal remedy for the dredged sediments. In the interim, the sediments remain stored in the hot spot CDF.

The high degree of public interest in the project also carried over to the dredging portion of the remedy. EPA, the Commonwealth of Massachusetts and the U.S. Army Corps of Engineers (USACE, COE or the Corps) worked extensively with interested local stakeholders throughout project operations to share monitoring data on a quick turn-around basis, and to demonstrate that the project was being performed in an environmentally sound manner.

As with the implementation of the dredging project, production of this report was a collaborative effort between EPA Region I, EPA's Narragansett, RI marine research and development laboratory, USACE and their consultant Roy F. Weston, Inc. Questions regarding this report may be directed to David Dickerson, EPA's Remedial Project Manager for the site at 617/573-5735 or dickerson.dave@epamail.epa.gov.

II. Summary of the Environmental Effects of the Hot Spot Dredging Program

A. Introduction

One of the principal goals of the hot spot dredging program was the removal of a significant percentage of the PCB mass in the upper harbor without causing significant additional risks to human health or the environment. A second objective was to avoid additional remediation in the lower harbor as a result of the dredging program (i.e., contaminant transport to less contaminated areas). A monitoring plan was developed prior to dredging based on these project goals (Nelson, et al., 1994). Specific criteria were established to ensure that this operation did not pose a threat to human health or cause additional environmental damage to New Bedford Harbor (NBH) and adjacent Buzzards Bay.

This section is structured to follow the decision criteria listed in the original monitoring plan. Specific criteria were established for the net transport of PCBs from the upper harbor as well as for selected biological parameters (toxicity tests and bioaccumulation). Chemical and physical criteria addressed concerns with respect to limiting the transport of contaminants from the more severely contaminated upper harbor. Biological criteria, including selected toxicity tests and PCB bioaccumulation in blue and ribbed mussels (Mytilus edulis and Modiolus demissus, respectively), were established to ensure that biota were not adversely affected. In addition, PCBs and metals were monitored in the water column. The specific criteria and methods utilized will be described, followed by a discussion of the results relative to the established criteria. Finally, all the data will be considered relative to the overall project goals, thus providing an information base upon which to assess the success of the Hot Spot dredging project as well as dredging as a remedial option for additional contaminated sediments in NBH.

B. Methods

The location of monitoring stations critical to the environmental criteria, and the rationale for various criteria selection, are described in detail and are similar to those used during the pilot dredging study (Nelson and Hansen, 1991).

Station Location

One fundamental goal associated with decision-making during remediation was to limit contaminant transport, and subsequent effects, from the upper harbor to the lower harbor and Buzzards Bay (Figure 2-1). Therefore, decision criteria were established to limit effects at the same two strategic stations employed in

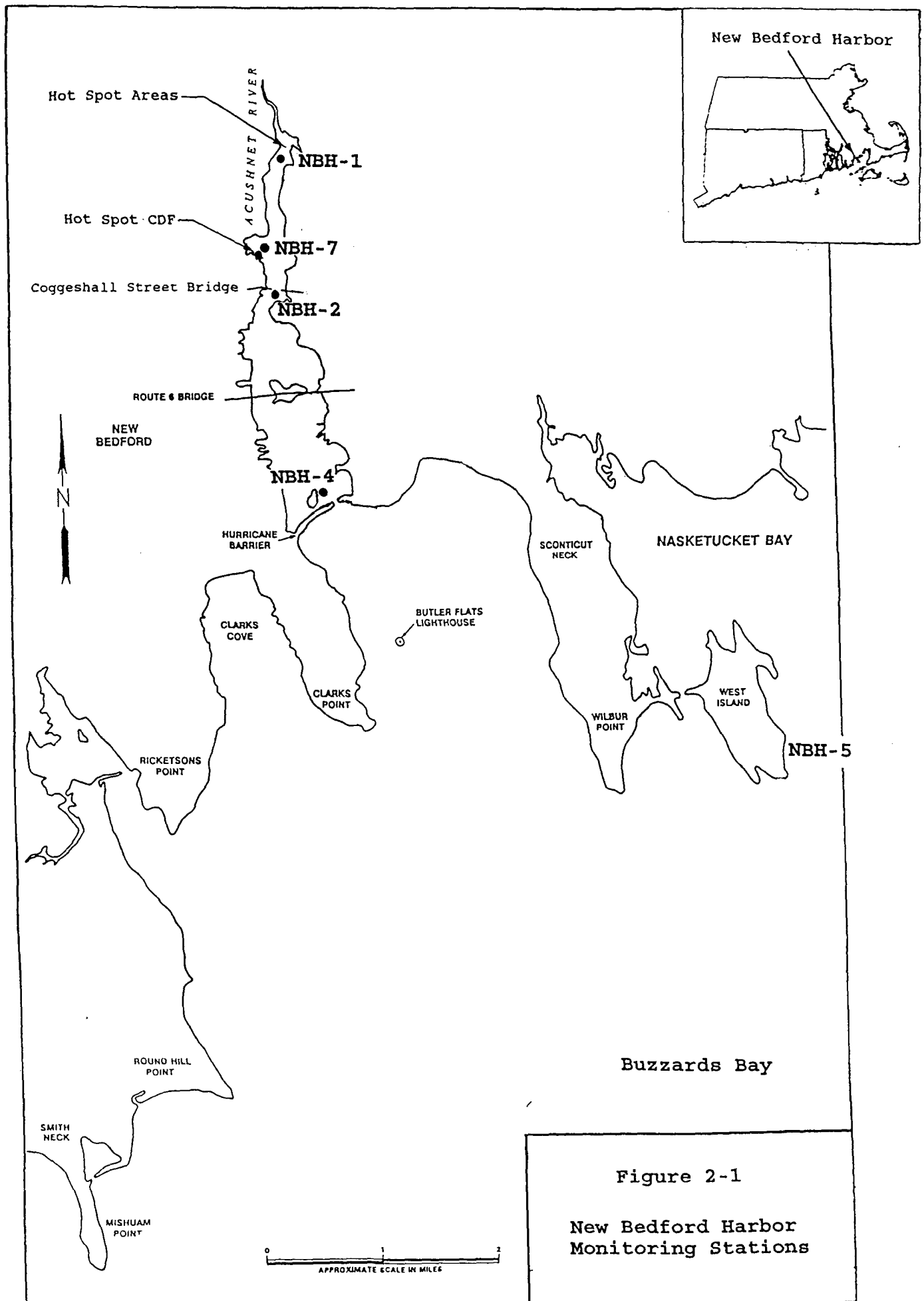

Figure 2-1

New Bedford Harbor
Monitoring Stations

the pilot study, the Coggeshall St. Bridge (NBH-2) and the Hurricane Barrier (NBH-4). Station NBH-2 is positioned at the transition between the upper and lower harbor; criteria were established here to limit the net transport of PCBs to the lower harbor, monitor for significant PCB bioaccumulation in mussels, and monitor for acute toxicity in the water column. At Station NBH-4, the transition point between NBH proper and Buzzards Bay, decision criteria were established for PCB bioaccumulation in mussels as well as for sub-lethal biological effects. Unlike the pilot study, no chemical criteria for water column samples were established at NBH-4. Chemical data collected during the pilot study indicated that when concentrations were controlled at NBH-2, no corresponding signal was observed at NBH-4. Because PCB net transport was monitored at NBH-2, it was not necessary to measure chemical concentrations in the water column at NBH-4. Additionally, mussel bioaccumulation was quantified at NBH-4, which provided an integrated assessment of water column PCB concentration over time.

In addition to the stations sampled for the decision criteria, supplemental water column monitoring occurred at several other upper harbor locations. The additional stations were sampled to assist in identifying possible causes of potential toxicity associated with the operation. These stations included one immediately south of the dredging operation, NBH-1, and one in the vicinity of the CDF, NBH-7. For example, if toxicity was noted at NBH-2, conceivably it could be associated with either the dredging operation or the CDF effluent. Without monitoring at these additional sites to distinguish the toxic stream location, the observed toxicity might be attributed to dredging when it could have been emanating from the CDF.

Decision Criteria

Net Transport

As stated previously, one goal of the hot spot remediation was to minimize the transport of contaminants to the lower harbor. To accomplish this objective, PCB transport under the Coggeshall Street Bridge needed to be limited. Previous studies by the COE, EPA, and others have demonstrated a continual net transport of PCBs to the lower harbor even in the absence of dredging. Because PCB net transport occurs continuously, regardless of remedial operations, it was necessary to establish some "acceptable" criterion limit for transport associated with the hot spot remediation. This level was selected to ensure that no additional remediation in the lower harbor would be required.

While the idea of limiting dredging-related PCB transport was desirable, establishing a specific criterion value was less straightforward. Several approaches were possible. During the pilot study, the PCB criterion at NBH-2 was based on a daily

single-point water column concentration measurement compared against a statistically significant increase over preoperational conditions (Nelson and Hansen, 1991). This approach worked well for several reasons. First, the sediment PCB concentrations were relatively low ($\sim 200 \mu\text{g/g}$) and the duration of the project was short. Therefore, the probability of transporting large amounts of PCBs to the lower harbor was low and could be controlled effectively by assessing PCB concentrations at NBH-2 on a daily basis against a single point criterion.

This was not the case with the hot spot remediation. The sediment concentrations were up to three orders of magnitude higher than those dredged during the pilot study, and the duration of the project was longer. Therefore, a single episodic criterion value could give a false sense of security with respect to PCB transport to the lower harbor. For example, if the PCB water column concentration remained at $1.3 \mu\text{g/l}$ during the entire hot spot remediation, a period of about 16 months, it would not have constituted a violation relative to the pilot study decision criterion of $1.4 \mu\text{g/l}$. However, if PCB water concentrations were near background most of the time ($\sim 0.3 \mu\text{g/l}$ during the dredging period), and exceeded the old criterion only intermittently during the operation, the net transport of PCBs into the lower harbor would be less over time. Therefore, it was important to consider both magnitude (i.e., concentration) and duration (i.e., time) components for the hot spot remediation. An evaluation parameter that provided the most integrative assessment of PCB transport would yield the greatest probability of limiting lower harbor impact during the remedial operation. A more conservative (i.e., environmentally protective) approach than the single episodic value was adopted for the hot spot remediation; a maximum cumulative transport (MCT) of PCBs during the entire operation. This MCT approach was based on the belief that some quantity of PCBs could be calculated that would be presumed to have no significant impact on the lower harbor. This mass of PCBs became the decision criterion value. The cumulative total of PCB net transport at NBH-2 was then compared with this upper limit throughout the operation.

The challenge in proposing a MCT for PCBs at NBH-2 was defining that mass of PCBs which would be "unacceptable" for transport to the lower harbor. A scientifically defensible estimate of how much PCB transport is "acceptable" is very difficult, if not impossible, to calculate. Consequently, best professional judgement was exercised to define an "unacceptable" MCT to meet the objective of not requiring additional remediation in the lower harbor. The average sediment concentration in the lower harbor was calculated to be 14 ppm, (Nelson et al., 1994). Based on this existing average concentration, it was decided that a 1 ppm increase in the sediment would probably neither be detectable analytically nor cause additional damage ecologically. Therefore, the MCT criterion value for NBH-2 was operationally

defined as follows: that mass of PCBs transported out from the upper harbor, above background concentrations, that would increase the mean lower harbor sediment concentration by more than 1 ppm.

Based on this definition, a numerical MCT criterion value was calculated. Several assumptions were made. First, it was assumed that PCBs would be deposited in the sediment uniformly over the entire lower harbor and remain in the system indefinitely. This was not the case. Data collected before, during, and after the pilot study indicate that only about 50% of the total PCBs at NBH-2 are associated with particulates. The other half are present in the dissolved phase of the water and would likely not settle to the bottom, especially exclusively in the lower harbor. Also, a portion of those particles that move into the lower harbor may deposit in the depositional areas presently scheduled for remediation (USEPA, 1996b). This mass of PCBs will be removed permanently from the lower harbor and not have a long-term impact. Finally, the MCT approach assumed that only PCBs would deposit during the operation. In fact, uncontaminated particles also deposit continuously, which has the cumulative effect of diluting any PCBs that will be deposited as a result of the remediation. Therefore, the assumption that all PCBs that are "allowed" to be transported using the MCT approach will remain in the sediments of the lower harbor is conservative on the side of environmental protection.

The calculation of the MCT value required the determination of the mass of PCBs in lower NBH. A detailed description is given by Nelson et al. (1994); however, a brief overview is provided here. The total sediment surface area in the lower harbor was determined using a digitizing planimeter. Next, the volume of sediment was determined by multiplying the area by a depth of 4 cm; chosen to represent the biologically active zone. The resultant volume was converted to dry weight mass units using an estimate of sediment density (1 cubic cm = 2.2 g dry wt). The total mass of the top 4 cm of sediment in the lower harbor was approximately 240×10^6 Kg. Therefore, in order to increase the total PCB sediment concentration by 1 ppm, 240 Kg of PCB would have to be transported to the lower harbor. This mass of PCBs became the MCT decision criteria value for NBH-2.

Biological

In addition to the chemical and physical measurements, biological decision criteria serve two purposes: a reality check on the chemical criteria and a screen for the presence of toxicity associated with contaminants not monitored for chemically. Typically, the general public can relate more closely to biological measurements than chemistry numbers. The fact that there are a few additional μg of a contaminant in the water column often does not convey much significance to the public. However, if those contaminants cause mortality in the

biota, a red flag is raised in peoples' minds. Conversely, a small increase in contaminant concentrations without a corresponding biological signal indicates that those elevated levels may not be causing significant environmental impacts. This was the case during the pilot study. The biological criteria indicated no impact at the two stations at which they were employed, even when sporadic elevation in PCBs occurred at NBH-2. These values provided a reality check for the chemical values and a sense of security that environmental parameters of concern, namely the health of the biota, were being protected.

A second rationale for including biological criteria is that it is impossible to enumerate every single contaminant that could possibly elicit biological effects. Rather, it is easier to conduct toxicity tests and have the organisms' physiological reactions to the test indicate whether or not a problem is occurring. Two types of biological criteria were employed for the hot spot remediation: toxicity tests and bioaccumulation.

Toxicity tests

Biological criteria established at Station NBH-2 (the Coggeshall St. Bridge) were designed to prevent water-borne contaminants at levels lethal to organisms from discharging to the lower harbor. The goal of the biological criteria at Station NBH-4 (the Hurricane Barrier) was to prevent water-borne contaminants at levels that might cause sub-lethal effects in organisms from discharging into Buzzards Bay. Based on the results (i.e., species sensitivity) of the pilot study (Nelson and Hansen, 1991), three toxicity tests were selected to assess acute effects at NBH-2 during the hot spot remediation: the sea urchin (Arbacia punctulata) sperm cell test, the 7-day mysid (Mysidopsis bahia) survival test, and the red alga (Champia parvula) survival test. The actual criteria were acute effects greater than 20% that at the West Island reference station (NBH-5) for any two species, or 50% greater than at NBH-5 in any one organism. The toxicity tests selected to assess sub-lethal effects at NBH-4 include the 7-day mysid growth test and the red alga reproduction test. The specific criteria were sub-lethal effects greater than 20% that at the West Island reference station (NBH-5) for any two species, or 50% greater than at NBH-5 for any single organism. These are the same criteria that were employed effectively during the pilot study.

Bioaccumulation

During the preoperational and operational phases of the pilot study, as well as subsequent post-operational deployments, bioaccumulation of PCBs was measured in mussels deployed in NBH. The data indicate that accumulation was remarkably constant over time. However, several questions pertaining to PCB uptake in the mussels were raised as a result of these data. Research was conducted to explore these questions which ultimately reinforced earlier findings that PCB accumulation in mussels accurately

reflects water column concentrations, especially the dissolved fraction (Bergen et al., 1993a; 1993b). Therefore, the use of mussels was considered to be very important for monitoring PCB bioavailability at both the Coggeshall St. Bridge and the Hurricane Barrier during remediation. The decision criteria for assessing PCB bioaccumulation at NBH-2 and NBH-4 was a statistically significant ($\alpha=0.01$) increase over pre-Hot Spot dredging concentrations.

Procedures

Physical

The focal point for water quality monitoring was Station NBH-2, for the reasons mentioned above. Quantifying total PCB-flux to the lower harbor was assessed at this site and represented one of the most important criteria in the project. An intensive water column sampling effort was conducted at NBH-2 during each tidal cycle (i.e., flood tide then ebb tide) when dredging occurred. Water samples were collected at thirteen separate locations throughout the water column at this station (5 horizontal points with multiple depths at each point, see Figure 2-2). Samples were taken at each six-inch fall or rise in tidal fluctuation as measured by a tide gauge at the bridge. Tidal amplitude was used instead of time intervals because water rise and fall at NBH-2 was not uniform over a tidal cycle. These samples were composited to form one sample for the ebb tide and one sample for the flood tide. These two samples were analyzed for PCBs and metals. PCB analysis was conducted on a 24 hour turn-around basis so that contaminant transport to the lower harbor could be assessed rapidly for each dredging day. For cumulative flux determinations, on days when dredging occurred but no monitoring was conducted, the mean concentration of all previous dredging days was used for cumulative flux determinations. Both individual and cumulative flux determinations were reviewed on a daily basis. If elevated contaminant levels were detected, water data were reviewed from NBH-1 and NBH-7 to provide an indication of the contamination source. In addition, the cumulative flux determinations were compared daily to the MCT decision criteria for the entire project.

Chemical

PCBs

The primary remedial goal was to remove PCBs and other collocated contaminants; therefore, accurate quantification of PCB concentrations in water and biota was extremely important. PCBs are a class of hydrophobic organic contaminants containing 209 individual congeners. Each PCB congener has one to ten chlorine atoms attached in a unique molecular arrangement. For many years, PCBs were quantified as total Aroclor®. Aroclor® is

Figure 2-2. Multi-point sampling array at the Coggeshall Street Bridge (station NBH-2).

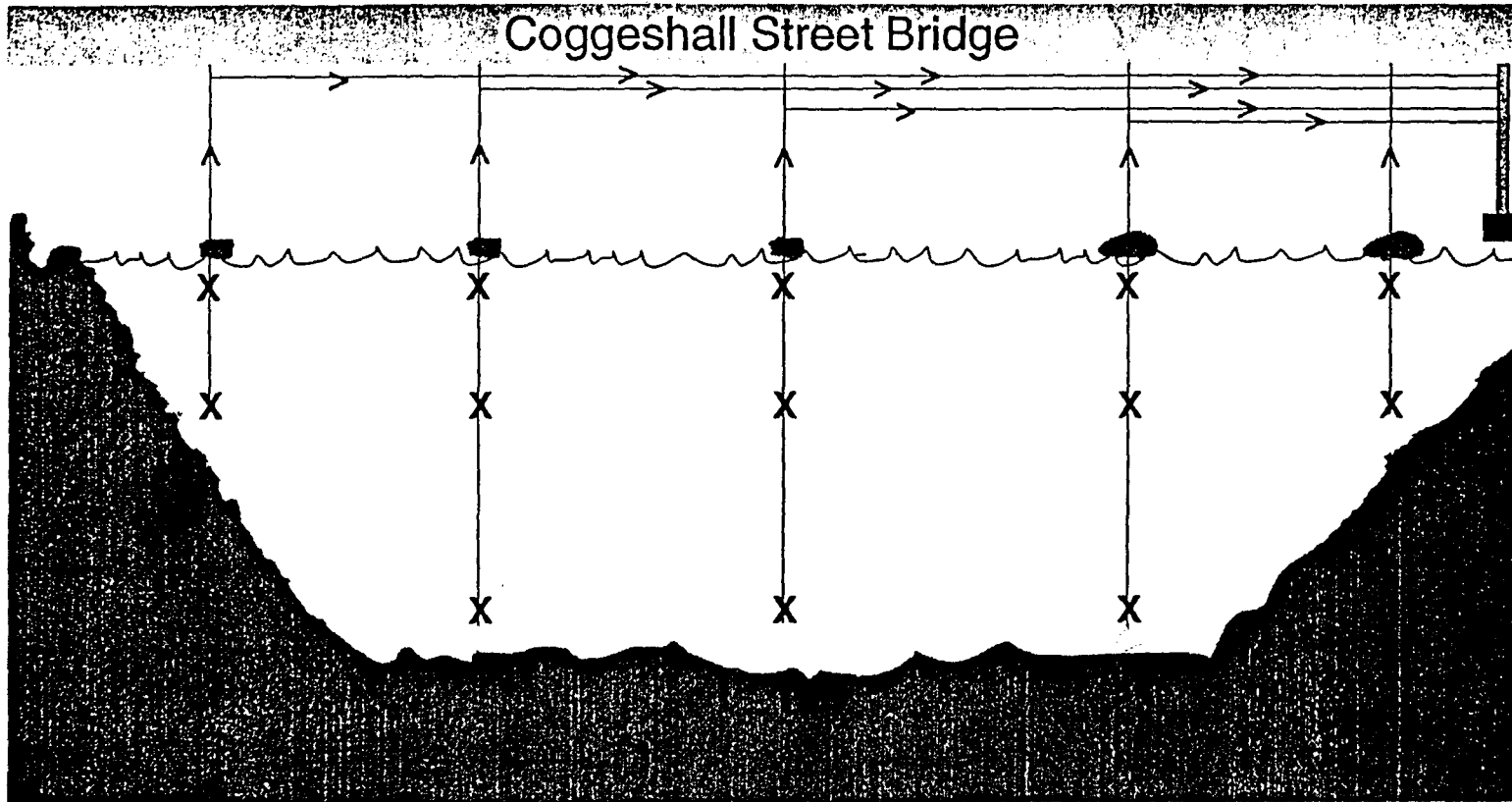

a Monsanto company trademark and refers to mixtures of PCB congeners (e.g., see Table 3-3). When quantifying total PCB concentration as Aroclor®, results can vary depending upon the analytical method used (i.e., which congeners are selected to represent the Aroclor® mixture). Congener-specific analysis is more accurate because single congener standards and reference materials (with congener-specific certified values) are readily available. For these reasons, this program measured 18 individual congeners in water and biota (Table 2-1), instead of quantifying total Aroclor®. However, because numerous samples collected during the pilot study measured both congener and Aroclor® content, a relationship between the two was calculated that allowed conversion of the PCB congener concentrations to total Aroclor® content.

Another result from the pilot study was how best to quantify PCB concentrations in water column samples. A subset of samples were analyzed for both whole water and dissolved/particulate PCB concentrations. Often, the sum of the dissolved PCB plus particulate PCB exceeded the whole water PCB concentration, particularly during times of increased particle loading. For this reason, and to increase the accuracy of the net transport calculations, all water samples were analyzed for dissolved and particulate PCBs separately, then summed to get a total value.

Water sample PCB analysis was conducted in the following manner. Separate composite samples for the ebb and flood tidal cycles were thoroughly mixed and filtered through a 0.3 um Type A/E Gelman glass fiber filter. An internal standard (CB198) was added to each sample before extraction with acetone and methylene chloride. Extracts were solvent exchanged to hexane and analyzed by GC-ECD (gas chromatograph equipped with an electron capture detector). Eighteen individual PCB congeners were quantified in the dissolved and particulate fractions of the seawater.

Metals

Separate ebb and flood composite samples were thoroughly mixed and filtered through a 0.45 um Coster teflon filter. Next, samples were extracted with 2M nitric acid. The resultant extract was brought to volume and analyzed for As, Cd, Cr, Cu, Hg, Pb, Ni, Se and Zn on an inductively coupled plasma spectrophotometer or an atomic adsorption spectrophotometer.

Biological

Toxicity tests

Arbacia punctulata: The sea urchin, Arbacia punctulata, sperm cell test (SCT) measures the concentration of a test substance that reduces fertilization of exposed gametes relative to a control. In this study, the SCT was used to measure water column acute toxicity at station NBH-2. The test method uses fertilization to estimate toxicity, following a short-term

Table 2-1. The eighteen congeners measured in the water column for this study.

<u>Name</u>	<u>Substitution Pattern</u>
CB008	2,4' -
CB018	2,2',5-
CB028	2,4,4' -
CB044	2,2',3,3' -
CB052	2,2',5,5' -
CB066	2,3',4,4' -
CB101	2,2',4,5,5' -
CB105	2,3,3',4,4' -
CB118	2,3',4,4',5-
CB128	2,2',3,3',4,4' -
CB138	2,2',3,4,4',5' -
CB153	2,2',4,4',5,5' -
CB170	2,2',3,3',4,4',5-
CB180	2,2',3,4,4',5,5' -
CB187	2,2',3,4',5,5',6-
CB195	2,2',3,3',4,4',5,6-
CB206	2,2',3,3',4,4',5,5',6-
CB209	decachlorobiphenyl

exposure of the sperm to effluents or receiving water. Briefly, the method consists of exposing dilute sperm solutions to the NBH water samples for one hour. Eggs are added and fertilization occurs in exposure vials. The test is terminated after 20 minutes by the addition of a fixative, and relative fertilization is tabulated by microscopic observations of eggs from control and test samples. Fertilization of the sea urchin egg is readily apparent by the presence of a surrounding fertilization membrane.

Mysidopsis bahia: Mysids are small marine shrimp. The mysid test method consists of exposing seven-day old Mysidopsis bahia juveniles to a water sample for 7 days. Two test endpoints were used in this program; survival, a measure of acute toxicity at NBH-2, and growth (measured as dry weight), a measure of sub-lethal effects at NBH-4. The test was conducted under conditions of daily renewal with NBH water samples, during which the animals were fed newly hatched brine shrimp, Artemia salina.

Champia parvula: This marine red alga was also used to measure both acute and sub-lethal effects during the dredging program. Five replicates were analyzed at each station and the results averaged. At NBH-2, acute toxicity was quantified in water column samples, while at NBH-4, sexual reproduction was measured as a sub-lethal effect. Briefly, the method consists of an exposure of males and females to effluents or receiving waters for two days, followed by a 5- to 7-day period of development in control medium. The latter period allows time for any cystocarps (evidence of sexual reproduction) to mature. At the end of the developmental period, the number of live plants and the number of cystocarps per plant are counted.

Bioaccumulation

Detailed methods for collecting and deploying mussels are found in Nelson and Gleason (1995). Briefly, uncontaminated mussels were collected from East Sandwich, MA (blue mussels, Mytilus edulis) and West Island, MA (ribbed mussels, Modiolus demissus). Both mussel species were utilized because dredging continued throughout the summer months, where water temperatures are often greater than 25°C in the upper harbor. Blue mussels do not survive these temperature for long periods of time, therefore, it was necessary to use another organism. Ribbed mussels have a greater temperature tolerance than blue mussels and a previous study in NBH demonstrated that they accumulate PCBs in concentrations equivalent to that in blue mussels within a 28-day deployment period (Nelson et al., 1995).

Mussels were placed into polyethylene mesh bags and deployed 1 meter above the bottom at three sites: NBH-2, -4, -5 (Figure 2-1). Each station consisted of four independent satellites. After 28 days, the mussels were retrieved and frozen. Prior to analysis, mussels were thawed, shucked and homogenized. Two grams of homogenate were extracted with acetonitrile and pentane,

solvent-exchanged to hexane, and analyzed by gas chromatography for the same 18 PCB congeners quantified in the water samples (Bergen et al., 1993a).

C. Results and Discussion

Net transport

The primary hot spot dredging monitoring goal was to effectively limit the transport of PCBs out from the upper harbor. The MCT decision criterion was established to allow an amount of PCBs that would not require any additional remediation in the lower harbor. Figure 2-3 shows the net transport of PCBs (Kg per day) for each day that transport data were collected. For days when dredging occurred but transport data was not collected, a mean PCB net transport value was used. This value was calculated by taking a mean of all previous dredging days' transport levels. Thus the cumulative net transport values include all dredging days, both when monitoring occurred and when it did not.

The cumulative transport during the dredging operation never approached the maximum allowable under the decision criteria. Figure 2-4 shows the allowable maximum cumulative transport, 240 Kg, distributed equally over the entire dredging period, 260 days (240 Kg/260 days). Also shown is the actual cumulative transport over the same period. For the entire operation, the total mass of PCBs transported under the bridge was approximately 57 Kg. This represented only 24% of the maximum 240 Kg allowed based on the net transport criterion. Therefore, the criteria for net transport was not violated during the remediation. The mass of PCBs transported out of the upper harbor during this time period was significantly less than that considered sufficient to require additional remediation in the lower harbor.

Toxicity tests

A summary of the biological test results for NBH-2 and NBH-4 is provided in Table 2-2, while Appendix A tabulates all of the biological data. The results of specific test results are discussed here.

Sea Urchin sperm cell test. Of the 86 sperm cell tests performed during the dredging project, mortality at station NBH-2 was never more than 10% than that of station NBH-5 the reference site. At station NBH-4 the maximum difference between station NBH-4 and NBH-5 was 12%. Therefore, because the criteria for mortality (greater than 50% that at NBH-5 for any single species) was never violated during the course of this operation, remedial activities appeared to cause no acute effects based on this test.

Figure 2-3.

Net Transport of PCBs under the Coggeshall St. Bridge.
Values represent kg per tidal cycle on dredging days.

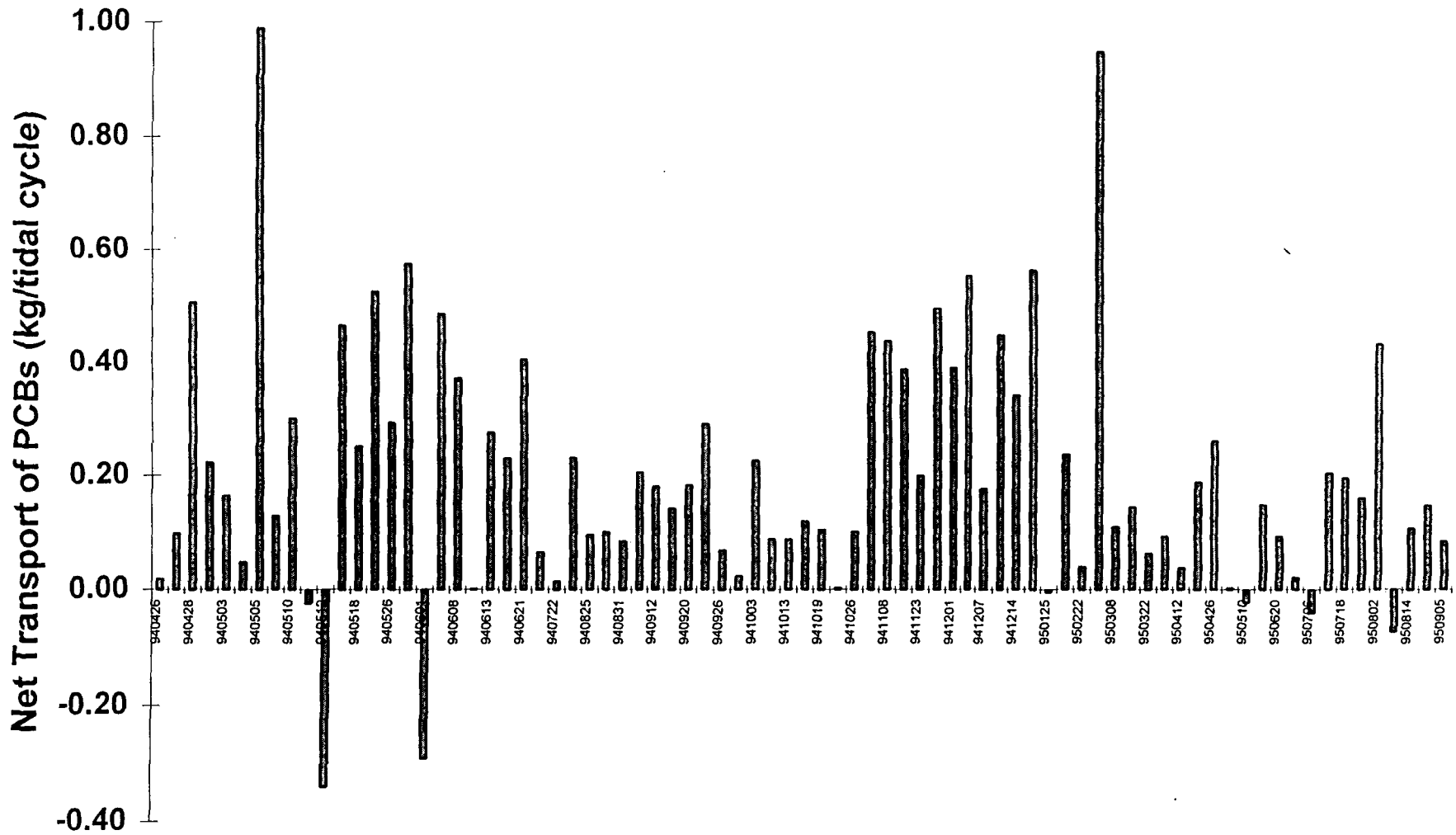

Figure 2-4.

Comparison of actual transport during the Hot Spot Remediation with the maximum allowable under the decision criteria

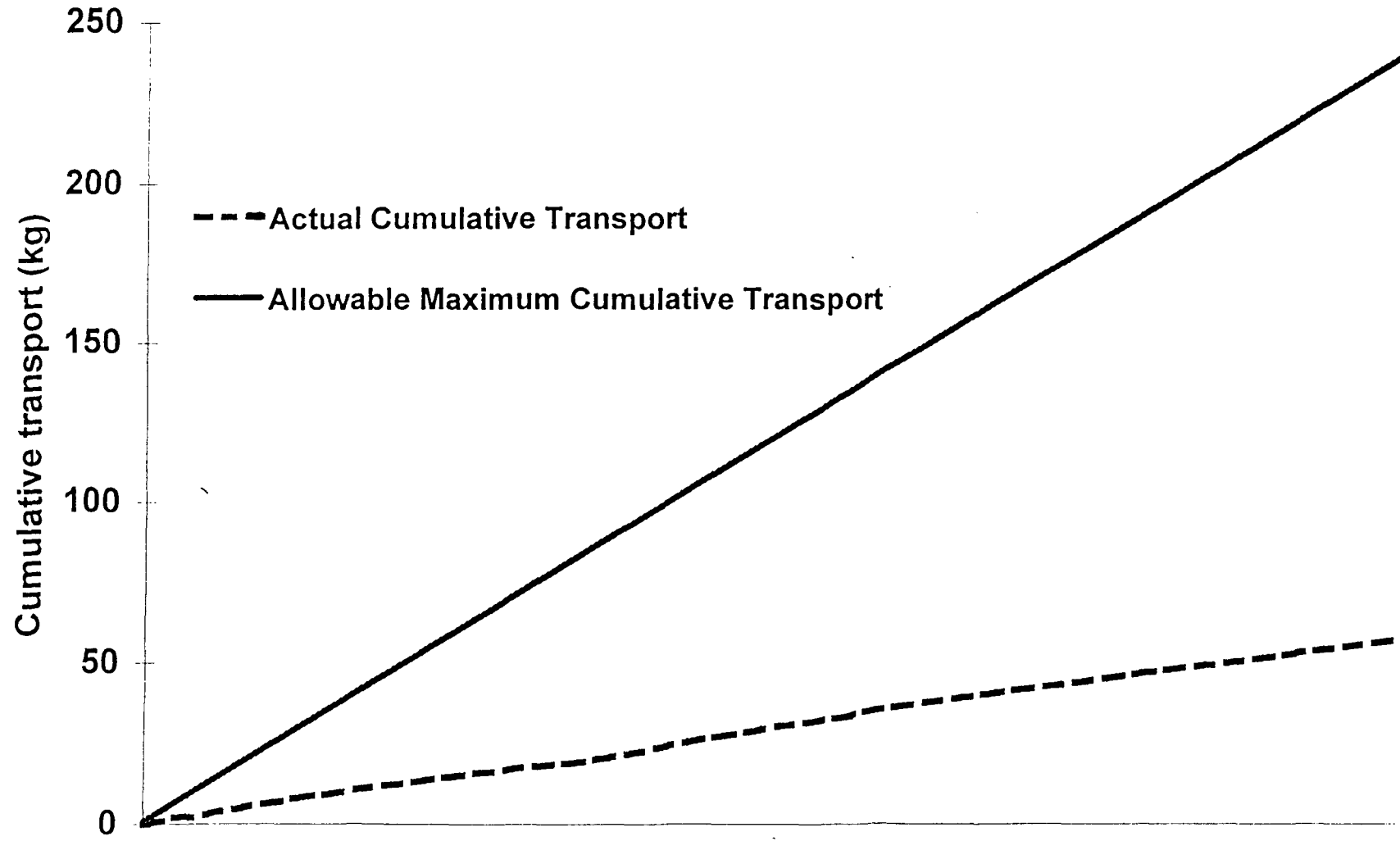

Table 2-2. Synthesis of toxicity test results relative to biological decision criteria. The biological criteria at NBH-2 were mortality >20% that at NBH-5 for any two species, or >50% for any single species. At NBH-4, the criteria were sub-lethal effects >20% that at NBH-5 for any two species, or >50% for any single species. Values indicate the number of times criteria were exceeded for each test, along with the total number of tests conducted, in parentheses, during the hot spot monitoring program.

Station Location	Acute Effects (NBH-2)			Sub-lethal Effects (NBH-4)	
	Sperm Cell Test	Mysid Survival	<u>Champia</u> Survival	Mysid Growth	<u>Champia</u> Reproduction
NBH-2	0 (86)	1 (7)	1 (83)		
NBH-4	0 (85)	0 (7)	0 (82)	0 (7)	3 (72)

Table 2-3. Mean (standard deviation) PCB concentrations (sum of 10 congeners, ng/g dry weight) in mussels deployed at monitoring stations for 28 days. Pre-Operational samples were collected between July 1987 and December 1993 (n=9); Operational samples were collected between May 1994 and September 1995 (n=14); Post-Operational samples were collected between October 1995 and May 1997 (n=4).

Station	PCB Concentration (ng/g)		
	Pre-Operational	Operational	Post-Operational
NBH-2	15012 (4368)	15052 (4719)	14639 (3715)
NBH-4	3814 (892)	4250 (890)	6315 (711)
NBH-5	613 (187)	403 (73)	371 (204)

Mysids. Seven week-long tests were conducted with mysids, with only one demonstrating any negative impact relative to mysid survival at station NBH-2: 100% mortality occurred during the week of 12/12/94. However, during this same time period, no acute effects were observed with the sea urchin sperm cell test or in Champia survival. Relative to the sub-lethal mysid growth criteria established at NBH-4, no negative effects were observed on any occasion. Based on the specific decision criteria established for this operation, dredging could have had an acute effect on only one occasion; however, similar acute effects were not observed with either of the other two test species.

Champia. Water column samples collected on eighty-five days were assessed for Champia survival at NBH-2. On only one occasion (9/7/94) was mortality greater than 50% that at NBH-5. However, on the same day, survival was 100% and 50%, respectively, at stations NBH-1 and NBH-7, which were closer to the dredging operation. Furthermore, no negative effects were observed in the sea urchin acute test at station NBH-2 on this same day. While the exact reason for this mortality is unknown, the data indicate that it was not related to the dredging operation.

Champia reproduction, as measured by cystocarp production, was one of two tests used to assess sub-lethal effects at NBH-4. Of all the tests used in this monitoring program, Champia reproduction is the most sensitive to both anthropogenic stressors (e.g., metals, organics) as well as natural stressors (e.g., nutrients, temperature). Therefore, while this test provides a comprehensive assessment of overall water quality, the variability associated with the results makes it more difficult to interpret relative to the dredging operation specifically. For example, 12 of the 84 tests showed no reproduction (<1 cystocarp) at any station, including NBH-5, therefore, the test results were only interpretable for 72 days. On 3 of these 72 days, cystocarp production was less than 50% that at NBH-5, the criterion value at NBH-4. However, on one of those days, this criterion was not exceeded at either NBH-1, -7, or -2, therefore, that day's effect cannot be attributed to the dredging operation. The fact that sub-lethal effects were observed in only 2 out of 72 tests (less than 5%) at NBH-4 indicates that any sub-lethal effects due to the remedial dredging operation had a minimal, if any, impact on Buzzards Bay.

Bioaccumulation

PCB accumulation in mussels is shown in Figures 2-5 (NBH-2), 2-6 (NBH-4), and 2-7 (NBH-5). The mean and standard deviation for the three operational phases (preoperational, operational, postoperational) are summarized in Table 2-3. The criteria of a statistically significant increase ($\alpha=0.01$) in mussel PCB concentration during operational dredging relative to

Figure 2-5: Mean PCB concentrations in blue mussels deployed for 28 days at Station NBH-2. Values on 940808, 940916, 950907 and 951005 are for ribbed mussels.

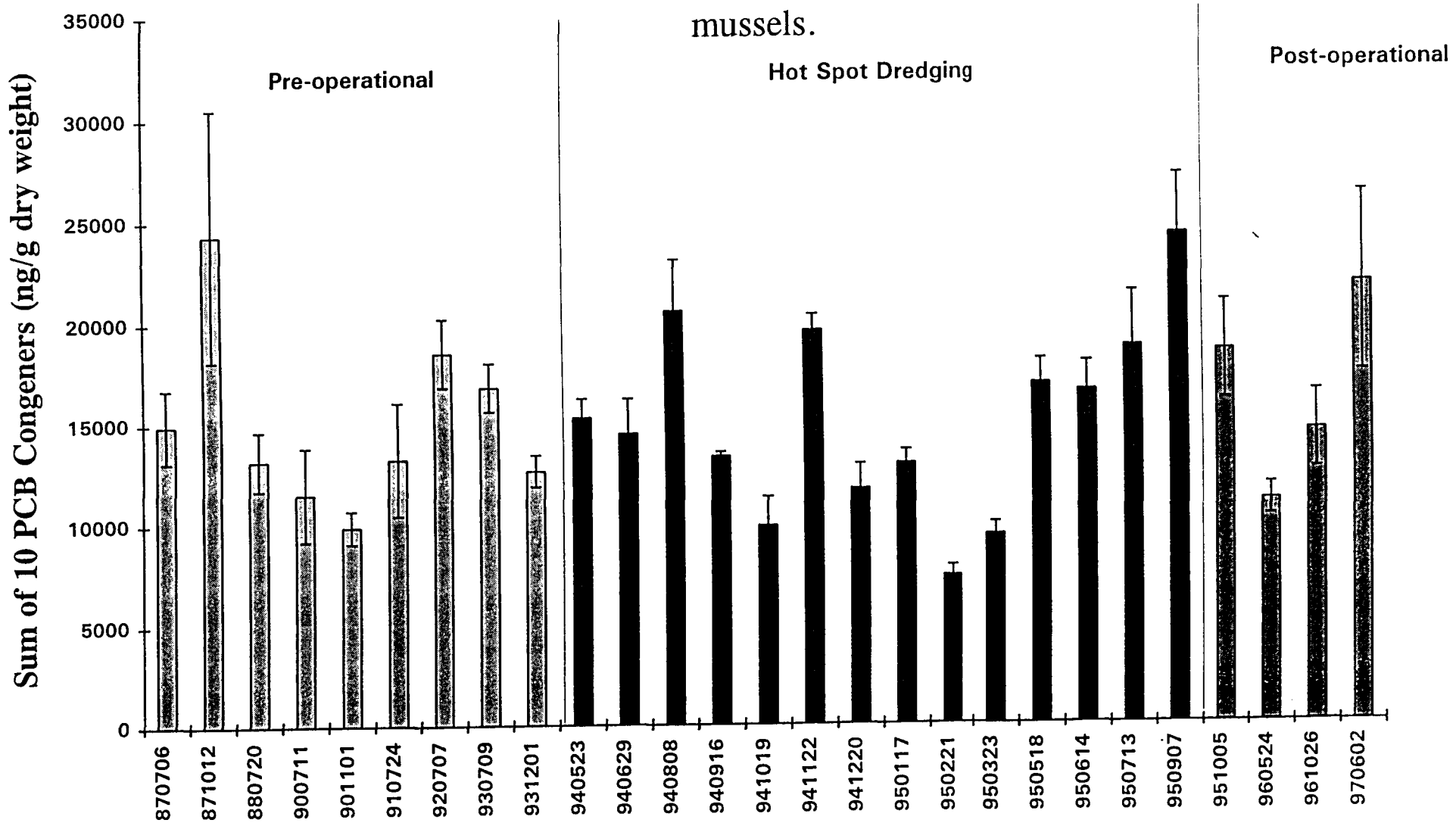

Figure 2-6: Mean PCB concentration in blue mussels deployed for 28 days at Station NBH-4. Values on 940808, 940916, 950907, and 951005 are for ribbed mussels.

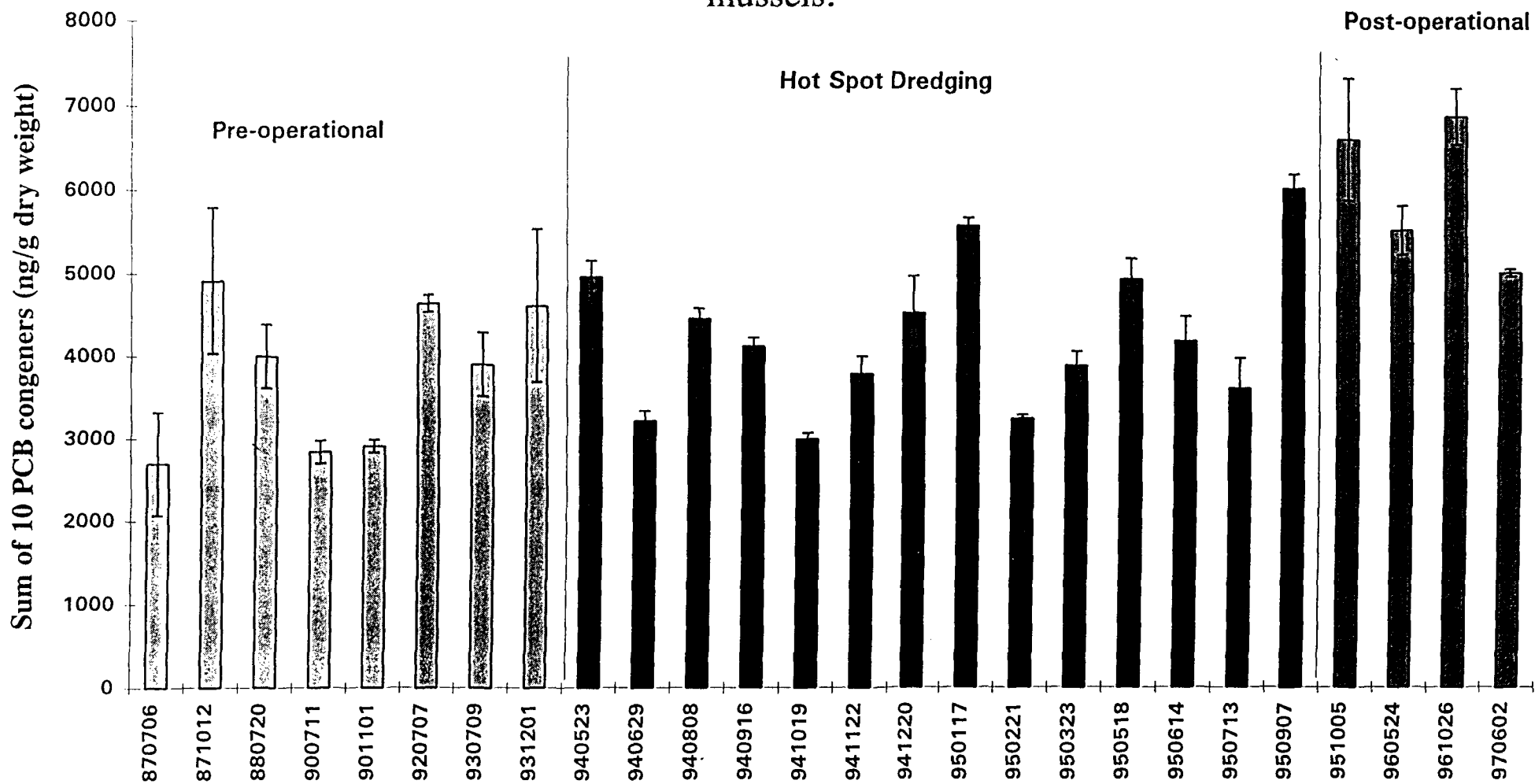

Figure 2-7: Mean PCB concentrations in blue mussels deployed for 28 days at Station NBH-5. Values on 940808, 940916, 950907, and 951005 are for ribbed mussels.

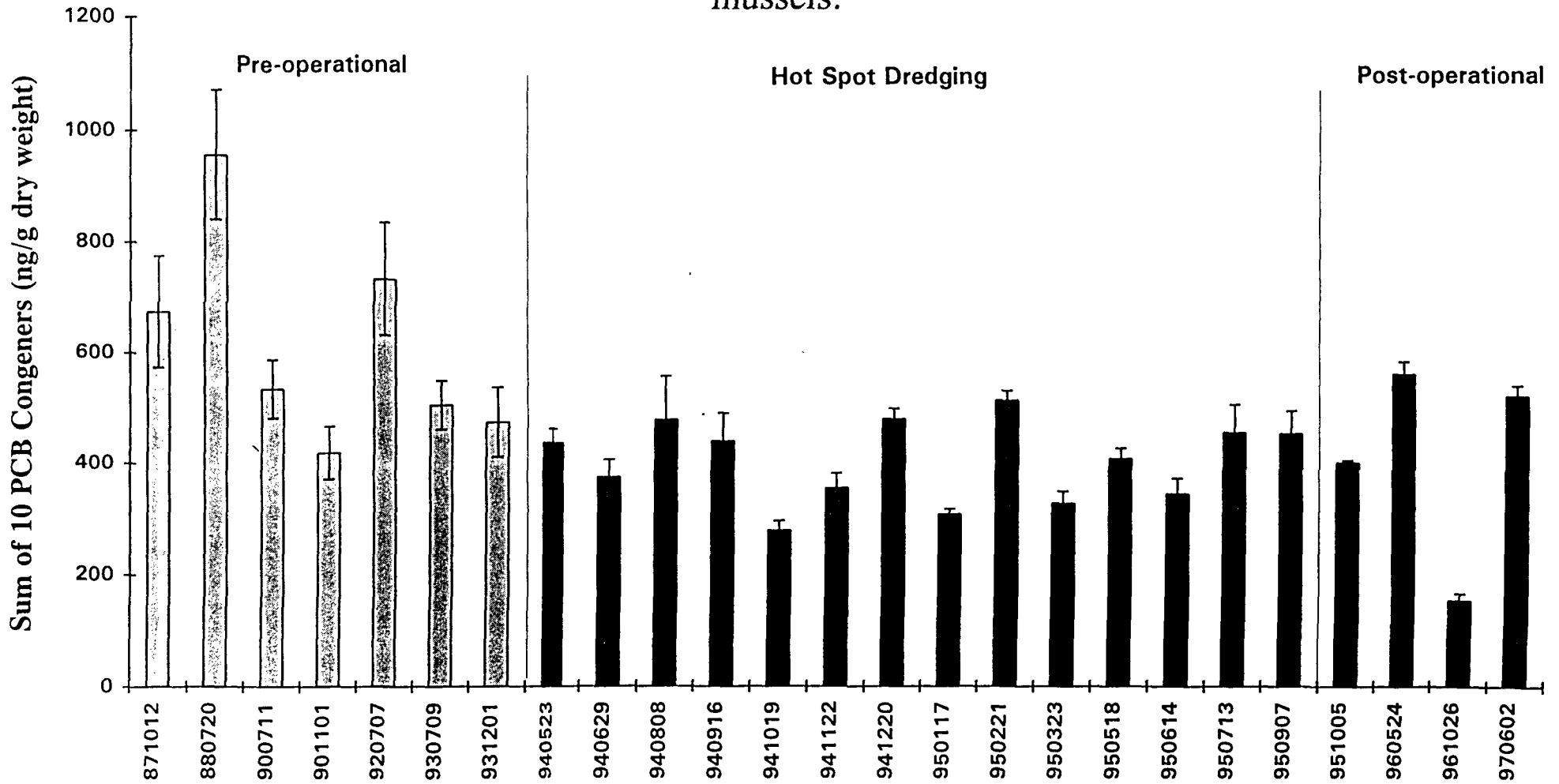
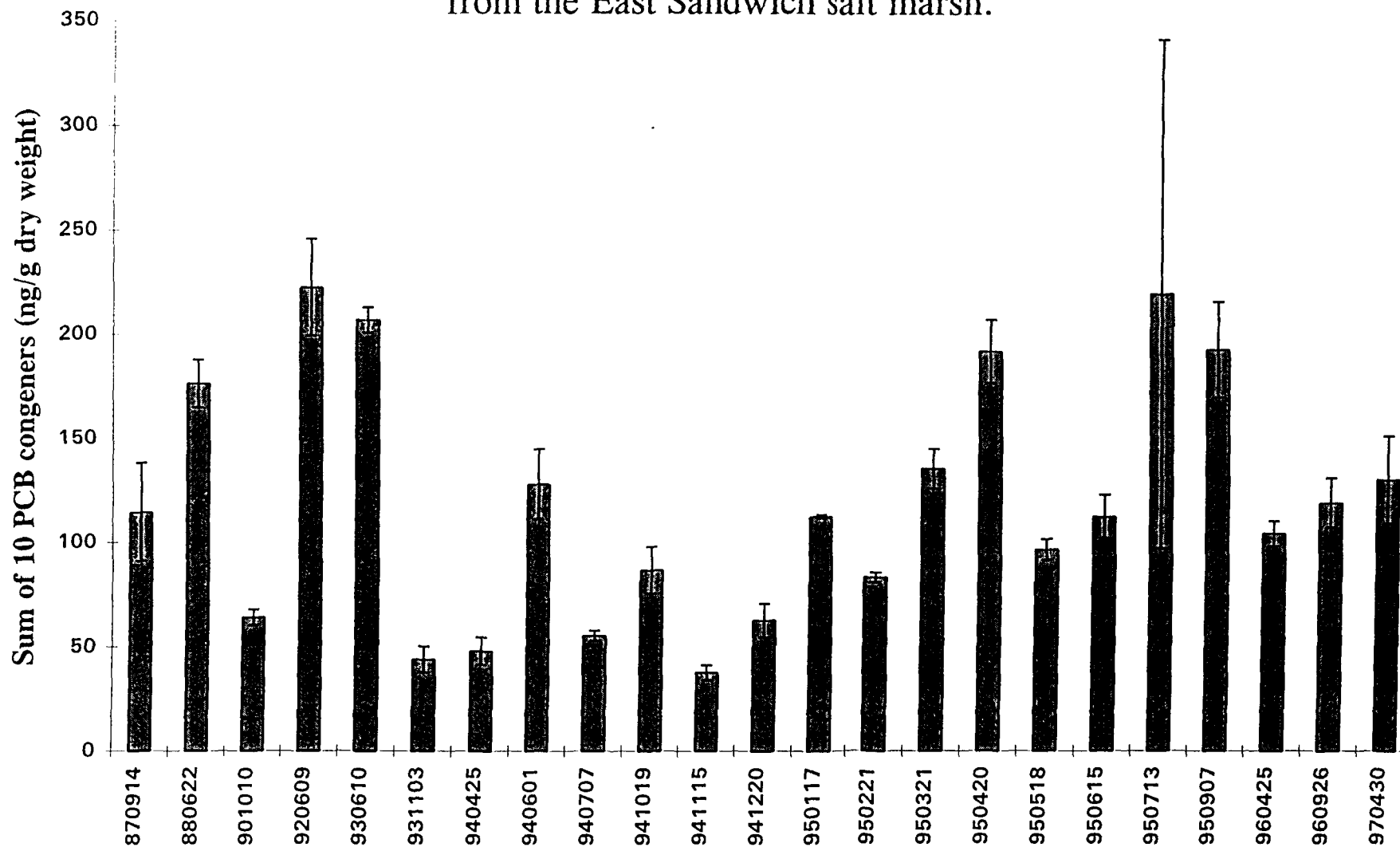

Figure 2-8: Mean PCB concentration in Day-0 blue mussels collected from the East Sandwich salt marsh.



preoperational concentrations, at stations NBH-2 and NBH-4, was never exceeded. There was a statistically significant decrease observed at the reference site (NBH-5) during the remediation; however, this is probably an artifact of two very high preoperational deployments. Typical seasonal variability can be seen during all phases of the hot spot remediation at all stations, including the clean collection site in East Sandwich, MA (Day-0, Figure 2-8). This variability is most likely attributable to spawning, where lipid-rich gametes increase and decrease during the year.

To date, four postoperational deployments have been conducted. At stations NBH-2 and NBH-5, no increase in PCB bioaccumulation has been observed. At station NBH-4, a statistically significant increase was observed. While the cause of this increase is unknown at the time, it is unlikely that it is attributable to the Hot Spot remediation. If this were the case, an increase also would be expected at NBH-2 which is much closer to the actual remedial area. This situation will continue to be monitored over time. Mussels will be deployed twice yearly at these same sites to provide an integrated assessment of water column PCB concentrations as outlined in the NBH Long-term Monitoring Plan (Nelson et al., 1996).

D. Conclusions

Based on an analysis of all the hot spot water quality monitoring data relative to the initial project decision criteria, the remedial dredging operation was completed within the acceptable limits agreed to by EPA, COE, and the Commonwealth of Massachusetts. There was a minimal net transport of PCBs during the dredging project, well below the level calculated to require any additional dredging in the lower harbor. During remediation, there were no acute toxicity effects that could be attributed to the dredging operation. PCB bioaccumulation in mussels was not significantly greater than pre- or post-operational deployments. These results indicate that the hot spot remedial dredging operation had a minimal environmental effect on New Bedford Harbor and Buzzards Bay. In light of the fact that a significant amount of PCBs were removed during this remedial dredging, this operation was successful.

III. Summary of the Effects of Dredging and CDF Disposal on Air Quality

A. Introduction

As part of the hot spot remedial action, an extensive air monitoring program was designed and implemented to monitor the potential impacts of the cleanup on ambient air quality, and to ensure the protection of site workers and nearby residents from unacceptable levels of airborne PCBs. Previous studies had indicated locally elevated airborne PCB levels in the vicinity of the hot spots (ranging from 196 to 471 ng/m³ at low tide, NUS 1986), as well as that dredging and disposal activities can promote airborne PCB releases (Ebasco, 1990). As discussed further below, the sampling plan included multiple stations at both the dredging and CDF storage area, and originally focused on potential impacts from the incinerator as well (USACE, 1991).

Due to the very high degree of public concern about the dredging operations, airborne PCB data was made available to the public on a quick turn-around basis. This data was reviewed with the public regularly throughout the duration of the project. A series of airborne PCB action levels were utilized which called for assessments, operational changes or, in the worst case, cessation of operations in the event of elevated airborne PCB levels.

B. Methods

Monitoring stations

Although the incineration component of the remedy was ultimately terminated, ambient monitoring stations originally intended for the assessment of air quality impacts from incineration were retained. Other ambient stations were added to ease public concerns about dredging. The final configuration of monitoring stations is shown in Figure 3-1, and consisted of 6 stations in the dredging area, 6 stations in the immediate CDF area and 4 stations covering offsite areas around the CDF.

The locations of the dredge area stations reflect the predominant southwesterly wind direction during summer, in which higher degrees of PCB volatilization are expected. Logistical issues with the air sampling equipment (i.e., utilities, security, access) also played a role in determining station locations. Duplicate stations were co-located at stations 3 and 13 to provide assessments of overall data quality.

With the exemption of stations 3 and 3D, the samplers were installed on wooden platforms at the breathing zone level approximately 6 feet above the ground. Stations 3 and 3D were located approximately 10 feet above the ground, due to a wind



SOURCE: Base map adapted from USGS 7.5 min series maps(1:25,000), New Bedford North, MA. quad, dated 1979

Figure 3-1. Location of Ambient Air Monitoring Sites New Bedford Harbor Hot Spot Dredging Remedy

screen around the CDF in this area. Station 4 was moved on 5/22/95 to the office trailer area, and was redesignated station 17.

Meteorological monitoring

A meteorological monitoring station was located in the CDF area, and included instrumentation for continuous recording of wind speed, wind direction, standard deviation of wind direction, temperature at 2 and 10 m and the difference between the two, precipitation, relative humidity, barometric pressure, and solar radiation. These parameters were recorded for the duration of the dredging program, and the results were used to determine which monitoring stations were upwind or downwind on any given day, and as aids in the overall interpretation of the airborne PCB results.

Sampling program

In order to characterize impacts from the dredging operations, 8-hour integrated samples were collected from stations 11 through 16 and at station 10 on days in which dredging or intrusive activity occurred. The 8-hour period was centered around the high tide during which the dredging activity occurred. For characterization of impacts from the CDF, the six CDF stations were sampled over a 24-hour period twice per week, and the three other off-site stations (7, 8 and 9) were similarly sampled once per week. The days of the week in which sampling occurred at these nine stations were rotated to avoid potential bias from offsite urban activities.

The type of air samplers used were General Metals Works model GPS-1. The sampler contained a quartz glass fiber filter for the removal of particulate-bound PCBs, followed by a sorbent polyurethane foam (PUF)/"XAD" resin plug for the collection of vapor-phase PCBs. Ambient air was drawn through the filter and sorbent plug at a rate of approximately 9 cfm, as monitored using a calibrated magnehelic gauge. After sampling was completed, both the filter and PUF plug were removed and sent for laboratory analysis.

All ambient air monitoring and analysis was performed using a modified version of EPA Method TO-4, "Determination of Organochlorine Pesticides and Polychlorinated Biphenyls in Ambient Air." The analysis for PCBs was performed using a modified version of the Aroclor-specific EPA method 608. The method was modified so that it was consistent with prior studies, and so that it provided a conservative estimate of airborne PCBs, as follows:

- 4 peak identification for Aroclors 1016, 1242, 1254 and 1260
- external standards for Aroclor 1016 and 1254
- analysis using a packed column

Some initial work focused on congener-specific as opposed to Aroclor-specific airborne PCB analysis, but non-PCB airborne interferants were found to bias the sample results unacceptably high (Virag et al., 1996).

Action Levels

A series of action levels was established prior to the start of remedial operations to manage potential air impacts from the remedial operations. These action levels are presented in Table 3-1. If the airborne PCB monitoring data were to exceed the various action levels (i.e., 50, 500 or 1,000 ng/m³), then changes in operations or addition of engineering controls were to be implemented as appropriate. During the preliminary stages of the remedial action, in order to further minimize potential air impacts, an additional control measure was added for the dredge area: if any airborne PCB value for stations 11 through 16 were above the 1,000 ng/m³ level, the dredging operations would be shut down until levels could be lowered. These action levels were built into the remedial action contract, so that EPA and the Corps had clear authority to manage the remedial contractor's activities as appropriate.

For perspective, the dredge area shut-down level, 1,000 ng/m³ or 1 ug/m³ for total Aroclors, is the same level as the NIOSH REL for individual Aroclors (NIOSH, 1994). This NIOSH REL is 500 times lower than the lowest Aroclor-specific OSHA PEL (Occupational Safety and Health Administration permissible exposure level) (NIOSH, 1994).

C. Results and Discussion

A summary of the air data collected from March 11, 1994 to September 5, 1995, the last day of dredging, is shown on Table 3-2. The complete air data base is attached in Appendix B. As presented in Table 3-2, of the 4,041 total samples, 1,063 (26%) exceeded the 50 ng/m³ action level, 49 (1%) exceeded the 500 ng/m³ action level, and 10 (0.25%) exceeded the 1,000 ng/m³ action level, including two occasions in which levels at both station 3 and the co-located station 3D were above the 1,000 ng/m³ criteria.

All but one of the 10 exceedances of the 1,000 ng/m³ action level occurred at CDF monitoring station 3 or 3D. This station was the closest of all CDF stations to the stored dredged material, approximately 50 ft away. Due to these occasionally elevated levels, engineering controls were implemented at the CDF to minimize airborne PCB levels. These controls included maintenance of a ponded water layer over the dredged sediment, placement of a floating plastic cover on this ponded water layer, and implementation of a sprinkler system to cool this black colored cover as a way to minimize temperature dependent volatilization of the PCBs.

Table 3-1. Airborne PCB Action Levels and Corrective Measures

<u>Case</u>	<u>Air Concentration</u>	<u>Action</u>
1.	50 ng/m ³ measured in any one sampling event	Contractor shall notify the Contracting Officer and provide an explanation of why the elevated ambient concentration was observed.
2.	50 ng/m ³ measured in two or more consecutive sampling events	Contractor shall take action outlined for Case 1 above and propose operational changes to control emissions.
3.	50 ng/m ³ measured in more than 50% of ten consecutive sampling events (i.e., 5 out of 10)	The Contractor shall take action outlined above for Case 2 and shall develop and present to the Contracting Officer a plan to provide physical emission controls and contingencies.
4.	0.5 ug/m ³ measured in any one sampling event	Contractor shall notify the Contracting Officer, provide an explanation of why the elevated ambient concentration was observed and be prepared to take immediate operational changes to control emissions.
5.	1.0 ug/m ³ measured in any one sampling event	Contractor shall take the action outlined in Case 4 above and shall be prepared to implement immediate physical emission controls and contingencies (e.g., vapor suppression foams).

Table 3-2. Summary of Airborne PCB Sampling Results
New Bedford Harbor Hot Spot Dredging Remedy

SAMPLE LOCATION	TOTAL # OF SAMPLES COLLECTED	AVERAGE CONC. (NG/M3)	ACTION LEVEL EXCEEDENCES		
			>50 ng/m3	>500 ng/m3	>1000ng/m3

ON-SITE

1	204	33.19	37	0	0
2	204	44.18	55	0	0
3	200	180.11	107	22	7
3D	161	147.70	87	9	2
4	131	14.04	6	0	0
5	162	20.06	18	0	0
6	206	51.98	68	0	0
17	30	52.29	13	0	0

NEAR SITE

7	86	9.45	0	0	0
8	94	8.45	0	0	0
9	94	14.92	11	0	0

DREDGE

10	311	29.17	52	0	0
11	313	174.12	251	12	1
12	313	28.69	50	0	0
13	313	80.99	143	4	0
13D	282	77.54	121	2	0
14	314	11.16	13	0	0
15	313	23.08	28	0	0
16	310	10.09	3	0	0

TOTAL

	4041		1063	49	10
--	------	--	------	----	----

NOTE: SUMMARY OF DATA FROM 03/11/94 TO 09/05/95

The one dredge area exceedance of the 1,000 ng/m³ action level also occurred at the closest dredge area station, station 11, approximately 30 ft away from the most contaminated hot spot area. This exceedance occurred on April 25, 1994, the day before actual dredging began, during initial deployment of various dredging-related equipment. This one dredge area exceedance is attributed to poor performance of silt curtains that were initially planned to help minimize sediment resuspension. Use of the silt curtains around the dredge was abandoned as a result of these initial findings.

Other operational changes were made as well in order to minimize airborne PCB levels in the dredge area, including a) decreasing the sweep speed of the cutterhead, b) modification of the dredging sequence so that the most contaminated areas were dredged during the winter, and c) initiation of night time dredging during the summer months to minimize the influence of temperature and solar radiation on the volatilization of any PCBs that migrated to the water surface as a result of dredging.

PCBs in the vapor phase

Importantly, although the monitoring protocol called for the reporting of total PCBs as opposed to differentiating between particulate-bound and vapor phase PCBs, we believe that the vast majority of airborne PCBs were in the vapor phase. This is due to the nature of the remedial operations (creation of dust that would carry attached PCBs was not a characteristic of this site nor this remedy), the seasonality of the airborne PCB levels (levels were much higher in summer than in winter), and the low molecular weight Aroclor typically identified during the sampling program (see next paragraph). One sample from station 3 did differentiate the PCB mass associated with the filter from that associated with the sorbent plug portion of the air sampler: the results (1.3 ug/filter, 368 ug/plug; Virag et al., 1996) are consistent with the conclusion that airborne PCBs were largely in the vapor phase.

The specific Aroclor typically identified during the sampling program was Aroclor 1016. Aroclor 1016 contains mostly tri-chlorinated PCB congeners, and no congeners greater than the tetra-chlorinated group (Table 3-3). The lighter molecular weight, predominating congeners of Aroclor 1016 have higher vapor pressures than the more chlorinated isomers (Table 3-4), and would thus be expected to evaporate more readily. Aroclor 1016 was by far the most prevalent Aroclor identified during the sampling program: on average, Aroclor 1016 accounted for 99.74 to 100% of the total PCBs reported for each sampling station (Weston, 1997).

In terms of other factors that affected airborne PCB levels, Virag et al. (1996) found that wind direction, wind speed, air temperature and solar radiation all played a statistically significant role in detected PCB concentration.

Table 3-3. Typical percent composition of some commercial PCB mixtures

	Aroclor					Clophen		Kanechlor		
	1016	1242	1248	1254	1260	A 30	A 60	300	400	500
Mono-CBs	2	1	—	—	—	—	—	—	—	—
Di-CBs	19	13	1	—	—	20	—	17	3	—
Tri-CBs	57	45	21	1	—	52	—	60	33	5
Tetra-CBs	22	31	49	15	—	22	1	23	44	26
Penta-CBs	—	10	27	53	12	3	16	1	16	55
Hexa-CBs	—	—	2	26	42	1	51	—	5	13
Hepta-CBs	—	—	—	4	38	—	28	—	—	—
Octa-CBs	—	—	—	—	7	—	4	—	—	—
Nona-CBs	—	—	—	—	1	—	—	—	—	—
Deca-CB	—	—	—	—	—	—	—	—	—	—

Source: USEPA, 1996a (originally adapted from Silberhorn et al., 1990, and ATSDR, 1995)

Table 3-4. Vapor pressures of some PCB congeners

	congener IUPAC No.	subcooled liquid vapor pressure at 25 °C (Torr)
biphenyl	0	2.8×10^{-2}
2-chlorobiphenyl	1	1.9×10^{-2}
3-chlorobiphenyl	2	7.5×10^{-3}
4-chlorobiphenyl	3	6.8×10^{-3}
2,2'-dichlorobiphenyl	4	4.5×10^{-3}
2,4-dichlorobiphenyl	7	1.9×10^{-3}
4,4'-dichlorobiphenyl	15	6.0×10^{-4}
2,4,4'-trichlorobiphenyl	28	1.8×10^{-4}
2,4,5-trichlorobiphenyl	29	3.3×10^{-4}
2,4',5-trichlorobiphenyl	31	2.1×10^{-4}
2',3,4-trichlorobiphenyl	33	1.4×10^{-4}
2,2',3,5'-tetrachlorobiphenyl	44	8.8×10^{-5}
2,2',4,4'-tetrachlorobiphenyl	47	9.9×10^{-5}
2,2',3,5',6-pentachlorobiphenyl	95	4.7×10^{-5}
2,3,3',4',6-pentachlorobiphenyl	110	1.9×10^{-5}
2,3,4,5,6-pentachlorobiphenyl	116	1.7×10^{-5}

Source: Anderson and Hites, 1996

D. Conclusions

The extensive air monitoring program implemented for the hot spot dredging and interim storage operations revealed occasionally elevated airborne PCB levels. Most of the exceedances of the 500 and 1,000 ng/m³ action levels occurred at the CDF area as opposed to the dredge area, and no such exceedances occurred in the months of September through February.

Operational practices and engineering controls served to minimize airborne levels, to an extent that no exceedances of the 1,000 ng/m³ dredge area shut down level occurred once dredging actually began. Control of airborne PCB emissions did contribute, however, to a slower rate of dredging and thus a longer project duration.

A number of important operational lessons were learned as a result of this project that can be applied to the next phase of remedial dredging planned for the harbor (USEPA, 1996b). These include a) silt curtains should not be used around the dredge(s), b) even though sediment PCB levels will be lower, some form of emissions control at the CDFs will most likely be required if similar airborne PCB action levels are employed, and c) airborne PCB monitoring need not be as frequent during winter as in summer. Also, given the \$1.3 million cost of this monitoring program, alternative air monitoring technologies should be reviewed for appropriateness and cost-effectiveness for future dredging operations.

Finally, the comprehensive nature of the air monitoring program clearly demonstrated that migration of PCBs via the air pathway does occur, especially during warmer temperatures. Characterization or cleanup at other PCB-contaminated sites should therefor include an effective airborne PCB monitoring program.

IV. Summary of the Effects of CDF Effluent on Water Quality

A. Introduction

Since one of the primary operational goals of the hot spot dredging project was to minimize sediment resuspension, large volumes of water were "codredged" (i.e., high operating vacuums were used on the dredge) as one of several engineering controls to minimize sediment resuspension. This section summarizes the treatment operations for this dredged water, including a discussion of the effluent limitations employed and an analysis of the chemical and biological effects of the treated discharge on the receiving waters.

Flow rates into the CDF during periods of dredging (i.e., at high tide) varied between 1500 and 2100 gpm, with typically only 5% solids. The process of dredging and pumping the dredged material roughly one mile to the CDF via floating pipeline increased the concentration of PCBs and certain metals in the liquid phase by roughly one to two orders of magnitude. From CDF cell #1 the dredged water was decanted over a slide gate to cell #2, and from there pumped to a water treatment plant (Figure 4-1). Approximately 160 million gallons of decant water was treated during the 16 months of the project at an average rate of about 350 gpm. The treated effluent was discharged to the Acushnet River near the northeastern corner of the CDF. The overall goal of the water treatment process was to control and minimize the amount of contaminants discharged to the river.

B. Methods

Discharge limits

Discharge limitations for the hot spot water treatment plant were developed during the design phase of the project, and reflected performance testing of wastewater treatment technology and existing water quality conditions. The monthly average discharge limits are displayed in Figure 4-2, along with relevant EPA ambient water quality criteria (AWQC) and average background water quality conditions as measured at NBH-2, the Coggeshall Street bridge, to provide perspective. The daily maximum discharge limitations, which are not shown in Figure 4-2, were as follows: chromium - 12.8 ug/l; cadmium - 10.7 ug/l; lead - 8.5 ug/l; copper - 14.9 ug/l; PCBs (defined for this project as the sum of Aroclors 1242 and 1254) - 1.3 ug/l.

Note that the background averages displayed in Figure 4-2 for lead (n=84), copper (n=84) and PCBs (n=111) reflect a large, four season data base collected in 1994 and 1995 during hot spot dredging, whereas those for chromium and cadmium reflect smaller data bases collected during the winter of 1988/1989. Collection of the more recent, larger data base for PCBs, copper and lead during

Figure 4-1. Areal Schematic of the Hot Spot CDF

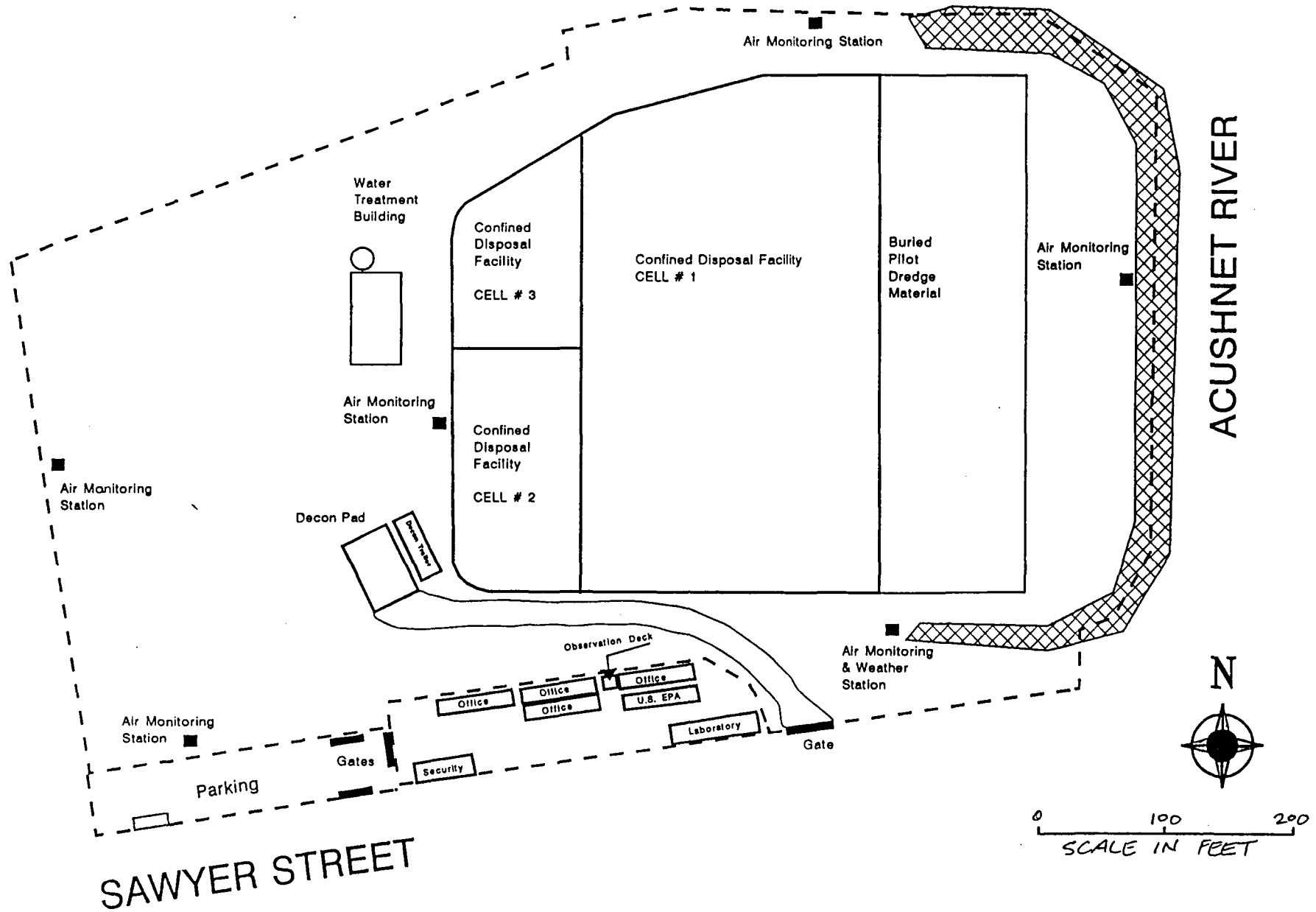
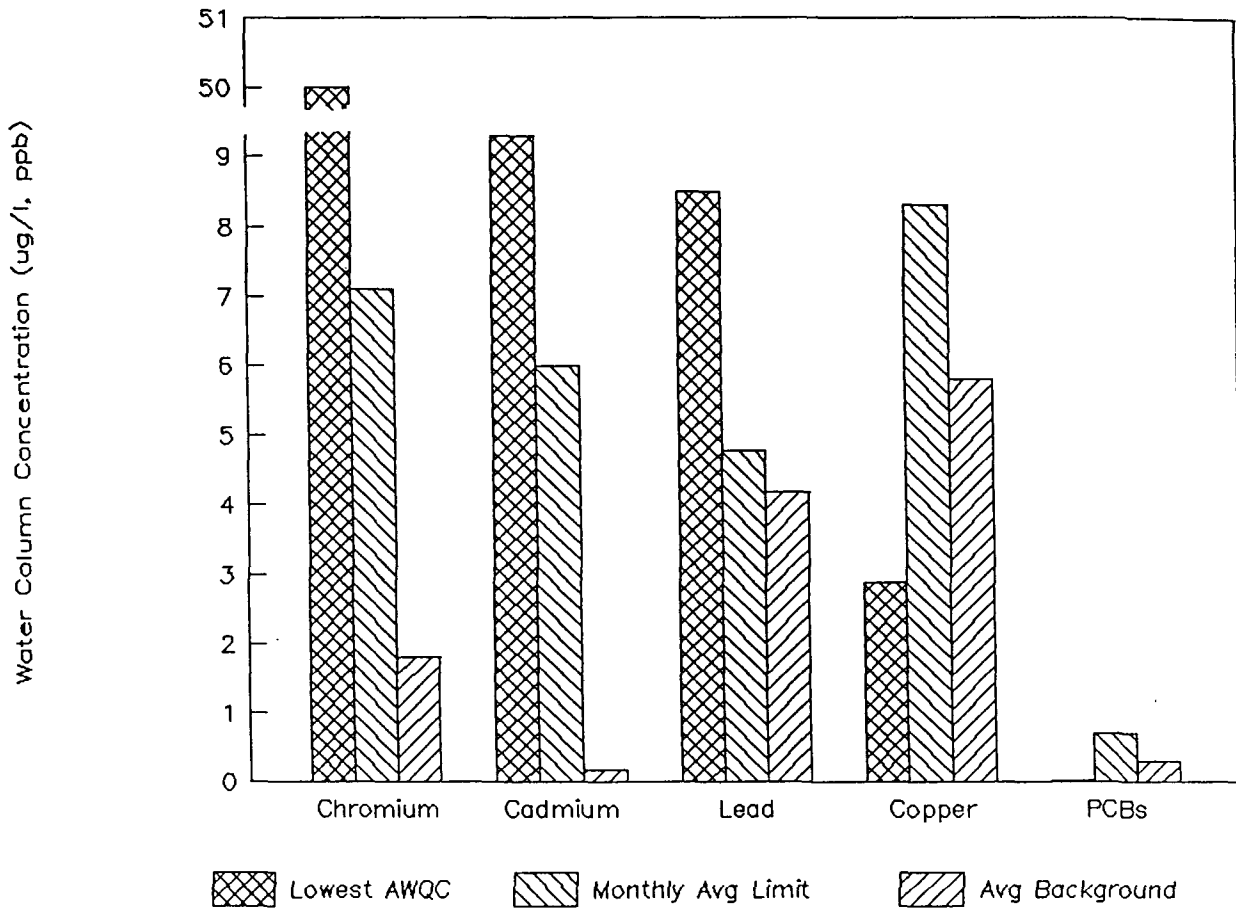

Figure 4-2

Hot Spot CDF Discharge Limits

New Bedford Harbor Superfund Site



the hot spot dredging lowered the average "ambient" values compared to those previously calculated in 1988/1989. Thus the background values displayed in Figure 4-2 for chromium and cadmium may be biased high. Also, use of a single value to reflect background concentrations obviously does not reflect existing spatial and temporal variability, but is used here as a simplifying approach to provide the reader with a quick perspective of ambient water quality as measured at a central, well-mixed point in the harbor.

In summary, the monthly average discharge limitations for chromium, cadmium and lead were below marine chronic AWQC, setting very ecologically protective treatment criteria for these metals. For copper and PCBs, however, the monthly average limits were set above the chronic AWQC, reflecting the elevated, above-AWQC background levels of these substances and laboratory-based performance expectations of the treatment system. As discussed further below, the actual operational levels of copper and PCBs discharged were generally below ambient background levels.

Treatment methods

The treatment technologies used to obtain the hot spot discharge criteria included primary settling in cell #1, equalization in cell #2, flocculation, secondary settling in cell #3, sand filtration, polishing filtration and ultraviolet light/hydrogen peroxide treatment (Figure 4-3). The treatment plant was operated by staff from Metcalf & Eddy, Inc. a subcontractor to the Corps' prime contractor for the hot spot dredging, Perland Environmental Technologies, Inc.

Ambient impact monitoring

Finally, station NBH-7 was included in the monitoring effort for the evaluation of potential biological and chemical effects in the Acushnet River in the immediate vicinity of the CDF discharge. This monitoring station was included to provide the ability, in the event of unacceptable ecological effects detected during dredging, to differentiate between effects from the cutterhead and effects from the CDF discharge. As described in more detail in section II, the monitoring protocol for NBH-7 included analysis for PCBs, Cu and Pb, as well as toxicity testing using the sea urchin (Arbacia punctulata) sperm cell test, the seven day mysid (Mysidopsis bahia) survival test, and the red alga (Champia parvula) survival test.

C. Results and Discussion

Figures 4-4, 4-5, and 4-6 illustrate the actual levels of PCBs, Cu and Pb discharged (as monthly averages), along with the respective AWQC and background concentrations of these pollutants. Effluent quality was generally at or below background for these contaminants of most concern. PCBs and Cu stand out since their background concentrations are above AWQC by factors of about 10 and

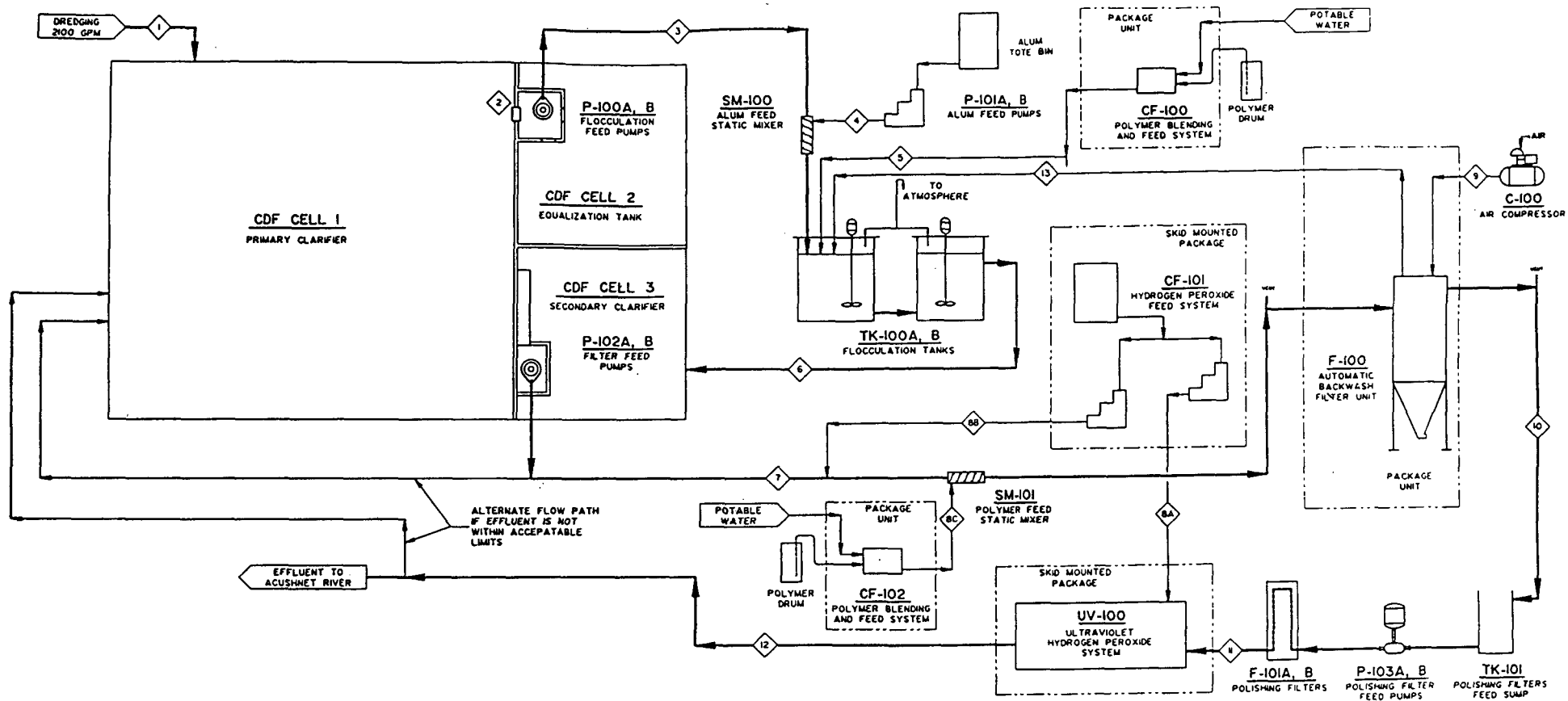

Figure 4-3
 New Bedford Harbor Superfund Site
 Water Treatment Plant Schematic
 for the Hot Spot Dredging Project

Figure 4-4

Hot Spot Tmt. Plant PCB Discharges

New Bedford Harbor Superfund Site

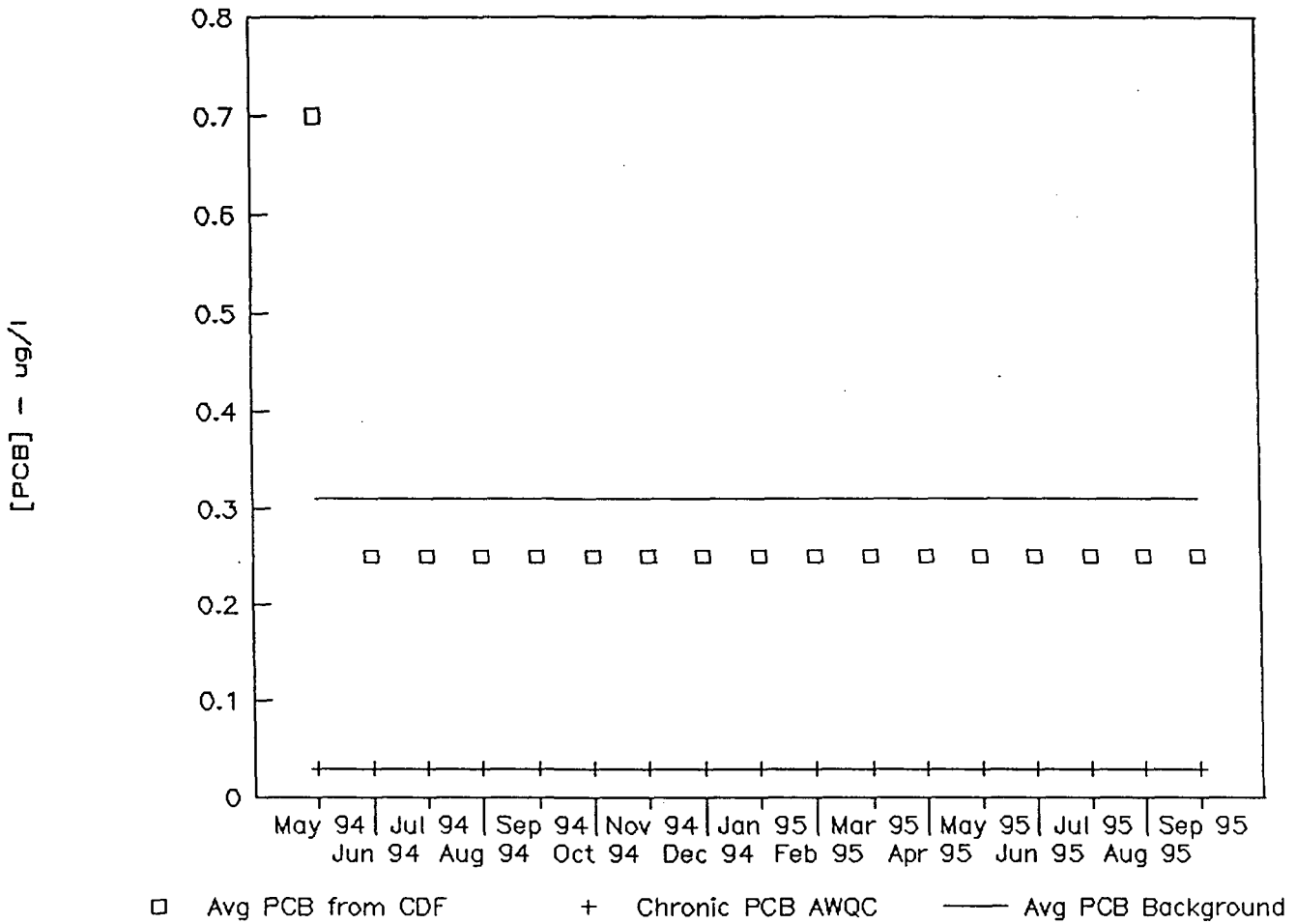

Figure 4-5

Hot Spot Tmt. Plant Copper Discharges

New Bedford Harbor Superfund Site

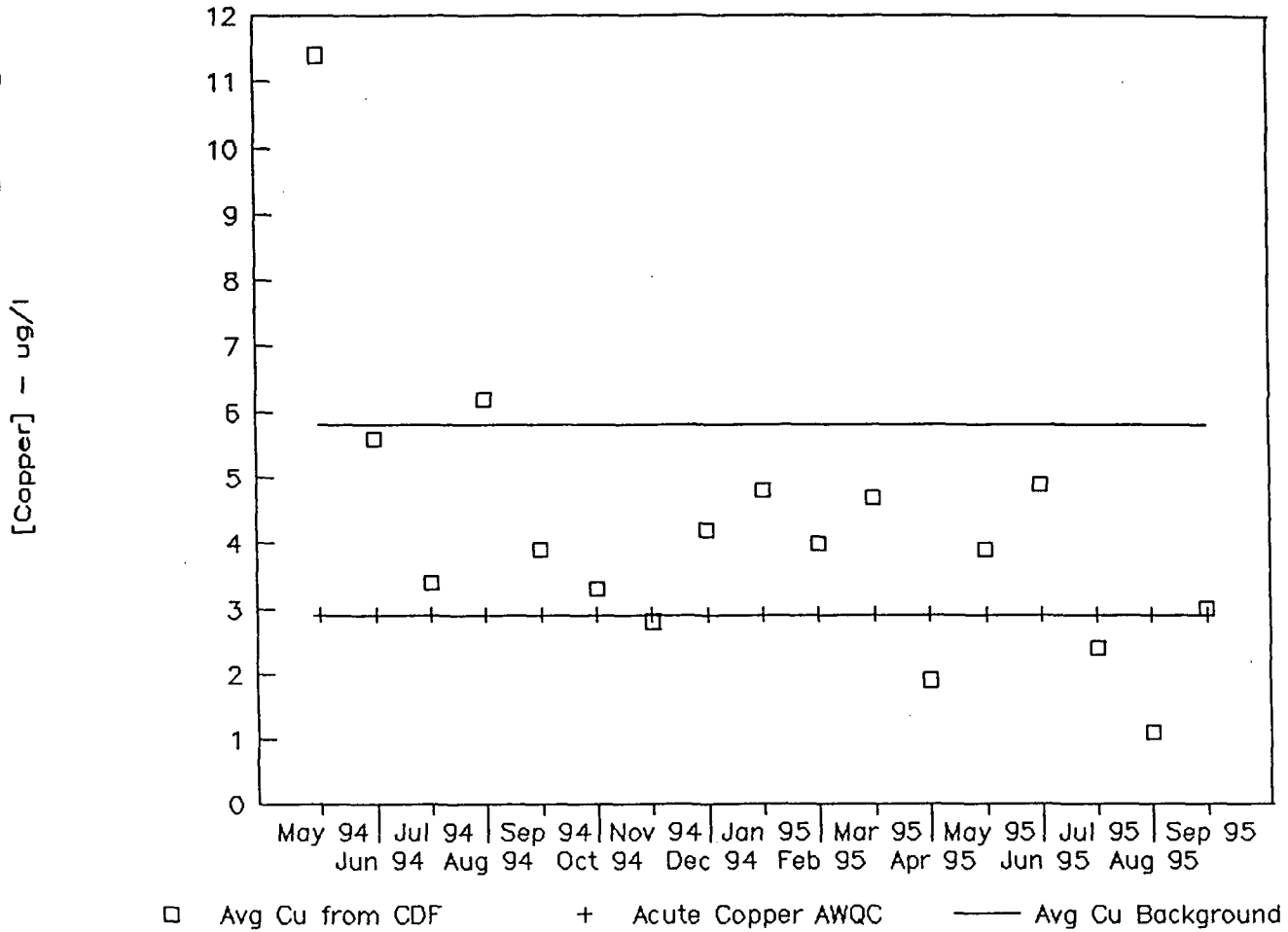
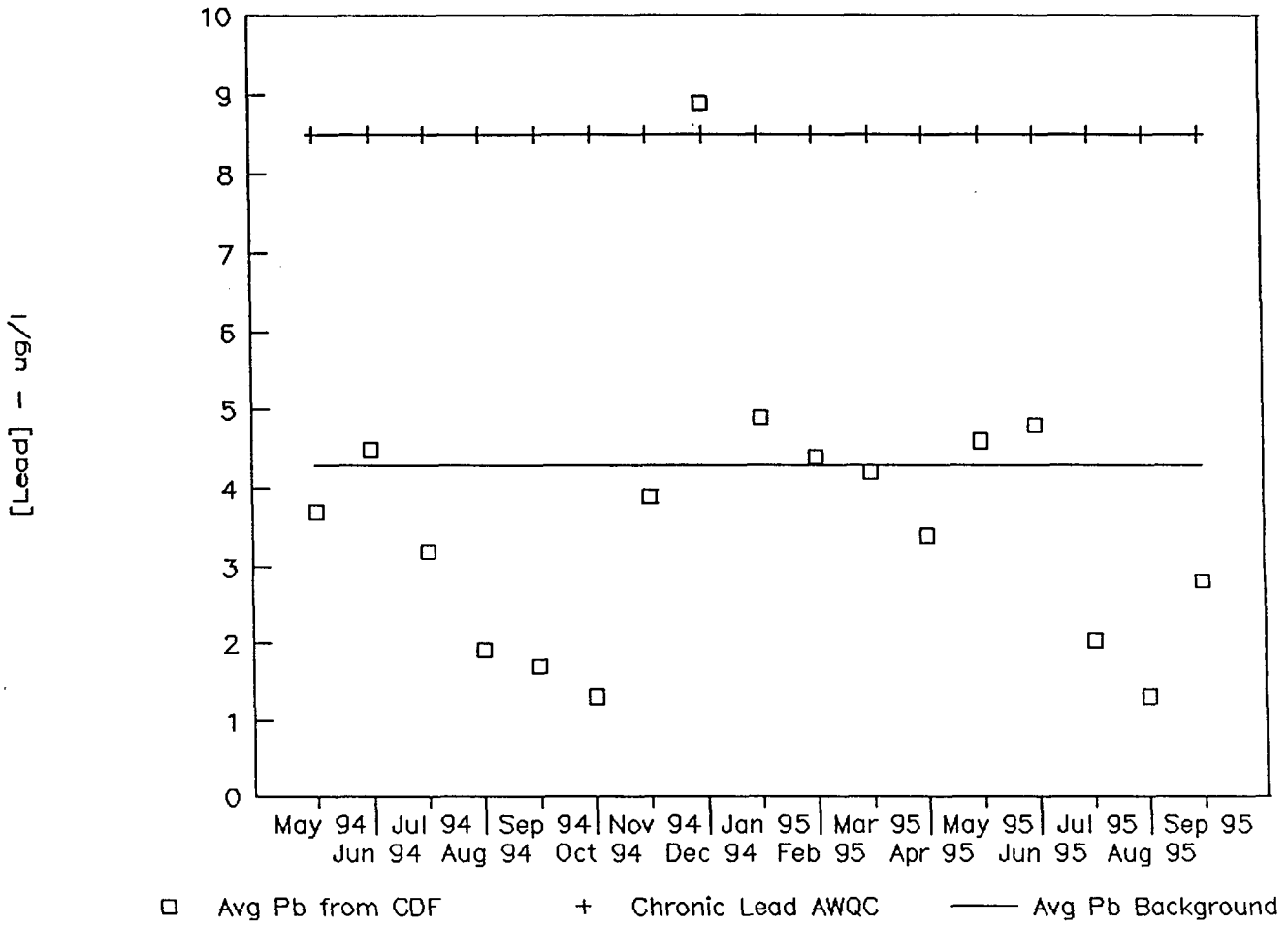

Figure 4-6

Hot Spot Tmt. Plant Lead Discharges

New Bedford Harbor Superfund Site



2, respectively. For Pb on the other hand, although some of the monthly average results are slightly above background, they are, with one minor exception, all below the chronic AWQC. The one exception occurred in December 1994, with an average discharge of 8.9 ug/l (n=13) versus a chronic AWQC of 8.5 ug/l. Since the background Pb level is roughly one-half that of the AWQC, this was not expected to cause adverse impacts due to available dilution in the receiving water and the minor nature of the exceedance. For Cd and Cr, although not displayed, neither the monthly average or daily maximum results ever exceeded chronic AWQC.

Regarding PCB compliance, PCBs were actually detected on only one occasion (5/27/94) at a reported concentration of 4.3 ug/l. Although this exceeded the daily limit of 1.3 ug/l, the monthly average limit of 0.71 ug/l was not exceeded. All other reported discharges were below the detection limit of 0.25 ug/l for both Aroclor 1242 and 1254. As a result, with the assumption that both of these Aroclors were present at one-half the detection limit, discharged PCB concentrations have been reported at 0.25 ug/l.

Regarding heavy metal compliance, the only monthly average limits exceeded were Cu in May 1994 (11.4 ug/l), and Pb in December 1994 (8.9 ug/l) and January 1995 (4.9 ug/l). The May 1994 Cu average and the December 1994 Pb average stand out as anomalies within the data set. The May 1994 Cu average may be due to plant start up, since Cu averages trended downward throughout the rest of the project (Figure 4-5). The December 1994 Pb average may be due to elevated lead levels in the sediment area being dredged at the time, or the fact that roughly half of the lead concentration during this time frame was in the soluble form (additional investigations into dissolved versus particulate Pb fractions were initiated to troubleshoot the Pb problem).

In terms of the in-stream biological effects from the CDF discharge, the aquatic toxicity testing data from NBH-7 demonstrated a lack of significant acute impact compared to control seawater from NBH-5, located approximately 12 km seaward in Buzzards Bay. Please refer to Appendix A for the specific results of the toxicity testing from this station.

D. Conclusions

The ecologically protective strategy of the dredging operations resulted in large volumes of water codredged along with the highly contaminated hot spot sediments. Successful design, construction and operation of the associated CDF and water treatment plant, however, combined to prevent adverse impacts as a result of the discharge of this water. Discharges of Pb, Cd and Cr were generally below chronic marine AWQC, and discharges of PCBs and Cu were generally below background (but above PCB and Cu AWQC). Moreover, the aquatic toxicity testing from station NBH-7 confirmed

a lack of acute biological impacts as a result of the CDF discharge.

The hot spot water treatment experience provided valuable information for the planning and design of the much larger remedy for the upper and lower harbor (USEPA, 1996b), although more influent data would have been beneficial. The technology-based discharge limits for Pb, Cr and Cd, which were below chronic AWQC, were lower than theoretically necessary to protect marine organisms, although the treatment technology was appropriate for the reduction of other pollutants of concern. Ultimately, the protective nature of the water treatment operations cost approximately 0.025 \$/gallon, including the construction and operation costs of the water treatment plant (but excluding those costs for the CDF itself). This cost will be partially offset, however, since the water treatment plant is planned for reuse as part of the remedy for the upper and lower harbor.

V. References

Anderson, P.N. and R.A. Hites. 1996. OH Radical Reactions: the Major Removal Pathway for Polychlorinated Biphenyls from the Atmosphere. Environ. Sci. Technol., 30, 1756-1763.

ATSDR (Agency for Toxic Substances and Disease Registry). 1995. Toxicological Profile for Polychlorinated Biphenyls. Atlanta: ATSDR, draft for public comment.

Bergen, B.J., W.G. Nelson and R.J. Pruell. 1993a. The bioaccumulation of PCB congeners in mussels deployed in New Bedford Harbor. Environmental Toxicology and Chemistry, 12, pp. 1671-1681.

Bergen, B.J., W.G. Nelson and R.J. Pruell. 1993b. The partitioning of PCB congeners in the water column of New Bedford Harbor. Environmental Science and Technology, 27, pp. 938-942.

Ebasco Services, Inc. (Ebasco). 1990. Final Air Monitoring Report: New Bedford Harbor Pilot Dredging and Disposal Study; prepared for USEPA under EPA Contract No. 68-01-7250; Work Assignment No. 04-1L43.

National Institute for Occupational Safety and Health (NIOSH). 1994. NIOSH Pocket Guide to Chemical Hazards; U.S. Department of Health and Human Services/Public Health Service/Centers for Disease Control and Prevention/NIOSH. June 1994.

Nelson, W.G. and D.J. Hansen. 1991. Development and use of site-specific chemical and biological criteria for assessing New Bedford Harbor Pilot Dredging Project. Environmental Management 15(1), pp. 105-112.

Nelson, W.G., R.J. Pruell and D.J. Hansen. 1994. Monitoring plan and decision criteria for remediation of the second operable unit ("Hot spot") at the New Bedford Harbor, MA, Superfund site. U.S. Environmental Protection Agency, Office of Research and Development, NHEERL, Atlantic Ecology Division, Narragansett, RI.

Nelson, W.G., B.J. Bergen and D.J. Cobb. 1995. Comparison of PCB and Trace Metal Bioaccumulation in the Blue Mussel, Mytilus edulis, and the Ribbed Mussel, Modiolus demissus, in New Bedford Harbor, MA. Environmental Toxicology and Chemistry, 14 (3), pp. 513-521.

Nelson, W.G. and T. Gleason. 1995. Deployment and retrieval of caged bivalves for environmental monitoring. Standard Operating Procedure # 1.02.002, U.S. Environmental Protection Agency, Office of Research and Development, NHEERL, Atlantic Ecology Division, Narragansett, RI.

Nelson, W.G., B.J. Bergen, S.J. Benyi, G. Morrison, R.A. Voyer, C.J. Stobel; S. Rego, G. Thursby and C.E. Pesch. 1996. New Bedford Harbor Long-Term Monitoring Assessment Report: Baseline Sampling. U.S. Environmental Protection Agency, National Health and Environmental Effects Research Laboratory, Atlantic Ecology Division, Narragansett, RI. EPA/600/R-96/097.

NUS Corporation (NUS). 1986. Draft Ambient Air Monitoring Program, Acushnet River Estuary, New Bedford, Massachusetts, Volume 1. February 1986.

Silberhorn, E.M.; Glauert, H.P.; and L.W. Robertson. 1990. Carcinogenicity of Polychlorinated Biphenyls: PCBs and PBBs. Crit. Rev. Toxicol. 20(6):439-496.

USACE. 1990. New Bedford Harbor Superfund Pilot Study, Evaluation of Dredging and Dredged Material Disposal; U.S. Army Corps of Engineers, New England Division. May 1990.

USACE. 1991. Specifications (for Construction Contract), Request for Proposal No. DACW45-92-R-0020, Hazardous Waste Cleanup, New Bedford Harbor/Hot Spot Operable Unit, New Bedford, Massachusetts. December 1991.

USEPA. 1990. Record of Decision Summary: New Bedford Harbor/Hot Spot Operable Unit, New Bedford, Massachusetts; U.S. Environmental Protection Agency, Region I. April 1990.

USEPA. 1996a. PCBs: Cancer Dose-Response Assessment and Application to Environmental Mixtures. U.S. Environmental Protection Agency, Office of Research and Development, National Center for Environmental Assessment. Washington, DC. EPA/600/P-96/001F. September 1996.

USEPA. 1996b. Proposed Cleanup Plan, Upper & Lower New Bedford harbor, New Bedford, MA; U.S. Environmental Protection Agency Superfund Program, Region I. November 1996.

Virag, P., N. Feick, D. Hanes, M. Beaudoin and P. L'Heureux. 1996. Ambient Air Monitoring for PCBs at the New Bedford Harbor Superfund Site. Presented at the 89th Annual Meeting of the Air & Waste Management Association. June 1996.

Weston. 1997. Letter report from N. Feick (Roy F. Weston, Inc.) to M. Beaudoin (USACE) regarding airborne PCB data from the New Bedford Harbor air sampling program. September 24, 1997.

**NEW BEDFORD HARBOR "HOT SPOT"
MONITORING REPORT**

Appendix A - Biological Data

Sea Urchin (*Arbacia punctulata*) Sperm Cell Test
Mysid (*Mysidopsis bahia*) Seven-day Survival and Growth Tests
Red Alga (*Champia parvula*) Survival and Reproduction Tests

NEW BEDFORD HARBOR HOT SPOT MONITORING

Biological Testing

SEA URCHIN SPERM CELL TEST

Dates		Percent Fertilization				
Collected	Processed	NBH-1	NBH-7	NBH-2	NBH-4	NBH-5
4/26/94	4/27/94	96	95	93	91	97
4/27/94	4/28/94	99	100	99	99	99
4/28/94	4/29/94	98	99	97	98	99
4/29/94	4/30/94	88	83	92	94	84
5/3/94	5/4/94	95	90	97	96	88
5/4/94	5/5/94	92	91	90	95	94
5/5/94	5/6/94	95	90	93	95	91
5/9/94	5/10/94	100	98	100	98	100
5/10/94	5/11/94	95	94	98	97	96
5/11/94	5/12/94			98		99
5/12/94	5/13/94	93	91	96	90	94
5/17/94	5/18/94			92	94	96
5/18/94	5/19/94	94	93	91	89	95
5/25/94	5/26/94	94	74	82	90	89
5/31/94	6/1/94	63	96	97	93	
6/1/94	6/2/94	74	78	80	78	85
6/6/94	6/7/94	98	98	98	99	97
6/7/94	6/8/94	83	92	84	91	93
6/8/94	6/9/94	79	94	89	96	89
6/10/94	6/11/94	90	93	91	92	97
6/13/94	6/14/94	98	99	99	100	97
6/15/94	6/16/94	92	97	99	97	98
6/16/94	6/17/94	96	95	98	98	97
6/21/94	6/22/94	94	89	91	91	97
6/29/94	6/30/94	93	84	90	86	96
6/30/94	7/1/94	93	85	88	90	92
7/14/94	7/15/94	97	94	93	93	95
7/21/94	7/22/94	95	95	93	90	95
7/22/94	7/23/94	84	92	92	86	90
8/18/94	8/19/94	96	96	95	97	91
8/30/94	8/31/94	98	95	90	94	97
8/31/94	9/1/94	92	94	90	96	95
9/6/94	9/7/94	85	91	92	88	93
9/7/94	9/8/94	91	95	96	96	94
9/12/94	9/13/94	100	99	99	100	99
9/15/94	9/16/94	98	100	97	97	97
9/20/94	9/21/94	93	95	95	96	93
9/21/94	9/22/94	86	91	92	87	92
9/26/94	9/27/94	97	99	97	98	97
9/28/94	9/29/94	91	95	95	94	91
10/3/94	10/4/94	96	96	98	97	97
10/12/94	10/13/94	95	96	95	93	98
10/13/94	10/14/94	96	96	99	94	96
10/18/94	10/19/94	93	94	96	95	96

NEW BEDFORD HARBOR HOT SPOT MONITORING

Biological Testing

SEA URCHIN SPERM CELL TEST (Continued)

Dates		Percent Fertilization				
Collected	Processed	NBH-1	NBH-7	NBH-2	NBH-4	NBH-5
10/19/94	10/20/94	92	96	94	93	94
10/24/94	10/25/94	93	97	97	98	98
10/26/94	10/27/94	94	96	98	94	93
11/3/94	11/4/94	92	89	89	90	94
11/8/94	11/9/94	83	80	87	77	88
11/22/94	11/23/94	94	94	88	96	92
11/23/94	11/25/94	94	94	95	96	97
11/30/94	12/1/94	97	97	96	97	98
12/1/94	12/2/94	94	98	96	97	95
12/6/94	12/7/94	94	92	91	93	95
12/7/94	12/8/94	96	95	93	98	95
12/12/94	12/13/94	96	94	92	91	92
12/14/94	12/15/94	96	95	96	95	97
12/19/94	12/20/94	96	98	96	92	92
12/22/94	12/23/94	94	93	94	96	98
12/28/94	12/29/94	97	95	96	95	97
1/18/95	1/19/95	93	91	88	87	91
1/25/95	1/26/95	88	92	91	93	88
2/1/95	2/2/95	95	96	94	96	97
2/22/95	2/24/95	92	97	92	97	97
3/1/95	3/2/95	97	92	94	97	95
3/8/95	3/9/95	86	84	79	86	88
3/14/95	3/15/95	90	97	87	95	96
3/29/95	3/31/95	95	98	93	96	94
4/12/95	4/13/95	97	97	92	95	96
4/19/95	4/20/95	97	97	92	97	97
4/26/95	4/27/95	90	97	94	93	94
5/2/95	5/4/95	98	96	96	96	97
5/10/95	5/11/95	95	97	96	96	95
6/7/95	6/9/95	98	94	97	96	98
6/20/95	6/22/95	0	94	97	93	97
6/27/95	6/29/95	92	97	94	96	93
7/6/95	7/7/95	96	95	96	94	98
7/11/95	7/12/95	90	91	83	90	88
7/18/95	7/19/95	87	92	92	94	95
7/25/95	7/26/95	97	93	96	96	94
8/2/95	8/3/95	93	95	94	96	96
8/7/95	8/8/95	94	97	86	92	94
8/14/95	8/15/95	80	86	84	84	88
8/21/95	8/23/95	97	99	97	99	100
8/24/95	8/25/95	91	91	89	97	97
8/28/95	8/29/95	95	98	96	96	98
9/5/95	9/7/95	88	84	78	88	86

SEVEN DAY MYSID SURVIVAL (Percent)

Date(s)						
Collected	Processed	NBH-1	NBH-7	NBH-2	NBH-4	NBH-5
4/26-4/29	5/3/94	47.5	60	85	67.5	75
7/18-7/22	7/26/94	95	98	90	98	90
9/26-10/3	10/7/94	97.5	90	85	92.5	77.5
10/17-10/24	10/26/94	87.5	95	100	95	92.5
12/12-12/18	12/19/94	100	95	0	97.5	95
3/20-3/24	3/27/95	95	93	95	93	93
8/7-8/14	8/15/95	92.5	97.5	95	92.5	97.5

SEVEN DAY MYSID GROWTH (Dry wt. - mg.)

Date(s)						
Collected	Processed	NBH-1	NBH-7	NBH-2	NBH-4	NBH-5
4/26-4/29	5/3/94	0.50	1.03	1.18	1.16	1.12
7/18-7/22	7/26/94	1.80	1.82	1.65	1.48	1.73
9/26-10/3	10/7/94	0.42	0.43	0.41	0.37	0.40
12/12-12/18	12/19/94	1.29	1.17		1.31	1.37
3/20-3/24	3/27/95	0.47	0.38	0.39	0.39	0.45
8/7-8/14	8/15/95	0.39	0.37	0.37	0.37	0.33

NEW BEDFORD HARBOR HOT SPOT MONITORING

Biological Testing (Continued)

RED ALGA (Champia) SURVIVAL (Percent)

Date(s)						
Collected	Processed	NBH-1	NBH-7	NBH-2	NBH-4	NBH-5
4/26/94	4/27/94	100	100	100	100	100
4/27/94	4/28/94	100	100	100	100	100
4/28/94	4/29/94	100	100	100	100	100
4/29/94	4/30/94	100	100	100	100	100
5/3/94	5/4/94	100	100	100	100	100
5/4/94	5/5/94	100	100	100	100	66
5/5/94	5/6/94	100	100	100	100	50
5/9/94	5/10/94	100	100	100	100	100
5/10/94	5/11/94	100	100	100	100	100
5/11/94	5/12/94			100		100
5/12/94	5/13/94	100	100	100	100	100
5/17/94	5/18/94			100	100	100
5/18/94	5/19/94	100	100	100	100	100
5/25/94	5/26/94	100	100	100	100	100
5/26/94	5/27/94	100	100	100	100	100
5/31/94	6/1/94	100	100	100	100	75
6/1/94	6/2/94	100	100	100	100	100
6/6/94	6/7/94	100	100	100	100	75
6/7/94	6/8/94	100	100	100	100	75
6/8/94	6/9/94	100	100	100	100	100
6/15/94	6/16/94	100	100	100	100	100
6/16/94	6/17/94	100	100	100	100	100
6/21/94	6/22/94	100	100	100	100	100
6/29/94	6/30/94	100	100	100	100	100
6/30/94	7/1/94	75	75	50	100	45
7/21/94	7/22/94	100	100	100	100	100
7/22/94	7/23/94	50	100	100	100	100
8/9/94	8/10/94	100	75	75	50	10
8/11/94	8/12/94	100	100	100	100	0
8/17/94	8/19/94	75	100	75	50	0
8/30/94	8/31/94	0	0	0	0	0
8/31/94	9/1/94	0	0	0	0	0
9/6/94	9/8/94	50	100	100	100	10
9/7/94	9/9/94	100	50	0	0	70
9/12/94	9/14/94	100	100	100	100	100
9/15/94	9/16/94	100	0	100	0	0
9/20/94	9/21/94	100	100	100	75	100
9/21/94	9/22/94	100	100	100	100	75
9/26/94	9/27/94	100	100	100	100	100
9/28/94	9/29/94	100	100	50	100	50
10/3/94	10/4/94	100	100	100	100	75
10/18/94	10/19/94	100	100	100	100	100

NEW BEDFORD HARBOR HOT SPOT MONITORING

Biological Testing (Continued)

RED ALGA (Champia) SURVIVAL (Percent)

Date(s)						
Collected	Processed	NBH-1	NBH-7	NBH-2	NBH-4	NBH-5
10/19/94	10/20/94	25	100	25	75	50
10/24/94	10/25/94	100	100	100	100	100
10/26/94	10/27/94	100	100	100	100	100
11/3/94	11/4/94	100	100	100	75	100
11/8/94	11/9/94	100	100	100	100	100
11/22/94	11/23/94	100	100	100	75	50
11/23/94	11/25/94	100	100	100	100	100
11/30/94	12/1/94	100	100	100	100	75
12/1/94	12/2/94	100	100	100	100	100
12/6/94	12/7/94	100	100	100	100	100
12/7/94	12/8/94	100	100	100	100	100
12/12/94	12/13/94	100	100	100	100	75
12/14/94	12/15/94	75	75	100	75	100
12/19/94	12/20/94	100	100	100	100	100
12/22/94	12/24/94	100	100	100	100	100
12/28/94	12/29/94	100	100	100	100	75
1/18/95	1/19/95	100	100	100	100	75
1/25/95	1/26/95	100	100	100	100	100
2/2/95	2/4/95	100	100	100	100	100
2/22/95	2/24/95	100	100	100	100	100
3/1/95	3/2/95	100	100	100	100	100
3/14/95	3/15/95	100	100	100	100	100
3/22/95	3/23/95	100	100	100	100	100
3/29/95	3/31/95	100	100	100	100	100
4/12/95	4/13/95	100	100	100	100	100
4/19/95	4/20/95	100	100	100	100	100
4/26/95	4/27/95	100	100	100	100	100
5/2/95	5/3/95	100	100	100	100	100
5/10/95	5/11/95	100	100	100	100	100
6/14/95	6/15/95	100	100	100	100	100
6/20/95	6/21/95	0	100	100	100	100
6/27/95	6/29/95	100	100	100	100	75
7/6/95	7/7/95	100	100	100	100	100
7/11/95	7/12/95	0	100	100	100	100
7/18/95	7/19/95	100	100	100	100	100
7/25/95	7/26/95	100	100	100	100	100
8/2/95	8/3/95	75	100	100	100	100
8/8/95	8/9/95	100	100	100	75	75
8/14/95	8/15/95	100	100	100	100	90
8/21/95	8/22/95	100	100	100	100	100
8/24/95	8/25/95	100	100	100	100	100
8/28/95	8/29/95	100	100	100	100	100
9/5/95	9/6/95	100	100	100	100	100

NEW BEDFORD HARBOR HOT SPOT MONITORING

Biological Testing (Continued)

RED ALGA (Champia) REPRODUCTION (# of Cystocarps)

Date(s)						
Collected	Processed	NBH-1	NBH-7	NBH-2	NBH-4	NBH-5
4/26/94	4/27/94	7.0	11.6	11.4	19.2	22.1
4/27/94	4/28/94	12.3	24.9	16.3	29.9	36.3
4/28/94	4/29/94	8.0	6.3	6.5	11.2	10.0
4/29/94	4/30/94	19.4	23.5	25.6	41.9	32.4
5/3/94	5/4/94	9.7	19.1	24.9	21.7	23.0
5/4/94	5/5/94	1.9	7.8	16.5	26.3	14.7
5/5/94	5/6/94	4.6	3.7	8.2	13.3	0.8
5/9/94	5/10/94	14.3	24.8	22.3	43.3	39.5
5/10/94	5/11/94	4.6	5.6	10.4	15.8	14.2
5/11/94	5/12/94			17.9		23.8
5/12/94	5/13/94	4.2	8.5	13.6	27.0	19.0
5/17/94	5/18/94			18.0	16.4	18.3
5/18/94	5/19/94	12.4	12.9	7.0	16.4	21.6
5/25/94	5/26/94	1.3	4.3	4.8	11.7	5.7
5/26/94	5/27/94	1.9	1.8	3.8	12.5	7.6
5/31/94	6/1/94	0.0	14.4	7.6	31.3	48.9
6/1/94	6/2/94	1.3	16.5	3.3	14.3	11.7
6/6/94	6/7/94	3.6	7.2	3.1	15.7	0.8
6/7/94	6/8/94	10.4	10.9	9.2	19.2	16.8
6/8/94	6/9/94	16.7	42.5	18.5	41.0	2.7
6/15/94	6/16/94	3.7	3.7	5.5	6.1	10.8
6/16/94	6/17/94	2.0	14.2	12.5	14.2	17.7
6/21/94	6/22/94	1.4	0.0	0.4	0.0	1.2
6/29/94	6/30/94	12.7	9.0	17.5	42.3	38.7
6/30/94	7/1/94	2.5	0.6	0.0	1.5	9.4
7/21/94	7/22/94	0.0	0.0	0.0	0.0	0.0
7/22/94	7/23/94	0.0	0.0	0.0	0.0	0.0
8/9/94	8/10/94	6.5	1.4	0.8	14.5	0.1
8/11/94	8/12/94	0.0	0.0	0.0	0.0	0.0
8/17/94	8/19/94	22.8	25.2	16.9	23.4	0.0
8/30/94	8/31/94	0	0	0	0	0
8/31/94	9/1/94	0	0	0	0	0
9/6/94	9/8/94	0	0	0	0	0
9/7/94	9/9/94	0	0	0	0	0
9/12/94	9/14/94	0	0	0	0	0
9/15/94	9/16/94	0	0	0	0	0
9/20/94	9/21/94	10.5	10.7	9.4	6.3	6.7
9/21/94	9/22/94	1.3	3.5	4.5	14.7	6.4
9/26/94	9/27/94	2.6	4.3	3.4	2.4	8.7
9/28/94	9/29/94	7.1	12.7	2.3	10.4	4.3
10/3/94	10/4/94	10.4	17.2	10.7	6.5	0.6
10/18/94	10/19/94	0.4	3.4	2.0	3.6	0.4

NEW BEDFORD HARBOR HOT SPOT MONITORING

Biological Testing (Continued)

RED ALGA (*Champia*) REPRODUCTION (# of Cystocarps)

Date(s)						
Collected	Processed	NBH-1	NBH-7	NBH-2	NBH-4	NBH-5
10/19/94	10/20/94	0.0	6.2	0.0	14.3	8.6
10/24/94	10/25/94	3.5	5.2	6.7	15.5	24.1
10/26/94	10/27/94	3.9	3.2	8.9	9.8	10.8
11/3/94	11/4/94	4.7	13.9	16.3	32.6	33.0
11/8/94	11/9/94	5.4	18.9	17.4	33.0	35.7
11/22/94	11/23/94	2.6	8.6	6.5	38.5	30.3
11/23/94	11/25/94	6.0	4.8	5.7	10.4	10.9
11/30/94	12/1/94	0.0	2.9	7.3	16.1	24.2
12/1/94	12/2/94	13.2	12.8	13.6	22.7	27.3
12/6/94	12/7/94	11.7	11.1	12.5	31.8	32.9
12/7/94	12/8/94	10.8	20.1	17.7	33.6	41.8
12/12/94	12/13/94	22.9	17.8	0.0	21.8	29.3
12/14/94	12/15/94	2.2	2.3	2.5	11.8	7.7
12/19/94	12/20/94	1.8	2.3	1.9	5.1	2.8
12/22/94	12/24/94	3.0	2.7	4.5	7.5	3.1
12/28/94	12/29/94	2.0	7.6	15.1	7.8	3.9
1/18/95	1/19/95	3.9	2.9	0.2	2.3	8.9
1/25/95	1/26/95	44.5	37.9	41.8	53.6	67.1
2/2/95	2/4/95	17.5	20.3	16.3	47.3	30.3
2/22/95	2/24/95	0.0	0.0	0.0	0.1	0.3
3/1/95	3/2/95	3.3	1.8	1.4	19.7	17.9
3/14/95	3/15/95	7.6	6.5	10.6	16.1	6.5
3/22/95	3/23/95	22.9	15.2	24.2	19.0	31.7
3/29/95	3/31/95	4.1	8.3	4.4	9.3	12.0
4/12/95	4/13/95	22.9	15.2	24.2	19.0	31.7
4/19/95	4/20/95	8.1	13.7	7.3	23.9	39.0
4/26/95	4/27/95	9.5	32.2	12.3	27.0	27.0
5/2/95	5/3/95	32.5	20.3	27.1	41.6	34.6
5/10/95	5/11/95	26.3	22.5	14.0	23.2	22.8
6/14/95	6/15/95	0.1	0.1	0.0	0.1	0.9
6/20/95	6/21/95	0.0	16.8	18.1	34.8	31.7
6/27/95	6/29/95	48.1	76.8	67.4	57.3	36.9
7/6/95	7/7/95	40.3	39.1	17.3	56.0	65.4
7/11/95	7/12/95	0.0	27.6	22.5	54.4	58.4
7/18/95	7/19/95	17.1	21.6	17.0	30.9	46.1
7/25/95	7/26/95	16.1	20.9	35.0	28.1	22.8
8/2/95	8/3/95	5.3	15.5	17.6	20.8	20.5
8/8/95	8/9/95	12.7	17.5	17.3	12.5	0.4
8/14/95	8/15/95	31.1	23	29.9	24.9	18.1
8/21/95	8/22/95	18.8	22.7	14.2	7.6	20.2
8/24/95	8/25/95	37.1	31.4	39.7	45.7	24
8/28/95	8/29/95	22.8	19.9	17.1	23.9	19.4
9/5/95	9/6/95	0.75	2.15	1.45	6.1	7.6

APPENDIX B
AIRBORNE PCB DATA BASE

New Bedford Harbor Superfund Site
 Ambient Air Monitoring
 PCB Concentrations (AROCLORS)
 Reported in ng/m³

Sample Locations 22-Sep-97

CDF Area (24 hr)/(8hr)	Sample Date	031194	031294	031394	031494	031694	031794	031894	031994	042594	042694	042694 B
Sampler #1		5.48		25.81			2.69 B					31.23
Sampler #2		11.23		27.22			3.38 B					38.69
Sampler #3		8.33		26.12			6.13					24.92
Sampler #3-D		8.55		26.09			5.88					22.68
Sampler #4		2.57		12.31			2.02 B				14.87	
Sampler #5		2.02 B		11.73			1.59 A				12.09	
Sampler #6		7.58		11.71			3.72 B					12.40

Average On Site (1-3,6) 26.53

Off Site CDF Area (24 hr)	Sample Date	031194	031294	031394	031494	031694	031794	031894	031994	042594	042694	042694 B
Sampler #7		3.10		10.74			1.53 B				8.71	
Sampler #8		2.83		10.39			1.51 B				9.34	
Sampler #9		3.05		40.90			2.56 B				15.46	
Sampler #10		17.36	15.83	21.36	20.06	22.80	20.80	16.88	24.35		0.15 U	

Off Site Dredge Area (8 hr on tide)	Sample Date	031194	031294	031394	031494	031694	031794	031894	031994	042594	042694	042694 B
Tide Level		LOW-B	LOW-B	LOW-B	LOW-B	HIGH-B	HIGH-B	HIGH-B	HIGH-B	LOW-B	HIGH-D	
Sampler #11		43.16	136.00	80.23	219.79	84.95	53.00	47.55	85.52	2886.00	301.49	
Sampler #12		5.63 B	19.30	17.66 B	52.60	22.61	5.75 B	7.42 B	4.35 B	0.50 U	11.73	
Sampler #13		6.78 B	97.49	278.02	164.39	83.14	21.89	43.24	32.16	0.50 U	8.07	
Sampler #13-D		7.27	97.62	335.36	186.58	76.53	28.05	41.25	27.78	0.50 U	6.80	
Sampler #14		3.16 B	5.80 A	14.62 B	6.61	11.66	3.41 A	8.32 B	3.36 A	0.50 U	0.42 U	
Sampler #15		22.40	8.89 B	23.23	11.98	19.31	17.20	12.31	16.88	0.50 U	0.42 U	
Sampler #16		6.06 B	6.73 A	15.84 B	13.77	10.92	10.32	5.88 B	7.53 B	0.50 U	0.43 U	

Average of Dredge 14.57 45.71 76.38 80.04 38.21 19.11 20.62 24.60 481.42 53.65

Environmental Conditions

8 Hour Event	Primary	0800-1800	0900-1800	0900-1900	0930-1830	0700-1500	0700-1500	0800-1600	0900-1700	0900-1800	0500-1300	0700-1500
Ave Wind Direction (Direction/Percent)	Secondary	N/57.89 NNE/37.72	S/33.65 WSW/15.38	SW/85.71 WSW/13.10	S/73.39 SSE/19.26	S/77.33 SW/13.41	NNW/39.18 NW/27.83	SW/36.08 WNW/20.62	NW/82.48 NNW/9.27	NE/54.63 ENE/32.99	ESE/46.39 SE/35.05	ESE/54.18 SE/37.51
Ave Wind Speed (MPH)		13.15	9.12	12.38	5.77	6.93	14.71	9.58	14.77	12.10	8.90	9.35
Ave Solar Radiation (Watt/m ²)		86.45	394.88	329.35	265.48	401.23	348.47	336.89	446.70	158.70	101.00	145.30
Ave Air Temperature (F)		38.16	33.26	43.00	45.83	39.90	33.46	34.14	38.67	46.59	47.24	48.18
Total Precipitation (inches)		0.00	0.00	0.00	0.00	0.00	0.00	0.00	0.07	0.01	0.00	0.00
Tide H/L (MAG) (FT)		4.2/-0.2	4.3/-0.2	4.2/-0.2	4.1/-0.2	3.4/0.0	3.2/0.1	3.0/0.3	3.3/0.4	4.5/-0.9	4.5/-1.0	4.5/-1.0

24 Hour Event	Primary	1200-1200	1200-1200	1200-1200	1200-1200	1200-1200	1200-1200	1200-1200	1200-1200	1200-1200	1200-1200	
Ave Wind Direction (Direction/Percent)	Secondary	NNW/57.48 NNW/22.45	SSW/42.52 SW/31.97	S/24.66 WSW/23.66	N/128.84 S/22.84	WNW/44.98 NW/11.07	NW/52.25 WNW/22.84	NW/39.10 NNW/16.27	NW/52.59 WNW/30.45		ENE/30.46 SE/18.69	
Ave Wind Speed (MPH)		12.14	8.80	6.80	4.70	10.40	12.70	8.60	13.20		8.83	
Ave Solar Radiation (Watt/m ²)		129.46	219.90	168.10	137.70	152.80	215.10	144.50	194.70		83.95	
Ave Air Temperature (F)		35.07	36.33	41.16	40.54	34.35	31.99	32.83	36.41		46.37	
Total Precipitation (inches)		0.00	0.00	0.00	0.00	SNOW/0.1	SNOW	SNOW/0.07	0.00		0.03	
Tide H/L (MAG) (FT)		4.2/-0.2	4.3/-0.2	4.2/-0.2	4.1/-0.2	3.4/0.0	3.2/0.1	3.0/0.3	3.3/0.4		4.5/-1.0	

New Bedford Harbor Superfund Site
 Ambient Air Monitoring
 PCB Concentrations (AROCLORS)
 Reported in ng/m³

Sample Locations 22-Sep-97

CDF Area (24 hr)/(8hr)	Sample Date	042694 C	042794	042794 A	042794 B	042794 C	042894	042894 A	042894 B	042894 C	042994	042994
Sampler #1		32.86		23.78	22.71	15.26		82.30	92.57	59.23		89.90
Sampler #2		39.17		25.74	20.90	31.77		99.66	111.35	64.10		100.29
Sampler #3		18.54		23.33	30.34	18.65		80.42	60.83	43.14		99.99
Sampler #3-D		QA (28)		22.45	32.74	23.50		82.21	QA (51)	45.80		110.98
Sampler #4			11.74				27.32				53.24	
Sampler #5			11.03				21.58				50.98	
Sampler #6		16.74		14.26	11.10	10.37		46.42	42.29	55.32		89.78
Average On Site (1-3,6)		26.83		21.67	21.56	19.62		77.42	76.76	55.78		96.36
Off Site CDF Area (24 hr)												
Sampler #7			12.88				17.46				38.58	
Sampler #8			8.04				15.32				35.66	
Sampler #9			17.32				57.79				63.01	
Sampler #10			5.21				41.53				8.06	
Off Site Dredge Area (8 hr on tide)												
Tide Level			HIGH-D				HIGH-D				HIGH-D	
Sampler #11			824.99				476.76 D				684.69	
Sampler #12			158.19				54.17 R				45.91	
Sampler #13			518.91				65.81				59.86	
Sampler #13-D			QA (710)				17.61 RR				QA (<1.8)	
Sampler #14			0.44 U				4.46				0.42	
Sampler #15			12.06				65.67				10.60	
Sampler #16			0.43 U				NA				0.55	
Average of Dredge			252.50				133.37				133.67	

Environmental
 Conditions

8 Hour Event	1500-2300	0600-1400	2300-700	0700-1500	1500-2300	0600-1500	2300-0700	0700-1500	1500-2300	0700-1600	2300-0700
Ave Wind Direction (Direction/Percent)	Primary NE/25.00 Secondary NNE/20.83	S/58.34 SSW/16.66	NE/25.00 NNE/20.83	S/48.96 SW/19.80	SW/34.38 S/22.92	NNE/38.55 N/16.67	SW/19.79 S/18.76	NNE/38.55 NE/16.68	E/37.51 ENE/31.25	SSE/48.96 S/23.96	NW/33.34 S/18.75
Ave Wind Speed (MPH)	5.90	6.67	4.00	7.80	10.07	11.30	4.10	12.40	8.97	6.32	3.21
Ave Solar Radiation (Watt/m ²)	73.10	357.90	3.50	428.10	231.16	484.65	8.50	538.21	226.54	152.00	4.45
Ave Air Temperature (F)	51.63	54.15	48.40	56.64	62.15	62.19	56.11	63.05	53.68	48.17	45.05
Total Precipitation (inches)	0.00	0.00	0.00	0.00	0.00	0.00	0.00	0.00	0.00	0.01	0.00
Tide H/L (MAG) (FT)	4.5/-1.0	4.5/-0.9	4.5/-0.9	4.5/-0.9	4.5/-0.9	4.3/-0.8	4.3/-0.8	4.3/-0.8	-0.6L	4.1H	-0.5L
24 Hour Event											
Ave Wind Direction (Direction/Percent)	Primary Secondary	1200-1200 S/16.67 NE/15.63				1200-1200 SW/23.61 S/16.66				1200-1200 SW/23.61 S/16.66	
Ave Wind Speed (MPH)		5.65				8.46				8.46	
Ave Solar Radiation (Watt/m ²)		115.10				268.00				267.99	
Ave Air Temperature (F)		50.31				60.82				60.82	
Total Precipitation (inches)		0.00				0.00				0.00	
Tide H/L (MAG) (FT)		4.5/-1.0				4.5/-0.9				4.3/-0.8	

New Bedford Harbor Superfund Site
 Ambient Air Monitoring
 PCB Concentrations (AROCLORS)
 Reported in ng/m³

Sample Locations	22-Sep-97												
CDF Area (24 hr)/(8hr)	Sample Date	A	042994 B	042994 C	043094	043094 A	043094 B	043094 C	050194	050194 A	050194 B	050194 C	050294
Sampler #1			38.56	24.78		27.64	35.46	39.56		31.12	9.18	12.49	
Sampler #2			38.54	24.60		27.29	47.31	45.01		36.02	11.96	11.70	
Sampler #3			42.99	53.97		44.87	116.20	78.87		43.16	52.59	44.04	
Sampler #3-D			40.26	60.05		QA (53)					QA (53)		
Sampler #4					7.20				10.63				2.28
Sampler #5					7.84				9.09				4.01
Sampler #6			54.82	25.61		10.76	40.95	69.36		35.21	13.27	13.24	
Average On Site (1-3,6)			43.39	33.00		27.64	59.98	58.20		36.38	21.75	20.37	
Off Site CDF Area (24 hr)													
Sampler #7					6.17				9.27				1.67
Sampler #8					4.45				8.51				1.61
Sampler #9					5.37				80.76				18.90
Sampler #10					35.63								
Off Site Dredge Area (8 hr on tide)													
Tide Level													HIGH-B
Sampler #11													287.64
Sampler #12													21.04
Sampler #13													79.48
Sampler #13-D													77.85
Sampler #14													0.43
Sampler #15													54.03
Sampler #16													19.25
Average of Dredge													76.84

Environmental
 Conditions

8 Hour Event	0700-1500	1500-2300	2300-0700	0700-1500	1500-2300	2300-0700	0700-1500	1500-2300	2300-0700	0700-1500	1500-2300	1000-1900
Ave Wind Direction (Direction/Percent)	Primary SSE/48.96 Secondary S/23.96	SW/56.25 S/39.59	SW/36.47 WSW/28.13	S/34.38 SSW/11.46	SSE/41.66 S/30.21	S/47.92 SSE/46.87	SW/61.46 SSW/36.46	SW/42.71 WSW/14.59	NW/61.77 NNW/19.60			
Ave Wind Speed (MPH)	6.32	9.94	6.10	8.07	9.71	9.10	10.53	8.70	12.40			
Ave Solar Radiation (Watt/m ²)	152.00	157.79	2.82	504.39	147.79	0.71	134.33	99.01	549.40			
Ave Air Temperature (F)	48.17	50.94	53.87	61.40	58.67	53.16	56.99	58.46	60.44			
Total Precipitation (inches)	0.01	0.00	0.00	0.00	0.00	0.01	0.00	0.02	0.00			
Tide H/L (MAG) (FT)	4.1H	-0.3L	-0.2L	3.9/-0.2	3.9/0.1	4.2/0.1	3.7H	0.3L	3.7H			
24 Hour Event			1200-1200			1200-1200			1200-1200			
Ave Wind Direction (Direction/Percent)	Primary Secondary		SSW/28.13 S/24.31			S/35.08 SSE/32.64			NW/36.45 SW/26.39			
Ave Wind Speed (MPH)			7.65			9.80			9.08			
Ave Solar Radiation (Watt/m ²)			178.56			186.89			147.44			
Ave Air Temperature (F)			53.87			57.55			54.01			
Total Precipitation (inches)			0.00			0.11			0.02			
Tide H/L (MAG) (FT)			4.6/-0.2			0.1/3.7			0'3.9/0.3			

New Bedford Harbor Superfund Site
 Ambient Air Monitoring
 PCB Concentrations (AROCLORS)
 Reported in ng/m³

Sample Locations 22-Sep-97

CDF Area (24 hr)/(8hr)	Sample Date	050294 A	050294 B	050294 C	050394	050394 A	050394 B	050394 C	050494	050494 A	050494 B	050494 C
Sampler #1		19.05	28.03	24.18		14.67	25.68	6.38		10.53	28.91	39.02
Sampler #2		18.48	33.03	34.10		13.36	27.78	40.25		24.99	34.75	63.24
Sampler #3		24.43	19.03	16.70		11.98	79.22	60.46		36.47	136.65	46.26
Sampler #3-D	QA (24)						71.60	QA (63)			QA (160)	48.90
Sampler #4					1.87				NA			
Sampler #5					1.16				5.63			
Sampler #6		9.78	16.92	13.53		7.01	27.70	10.51		13.03	29.21	96.45
Average On Site (1-3,6)		17.94	24.25	22.13		11.76	39.14	21.84		21.26	57.38	61.57
Off Site CDF Area (24 hr)												
Sampler #7					0.94				4.08			
Sampler #8					1.09				4.87			
Sampler #9					2.97				46.70			
Sampler #10									22.61			
Off Site Dredge Area (8 hr on tide)												
Tide Level									HIGH-D			
Sampler #11									387.15			
Sampler #12									36.20			
Sampler #13									88.86			
Sampler #13-D									101.33			
Sampler #14									4.49			
Sampler #15									25.24			
Sampler #16									4.95			
Average of Dredge									92.19			

Environmental
 Conditions

8 Hour Event	Primary	2300-0700	0700-1500	1500-2300		2300-0700	0700-1500	1500-2300	1200-2100	2300-0700	0700-1500	1500-2300
Ave Wind Direction (Direction/Percent)	Secondary	NW/54.16	NW/67.71	NW/83.34		NW/78.12	S/25.00	SSW/77.09	SE/33.33	SW/36.46	S/77.08	E/28.13
		NNW/28.13	NNW/21.88	WNW/11.45		NNW/17.71	N/20.84	SW/17.11	SSE/22.92	WSW/27.09	SSW/8.34	SE/27.08
Ave Wind Speed (MPH)		7.22	11.29	11.71		7.20	9.05	10.90	11.02	4.34	7.24	9.93
Ave Solar Radiation (Watt/m ²)		9.66	572.98	280.15		0.85	561.95	222.00	382.40	0.34	453.36	167.38
Ave Air Temperature (F)		49.64	53.31	51.12		48.12	53.98	54.18	55.64	48.54	57.99	54.22
Total Precipitation (inches)		0.00	0.00	0.00		0.00	0.00	0.00	0.00	0.00	0.00	0.00
Tide H/L (MAG)	(FT)	3.9H	0.3L	0.5L		3.6H	0.5L	0.6L	3.8H	3.5H	0.5 L	3.8 H

24 Hour Event	Primary					1200-1200				1200-1200		
Ave Wind Direction (Direction/Percent)	Secondary					NW/67.01				SSW/39.58		
						NNW/15.28				S/28.12		
Ave Wind Speed (MPH)						9.24				7.47		
Ave Solar Radiation (Watt/m ²)						279.19				228.76		
Ave Air Temperature (F)						53.24				52.16		
Total Precipitation (inches)						0.00				0.00		
Tide H/L (MAG)	(FT)					3.6/0.5				0.6/3.5		

New Bedford Harbor Superfund Site
 Ambient Air Monitoring
 PCB Concentrations (AROCLORS)
 Reported in ng/m³

Sample Locations 22-Sep-97

CDF Area (24 hr)/(8hr)	Sample Date	050794 B	050794 C	050894	050894 A	050894 B	050894 C	050994	050994 A	050994 B	050994 C	051094
Sampler #1		22.05	6.80		42.14	14.44	17.80		13.87	24.34	6.56	
Sampler #2		29.04	5.90		48.02	22.13	21.25		16.31	23.86	6.02	
Sampler #3		356.25			NA	NA	51.76		24.53	84.65	70.17	
Sampler #3-D							QA (59)		QA (21)	QA (95)	61.86	
Sampler #4				1.77				4.64				3.27
Sampler #5				4.07				4.36				3.52
Sampler #6		20.33	4.22		62.66	25.38	17.15		8.13	5.39	5.98	
Average On Site (1-3,6)		106.92	5.64		50.94	20.65	26.99		15.71	34.56	21.14	
Off Site CDF Area (24 hr)												
Sampler #7				4.07				3.28				3.23
Sampler #8				3.48				2.74				3.52
Sampler #9				2.57				NA				33.91
Sampler #10				86.72				41.41				58.31
Off Site Dredge Area (8 hr on tide)												
Tide Level								HIGH-D				HIGH-D
Sampler #11								106.52				269.97
Sampler #12								13.89				37.08
Sampler #13								74.92				115.24
Sampler #13-D								133.00				128.95
Sampler #14								20.32				32.42
Sampler #15								30.34				28.64
Sampler #16								13.37				15.69
Average of Dredge								48.07				84.32
Environmental Conditions												
8 Hour Event		0700-1500	1500-2300		2300-0700	0700-1500	1500-2300	0400-1200	2300-0700	0700-1500	1500-2300	0400-1300
Ave Wind Direction (Direction/Percent)	Primary Secondary	SW/26.0 SSW/14.6	SSW/63.6 SW/35.42		SSE/58.16 SE/25.49	S/26.8 SSW/16.5	S/25.8 SSW/19.6	WNW/74.23 NW/16.49	WNW/41.2 NW/19.6	WNW/45.4 SSW/19.6	WSW/51.6 SW/47.4	WSW/38.75 SW/23.19
Ave Wind Speed	(MPH)	7.7	9.5		12.90	12.5	7.30	8.46	5.10	10.70	13.00	3.80
Ave Solar Radiation	(Watt/m ²)	588.6	243.1		0.27	205.2	41.20	324.80	13.30	574.70	276.10	56.10
Ave Air Temperature	(F)	57.6	55.3		51.11	56.2	59.20	56.94	53.00	61.50	62.00	156.80
Total Precipitation	(inches)	0.00	0.00		0.11	0.12	0.00	0.00	0.00	0.00	0.00	0.00
Tide H/L (MAG)	(FT)	0.3L	4.2H		0.3 L	0.2L	4.3H	4.2H	0.1L	0.1L	4.4H	4.4H
24 Hour Event				1200-1200				1200-1200				1200-1200
Ave Wind Direction (Direction/Percent)	Primary Secondary			SSE/29.00 SSW/25.80				WNW/33.6 NW/13.2				WSW/38.8 SW/23.2
Ave Wind Speed	(MPH)			16.0				7.00				8.95
Ave Solar Radiation	(Watt/m ²)			199.8				175.40				219.80
Ave Air Temperature	(F)			54.5				55.17				58.40
Total Precipitation	(inches)			0.22				0.00				0.00
Tide H/L (MAG)	(FT)			4.3/0.2				0.1/4.2				0.1/4.4

New Bedford Harbor Superfund Site
 Ambient Air Monitoring
 PCB Concentrations (AROCLORS)
 Reported in ng/m³

Sample Locations 22-Sep-97

CDF Area	Sample Date	051094 A	051094 B	051094 C	051194	051194 A	051194 B	051194 C	051294	051294 A	051294 B	051294 C
(24 hr)/(8hr)												
Sampler #1		9.87	16.41	15.21		41.17	26.85	4.60		8.93	7.37	15.69
Sampler #2		10.66	23.58	13.88		34.67	41.60	4.28		8.74	9.66	16.27
Sampler #3		43.31	44.77	49.68		21.43	105.41	146.82		98.22	88.77	41.43
Sampler #3-D		QA (72)	43.71	48.55			91.46	161.25		106.76	QA (150)	
Sampler #4					4.87				3.25			
Sampler #5					4.89				3.51			
Sampler #6		10.55	9.80	4.35		12.77	9.68	4.31		10.70	9.58	11.26
Average On Site (1-3.6)		18.60	23.51	20.64		27.51	44.14	41.81		32.71	28.85	21.16
Off Site CDF Area (24 hr)												
Sampler #7					4.61				3.23			
Sampler #8					4.63				3.52			
Sampler #9					13.87				37.88			
Sampler #10					66.04				35.55			
Off Site Dredge Area (8 hr on tide)												
Tide Level					HIGH-B				HIGH-D			
Sampler #11					160.97				239.02			
Sampler #12					16.30				55.82			
Sampler #13					66.07				215.28			
Sampler #13-D					QA (54)				248.73			
Sampler #14					20.98				18.60			
Sampler #15					17.38				41.68			
Sampler #16					33.43				16.60			
Average of Dredge					52.52				100.62			
Environmental Conditions												
8 Hour Event		2300-0700	0700-1500	1500-2300	0500-1300	2300-0700	0700-1500	1500-2300	0600-1400	2300-0700	0700-1500	1500-2300
Ave Wind Direction (Direction/Percent)	Primary Secondary	WSW/59.8 SW/11.3	WNW/45.4 SSW/19.6	NW/44.8 WSW/26.1	NW/46.87 WNW/31.25	NW/71.9 WNW/12.5	NW/36.5 WNW/24.0	SW/65.63 SSW/31.25	SSW/56.28 SW/32.50	SSW/90.6 SW/9.4	SSW/49.0 SW/35.4	NW/44.8 SW/17.7
Ave Wind Speed (MPH)		7.40	5.40	8.30	8.02	6.50	9.90	13.15	14.53	12.40	14.30	9.10
Ave Solar Radiation (Watt/m ²)		0.84	250.80	166.70	29.30	1.30	585.80	265.95	116.30	0.40	130.40	108.30
Ave Air Temperature (F)		53.50	60.25	62.62	56.70	52.80	60.00	58.42	58.13	55.20	58.80	57.80
Total Precipitation (inches)		0.00	0.00	0.00	0.00	0.00	0.00	0.00	0.00	0.00	0.00	0.01
Tide H/L (MAG) (FT)		0.1L	3.7H	4.3H	3.7H	0.1L	3.7H	4.3H	3.6H	0.0L	3.6H	4.2H
24 Hour Event					1200-1200				1200-1200			
Ave Wind Direction (Direction/Percent)	Primary Secondary				NW/50.5 WNW/16.61				SSW/54.5 SW/38.5			
Ave Wind Speed (MPH)					7.90				13.10			
Ave Solar Radiation (Watt/m ²)					201.80				210.90			
Ave Air Temperature (F)					58.70				58.00			
Total Precipitation (inches)					0.00				0.00			
Tide H/L (MAG) (FT)									4.2/0			

New Bedford Harbor Superfund Site
 Ambient Air Monitoring
 PCB Concentrations (AROCLORS)
 Reported in ng/m³
 Sample Locations 22-Sep-97

CDF Area (24 hr)/(8hr)	Sample Date	051394	051394 A	051394 B	051394 C	051494	051494 A	051494 B	051494 C	051594	051594 A	051594 B
Sampler #1			17.20	36.00	20.69		18.90	46.89	28.71		87.81	32.13
Sampler #2			15.70	45.70	24.97		17.56	76.01	59.13		126.92	37.06
Sampler #3			15.20	16.00	17.58		15.68	27.78	21.36		102.92	527.29
Sampler #3-D				QA (28)	20.33		11.38		QA (13)		QA (130)	339.80
Sampler #4		1.40				3.00				32.44		
Sampler #5		1.70				1.98				26.97		
Sampler #6			4.00	7.00	10.11		8.69	10.70	6.19		94.73	46.49
Average On Site (1-3,6)			13.00	26.20	18.68		14.67	40.35	28.85		103.10	137.31
Off Site CDF Area (24 hr)												
Sampler #7		2.10				1.65				21.86		
Sampler #8		2.00				2.07				30.21		
Sampler #9		11.40				4.09				43.27		
Sampler #10		111.50				76.15						
Off Site Dredge Area (8 hr on tide)												
Tide Level		HIGH-D										
Sampler #11		133.80										
Sampler #12		15.80										
Sampler #13		55.50										
Sampler #13-D												
Sampler #14		7.42										
Sampler #15		35.20										
Sampler #16		15.80										
Average of Dredge		43.90										
Environmental Conditions												
8 Hour Event		0600-1500	2300-0700	0700-1500	1500-2300		2300-0700	0700-1500	1500-2300		0800-1500	0700-1500
Ave Wind Direction (Direction/Percent)	Primary Secondary	NW/86.5 NNW/7.3	NW/85.4 WNW/14.6	NW/85.4 NNW/8.3	NW/69.07 NNW/29.89		WNW/62.88 NW/37.12	NW/72.16 NNW/26.8	NW/49.48 WNW/40.21		N/31.76 ESE/21.17	SSE/45.83 S/40.62
Ave Wind Speed (MPH)		16.30	9.80	17.00	16.69		8.15	17.31	11.70		10.81	7.69
Ave Solar Radiation (Watt/m ²)		473.20	1.31	588.50	305.30		1.48	602.45	306.74		124.91	565.55
Ave Air Temperature (F)		51.60	49.10	51.50	56.80		48.36	57.39	68.76		52.88	63.31
Total Precipitation (inches)		0.00	0.00	0.00	0.00		0.00	0.00	0.00		0.63	0.00
Tide H/L (MAG) (FT)		3.5H	0.0L	3.5H	4.2H		0.1L	3.4H	0.02L		3.4H	3.4H
24 Hour Event		1200-1200					1200-1200				1200-1200	
Ave Wind Direction (Direction/Percent)	Primary Secondary	NW/61.5 SSW/11.1					NW/59.17 WNW/21.8				NW/30.11 WNW/14.88	
Ave Wind Speed (MPH)		11.20					14.22				8.04	
Ave Solar Radiation (Watt/m ²)		152.50					302.50				299.00	
Ave Air Temperature (F)		53.30					53.10				60.79	
Total Precipitation (inches)		0.01					0.00				0.00	
Tide H/L (MAG) (FT)		4.1/0					3.9/0.1				3.9/0.1	

New Bedford Harbor Superfund Site
 Ambient Air Monitoring
 PCB Concentrations (AROCLORS)
 Reported in ng/m³

Sample Locations 22-Sep-97

CDF Area (24 hr)/(8hr)	Sample Date	052094	052594	052694	052794	053194	060194	060294	060394	060694	060794	060894
Sampler #1		24.37	21.15	20.52				50.91	54.14			
Sampler #2		26.60	21.54	26.16				54.24	6.02			
Sampler #3		23.50	100.61	59.90				95.23	43.45			
Sampler #3-D		23.59	80.63	QA (260)				84.38	32.60			
Sampler #4		16.43	6.19	9.54				4.50	10.62			
Sampler #5		27.56	7.65	10.28				3.26	20.36			
Sampler #6		29.23	16.98	24.87				18.45	9.51			
Average On Site (1-3,6)		24.62	27.36	25.21				36.86	23.11			
Off Site CDF Area (24 hr)												
Sampler #7		16.69	6.22					NC				
Sampler #8		6.04	NC					NC				
Sampler #9		9.20	49.76					22.86				
Sampler #10		2.02	15.12		69.19 8	93.49 8	42.72 8	248.70 8	46.72 8	28.06 8	94.52 8	22.35 8
Off Site Dredge Area (8 hr on tide)												
Tide Level			HIGH-D	HIGH-D	HIGH-D	HIGH-D	HIGH-D	HIGH-D	HIGH-D	HIGH-B	HIGH-D	HIGH-D
Sampler #11			206.90	239.56	108.85	242.11	309.27	238.72	354.34	242.40	327.11	842.51
Sampler #12			86.80	66.88	33.66	53.58	115.15	67.06	83.09	71.07	48.93	26.41
Sampler #13			108.76	126.55	23.19	505.97	310.75	63.61	229.77	429.00	149.79	31.67
Sampler #13-D			101.29	114.38	21.62	497.99	QA (110)	45.73	234.73	471.56	132.45	35.81
Sampler #14			10.44	18.05	0.39 U	55.65	30.22	57.25	42.43	16.18	25.00	5.80
Sampler #15			17.07	9.84 RR	55.50	75.03	41.75	276.77	39.36	35.69	61.96	23.04
Sampler #16			3.31 RR	8.16	22.56	50.20	26.68	89.49	25.77	14.74	29.40	13.52
Average of Dredge			71.59	77.16	40.56	163.09	119.12	130.66	115.69	138.39	105.59	157.50

Environmental
 Conditions

8 Hour Event		0430-1230	0530-1330	0630-1430	1000-1800	1100-1900	1130-1930	1230-2030	1500-2300	1530-2330	1600-2400
Ave Wind Direction (Direction/Percent)	Primary Secondary	SSW/63.55 S/24.99	S/37.5 SSE/17.71	NNW/53.12 N/34.38	SW/85.42 WSW/13.54	SW/48.96 SSW/29.16	NW/38.54 WNW/32.29	WSW/36.08 SW/23.72	SSW/83.51 SW/14.43	NW/46.39 WSW/23.71	N/23.45 ENE/15.87
Ave Wind Speed	(MPH)	10.57	7.04	14.1	15.4	10.2	12.7	10.9	12.3	6.4	7.38
Ave Solar Radiation	(Watt/m ²)	244.05	415.55	435.7	657.0	451.3	413.8	494.6	49.5	182.0	210.2
Ave Air Temperature	(F)	58.27	61.44	56.9	68.5	68.2	62.7	67.3	64.8	75.5	67.6
Total Precipitation	(inches)	0.01	0.00	0.00	0.00	0.00	0.00	0.00	0.44	0.00	0.00
Tide H/L (MAG)	(FT)	4.5H	4.5H	4.4H	3.8H	3.8H	3.9H	3.9H	4.3H	4.4H	4.5H
24 Hour Event		1200-1200	1200-1200	1200-1200		1200-1200		1200-1200			
Ave Wind Direction (Direction/Percent)	Primary Secondary	NE/76.73 ENE/15.28	S/40.97 SSE/38.89	S/21.18 SW/20.49		NW/40.28 SW/16.67		NW/57.30 WNW/15.98			
Ave Wind Speed	(MPH)	13.04	9.54	7.52		9.4		10.2			
Ave Solar Radiation	(Watt/m ²)	107.77	241.93	241.63		235.2		237.5			
Ave Air Temperature	(F)	45.77	58.01	63.59		63.3		57.5			
Total Precipitation	(inches)	0.00	0.01	0.25		0.00		0.00			
Tide H/L (MAG)	(FT)	3.6/0.3	5.4/-0.7	5.4/-0.7		3.7/0.7		3.4/1.1			

New Bedford Harbor Superfund Site
 Ambient Air Monitoring
 PCB Concentrations (AROCLORS)
 Reported in ng/m³

Sample Locations 22-Sep-97

Sample Locations	Sample Date	060994	061094	061394	061494	061594	061694	061794	062094	062194	062294	062394
CDF Area (24 hr)/(8hr)												
Sampler #1		35.06	40.17		6.30		51.99				41.85	
Sampler #2		89.98	52.85		5.77		58.77				50.93	
Sampler #3		32.47	134.24		235.30		1852.26				86.74	
Sampler #3-D	QA (49)		111.15		209.65		790.03				QA (76)	
Sampler #4		32.45	41.07		3.52		75.75				3.28	
Sampler #5		40.34	28.68		4.18		80.17				3.64	
Sampler #6		197.47	210.48		5.26		260.74				8.21	
Average On Site (1-3,6)		68.59	82.66		41.25		308.10				46.93	
Off Site CDF Area (24 hr)												
Sampler #7			22.14		3.77						3.04	
Sampler #8			6.48		1.50						3.05	
Sampler #9			18.59		35.25						23.89	
Sampler #10		45.62 8	20.22 8	44.09 8	60.12 8	12.75 8H		20.17 8	11.05 8	25.25 8	78.49 8	62.90 8
Off Site Dredge Area (8 hr on tide)												
Tide Level		HIGH-D	HIGH-D	HIGH-D	HIGH-D	HIGH-B		HIGH-D	HIGH-D	HIGH-D	LOW-B	HIGH-D
Sampler #11		210.07	793.10	195.06	155.21	338.37		240.78	196.26	221.16	411.19	221.93
Sampler #12		20.68	28.07	43.51	47.90	28.81		48.39	52.38	55.80	68.91	30.93
Sampler #13		64.79	41.30	171.16	247.07	55.41		150.17	108.08	155.47	95.47	125.14
Sampler #13-D		63.06	40.32	187.25	244.72	QA (65)		130.59	142.11	152.34	80.13	125.71
Sampler #14		16.78	13.65	22.96	45.46	7.60		7.94	4.05	11.23	7.02	33.71
Sampler #15		42.65	6.23	35.78	52.09	20.52		20.11	10.89	14.74	88.23	44.05
Sampler #16		19.44	5.99	20.97	27.50	12.97		12.62	4.78	10.75	34.16	17.63
Average of Dredge		62.26	147.97	82.92	95.68	77.28		78.37	65.58	77.36	116.22	78.95

Environmental
 Conditions

8 Hour Event	0430-1230	0530-1330	0730-1530	0830-1630	0930-1730	1100-1900	1400-2200	0230-1030	0900-1700	0430-1230
Ave Wind Direction (Direction/Percent)	Primary NNW/45.49 Secondary NW/18.49	not available not available	SW/56.88 WSW/21.10	SW/60.55 SSW/24.77	NNE/25.78 SSE/14.43	SSE/43.27 S/36.54	S/68.76 SSE/30.21	SSW/43.75 S/27.08	WNW/51.04 W/38.55	NNW/46.88 NW/26.04
Ave Wind Speed (MPH)	6.6	7.0	9.4	9.8	7.7	8.8	9.9	6.5	12.4	8.1
Ave Solar Radiation (Watt/m ²)	341.3	457.4	343.4	118.8	489.0	623.1	314.0	143.2	697.0	361.2
Ave Air Temperature (F)	59.9	65.0	70.1	70.6	75.6	72.3	70.4	66.8	78.2	73.5
Total Precipitation (inches)	0.00	0.00	0.37	1.37	0.00	0.00	0.00	0.00	0.00	0.00
Tide H/L (MAG) (FT)	3.7H	3.7H	3.8H	3.8H	3.9H	4.3H	5.1H	4.2H	-0.2L	4.5H

24 Hour Event	1200-1200	1200-1200	1200-1200	1200-1200
Ave Wind Direction (Direction/Percent)	Primary NNW/30.17 Secondary WNW/18.42	WSW/23.54 W/14.88	SW/45.45 WSW/18.18	ENE/24.91 NE/23.87
Ave Wind Speed (MPH)	7.3	8.0	10.5	6.3
Ave Solar Radiation (Watt/m ²)	249.4	313.5	140.9	270.5
Ave Air Temperature (F)	64.4	67.3	70.4	69.1
Total Precipitation (inches)	0.00	0.00	0.71	0.00
Tide H/L (MAG) (FT)	4.5/5	4.5/0.4	4.0/3	3.8/0.6

New Bedford Harbor Superfund Site
 Ambient Air Monitoring
 PCB Concentrations (AROCLORS)
 Reported in ng/m³

Sample Locations 22-Sep-97

CDF Area (24 hr)/(8hr)	Sample Date	062494	062794	062894	062994	063094
Sampler #1		39.01		16.50		16.94
Sampler #2		59.07		12.57		15.21
Sampler #3		95.29		508.99		153.94
Sampler #3-D		86.48		344.83		129.42
Sampler #4		20.40		5.51		3.45
Sampler #5		16.53		9.17		3.83
Sampler #6		38.08		10.81		10.74
Average On Site (1-3,6)		56.76		116.70		46.14
Off Site CDF Area (24 hr)						
Sampler #7						4.97
Sampler #8						4.81
Sampler #9						56.90
Sampler #10		9.37	33.30	40.48	43.81	136.85
Off Site Dredge Area (8 hr on tide)						
Tide Level		HIGH-D	HIGH-B	HIGH-D	HIGH-D	HIGH-B
Sampler #11		473.03	342.22	338.17	312.65	154.19
Sampler #12		41.57	99.33	91.05	113.73	24.58
Sampler #13		50.63	308.72	618.60	257.35	330.32
Sampler #13-D		46.31	301.41	QA (512)	255.44	331.86
Sampler #14		7.27	25.53	24.73	11.75	23.72
Sampler #15		13.93	34.73	44.04	22.22	42.19
Sampler #16		6.36	22.44	26.68	12.71	34.15
Average of Dredge		98.44	138.22	190.55	121.58	101.65

Environmental
 Conditions

8 Hour Event		0500-1300	0730-1530	0830-1630	0930-1730	1000-1800
Ave Wind Direction (Direction/Percent)	Primary Secondary	E/26.05 ENE/17.70	SSW/43.75 S29.17	S/30.9 SSE/25.7	SSE/56.7 S/24.74	SW/50.5 SSW/27.8
Ave Wind Speed (MPH)		4.1	10.0	14.6	10.5	11.1
Ave Solar Radiation (Watt/m ²)		112.6	381.4	413.5	183.2	284.8
Ave Air Temperature (F)		70.1	76.0	74.7	72.6	74.1
Total Precipitation (inches)		0.00	0.00	0.27	1.65	0.00
Tide H/L (MAG)	(FT)	4.6H	4.3H	4.1H	4.0H	3.9H
24 Hour Event		1200-1200		1200-1200		1200-1200
Ave Wind Direction (Direction/Percent)	Primary Secondary	W/27.44 WNW/15.29		S/60.77 SSE/22.91		SW/37.02 SSW/21.8
Ave Wind Speed (MPH)		6.7		14.9		9.1
Ave Solar Radiation (Watt/m ²)		197.3		196.9		98.3
Ave Air Temperature (F)		75.3		75.5		73.2
Total Precipitation (inches)		0.00		0.29		1.98
Tide H/L (MAG)	(FT)	5.3/-0.3				

New Bedford Harbor Superfund Site
Ambient Air Monitoring
PCB Concentrations (AROCLORS)

Reported in ng/m³

Sample Locations 22-Sep-97

CDF Area	Sample Date	070194	070694	070894	071294	071394	071494	071594	071894	071994	072094	072194
(24 hr)/(8hr)												
Sampler #1			22.29	41.75	43.53		38.30				21.28	
Sampler #2			21.23	49.53	97.30		63.25				23.60	
Sampler #3			1649.97	1312.40	735.09		200.95				1032.03	
Sampler #3-D			QA (1690)	986.81	478.43		146.84				QA	
Sampler #4			8.96	40.67	34.97		48.94				5.43	
Sampler #5			18.49	32.57	52.56		36.86				5.68	
Sampler #6			60.06	138.81	134.09		121.67				16.83	
Average On Site (1-3,6)			438.39	344.92	220.42		80.49				273.43	
Off Site CDF Area (24 hr)												
Sampler #7			9.45	21.16	26.30						5.74	
Sampler #8			6.32	17.94	2.98						NA	
Sampler #9			46.98	72.57	22.96						26.88	
Sampler #10		61.16 8H				52.55 8H						
Off Site Dredge Area (8 hr on tide)												
Tide Level		HIGH-B				HIGH-D	HIGH-D	HIGH-B	HIGH-D	HIGH-D	HIGH-D	HIGH-D
Sampler #11		261.83				191.32	296.33	111.69	160.91	218.79	435.97	110.98
Sampler #12		36.20				24.72	10.64	9.06	19.99	55.37	98.03	40.23
Sampler #13		297.03				194.96	7.13	5.68	17.72	291.88	325.63	218.89
Sampler #13-D		274.44				QA (266)	6.21	10.16	19.15	296.39	277.02	220.06
Sampler #14		24.53				38.13	2.80	1.82	2.12	24.81	16.64	61.08
Sampler #15		50.58				50.76	3.34	3.81	9.70	32.79	29.63	50.51
Sampler #16		33.65				30.35	2.59	3.19	4.20	17.60	13.30	19.51
Average of Dredge		117.30				88.37	53.73	22.92	35.89	107.25	149.15	83.63

Environmental
Conditions

8 Hour Event		1100-1900				0800-1600	0900-1700	1000-1800	1300-2100	1400-2200	1430-2230	0300-1100
Ave Wind Direction (Direction/Percent)	Primary Secondary	SW/53.61 SSW/39.17				SW/46.39 SSW/24.75	NE/56.70 E/24.75	E/57.73 ESE/18.56	E/20.26 NE/13.72	SW/64.58 SSW/28.12	S/52.08 SSW/38.54	WSW/39.58 SW/37.5
Ave Wind Speed (MPH)		10.60				9.04	12.2	7.4	5.0	9.5	8.3	6.0
Ave Solar Radiation (Watt/m ²)		615.43				623.52	552.4	91.3	156.0	326.2	284.4	210.2
Ave Air Temperature (F)		80.06				90.09 ?	76.8 ?	69.1	74.7	78.5	81.4	79.7
Total Precipitation (inches)		0.00				0.00	0.00	0.11	0.00	0.00	0.00	0.00
Tide H/L (MAG)	(FT)	3.8H				4.3H	4.3H	4.4H	4.7H	4.9H	5.1H	4.3H

24 Hour Event		0600-0600	1200-1200	1200-1200		1200-1200				1200-1200	
Ave Wind Direction (Direction/Percent)	Primary Secondary	SW/24.22 SSE/20.41	SSE/25.60 SE/14.88	SW/17.65 NW/13.84		SW/30.10 SSW/21.80				SW/28.47 WSW/21.88	
Ave Wind Speed (MPH)		9.48	5.71	6.37		8.6				7.3	
Ave Solar Radiation (Watt/m ²)		265.31	189.05	259.52		257.1				262.8	
Ave Air Temperature (F)		74.64 ?	78.17 ?	76.52 ?		79.56 ?				76.86	
Total Precipitation (inches)		0.00	0.00	0.00		0.00				0.00	
Tide H/L (MAG)	(FT)	4.2/1.1	4.5/0.5	4.5/0.0		4.3H				4.9/0.3	

New Bedford Harbor Superfund Site
 Ambient Air Monitoring
 PCB Concentrations (AROCLORS)
 Reported in ng/m³

Sample Locations 22-Sep-97

CDF Area	Sample Date	072294	072594	072794	080394	080594	080894	080994	081094	081194	081294	081594
(24 hr)/(8hr)												
Sampler #1		7.48	12.87	10.55	13.16	4.50		52.07		34.98		
Sampler #2		5.94	11.64	8.94	13.98	4.62		26.96 E		47.34		
Sampler #3		340.32	705.94 D	262.72	463.46	212.17		475.07		23.96		
Sampler #3-D		236.41	382.21 D	QA	344.28	168.27		357.84		23.32		
Sampler #4		2.65	4.29	NA	3.81	2.70		35.41		12.37		
Sampler #5		2.66	3.77	3.52 RR	3.95	2.37		29.38		2.92		
Sampler #6		4.57	13.69	14.09	9.49	3.28		65.55		26.97		
Average On Site (1-3,6)		51.94	98.39 P	74.08	110.13	50.66		140.26		33.23		
Off Site CDF Area (24 hr)												
Sampler #7			3.65	3.82		2.41		26.07				
Sampler #8			5.31	4.67		3.57		15.87				
Sampler #9			52.45	52.05		43.29		40.72				
Sampler #10												
Off Site Dredge Area (8 hr on tide)		HIGH-D					HIGH-D	HIGH-D	HIGH-D		HIGH-D	HIGH-D
Tide Level		82.46				10.49	34.50	37.74	NC	14.66	56.51	
Sampler #11		103.09				141.73	272.09	224.51	NC	194.73	68.28	
Sampler #12		66.22				32.95	37.74	36.59	NC	54.53	13.54	
Sampler #13		354.81				47.21	82.35	93.77	NC	137.10	126.68	
Sampler #13-D		294.50				47.70	84.59	QA (130)	NC	126.23	111.44	
Sampler #14		57.89				6.49	17.94	30.29	NC	12.25	36.32	
Sampler #15		62.06				18.04	20.80	53.91	NC	10.43	30.76	
Sampler #16		41.02				8.22	15.76	14.34	NC	5.54	10.95	
Average of Dredge		109.16					42.48	74.63	75.57	68.19	57.04	

Environmental
 Conditions

8 Hour Event	0400-1200					0530-1330	0600-1400	0700-1500		0830-1630	1130-193
Ave Wind Direction (Direction/Percent)	Primary SSW/58.33 Secondary SW/34.37					NNE40.2 NE/18.55	WNW/32.99 NW/18.56	WNW/49.48 NW/31.96		SSW/50.52 S/20.61	W/44.79 WSW/23.
Ave Wind Speed (MPH)	13.3					4.8	5.7	8.0		7.8	9.0
Ave Solar Radiation (Watt/m ²)	170.9					400.7	465.5	377.9		413.3	342.5
Ave Air Temperature (F)	79.2					66.6	72.3	75.7		70.5	71.1
Total Precipitation (inches)	0.00					0.00	0.00	0.00		0.08	0.00
Tide H/L (MAG) (FT)	4.5H					4.5/-0.2	4.6/-0.2	4.7/0.0		4.6/0.2	4.5/0.5
24 Hour Event	1200-1200	2400-2400	1200-1200	1200-1200	1200-1200	1200-1200	1200-1200	1200-1200		1200-1200	
Ave Wind Direction (Direction/Percent)	Primary SSW/78.81 Secondary SW/16.67	SW/38.54 SSW/28.13	S/38.20 SW/28.46	SSW/31.15 SW/26.99	SSW/13.49	SW/82.7	S/16.25 SSE/14.88	WNW/20.76 N/19.72			
Ave Wind Speed (MPH)	12.1	6.84	9.4	5.3	11.2		4.9	6.2			
Ave Solar Radiation (Watt/m ²)	257.7	214.2	207.1	144.6	233.8		295.8	170.0			
Ave Air Temperature (F)	81.26	77.4	78.55	78.20	80.56		70.20	70.61			
Total Precipitation (inches)	0.00	0.00	0.21	0.00	0.00		0.00	0.00			
Tide H/L (MAG) (FT)	5.2/0.0	4.6/0.3	4.3/0.4	3.4/0.9	4.3/0.4		4.7/-0.3	4.7/-0.3			

New Bedford Harbor Superfund Site
 Ambient Air Monitoring
 PCB Concentrations (AROCLORS)
 Reported in ng/m³

Sample Locations 22-Sep-97

CDF Area	Sample Date	081694	081794	081994	082294	082394	082494	082594	082694	082994	083094	083194
(24 hr)/(8hr)												
Sampler #1			4.62	18.48		30.30 P		46.43				41.44
Sampler #2			8.99	25.84		38.29 P		53.76				74.22
Sampler #3			117.33	107.82		37.94 P		219.21				57.90
Sampler #3-D			QA (11)	87.07		30.19 P		196.53			QA	
Sampler #4			1.67	18.31		13.84 P		40.98				17.61
Sampler #5			1.13	26.52		23.21 P		32.91				11.59
Sampler #6			2.06	67.30		100.44 P		115.85				37.07
Average On Site (1-3,6)			33.25	52.27		50.77 P		105.98				52.66
Off Site CDF Area (24 hr)												
Sampler #7			0.27 U					29.24				
Sampler #8			0.28 U					33.10				
Sampler #9			38.11					32.89				
Sampler #10												
Off Site Dredge Area (8 hr on tide)		HIGH-D	HIGH-D	HIGH-D	HIGH-D	HIGH-D	HIGH-D	HIGH-D	HIGH-D	HIGH-D	HIGH-D	HIGH-D
Tide Level		44.88	25.19	6.08	3.51	9.64 P	16.92	47.46	60.06	54.86	44.05	30.72
Sampler #11		84.08	218.93	137.48	116.88 RR	116.94 P	132.60	261.77	139.97	98.65	133.60	144.31
Sampler #12		17.79	53.29	36.78	26.00	18.45 P	21.90	18.43	15.90	16.60 B	12.28	39.52
Sampler #13		174.38	203.75	12.62	3.92	13.86 RR	32.95	107.40	117.20	43.05	63.45	189.27
Sampler #13-D		153.33	230.89	7.43 RR	2.87	7.45 RR	33.19	QA (95)	119.83	39.97	56.63	191.99
Sampler #14		44.01	16.48	0.42 U	7.76	0.80 UP	4.64	17.98	25.63	13.38 B	10.21	16.81
Sampler #15		26.15	22.54	12.63	4.60	43.38 P	10.53	21.51	34.55	37.28	46.97	21.58
Sampler #16		14.13	13.81	2.67	NC (Short)	0.87 UP	5.31	12.80	14.74	11.85 B	11.12	13.78
Average of Dredge		58.34	90.40	33.34	31.73	38.04 P	34.68	73.31	58.22	36.54	52.62	71.10

Environmental
 Conditions

8 Hour Event		1230-2030	1330-2130	0300-1100	0500-1300	0600-1400	0630-1430	0700-1500	0800-1600	1030-1830	1130-1930	1230-2030
Ave Wind Direction (Direction/Percent)	Primary Secondary 7	SW/32.29 SSW/30.20	SSE/48.95 S/39.59	NNE/60.41 NE/39.58	NNE/67.71 ENE/29.17	NNE/87.51 NE/10.42	NNE/35.42 S/14.58	WSW/31.26 S/25.00	SSW/33.33 SW/25.00	WSW/27.08 WNW/19.79	WNW/42.71 W/29.18	SE/50.00 SSE/30.21
Ave Wind Speed (MPH)		8.7	7.3	7.9	7.7	18.0	5.9	7.7	7.9	6.8	9.4	9.9
Ave Solar Radiation (Watt/m ²)		399.4	142.1	27.7	28.0	457.0	473.6	499.1	487.3	135.9	484.7	199.8
Ave Air Temperature (F)		73.2	73.7	68.9	72.0	64.3	66.8	69.3	75.8	66.1	72.8	71.5
Total Precipitation (inches)		0.00	0.00	0.00	0.92	0.00	0.00	0.00	0.00	0.26	0.00	0.00
Tide H/L (MAG) (FT)		4.6/0.4	4.7/0.2	4.3/0	4.7/0.0	4.6/0.1	4.5/0.3	4.3/0.2	4.1/0.3	3.6H	3.6H	3.8H
24 Hour Event			1200-1200	1200-1200		1200-1200		1200-1200				1200-1200
Ave Wind Direction (Direction/Percent)	Primary Secondary		SSW/44.79 S/25.70	NNE/25.35 SSW/21.18		NNE/50 NE44.45		S/14.24 SSE/13.19				W/21.87 WSW/18.75
Ave Wind Speed (MPH)			7.1	9.3		15.0		4.5				6.0
Ave Solar Radiation (Watt/m ²)			224.9	101.6		122.6		249.4				230.0
Ave Air Temperature (F)			71.09	73.92		64.7		67.19				67.8
Total Precipitation (inches)			0.00	0.00		0.00		0.00				0.0
Tide H/L (MAG) (FT)			3.9/0.2	4.8/0.1		4.6/-0.1		3.8/0.2				3.2/1.1

New Bedford Harbor Superfund Site
 Ambient Air Monitoring
 PCB Concentrations (AROCLORS)
 Reported in ng/m³
 Sample Locations 22-Sep-97

CDF Area	Sample Date	090194	090294	090694	090794	090894	090994	091294	091394	091494	091594	091694
(24 hr)/(8hr)												
Sampler #1			33.87		22.04		9.22 RR			34.00		75.36
Sampler #2			35.97		46.25		40.58			80.49		79.19
Sampler #3			34.49		47.40		107.00			10.36		97.50
Sampler #3-D			35.38		43.76		104.13			23 QA		89.35
Sampler #4			19.91		2.10		30.07			5.83		93.74
Sampler #5			21.70		2.02		3.78 RR			3.17		78.47
Sampler #6			126.37 RR		3.57		21.11			11.99		325.75
Average On Site (1-3,6)			57.79		29.36		35.05			34.21		143.43
Off Site CDF Area (24 hr)												
Sampler #7			9.55		0.14 U					2.76		
Sampler #8			5.85		0.14 U					1.66		
Sampler #9			6.91		5.93					6.21		
Off Site Dredge Area (8 hr on tide)		HIGH-D	HIGH-D	HIGH-D	HIGH-D	HIGH-D	HIGH-D	HIGH-D	HIGH-D	HIGH-D	HIGH-D	HIGH-D
Tide Level		4.52	25.53	36.35	20.17	43.59	36.94	47.45	35.66	6.72	6.36	18.02
Sampler #11		98.77	72.73	104.29	138.50	131.44	297.74	126.81	176.56	114.90	161.85	167.58
Sampler #12		14.01	14.76	18.28	24.12	14.64	51.60	20.37	18.11	20.15	27.29	29.21
Sampler #13		12.31	5.86	20.67	65.29	81.63	217.66	24.83	104.51	9.89	18.32	65.27
Sampler #13-D		0.44	11.58	23.68	QA (72)	85.18	132.28	29.36	97.67	7.93	15.35	56.02
Sampler #14		0.42	0.39	0.39 U	18.86	26.45	33.02	2.99	17.43	0.41 U	4.31	7.91
Sampler #15		4.42	7.20	32.50	21.55	35.01	37.96	51.62	60.34	9.63	6.45	15.57
Sampler #16		3.89	12.72	11.09	16.41	12.01	20.67	12.35	11.85	0.41 U	3.69	16.00
Average of Dredge		21.32	19.42	31.45	47.46	50.49	102.66	40.21	64.23	25.90	36.74	49.49

Environmental Conditions

8 Hour Event	Primary	1330-2130	0200-1000	0500-1300	0530-1330	0630-1430	0700-1500	1000-1800	1130-1930	1230-2030	1330-2130	0130-0930
Ave Wind Direction (Direction/Percent)	Secondary	NNE/22.92 NE/18.74	NW/42.71 NNW/34.37	WNW/50.00 NNW/25.01	WSW/35.41 SW/24.99	WSW/32.99 SW/21.65	SE/53.13 SSE/22.93	NW/50.00 NNW/32.29	WNW/30.93 W/28.87	NNE/30.93 NE/28.87	NE/40.21 ENE/29.90	NE/28.87 NNE/16.49
Ave Wind Speed (MPH)		7.9	6.8	10.9	7.0	9.3	8.3	11.5	8.3	6.6	6.5	2.9
Ave Solar Radiation (Watt/m ²)		176.2	108.2	194.3	357.6	422.7	462.4	533.1	367.2	152.7	298.9	83.8
Ave Air Temperature (F)		70.6	57.5	59.7	65.7	68.1	72.6	70.7	79.4	67.4	67.4	59.4
Total Precipitation (inches)		0.00	0.00	0.00	0.00	0.00	0.00	0.00	0.00	0.00	0.00	0.00
Tide H/L (MAG)	(FT)	4.0H	4.3H	4.9H	5.1H	5.1H	5.0H	4.8H	4.3H	4.3H	4.4H	4.1H
24 Hour Event			1200-1200		1200-1200		1200-1200			1200-1200		1200-1200
Ave Wind Direction (Direction/Percent)	Primary Secondary		NNE/21.33 NW/18.51		WSW/29.17 SW/19.79		SE/37.49 SSE/15.63			WSW/24.57 SW/23.53		NE/33.22 ENE/20.76
Ave Wind Speed (MPH)			7.3		7.3		6.9			7.0		4.9
Ave Solar Radiation (Watt/m ²)			188.6		186.7		232.7			146.3		213.2
Ave Air Temperature (F)			65.20		64.0		69.9			75.2		63.6
Total Precipitation (inches)			0.00		0.00		0.00			0.01		0.00
Tide H/L (MAG)	(FT)		3.7/0.7		4.8/-0.6		4.3/-0.2			3.7/0.4		4.1/0.3

New Bedford Harbor Superfund Site
 Ambient Air Monitoring
 PCB Concentrations (AROCLORS)
 Reported in ng/m³
 Sample Locations 22-Sep-97

Sample Date	091994	092094	092194	092294	092394	092694	092794	092894	092994	093094	100394
CDF Area (24 hr)/(8hr)											
Sampler #1		35.22		30.20				17.40		13.26	
Sampler #2		46.32		39.99				21.53		50.45	
Sampler #3		23.97		156.39				102.70		16.99	
Sampler #3-D		20.35		148.55				<0.2 QA		14.06	
Sampler #4		7.07		32.60				17.02		1.33	
Sampler #5		5.51 RR		43.64				16.47		1.29	
Sampler #6		16.26		67.76 RR				119.58		2.97	
Average On Site (1-3,6)		29.99		72.61				65.30		20.55	
Off Site CDF Area (24 hr)											
Sampler #7				23.80						0.13 U	
Sampler #8				15.09						0.14 U	
Sampler #9				40.51						3.85	
Off Site Dredge Area (8 hr on tide)	HIGH-D	HIGH-D	HIGH-D	HIGH-D	HIGH-D	HIGH-D	HIGH-D	HIGH-D	HIGH-D	HIGH-D	HIGH-D
Tide Level	26.46	25.10	15.42	3.75	0.41 U	0.43 U	1.87	16.93	44.43	23.72	15.35 RR
Sampler #11	61.89	58.59	409.37	86.15	52.34	26.94	49.82	224.96	67.01	111.65	73.92
Sampler #12	13.72 B	24.66	39.77	17.63	0.43 U	0.44 U	3.64	46.87	8.49	7.02	7.23 B
Sampler #13	37.08	32.37	128.29	7.86	0.43 U	6.74	3.95	83.02 RR	34.17	25.72	9.75 B
Sampler #13-D	33.17	30.20	102.20	4.2 QA	0.43 U	8.58	3.30	102.78	32.06	24.59	0.40 U
Sampler #14	12.23 B	6.01	12.98	0.40 U	0.41 U	0.42 U	0.40 U	5.77	13.82	3.68	12.62 B
Sampler #15	23.23	21.30	15.78	5.47	0.41 U	0.42 U	0.41 U	11.75	17.94	35.77	27.71
Sampler #16	12.36 B	13.14	5.75	0.40 U	0.41 U	0.41 U	0.41 U	8.23	9.05	8.91	7.56 B
Average of Dredge	26.43	25.83	99.82	19.65	9.07	6.05	9.72	65.08	24.90	32.03	22.35

Environmental
 Conditions

8 Hour Event	0400-1200	0430-1230	0530-1330	0600-1400	0630-1430	0900-1700	1000-1800	1100-1900	1200-2000	1300-2100	0250-1050
Ave Wind Direction (Direction/Percent)	Primary W/39.17 Secondary WNW/28.86	NNW/19.59 N/17.53	SSE/32.99 NE/16.49	ENE/52.58 NE/27.83	ESE/59.28 SE/33.57	SE/28.86 SSE/25.77	ENE/49.48 NE/22.68	S/51.55 SSE/43.30	W/43.30 WSW/21.65	NW/56.71 WNW/42.27	NW/47.42 WNW/27.83
Ave Wind Speed (MPH)	5.8	3.9	4.0	8.8	18.6	5.4	7.8	10.0	10.0	13.2	9.7
Ave Solar Radiation (Watt/m ²)	241.0	265.2	332.3	183.8	37.7	116.6	207.6	399.1	278.0	286.1	133.1
Ave Air Temperature (F)	57.79	58.61	66.33	63.27	70.18	65.48	65.09	71.00	65.06	60.57	44.91
Total Precipitation (inches)	0.00	0.00	0.00	0.00	1.83	0.00	0.00	0.00	0.00	0.00	0.00
Tide H/L (MAG) (FT)	4.6H	4.7H	4.6H	4.5H	4.3H	3.6H	3.5H	3.5H	3.6H	3.8H	4.6H
24 Hour Event		1200-1200		1200-1200				1200-1200		1200-1200	
Ave Wind Direction (Direction/Percent)	Primary Secondary	NW/31.49 WNW/20.76		SSE/34.95 ENE/20.76				SSE/19.72 ENE/16.26		W/44.98 WNW/29.41	
Ave Wind Speed (MPH)		6.6		6.7				6.5		10.4	
Ave Solar Radiation (Watt/m ²)		198.4		174.5				122.2		161.0	
Ave Air Temperature (F)		60.94		66.83				67.47		60.09	
Total Precipitation (inches)		0.00		0.00				0.11		0.00	
Tide H/L (MAG) (FT)		4.7/0.0		4.5/0.0				3.1/0.8		3.4/0.8	

New Bedford Harbor Superfund Site
 Ambient Air Monitoring
 PCB Concentrations (AROCLORS)
 Reported in ng/m³

Sample Locations 22-Sep-97

CDF Area (24 hr)/(8hr)	Sample Date:	100494	100594	100694	100794	100894	101194	101294	101394	101494	101794	101894
Sampler #1		29.99		21.53	29.83	19.24		30.94		12.69		25.36
Sampler #2		40.59		31.97	37.84	19.88		26.98		15.83		37.91
Sampler #3		14.68		15.12	79.07	76.86		20.83		57.13		29.96
Sampler #3-D		14 QA		14.14	76.39	70.08		23 QA		42.46		19 QA
Sampler #4		3.49		2.68	19.83	8.89		22.31		5.60 B		17.53
Sampler #5		2.38		1.55	19.08	8.89		26.14		5.38 RR		24.24
Sampler #6		15.82		4.33	27.09	12.70		42.65		16.20		60.03
Average On Site (1-3,6)		25.27		18.11	43.12	31.32		30.35		23.63		38.31
Off Site CDF Area (24 hr)												
Sampler #7		1.55						14.89				
Sampler #8		1.67						0.13 RR				
Sampler #9		2.64						16.74				
Sampler #10												
Off Site Dredge Area (8 hr on tide)		HIGH-D	HIGH-D	HIGH-D	HIGH-D		HIGH-D	HIGH-D	HIGH-D	HIGH-D	HIGH-D	HIGH-D
Tide Level		23.58	22.99	NC	NC		13.67	4.20	25.68	17.75 B	11.92	24.27
Sampler #11		49.19	96.70	NC	NC		48.97	68.71	86.73	18.03 B	39.05	51.93
Sampler #12		9.20	11.34	NC	NC		9.91	8.45	19.51 B	32.13	5.53	15.31
Sampler #13		4.30 E	16.39	NC	NC		4.47	4.99	114.94	63.24	3.50	7.54
Sampler #13-D		6.15	16.72	NC	NC		3.94	4.05	140 QA	63.00	3.66	6.78
Sampler #14		0.41 U	0.41 U	NC	NC		0.41 U	0.83	7.90 A	15.78 B	2.04	0.41 U
Sampler #15		7.05	16.67	NC	NC		8.64	5.61	30.33	8.82 A	13.71	9.76
Sampler #16		11.42	8.84	NC	NC		0.40 U	3.94	11.17 B	6.93 B	6.87	5.89
Average of Dredge		13.75	25.09				12.09	15.34	45.10	24.14	11.80	15.08

Environmental
 Conditions

8 Hour Event		0330-1130	0420-1220				1000-1800	1100-1900	1200-2000	0030-0830	0300-1100	0330-1130
Ave Wind Direction (Direction/Percent)	Primary	NW/71.13	WNW/72.16				NNE/55.7	ENE/25.8	ESE/37.1	SSW/28.9	NNE/42.27	NNW/26.81
	Secondary	NNW/16.49	NW/25.78				N/30.9	NE/24.8	SE/23.7	SW/20.6	NNE/23.71	NNE/26.80
Ave Wind Speed (MPH)		8.5	7.4				11.9	7.7	6.5	3.6	9.0	4.5
Ave Solar Radiation (Watt/m ²)		162.5	135.1				425.7	376.3	306.3	17.0	139.3	153.8
Ave Air Temperature (F)		47.36	49.89				51.6	56.0	60.74	51.93	46.46	46.66
Total Precipitation (inches)		0.00	0.00				0.0	0.0	0.00	0.00	0.00	0.00
Tide H/L (MAG)	(FT)	5.0H	5.2H				4.3H	4.1H	4.0H	3.9H	4.4H	4.5H

24 Hour Event		1200-1200		1200-1200	1800-1800	1800-1800		1200-1200		1200-1200		1200-1200
Ave Wind Direction (Direction/Percent)	Primary	NW/52.94		WNW/65.63	NNE/24.91	S/23.52		NNE/30.8		SSW/21.5		NNE/41.52
	Secondary	NNW/23.87		NW/23.61	SSE/18.34	SE/21.45		N/23.6		SW/13.9		N/22.50
Ave Wind Speed (MPH)		8.8		6.2	4.7	6.4		6.0		5.2		7.9
Ave Solar Radiation (Watt/m ²)		192.3		120.8	169.7	166.5		157.1		164.2		169.9
Ave Air Temperature (F)		51.06		50.27	53.65	60.26		44.50		56.18		49.43
Total Precipitation (inches)		0.00		0.00	0.00	0.00		0.00		0.00		0.00
Tide H/L (MAG)	(FT)	5.0/-0.4		5.3/-0.8	5.3/-0.8	5.1/-0.6		4.6/0.2		4.1/0.3		4.5/0.1

New Bedford Harbor Superfund Site
 Ambient Air Monitoring
 PCB Concentrations (AROCLORS)
 Reported in ng/m³

Sample Locations 22-Sep-97

CDF Area (24 hr)/(8hr)	Sample Date	101994	102094	102194	102494	102594	102694	102794	102894	103194	110194	110294
Sampler #1			27.75				19.32		45.92		30.25	
Sampler #2			29.65				19.55		46.14		29.81	
Sampler #3			296.92				94.31		32.65		206.87	
Sampler #3-D			335.18				53 QA		32.09		172.79	
Sampler #4			15.21				4.88		26.99		15.23	
Sampler #5			12.37				4.06		27.10		65.99	
Sampler #6			41.68				17.31		74.68		35.57	
Average On Site (1-3,6)			103.78				37.62		49.78		71.37	
Off Site CDF Area (24 hr)												
Sampler #7			11.17						22.11		17.36	
Sampler #8			10.21						11.34		12.92	
Sampler #9			63.27						5.99		60.94	
Off Site Dredge Area (8 hr on tide)		HIGH-D	HIGH-D	HIGH-D	HIGH-D	HIGH-D	HIGH-D	HIGH-D	HIGH-D	HIGH-D	HIGH-D	HIGH-D
Tide Level		12.35	0.37 U	30.47	22.71 A	21.72	23.45	17.23	42.00	20.78	0.40 U	40.09
Sampler #11		228.30	148.20	60.07	100.87 B	218.37	40.78	76.57	49.32	183.86	45.67	33.60
Sampler #12		32.25	56.59	26.70	15.25 E	55.58	12.63	19.74	10.26	37.02	60.90	12.53
Sampler #13		39.71	73.57	8.01	29.94 A	134.01	14.97	17.27	70.87	60.30	69.29	102.58
Sampler #13-D		27.92	52 QA	6.23	43.37 A	135.17	<0.8 QA	15.95	70.81	62.92	75.97	113.53
Sampler #14		5.61	0.41 U	0.41 U	0.40 U	12.72	0.40 U	0.40 U	20.05	16.79	0.40 U	55.26
Sampler #15		13.05	5.49	31.21	29.48 A	25.21	23.28	42.42	19.22	17.85	5.54	36.80
Sampler #16		8.06	0.39 U	9.78	7.79 A	13.43	11.70	0.41 U	13.55	18.21	0.41 U	12.28
Average of Dredge		53.51	47.44	22.55	31.74	76.65	17.29	26.03	30.54	55.89	30.93	43.09

Environmental
Conditions

8 Hour Event	Primary	0400-1200	0500-1300	0530-1330	0730-1530	0830-1630	0915-1715	1015-1815	1100-1900	0100-0900	0130-0930	0200-1000
Ave Wind Direction (Direction/Percent)	Secondary	SE/24.74	SE/44.32	N/63.91	WNW/30.21	ENE/24.74	N/37.50	NNE/36.46	SW/19.59	NNE/21.65	SE/80.42	SW/56.70
Ave Wind Speed (MPH)		3.9	7.3	10.3	7.5	8.1	6.7	7.3	8.8	2.4	8.3	12.0
Ave Solar Radiation (Watt/m ²)		61.3	83.3	103.7	370.1	287.1	163.5	205.6	308.5	15.5	14.9	7.4
Ave Air Temperature (F)		55.96	62.08	60.82	62.58	61.66	54.51	54.97	57.16	52.13	66.87	56.64
Total Precipitation (inches)		0.01	0.00	0.00	0.02	0.00	0.00	0.00	0.00	0.00	0.11	0.02
Tide H/L (MAG) (FT)		4.6H	4.5H	4.4H	3.8H	3.6H	3.5H	3.5H	3.5H	4.3H	4.7H	5.1H

24 Hour Event	Primary	1200-1200					1200-1200		1200-1200		1200-1200	
Ave Wind Direction (Direction/Percent)	Secondary	SE/57.78	ESE/22.50				ENE/16.90	NNW/16.20	NNE/32.18	N/16.95	SE/64.71	ESE/25.60
Ave Wind Speed (MPH)		7.0					6.9		5.1		7.5	
Ave Solar Radiation (Watt/m ²)		74.3					107.9		115.0		79.2	
Ave Air Temperature (F)		60.66					56.53		48.02		64.30	
Total Precipitation (inches)		0.00					0.00		0.00		0.14	
Tide H/L (MAG) (FT)		4.5/0.0					3.1/0.6		3.3/0.6		4.7/-0.3	

New Bedford Harbor Superfund Site
 Ambient Air Monitoring
 PCB Concentrations (AROCLORS)
 Reported in ng/m³

Sample Locations 22-Sep-97

CDF Area (24 hr)/(8hr)	Sample Date	110394	110494	110794	110894	110994	111094	111194	111494	111594	111694	111794
Sampler #1		18.37				10.21		16.21		5.19		37.78
Sampler #2		24.40				19.51		19.87		6.54		29.27
Sampler #3		9.54				21.09		7.65		6.33		29.84
Sampler #3-D		9.62				20.9 QA		7.26		46 QA		23.72
Sampler #4		0.14 U				1.69		0.54		1.17		29.27
Sampler #5		0.14 U				1.40		0.14 U		1.09		32.47
Sampler #6		2.33				1.37		5.13		1.79		132.10
Average On Site (1-3,6)		13.67				13.05		14.03		4.96		56.48
Off Site CDF Area (24 hr)												
Sampler #7						0.14						35.59
Sampler #8						0.14						10.12
Sampler #9						8.24						17.89
Off Site Dredge Area (8 hr on tide)		HIGH-D	HIGH-D	HIGH-D	HIGH-D	HIGH-D	HIGH-D	HIGH-D	HIGH-D	HIGH-D	HIGH-D	MOVE TO F
Tide Level		48.97	0.41 U	96.78	48.13	21.67	36.42	31.40	19.11	39.79	10.09	6.23
Sampler #11		40.73	65.16	87.25	41.00	37.84	57.04	41.51	125.38	32.29	25.87	63.46
Sampler #12		15.29	24.01	31.67	19.52	7.24	9.60	10.45	44.24	10.56	11.06	9.62
Sampler #13		15.20	127.73	22.49	100.38	29.63	12.31	0.40 U	148.43	3.30	50.63	7.96
Sampler #13-D		24 QA	142.63	21.29	100.25	26.17	14.35	24 QA	141.05	25 QA	3.43	6.24
Sampler #14		23.01	25.85	0.38 U	35.99	7.68	0.39 U	0.40 U	8.71	12.78	0.39 U	0.40 U
Sampler #15		3.86	26.84	40.83	33.70	12.92	37.36	27.82	16.51	30.61	13.80	9.09
Sampler #16		0.41 U	15.70	15.78	13.58	11.23	0.40 U	9.98	12.18	13.97	0.40 U	0.40 U
Average of Dredge		16.42	48.79	32.97	40.68	22.12	19.69	15.09	58.63	17.25	13.09	15.01

Environmental
 Conditions

8 Hour Event		0300-1100	0400-1200	0630-1430	0730-1530	0830-1630	0930-1730	1030-1830	1300-2100	1345-2145	0200-1000	0300-1100
Ave Wind Direction (Direction/Percent)	Primary Secondary	NW/49.49 WNW/48.45	WSW/47.43 SW/42.28	NW/98.97 NNW/1.03	WSW/65.98 SW/19.59	WNW/23.72 WSW/21.65	NW/75.26 WNW/21.65	NW/84.47 NNW/9.71	S/50.51 SSW/45.36	W/34.37 NW/29.16	N/60.83 N/60.83	NNE/46.01 NE/26.30
Ave Wind Speed (MPH)		8.8	5.8	21.7	12.7	8.5	12.52	12.77	7.39	10.44	6.46	7.16
Ave Solar Radiation (Watt/m ²)		96.9	130.0	317.2	254.9	123.2	192.77	239.84	93.21	40.29	21.44	121.74
Ave Air Temperature (F)		48.31	60.90	53.49	58.50	63.50	49.11	46.28	53.53	61.64	47.38	46.82
Total Precipitation (inches)		0.00	0.00	0.00	0.00	0.00	0.00	0.00	0.00	0.00	0.00	0.00
Tide H/L (MAG) (FT)		5.3H	5.4H	4.8H	4.5H	4.2H	3.9H	3.7H	3.7H	3.7H	3.8H	3.8H

24 Hour Event		1200-1200				1200-1200		1200-1200		1200-1200		1200-1200
Ave Wind Direction (Direction/Percent)	Primary Secondary	WNW/72.32 NW/24.92				WSW/41.87 SW/29.41		NW/59.51 WNW/20.76		SSW/33.91 S/20.07		NNE/38.14 N/24.75
Ave Wind Speed (MPH)		13.5				7.5		11.86		7.99		6.40
Ave Solar Radiation (Watt/m ²)		84.2				69.2		114.71		68.10		79.36
Ave Air Temperature (F)		49.88				59.71		42.52		55.51		47.63
Total Precipitation (inches)		0.00				0.00		0.00		0.00		0.00
Tide H/L (MAG) (FT)		5.36/-0.8				3.9/0.2		3.8/0.5		4.2/0.2		3.8/0.1

New Bedford Harbor Superfund Site
 Ambient Air Monitoring
 PCB Concentrations (AROCLORS)
 Reported in ng/m³

Sample Locations 22-Sep-97

CDF Area (24 hr)/(8hr)	Sample Date	111894	112194	112294	112394	112894	112994	113094	120194	120294	120594	120694
Sampler #1				19.06	8.80		5.95		18.25			
Sampler #2				27.16	12.62		10.22		20.17			
Sampler #3				76.46	6.45		24.16		22.78			
Sampler #3-D				67.9 Q	6.12		22.75		23.7 QA			
Sampler #4				4.05	0.84		0.59		1.35			
Sampler #5				4.67	MOTOR F. NC		0.74		1.33			
Sampler #6				13.29	0.13 U		1.34		7.76			

Average On Site (1-3,6)				33.99	6.96		10.24		17.24			
-------------------------	--	--	--	-------	------	--	-------	--	-------	--	--	--

Off Site CDF Area (24 hr)	Sample Date	111894	112194	112294	112394	112894	112994	113094	120194	120294	120594	120694
Sampler #7				4.10			0.78					
Sampler #8				4.92			0.99					
Sampler #9				25.13			11.70					
Sampler #10												

Off Site Dredge Area (8 hr on tide)	Sample Date	111894	112194	112294	112394	112894	112994	113094	120194	120294	120594	120694
Tide Level	MOVE TO F	HIGH-B	HIGH-D	HIGH-D	HIGH-D	HIGH-D	HIGH-D	HIGH-D	HIGH-D	HIGH-D	HIGH-D	HIGH-D
Sampler #11	4.87	4.66	99.70	32.30		[1] 85.95 V[2]	33.96	28.63	17.75 V	17.01	63.47	
Sampler #12	39.02	34.82	128.34	31.48		N 36.59	60.18	55.38	35.66	41.88	145.96	
Sampler #13	10.41	5.07	5.42	3.88		[1] 2.48	9.45	4.16	8.50	17.93	6.99	
Sampler #13-D	5.61	10.97	30.18	24.41		[1] 24.17	30.53	12.99	30.16	51.64	34.82	
Sampler #14	9.39	11.98	28.50	QA		[1] 22.30 V	25.17	13.31	31.31	55.75	25.67	
Sampler #15	19.42	0.41 U	5.82	17.74		[1] 10.24	8.59	0.42 U	7.38	4.24	8.00	
Sampler #16	1.40	5.56	29.53	18.20		[1] 23.66	14.83	14.05	13.23	16.75	25.46	
Sampler #16	6.22	3.87	9.33	5.82		[1] 9.85	7.91	5.03	9.16	5.40	8.65	

Average of Dredge	14.00	10.20	34.63	16.92	2.37 [1]	17.68	21.47	15.37	17.45	23.32	37.55
-------------------	-------	-------	-------	-------	----------	-------	-------	-------	-------	-------	-------

Environmental
Conditions

8 Hour Event	Sample Date	0330-1130	0530-1330	0600-1400	0700-1500	2300-0700	0000-0800	0100-0900	0200-1000	0230-1030	0500-1300	0600-1400
Ave Wind Direction (Direction/Percent)	Primary Secondary	NNE/31.96 ESE/20.62	SE/50.51 SSE/17.52	NW/41.23 WNW/32.99	WSW/48.46 W/43.30	E/52.58 ENE/23.71	WSW/38.14 W/20.61	NNE/35.05 N/32.99	NW/53.61 WNW/27.83	SW/37.11 SSW/31.96	ESE/28.86 SE/18.55	WNW/54.64 NW/29.89
Ave Wind Speed (MPH)		6.90	9.88	13.04	12.73	13.42	11.22	3.96	7.61	6.20	4.61	8.73
Ave Solar Radiation (Watt/m ²)		118.42	93.72	239.59	221.27	0.01	5.02	6.44	61.36	92.80	21.08	173.52
Ave Air Temperature (F)		54.46	46.09	56.76	42.05	44.84	51.97	43.62	34.98	39.36	50.81	56.13
Total Precipitation (inches)		0.00	0.00	0.02	0.00	0.19	0.00 [3]	0.01	0.00	0.00	0.31	0.00
Tide H/L (MAG) (FT)		4.4H	4.1H	3.9H	3.7H	4.0H	4.3H	4.7H	5.0H	5.3H	5.0H	4.7H

24 Hour Event	Sample Date	1200-1200	1200-1200	1200-1200	1200-1200	1200-1200	1200-1200
Ave Wind Direction (Direction/Percent)	Primary Secondary	SSE/23.88 SE/17.99	WSW/30.79 WNW/25.60	SW/29.41 SSW/25.26	NW/44.99 WNW/17.99		
Ave Wind Speed (MPH)		15.36	12.25	13.63	7.52		
Ave Solar Radiation (Watt/m ²)		74.68	111.72	56.12	100.82		
Ave Air Temperature (F)		58.53	44.66	60.08	40.79		
Total Precipitation (inches)		0.03	0.08	0.23 [3]	0.00		
Tide H/L (MAG) (FT)		3.9/0.2	3.7/0.3	4.3/-0.1	5.0/-0.6		

New Bedford Harbor Superfund Site
 Ambient Air Monitoring
 PCB Concentrations (AROCLORS)
 Reported in ng/m³
 Sample Locations 22-Sep-97

CDF Area	Sample Date	120794	120894	120994	121294	121394	121494	121594	121694	121994	122094	122194
(24 hr)/(8hr)												
Sampler #1		16.36		8.53 P		11.58		17.83				8.49
Sampler #2		30.15		9.43 P		11.40		20.27				15.60
Sampler #3		43.25		9.30		4.08		20.48				19.46
Sampler #3-D		39.7 QA		7.76		8.3 QA		16.74				31.8 Q
Sampler #4		1.56		1.71		5.66		9.41				1.36
Sampler #5		1.69		2.49 P		6.86		13.87				0.14 U
Sampler #6		3.23		14.10		0.14 U		70.12				3.51
Average On Site (1-3.6)		23.25		10.15 P		6.80		31.71				11.76
Off Site CDF Area (24 hr)												
Sampler #7		0.13 U						7.06				
Sampler #8		2.22						1.56				
Sampler #9		12.70						3.80				
Sampler #10												
Off Site Dredge Area (8 hr on tide)		HIGH-D	HIGH-D	HIGH-D	HIGH-D	HIGH-D	HIGH-D	HIGH-D	HIGH-D	HIGH-D	HIGH-D	HIGH-D
Tide Level		31.63	43.71	12.53	18.32	3.13	0.41 U	7.43	13.94	21.04	0.40 U	20.24
Sampler #11		38.75	33.08	45.82	35.71	46.06	105.02	32.69	23.12	51.43	60.21	28.16
Sampler #12		9.94	4.42	13.75	2.25	4.32	2.71	5.50	4.45	3.82 B	4.15	6.76
Sampler #13		54.97	8.94 V	27.08	6.09	1.92	0.39 U	2.01	2.54	7.82	18.31	63.22
Sampler #13-D		54.76	8.92	17.2 QA	6.22	1.8 Q	0.41 U	1.63	0.41 U	7.88	13.81	38.79
Sampler #14		0.39 U	0.40 U	2.33	0.41 U	0.41 U	0.41 U	0.42 U	0.41 U	0.39 A	2.89	10.21
Sampler #15		13.92	24.00	8.83	18.66	4.85	0.42 U	10.93	13.50	17.71	7.87	12.58
Sampler #16		6.71	8.67	4.96	6.80	0.43 U	0.42 U	11.10	3.48	4.64 B	4.03	6.58
Average of Dredge		20.76	13.25	16.30	12.69	9.67	18.23	10.41	7.74	14.31	15.87	19.22

Environmental
 Conditions

8 Hour Event	0700-1500	0800-1600	0830-1630	2230-0630	1230-2030	0100-0900	0200-1000	0230-1030	0430-1230	0500-1300	0600-1400
Ave Wind Direction (Direction/Percent)	Primary NW/18.56 Secondary NE/15.46	NW/64.94 NNW/34.02	S/49.49 NNE/19.58	NW/53.21 NNW/32.11	NNE/47.43 NE/29.89	NE/64.95 ENE/29.90	NNE/60.83 N/39.18	N/87.62 NNE/6.18	WNW/57.73 NW/39.17	W/39.17 WSW/29.90	WSW/62.89 SW/34.02
Ave Wind Speed (MPH)	6.30	16.24	5.80	12.09	9.69	10.33	11.30	8.21	11.81	6.58	6.67
Ave Solar Radiation (Watt/m ²)	23.53	229.77	181.07	0.06	80.69	3.24	10.72	12.66	97.98	127.42	188.88
Ave Air Temperature (F)	52.26	31.93	36.72	29.99	35.54	35.58	37.27	34.97	38.12	31.75	45.24
Total Precipitation (inches)	0.00	0.00	0.00	0.00	0.00	0.00	0.03	0.00	0.00	0.00	0.00
Tide H/L (MAG) (FT)	4.4H	4.0H	3.7H	3.7H	3.3H	3.9H	4.1H	4.2H	4.2H	4.1H	4.0H
24 Hour Event	1200-1200		1200-1200		1200-1200		1200-1200				1200-1200
Ave Wind Direction (Direction/Percent)	Primary SW/24.56 Secondary W/21.45		NNW/39.79 NW/29.07		N/38.76 NNE/26.3		N/45.33 NNE/43.25				WSW/37.38 SW/25.61
Ave Wind Speed (MPH)	6.00		9.81		6.83		10.80				5.80
Ave Solar Radiation (Watt/m ²)	50.08		94.23		79.72		20.91				83.75
Ave Air Temperature (F)	54.88		31.18		24.81		37.05				38.19
Total Precipitation (inches)	0.00		0.00		0.00		0.03				0.00
Tide H/L (MAG) (FT)	0.1/4.0		3.8/0.4		3.8/0.4		4.2/0.3				4.0/-0.1

New Bedford Harbor Superfund Site
 Ambient Air Monitoring
 PCB Concentrations (AROCLORS)
 Reported in ng/m³

Sample Locations 22-Sep-97

CDF Area	Sample Date	122294	122394	122794	122894	122994	123094	010395	010495	010595	010695	010995
(24 hr)/(8hr)												
Sampler #1			72.60			15.63	10.92		4.31		2.72	
Sampler #2			65.14			21.44	11.94		8.80		6.01	
Sampler #3			154.51			31.44	5.87		20.86		8.69	
Sampler #3-D			143.58			27.17	5.88		QA		8.16	
Sampler #4			45.93			0.13 U	0.21 J		0.14 U		0.14 U	
Sampler #5			49.00			0.13 U	0.13 U		0.14 U		0.14 U	
Sampler #6			113.69			2.19	5.61		1.06		0.14 U	
Average On Site (1-3,6)			86.55			17.14	8.59		8.76		4.32	
Off Site CDF Area (24 hr)												
Sampler #7			22.12			0.13 U			0.14 U			
Sampler #8			19.04			0.13 U			0.14 U			
Sampler #9			48.99			7.51			4.65			
Off Site Dredge Area (8 hr on tide)		HIGH-D	HIGH-D	HIGH-D	HIGH-D	HIGH-D	HIGH-D	HIGH-D	HIGH-D	HIGH-D?	HIGH-D?	NON-D
Tide Level		23.53	11.54	8.07	11.09	52.12	36.98	25.73	9.70	15.26	6.73	4.22
Sampler #11		256.59	270.10	123.33	75.94	51.03	20.53	38.41	45.82	41.99	15.90	41.70
Sampler #12		27.80	10.58	26.68	40.41	2.54	2.68	2.76	3.01	2.80	0.41 U	2.72
Sampler #13		232.36	12.01	30.20	80.59	17.88	3.03	10.61	16.15	5.82	23.32 V	29.61 V
Sampler #13-D		258 Q	10.93	25.6 Q	66.93	12.26	QA	8.65	13.37	QA	10.27	21.57
Sampler #14		10.24	0.39 U	3.48	3.73	7.88	0.39 U	2.56	4.94	1.17	7.95	0.40 R
Sampler #15		10.20	12.55	6.60	10.20	11.47	8.47	8.64	10.09	4.70	5.25	5.30
Sampler #16		4.63	3.29	3.59	4.92	4.93	4.73	4.63	3.91	2.27	2.93	2.63
Average of Dredge		90.30	51.40	32.31	34.83	15.49	53.84	11.11	13.75	9.30	8.21	13.06
Environmental Conditions												
8 Hour Event		0630-1430	0700-1500	1100-1900	2330-0730	0030-0830	0130-0930	0500-1300	0600-1400	0630-1430	700-1500	1000-1800
Ave Wind Direction (Direction/Percent)	Primary	SSE/32.29 [4]	NNE/52.58	S/44.33	SSW/56.70	WNW/65.97	NW/62.89	WNW/50.52	WNW/63.92	WNW/75.2 [4]	WSW/49.4 [4]	WNW/49.49
	Secondary	WSW/32.2 [4]	NE/25.77	SSW/20.62	S/32.99	W/28.86	NNW/27.84	NW/25.77	W/18.55	NW/24.74 [4]	W/38.14 [4]	W/29.89
Ave Wind Speed (MPH)		6.26 [4]	18.41	6.99	5.21	11.45	19.56	10.73	7.86	13.87 [4]	17.28 [4]	8.28
Ave Solar Radiation (Watt/m ²)			64.99	173.03	2.48	14.03	39.00	143.51	171.07	[4]	[4]	195.16
Ave Air Temperature (F)			44.94	42.23	43.90	41.15	15.63	28.13	31.52	20.85 [4]	33.46 [4]	33.19
Total Precipitation (inches)			0.00	0.00	0.00	0.00	0.00	0.00	0.00	0.00 [4]	0.00 [4]	0.00
Tide H/L (MAG) (FT)			3.7H	3.5H	4.3H	4.6H	4.8H	4.9H	4.6H	4.3H	3.9H	3.1H
24 Hour Event			1200-1200			1200-1200	1200-1200		1200-1200	1200-1200		
Ave Wind Direction (Direction/Percent)	Primary		N/35.29			WNW/25.62	NW/56.05		WSW/34.25	W/38.89 [4]		
	Secondary		NNE/22.14			W/23.87	NNW/38.76		W/27.67	WSW/37.5 [4]		
Ave Wind Speed (MPH)			5.86 P			11.78	19.15		7.86	11.36 [4]		
Ave Solar Radiation (Watt/m ²)			63.30			84.08	96.19		76.88	[4]		
Ave Air Temperature (F)			39.76 P			43.02	21.99		32.60	25.66 [4]		
Total Precipitation (inches)			0.00			0.00	0.00		0.00	0.00 [4]		
Tide H/L (MAG) (FT)			3.5/0.0			4.6/-0.4	4.8/-0.6		4.4/-0.6	4.2/-0.3		

New Bedford Harbor Superfund Site
 Ambient Air Monitoring
 PCB Concentrations (AROCLORS)
 Reported in ng/m³

Sample Locations 22-Sep-97

CDF Area	Sample Date	011095	011195	011295	011395	011695	011795
(24 hr)/(8hr)							
Sampler #1		10.98		4.88			
Sampler #2		14.62		5.12			
Sampler #3		2.94		12.40			
Sampler #3-D		2.69		QA			
Sampler #4		0.13 U		8.54			
Sampler #5		0.13 U		6.59			
Sampler #6		10.31		67.62			
Average On Site (1-3,6)		9.68		22.51			
Off Site CDF Area (24 hr)							
Sampler #7		0.13 U					
Sampler #8		1.33					
Sampler #9		0.14 U					
Sampler #10							
Off Site Dredge Area (8 hr on tide)		NON-D	NON-D	NON-D	NON-D	HIGH-D	HIGH-D
Tide Level		2.58	4.65	16.25	14.29	12.67	91.36
Sampler #11		2.20	24.78	91.81	39.43	384.95	268.64
Sampler #12		1.94	3.46	16.74	12.95	80.67	37.85
Sampler #13		3.01	2.18	41.75	78.19	97.74	116.34
Sampler #13-D		3.02	2.14	29.85	QA	126.28	117.43
Sampler #14		0.39 U	0.40 U	2.86	7.52	4.71	12.15
Sampler #15		1.89	3.18	13.43	13.39	14.89	65.76
Sampler #16		1.17	1.74	7.33	7.99	7.88	24.45
Average of Dredge		1.77	5.95	28.00	26.58	100.85	87.62
Environmental Conditions							
8 Hour Event		1100-1900	1200-2000	1300-2100	0100-0900	0330-1130	0400-1200
Ave Wind Direction (Direction/Percent)	Primary	ENE/48.45	NNE/74.23	S/37.11	SW/79.38	S/60.83	NNE/27.83
	Secondary	NE/26.81	N/10.31	NE/16.49	SSW-WSW/1	SSW/29.90	N/22.68
Ave Wind Speed (MPH)		8.53	8.04	4.59	9.00	10.38	4.56
Ave Solar Radiation (Watt/m ²)		165.36	35.67	31.84	11.76	30.72	39.22
Ave Air Temperature (F)		27.72	28.12	46.66	55.47	59.57	53.76
Total Precipitation (inches)		0.00	0.02	0.01	0.00	0.04	0.01
Tide H/L (MAG) (FT)		3.0H	3.0H	3.2H	3.3H	4.2H	4.2H
24 Hour Event		1200-1200		1200-1200			
Ave Wind Direction (Direction/Percent)	Primary	NNW/24.92		SW/43.6			
	Secondary	NW/22.5		NNE/25.95			
Ave Wind Speed (MPH)		6.78		8.04			
Ave Solar Radiation (Watt/m ²)		83.51		20.04			
Ave Air Temperature (F)		27.01		36.82			
Total Precipitation (inches)		0.00		0.21			
Tide H/L (MAG) (FT)		3.5/0.5		3.6/0.5			

New Bedford Harbor Superfund Site
 Ambient Air Monitoring
 PCB Concentrations (AROCLORS)
 Reported in ng/m³

Sample Locations 22-Sep-97

CDF Area	Sample Date	011895	011995	012095	012395	012495	012495	012595	012695	012795	013095	013195
(24 hr)/(8hr)												
Sampler #1		50.46		24.16		9.61 P	9.61 P		11.13			
Sampler #2		64.35		24.27		15.49 P	15.49 P		24.61			
Sampler #3		48.55		20.85		4.39 P	4.39 P		4.60			
Sampler #3-D	QA			19.91		QA P	QA P		4.76			
Sampler #4		34.88		40.88		0.90 P	0.90 P		0.33			
Sampler #5		46.12		49.40		0.94 P	0.94 P		0.63			
Sampler #6		112.86		104.82		4.10 P	4.10 P		7.56			
Sampler #17												
Average On Site (1-3,6)		69.05		43.41		7.85 P	7.85 P		12.00			
Off Site CDF Area (24 hr)												
Sampler #7		29.92							0.71			
Sampler #8		8.43							0.75			
Sampler #9		16.39							0.82			
Off Site Dredge Area (8 hr on tide)												
Tide Level		HIGH-D	HIGH-D	HIGH-D	HIGH-D	HIGH-D	NON-DREDDG	HIGH-D	HIGH-D	HIGH-D	HIGH-D	HIGH-D
Sampler #10		2.02	1.66	10.91	9.18 P	14.01 P	14.01	15.74	17.38	17.94	4.68	9.42
Sampler #11		111.24	75.54	52.00	69.58 P	26.25 P	26.25	47.48	48.81	44.09	34.69	11.09 R
Sampler #12		6.29	8.22	5.17	0.42 U	28.34 P	28.34	2.37	2.82	2.49	3.07	6.45
Sampler #13		3.09	2.23	2.95	17.80 P	5.50 P	5.50	9.63	10.71	18.07	5.84	6.02
Sampler #13-D	QA		1.77	1.25	15.15 P	QA P	QA	9.24	9.34	17.93	5.07	6.97
Sampler #14		1.14	1.93	0.40 U	8.13 P	0.41 U	0.41 U	0.40 U	0.41	3.89	3.45	1.50
Sampler #15		3.75	3.52	0.89	10.81 P	9.94 P	9.94	14.88	12.51	9.15	5.13	15.20
Sampler #16		0.40 U	2.06	1.43	6.55 P	5.32 P	5.32	5.09	0.40	3.48	4.88	9.12
Average of Dredge		20.99	15.55	10.33	18.66 P	12.63 P	12.63	13.28	12.50	13.52	9.45	8.31

Environmental
 Conditions

8 Hour Event		0500-1300	0530-1330	0600-1400	0830-1630	0930-1730	0930-1730	1100-1900	1200-2000	1300-2100	0300-1100	0400-1200
Ave Wind Direction (Direction/Percent)	Primary	NE/93.81	NE/58.76	ENE/69.08	WNW/68.04	NNW/54.64	NNW/54.64	NW/72.17	NW/74.22	WNW/55.67	W/30.93	NNW/73.19
	Secondary	NNE/6.18	ENE/24.74	NE/24.74	NW/29.90	N/41.23	N/41.23	NNW/27.84	NNW/14.43	NW/39.18	WSW/26.80	N/11.34
Ave Wind Speed (MPH)		19.42	9.79	12.01	9.01	10.58	10.58	11.1	11.2	14.4	4.4	7.4
Ave Solar Radiation (Watt/m ²)		26.12	61.91	31.01	123.58	162.71	162.71	161.4	194.2	119.3	95.2	125.2
Ave Air Temperature (F)		42.12	42.57	44.56	36.23	32.56	32.56	35.9	33.1	30.3	27.8	29.8
Total Precipitation (inches)		0.00	0.00	0.03	0.00	0.00	0.00	0.00	0.00	0.00	0.00	0.00
Tide H/L (MAG) (FT)		4.2H	4.1H	4.0H	3.5H	3.4H	3.4H	3.4H	3.6H	3.8H	4.4H	4.5H
24 Hour Event		1200-1200		1200-1200		1200-1200	1200-1200		1200-1200			
Ave Wind Direction (Direction/Percent)	Primary	NNE/54.68		NE/58.48		NNE/49.83	NNE/49.83		NW/71.97			
	Secondary	NE/42.9		ENE/39.79		WNW/21.80	WNW/21.80		NNW/27.68			
Ave Wind Speed (MPH)		18.90		9.36		8.35	8.35		10.5			
Ave Solar Radiation (Watt/m ²)		23.56		25.52		62.57	62.57		96.7			
Ave Air Temperature (F)		47.73		43.22		33.20	33.20		30.5			
Total Precipitation (inches)		0.00		0.03		0.00	0.00		0.00			
Tide H/L (MAG) (FT)		3.8/-0.3		3.9/-0.4		3.9/0.1	3.9/0.1		4.2/-0.1			

New Bedford Harbor Superfund Site
 Ambient Air Monitoring
 PCB Concentrations (AROCLORS)
 Reported in ng/m³

Sample Locations 22-Sep-97

CDF Area	Sample Date	020195	020295	020395	020695	020795	020895	020995	021095	021395	021495	021595
(24 hr)/(8hr)												
Sampler #1		11.55		14.19		2.21		5.71			6.59	
Sampler #2		7.54		13.69		5.56		12.46			15.29	
Sampler #3		23.72		5.65		0.64		1.25			3.01	
Sampler #3-D		20.20		(QA) 6.3		(QA) 0.77		1.22			(QA) 7.0	
Sampler #4		0.90		1.52		0.13 U		0.14 U			0.14 U	
Sampler #5		1.96		1.33		0.13 U		0.14 U			0.14 U	
Sampler #6		6.45		16.91		1.30		2.96			0.57	
Sampler #17												
Average On Site (1-3,6)		11.88		12.61		2.43		5.59			6.36	
Off Site CDF Area (24 hr)												
Sampler #7				0.74		0.14 U					0.14 U	
Sampler #8				0.13 U		0.14 U					0.14 U	
Sampler #9				6.15		0.14 U					0.84	
Off Site Dredge Area (8 hr on tide)												
Tide Level		HIGH-D	HIGH-D	HIGH-D	NON-DREDGE							
Sampler #10		36.84	26.50	10.94	4.32							
Sampler #11		5.56	59.91	30.89	28.62							
Sampler #12		4.24	6.62	5.03	0.37 U							
Sampler #13		28.54	15.45	3.77	3.49							
Sampler #13-D		(QA) 36	19.60	3.27	3.42							
Sampler #14		30.65	6.57	0.38 U	1.07							
Sampler #15		13.78	7.45	11.88	0.40 U							
Sampler #16		6.63	18.74	5.21	0.38 U							
Average of Dredge		14.90	19.47	9.48	5.72							
Environmental Conditions												
8 Hour Event		0430-1230	0530-1330	0600-1400	0830-1630							
Ave Wind Direction	Primary	W/80.59	NW/43.30	NNW/52.58	N/71.13							
(Direction/Percent)	Secondary	WNW/17.47	NNW/28.86	N/23.71	NNW/21.65							
Ave Wind Speed	(MPH)	9.9	9.1	9.98	17.9							
Ave Solar Radiation	(Watt/m ²)	177.5	157.4	272.4	293.3							
Ave Air Temperature	(F)	39.8	39.4	20.6	11.28							
Total Precipitation	(inches)	0.00	0.00	0.00	0.00							
Tide H/L (MAG)	(FT)	4.7H	4.4H									
24 Hour Event		1200-1200		1200-1200		1200-1200		1200-1200			1200-1200	
Ave Wind Direction	Primary	W/40.48		NNW/55.37		NNW/61.25		NW/43.59			W/47.06	
(Direction/Percent)	Secondary	WSW/25.26		N/39.79		NW/13.51		WNW/23.19			WNW/22.48	
Ave Wind Speed	(MPH)	9.1		11.50		14.4		10.7			9.4	
Ave Solar Radiation	(Watt/m ²)	118.0		107.7		138.8		146.1			157.3	
Ave Air Temperature	(F)	38.1		25.9		9.3		20.8			24.5	
Total Precipitation	(inches)	0.00		0.00		0.00		0.00			0.00	
Tide H/L (MAG)	(FT)	4.5/-0.8		4.3/-0.4		3.4/0.7		3.3/0.8			6.56/-0.2	

New Bedford Harbor Superfund Site
 Ambient Air Monitoring
 PCB Concentrations (AROCLORS)
 Reported in ng/m³

Sample Locations 22-Sep-97

Sample Locations	Sample Date	021695	022195	022295	022395	022495	022795	022895	030195	030295	030395	030695
CDF Area (24 hr)/(8hr)												
Sampler #1		6.08	22.82		4.63				29.81		16.12	
Sampler #2		11.49	21.11		5.99				37.55		17.68	
Sampler #3		55.08	18.88		79.16				40.96		12.83	
Sampler #3-D		52.16	14.04		(QA) 110				(QA) 38		12.24	
Sampler #4		1.82	24.14		1.49				18.00		7.92	
Sampler #5		1.81	43.46		2.58				27.42		12.57	
Sampler #6		5.12	118.23		9.79				102.31		67.39	
Sampler #17												
Average On Site (1-3,6)		19.08	39.38		24.89				52.66		28.43	
Off Site CDF Area (24 hr)												
Sampler #7					1.43						7.15	
Sampler #8					1.48						1.26	
Sampler #9					9.29						2.99	
Off Site Dredge Area (8 hr on tide)												
Tide Level			HIGH-D	HIGH-D	HIGH-D	NON-D	HIGH-D	HIGH-D	HIGH-D	HIGH-D	HIGH-D	NON-D
Sampler #10			4.05	8.72	8.58	47.42	4.36	29.40	2.41	24.46	7.50	32.16
Sampler #11			46.00	42.21	90.88	67.93	34.00	105.11	75.61	41.44	31.12	44.65
Sampler #12			4.45	3.39	379.88	5.92	6.70	18.13	7.09	7.90	0.41 U	6.12
Sampler #13			2.27	14.33	133.18	69.26	2.96	35.07	0.39 U	4.08	0.39 U	38.32
Sampler #13-D			(QA) 2.4	14.75	138.46	64.53	3.10	34.39	(QA) 2.6	3.32	0.39 U	26.99
Sampler #14			0.41 U	0.42 U	2.65	16.79	0.40 U	5.78	0.40 U	0.40 U	0.39 U	24.90
Sampler #15			6.13	10.41	8.02	18.84	5.16	29.10	9.93	19.28	12.40	9.11
Sampler #16			0.39 U	2.87	3.24	7.66	0.42 U	12.26	0.40 U	4.85	2.34	0.38 U
Average of Dredge			9.94	12.31	103.42	31.07	8.28	34.19	15.64	12.93	7.84	19.64
Environmental Conditions												
8 Hour Event			0830-1630	0930-1730	1030-1830	1130-1930	0200-1000	0300-1100	0330-1130	0400-1200	0500-1300	0700-1500
Ave Wind Direction (Direction/Percent)	Primary Secondary		NNE/78.34 NE/14.43	NNE/32.99 N/26.80	S/67.01 SSE/18.56	WNW/59.78 NW/14.43	NE/39.59 E/33.33	NE/19.59 S/12.37	NNE/75.25 NE/24.74	N/73.20 NNE/16.49	NNE/49.48 N/36.08	NNW/29.89 NW/19.58
Ave Wind Speed (MPH)			14.76	6.89	7.57	13.31	7.77	3.36	15.61	9.81	9.59	6.02
Ave Solar Radiation (Watt/m ²)			105.13	152.11	91.28	105.28	12.04	19.79	27.63	184.58	237.01	163.73
Ave Air Temperature (F)			36.60	34.09	42.08	41.07	23.87	39.21	39.84	32.45	29.33	43.73
Total Precipitation (inches)			0.00	0.00	0.00	0.05	0.00	0.27	0.00	0.00	0.00	0.00
Tide H/L (MAG) (FT)			3.5H	3.4H	3.4H	3.5H	4.4H	4.5H	4.5H	4.4H	4.2H	3.4H
24 Hour Event												
Ave Wind Direction (Direction/Percent)	Primary Secondary	1200-1200 S/33.57 WSW/22.50	1200-1200 NNE/53.82 NE/37.85		1200-1200 SW/33.56 SSW/22.84				1200-1200 NNE/76.13 NE/9.34		1200-1200 N/42.21 NNE/38.76	
Ave Wind Speed (MPH)		12.38	12.92		5.48				11.90		9.45	
Ave Solar Radiation (Watt/m ²)		124.50	65.74		63.45				23.80		102.54	
Ave Air Temperature (F)		39.86 [6]	41.17		35.40				43.47		30.54	
Total Precipitation (inches)		0.86	0.00		0.00				0.47		0.00	
Tide H/L (MAG) (FT)		4.3/-0.6	4.1/-0.2		4.0/-0.1				4.5/-0.7		4.5/-0.5	

New Bedford Harbor Superfund Site
 Ambient Air Monitoring
 PCB Concentrations (AROCLORS)
 Reported in ng/m³

22-Sep-97

Sample Locations

CDF Area	Sample Date	030795	030895	030995	031095	031395	031495	031595	031695	031795	032095	032195
(24 hr)/(8hr)												
Sampler #1		65.89		29.46				13.18		18.36		12.34
Sampler #2		70.29		32.09				14.56		19.06		12.96
Sampler #3		98.42		275.45				159.24		229.27		622.65 D
Sampler #3-D	QA			195.09				117.54		194.41		(QA) 370
Sampler #4		45.34		6.66				7.73		7.30		5.47
Sampler #5		48.27		3.83				9.47		7.22		6.64
Sampler #6		86.38		29.40				22.38		20.94		13.46
Sampler #17												
Average On Site (1-3,6)		80.25		81.56				46.77		67.55		165.35
Off Site CDF Area (24 hr)												
Sampler #7		24.86						5.43				
Sampler #8		30.31						3.01				
Sampler #9		37.67						20.97				
Off Site Dredge Area (8 hr on tide)												
Tide Level		NON-D	NON-D	HIGH-D	HIGH-D	HIGH-D	HIGH-D	HIGH-D	HIGH-D	HIGH-D	HIGH-D	HIGH-D
Sampler #10		3.91	9.95	99.39	0.38 U	7.86	9.39	10.11	8.59	4.73	9.31	11.77
Sampler #11		97.34	639.02	46.59	29.71	109.26	141.54	59.51	151.10	157.88	247.57	285.02
Sampler #12		10.84	139.52	5.09	0.42 U	34.25	14.49	15.29	9.79	8.99	27.65	135.44
Sampler #13		16.73	512.80	17.21	15.92	49.37	11.96	53.47	15.52	14.70	26.84	117.43
Sampler #13-D	QA		497.17	17.65	15.80	(QA) 46	9.61	(QA) 59	12.26	15.74	24.54	(QA) 110
Sampler #14	0.40 U	10.48	1.88	0.41 U	3.91	0.39 U	3.37	1.65	0.40 U	2.39	4.45	
Sampler #15	4.26	33.33	40.72	20.50	9.87	15.31	5.88	7.58	6.42	8.14	18.88	
Sampler #16	2.99	9.94	15.08	9.39	5.69	2.27	4.72	5.13	2.57	2.77	8.70	
Average of Dredge		22.09	222.88	21.13	12.71	35.39	30.80	23.71	31.52	31.91	52.37	94.99
Environmental Conditions												
8 Hour Event		0800-1600	0830-1630	0930-1730	1030-1830	0100-0900	0200-1000	0230-1030	0300-1100	0400-1200	0600-1400	0700-1500
Ave Wind Direction (Direction/Percent)	Primary Secondary	S/43.30 SE/30.93	SSW/79.38 S/20.62	NNW/76.29 NW/16.50	NNW/75.26 NW/15.46	SSW/41.24 S/40.21	NNE/93.82 N/3.09	S/34.02 SW/25.77	ESE/19.59 E/14.43	SSE/21.65 SE/18.56	S/53.61 SSE/28.86	S/70.10 SSW/29.90
Ave Wind Speed (MPH)		9.12	16.76	15.74	12.76	5.54	11.11	4.11	3.68	7.07	9.42	13.64
Ave Solar Radiation (Watt/m ²)		133.10	303.63	168.66	407.22	26.31	20.88	36.76	63.08	17.48	467.46	194.51
Ave Air Temperature (F)		44.72	61.99	34.66	34.33	41.56	44.92	41.04	41.01	47.65	37.64	57.45
Total Precipitation (inches)		0.00	0.00	0.00	0.00	0.00	0.00	0.00	0.00	0.27	0.00	0.06
Tide H/L (MAG) (FT)		3.1H	2.9H	2.9H	2.9H	3.6H	3.9H	4.1H	4.3H	4.3H	4.0H	3.8H
24 Hour Event		1200-1200		1200-1200				1200-1200		1200-1200		1200-1200
Ave Wind Direction (Direction/Percent)	Primary Secondary	N/11.42 SW/11.07		S/38.41 NNE/25.26				S/33.92 SSE/15.92		S/51.21 SSE/16.61		S/61.93 SSW/23.52
Ave Wind Speed (MPH)		4.46		17.10				4.47		7.30		9.88
Ave Solar Radiation (Watt/m ²)		77.18		89.21				42.09		53.56		165.47
Ave Air Temperature (F)		43.05		54.78				41.93		44.51		48.19
Total Precipitation (inches)		0.00		0.95				0.00		0.27		0.00
Tide H/L (MAG) (FT)		3.6/0.3		3.2/0.7				4.1/-0.2		4.3/-0.7		4.5/-0.5

New Bedford Harbor Superfund Site
 Ambient Air Monitoring
 PCB Concentrations (AROCLORS)
 Reported in ng/m³

Sample Locations	Sample Date	032295	032395	032495	032795	032895	032995	033095	033195	040395	040495	040595
CDF Area (24 hr)/(8hr)												
Sampler #1			52.21			49.37			30.44		44.06	
Sampler #2			97.09			45.64			43.63		49.26	
Sampler #3			17.11			24.80			611.68		627.04 D	
Sampler #3-D			16.11			24.29			550.04		446.14 D	
Sampler #4			0.68			61.49			5.16		2.55 RR	
Sampler #5			0.60			100.74			5.30		22.42	
Sampler #6			10.58			245.08			24.51		23.35	
Sampler #17												
Average On Site (1-3,6)			44.12			91.16			169.86		163.31	
Off Site CDF Area (24 hr)												
Sampler #7			0.49						4.11		8.78	
Sampler #8			0.14 U						3.02		2.21	
Sampler #9			4.62						51.95		54.96	
Off Site Dredge Area (8 hr on tide)												
Tide Level		HIGH-D	HIGH-D	HIGH-D	NON-DREDGE	HIGH-D	HIGH-D	HIGH-D	HIGH-D	HIGH-D	HIGH-D	HIGH-D
Sampler #10		87.51	27.78	14.76	4.42	19.73	10.33	3.58	65.83	11.73	24.61	87.13
Sampler #11		70.67	89.75	126.92	226.93	81.85	82.06	80.52	186.04	141.60	72.62	58.48
Sampler #12		7.58	8.25	9.79	6.65	6.26	7.20	15.46	19.69	10.67	20.77	11.39
Sampler #13		89.13	36.76	5.76	6.51	5.47	3.13	26.88	64.74	27.57	131.64	38.11
Sampler #13-D		91.55	32.99	4.58	4.56		2.66	20.74	(QA) 42	10.87	(QA) 110	(QA) 31
Sampler #14		34.13	6.83	0.40 U	0.39 U	0.39 U	0.39 U	0.39 U	6.85	0.40 U	19.03	0.40 U
Sampler #15		31.16	23.10	15.39	6.82	13.80	12.94	3.87	19.53	8.94	27.48	32.08
Sampler #16		14.06	8.70	4.45	0.38 U	5.44	3.59	2.27	8.70	3.65	16.34	6.58
Average of Dredge		41.32	28.58	27.02	41.12	18.87	18.18	21.05	50.92	30.75	47.98	24.51
Environmental Conditions												
8 Hour Event		0800-1600	0900-1700	1000-1800	1300-2100	0130-0930	0230-1030	0300-1100	0400-1200	0700-1500	0730-1530	0830-1630
Ave Wind Direction (Direction/Percent)	Primary Secondary	W/37.11 WSW/28.87	NNW/24.74 NW/16.50	NNE/75.26 N/14.43	ENE/36.08 NE/28.87	N/29.90 NNE/26.79	NNE/70.10 N/22.68	SSE/48.46 S/47.42	NW/41.24 WNNW/15.46	NNE/32.98 S/21.65	SW/76.28 WSW/16.49	WNW/55.67 NW/44.33
Ave Wind Speed (MPH)		8.73	6.68	11.68	9.00	6.23	9.02	9.59	7.10	9.92	14.45	23.82
Ave Solar Radiation (Watt/m ²)		288.18	218.59	207.40	280.67	115.10	252.66	220.74	176.81	595.78	249.70	506.55
Ave Air Temperature (F)		48.68	42.18	37.33	40.84	32.48	40.15	40.03	43.48	41.38	49.84	28.49
Total Precipitation (inches)		0.01	0.00	0.02	0.00	0.00	0.00	0.00	0.01	0.00	0.00	0.00
Tide H/L (MAG) (FT)		3.6H	3.5H	3.5H	4.1H	4.1H	4.2H	4.5H	4.1H	3.6H	3.4H	3.2H
24 Hour Event			1200-1200			0600-0600			1200-1200		1200-1200	
Ave Wind Direction (Direction/Percent)	Primary Secondary		WNW/44.63 NW/22.49			NNE/24.57 N/16.95			S/34.25 SSW/19.37		S/37.37 SSW/37.71	
Ave Wind Speed (MPH)			7.53			7.76			9.16		12.59	
Ave Solar Radiation (Watt/m ²)			137.08			189.04			178.40		180.04	
Ave Air Temperature (F)			44.26			36.48			43.66		44.04	
Total Precipitation (inches)			0.01			0.00			0.05		0.00	
Tide H/L (MAG) (FT)			4.1/0.0			4.1/-0.1			4.6/-0.4		4.0/0.0	

New Bedford Harbor Superfund Site
 Ambient Air Monitoring
 PCB Concentrations (AROCLORS)
 Reported in ng/m³

Sample Locations 22-Sep-97

CDF Area	Sample Date	040695	040795	041095	041195	041295	041395	041495	041795	041895	041995	042095
(24 hr)/(8hr)												
Sampler #1		60.42	25.03			23.55		86.70		13.05		178.28
Sampler #2		128.55	24.86			26.79		78.87		19.31		163.33
Sampler #3		3.95	78.66			859.56 D		213.94		1309.49 D		140.82
Sampler #3-D		3.45	53.60			665.01 D		131.94		(QA) 1200		74.97
Sampler #4		0.53	75.36			21.33		2.99		6.11		8.36
Sampler #5		0.14 U	92.97			22.36		2.52		6.32		10.06
Sampler #6		6.68	204.63			69.48		13.67		19.84		51.10
Sampler #17												
Average On Site (1-3,6)		49.83	80.16			220.53		88.05		340.42		125.15
Off Site CDF Area (24 hr)												
Sampler #7						6.24						2.69
Sampler #8						7.84						1.93
Sampler #9						93.52						13.85
Off Site Dredge Area (8 hr on tide)												
Tide Level		HIGH-D	CANCELED	HIGH-D	HIGH-D	HIGH-D	HIGH-D	HIGH-D	HIGH-D	HIGH-D	HIGH-D	HIGH-D
Sampler #10		56.61		12.29	14.09	4.41	33.46	35.27	9.08	11.59	7.07	30.82
Sampler #11		73.02		57.03	139.10	138.75	166.25	173.57	106.64	163.11	111.07	175.86
Sampler #12		6.52		5.65	5.35	9.18	70.69	7.37	13.27	25.63	21.26	24.43
Sampler #13		72.41		8.11	10.52	32.11	177.49	24.83	32.31	96.11	53.20	56.31
Sampler #13-D		72.58		6.82	14.93	(QA) 34	(QA) 180	26.19	55.06	(QA) 160	55.56	59.62
Sampler #14		7.56		0.39 U	0.39 U	0.39 U	15.82	2.67	2.78	5.77	5.34	1.99
Sampler #15		19.54		13.55	10.48	5.33	19.78	40.40	29.40	11.22	7.87	30.84
Sampler #16		12.45		6.15	6.60	0.38 U	10.12	12.75	11.39	4.67	LOST@LAB	10.74
Average of Dredge		37.97		15.04	29.11	31.02	76.69	43.71	34.53	51.09	39.98	50.31
Environmental Conditions												
8 Hour Event		0900-1700		0030-0830	0130-0930	0200-1000	0300-1100	0400-1200	0600-1400	0700-1500	0800-1600	0900-1700
Ave Wind Direction	Primary	SW/28.87		N/75.26	NNE/53.62	SE/63.91	SSE/31.96	NNW/30.93	S/32.98	S/55.67	SSE/46.38	S/23.71
(Direction/Percent)	Secondary	NW/18.56		NNW/17.52	N/25.77	SSE/31.95	W/19.58	NW/25.77	NNE/19.59	SSE/13.40	SSW/21.64	N/16.50
Ave Wind Speed	(MPH)	12.04		12.46	3.94	9.02	11.80	7.12	8.3	8.0	11.0	10.1
Ave Solar Radiation	(Watt/m ²)	600.61		120.44	188.22	56.70	231.11	172.03	587.7	638.9	34.1	658.2
Ave Air Temperature	(F)	37.96		35.88	36.92	42.26	54.85	45.51	43.3	49.4	50.4	60.7
Total Precipitation	(inches)	0.00		0.12	0.00	0.00	0.40	0.09	0.00	0.00	1.23	0.00
Tide H/L (MAG)	(FT)	3.0H		3.3H	3.6H	3.8H	4.0H	4.2H	4.3H	4.2H	4.0H	3.9H
24 Hour Event		1200-1200	1800-1800			1200-1200		1200-1200		1200-1200		1200-1200
Ave Wind Direction	Primary	NW/60.21	NNE/18.68			SE/35.30		NNW/32.18		SSW/37.03		SSW/25.60
(Direction/Percent)	Secondary	WNW/34.26	S/14.53			S/34.26		NW/12.80		S/31.15		NNW/23.87
Ave Wind Speed	(MPH)	17.26	8.12			8.48		8.07		7.7		9.2
Ave Solar Radiation	(Watt/m ²)	247.76	170.02			176.80		193.43		306.1		153.5
Ave Air Temperature	(F)	28.49	41.70			43.68		51.79		45.1		54.2
Total Precipitation	(inches)	0.00	0.05			0.00		0.15		0.00		1.09
Tide H/L (MAG)	(FT)	3.4/0.4	3.3/0.6			3.8/0.1		4.6/-0.5				4.5/-0.3

New Bedford Harbor Superfund Site
 Ambient Air Monitoring
 PCB Concentrations (AROCLORS)
 Reported in ng/m³
 Sample Locations 22-Sep-97

Sample Locations	Sample Date	042195	042495	042595	042695	042795	042895	050195	050295	050395	050495	050595
CDF Area (24 hr)/(8hr)												
Sampler #1					35.45		17.97			33.29		15.76
Sampler #2					123.54		25.31			35.22		20.78
Sampler #3					612.89 D		728.48 D			327.05		1112.57 D
Sampler #3-D					464.15 D		QA			QA		SPLIT
Sampler #4					16.59 RR		5.70			41.07		5.16
Sampler #5					41.09		5.48			52.08		5.97
Sampler #6					123.53		10.03			128.17		21.47
Sampler #17												
Average On Site (1-3,6)					205.26		195.45			130.93		292.65
Off Site CDF Area (24 hr)												
Sampler #7							6.02			32.81		
Sampler #8							4.38			8.22		
Sampler #9							71.82 D			16.16		
Off Site Dredge Area (8 hr on tide)												
Tide Level		HIGH-D	HIGH-D	HIGH-D	HIGH-D	HIGH-D	HIGH-D	HIGH-D	HIGH-D	HIGH-D	HIGH-D	HIGH-D
Sampler #10		3.23	21.69	34.36	33.88	17.86	15.45	4.63	10.24	7.01	13.16	12.19
Sampler #11		82.93	122.27	130.75	68.95	300.84	139.09	107.68	92.14	119.31	289.52	431.54
Sampler #12		14.02	7.62	9.05	11.58	18.17	32.87	7.06	12.74	9.22	32.73	37.79
Sampler #13		31.37	16.23	10.64	105.64	22.78	78.43	2.95	27.08	7.99	53.58	70.58
Sampler #13-D		35.00	19.35	5.91	QA	24.65	71.35	2.37	25.36	QA	57.33	73.29
Sampler #14		1.42	0.39 U	0.40 U	14.91	8.62	9.45	0.39 U	7.07	13.34	1.72	4.99
Sampler #15		3.08	21.09	18.56	15.20	11.19	15.41	3.66	10.57	12.18	8.94	9.72
Sampler #16		1.63	0.39 U	0.39 U	7.72	10.70	10.12	1.01	6.36	4.39	4.62	2.77
Average of Dredge		22.71	28.26	27.90	37.33	62.20	46.97	20.41	25.85	27.74 P	65.50	93.12

Environmental
 Conditions

8 Hour Event	1000-1800	0030-0830	0130-0930	0200-1000	0300-1100	0400-1200	0530-1330	0630-1430	0700-1500	0800-1600	0830-1630
Ave Wind Direction (Direction/Percent)	Primary SSE/39.17 Secondary S/32.98	NNE/24.74 NNW/21.64	N/59.79 NNE/26.80	W-WSW/27.8 WNW/24.7	S/39.2 SSE/30.93	S/31.96 SW/29.9	NNE/61.9 NE/37.1	SSW/21.7 S/18.6	NNE/63.9 NE/19.6	S/49.5 SSW/13.4	S/86.60 SSW/12.37
Ave Wind Speed (MPH)	10.0	4.2	9.0	6.67	4.8	6.4	17.9	6.1	14.1	9.1	9.4
Ave Solar Radiation (Watt/m ²)	285.4	76.1	232.1	219.3	159.9	108.6	99.9	312.0	653.8	631.9	326.3
Ave Air Temperature (F)	50.7	45.0	44.9	50.6	48.6	53.0	41.0	48.9	54.8	63.9	55.2
Total Precipitation (inches)	0.03	0.00	0.00	0.00	0.00	0.09	0.57	0.00	0.00	0.00	0.00
Tide H/L (MAG) (FT)	3.8H	3.8H	4.2H	3.9H	3.9H	3.9H	3.8H	3.6H	3.5H	3.3H	3.2H
24 Hour Event				1200-1200		1200-1200			1200-1200		1200-1200
Ave Wind Direction (Direction/Percent)	Primary Secondary			WSW/29.75 SW/15.9		S/45.3 SW/23.5			NNE/30.1 NE/26.7		S/45.67 SSW/20.42
Ave Wind Speed (MPH)				8.56		8.3			11.1		7.9
Ave Solar Radiation (Watt/m ²)				279.9		185.4			199.0		203.0
Ave Air Temperature (F)				51.8		53.9			48.8		56.4
Total Precipitation (inches)				0.00		0.09			0.02		0.00
Tide H/L (MAG) (FT)				3.9/0.0		4.5/-0.1			4.1/0.1		3.6/0.3

New Bedford Harbor Superfund Site
Ambient Air Monitoring
PCB Concentrations (AROCLORS)
Reported in ng/m³

Sample Locations 22-Sep-97

CDF Area	Sample Date	050895	050995	051095	051195	051295	051595	051695	051795	051895	051995	052295
(24 hr)/(8hr)												
Sampler #1			74.33			79.18			27.14		32.73	
Sampler #2			72.86			75.06			34.41		63.90	
Sampler #3			NO VOL.			24.88			887.17 D		230.67	
Sampler #3-D			366.74 D			16.03			QA		232.77	
Sampler #4			56.34			15.13			7.42		25.59	
Sampler #5			117.87			9.81			6.20		32.36	
Sampler #6			215.60			40.90			25.95		59.54	
Sampler #17												
Average On Site (1-3,6)			120.93			53.90			243.67		96.97	
Off Site CDF Area (24 hr)												
Sampler #7						6.53					23.28	
Sampler #8						5.17					19.34	
Sampler #9						4.40					57.07	
Off Site Dredge Area (8 hr on tide)												
Tide Level		HIGH-D	HIGH-D	HIGH-D	HIGH-D	HIGH-D	HIGH-D	HIGH-D	HIGH-D	HIGH-D	HIGH-D	HIGH-D
Sampler #10		8.52	17.34	13.98	0.39 U	21.11	0.41 U	21.23	2.19	13.84	4.81	151.61 P
Sampler #11		LOST @ LAB	413.40	194.96	59.96	38.70	2.10	461.50	170.77	312.77	135.37	428.76 D,P
Sampler #12		6.66	51.10	41.20	1.60	5.16	168.98	28.57	17.87	30.31	12.79	19.66 P
Sampler #13		QA	163.26	69.14	6.88	13.16	18.27	43.40	38.10	148.98	7.63	236.95 P
Sampler #13-D		3.22	QA	75.24	11.64	8.73	18.95	QA	30.77	139.82	6.72	235.04 P
Sampler #14		0.39 U	4.05	6.45	0.70 J	0.39 U	15.85	0.40 U	0.40 U	9.46	0.39 U	22.05 P
Sampler #15		15.41	10.56	10.22	0.40 U	25.73	0.41 U	16.34	0.40 U	15.64	8.83	58.09 P
Sampler #16		2.25	6.13	6.06	2.17	16.66	2.29	11.15	0.42 U	0.43 U,	0.42 U	22.16 P
Average of Dredge		4.26	108.09	55.18	12.35	16.26	34.71	93.56	37.38	85.50	27.50	131.12 P
Environmental Conditions												
8 Hour Event		1130-1930	1230-2030	0030-0830	0130-0930	0230-1030	0500-1300	0600-1400	0630-1430	0730-1530	0830-1630	1130-1930
Ave Wind Direction (Direction/Percent)	Primary Secondary	NNE/32.17 NE/29.76	S/49.46 SSW/28.57	SSW/49.48 S/22.68	ESE/61.86 SE/26.80	NNW/68.04 N/29.89	SE/50.52 SSE/37.11	S/45.37 NNE/16.49	S/48.45 SSE/39.17	SSE/30.93 S/30.93	NNE/68.03 NE/21.65	NW/31.87 WNW/28.57
Ave Wind Speed (MPH)		15.4	8.8	4.8	13.2	10.5	7.4	8.4	15.1	6.4	8.1	11.6
Ave Solar Radiation (Watt/m ²)		414.4	369.5	60.4	14.8	105.8	79.1	556.6	143.6	313.6	115.7	536.2
Ave Air Temperature (F)		110.7	55.9	50.9	48.8	47.7	48.1	54.4	51.8	58.6	52.4	71.1
Total Precipitation (inches)		0.00	0.00	0.00	0.03	0.00	0.10	0.00	0.11	0.00	0.08	0.00
Tide H/L (MAG) (FT)		3.4H	3.7H	3.5H	3.8H	4.0H	4.5H	4.5H	4.4H	4.3H	4.1H	4.0H
24 Hour Event			1200-1200			1200-1200			1200-1200		1200-1200	
Ave Wind Direction (Direction/Percent)	Primary Secondary		NE/53.61 NNE/35.05			NNW/46.71 N/19.38			S/34.96 SSE/30.80		S/14.54 SSE/13.15	
Ave Wind Speed (MPH)			9.0			9.8			11.7		5.1	
Ave Solar Radiation (Watt/m ²)			313.8			73.2			203.4		79.1	
Ave Air Temperature (F)			50.0			49.2			50.8		55.6	
Total Precipitation (inches)			0.00			0.20			0.00		0.08	
Tide H/L (MAG) (FT)			3.4/0.6			4.0/-0.2			5.2/-0.7		5.0/-0.3	

New Bedford Harbor Superfund Site
 Ambient Air Monitoring
 PCB Concentrations (AROCLORS)
 Reported in ng/m³
 Sample Locations

22-Sep-97

Sample Date	052395	052495	052595	052695	053095	053195	060195	060295	060595	060695	060795
CDF Area (24 hr)/(8hr)											
Sampler #1	86.77 D			35.73	40.56		112.45			14.52	
Sampler #2	242.68 D			40.05	78.41		380.70			23.34	
Sampler #3	178.55 D			301.28 D	94.48		79.03			74.82 D	
Sampler #3-D	180.54 D			325.65 D	66.42		QA			QA	
Sampler #4	SEE # 17			SEE #17	SEE #17		SEE #17				
Sampler #5	15.89			68.22 D	1.77		1.39			3.57	
Sampler #6	67.44			222.24 D	6.27		6.01			13.69	
Sampler #17	50.36			48.55	4.02		4.89			6.50	
Average On Site (1-3,6)	125.36			132.01	41.94		116.62			26.57	
Off Site CDF Area (24 hr)											
Sampler #7	5.99			35.81			1.16				
Sampler #8	0.14 U			20.04			0.14 U				
Sampler #9	13.75			25.66			23.79				
Off Site Dredge Area (8 hr on tide)											
Tide Level	NON-DREDG	NON-DREDGE	NON-DREDG	NON-DREDGE			HIGH-D	HIGH-D	HIGH-D	HIGH-D	HIGH-D
Sampler #10	54.59	74.56					74.92	78.08	71.13	59.70	15.93
Sampler #11	688.39	240.34					258.97	375.95	443.80	422.32	622.44
Sampler #12	141.11	41.73					16.51	24.70	41.94	50.72	89.54
Sampler #13	284.24	488.53					139.86	293.67	426.09	223.40	259.50
Sampler #13-D	QA	451.92					148.85	QA	254.49	QA	290.08
Sampler #14	19.21	70.07					32.97	65.35	37.04	21.09	0.39 U
Sampler #15	42.04	76.91					94.18	75.90	55.83	39.61	10.41
Sampler #16	24.34	55.62					15.33	20.27	31.46	26.61	5.76
Average of Dredge	199.89	159.15					93.72	142.64	158.39	130.62	167.22

Environmental
 Conditions

8 Hour Event	1230-2030	1315-2115	SHUT-DOWN	SHUT-DOWN	SHUT-DOWN	0600-1400	0700-1500	0730-1530	0900-1700	1100-1900	1130-1930
Ave Wind Direction (Direction/Percent)	Primary SW/80.22 Secondary SSW/17.59	SW/45.84 WSW/42.71				WNW/56.70 W/29.90	W/38.15 WSW/30.93	SW/71.60 SSW/17.28	SW/59.80 SSW/25.77	S/49.48 SSE/47.42	N/52.58 NNE/26.80
Ave Wind Speed (MPH)	12.1	13.4				8.6	10.8	11.1	10.0	9.9	13.9
Ave Solar Radiation (Watt/m ²)	374.9	236.5				650.9	707.0	666.9	661.0	600.8	76.8
Ave Air Temperature (F)	64.5	64.9				74.3	80.9	72.4	70.9	71.6	63.9
Total Precipitation (inches)	0.00	0.00				0.00	0.00	0.00	0.00	0.00	1.00
Tide H/L (MAG)	(FT) 4.1H	4.2H				3.7H	3.6H	3.5H	3.5H	3.7H	4.0H
24 Hour Event	1200-1200			1200-1200	1200-1200		1200-1200			1100-1100	
Ave Wind Direction (Direction/Percent)	Primary NW/35.29 Secondary NNW/13.50			ENE/23.19 E/20.76	SW/39.09 WNW/19.03		W/46.37 WSW/19.38			SW/43.85 SSW/17.94	
Ave Wind Speed (MPH)	8.2			6.9	10.7		9.2			7.1	
Ave Solar Radiation (Watt/m ²)	364.3			221.5	144.7		385.5			313.6	
Ave Air Temperature (F)	63.8			57.8	62.0		76.0			66.4	
Total Precipitation (inches)	0.00			0.01	0.36		0.00			0.00	
Tide H/L (MAG)	(FT) 3.7/0.5			3.7/0.3	4.4/0.1		4.2/0.2			3.5/0.6	

New Bedford Harbor Superfund Site
 Ambient Air Monitoring
 PCB Concentrations (AROCLORS)
 Reported in ng/m³

Sample Locations 22-Sep-97

CDF Area	Sample Date	060895	060995	061295	061395	061495	061595	061695	061995	062095	062195	062295
(24 hr)/(8hr)												
Sampler #1		10.02				47.52		105.41		94.40		56.98
Sampler #2		84.00				21.23		189.95		179.64		71.29
Sampler #3		290.87				30.21		38.51		139.48		717.64
Sampler #3-D		270.57				34.70		QA		120.73		QA
Sampler #4												
Sampler #5		65.97				65.51		19.18		82.19		83.61
Sampler #6		144.17				142.82		40.30		223.33		323.00
Sampler #17		60.97				206.63		24.29		156.01		66.37
Average On Site (1-3,6)												
		115.98				90.13		79.69		156.70		247.06
Off Site CDF Area (24 hr)												
Sampler #7		36.79						10.31		20.38		
Sampler #8		20.88						6.29		3.38		
Sampler #9		65.01						18.66		20.30		
Off Site Dredge Area (8 hr on tide)												
Tide Level		HIGH-D	HIGH-D	HIGH-D	HIGH-D	HIGH-D	HIGH-D	HIGH-D	HIGH-D	HIGH-D	HIGH-D	HIGH-D
Sampler #10		7.96	6.15	34.00	5.12	7.33	71.60	68.30	74.82	38.25	20.27	7.85
Sampler #11		224.45	319.43	276.83	267.10	239.54	132.11	206.85	78.86	189.05	55.56	10.79
Sampler #12		21.59	22.26	56.35	26.36	31.25	27.94	14.30	14.74	10.69	17.89	17.98
Sampler #13		46.64	8.08	132.91	13.48	10.69	30.13	138.73	123.60	173.81	19.45	33.77
Sampler #13-D		86.04	5.88	133.53	10.05	6.64	27.64	QA	147.42	167.61	15.81	29.37
Sampler #14		0.39 U	0.39 U	16.31	0.38 U	0.39 U	0.39 U	32.00	82.97	69.40	5.36	8.73
Sampler #15		11.84	12.80	29.15	11.18	19.14	70.80	44.35	46.09	44.10	15.84	15.36
Sampler #16		9.95	0.39 U	16.06	0.38 U	2.17	26.11	10.08	15.58	12.52	14.80	ELEC DISCO
Average of Dredge		55.76	60.38	87.99	52.86	50.19	47.71	74.39	62.29	97.16	21.18	14.07

Environmental
 Conditions

8 Hour Event	Primary	1230-2030	1330-2130	0400-1200	0430-1230	0530-1330	0630-1430	0700-1500	2130-0530	2230-0630	2315-0715	0030-0830
Ave Wind Direction (Direction/Percent)	Secondary	SE/22.68	NE/50.5	SW/35.1	NE/83.5	NNE/69.1	NNW/50.5	W/48.46	WSW/62.89	WSW/29.89	NNE/45.83	NE/39.17
		NE/17.52	NNE/35.1	SSW/29.9	NNE/16.5	NE/21.6	NW/28.9	WNW/24.74	W/35.05	W/28.86	NE/26.05	ENE/20.62
Ave Wind Speed (MPH)		9.7	9.2	6.2	9.9	9.4	14.1	8.8	7.23	4.98	3.66	3.31
Ave Solar Radiation (Watt/m ²)		208.3	365.4	115.5	71.8	106.2	575.3	668.9	3.34	8.89	45.67	64.51
Ave Air Temperature (F)		68.8	63.9	63.2	57.8	58.0	63.6	71.0	69.21	72.62	60.12	59.73
Total Precipitation (inches)		0.59	0.00	0.30	0.06	0.08	0.00	0.00	0.00	0.00	0.00	0.00
Tide H/L (MAG)		4.3H	4.7H	4.4H	4.5H	4.6H	4.6H	4.5H	4.1H	3.8H	3.6H	3.5H
24 Hour Event		1100-1100				1100-1100		1100-1100		1100-1100		
Ave Wind Direction (Direction/Percent)	Primary	N/18.00				NNE/82.0		W/20.76		WSW/38.06		
	Secondary	S/15.57				NE/14.9		SW/17.99		W/18.35		
Ave Wind Speed (MPH)		8.3				9.9		8.4		8.46		
Ave Solar Radiation (Watt/m ²)		148.1				59.6		319.0		305.50		
Ave Air Temperature (F)		66.1				57.9		62.1		79.15		
Total Precipitation (inches)		1.00				0.07		0.00		0.00		
Tide H/L (MAG)		3.6/0.5				5.4/-0.7		5.1/-0.5		3.8/0.6		

New Bedford Harbor Superfund Site
 Ambient Air Monitoring
 PCB Concentrations (AROCLORS)
 Reported in ng/m³

Sample Locations 22-Sep-97

CDF Area	Sample Date	062395	062695	062795	062895	062995	063095	070595	070695	070795	071095	071195
(24 hr)/(8hr)												
Sampler #1					69.30		22.86		20.62	21.27		
Sampler #2					74.88		32.20		18.16	14.16		
Sampler #3					119.57		474.92 D		954.49 D	648.30 D		
Sampler #3-D				QA			364.64 D		853.24 D	480.46 D		
Sampler #4												
Sampler #5					204.56		5.41		15.49	2.99		
Sampler #6					240.22		57.75		52.21	21.54		
Sampler #17					102.26		7.40		6.85	4.80		
Average On Site (1-3,6)						121.25		108.00		200.34	125.23	
Off Site CDF Area (24 hr)												
Sampler #7					107.87					2.67		
Sampler #8					20.96					1.74		
Sampler #9					25.43					86.79 D		
Off Site Dredge Area (8 hr on tide)												
Tide Level		HIGH-D	HIGH-D	HIGH-D	HIGH-D	HIGH-D	HIGH-D	HIGH-D	HIGH-D	HIGH-D	HIGH-D	HIGH-D
Sampler #10		7.56	9.60	0.40 U	12.67	28.74	46.78	34.18	26.00	18.28	61.49	31.00
Sampler #11		96.63	116.41	131.95	312.17	288.16	540.18	216.97	222.08	672.97 D	99.83	216.52
Sampler #12		12.17	46.81	2.68	22.91	48.32	74.93	33.15	48.37	68.57	27.63	77.36
Sampler #13		17.56	118.12	2.67	39.64	128.84	237.71	104.35	299.52	180.09 D	100.93	138.10
Sampler #13-D		QA	91.61	1.63	QA	120.43	241.27	108.96	QA	157.90 D	103.70	169.63
Sampler #14		0.86	5.44	0.39 U	0.39 U	15.13	15.65	25.62	11.41	9.28	28.62	19.22
Sampler #15		12.23	9.00	0.40 U	15.30	23.99	18.37	15.13	21.64	21.39	42.19	31.97
Sampler #16		4.33	6.98	0.38 U	6.56	13.49	10.86	11.55	8.52	12.29	9.49	19.07
Average of Dredge		23.96	48.25	22.99	66.16	85.62	149.91	68.18	101.92	179.20 P	51.68	86.33

Environmental
 Conditions

8 Hour Event	0100-0900	0330-1130	0400-1200	0500-1300	0530-1330	0400-1200	2130-0530	2230-0630	2330-0730	0230-1030	0330-1130
Ave Wind Direction (Direction/Percent)	Primary NNE/41.67 Secondary NE/33.33	SSE/19.59 E/15.46	E/54.64 ENE/45.36	N/18.55 NNE/16.49	WNW/23.71 SSE/22.67	SSW/30.00 SW/24.44	WSW/39.18 SW/19.59	SSW/89.70 SW/8.24	SSW/71.14 SW/22.68	WNW/63.92 NW/14.43	SSW/45.4 NNE/8.3
Ave Wind Speed (MPH)	3.98	4.22	13.40	5.79	7.07	5.38	3.91	5.94	7.36	6.61	5.60
Ave Solar Radiation (Watt/m ²)	132.65	139.90	412.04	598.33	612.41	436.10	2.04	43.88	55.68	230.57	45.11
Ave Air Temperature (F)	55.18	68.45	64.40	60.95	67.92	MALFUNCTI	MALFUNC	MALFUNC	MALFUNC	MALFUNC	74.61
Total Precipitation (inches)	0.00	0.00	0.00	0.00	0.00	0.00	0.00	0.00	0.00	0.00	0.16
Tide H/L (MAG) (FT)	3.5H	3.7H	3.8H	3.9H	3.9H	3.8H	3.6H	3.6H	3.6H	4.2H	4.5H

24 Hour Event

Ave Wind Direction (Direction/Percent)	Primary Secondary
Ave Wind Speed (MPH)	
Ave Solar Radiation (Watt/m ²)	
Ave Air Temperature (F)	
Total Precipitation (inches)	
Tide H/L (MAG) (FT)	

New Bedford Harbor Superfund Site
 Ambient Air Monitoring
 PCB Concentrations (AROCLORS)
 Reported in ng/m³

Sample Locations 22-Sep-97

CDF Area	Sample Date	071295	071395	071495	071795	071895	071995
(24 hr)/(8hr)							
Sampler #1		51.98		13.06		38.06	
Sampler #2		57.31		27.31		51.25	
Sampler #3		237.12 D		94.21 D		186.43	
Sampler #3-D		229.07 D		93.28 D		QA	
Sampler #4							
Sampler #5		23.66		0.84		27.41	
Sampler #6		140.47 D		3.84		157.86	
Sampler #17		35.02		1.95		38.20	
Average On Site (1-3,6)							
		103.58		27.98		94.36	
Off Site CDF Area							
(24 hr)							
Sampler #7				1.53		19.51	
Sampler #8				3.35		10.60	
Sampler #9				37.29		23.97	
Off Site Dredge Area							
(8 hr on tide)							
Tide Level		HIGH-D	HIGH-D	HIGH-D	HIGH-D	HIGH-D	HIGH-D
Sampler #10		20.76	61.24	47.24 D	4.48	16.15	49.51
Sampler #11		247.52 D	188.22	107.33 D	139.79	118.56	135.90
Sampler #12		59.64	64.71	40.22 D	21.81	22.54	49.43
Sampler #13		78.41	305.03 D	280.60	44.15	17.18	76.36
Sampler #13-D		QA	QA	271.20	57.35	15.68	QA
Sampler #14		5.30	35.44	40.15 D	3.18	1.69	11.10
Sampler #15		35.89	51.68	70.61 D	4.88	18.00	36.38
Sampler #16		7.90	29.83 R	18.81	1.58	5.90	19.39
Average of Dredge		75.00	122.04	92.17	37.00	30.52 P	54.76

Environmental Conditions

8 Hour Event	0415-1215	0500-1300	0600-1400	2000-0400	2000-0400	2200-0600
Ave Wind Direction	S/24.0	SW/63.9	W/26.80	SSE/64.95	N/27.83	NNE/24.74
(Direction/Percent)	Secondary NNE/12.5	WSW/18.6	S/25.77	S/25.77	NE/10.31	NE/21.64
Ave Wind Speed	(MPH) 5.78	6.61	4.50	7.24	4.80	4.91
Ave Solar Radiation	(Watt/m ²) 331.56	330.78	333.24	7.04	0.76	1.67
Ave Air Temperature	(F) 75.14	79.61	MALFUNCTI	67.91	67.22	70.22
Total Precipitation	(inches) 0.01	0.00	MALFUNCTI	0.00	0.33 W	0.03 W
Tide H/L (MAG)	(FT) 4.7H	4.8H	4.8H	4.4H	4.0	3.7H
24 Hour Event					1200-1200	
Ave Wind Direction	Primary				SE/22.49	
(Direction/Percent)	Secondary				N/14.19	
Ave Wind Speed	(MPH)				6.30	
Ave Solar Radiation	(Watt/m ²)				98.38	
Ave Air Temperature	(F)				67.90	
Total Precipitation	(inches)				0.50 W	
Tide H/L (MAG)	(FT)					

New Bedford Harbor Superfund Site
 Ambient Air Monitoring
 PCB Concentrations (AROCLORS)
 Reported in ng/m³

Sample Locations 22-Sep-97

Sample Locations	Sample Date	072095	072095	072495	072595	072695	072795	072895	073195	080195	080295	080395
CDF Area (24 hr)/(8hr)												
Sampler #1		215.60 D				23.99		41.06			21.04	45.01
Sampler #2		259.90 D				21.94		60.98			32.50	50.90
Sampler #3		330.72 D				372.89 D		411.14 D			317.37 D	364.63 D
Sampler #3-D		274.74 D				QA		320.43 D			QA	368.32 D
Sampler #4												
Sampler #5		60.60 D				4.93		8.46			2.16	48.99
Sampler #6		181.29 D				25.16		64.88			29.86	157.14 D
Sampler #17		57.54 D				4.97		12.16 R			3.40	88.73 D
Average on site (1-3,6)		203.41				88.80		108.97			80.83	141.65
Off Site CDF Area (24 hr)												
Sampler #7								8.15			1.45	
Sampler #8								4.40			2.65	
Sampler #9								18.29 D			28.11	
Off Site Dredge Area (8 hr on tide)												
Tide Level		HIGH-D	HIGH-D	HIGH-D	HIGH-D	HIGH-D	HIGH-D	HIGH-D	HIGH-D	HIGH-D	HIGH-D	HIGH-D
Sampler #10		37.76	60.15	53.35	12.03	74.92	79.88	10.44	24.68	46.75	66.40	12.61
Sampler #11		492.93 D	179.40 V	199.93	417.45	189.84	166.53	580.31	430.54	74.35	71.20	212.77
Sampler #12		63.30	27.26	33.19	58.02	68.62	44.52	61.24	NA	37.93	19.40	46.13
Sampler #13		87.87	168.88 D	139.29	98.60	363.20	227.05	311.48	25.16	115.89	122.95	10.58
Sampler #13-D		96.42	201.96 D	167.08	111.10	QA	220.69	186.81	25.46	116.55	QA	11.49
Sampler #14		27.97 R	35.37	23.42	12.43	25.36	65.86	4.30	0.39 U	67.35	57.28	3.49
Sampler #15		19.96	46.77	38.66	15.34	37.46	64.47	9.60	39.75	25.08	33.57	23.46
Sampler #16		9.90	23.09	9.21	12.18	28.49	20.00	5.51	12.93	11.62	10.72	5.64
Average of Dredge (11 - 16)		117.70	82.89	76.27	103.38	118.83	97.54	151.68	101.78	55.43	52.52	50.42

Environmental
 Conditions

8 Hour Event	Primary	2300-0700	1100-1900	0200-1000	0300-1100	0400-1200	0430-1230	0500-1300	1845-0245	1930-0330	2015-0415	2100-0500
Ave Wind Direction (Direction/Percent)	Secondary	ENE/16.49	SW/73.20	NW/40.20	SSE/48.45	SW/89.69	WNW/25.78	S/41.24	NNE/37.96	W/38.9	W/56.25	NNE/62.89
		NE/13.40	WSW/19.59	WNW/20.61	S/37.11	SSW/10.31	NW/22.68	SSE/22.67	N/15.74	WSW/38.9	WSW/41.66	NE/29.9
Ave Wind Speed (MPH)		2.91	12.01	6.76	4.56	8.49	5.69	7.08	4.58	5.10	8.43	6.80
Ave Solar Radiation (Watt/m ²)		11.34	678.42	171.70	54.39	99.20	387.22	308.92	27.11	4.56	3.67	0.00
Ave Air Temperature (F)		68.25	81.33	74.54	74.05	76.21	80.89	74.88	75.43	72.31	74.74	72.06
Total Precipitation (inches)		0.00	0.00	0.00	0.00	0.01	0.00	0.02	0.00	0.00	0.00	0.00
Tide H/L (MAG) (FT)		3.5H	4.0H	4.0H	3.7H	4.5H	4.0H	4.1H	4.2H	4.1H	3.9H	3.7H
24 Hour Event		1200-1200				1200-1200		1200-1200		1200-1200	1200-1200	1200-1200
Ave Wind Direction (Direction/Percent)	Primary	WNW/21.80				SW/55.71		WSW/19.72		WSW/29.76	NE29.06	NE29.06
	Secondary	NW/19.72				SSW/28.72		SW/18.34		W/22.49	NNE28.03	NNE28.03
Ave Wind Speed (MPH)		7.03				7.68		6.87		7.55	7.28	7.28
Ave Solar Radiation (Watt/m ²)		350.45				123.06		271.05		334.72	200.44	200.44
Ave Air Temperature (F)		75.41				76.65		79.34		79.82	74.99	74.99
Total Precipitation (inches)		0.00				0.01		0.05		0.00	0.00	0.00
Tide H/L (MAG) (FT)						4.4/0.4		4.5/0.1		3.9/0.0	3.7/0.1	3.7/0.1

New Bedford Harbor Superfund Site
 Ambient Air Monitoring
 PCB Concentrations (AROCLORS)
 Reported in ng/m³

Sample Locations 22-Sep-97

CDF Area (24 hr)/(8hr)	Sample Date	080495	080795	080895	080995	081095	081195	081495	081595	081695	081795	081795
Sampler #1					106.47		10.79		53.73		54.09	
Sampler #2					115.87		19.95		58.65		66.78	
Sampler #3					100.72		112.36 D		1124.66 D		809.15 D	
Sampler #3-D					97.79		106.53		966.00 D		686.71 D	
Sampler #4												
Sampler #5					151.77 D		2.23		18.03		49.56	
Sampler #6					375.61 D		4.61		114.43		231.59 D	
Sampler #17					153.89 D		4.11		17.44		103.22	
Average on site (1-3,6)					170.22		29.78		257.91		240.72	
Off Site CDF Area (24 hr)												
Sampler #7							0.14 U				22.03	
Sampler #8							0.14 U				9.44	
Sampler #9							44.14				85.84	
Off Site Dredge Area (8 hr on tide)												
Tide Level		HIGH-D	HIGH-D	HIGH-D	HIGH-D	HIGH-D	HIGH-D	HIGH-D	HIGH-D	HIGH-D	HIGH-D	RELOCATE
Sampler #10		14.26	7.65	47.73	42.60	46.30	51.27	28.38	7.32	5.08	21.83	7.33
Sampler #11		163.67	130.93	122.45 D	235.69 D	178.72	179.53	181.89	242.27	131.85	310.20	246.26
Sampler #12		34.85	35.25	33.52	37.88	23.95	38.62	71.73	30.50	19.19	55.24	46.62
Sampler #13		55.10	5.91	9.85	51.94	107.17	248.24	64.35	54.08	46.25	156.34	12.38
Sampler #13-D		34.16	27.26	QA	QA	88.78	230.80	QA	QA	49.09	149.01	8.70
Sampler #14		9.01	1.97	0.39 U	2.85	34.07	44.66	12.22	1.62	0.39 U	8.56	1.67
Sampler #15		9.68	42.71	43.62	28.59	33.98	52.77	22.16	5.88	0.40 U	19.93	16.89
Sampler #16		7.11	3.16	9.49	9.97	15.80	21.18	9.40	6.07	4.20	9.29	2.57
Average of Dredge (11 - 16)		44.82	38.43	36.55	61.15	64.08	96.05	54.93	47.72	33.95	92.65	54.09

Environmental
Conditions

8 Hour Event		2200-0600	0130-0930	0200-1000	0300-1100	0400-1200	0500-1300	1900-0300	1930-0330	2030-0430	2030-0430	1000-1800
Ave Wind Direction (Direction/Percent)	Primary Secondary	S/18.55 NE/17.53	NNE/59.8 NE/39.2	NNE/49.5 N/38.14	NNE/33.0 NW/22.7	W/44.3 WNW/39.2	WSW/58.76 SW/25.77	S/11.34 SSW/11.34	S/63.31 SSE/33.03	SSE/37.11 S/15.46	SSW/31.95 S/16.49	NE/57.73 NNE/26.81
Ave Wind Speed (MPH)		3.28	9.34	7.36	4.08	5.98	6.20	3.66	7.88	4.66	4.85	9.58
Ave Solar Radiation (Watt/m ²)		0.22	97.56	168.44	256.89	350.44	422.79	2.28	11.34	0.10	1.51	506.04
Ave Air Temperature (F)		69.80	63.60	59.81	65.42	70.51	74.54	69.73	72.01	73.29	75.32	81.56
Total Precipitation (inches)		0.01	0.02	0.00	0.00	0.00	0.00	0.00	0.00	0.00	0.00	0.00
Tide H/L (MAG)	(FT)	3.6H	4.0H	4.3H	4.6H	4.8H	4.9H	4.6H	4.3H	3.9H	3.6H	4.0H
24 Hour Event					1200-1200		1200-1200		1200-1200		1200-1200	
Ave Wind Direction (Direction/Percent)	Primary Secondary				NNE/17.0 NE/15.9		WSW/57.79 SW/31.83		S/50.17 SSE/34.26		S/31.15 SSE/12.11	
Ave Wind Speed (MPH)					5.34		7.25		8.38		6.27	
Ave Solar Radiation (Watt/m ²)					351.48		336.02		323.94		284.57	
Ave Air Temperature (F)					69.87		73.55		74.17		78.06	
Total Precipitation (inches)					0.00		0.00		0.00		0.00	
Tide H/L (MAG)	(FT)				5.1/-0.2		5.2/-0.5		4.3/0.1		3.6/0.6	

New Bedford Harbor Superfund Site
 Ambient Air Monitoring
 PCB Concentrations (AROCLORS)
 Reported in ng/m³

Sample Locations 22-Sep-97

Sample Date	082195	082295	082395	082495	082595	082895	082995	083095	083195	090195
CDF Area (24 hr)/(8hr)										
Sampler #1		130.62 D	181.62 D				65.36 P		114.34 D	
Sampler #2		293.14 D	180.55 D				66.43 P		88.74 D	
Sampler #3		76.48 D	15.59				277.84 DP		255.28 D	
Sampler #3-D		QA	19.04				280.72 DP		QA	
Sampler #4										
Sampler #5		4.08	7.95				51.13 P		24.87	
Sampler #6		13.60	56.19				216.36 P		99.86 D	
Sampler #17		28.86	59.14				92.97 P		117.12 D	
Average on site (1-3,6)		108.54	98.96				144.08 P		135.07	
Off Site CDF Area (24 hr)										
Sampler #7		1.97					23.77 P			
Sampler #8		3.04					11.60 P			
Sampler #9		12.57					31.90 P			
Off Site Dredge Area (8 hr on tide)										
Tide Level	HIGH-D	HIGH-D	HIGH-D	HIGH-D	HIGH-D	HIGH-D	HIGH-D	HIGH-D	HIGH-D	HIGH-D
Sampler #10	21.89	42.79	28.38	64.87	41.63 R	6.60	24.99 P	39.32	20.25	75.38
Sampler #11	108.18	123.02 D	228.50	80.14	154.13 R	109.34	226.81 P	259.82	152.29	61.36
Sampler #12	16.29	28.69	18.69	19.72	29.91	22.56	47.20 P	116.46	59.62	38.63
Sampler #13	9.15	91.08	18.28	173.01 D	18.24	7.58	99.62 P	170.79	48.51	35.29
Sampler #13-D	8.02	QA	25.66	188.22 D	19.34	7.63	63.40 P	163.14	QA	173.79
Sampler #14	0.39 U	28.87	0.39 U	50.14	1.96	0.41 U	0.40 UO	34.38	4.14	47.97
Sampler #15	22.82	31.25	43.12	34.11	63.06	16.67	NC	37.55	15.13	30.94
Sampler #16	9.47	10.13	18.46	15.70	14.68	5.79	33.33 P	18.09	14.52	15.50
Average of Dredge (11 - 16)	27.62	52.17	55.19	63.41	47.09	27.06	77.85 P	105.55	49.03	49.82

Environmental Conditions

	0100-0900	0200-1000	0230-1030	0330-1130	0400-1200	0600-1400	0700-1500	1900-0300	2000-0400	2100-0500
Ave Wind Direction (Direction/Percent)	Primary NNE/40.21 Secondary N/26.80	NW/42.27 WNW/34.02	NNE/39.18 NW/30.92	WSW/43.30 W/34.02	NNW/40.21 N/30.92	E/28.87 ENE/17.52	S/38.14 NNE/23.71	SW/22.68 SSW/21.65	N/23.71 SSW/17.52	WSW/72.17 SW/15.46
Ave Wind Speed (MPH)	4.36	7.11	6.59	10.87	11.94	9.88	6.61	4.46	4.03	10.31
Ave Solar Radiation (Watt/m ²)	83.19	143.91	192.38	274.96	319.90	520.49	577.16	8.88	0.33	0.08
Ave Air Temperature (F)	59.02	72.26	62.55	72.75	60.22	67.58	67.11	65.92	61.59	70.51
Total Precipitation (inches)	0.00	0.00	0.00	0.00	0.00	0.00	0.00	0.00	0.00	0.00
Tide H/L (MAG) (FT)	3.3H	3.5H	3.8H	4.0H	4.2H	4.5H	4.6H	4.2H	4.0H	3.8H
24 Hour Event		1200-1200	1200-1200				1200-1200		1200-1200	
Ave Wind Direction (Direction/Percent)	Primary Secondary	WSW/26.30 W/21.11	NNW/45.33 NW/26.99				NNE/27.68 N/14.54		N/17.31 S/15.22	
Ave Wind Speed (MPH)		8.23	8.07				7.06		6.05	
Ave Solar Radiation (Watt/m ²)		301.79	270.80				304.08		285.67	
Ave Air Temperature (F)		78.01	70.11				62.90		65.16	
Total Precipitation (inches)		0.00	0.00				0.00		0.00	
Tide H/L (MAG) (FT)		3.5/0.9	4.1/0.7				4.3/-0.2		4.0/-0.1	

APPENDIX C

PCB, COPPER AND LEAD WATER QUALITY DATA
PRESENTED GRAPHICALLY

**New Bedford Harbor Hot Spot Remedial Action
Operational Water Quality Monitoring Station 2
Total PCB Ebb vs. Flood Tide
April 1994 - September 1995**

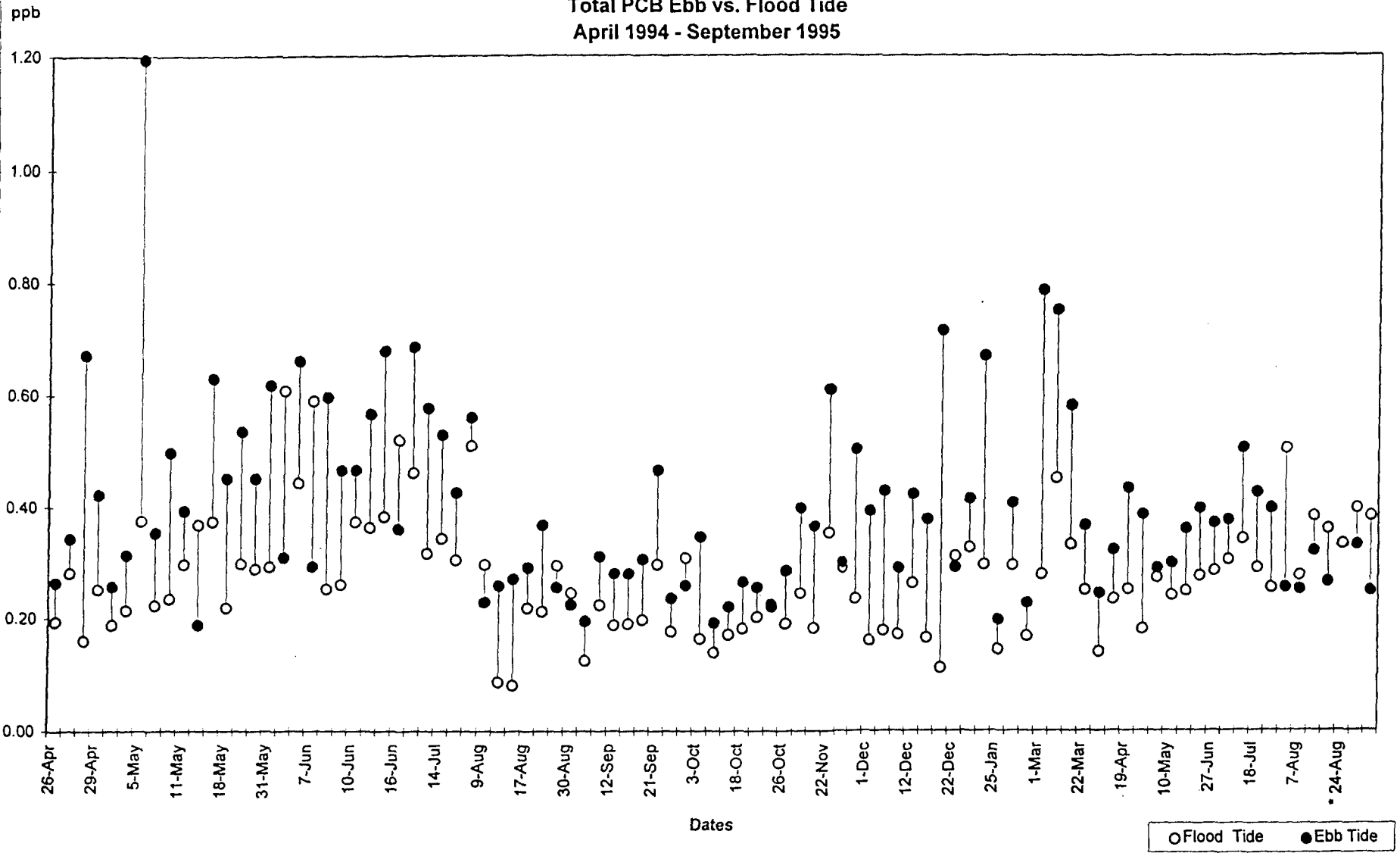

* No data for flood tide:

No dissolved data for 28-Apr-94

No particulate data for 10-Aug-94

No particulate data for 15-Aug-94

No flood samples taken on 24-Aug-95

New Bedford Hot Spot Remedial Action
 Operational Water Quality Monitoring Station 2
 Total PCBs Ebb Tide vs. Dissolved PCB Ebb Tide
 April 1994 - September 1995

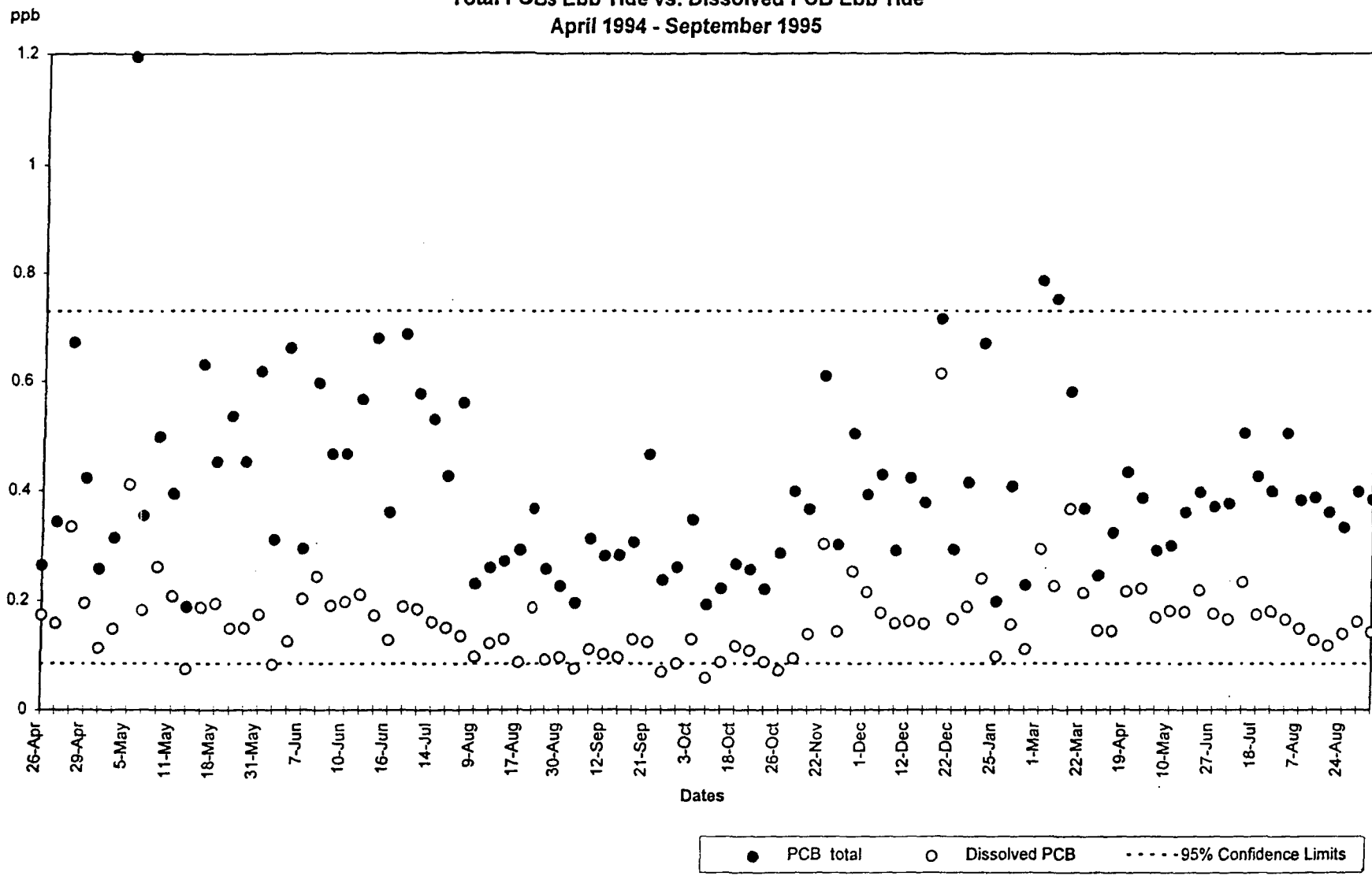

**New Bedford Hot Spot Remedial Action
Operational Water Quality Monitoring Station 2
Total PCBs Flood Tide vs. Dissolved PCB Flood Tide
April 1994 - September 1995**

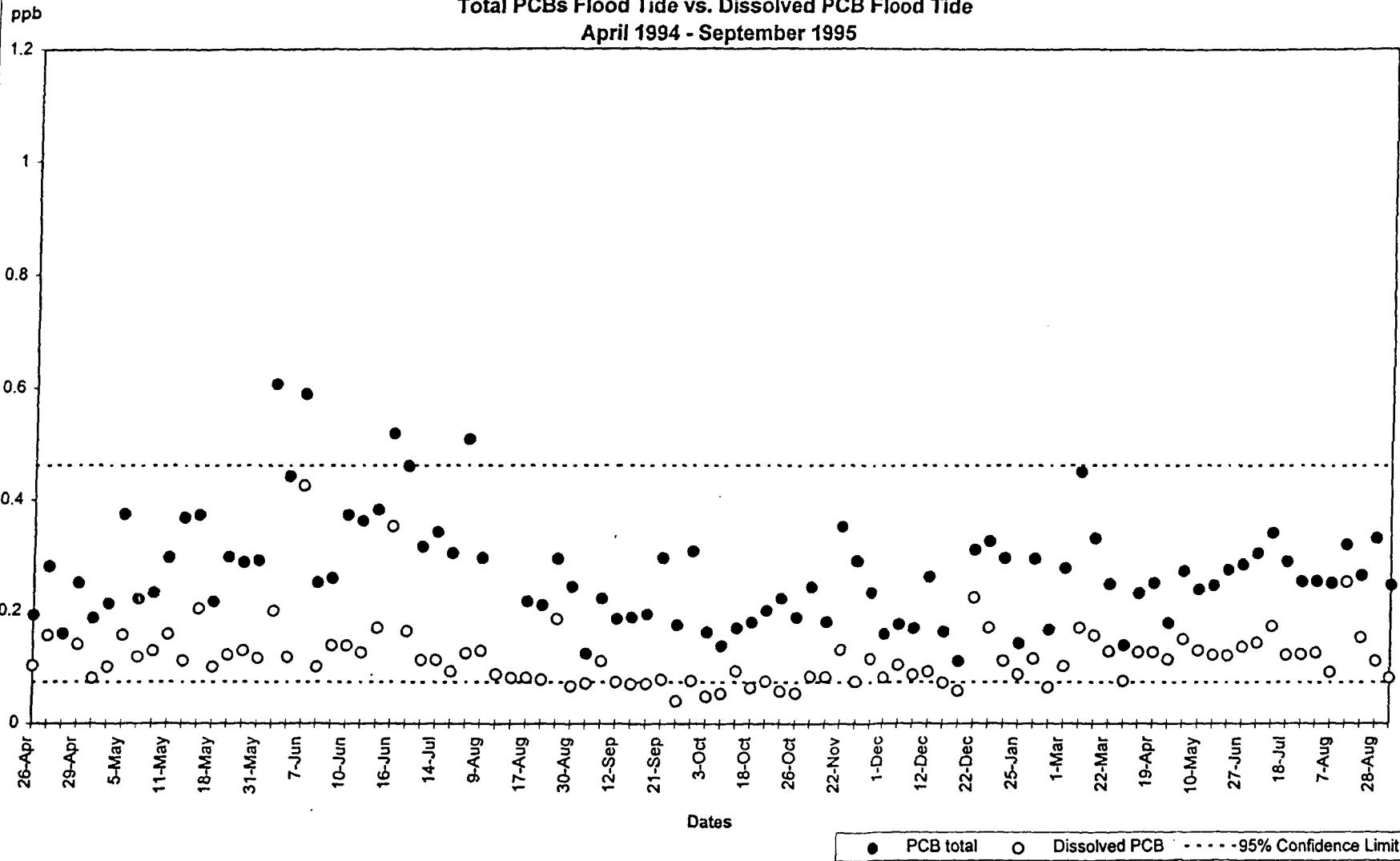

- * No dissolved data for 28-Apr-94
- * No particulate data for 10-Aug-94 and 15-Aug-94
- * Flood tide samples not taken on 24-Aug-95

**New Bedford Hot Spot Remedial Action
Operational Water Quality Monitoring Data Station 1
Total PCBs Ebb Tide vs. Dissolved PCB Ebb Tide
April 1994 - September 1995**

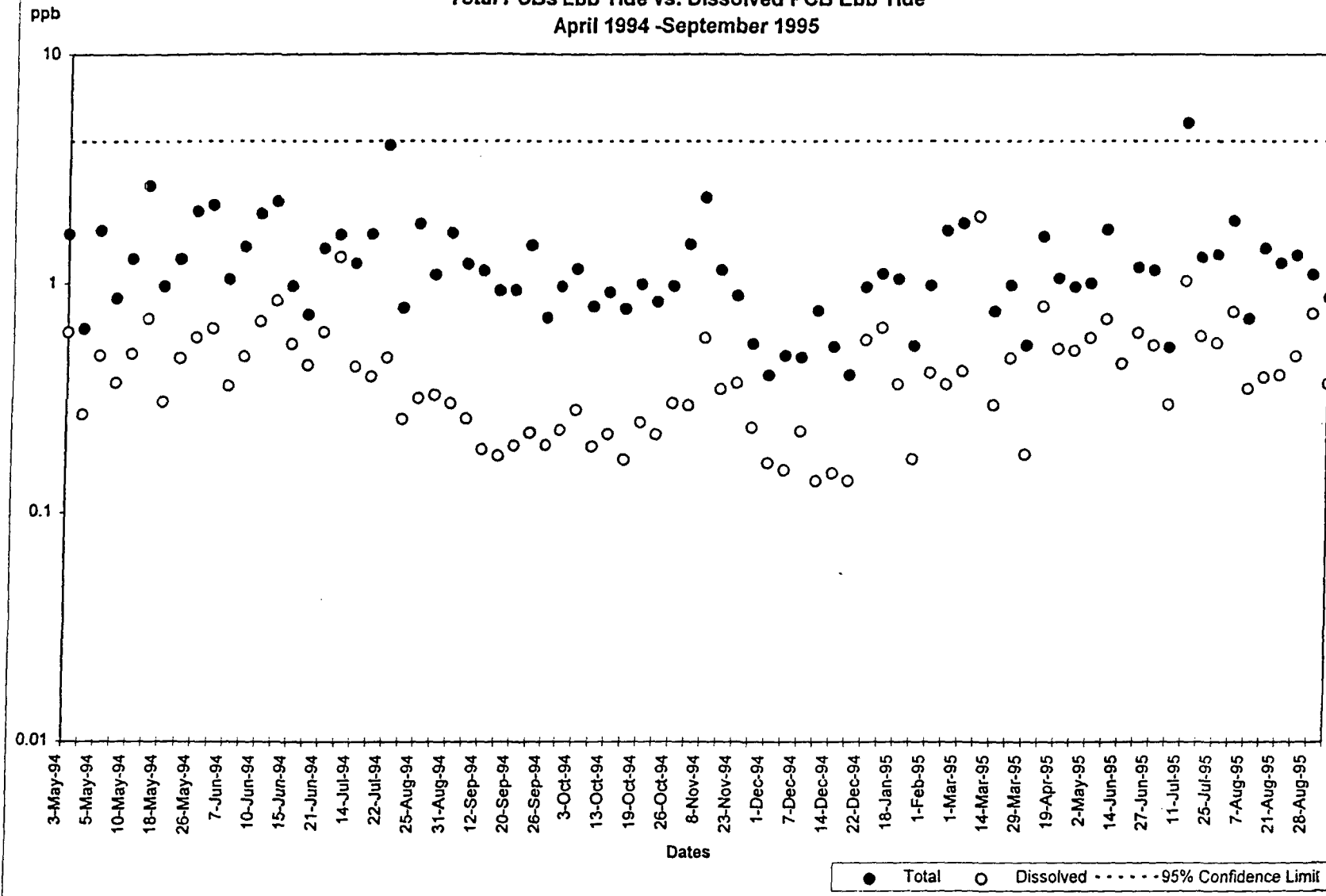

**New Bedford Hot Spot Remedial Action
Operational Water Quality Monitoring Data Station 7
Total PCBs Ebb Tide vs. Dissolved PCB Ebb Tide
April 1994 - September 1995**

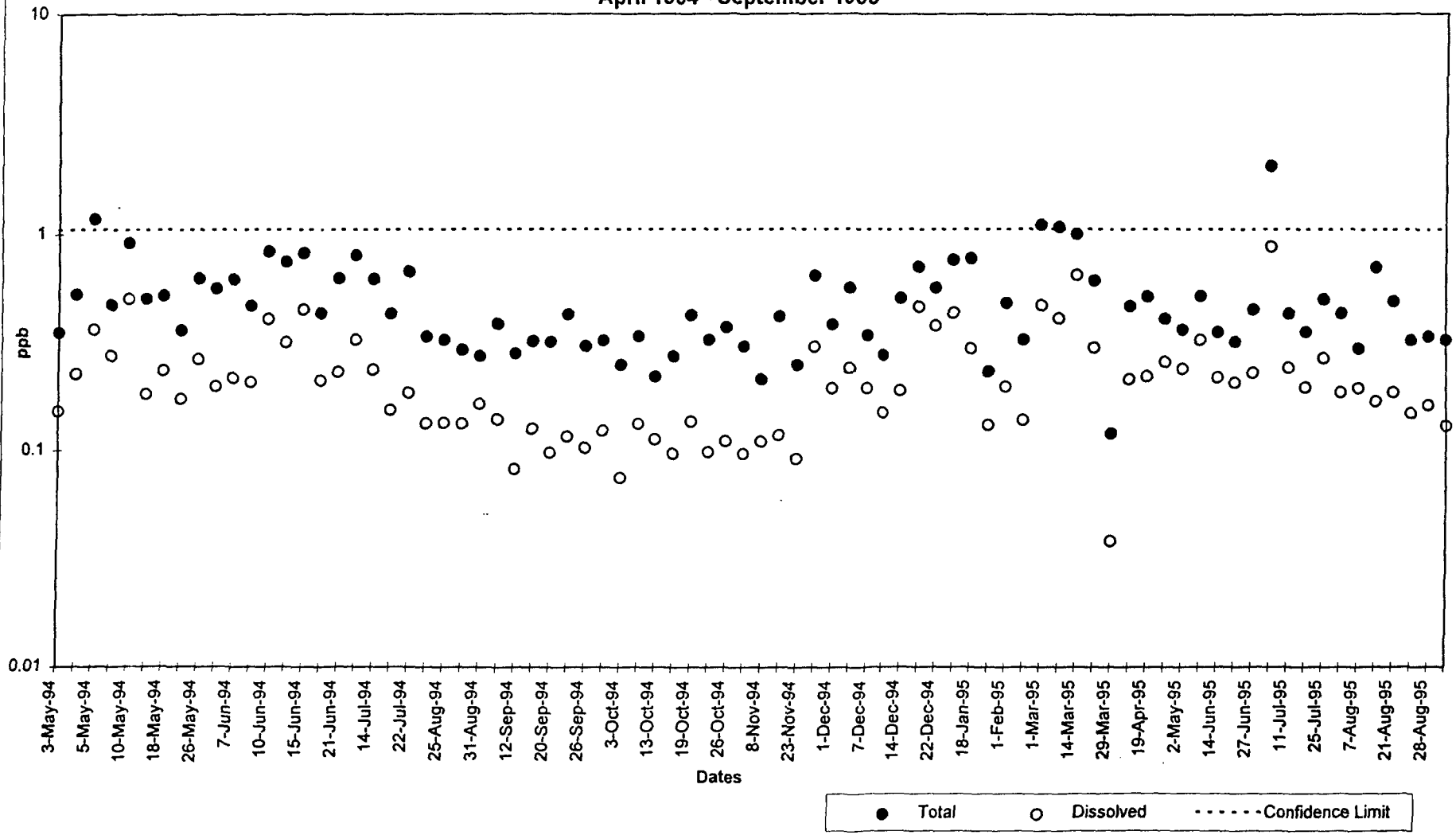

**New Bedford Hot Spot Remedial Action
Operational Water Quality Monitoring Data Station 1
Copper (Cu) Total vs. Dissolved
May 1994 - September 1995**

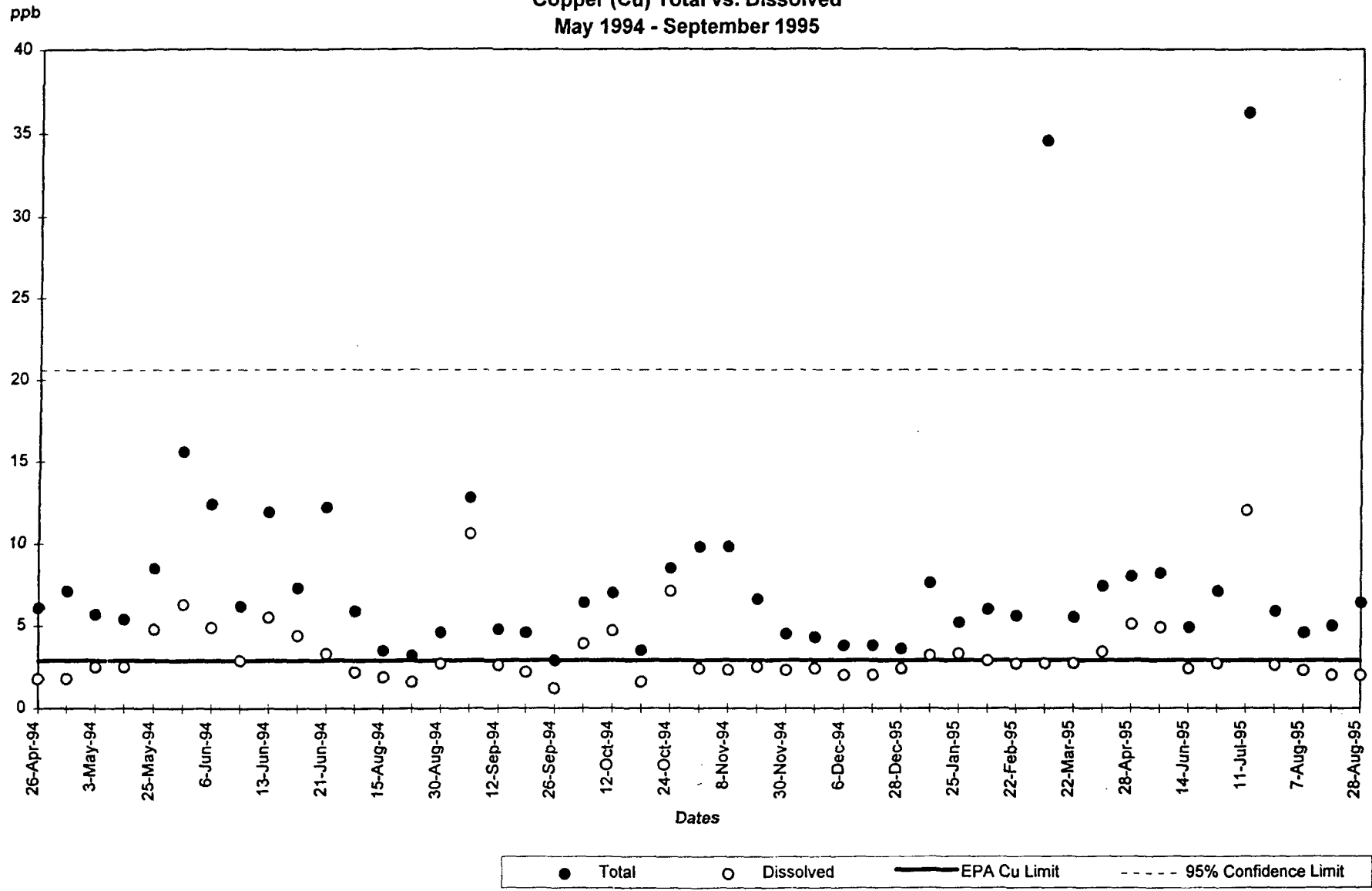

Note: EPA Cu limit 2.9 ppb

**New Bedford Hot Spot Remedial Action
Operational Water Quality Monitoring Data Station 1
Lead (Pb) Total vs. Dissolved
May 1994 - September 1995**

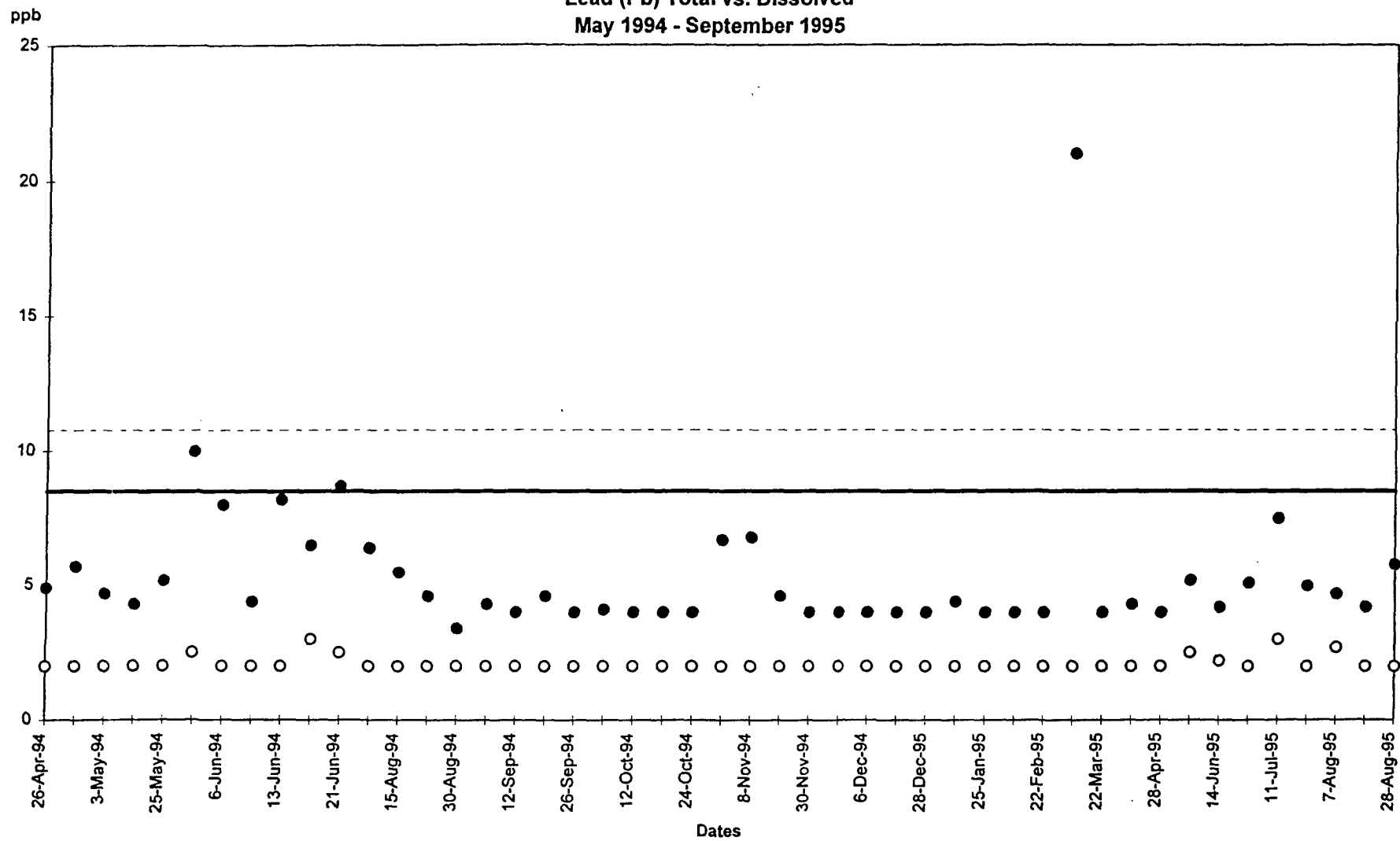

Total
 Dissolved
 EPA Pb Limit
 95% Confidence Limit

Note: EPA Pb limit 8.5 ppb

Note: When analyte was analyzed for but not detected, the detection limit (2 ppb) was reported.

**New Bedford Hot Spot Remedial Action
Operational Water Quality Monitoring Data Station 7
Copper (Cu) Total vs. Dissolved
May 1994 - September 1995**

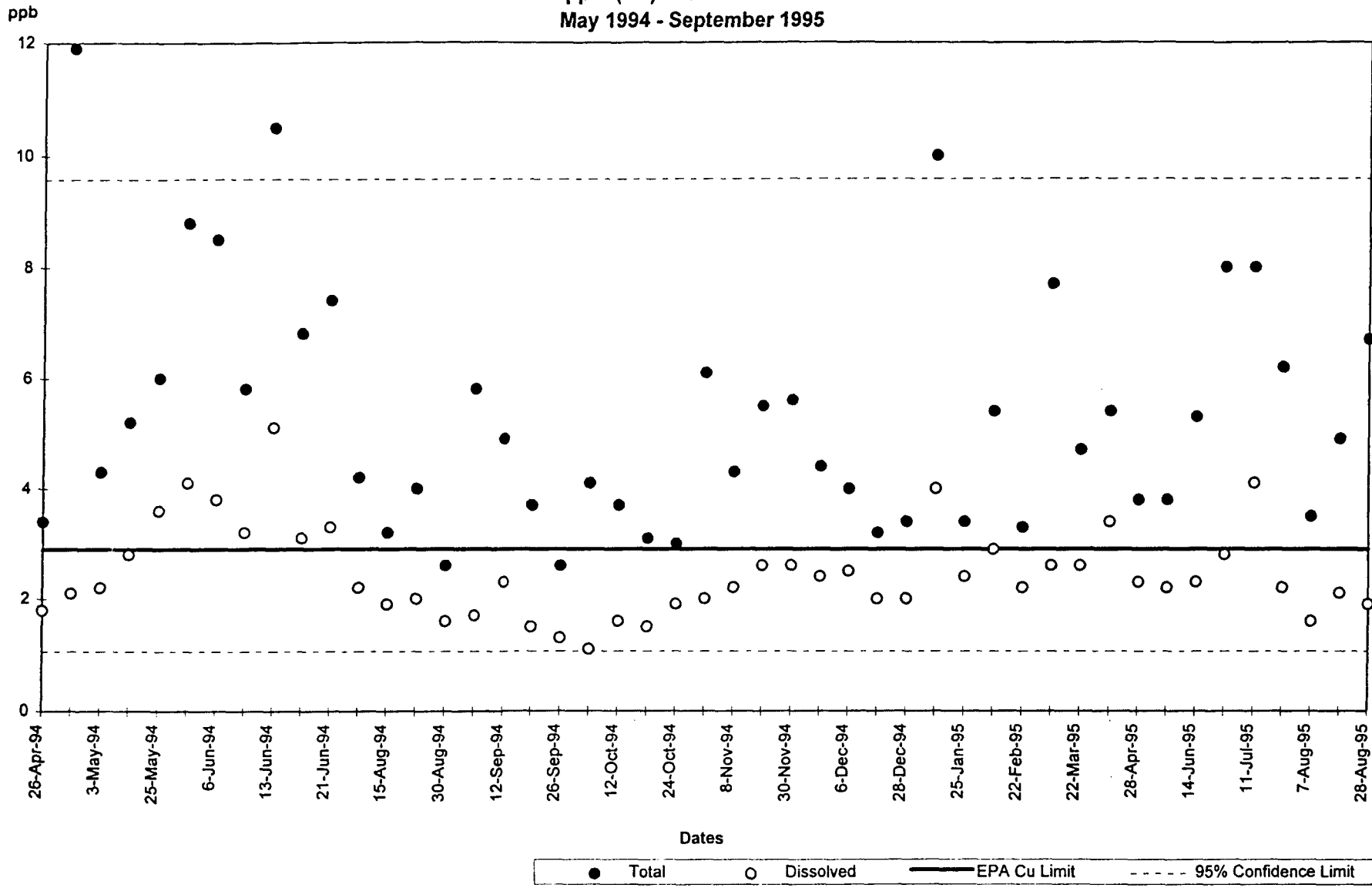

Note: EPA Cu limit 2.9 ppb

**New Bedford Hot Spot Remedial Action
Operational Water Quality Monitoring Data Station 7
Lead (Pb) Total vs. Dissolved
May 1994 - September 1995**

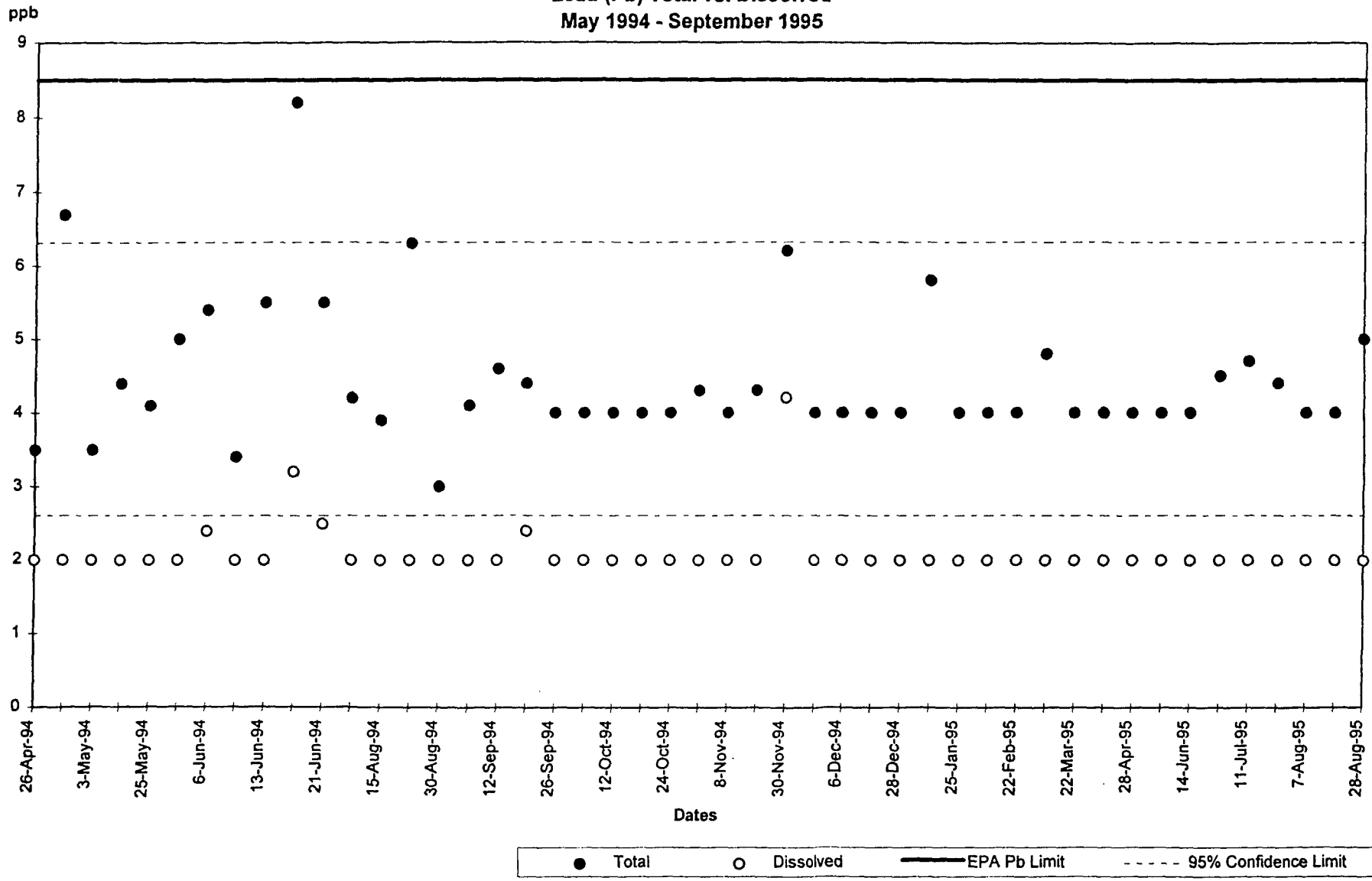

Note: EPA Pb limit 8.5 ppb

Note: When analyte was analyzed for but not detected, the detection limit (2 ppb) was reported.

**New Bedford Hot Spot Remedial Action
Operational Water Quality Monitoring Data Station 2 [Ebb]
Copper (Cu) Total vs. Dissolved
May 1994 - September 1995**

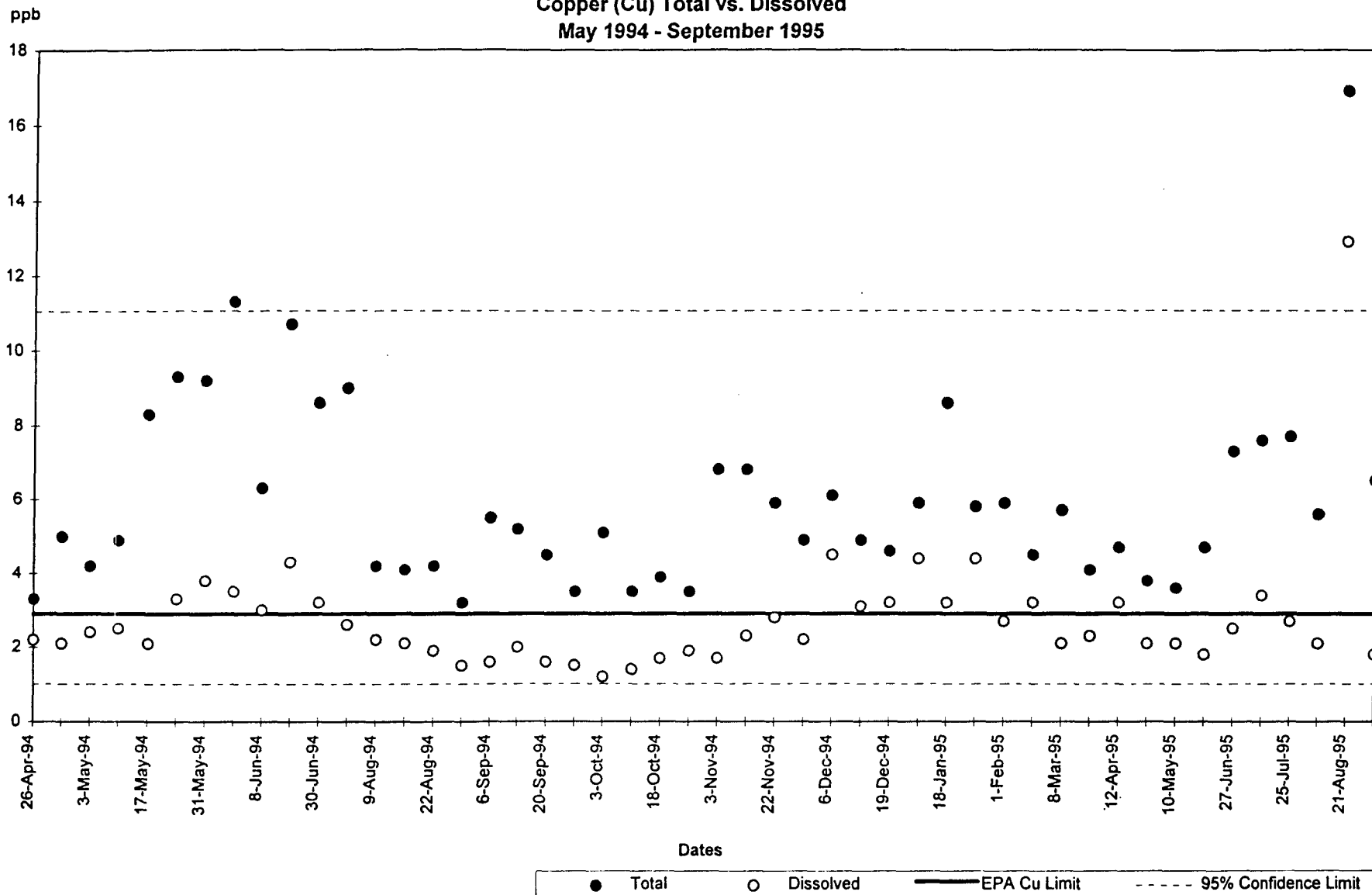

Note: EPA Cu limit 2.9 ppb

**New Bedford Hot Spot Remedial Action
Operational Water Quality Monitoring Data Station 2 [Ebb]
Lead (Pb) Total vs. Dissolved
May 1994 - September 1995**

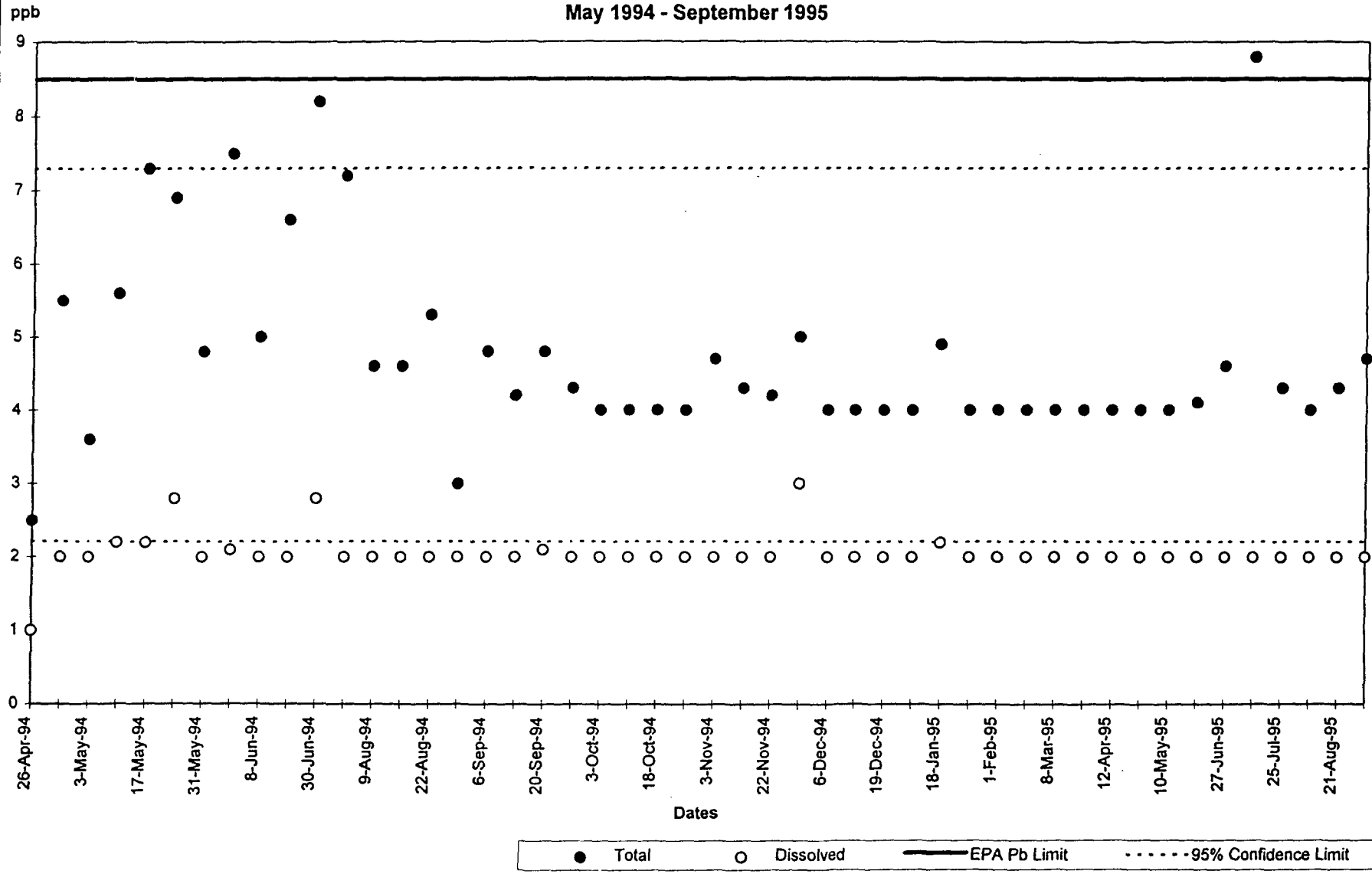

Note: EPA Pb limit 8.5 ppb

Note: When analyte was analyzed for but not detected, the detection limit (2 ppb) was reported.

**New Bedford Hot Spot Remedial Action
Operational Water Quality Monitoring Data Station 2 [Flood]
Copper (Cu) Total vs. Dissolved
May 1994 - September 1995**

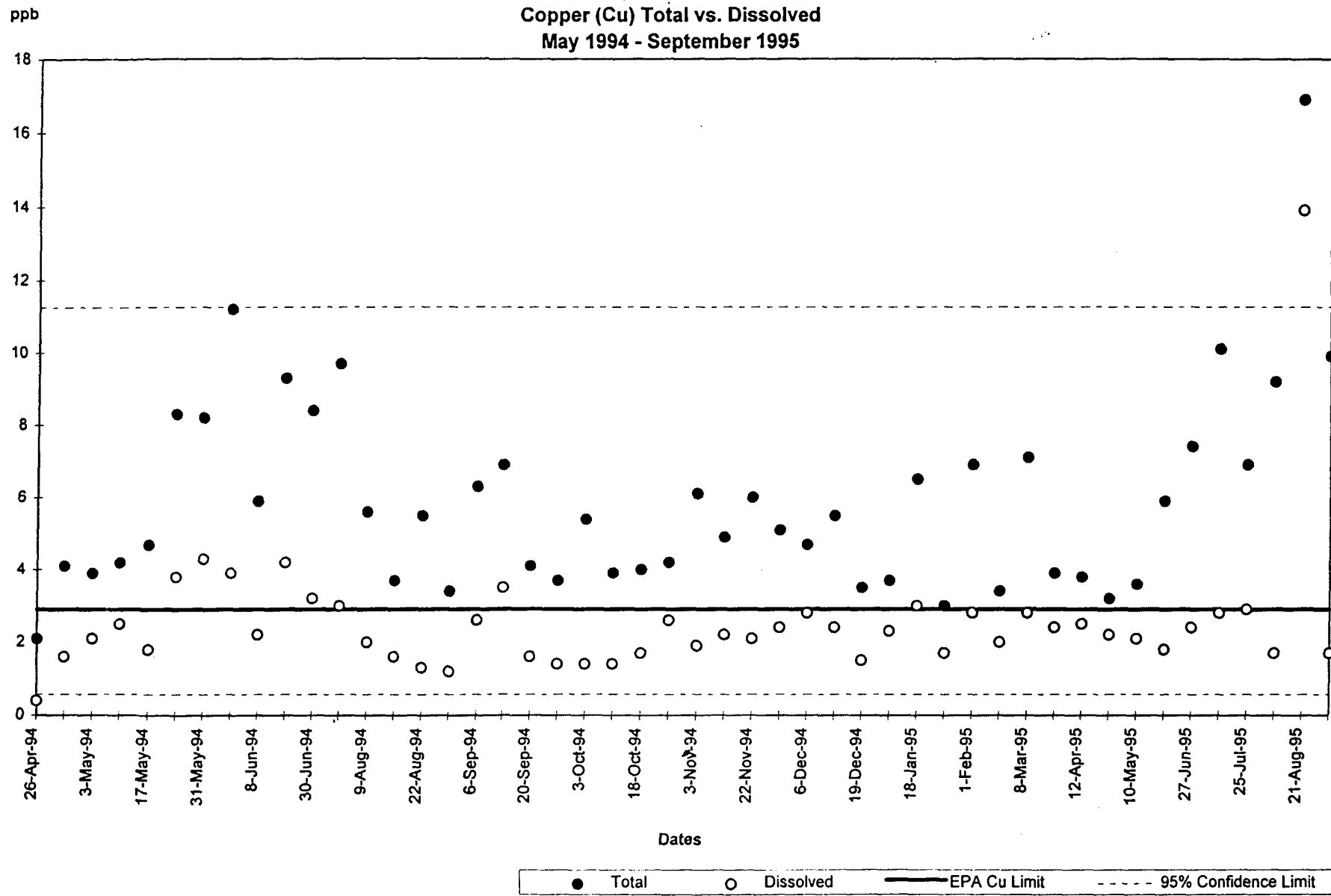

Note: EPA Cu limit 2.9 ppb

**New Bedford Hot Spot Remedial Action
Operational Water Quality Monitoring Data Station 2 [Flood]
Lead (Pb) Total vs. Dissolved
May 1994 - September 1995**

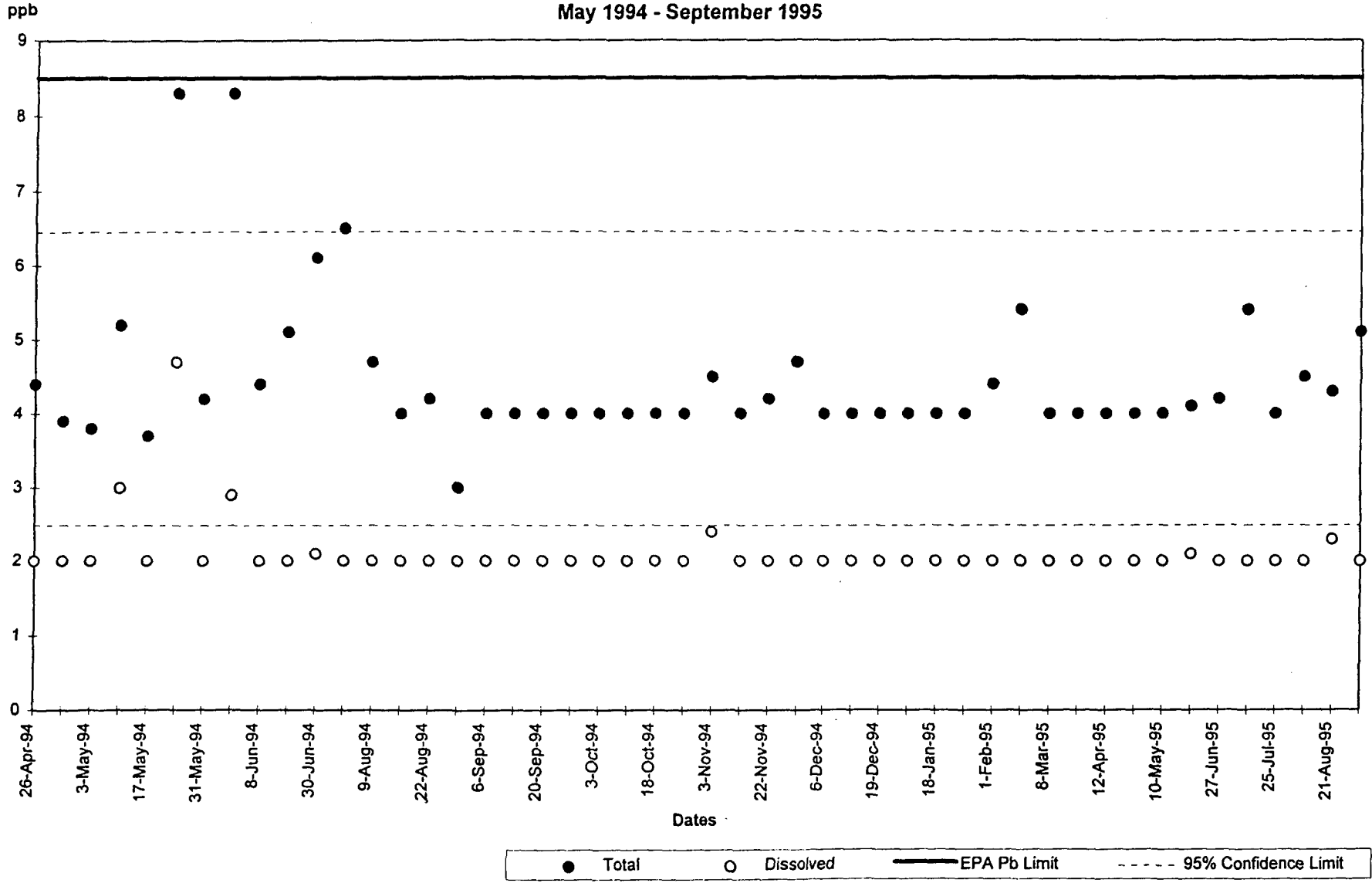

Note: EPA Pb limit 8.5 ppb

Note: When analyte was analyzed for but not detected, the detection limit (2 ppb) was reported.