

**FRANKLIN**  
engineering group, inc.

381 Riverside Drive, Suite 200  
Franklin, TN 37064  
615/591-0058 voice

**CLARIFIER WASTE TREATABILITY STUDY  
PHASE 3 REPORT  
PILOT PLANT OPERATION**

**Prepared for:**

Rhodia, Inc.  
Silver Bow  
119130 German Gulch Road  
Butte, MT 59750

**Prepared by:**

Franklin Engineering Group, Inc.  
381 Riverside Drive, Suite 200  
Franklin, TN 37064

**February 2012**

## TABLE OF CONTENTS

<b>1.0 INTRODUCTION</b>	<b>4</b>
<b>2.0 PILOT PLANT DESCRIPTION</b>	<b>5</b>
2.1 Overview	5
2.1.1 <i>Removing Material from the Clarifier</i>	5
2.1.2 <i>Loading Mud Still</i>	5
2.1.3 <i>Operating the Mud Still</i>	6
2.1.4 <i>Unloading Mud Still</i>	6
2.2 System Components	6
2.2.1 <i>Pan Still</i>	6
2.2.2 <i>Condenser</i>	6
2.2.3 <i>Recirculation system</i>	6
2.2.4 <i>Control Systems</i>	7
2.2.5 <i>Furnace</i>	7
2.3 Operations Narrative	8
<b>3.0 2011 TESTING PLAN</b>	<b>9</b>
3.1 Overview	9
3.2 Individual Tests	10
3.2.1 <i>Test Run #1</i>	10
3.2.2 <i>Test Run #2</i>	10
3.2.3 <i>Test Run #3</i>	10
3.2.4 <i>Test Run #4</i>	10
3.2.5 <i>Test Run #5</i>	10
3.2.6 <i>Test Run #6</i>	10
3.2.7 <i>Test Run #7</i>	10
3.2.8 <i>Test Run #8</i>	11
3.2.9 <i>Test Run #9</i>	11
3.2.10 <i>Test Run #10</i>	11
3.2.11 <i>Test Run #11</i>	11
3.2.12 <i>Test Run #12</i>	11
<b>4.0 TEST RUN OBSERVATIONS</b>	<b>11</b>
4.1 Test Run #1	11
4.2 Test Run #2	12
4.3 Test Run #3	13
4.4 Test Run #4	13
4.5 Test Run #5	14
4.6 Test Run #6	15
4.7 Test Run #7	15
4.8 Test Run #8	16



4.9 Test Run #9.....	16
4.10 Test Run #10.....	17
4.11 Test Run #11.....	17
4.12 Test Run #12.....	17
<b>5.0 DATA ANALYSIS .....</b>	<b>18</b>
5.1 Furnace Still Temperature .....	18
5.2 Vapor Line Temperature.....	18
5.3 Condenser Related Temperatures .....	19
5.4 Condenser and Vapor Line Pressure.....	19
5.5 Furnace Power Consumption.....	19
5.6 Test Run Time Duration .....	19
<b>6.0 CONCLUSIONS.....</b>	<b>20</b>
<b>7.0 APPENDICES .....</b>	<b>23</b>
7.1 2011 Test Plan	
7.2 Drawings	
7.3 Procedures	
7.4 Waste Plan	
7.5 Clarifier Material Summary	
7.6 Operator Log Sheets and Test Run Notes	
7.7 Pilot Recovery System Summary	
7.8 Graphs of Raw Data	
7.9 HMB Summary Sheets and Analysis Charts	
7.10 Residue Analysis Summary	
<b>8.0 PICTURES</b>	

## 1.0 INTRODUCTION

The clarifier at the former Rhodia phosphorus manufacturing facility in Silver Bow, Montana contains approximately 500,000 gallons of solidified phosphorus-rich material. It contains 8 to 9 feet of phosphorus-rich material covered by more than 2 feet of water (the water cap). This material consists of elemental phosphorus (about 20% [v/v]), water and solids including phosphate dust, coke dust, and silica dust.

In 2007, Rhodia retained Franklin Engineering Group (FEG) to perform Phase 1 of a Treatability Study for this material. Phase 1 involved the compilation of process information for several candidate processes for treatment of the phosphorus-rich solids in the clarifier. A report summarizing the findings from the Phase 1 research was submitted in October 2007. The Phase 1 report was approved by the US Environmental Protection Agency (EPA) in February 2009. A joint decision was made between Rhodia, the Montana State Department of Environmental Quality (MDEQ), and the EPA to further evaluate batch still technology similar to that developed by Albright and Wilson (A&W) for evaporation and subsequent recovery of the phosphorus. This technology was chosen because it:

- Has proven to be effective in processing similar materials
- Allows Rhodia to recover the phosphorus contained in the clarifier
- Could be evaluated with pilot-scale equipment
- Reduces total volume of waste

In 2009, Rhodia retained FEG to perform Phase 2 of the treatability study: a more thorough evaluation of the still-based phosphorus recovery process. This evaluation included reviewing available processing systems, selecting the most appropriate system for testing and pilot plant system design. The pilot plant was constructed and a series of test runs were completed during 2010. The Phase 2 report described the various options reviewed for the type of vessel (still) available to vaporize the phosphorus, describes the actual pilot plant design, and presents test results and data from the 2010 operation of the pilot plant.

In January 2011, a meeting was held in Scottsdale Arizona to discuss the following items:

- Lessons learned from the pilot plant runs completed in 2010 as well as lessons from previous sludge recovery operations.
- Modifications/improvements to the pilot plant and/or processes before the next series of runs planned for the summer of 2011.
- A test plan to demonstrate the pilot plant elements/processes most important to a successful full scale operational plant.
- Review and comment on the Phase 2 Report.

The meeting was attended by representatives from Rhodia, Kase Warbonnet, Franklin Engineering Group, Barr Engineering, and Kevin Ryan a Consultant. The final test plan consisted of 12 runs of various batch

sizes, with and without agitation, and various temperature profiles (See Appendix 7.1 – “2011 Test Plan”). After the modifications and improvements to the pilot plant were implemented, the 12 runs identified in the test plan were processed through the pilot plant during the summer of 2011. This report describes the 12 test plan runs and presents lab test results, data, and conclusions for the 12 runs.

## **2.0 PILOT PLANT DESCRIPTION**

### **2.1 Overview**

The Mud Still Pilot Plant was constructed in 2010 as a part of the Treatability Study for the 100' Clarifier. The Pilot Plant was designed to evaluate Mud Still Technology for use on material contained in the clarifier at the Silver Bow Site. The technology is based on using an electrically heated still to vaporize phosphorus contained in the clarifier material. The system consists of three functional sections: a stainless steel pan still with a separate 27 kW electric furnace to heat the sludge and vaporize the phosphorus, a stainless steel condenser to condense and recover phosphorus, and a stainless steel recirculation tank and pump to capture the overflow water from the condenser and recirculate back to the condenser. The phosphorus is condensed and collected as a separate material. The remaining residue is also collected and evaluated as a waste. The overall process is shown on the Process Flow Diagram/Heat and Material Balance (Drawing # 721-101; See Appendix 7.2 – “Drawings” for all drawings). A more detailed depiction of the process, with controls and instrumentation shown, is provided by the attached Piping & Instrumentation Diagram's (Drawing # 721-111 and 721-114).

Operation of the Mud Still Pilot Plant is a batch process with 4 distinct operations:

1. Removing material from the clarifier
2. Loading the Mud Still
3. Operating the Mud Still
4. Unloading the Mud Still and Waste Evaluation

#### *2.1.1 Removing Material from the Clarifier*

In order to use material that is fairly representative of the clarifier contents, three sample locations around the clarifier were selected. At each location, samples were obtained from 3 depths: 4' below water level, 8' below water level, and 12' below water level. Using a CAT 320 Excavator, 350-400 pounds of material was removed from the clarifier at the designated depth and placed in 55 gallon drums. Each drum was labeled and placed on the drum decontamination pad. These drums were then sampled and analyzed to determine phosphorus, water and solids content. The sampling procedure and locations are detailed in Appendix 7.3 – “Procedures”.

#### *2.1.2 Loading Mud Still*

The still is placed on the drum scale in preparation for loading. After a drum has been selected for a test, agitate the drum to insure a homogeneous mixture is used to load the still. Once the drum has been agitated, pour the contents into the still until the desired weight is reached. Place the lid on the still, tighten all bolts, and weigh the entire assembly prior to installation. Install the still and complete all piping connections. The loading procedure is detailed in Appendix 7.3 – “Procedures”.

### *2.1.3 Operating the Mud Still*

After all piping connections have been completed and operational checklists have been completed, turn the furnace on and set the temperature set point to 700°F. Maintain this still temperature until all water has been evaporated (indicated when the still temperature exceeds 250°F). At this point, raise the furnace temperature set point to 1200°F. Maintain this temperature until all white and red phosphorus has been vaporized and removed (indicated when still temperature nears furnace temperature and vapor line temperature decreases). When all phosphorus has been removed from the still, turn the furnace off. Remove all phosphorus collected in the condenser and allow the system to cool. The operating procedure is detailed in Appendix 7.3 – “Procedures”

### *2.1.4 Unloading Mud Still*

Once all equipment is cooled to ambient temperature, disconnect all piping, remove the still from the furnace and weigh the assembly. Remove the still lid and inspect for evidence of phosphorus (burning in the still). If no phosphorus is present, collect and sample for waste analysis. The Waste Plan is detailed in Appendix 7.4 – “Waste Plan”.

## **2.2 System Components**

### *2.2.1 Pan Still*

The pan still design uses a section of 24” schedule 40, stainless steel pipe with a flat plate for a bottom and a stainless steel flange at the top for attaching a lid. This is shown in Drawing # 721-420. The design capacity for the still is 3 cubic feet of clarifier material per batch. The lid has a matching flange to mate up to the bottom section and seal the still during operation. The lid is also equipped with an agitator to enhance the heat and mass transfer efficiency of the still, shown in Drawing #721-421. The still assembly is placed within the electric furnace during operation.

### *2.2.2 Condenser*

The condenser is a counter current flow, direct contact, stainless steel vessel with three water nozzles that spray downward inside the condenser. The hot gases from the still enter through a side inlet near the bottom of the condenser, rise through the falling water spray, and exit through the vent at the top of the condenser. This gas flow is enhanced by a scrubber/eductor on the scrubber vent. Water and/or phosphorus vapor is condensed by the water sprays and settles in the bottom of the condenser. The condensed phosphorus is recovered at the end of each batch from the bottom of the condenser and collected in a water filled drum. The condenser design is shown in Drawing # 721-401.

### *2.2.3 Recirculation system*

The recirculation system consists of a stainless steel recirculation tank and pump to circulate heated process water through the system. The water overflow from the condenser is collected in the tank and recirculated back into the condensing system. Any phosphorus carryover from the condenser is collected in the bottom of the recirculating tank and drained into a water filled recovery drum at the end of the test. Any water overflow

from the recirculating tank is returned to the clarifier. The recirculation tank design details are shown in Drawing # 721-402.

#### *2.2.4 Control Systems*

Key process variables are measured with field instrumentation. Instrument signals are sent to a data recorder for real-time monitoring and data recording.

There are two control loops used for controlling the system when in operation. The first control loop controls the electric furnace temperature to a setpoint entered manually by the operator through the front faceplate of the furnace controller. A thermocouple mounted on the furnace face is used by a Eurotherm controller to modulate silicon controlled rectifiers regulating the power to the heating elements of the furnace. The second control loop regulates the temperature of the recirculation water to the direct contact condenser by adjusting the amount of make-up water introduced into the recirculation line. A thermocouple mounted in the recirculation line is connected to a Red Lion controller outputting to a control valve in the make-up water supply line. The operator adjusts the temperature of the recirculation line water via the manually entered setpoint on faceplate of the Red Lion controller.

Pressure within the furnace/condenser system is controlled manually using a ball valve to adjust the flow of recirculation water to the scrubber/eductor on the top of the condenser. There are both electronic pressure transmitters and visual pressure indicators on the vapor line from the furnace to condenser, and on the top gas exit line of the condenser immediately prior to the scrubber/eductor. These instruments are used by the operator to control the pressure in the vapor line from the furnace to near zero inches of water column pressure or slightly negative. The pressure is controlled near zero to minimize the possibility of pulling oxygen into the system, or pushing phosphorus out. Either condition would likely initiate a fire.

Heated nitrogen is introduced to the furnace vapor space to act as a carrier gas for the phosphorus vapors. The nitrogen is introduced at the packing gland for the agitator (when present) and through a nozzle on the furnace lid. The nitrogen supply is from a pressurized nitrogen cylinder. The cylinder pressure is reduced using a pressure reduction valve to a level appropriate for the furnace. The flow rate of gas is regulated by two rotometers, one for each supply point to the still.

#### *2.2.5 Furnace*

The electric furnace is from Mellen, a supplier of commercial furnace products. The furnace is capable of supplying 27 kW of power input to heat the still to a maximum operating temperature of 1550°F. The furnace system is supplied complete with a Eurotherm temperature controller and high temperature cutoff.

### 2.3 Operations Narrative

The following is a description of typical steps to process a batch of sludge from the clarifier through the pilot plant.

1. Sludge is removed from the clarifier using a trackhoe and carefully loaded into sample drums. The sludge is then loaded into the still from the sample drums using a drum dumper.
2. The sludge is allowed to settle and the excess water is decanted from the surface and returned to the clarifier. A thin layer of water is left to cover the clarifier sludge to prevent burning.
3. The loaded still bottom is moved to the maintenance area/spill pan next to the clarifier.
4. The still lid with agitator is lifted and placed on top of the still bottom and the bolts are installed and torqued to specification.
5. The loaded still assembly is placed on the platform scale to record the beginning weight for the batch.
6. The loaded still is then placed into the furnace frame and secured with bolts.
7. Process connections are made between the still, condenser system, and the nitrogen purge/vent piping.
8. The condensing and recirculation system heat tracing and tank heaters are energized to bring and maintain the system within an acceptable temperature range (120-140°F).
9. The thermocouples on the furnace are re-installed and connected to the data recorder input wiring.
10. The furnace is energized and heat applied in a controlled fashion to bring the temperature in the still up to the set point temperatures.
11. During the heat up, the pressures and temperatures of the condensing and recirculation system are monitored and adjusted to stay within process limits.
12. The still vapor line temperature is monitored as a basis for predicting the start and end of the water and phosphorus vapor phases. Once the vapor line temperature is judged to indicate the phosphorus has been vaporized, the furnace is turned off and the system allowed to cool overnight.
13. The connections between the still, condenser system, and nitrogen/vent piping are removed.
14. The still is lifted from the furnace frame, weighed to determine batch final weight, and moved to the maintenance area/spill pan next to the clarifier.
15. The bolts are removed and the lid is removed. (If any phosphorus remains, water is added to suppress fires/smoke and the still is cleaned.)
16. The phosphorus that was vaporized and then condensed in the condenser is drained into a drum through a ball valve on the bottom of the condenser. The drum is located inside an oversized drum of heated water.
17. The product drum is then removed and weighed to determine how much phosphorus was distilled.
18. Any phosphorus collected in the recirculation tank is also drained into a drum and weighed.
19. The system is then cleaned with hot water flushes to remove any residual phosphorus and prepare for the next batch.

## 3.0 2011 TESTING PLAN

### 3.1 Overview

Results from the Clarifier Material Sampling program discussed in Section 2 and summarized in the Clarifier Material Summary (Appendix 7.5 – “Clarifier Material Summary”) narrowed the testing focus to the following factors:

- The quantity of clarifier material loaded in the still.
  - Operating information from Mud Still tests performed at other sites indicated there was a run time relationship between the depth of material charged and the heat transfer surface area of the still. A linear correlation of previous data suggested the optimum size charge for this still was approximately 222 pounds. Charges above that resulted in excessively long run times especially at the end of the run to distill the red phosphorus. Batch sizes of 175 pounds, 250 pounds and 350 pounds were selected to analyze this relationship.
- Use of the internal agitator.
  - Information collected during tests using the agitator would be analyzed for run time differences, dust carryover to the recovered phosphorus and the correlation between end of the test temperatures.
- Repeatable results.
  - Determine if test parameters are consistent between similar tests of similar charge weights and P4/solids/water ratios. Determine if the temperature profiles are consistent during each phase of the test.
- Reliable end of test determination.
  - Confirm that the vapor line ‘sniffer’ valve test is a reliable method of determining the end of a run.
  - Confirm that Still Temperature and Vapor Line Temperature can be used to help determine the end of a run.
- Operational and maintenance considerations.
  - Determine if improvements are needed in design, materials of construction or operability.
- Residue analysis.
  - Collect residue samples and information from each test to perform TCLP analysis, Method 1030 Ignitability testing, and density and temperature analysis.

In order to evaluate still operation, the clarifier material has been divided into two groups by P4 and residue content:

- Group A (drums 1,5,6,9,11 and 12)

This material has P4/solids ratios of 54.4% - 60.3%. They range from a low of 24.7% P4 to a high of 31.8% P4. The residue ranges from 20.3% to 25.6%. On average, Group A samples have analyses of 28.8% P4, 49.3% water and 21.8% residue and a P4/solids ratio of 56.9%.

- Group B (drums 2,3,4,7,8 and 10)

This material has P4/solids ratios of 60.9% to 70.7%. They are somewhat higher in P4 content and range from 31.9% to 41.5% P4. The residue is on average only 1.5% lower than Group A material and ranges from 17.2% to 23.3%. Water is lower in group B averaging 44.8% and ranging from 39.7% to 48.1%. On average, Group B samples have analyses of 35.4% P4, 44.8% water, 20.4% residue, and a P4/solids ratio of 63.9%.

## **3.2 Individual Tests**

### *3.2.1 Test Run #1*

Drum 12 was used in this test. 179 pounds of material were used in this batch, which was agitated. This test was selected as a baseline test using low P4 content material to confirm equipment operability. Improvements to the vapor line, furnace heating capabilities and heat tracing were evaluated during this test.

### *3.2.2 Test Run #2*

Drum 5 was used for this test. 175 pounds of material, similar to the clarifier material in drum 12, were used in this batch, which was not agitated. This test will be duplicated in Test 3 with agitation.

### *3.2.3 Test Run #3*

The remaining clarifier material from Drum 5 was used in Test 3 to compare agitated and non-agitated runs. 176 pound of material were used in this batch, which was agitated.

### *3.2.4 Test Run #4*

Drum 7 was used for this test. 248 pounds of material, having the highest P4 content and lowest percentage of residue, were used in this batch, which was agitated. From a P4 content and solids perspective, this material is opposite of Tests 1, 2 and 3. The remaining material in Drum 7 was retained and used in a duplicate test without an agitator (Test 9).

### *3.2.5 Test Run #5*

Drum 8 was used for this test. 347 pounds of material, with average water content and below average solids content, were used for this batch, which was agitated. This is the first test of a large batch size.

### *3.2.6 Test Run #6*

Drum 10 was used for this test. 348 pounds of material were used in this batch, which is a duplicate of Test 5 without an agitator. Drum 10 is the is near the average in P4 content, water and solids of all clarifier material sampled.

### *3.2.7 Test Run #7*

Drum 7 was used for this test. 253 pounds of material were used in this batch, which was a duplicate of Test 4 utilizing the agitator.



### *3.2.8 Test Run #8*

Drum 11 was used for this batch. 362 pounds of material were used in this batch, which was the second largest batch and it was agitated. This batch had the lowest P4 and second highest water content. Data compared with Tests 5 and 6.

### *3.2.9 Test Run #9*

Drum 1 was used for this test. 247 pounds of material were used in this batch, which was not agitated.

### *3.2.10 Test Run #10*

Drum 9 was used in this test. 248 pounds of material were used in this batch, which was not agitated. This material had below average P4 content and average water and residue content.

### *3.2.11 Test Run #11*

Drum 3 was used for this test. 253 pounds of material were used in this batch, which was not agitated. This test was designed as a comparison test to Test 10. The material had the second highest P4 content, lowest water content and residue content just above average. The material had a P4/Residue ratio 61.4%.

### *3.2.12 Test Run #12*

Drum 2 was used for this test. 249 pounds of material were used in this batch, which was agitated. This material was selected as a comparison test to Test 11. Slightly lower P4 and residue than Test 11 with a P4/Residue ratio of 61.9%.

## **4.0 TEST RUN OBSERVATIONS**

During each test, operators tracked all operating parameters of the system and recorded them on Operator Log Sheets. Comprehensive notes were compiled to record any anomalies or upset conditions. The full set of Operator Log Sheets and Test Run Notes are attached in Appendix 7.6 – “Operator Log Sheets and Test Plan Notes”. A summary of data collected for Runs #1 thru #12 is attached as Appendix 7.7 – “Pilot Recovery System Summary”.

### **4.1 Test Run #1**

A batch of 178.8 pounds of clarifier material was loaded in the still, with a lab analysis of 55% water and 60% P4 to solids ratio. Test 1 used the internal still agitator. Water overflow started within the first hour of run time at a still temperature of approximately 190°F. Water levels in the condenser and overflow tank proved to be within the normal operating range. Condenser overflow water temperatures dropped to 100°F (condenser outlet around 70°F.). A vapor line test was completed at 20:25 with significant flame and smoke. At 20:50 there was no smoke or flame from the vapor line and the vapor line temperature was consistently dropping. After turning the furnace off, pressure in the still raised to 80” w.c., therefore the furnace was vented using the PRV. The PRV was left slightly open overnight. Still temperature was 412°F at 06:30 the next morning. The condenser water at the end of the test had a pH of 4. There was a small amount of P4 collected in the recycle tank.

There was a small amount of condensed phosphorus and acid that burned when the still lid was removed. The phosphorus was concentrated at the still to lid gasket interface. The residue was light gray in color and light weight, similar to fly ash. There was an orange band of residue 6-8" around the still circumference just below the lid to gasket interface. This layer of material had streaks of yellow at several locations within the orange material. After the residue had cooled to about 150°F, a sample of residue was taken and placed in a small pan. A thermocouple was inserted into the sample and the temperature was observed to rise to nearly 450°F. There was an unexplained exothermic reaction taking place in the sample container. The sample did not ignite, suggesting that the phenomenon causing the rise in temperature of the residue does not appear to be phosphorus initiated.

The total amounts of phosphorus and residue collected for this test are actual weights. The total amount of water collected is based on the difference between the initial weight and the final weights. There were 51.8 pounds of phosphorus collected in this test. Lab analysis indicated there should have been 48.3 pounds of phosphorus in the charge. The amount of water and residue in the batch were similar to the predicted amount, based on lab analysis of the batch.

#### **4.2 Test Run #2**

A batch of 175.4 pounds of clarifier material was loaded in the still, which was not agitated. Test 2 was intended to be a comparable duplication of Test 1 without agitation. The final quantity of residue was much higher than lab analysis indicated with a corresponding reduction in the quantity of water removed. Total run time was similar but the water and yellow P4 phases were significantly shorter. Completion of the test or RAP (red amorphous phosphorus) phase was four times as long as Test 1. Recycle water temperatures were elevated (150°F) to start the run and were difficult to control through the water boil phase. High condenser spray temperatures may have contributed to the additional quantity of P4 found in the water recycle tank. For subsequent tests, recycle water temperatures will start at 100-110°F to compensate for heat loading from the water boil phase. Significantly higher Still temperatures were required to complete the test: 1190°F vs. 860°F for Test 1. Vapor line temperatures at the end of test were 273°F for Test 2 and 370°F for Test 1. Recovered P4 quality for both tests was good with little dirt carry over. Phosphine levels exceeded 1000 ppm at the recycle tank vent within an hour of startup. Water overflow was noted 45 minutes after startup with a still temperature of 195°F.

The amount of burning and phosphorus and acid around the still lid to gasket interface was much less than Test 1. This could be related to agitation of the light weight residue. A light layer of P4 contaminated material around the upper perimeter generated a small amount of smoke and flames. The residue was crusted, approximately 6-8 inches deep. There was no detectable phosphine. There were large nodules attached to the still shell in the heated zone with white and red deposits in the unheated upper portion of the still. The residue was field tested for ignitability and reactivity with negative results. Samples were taken for TCLP analysis.

There were 44.8 pounds of phosphorus recovered. Lab analysis indicated 48.9 pounds should have been contained in the batch. There were 65.4 pounds of residue collected, with lab analysis predicting 38.8 pounds. This points to the highly variable nature of the material in the clarifier.

### **4.3 Test Run #3**

Test 3 was intended to mirror Test 2 with the addition of the still agitator. Drum 5 clarifier material was used for both tests 2 and 3. 176.4 pounds of clarifier material was loaded in the still. Test 3 seemed to be very efficient, with a run time was 7 hours vs. 9 hours for Test 2. The total kWh per pound charged was slightly less for Test 3 than Test 2 (0.53 vs. 0.58) and much less than Test 1 (0.53 vs. 0.71). Phosphorus recovered was granular and appeared to be contaminated with dirt. Phosphine readings were much lower throughout the test, exceeding 1000 ppm only once at the recycle tank vent. Overflow water to the clarifier began at approximately 40 minutes after startup, with a still temperature of 190°F.

Phosphorus and acid was again evident around the still lid to gasket interface. For reference, this location is the weld joint attaching the still vessel to the mounting plate. A beveled joint is created providing a cavity for accumulation of P4 contaminated material. Additionally, the upper section of the still is not externally heated for the 2011 tests creating a 'cold' joint for condensing phosphorus and acid. The acid ring for Test 3 was darker than previous tests, indicating more contamination. No flame and only moderate smoke was observed when opening the still. Part of the P2O5 smoke originated from phosphorus in the vapor line outlet duct. Residue remaining in the still was ambient temperature with no detectable phosphine. Field ignitability and reactivity tests were negative. Samples were taken for TCLP testing.

For this test, the water that was boiled from the batch was collected and weighed. However, there are small inaccuracies in this method, since all water could not be collected. Based on this method, lab analysis predicted there would be 49.2 pounds of phosphorus and there were 53.6 pounds collected. Lab analysis predicted 88.2 pounds of water and there were 69 pounds of water collected.

### **4.4 Test Run #4**

There were 248 pounds of material loaded into the still for test 4, which was agitated. During the water boil phase, temperatures were difficult to control. Almost one hundred gallons of makeup water were added to the recycle tank to control the temperatures. Several vapor valve tests were conducted to determine the end point of the run. In hindsight, the run probably needed to continue 30-60 minutes longer with maybe a 50-100°F increase in temperature.

There were phosphine concentrations of 2.09 ppm when the still was opened. The residue had an odor similar to sulfur. There were traces of a yellow substance on the sidewalls and in the residue. The yellow substance would not burn or smoke. When stirred the residue temperature elevated from ambient (48°F) to almost 90°F. 4 hours later the residue temperature is slightly elevated at 77°F. The residue material was light and fluffy with a density of 35 lb/ft<sup>3</sup>. The residue from Test 4 was retained in a drum. Samples were taken for TCLP analysis.

A significant quantity of dust was carried over from the still to the condenser. Samples from the P4 collection drum also showed a significant dirt layer sitting on top of and attached to the P4. The recycle water drum contained a small quantity of fine granular material more orange in color. No P4 was detected in the recycle water drum.

The total amount of phosphorus collected was 93.7 pounds, with the lab analysis predicting 102.9 pounds.

#### **4.5 Test Run #5**

There were 346.8 pounds of material loaded in the still for Test 5, which was agitated. Shortly after the start of Test 5, it became impossible to control the condenser and furnace pressures. Since the condenser outlet temperatures were low, the initial conclusion was that the educator was frozen. Attempts to thaw the educator with hot water were unsuccessful. It was then decided to control the system pressure utilizing additional condenser sprays while installing a blank in the condenser outlet to remove the educator. During this process, it was determined the educator was plugged with small round particles of clear to white phosphorus 1/16" or less in diameter. Also at this time a small hole was observed in the top of the educator. During disassembly of the educator, the bottom of the 1-1/2" to 1/2" transition bushing was found to be filled with solids, mostly small particles of brown phosphorus contaminated material. In an attempt to complete repairs before completion of the water boil phase, the hole in the educator was stuffed with pig putty until there was no vapor trail. The pressure system continued to be difficult to control. Manual adjustment of the condenser spray valves was the most successful method of controlling pressure. Temperatures were maintained by adding fresh water through the bypass valve. Collecting water for a water balance was problematic due to the volume of water added to the recycle loop. Approximately 400 gallons of makeup water was added to the system. During the repairs, the N2 cylinder was emptied and N2 flow was stopped. With no flow, both N2 heaters failed. The test was completed with cold nitrogen.

Opening the still after the run was complicated because the agitator was stuck to the pivot in the still bottom. After removing the packing, the lid was removed with no fire or smoke. A material of light yellow color covered the inside of the Still lid. That material was later washed out with cold water from a water hose. The residue was light and fluffy with some traces of yellow. The residue was removed from the still by vacuuming. After removing the residue, the agitator was extracted with little effort.

Very little acid or P4 was found in the system during post-test cleaning. The P4 produced during Test 5 had a dirt layer on top of the P4. This may have been carry over during the pressure excursions or with the N2 sweep gas at the end of the run. Reducing the agitator RPM at the end of the run might reduce carryover.

Phosphorus collected during the test was 142.6 pounds. Lab analysis predicted 118.6 pounds would be in this batch.

#### **4.6 Test Run #6**

There were 347.7 pounds of material loaded into the still for Test 6, which was not agitated. A new eductor, slightly different than the original design, was installed prior to this test. The new eductor caused operating parameters to be different than in previous tests. Overall system pressures are higher on the vapor line and lower on the eductor. The times required to reach milestone temperatures were considerably longer than expected without agitation, even though water overflow during the water boil phase was observed at 12:20. At approximately 18:30, the vent stack was producing a blue/green flame and P<sub>2</sub>O<sub>5</sub> plume. This event continued off and on until 06:00 the next morning. Corresponding to the vent emissions, a self-igniting flame was observed at the vapor valve when tested.

Furnace and still temperatures exhibited characteristics of previous Tests. Around 20:00 there was reason to believe the RAP phase had begun so the P<sub>4</sub> was drained from the condenser and preparations were made for shutting down in 2-4 hours. Still temperatures climbed to 1211°F at 22:30 and remained there within 0.5°F for over 9 hours. The furnace temperature was incrementally raised over this time frame to 1500°F. A vapor valve test at 06:30 still produced a small flame and P<sub>2</sub>O<sub>5</sub> plume. Another vapor valve test was performed at 07:00 with no flame or plume. The furnace was shut off at 07:30.

Some smoke and flame was observed when opening the still. A small quantity of phosphorus and acid had collected at the still to lid gasket interface. The walls of the still above the residue were bright yellow with a ½"-1" layer of material attached. When disturbed, the material on the wall did not burn. Residue in the bottom of the still had a yellow tint and was crusted. This residue removed in large chunks.

The P<sub>4</sub> produced was of good quality. Due to the depth of P<sub>4</sub> in the product drum, it was difficult to break into chunks. Total phosphorus collected was 102.9 pounds, with lab analysis predicting 114.7 pounds.

#### **4.7 Test Run #7**

There were 253.1 pounds of material from Drum 7 loaded into still, which was agitated. Drum 7 was the highest P<sub>4</sub> content sample taken from the clarifier (41.5%), with an almost equal amount of water. Test 4 produced P<sub>4</sub> with a significant dirt layer on top. Test 7 was designed to determine if the dirt carry over to the product drum could be reduced if the high water temperatures experienced on Test 4 were kept in a lower operating range. Repeatability of material balance and P<sub>4</sub> production results were also important.

When the still was opened, phosphine concentration was 2.5 ppm. There were traces of yellow coloring in the residue. No distinctive odor was detected. Field tests on the residue were non-reactive and not ignitable. The still lid showed only trace amounts of P<sub>4</sub> in the outlet nozzle. There was once again phosphorus and acid around the inside of the still to lid gasket joint. Due to residue contamination from this phosphorus and acid, the residue from Test 7 was returned to the clarifier.

The total amount of phosphorus collected was 112.2 pounds. Lab analysis predicted 105 pounds of phosphorus were contained in this batch.

#### **4.8 Test Run #8**

There was 362 pounds of material loaded into the still for Test 8, which was agitated. Sample Drum 11 was selected for this test because the analysis was high water (55%) and low P4 (20.3%). The water boil phase for this test lasted over 6.5 hours. Test 8 was unique from several perspectives. Most significant was the P2O5 plume generated from the recycle vent stack within 30 minutes of startup. The plume was dense at times and was visible across the clarifier (>100 feet). Furnace temperature ramp rate was the standard 700°F until the end of the water boil phase. The still temperature recorded was 93°F. Further evidence of early P4 generation was demonstrated at 10:00 when the water recycle pump discharge pressure dropped from 35 psi to 18 psi due to a plugged strainer. We continued to run the test while the strainer was cleaned. The material removed was pure P4 as expected. The recycle tank was drained several times during the test anticipating a large carryover of P4. A decision was made to terminate the run after 18 hours, although there was a slight vapor trail at the vapor valve. The vapor trail did not self ignite but was clearly visible. Still temperatures were approaching 900°F and the Vapor Line temperatures were declining (271°F). Previous tests were terminated at temperatures from 950°F to >1200°F. Previous large weight charges of 350 pound were completed at 1150°F or higher.

When the still was opened, there was a manageable amount of fire and smoke. High levels of phosphine were detected. The residue was contaminated with phosphorus and was returned to the clarifier. Based on the levels of phosphorus in the still, the test should have continued for about 2 additional hours.

The total amount of phosphorus collected was 108.6 pounds. Lab analysis predicted 89.4 pounds.

#### **4.9 Test Run #9**

There were 247 pounds of material loaded into the still for test 9, which was not agitated. Water overflow started within 15 minutes of startup. During the water boil phase, within two hours of startup, a P2O5 plume began to drift from the vent stack, carrying at times up to 100 feet. The nitrogen supply was reduced from 1.5 cfm to 0.5 cfm and a second condenser spray was partially opened which reduced the plume to +/- 10 feet. At the end of the water phase the condenser and recycle water tank were sampled for dust carryover. There was a small quantity of fine red and yellow color material in the water sampled that appeared to be P4. Condenser water pH was 3 and the recycle tank water pH was 5. Approximately 150 gallons of makeup water had been added prior to the samples. The vapor valve was checked for P2O5 about 11 hours into the Test (18:00) with self-ignition until 19:30. Light P2O5 smoke continued until 20:30 when a self-igniting blue/green flame about 2" long appeared while sampling the vapor valve. There was a slight wisp of P2O5 with the blue/green flame and at 21:00 it was decided to terminate the test.

When the still was opened there was very little smoke and no flames. Temperature of the residue was 147°F. There was consistent yellow coloring in the residue and on the still walls. No phosphorus or acid was found around the still to lid interface. The residue did not ignite when exposed to flame and was not reactive when mixed with water. Phosphine readings were zero but the strong smell similar to H2S (but still different) was evident.

The total amount of phosphorus collected was 55.9 pounds. Lab analysis predicted 81.8 pound of phosphorus.

#### **4.10 Test Run #10**

There were 248 pounds of material loaded into the still for Test 10, which was not agitated. A P<sub>2</sub>O<sub>5</sub> trail from the vent stack began within 15 minutes of startup. 60 SCFH of nitrogen was added to the top of the recycle tank to reduce the emissions. Tested various volumes of cold N<sub>2</sub> in the recycle tank to reduce the P<sub>2</sub>O<sub>5</sub> plume. 30 SCFH kept the vapor trail at about 3 feet. Phosphine concentrations were greater than 1000 ppm at the recycle tank vent stack. A second condenser spray was partially opened to help control system pressure.

When the still was opened there was very little smoke and no flames. Temperature of the residue was 220°F when the still was removed from the furnace that morning. There was very little yellow coloring in the residue or on the still walls. No phosphorus or acid was found around the still to lid interface. The residue did not ignite when exposed to flame and was not reactive when mixed with water. Phosphine concentrations were 0.60 ppm with a slight H<sub>2</sub>S or sulfur odor. A residue sample was tested and yielded 6 ppm for H<sub>2</sub>S (Dräger tubes). There are potential phosphine interference issues to be considered and additional testing will be conducted on Test 11 and 12.

There were 78.4 pounds of phosphorus collected. Lab analysis predicted 74.9 pounds.

#### **4.11 Test Run #11**

There were 249 pounds of material loaded into the still, which was not agitated. The wireless connection for the thermocouple for still temperature failed at the beginning of the test. The thermocouple was hard wired to the data recorder late in the test. Still temperatures recorded after 15:30 should be accurate. Added 1-2 gallons of makeup water throughout the water phase to control recycle water temperatures.

When the still was opened there was very little smoke and no flames. Temperature of the residue was 50°F. There was a light yellow colored dust layer on the still walls, which was easily removed with hand tools. The still lid was very clean. No phosphorus or acid was found around the still to lid flange. The residue did not ignite when exposed to flame and was not reactive when mixed with water. Phosphine and H<sub>2</sub>S readings were 0.00 ppm.

There were 34.5 pounds of phosphorus collected. Lab analysis predicted 91.8 pounds. The lab analysis to actual weights variance was huge. As the bulk of the difference was P<sub>4</sub> and water, there likely was an error determining the quantity of water in the lab sample.

#### **4.12 Test Run #12**

There were 249 pounds of material loaded into the still, which was agitated. Test 12 water overflow from the water boil phase was within 30 minutes of startup with a still temperature of 155°F, which is less than the expected 190°F. The water boil phase temperature plateau was also about 15°F lower than the 215-217°F normally experienced. A P<sub>2</sub>O<sub>5</sub> vapor trail from the vent stack was also observed with 30 minutes of startup. Adding cold nitrogen to the top of the recycle tank helped reduce the plume. About 6 hours into the run, the

furnace controller tripped off. Typical electrical checks conducted were normal. The problem was finally traced to a faulty over temperature thermocouple at the furnace. Testing resumed shortly after isolating the T/C.

When the still was opened, there was no smoke or fire. Temperature of the residue was just above ambient. No phosphorus or acid was found around the still to lid interface. The residue sample taken did not ignite when exposed to flame and was not reactive when mixed with water. Phosphine concentrations were negligible. There was no indication of H<sub>2</sub>S in the Draeger tube, although there was a slight odor. There was a crust of residue continuous around the still walls equal in depth to the gap between the agitator and still wall. When the crust was disturbed, the cross section showed both a red and yellow layer. Similar to other agitated tests, the gap between the bottom of the agitator and the still (1/2") is very hard and will have to be removed with a chipping hammer.

There were 81.3 pounds of phosphorus collected. Lab analysis predicted 86.7 pounds.

## **5.0 DATA ANALYSIS**

All of the data discussed in the data analysis section can be found in graphical chart form in Appendix 7.8 – “Graphs of Raw Data” or in Appendix 7.9 – “HMB Summary Sheets and Analysis Charts”. The vapor line temperature, furnace temperature, and still temperature are found in the Hi-Temperature Trend Chart. The condenser overflow temperature, condenser outlet temperature, and condenser spray temperature are found in the Lo-Temperature Trend Chart. The vapor line pressure and eductor inlet pressure are found in the Pressure Trend Chart. The cumulative kWh usage during the test run is found in the Cumulative Power Trend Chart.

### **5.1 Furnace Still Temperature**

A thermocouple and wireless temperature transmitter were added to the still as part of the improvements discussed during the January 2011 meeting. The wireless transmitter allowed the temperature inside the still to be monitored during the run to help determine when all phosphorus was vaporized and an endpoint temperature reached. The temperature profile for a typical run was to heat up to just above 200°F and plateau there for several hours as the water was boiled off, then increase to the 550-600°F range plateauing again as the phosphorus was vaporized. From there the temperature will increase and steadily climb to the end of batch temperature between 900 and 1200°F.

### **5.2 Vapor Line Temperature**

The vapor line temperature for Test Run #1 resembled the pattern seen during the 2010 campaign. The vapor line temperature remained flat for several hours just above 200°F during the water boil phase and then rose to the 400-450°F range with double humps for the white and red phosphorus vaporization. After Test Run #1, the vapor line temperature always started at a higher temperature than the still temperature (not true for Test Run #1) and the plateaus for water, white phosphorus, and red phosphorus are not as identifiable. Test Run #2 was particularly lacking in any of the plateaus for the vapor line temperature. The suspected reason for the change after Test Run #1 was the addition of electric heat tracing and insulation to the top of the still and the vapor



line. This added heat would prevent the vapor line from responding to the temperature of the vapor stream coming from the still as before, thus giving a different trend line.

### **5.3 Condenser Related Temperatures**

The condenser related temperatures (overflow temperature, outlet temperature, and spray temperature) generally follow each other during the batch. There is more of a divergence during the water boil phase at the beginning. Condensing the water is the highest heat duty for the condenser, causing more divergence. After the water boil phase is complete the condenser related temperatures follow each other relatively closely until the end of the batch. Fresh cooling water is added to the condenser sprays to control the temperature of the condenser within the range of 120-140°F as required for the phosphorus to condense, properly settle, and collect in the bottom of the condenser.

### **5.4 Condenser and Vapor Line Pressure**

The pressure in the system is controlled by an educator/scrubber located on the top the condenser. Any issues with the flow of water to the educator, or with mechanical integrity of the educator will, cause a pressure excursion from the desired control point. The target for pressure was very slightly positive at the still (0 to 1” WC) and very slightly negative at the educator (0 to -1” WC). Runs 3, 9 and 12 were run with essentially no pressure excursions. The excursions that did occur during any of the runs were not expected to have had any adverse effects on the process or product quality. Controlling the process pressure is done to manage the risk of oxygen getting into the system or phosphorus getting out of the system.

### **5.5 Furnace Power Consumption**

The cumulative power usage for each run can be seen in the Cumulative Power Trend Charst for each run. The trends are generally smooth sloped lines from beginning to end with slight changes in slope for furnace set point changes.

As seen in the 2010 campaign, the accountable process energy budget is heavily influenced by the amount of water charged in each batch. This can be seen in the Per Cent Process Energy as Water vs. Water Charged correlation located in Appendix 7.9 – “HMB Summary Sheets and Analysis Charts”.

The purpose of installing an agitator in the still was to try and improve the heat transfer into the clarifier material and therefore increase energy efficiency (decrease energy inefficiencies). The HMB Summary sheets for agitated and non-agitated Test Runs (Appendix 7.9 – “HMB Summary Sheets and Analysis Charts”) show little significant difference between the average energy inefficiencies for agitated vs. non-agitated test runs (53.0% for non-agitated vs. 50.8% for agitated). If the energy required to drive the agitator is taken into consideration, the difference in energy efficiency (or inefficiencies) between agitated and non-agitated runs is probably small.

### **5.6 Test Run Time Duration**

The test run time duration varied from a low of 6.6 hours for Test Run #4 to a high of 19.5 hours for Test Run # 6. Several variables were correlated with the run time durations with pounds of residue charged having the

highest correlation coefficient ( $R^2=0.791$ ) of the variables correlated. See (Appendix 7.9 – “HMB Summary Sheets and Analysis Charts”) Total Heating Time vs. Material Charge Quantities trend chart for this and other correlations.

## 6.0 CONCLUSIONS

The pilot plant demonstrated that the clarifier material can be treated to recover elemental phosphorus of useful quality from a variety of feed compositions. Twelve distillation trials were successfully and safely carried out during the summer of 2011. There were:

- a) Three trials conducted using roughly 175 lbs of charge per trial (8" charge depth).
- b) Six trials were conducted using roughly 250 lbs of charge per trial (11" charge depth).
- c) Three trials were conducted using roughly 350 lbs of charge per trial (16" charge depth).
- d) Of the twelve trials, seven were conducted with agitation and five were conducted without agitation.

From these trials, several conclusions were made:

- Mixtures of clarifier feeds that are high in phosphorus and high in residual solids are more difficult to treat using this process. These types of feeds result in run times of excessive length, appear to cause excessive boiling and scaling of residual solids on the walls of the still, and unless left for an excessively long time can leave residues contaminated with elemental phosphorus. Because of this issue, some material in the clarifier may not be amenable to treatment using the still.
- There is variation in distillation behavior between different feeds from the clarifier, and this difference is related to the feed composition as well as the amount of material charged to the still.
- Run time for a particular feed is usually dependent on the charge weight and depth of material charged, increasing with larger charge weight.
- Generally speaking, agitation appears to improve heat transfer and therefore reduce run times and increased processing rates. However, it may prove that the operating advantages offered by agitation are offset by the difficulty in scaling up the agitator, seals, etc for a larger scale plant.
- There appear to be maximum charge weights for particular materials charged to the still and gross overcharging of a still must be avoided.
- The clarifier feed distillation at times appears to have distinct stages such as the water boiling period, the phosphorus boiling period, and then a rising temperature period from the end of the phosphorus boiling period up to the end of the run. The phosphorus boiling period is only a small period of the run. The water boiling period can be a considerable part of the run, hence minimizing the amount of water charged to the still is beneficial. However, most often the rising temperature period until the end of the run is the major part of the run time. This indicates, or more likely

confirms, that a significant amount of the yellow phosphorus is converted to red amorphous phosphorus. The red amorphous phosphorus must then be vaporized or sublimed at considerably higher temperatures before the distillation can be completed.

- Determination of the approach of the completion of a run was made by observing the reduction of the amount of phosphorus collected in the phosphorus condenser as indicated by a diminishing of the amount of water being displaced by the condensing phosphorus. A significant decrease in the vapor line temperature and a change in color of the flame from the sniffer valve in the vapor line from yellow to pale green indicated that the phosphorus distillation/sublimation was essentially completed.
- The most significant residues from the process are the solids that remain once the elemental phosphorus has been removed. The bulk density of the residue post distillation ranged from 30-34 lbs. per cubic foot, as compared to the much higher typical bulk density of the clarifier feed of about 85 lbs/cubic foot. The estimated volume of residual solid material requiring safe handling and disposal post distillation will be approximately 60% of the volume of clarifier material before the water and phosphorus have been removed by distillation.
- TCLP analyses were planned to be conducted on all of the test run solid residues. Three of the test run solid residues were contaminated with elemental phosphorus hence, TCLP analyses could not be completed. Nine residue samples were analyzed for TCLP metals. One residue sample (Test #11) passed all TCLP criteria, including Cadmium. Another residue sample (Test #2) in one instance passed the Cadmium criteria while a residue retest for that test failed for Cadmium. The other six residue samples passed all TCLP criteria with the exception of Cadmium. Consequently, most of the residue is likely to fail the TCLP and would require additional treatment to stabilize the leachable Cadmium prior to land disposal of the residue. An evaluation of potential treatment options, and related permitting requirements, must be completed as part of the decision to build a full scale unit.
- Process water usage modifications to minimize the amount of phosphy water generated would need to be evaluated and integrated into the process design in the event that any process water effluent is found to exhibit characteristics of hazardous waste. Likewise, water treatment and disposal alternatives for the phosphy water would need to be evaluated.
- In some instances the residue appeared to be black and powdery. On other occasions the residue was slightly caked, particularly on non-agitated tests. Also, some of the residues had very colorful bright orange and/or yellow scale deposits usually on the side of the still but often times mixed in with the caked residue.

- It should be noted that the series of pilot scale tests in this study were focused on the technical ability of still and condensation technology to recover phosphorus. Many issues remain to be evaluated in order to determine if this technology can be practicably employed at the site, including designing: 1) a full-scale still that can process the 500,000 gallons of clarifier material safely in a reasonable period (it would take the pilot still over 100 years to do so); 2) a process to safely remove and transfer the clarifier material to the still; and 3) a process for the removal, treatment and disposal of non-phosphorus residues from the still that meets regulatory requirements and has all necessary permits. These and other issues will need to be satisfactorily resolved before the feasibility of the still for the clarifier waste can be reliably predicted.
- At this stage, the optimum size of a full scale unit is unknown and thus batch size and batch processing time are also not known. It is likely that these and other aspects will not be known until full scale conceptual design is completed. Thus, the time required to process all of the material in the clarifier at this time cannot be predicted and will be dependant on the size of equipment used for the full scale unit and the ability to operate this equipment in the year round weather conditions at the site.

## **7.0 APPENDICES**

## **7.1 2011 Test Plan**

# Rhodia P4 Pilot Recovery System - 2011 Test Plan

## Key Variables

### Agitation

Agitator operation at 2 rpm  
 Agitator not operating

### Batch Size

~175-200 lb batch size                      6" depth = ~160 lbs batch weight  
     known P4/solids/water ratio            8" depth = ~215 lbs batch weight  
 ~325-350 lb batch size                      12" depth = ~320 lbs batch weight  
     known P4/solids/water ratio

### Ramp Rate

Heat at lower temperature during water vaporization, ie. 700 F / 370 C.  
 raise PV to 1200 F / 650 C at the end of the water vaporization phase.  
 Set PV at 1200 F / 650 C throughout the batch run

### P4 to Solids

<30 % P4 to solids ratio. Low P4 concentrations  
 30-60% P4 to solids ratio. Expected clarifier average ratio.  
 >60% P4 to solids ratio. High P4 concentrations

Run No.	P4/Solids	Batch Size	Agitator	Ramp	Data collected for analysis
1	<30%	175	On	700/1200	Temperatures/pressures from 2010 operator log
2	30-60%	175	On	700/1200	Batch elapsed time
3	>60%	175	On	700/1200	Power used (KWH)
4	<30%	350	On	700/1200	KWH per pound charged
5	30-60%	350	On	700/1200	Material balance vs. sampling baseline
6	>60%	350	On	700/1200	Charge depth start / end
7	<30%	175	On	1200	Batch residue density
8	30-60%	175	On	1200	TCLP/P analysis of batch residue
9	>60%	175	On	1200	Heat residue to detect residual RAP
10	<30%	350	On	1200	PH3 generation sampling thru batch run
11	30-60%	350	On	1200	PH sampling of recycle water system.
12	>60%	350	On	1200	Fresh water consumption by batch/total
13	(1)	175	Off	(3)	PH3 when opening skip
14	(1)	350	Off	(3)	pH in drums, skip, just before and just after run
15	(2)	175	Off	(4)	Batch temperature
16	(2)	350	Off	(4)	
17	Other tests from analysis of previous batches				
18	Other tests from analysis of previous batches				

- (1) Repeat successful low P4 batch without agitator.
- (2) Repeat successful mid-range P4 batch without agitator. Expected clarifier average ratio
- (3) Repeat preferred ramp rate from previous testing.
- (4) Repeat preferred starting PV temperature from previous testing. (Could be the same as runs 13-14)

### Operational Changes

Pre-charge/heat second still for material separation and excess water removal.  
 Ability to run a batch longer than 12 hours if needed  
 Run several batches before replenishing the scrubber system water (track pH)

### System changes:

bottom heat coils added  
 new seal on agitator  
 inverted V vapor line with valve at top  
 fresh water addition to recycle tank  
 Temp probe (wireless) in skip, thru agitator shaft

## **7.2 Drawings**



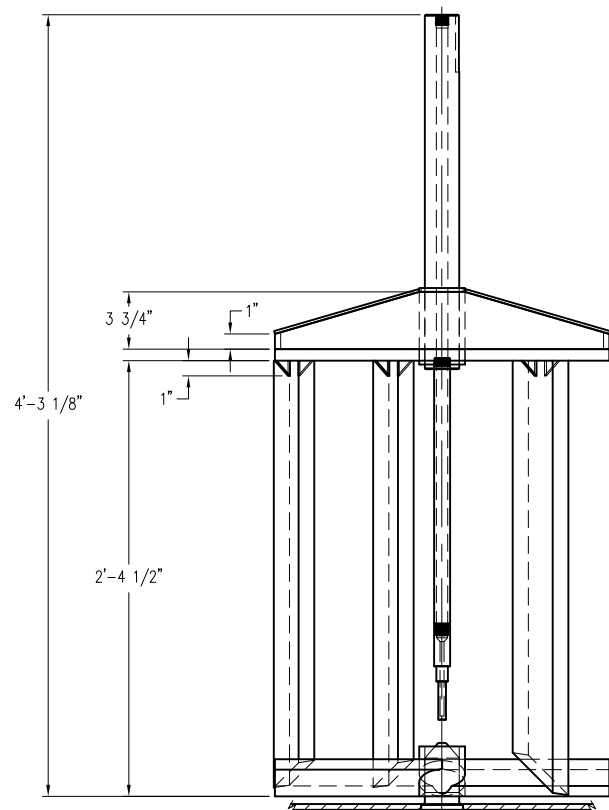
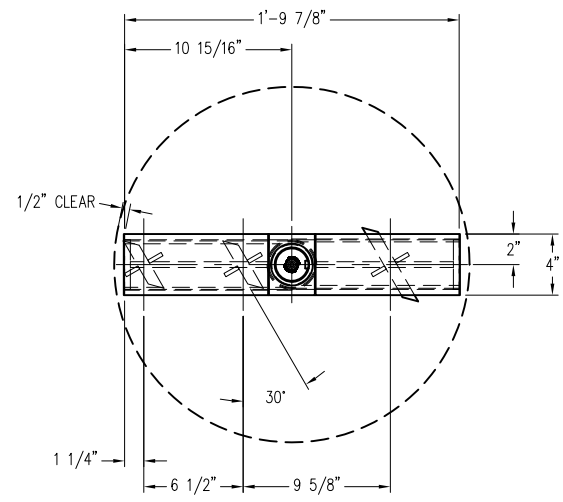

NOTE: ADD  $\varnothing 2-1/4$ " HOLE IN CENTER OF EXISTING PAN STILL BASE. WELD PIVOT (K) IN PLACE.

FULL WELDMENT / ASSEMBLY DETAILS  
SCALE: 1"=0'-6"

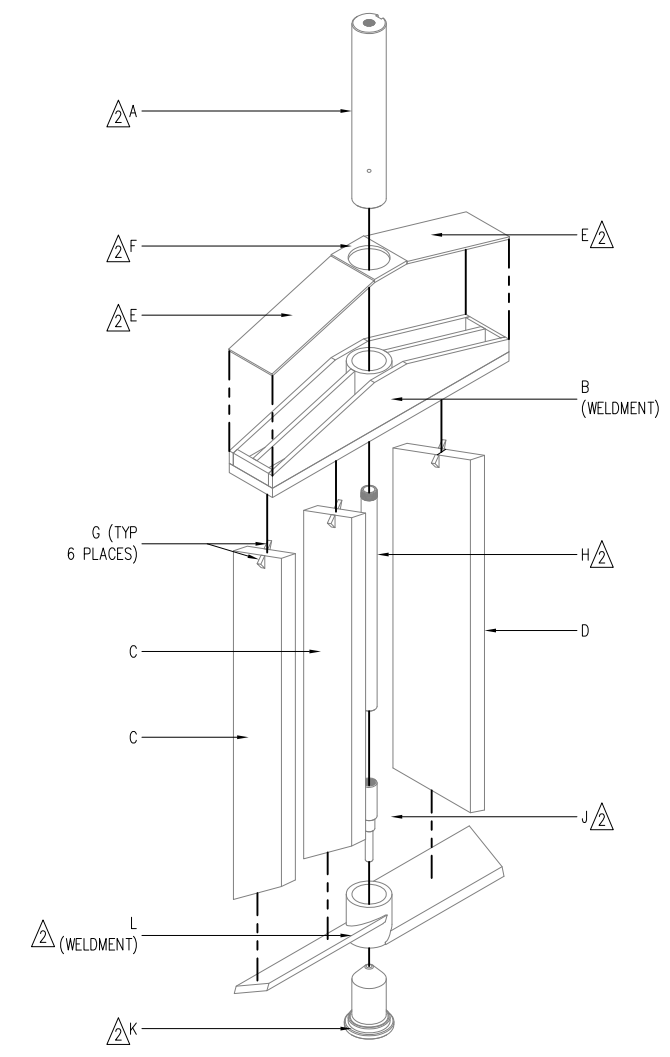
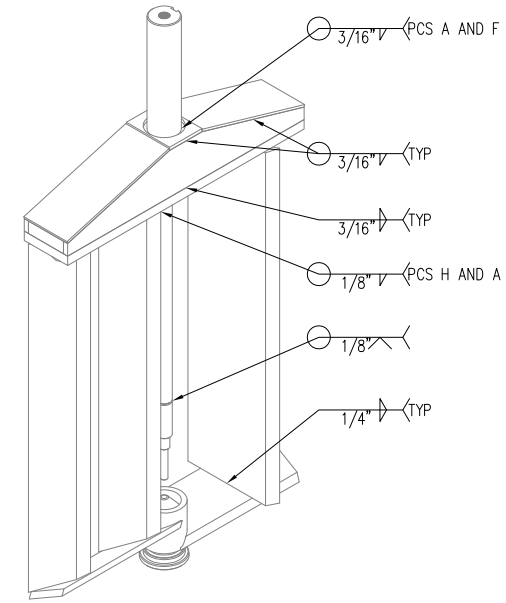
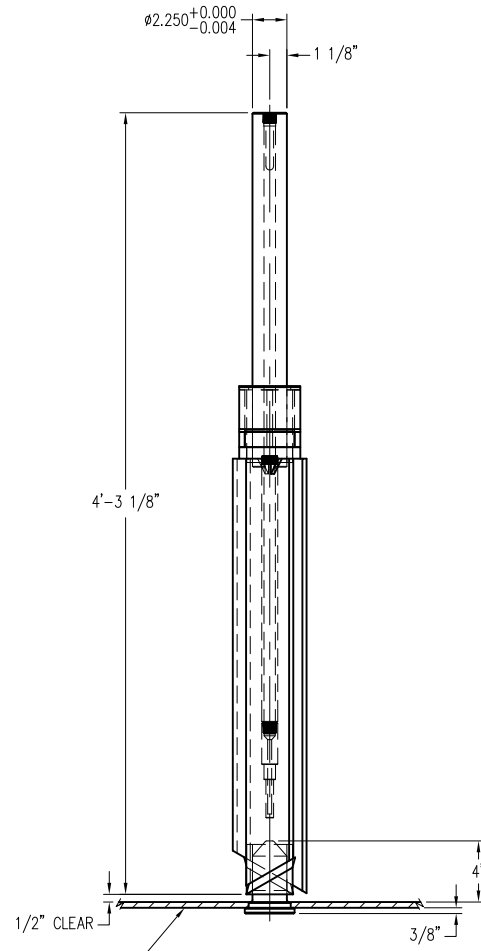

ITEM	DESCRIPTION	MATERIAL	QTY	SPEC	REQD
L	LOWER SUPPORT WELDMENT	316L STAINLESS STEEL	2	AS NOTED	1
K	PIVOT (WELD-ON)	416 STAINLESS STEEL (Harden HRC 35)	2	$\varnothing 3-1/4" \times 4-3/4"$	1
J	THERMOWELL - STEPPED (WELD-ON)	316L STAINLESS STEEL (ROSEMONT)	2	FOR 58C-035-SHNN	1
H	SHAFT EXTENSION	316L STAINLESS STEEL PIPE (SCH 80)	2	$3/4" \text{ PIPE } \times 1'-5-1/2"$	1
G	GUSSET	316L STAINLESS STEEL	2	$1/4" \times 1" \times 1"$ GUSSET	6
F	SMALL CAP	316L STAINLESS STEEL	2	$1/4" \times 3" \times 4"$	1
E	LARGE CAP	316L STAINLESS STEEL	1	$1/4" \times 4" \times 9-3/8"$	2
D	LARGE BLADE	316L STAINLESS STEEL	2	$3/4" \times 6" \times 2'-4-1/2"$	1
C	SMALL BLADE	316L STAINLESS STEEL	2	$3/4" \times 4" \times 2'-4"$	2
B5	END SUPPORT	316L STAINLESS STEEL	3	$3/8" \times 1-1/8" \times 3-1/4"$	2
B4	GUSSET SUPPORT	316L STAINLESS STEEL	3	$3/8" \times 3-3/4" \times 9"$	2
B3	SIDE SUPPORT	316L STAINLESS STEEL	3	$3/8" \times 3-3/4" \times 1'-9-7/8"$	2
B2	SHAFT SUPPORT	316L STAINLESS STEEL TUBING (3" OD)	3	$3/8" \text{ WALL } \times 4-3/4" \text{ L}$	1
B1	BASE SUPPORT	316L STAINLESS STEEL	3	$3/4" \times 4" \times 1'-9-7/8"$	1
A	SHAFT	316L STAINLESS STEEL	2	$\varnothing 2-1/4" \times 1'-11-3/16"$	1
ITEM	DESCRIPTION	MATERIAL	SHEET	SPEC	REQD

NOTE:

UNLESS OTHERWISE SPECIFIED:  
DIMENSIONS ARE IN INCHES  
TOLERANCES: XX ± .01, XXX ± .005, ANGLES ± 0°30', FRACTIONS ± 1/16  
BREAK SHARP EDGES .005-.015, FILLET RADI: .010 MAX, SURFACES PER RMS 125, DIMENSIONS APPLY AFTER PLATING

REV.	DATE	REVISION DESCRIPTION
5		
4		
3		
2	04/14/11	REDESIGNED FOR SHAFT EXT AND LOWER BLADE
1	05/25/10	ISSUED FOR FABRICATION
0	04/29/10	ISSUED FOR BID

© FRANKLIN engineering group, inc.  
DATE: 11-19-09 ALL RIGHTS RESERVED  
NOTICE: THIS DRAWING HAS NOT BEEN PUBLISHED AND IS THE SOLE PROPERTY OF FRANKLIN ENGINEERING GROUP. IT IS LOANED TO THE BORROWER FOR THEIR CONFIDENTIAL USE ONLY. AND IN CONSIDERATION OF THE LOAN OF THIS DRAWING, THE BORROWER AGREES TO RETURN IT UPON REQUEST AND AGREES THAT IT SHALL NOT BE REPRODUCED, COPIED, LOANED OR OTHERWISE DISPOSED OF DIRECTLY OR INDIRECTLY NOR USED FOR ANY PURPOSE OTHER THAN FOR WHICH IT IS FURNISHED.

PROJECT MANAGER: JGD  
LEAD ENG: DJL  
DESIGNER: JCC  
CLIENT APPROVAL: .  
SAFETY APPROVAL: .  
MOUNT APPROVAL: .

PHOSPHORUS RECOVERY PILOT PLANT  
PAN STILL  
AGITATOR DETAIL  
RHODIA  
BUTTE, MONTANA  
SCALE: AS NOTED, PAPER: D, DRAWING NO: 721-421, SHEET: 1 of 3, REV: 2



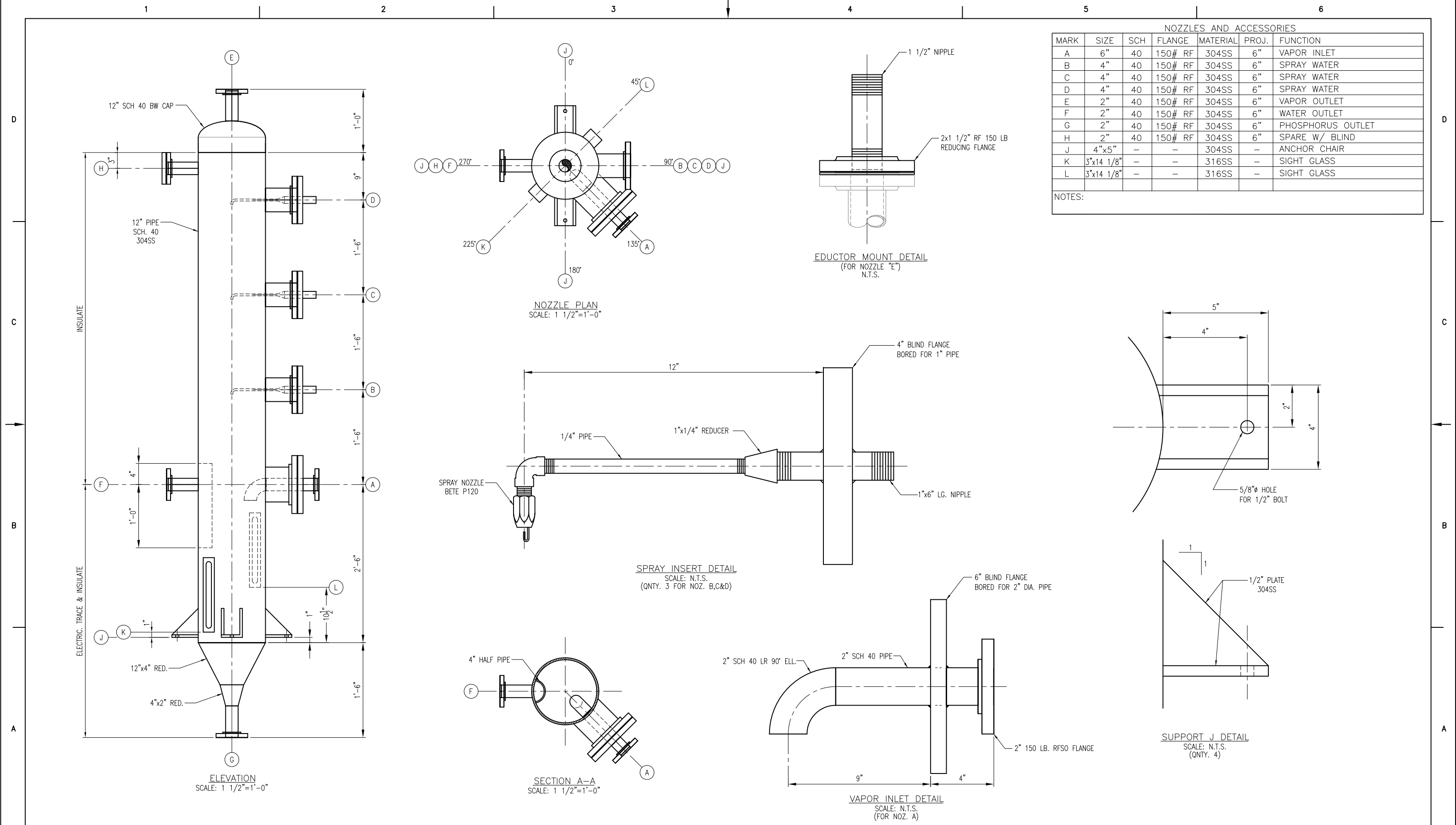

NOZZLES AND ACCESSORIES						
MARK	SIZE	SCH	FLANGE	MATERIAL	PROJ.	FUNCTION
A	6"	40	150# RF	304SS	6"	VAPOR INLET
B	4"	40	150# RF	304SS	6"	SPRAY WATER
C	4"	40	150# RF	304SS	6"	SPRAY WATER
D	4"	40	150# RF	304SS	6"	SPRAY WATER
E	2"	40	150# RF	304SS	6"	VAPOR OUTLET
F	2"	40	150# RF	304SS	6"	WATER OUTLET
G	2"	40	150# RF	304SS	6"	PHOSPHORUS OUTLET
H	2"	40	150# RF	304SS	6"	SPARE W/ BLIND
J	4"x5"	-	-	304SS	-	ANCHOR CHAIR
K	3"x14 1/8"	-	-	316SS	-	SIGHT GLASS
L	3"x14 1/8"	-	-	316SS	-	SIGHT GLASS

NOTES:

NOTE: 1. ALL MATERIALS 304SS UNLESS NOTED.  
 2. ALL 304SS THREADED FITTINGS 1 1/2" AND BELOW SHALL BE SCH 80.

REV.	DATE	REVISION DESCRIPTION
5		
4		
3		
2		
1	02/25/10	ISSUED FOR BID
0	02/11/10	ISSUED FOR REVIEW

**FRANKLIN**  
 engineering group, inc.  
 DATE: 02/11/10 ALL RIGHTS RESERVED  
 NOTICE: THIS DRAWING HAS NOT BEEN PUBLISHED AND IS THE SOLE PROPERTY OF FRANKLIN ENGINEERING GROUP. IT IS LOANED TO THE BORROWER FOR THEIR CONFIDENTIAL USE ONLY, AND IN CONSIDERATION OF THE LOAN OF THIS DRAWING, THE BORROWER AGREES TO RETURN IT UPON REQUEST AND AGREES THAT IT SHALL NOT BE REPRODUCED, COPIED, LOANED OR OTHERWISE DISPOSED OF DIRECTLY OR INDIRECTLY NOR USED FOR ANY PURPOSE OTHER THAN FOR WHICH IT IS FURNISHED.

PROJECT MANAGER	PHOSPHORUS RECOVERY PILOT PLANT CONDENSER E-100 FABRICATION DETAIL
LEAD ENG.	
DESIGNER	
CLIENT APPROVAL	
SAFETY APPROVAL	RHODIA BUTTE, MONTANA
MGMT APPROVAL	
SCALE	1 1/2"=1'-0"
PAPER	D
DRAWING NO.	721-401
SHEET	1 of 1
REV.	1

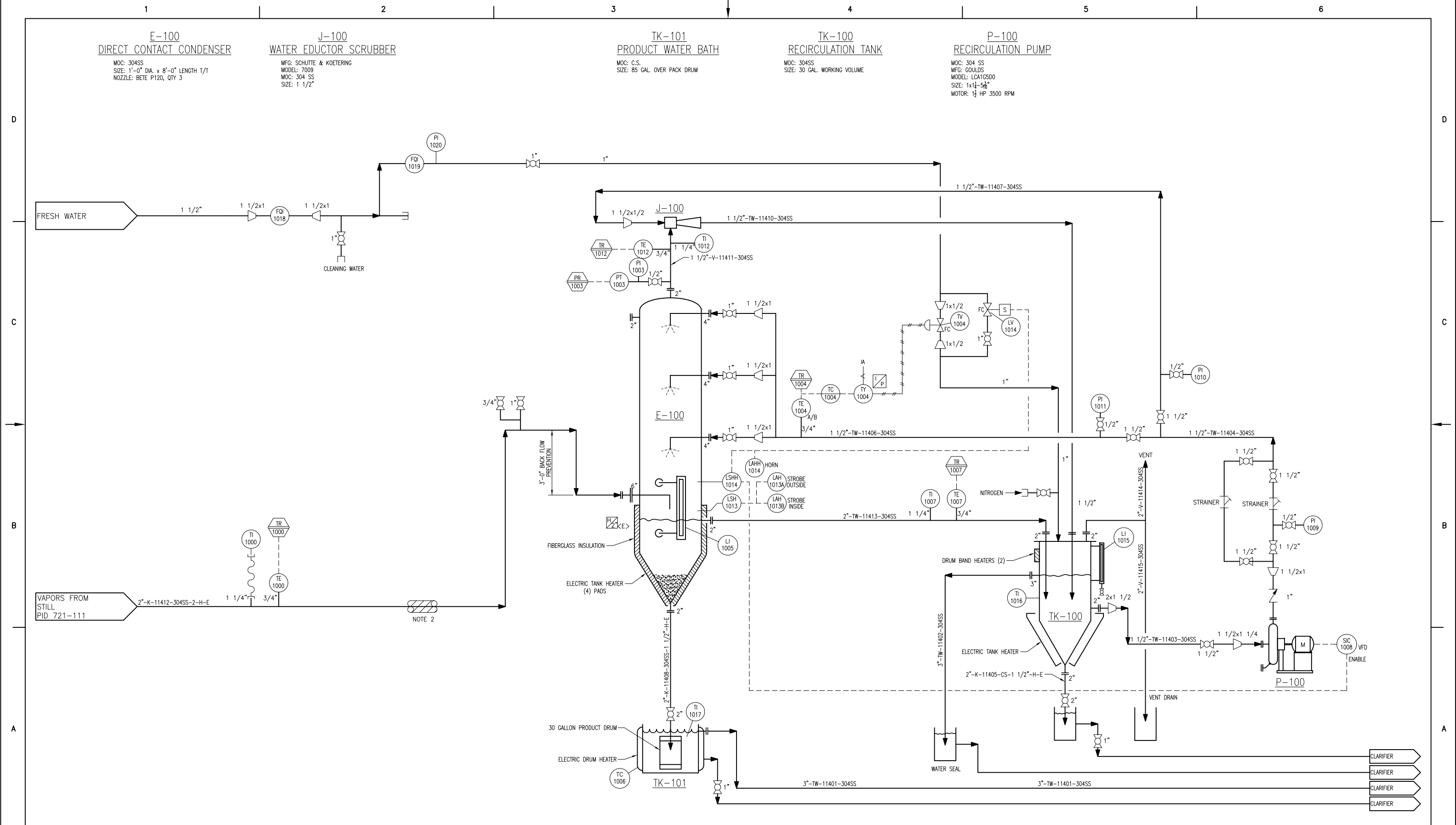

NOTE:  
 1. INSTRUMENT TAPS SHALL BE FEMALE NPT UNLESS OTHERWISE NOTED.  
 2. THERMON HEAT TRACE CABLE WITH THERMON T-99 HEAT TRANSFER CEMENT COVERED WITH CASTABLE REFRACTORY. 240 VOLT, 1920 WATTS, 0-600°F CONTROLLER. IDENTICAL SYSTEMS INSTALLED ON STILL LID AND VAPOR LINE.

5	08/04/10	ISSUED FOR HAZARDS REVIEW
4	06/08/10	ADDED INSTRUMENT TAP SIZES
3	06/04/10	REVISED
2	04/29/10	ISSUED FOR BID
1	02/25/10	ISSUED FOR PIPING AND MECH BID
6	11/30/11	AS BUILT
REV.	DATE	REVISION DESCRIPTION

**FRANKLIN**  
 engineering group, inc.  
 DATE: 02/11/10 ALL RIGHTS RESERVED  
 NOTICE: THIS DRAWING HAS NOT BEEN PUBLISHED AND IS THE SOLE PROPERTY OF FRANKLIN ENGINEERING GROUP. IT IS LOANED TO THE BORROWER FOR THEIR CONFIDENTIAL USE ONLY, AND IN CONSIDERATION OF THE LOAN OF THIS DRAWING, THE BORROWER AGREES TO RETURN IT UPON REQUEST AND AGREES THAT IT SHALL NOT BE REPRODUCED, COPIED, LOANED OR OTHERWISE DISPOSED OF DIRECTLY OR INDIRECTLY NOR USED FOR ANY PURPOSE OTHER THAN FOR WHICH IT IS FURNISHED.

PROJECT MANAGER	PILOT PHOSPHORUS RECOVERY SYSTEM CONDENSER P&ID		
LEAD ENG	RHODIA		
DESIGNER	BUTTE, MONTANA		
CLIENT APPROVAL	SCALE	PAPER	DRAWING NO.
SAFETY APPROVAL	NTS	D	721-114
MECH APPROVAL	SHEET	1 of 1	
	REV.	6	

1

2

3

4

5

6

D

C

B

A

D

C

B

A

### H-200 ELECTRIC FURNACE

MFG: THE MELLEEN COMP.  
MODEL: CV08-26X30V-1Z  
CAP: 45 KW  
MAX. TEMP: 1472 °F

### E-201 PAN STILL

MFG: FEG  
MODEL:  
CAP.: 3.5 CU/FT

### MX-203 PAN STILL MIXER

HP: 2 HP 3Ø 460V

### H-202 NITROGEN HEATER

MFG: HOT WATT  
MODEL: AH75-6MF  
CAP: 750 WATT  
POWER: 120 VAC

### H-203 NITROGEN HEATER

MFG: HOT WATT  
MODEL: AH75-6MF  
CAP: 750 WATT  
POWER: 120 VAC

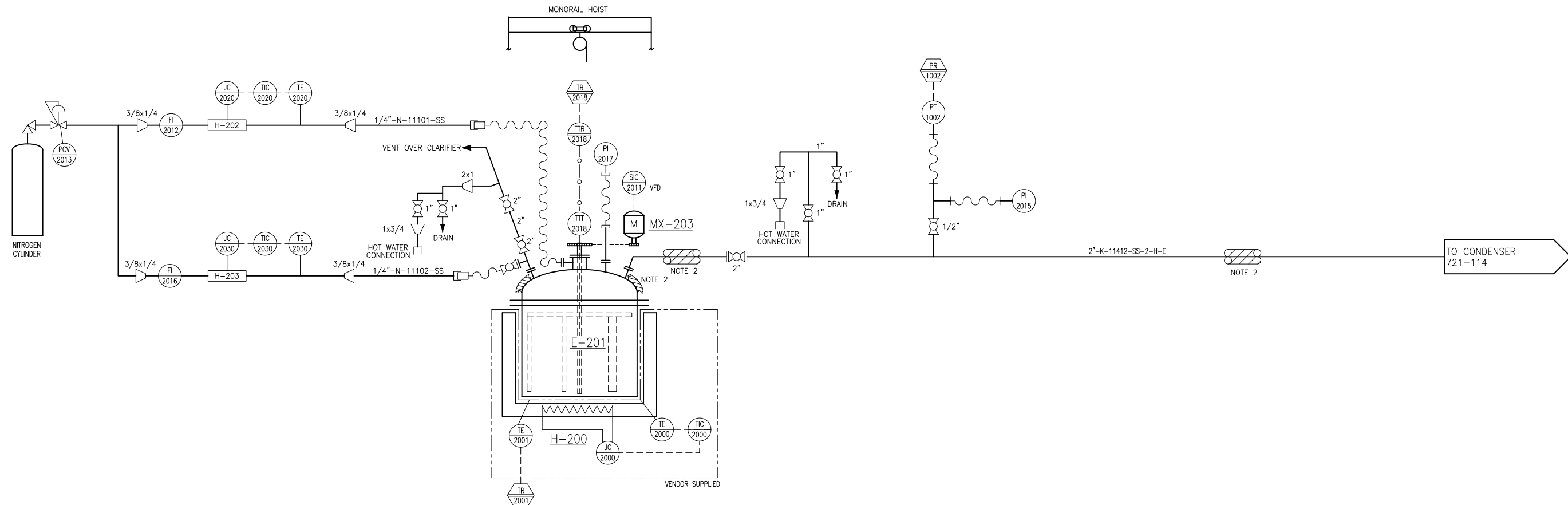

**NOTE:**

- INSTRUMENT TAPS SHALL BE FEMALE NPT UNLESS OTHERWISE NOTED.
- THERMON HEAT TRACE CABLE WITH THERMON T-99 HEAT TRANSFER CEMENT COVERED WITH CASTABLE REFRACTORY. 240 VOLT, 1920 WATTS, 0-600°F CONTROLLER. IDENTICAL SYSTEMS INSTALLED ON STILL LID AND VAPOR LINE.

REV.	DATE	REVISION DESCRIPTION
5	11/30/11	AS BUILT
4	08/18/10	REVISED PER 08/12/10 HAZARD REVIEW
3	08/04/10	ISSUED FOR HAZARDS REVIEW
2	06/08/10	ADDED INSTRUMENT TAP SIZES
1	06/04/10	REVISED
0	04/29/10	ISSUED FOR BID

**FRANKLIN**  
engineering group, inc.

DATE: 04/29/10 ALL RIGHTS RESERVED

NOTICE: THIS DRAWING HAS NOT BEEN PUBLISHED AND IS THE SOLE PROPERTY OF FRANKLIN ENGINEERING GROUP. IT IS LOANED TO THE BORROWER FOR THEIR CONFIDENTIAL USE ONLY, AND IN CONSIDERATION OF THE LOAN OF THIS DRAWING, THE BORROWER AGREES TO RETURN IT UPON REQUEST AND AGREES THAT IT SHALL NOT BE REPRODUCED, COPIED, LOANED OR OTHERWISE DISPOSED OF DIRECTLY OR INDIRECTLY NOR USED FOR ANY PURPOSE OTHER THAN FOR WHICH IT IS FURNISHED.

PROJECT MANAGER	PILOT PHOSPHORUS RECOVERY SYSTEM PAN STILL P&ID  RHODIA BUTTE, MONTANA				
LEAD ENG					
DESIGNER					
CLIENT APPROVAL					
SAFETY APPROVAL					
MGMT APPROVAL	SCALE: NTS	PAPER: D	DRAWING NO.: 721-111	SHEET: 1 of 1	REV: 5

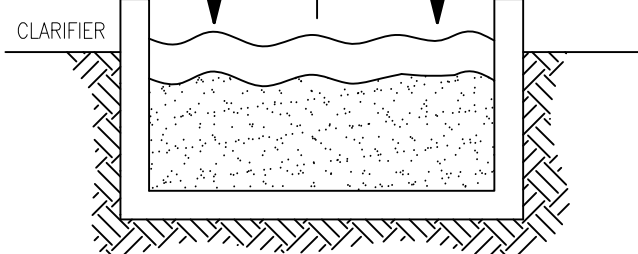
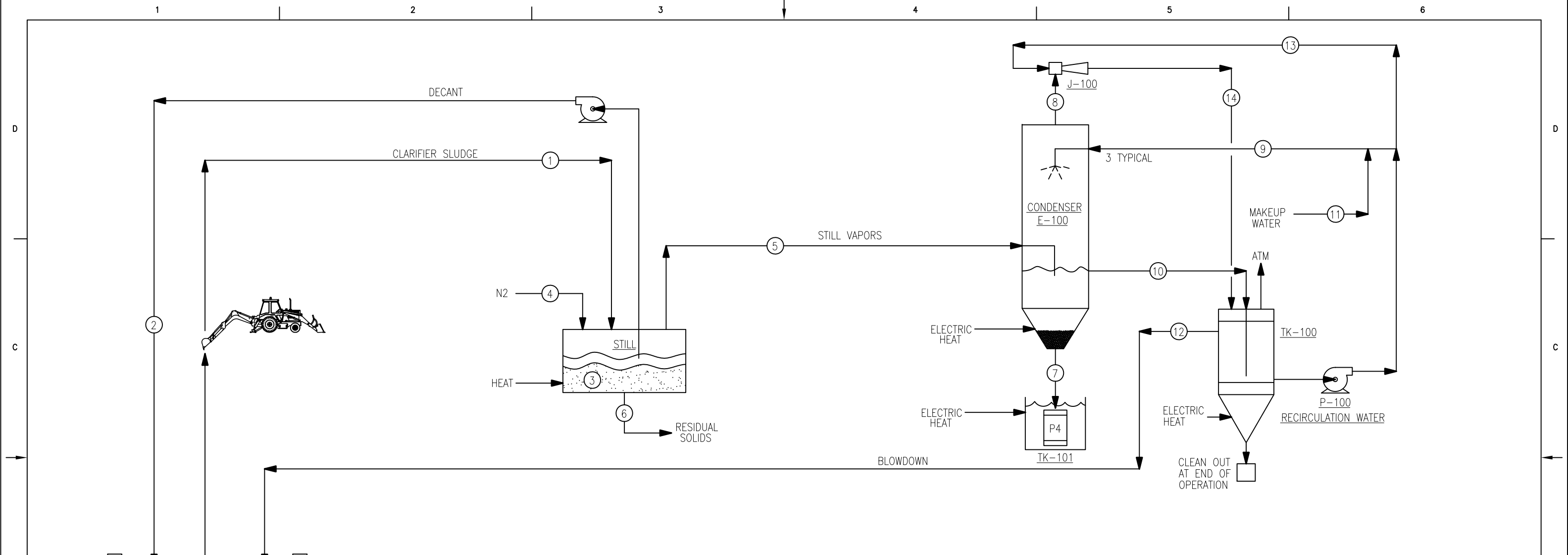

Parameter	Value	Units
Clarifier P4 content	20.0%	vol%
Clarifier Clear H2O content	22.7%	vol%
Clarifier Sand/silt/h2O content	57.3%	vol%
Solids porosity	25.0%	vol%
Embedded water content	14.3%	vol%
Clarifier Sand/silt content	43.0%	vol%
Clarifier Water content	37.0%	vol%
Clarifier Temp	68	F
Decant vol	46.0%	vol% total H2O
White P --> Red P conversion	24.3%	wt %
White P --> Red P conversion	572	F
White P BP	536	F
Red P Vaporization Temp	731	F
P4 solubility in water	3.33	mg/l
Inert gas sweep rate	2	scfm
Sweep gas temp	68	F
Raw Batch Size	4.10	ft3
Condenser Temp	140	F
HMB Ref Temp	68	F
Atm Pressure	11.95	psia
Technology	Batch Still	
Batch size	3.4	ft3
Max Heat Rate	10	F/min
Max Temp	1400	F

MATERIAL BALANCE (Batch Totals)

PARAMETER	STREAM NUMBER	1	2	3	4	5A	6A	5B	6B	5C	6C	7	8	9	10	11	12	13	14
STREAM NAME	From Clarifier	Decant	Still Feed	Sweep Gas	Still Vent	Residue	Still Vent	Residue	Still Vent	Residue	P4	Cond Vent	Spray Water	Cond Overflow	Make-up H2O	Cond B/D	Eductor Water	Eductor Exhaust	
time lapse	min		0	0	57.6	57.6	109.2	109.2	135.4	135.4	135.4	135.4	135.4	135.4	135.4	135.4	135.4	135.4	135.4
temp	F	68	68	68	68	202	202	503	503	731	731	139	140	130	139	68	139	139	139
temp	C	20.0	20.0	20.0	20.0	94.4	94.4	261.7	261.7	388.3	388.3	59.7	60.0	54.4	59.7	20.0	59.7	59.4	59.4
temp	K	293.2	293.2	293.2	293.2	367.6	367.6	534.8	534.8	661.5	661.5	332.8	333.2	327.6	332.8	293.2	332.8	332.6	332.6
pressure	psia				12.45	12.45	12.45	12.45	12.45	12.45	11.95	11.95	11.95	11.95	11.95	11.95	11.95	11.95	11.95
Water	lb	94.7	43.6	51.1	0	51.1	0.0	0	0	0	0	4.1	8170.0	8217.0	1073.5	1120.6	2877.93	2882.03	
White P	lb	93.1	0.0	93.1	0	1.8	91.3	68.7	0.0	0	0	0.09	0.024	0.03	0	0.004	0.010	0.10	
Red P	lb	0.0	0.0	0.0	0	0	0	22.6	0	0	0	0	0	0	0	0	0	0.00	
Sand/silt	lb	208.7	0.0	208.7	0	0	208.7	0	208.7	0	0	0	0	0	0	0	0	0.00	
Nitrogen	lb	0.0	0.0	0.0	20.0	8.5	0.0	7.6	0.0	3.9	0	0	0	0	0	0	0	19.99	
Total	lb	396.5	43.6	352.9	20.0	61.4	300.0	76.3	231.3	26.5	208.7	93.0	24.2	8170.0	8217.1	1073.5	1120.6	2877.9	2902.1
Water	Pvap psia				12.01	0	0	0	0	0	0	2.89	2.22	2.84	0.34	2.84			
White P	Pvap psia				0.06	0.06	12.00	0	0	0	0.009	0.009	0.007	0.009	0	0.009			
Red P	Pvap psia				0	0	0	0.35	0	11.94	0	0	0	0	0	0			
Sand/silt	Pvap psia				0	0	0	0	0	0	0	0	0	0	0	0			
Nitrogen	Pvap psia				0.38	0.45	0.51	0	0	0	0	9.1	0	0	0	0			
Total	Pvap psia				12.45	12.45	12.45	12.45	12.45	11.95	2.2	2.9	0.3	2.9					
Water	mole-frac				0.965	0.000	0.000	0.242											
White P	mole-frac				0.005	0.964	0.000	0.001											
Red P	mole-frac				0.000	0.000	0.959	0.000											
Sand/silt	mole-frac				0.000	0.000	0.000	0.000											
Nitrogen	mole-frac				0.030	0.036	0.041	0.757											
Total	mole-frac				1.000	1.000	1.000	1.000											
Water	lb-mole	5.26	2.42	2.84	0.00	2.838	0.00	0.00	0.00	0.00	0.00	0.228	453.49				62.20		
White P4	lb-mole	0.75	0.00	0.75	0.00	0.014	0.55	0.00	0.00	0.75	0.001	0.0002	0.0000				0.0000		
Red P	lb-mole																		
Sand/silt	lb-mole																		
Nitrogen	lb-mole					0.304	0.272	0.138											
Total	lb-mole					3.156	0.827	0.138											
Total	Actm/gpm					29.568	5.942	0.990					3.545	7.38	7.42	0.95	1.01	2.6	4.00 / 2.60
Water	Btu	0	0	0	0	56.471	0	0	0	0	0	131	506.540	586.525	0	79.985			
White P4	Btu	0	0	0	0	360	3,088	16,265	0	0	1,221	1.18	0.27	0.36	0	0.05			
Red P	Btu	0	0	0	0	0	0	2,015	6,850	0	0	0	0	0	0	0			
Sand/silt	Btu	0	0	0	0	0	5,592	0	20,993	0	0	0	0	0	0	0			
Nitrogen	Btu	0	0	0	0	285	0	828	0	641	0	360	0	0	0	0			
Total	Btu	0	0	0	0	57.116	8,681	17,093	23,007	7,491	27,670	1,221	494	506,540	586,525	0	79,985		

Physical Properties	Density	Cp	Latent Heat of Vaporization	Heat of Fusion	MP	BP @ 11.95 psia	MW
	g/cc	Btu/lb°F	BTU/lb	BTU/lb	°F	°F	
Water	1	1	970.3		202	212	18.016
White P	1.82	0.184	172.1	9.16	111.6	503	123.92
Red P	2.2	0.184	172.1			731	
Sand/silt	1.9	0.2					
Nitrogen	0.0738	0.25					28.013
N2 - lb/ft3							
Water Vapor		0.45					18.016

NOTE: BOILING POINTS IGNORE THE EFFECTS OF SWEEP GAS

REV.	DATE	REVISION DESCRIPTION
5		
4		
3		
2		
1	02/25/10	REV. PER 02/24/10 CONF. CALL
0	02/11/10	ISSUED FOR REVIEW

© FRANKLIN engineering group, inc.  
 DATE: 02-11-10 ALL RIGHTS RESERVED  
 NOTICE: THIS DRAWING HAS NOT BEEN PUBLISHED AND IS THE SOLE PROPERTY OF FRANKLIN ENGINEERING GROUP. IT IS LOANED TO THE BORROWER FOR THEIR CONFIDENTIAL USE ONLY, AND IN CONSIDERATION OF THE LOAN OF THIS DRAWING, THE BORROWER AGREES TO RETURN IT UPON REQUEST AND AGREES THAT IT SHALL NOT BE REPRODUCED, COPIED, LOANED OR OTHERWISE DISPOSED OF DIRECTLY OR INDIRECTLY NOR USED FOR ANY PURPOSE OTHER THAN FOR WHICH IT IS FURNISHED.

PROJECT MANAGER  
 LEAD ENG  
 DESIGNER  
 CLIENT APPROVAL  
 SAFETY APPROVAL  
 MGMT APPROVAL

FIGURE 1  
 PILOT PHOSPHORUS RECOVERY SYSTEM PFD/HMB

RHODIA BUTTE, MONTANA

SCALE: N.T.S. PAPER: D DRAWING NO: 721-101 SHEET: 1 of 1 REV: 1

## **7.3 Procedures**

<b>KW</b>	<b>PAN STILL CONTINUOUS OPERATIONS</b>	KWI-RPR-102
		Revision 1 Issue Date: May 27, 2011
		Page 1 of 7
Pocatello, Idaho		Authorized by: KW - Tim Whiteus, Wade Keller. Rhodia – Cam Balentine

<b>SCOPE</b>	This procedure describes the steps required to prepare and operate the Pan Still in a continuous mode thru a batch run.
<b>RESPONSIBILITIES</b>	All operators, administrative support and other qualified personnel are responsible for this procedure.
<b>REQUIREMENTS</b>	The operators are required to complete these steps in a safe and efficient manner to assure quality representative samples and data points are obtained for each batch run.
<b>RELEVANT DOCUMENTS</b>	Individual equipment operating manuals. Project specific operating procedures. Rhodia site specific contingency plan. <b>OPERATIONS NOTE: Operating parameters and set points are compiled on the Operating Guidelines spreadsheet.</b>
<b>MATERIALS AND EQUIPMENT</b>	The special equipment required for this procedure includes: <ul style="list-style-type: none"> <li>• H-201 Mellen 45KW Electric Furnace</li> <li>• EuroTherm Furnace Controller</li> <li>• E-201 Pan Still</li> <li>• E-100 Direct Contact Condenser</li> <li>• TK-100 Recirculation Tank</li> <li>• P-100 Recirculation Pump</li> <li>• J-100 Water Eductor Scrubber</li> <li>• TV-1004 Makeup Water Valve</li> </ul>
<b>SAFETY, HEALTH AND ENVIRONMENT</b>	The following protective equipment is required: Preparation, equipment checks and staging of equipment can be performed utilizing Level D personnel protection: <ul style="list-style-type: none"> <li>• OSHA approved hard hat</li> <li>• OSHA approved vision protection</li> <li>• OSHA approved steel toe safety shoes</li> <li>• Long sleeve shirt</li> <li>• Leather gloves as required</li> <li>• Respiratory protection as required</li> <li>• Hearing protection as required</li> </ul>
<b>QUALITY</b>	This is a critical operation to effectively obtain accurate



<b>KW</b>	<b>PAN STILL CONTINUOUS OPERATIONS</b>	KWI-RPR-102
		Revision 1 Issue Date: May 27, 2011
		Page 2 of 7
Pocatello, Idaho		Authorized by: KW - Tim Whiteus, Wade Keller. Rhodia – Cam Balentine

information relating to the recovery of phosphorus from contaminated clarifier solids.

**PROCEDURE**

Prepare the Pan Still assembly for batch operations.

**CAUTION**

Aluminum gear is to be worn anytime personnel are working around the material or equipment potentially contaminated with P4. After the Pan Still lid has been installed and bolted down, equipment and system checks can be performed with Level D PPE

Remove the control and over temperature thermocouples from the Mellen furnace if installed. Use caution in handling the thermocouples. They are of ceramic construction and very fragile.

Install the vapor line removable spool piece. NOTE: Unless noted, spiral wound gaskets are to be used at all flanged joints. Spiral wound gaskets are to be used for one application only and are to be discarded after a single use. Tighten bolts to 150 ft/lbs of torque.

Install removable instrumentation on the vapor line. Confirm instrumentation is sending a signal to the data logger.

Spin the agitator by hand to confirm it is not binding in the packing housing or in the Pan Still. Install the agitator drive chain and tensioning device.

Install removable pressure relief (PRV) spool piece from the Pan Still lid to the vent line. The 2" bronze ball valve on the pressure relief line should be closed. Confirm all block and bleed valves on the PRV piping spool are closed.

Install the 0-100" W.C. pressure gage to the 1" pipe

<b>KW</b>	<b>PAN STILL CONTINUOUS OPERATIONS</b>	KWI-RPR-102
		Revision 1 Issue Date: May 27, 2011
		Page 3 of 7
Pocatello, Idaho		Authorized by: KW - Tim Whiteus, Wade Keller. Rhodia – Cam Balentine

nozzle on the Pan Still lid.

Remove the flange guards below the vapor line plug valve and the PRV vent valve. Confirm the bolts are torqued to specification and there is no trace of residual phosphorus or phos acid. If there is indication of leakage replace the spiral wound gasket and reinstall/torque bolts.

Carefully reinstall control and over temperature thermocouples. The thermocouple labeled control is to be installed at the east side of the furnace. Slide the thermocouple into the furnace until the connection pins are flush with the metal guide. Tighten screw and washer to secure the thermocouple. Do not over tighten. Repeat this process installing the over temperature thermocouple into the south side of the furnace. Connect the yellow thermocouple cables at the furnace controller panel to their respective plugs.

Install the remote Pan Still thermocouple. Confirm a signal is being received by the data logger.

**OPERATIONS NOTE: Operating parameters and set points are compiled on the Operating Guidelines spreadsheet. An Operator Log Sheet will be maintained throughout the entire Test run.**

Prepare Water System for Operations

The following water system parameters are to be checked and verified before the furnace can be energized.

Confirm all heat blankets are operational.

Confirm the safety shower is charged and operational.

Confirm there is a minimum of 10" of water in the vent

<b>KW</b>	<b>PAN STILL CONTINUOUS OPERATIONS</b>	KWI-RPR-102
		Revision 1 Issue Date: May 27, 2011
		Page 4 of 7
Pocatello, Idaho	Authorized by: KW - Tim Whiteus, Wade Keller. Rhodia – Cam Balentine	

seal drum.

Confirm the fresh water supply line is charged with a minimum of 35 psig pressure.

Confirm the 85 gallon overpak drum has adequate water to cover the 30 gallon product drum. The water temperature in the overpak drum should be 125-160 degrees F during operations. Hot makeup water can be added to the overpak or product drum using the Hotsy if required. Make up water should not exceed 160 degrees F.

Shutdown the P-100 recirculation pump. Shut the 1-1/2" isolation valves on either side of the P-100 recirculation pump strainer. Remove the strainer screen and inspect for plugged holes. Clean as required and reassemble. Open isolation valves and restart P-100 recirculation pump. Begin operations with the pump Hz set at 37.

Check the condenser overflow water temperature. If the water temperature is not between 120-145 degrees F, add 160 degree water to the TK-100 recycle tank with the Hotsy until the system water temperature is between 120 and 145 degrees F. NOTE. The 3/4" valve from the nitrogen system must be closed when adding water to the water system.

Operators must confirm that the overflow line from the recycle tank to the clarifier is open. If adding water to the system, observe the overflow seal for water discharge into the clarifier. If the water system temperature is within operating range fresh water must be added until discharge is confirmed from the overflow water seal. To add fresh water, open the 1" bypass valve around the fresh water control valve until water is discharged into the clarifier from the overflow seal.

Confirm each condenser spray is open. Shut one or

<b>KW</b>	<b>PAN STILL CONTINUOUS OPERATIONS</b>	KWI-RPR-102
		Revision 1 Issue Date: May 27, 2011
		Page 5 of 7
Pocatello, Idaho		
Authorized by: KW - Tim Whiteus, Wade Keller, Rhodia – Cam Balentine		

more sprays off and confirm with P-1011 pressure gauge.

Confirm the fresh water makeup valve is closed. Confirm the 1" bypass valve around the fresh water makeup valve is closed.

Confirm water flow thru the eductor. PI-1003 should read a negative pressure. Flow can be confirmed by reading PR-1003 on the data logger.

**OPERATIONS NOTE: Do not start furnace until system water temperatures are between 120 and 145 degrees F. Adjust heat blanket controls to maintain water temperatures between Test runs.**

**OPERATIONS NOTE: Complete the pre-startup check list prior to making the nitrogen system operational so as to not waste the nitrogen sweep gas.**

Prepare Nitrogen sweep gas system for operations

Open all nitrogen system valves. Record cylinder bulk pressure on summary data sheet. Adjust Pan Still rotometer to 1.5 acfm. Adjust agitator shaft seal rotometer to 0.5 acfm if the agitator has been installed. The rotometers provide nitrogen supply to two nitrogen heaters piped directly to the Pan Still lid. One N2 heater is connected to the PRV nozzle below the vent valve. A second N2 heater is piped into the agitator packing housing. Set the nitrogen heater controller to 500 F. NOTE: Flow must be started to the nitrogen heaters before energizing the heating controller or the heater elements will be destroyed.

Prepare Eductor scrubber system for operations

Adjust Eductor hand valve to maintain a slight (<0.50" WC) suction thru the Eductor. Balance this flow to create a static or slightly positive pressure on the vapor outlet line.

<b>KW</b>	<b>PAN STILL CONTINUOUS OPERATIONS</b>	KWI-RPR-102
		Revision 1 Issue Date: May 27, 2011
		Page 6 of 7
Pocatello, Idaho		Authorized by: KW - Tim Whiteus, Wade Keller. Rhodia – Cam Balentine

OPERATIONS NOTE: Operator to complete and note all required readings prior to energizing the furnace.

**Energize the Furnace**

Confirm the Eurotherm over temperature limit set point is at 1562 degrees F on the Honeywell over temperature controller. Manually adjust the Eurotherm controller set point to 700 degrees F. Hold the 700 F. set point until all water has been completely boiled off or 250 F. Raise the controller set point to 1200 F. thru the white P4 vaporization phase. Additional heat may be required to complete the red phosphorus vaporization phase of the Test. Continue to increase the temperature following the heat and hold schedule provided. Record system temperatures and pressures on the Operator Log every 30 minutes after energizing the furnace.

Critical Operating Parameters: Water temperatures should be maintained between 120 and 145 degrees F. The Pan Still should be operated between 0.50" WC and 1.0" WC as measured on the Vapor outlet line.

**De-Energize the Furnace**

Determining when a Test run is completed should be made by a qualified operator and/or supervision. Several factors can enter into making the decision to terminate a Test run including a flame or P2O5 plume at vapor valve, declining vapor line temperatures and/or Still temperatures rising to match the furnace temperatures.

On the Batch Summary Data Sheet record the time the furnace was de-energized and the Kilowatt Hour meter reading. Final instrumentation readings should be taken and recorded on the Operator Log.

Continue the heated nitrogen sweep on the Pan Still and agitator packing for 10-20 minutes.

Close the vapor outlet line plug valve and turn off all nitrogen system valves and the nitrogen heater. Monitor the 0-100" WC gauge attached to the Pan Still

<b>KW</b>	<b>PAN STILL CONTINUOUS OPERATIONS</b>	KWI-RPR-102
		Revision 1 Issue Date: May 27, 2011
		Page 7 of 7
Pocatello, Idaho		Authorized by: KW - Tim Whiteus, Wade Keller. Rhodia – Cam Balentine

lid. The Pan Still should not be building significant pressure. Open the 2" pressure relief valve if more than 90" WC registers on the Pan Still lid pressure gauge. The 2" PRV should be opened only enough to release excess pressure and should be closed to determine if pressure continues to build. Repeat as often as necessary to eliminate excess pressure.

**CAUTION**

If the pressure relief valve and line are used to release pressure from the Pan Still the entire line will require a hot water washout before reuse.

<b>KW</b>	<b>LOAD CLARIFIER MATERIAL INTO PAN STILL. INSTALL LID AND AGITATOR ASSEMBLY AND PREPARE FOR TEST RUN</b>	KWI-RPR-101
		Revision 1 Issue Date: 5/27/2011
		Page 1 of 5
Pocatello, Idaho		Authorized by: KW - Tim Whiteus, Wade Keller. Rhodia - Cam Balentine

<b>SCOPE</b>	This procedure describes the steps for loading phosphorus sludge material from the existing clarifier into the Pan Still and preparing it to be processed.
<b>RESPONSIBILITIES</b>	All operators, administrative support and other qualified personnel are responsible for this procedure.
<b>REQUIREMENTS</b>	The operators are required to complete these steps in a safe and efficient manner to assure quality representative samples and data points are obtained for each batch run.
<b>RELEVANT DOCUMENTS</b>	Individual equipment operating manuals. Project specific operating procedures. Rhodia site specific contingency plan.
<b>MATERIALS AND EQUIPMENT</b>	The special equipment required for this procedure includes: <ul style="list-style-type: none"> <li>• All-Terrain Forklift – Long reach capability preferred.</li> <li>• Drum dumper – 800 lb. capacity minimum, chain operated dumping mechanism.</li> <li>• Large platform, steel pallet scale, 2000 lb. minimum capacity.</li> <li>• E-201 Pan Still</li> </ul>
<b>SAFETY, HEALTH AND ENVIRONMENT</b>	The following protective equipment is required: Preparation, equipment checks and staging of equipment can be performed utilizing Level D personnel protection: <ul style="list-style-type: none"> <li>• OSHA approved hard hat</li> <li>• OSHA approved vision protection</li> <li>• OSHA approved steel toe safety shoes</li> <li>• Long sleeve shirt</li> <li>• Leather gloves, as required</li> <li>• Respiratory protection as required</li> <li>• Hearing protection as required</li> </ul>
<b>QUALITY</b>	This is a critical operation to effectively obtain accurate information relating to the recovery of phosphorus from contaminated clarifier solids.

<b>KW</b>	<b>LOAD CLARIFIER MATERIAL INTO PAN STILL. INSTALL LID AND AGITATOR ASSEMBLY AND PREPARE FOR TEST RUN</b>	KWI-RPR-101
		Revision 1 Issue Date: 5/27/2011
		Page 2 of 5
Authorized by: KW - Tim Whiteus, Wade Keller. Rhodia - Cam Balentine		

### PROCEDURE

Inspect and stage all required equipment. Confirm utilities and safety systems are operational as required. Place the Pan Still, fill with clarifier material and stage for processing.

**CAUTION**

Aluminum gear is to be worn anytime personnel are working around the material or equipment potentially contaminated with P4. An exception to the standard P4 specific PPE has been approved for this project. Steel toe leather boots may be substituted for rubber boots when working around equipment or material potentially contaminated with P4. Note: Forklift operator is not required to wear aluminum jacket when operating excavator.

Complete equipment checks on mobile equipment per operating manuals supplied by the vendor.

Confirm the safety shower is charged and operational.

Provide a charged water hose to the clarifier sample drum location. Provide a charged fire hose to a nearby location for additional washing or fire fighting capabilities. Provide a fire extinguisher to a nearby site.

Locate safety candles to create an exclusion zone. No one is to be inside the exclusion zone without authorization from the lead operator. All personnel inside the exclusion zone are to be wearing the appropriate PPE.

Confirm at least one operator within the exclusion zone is in possession of a calibrated PH3 monitor. A calibrated PH3 monitor is to be located in the furnace area and in the control room.



<b>KW</b>	<b>LOAD CLARIFIER MATERIAL INTO PAN STILL. INSTALL LID AND AGITATOR ASSEMBLY AND PREPARE FOR TEST RUN</b>	KWI-RPR-101
		Revision 1 Issue Date: 5/27/2011
		Page 3 of 5
Authorized by: KW - Tim Whiteus, Wade Keller. Rhodia - Cam Balentine		

Select a suitable pallet. Place the large drum scale on the pallet. Place the small containment pan on the scale. The containment pan will collect any clarifier material or wash water that is spilled while charging the Still.

Attach two 3/8" wire rope slings to the Pan Still support plate pad eyes. Place the Pan Still inside the containment pan on top of the pallet scale. Remove the wire rope slings before filling the Pan Still.

**NOTE:** All material removed from the clarifier is tracked by Sample Drum number and weight. A chain of custody form has been created to track the material being processed. It is important to understand the material balance, phosphorus, water and residue from each Test run so all weights should be carefully recorded.

While water is necessary to prevent burning in the Sample Drum and Pan Still, excess water increases power cost and processing time. Decant free water from the Sample Drum until the clarifier material is clearly visible but enough water remains to eliminate burning. Decanted water should be placed in a separate drum used for process water collection and returned to the clarifier after weights are recorded.

Place the gasoline powered agitator in the Sample Drum. Slowly rotate the agitator around the Sample Drum until all material is thoroughly mixed. Remove the agitator and place it in the process water drum. Rinse the exposed flights of the agitator to eliminate burning.

Attach the drum turning device to the forklift. Tighten the T-bolts to securely attach the drum rotator to the forks. Attach a come-a-long from the drum rotator to the forklift carriage. Tighten the come-a-long until there is no slack in the cable. Carefully connect the drum rotator to the Sample Drum. Place the Sample Drum over the edge of

<b>KW</b>  Pocatello, Idaho	<b>LOAD CLARIFIER MATERIAL INTO  PAN STILL. INSTALL LID AND  AGITATOR ASSEMBLY AND  PREPARE FOR TEST RUN</b>	KWI-RPR-101
		Revision 1 Issue Date: 5/27/2011
		Page 4 of 5
Authorized by: KW - Tim Whiteus, Wade Keller. Rhodia - Cam Balentine		

the Pan Still. Rotate the Sample Drum slowly, pouring clarifier material into the Pan Still while noting the weight of the material transferred. When the desired quantity of clarifier material has been transferred, rotate the Sample Drum back to the vertical position. Rinse the Sample Drum interior to remove any clarifier material.

Rinse the Pan Still exterior and bottom plate to remove any contaminated material. Leave enough water in the Pan Still to eliminate the potential for the clarifier material to burn.

All equipment used to obtain the clarifier sample should be re-inspected for contaminated material.

All water and material collected during this procedure should be drained or deposited into the clarifier. If contaminated material is spilled on the ground, it should be collected with a shovel and returned to the clarifier.

Install the Pan Still cover and agitator assembly

Locate and stage tools, bolts, nuts, flat washers and gaskets. Transport the loaded Pan Still to the process pad.

**CAUTION.** When handling the Pan Still lid and agitator assembly. The agitator packing is a long delivery item and easily damaged. The combined weight of the domed lid, agitator, agitator packing and isolation valves is approximately 700 pounds.

Attach two 3/8" slings to the pad eyes on the Pan Still cover. Before lowering the cover and agitator assembly into the Pan Still the sealing gasket must be in place. Install 2, 1-1/4" alignment pins in the Pan Still mounting plate. Alignment pins will center the agitator in the Pan Still. Using the forklift, lower the cover and agitator assembly into the Pan Still. If the agitator blades do not penetrate the clarifier material with its own weight, wiggle the assembly by hand to force the agitator thru the clarifier material. If the agitator still does not penetrate the clarifier material and the gap is less than 2", the 1-1/4" cover bolts may be installed and tightened to force the agitator thru the clarifier material. Use necessary

<b>KW</b>	<b>LOAD CLARIFIER MATERIAL INTO PAN STILL. INSTALL LID AND AGITATOR ASSEMBLY AND PREPARE FOR TEST RUN</b>	KWI-RPR-101
		Revision 1 Issue Date: 5/27/2011
		Page 5 of 5
Pocatello, Idaho		Authorized by: KW - Tim Whiteus, Wade Keller. Rhodia - Cam Balentine

caution not to damage the sealing gasket.

Remove the alignment pins. Install 20, 1-1/4" bolts with 2 flat washers each and nuts. Bolts may be tightened to hand tight using an electric impact wrench. Torque all bolts to 500 foot pounds in 250 foot pound increments. Starting at 4 locations 90 degrees apart, tighten all bolts equally, north and south then west and east. Move to the next bolt to the left at each location and repeat the tightening sequence. After all bolts are hand tight repeat the sequence using the torque wrench set to 250 foot pounds. Repeat the tightening sequence again to 500 foot pounds.

Weigh the Still and Lid assembly with material. Record the gross weight for comparison to the post test weight. Leave 3/8" wire rope slings attached while weighing. Record the total combined weight on the Batch Summary Log Sheet. Transport Pan Still and cover assembly back to the process pad. Stage the Pan Still and cover assembly next to the furnace.

Open the 2" Vapor line valve and the 2" PRV valve. Leave valves open until rigging the Pan Still for furnace installation.



## Clarifier Bulk Sampling Process

### Preliminary work

Move portable safety shower from decontamination pad to sample site

Run potable water to sample site. Need manifold with 2 outlets minimum

Confirm a charged fire extinguisher is available at the site.

Full P4 safety gear is required for this task.

- Fire Repellant Suit
- Hard Hat with Face Shield
- Rubber Gloves
- Rubber Boots
- Personal Phosphine Monitor

Confirm PH3 personal monitors functions correctly

Complete all equipment checklists

Select a suitable pallet. Place the drum scale on the pallet. Manually place a 55 gallon drum into the drum pan. The drum pan will collect any clarifier material that is spilled during sample collection. Move sample drum assembly to one of the clarifier sample locations. Zero the scale and log the combined weight of the 55 gallon sample drum and drum containment pan.

Obtain 350-400 pound clarifier material bulk sample (approx. 4 cubic feet or 18" depth in 55 gallon drum)

### Clarifier Sampling Plan

Samples will be taken from the Clarifier at three locations and three depths below the water level. The approximate sample depths will be 4'-0, 8'-0 and 12'-0 below the water level. Because twelve drums of Clarifier material are required for the testing program, an additional sample will be taken at selected locations by rotating the excavator forty-five degrees clockwise. At the West location a fourth and fifth sample will be taken at the 4'-0 and 12'-0 depths. At the Southeast location the fourth sample will be taken at the 8'-0 depth.

Clarifier sample locations.

SE-1. Southeast Clarifier Location. – Southeast side of the clarifier near process pad at ~4'-0 below water level. (estimated to be <30% P4)

SE-2. Southeast Clarifier Location - Southeast side of the clarifier near process pad at ~8'-0 below water level. (estimated to be 30-60% P4)

SE-3. Southeast Clarifier Location – Southeast side of the clarifier near process pad at ~12'-0 below water level. (estimated to be >60% P4)  
SE-4. Southeast Clarifier Location + 45 degrees clockwise rotation – Southeast side of the clarifier near the process pad at ~8'-0 below water level. (estimated to be 30-60% P4)

NE-1. Northeast Clarifier Location – Northeast side of the clarifier opposite the process pad at ~4'-0 below water level. (estimated to be <30% P4)  
NE-2. Northeast Clarifier Location - Northeast side of the clarifier opposite the process pad at ~8'-0 below water level. (estimated to be 30-60% P4)  
NE-3. Northeast Clarifier Location – Northeast side of the clarifier opposite the process pad at ~12'-0 below water level. (estimated to be >60% P4)

W-1. West Clarifier Location – West side of the clarifier just south of the monitoring station at ~4'-0 below water level. (estimated to be <30% P4)  
W-2. West Clarifier Location - West side of the clarifier just south of the monitoring station at ~8'-0 below water level. (estimated to be 30-60% P4)  
W-3. West Clarifier Location – West side of the clarifier just south of the monitoring station ~12'-0 below water level. (estimated to be >60% P4)  
W-4. West Clarifier Location + 45 degrees rotation – West side of the clarifier just south of the monitoring station ~4'-0 below water level. (estimated to be <30% P4)  
W-5. West Clarifier Location + 45 degrees rotation – West side of the clarifier just south of the monitoring station ~12'-0 below water level. (estimated to be >60% P4)

Stage Excavator (CAT 320) at the sample location. Dig sample material from clarifier. Twelve (12) 55 gallon sample drums will be filled with 350-400 pounds of clarifier material. Manually shovel clarifier material from the excavator bucket into the sample drum until the desired weight is displayed on the drum scale. Record the weight of the clarifier material collected on the Drum Log. Additional water may be added to ensure an adequate water cover is provide. Excess water will be decanted during the laboratory sampling process.

Laboratory analysis will confirm which drum of clarifier material will be used for each specific test. Some sample drums may be used for multiple tests.

After each drum of the clarifier material sample has been collected, attach a lid and securing ring on the drum. Using the forklift and drum lifter, raise the filled sample drum for exterior cleaning. (Sampling Procedure). Relocate filled sample drum to the decontamination pad for temporary storage. Continue clarifier sampling until all twelve sample drums contain a 350-400 pound bulk sample of clarifier material.

Collect two 10 mg individual samples from each drum of clarifier bulk sample material.

For efficiency, the analytical samples may be taken one or more days after the bulk sample has been collected.

The analytical samples must be taken from a homogenous completely mixed bulk clarifier sample. If necessary the individual sample drums can be heated with a drum band heater (2 provided). A drum agitator will be provided to ensure a homogenous mixture of the clarifier material is provided for the analytical sample. Using a long handle ladle, a wide mouth sample container will be filled to a predetermined level. Each sample container will be labeled by date the sample was taken, drum number and sample number (Drum1-Sample1, Drum1-Sample2, etc). Completed analytical samples will be stored in a designated, secure location until laboratory analysis can be completed.

Laboratory analysis will be completed per The Standard Operating Procedure for Elemental Phosphorus/Toluene Insolubles

#### Cleanup and Decontamination

After the bulk sampling activities are completed, all equipment used in the process will be completely cleaned over the decontamination pan or clarifier. All residue and wash water will be returned to the clarifier per the Waste Plan.

## **7.4 Waste Plan**

**WASTE PLAN  
100 FOOT CLARIFIER PILOT PROJECT  
ADMINISTRATIVE ORDER § 7003  
DOCKET NO. RCRA-8-2000-07**

**Rhodia Silver Bow Plant  
Butte, Montana**

**August 26, 2010**



# Design Waste Plan 100 Foot Clarifier Pilot Project

## Table of Contents

1.0 Introduction.....	1
1.1 Waste Plan Activities.....	1

# 1.0 Introduction

---

Pursuant to the RCRA §7003 Administrative Order in Docket No. RCRA-8-2000-07, the Corrective Action Order on Consent in Docket to RCRA-08-2004-0001,<sup>1</sup> Rhodia Inc. (“Rhodia”) is pleased to present this Design Waste Plan to EPA regarding the 100 Foot Clarifier Pilot Project at Rhodia’s Silver Bow Plant, near Butte, Montana. This Waste Plan summarizes the proposed activities related to inspecting all of the waste materials in the 100 Foot Clarifier Pilot Project.

## 1.1 Waste Plan Activities

The following tasks are proposed:

- Empty the each “batch” of residue from the Clarifier Pilot Project still to a metal plate or container after the phosphorus vaporization process is complete.
- Inspect each processed “batch” of processed clarifier material from the Pilot Project for evidence of smoking or igniting elemental phosphorus.

---

<sup>1</sup> Section XX of the 3008(h) Corrective Action Order on Consent provides:

“XX. *Other Applicable Laws.*

*The Parties recognize and agree that the storage, treatment or disposal of any hazardous waste at the Facility may continue under this Order and the 7003 Order without Respondent having to meet applicable hazardous waste management standards or obtain a hazardous waste management permit, and Respondent shall not be deemed out-of-compliance with any applicable law or regulation relating to hazardous waste, including the requirement to obtain a hazardous waste permit, provided Respondent is otherwise in compliance with this Order ....”*

This provision allows the storage, treatment and disposal of the clarifier materials to be done in a manner that is considered protective by EPA, but not necessarily in accordance with hazardous waste management requirements. Similarly, RCRA §7003, which is the authority for the Order regarding the clarifier, begins “*Notwithstanding any other provision of this Chapter ....”* This clause has been interpreted by EPA to allow management of waste in a protective fashion but not necessarily in accordance with all hazardous waste management requirements.

- If no smoke or flame is observed in the “batch”, apply a flame to the residue for several minutes and observe for smoke and flame. If smoke or fire are present, return the residue material to the 100 Foot Clarifier.
- If no smoke or fire is observed in the residue material, collect a sample for TCLP analysis, and containerize the material in a 30 gallon drum, label and seal the drum, and store on the concrete Hazardous Waste Storage Pad.
- If the residue material fails the TCLP metals<sup>2</sup> analysis, arrange for off-site transportation and disposal. If the residue material passes the TCLP analysis, the residue will be dumped in the existing Roaster residue area.
- Clarifier material that is spilled on the ground or in the pan underneath the hopper used to fill the stainless steel still during the still loading procedure will be returned to the 100 foot clarifier. Excess water will be returned to the clarifier.
- Elemental Phosphorus recovered during the Pilot test will be returned to the clarifier.

---

<sup>2</sup> TCLP Metals includes: Arsenic, Barium, Cadmium, Chromium, Lead, Mercury, Selenium, & Silver.

## **7.5 Clarifier Material Summary**

2011 Rhodia Phosphorus Recovery Pilot Project  
Clarifier Material Summary

Test Data					Laboratory Sample Summary										
Date	Test No.	Drum	Chg Wt.	Agitated	% P4 - Lab Analysis vs. Actual Test %		% Water - Lab Analysis vs. Actual Test %		% Residue - Lab Analysis vs. Actual Test %		% P4 to Residue - Lab Analysis vs. Actual Test %		Location	Depth	Sample
6/15/2011	1	12	178.8	Yes	27.0%	29.0%	55.2%	50.4%	17.8%	20.6%	60.3%	58.5%	Northeast	12'	A2
6/21/2011	2	5	175.4	No	27.9%	25.6%	50.0%	37.2%	22.1%	37.3%	55.8%	40.8%	West - B	4'	B
6/23/2011	3	5	176.4	Yes	27.9%	30.4%	50.0%	42.3%	22.1%	27.3%	55.8%	52.7%	West - B	4'	B
6/28/2011	4	7	248.0	Yes	41.5%	37.8%	41.3%	42.9%	17.2%	19.3%	70.7%	66.2%	Southeast	4'	A
7/12/2011	5	8	346.8	Yes	34.2%	41.1%	46.3%	40.4%	19.5%	18.5%	63.6%	69.0%	Southeast	8'	A
7/19/2011	6	10	347.7	No	33.0%	29.6%	45.9%	41.9%	21.1%	28.5%	60.9%	50.9%	Southeast	8'	A
7/26/2011	7	7	253.0	Yes	41.5%	44.3%	41.3%	38.2%	17.2%	17.4%	70.7%	71.8%	Southeast	4'	A
7/28/2011	8	11	362.0	Yes	24.7%	30.0%	55.0%	42.7%	20.3%	27.3%	54.9%	52.4%	Northeast	8'	A
8/9/2011	9	1	247.0	No	31.1%	22.6%	43.3%	51.5%	25.6%	25.9%	54.8%	46.6%	Northeast	4'	A
8/16/2011	10	9	248.1	No	30.2%	31.6%	47.3%	43.5%	22.4%	24.9%	57.4%	56.0%	Southeast	12'	A
8/23/2011	11	3	253.0	No	37.0%	13.9%	39.7%	66.1%	23.3%	20.0%	61.4%	41.0%	West	8'	A
8/25/2011	12	2	249.0	Yes	34.8%	32.7%	43.8%	48.4%	21.4%	19.0%	61.9%	63.2%	West	4'	A

Total Clarifier Material Processed 3,085.2

Sample Drums No.4 and No.6 were not used for Tests. The material in these drums was returned to the clarifier.

6	31.8%	45.5%	22.7%	58.3%	West - B	12	A
4	31.9%	48.1%	20.0%	61.5%	West	12'	A

## **7.6 Operator Log Sheets and Test Run Notes**

**TEST 1**

**OPERATOR LOG SHEETS**

**2011 Rhodia Phosphorus**

---

**Recovery Pilot Project**

## Time in 30 minute increments (max)

<b>Pan Still</b>	Inst Tag No.	13:00	13:30	14:00	14:30	15:00	15:30	16:00	16:30
Furnace Controller Temperature (L)	EuroTherm	691	709	698	704	704	693	941	983
Still Temperature (R)	Agitator	127	197	213	213	213	213	213	219
Vapor Outlet Temperature (R)	104	198	200	200	200	200	200	205	208
Vapor Outlet Pressure (R)	PR-1002	0.49	0.30	0.32	0.30	0.24	0.33	0.46	0.52
<b>Condenser</b>	Inst Tag No.	Time in 30 minute increments (max)							
Condenser Overflow Temp (R)	TR-1007	99	110	116	118	118	115	129	131
Condenser Outlet Temp (R)	TR-1012	77	84	77	76	73	70	85	87
Eductor Inlet Pressure (R)	PR-1003	-0.61	-0.79	-0.84	-0.81	-0.95	-1.31	-1.18	-1.04
<b>Water Circulation System</b>	Inst Tag No.	Time in 30 minute increments (max)							
Condenser Spray Pressure (L)	PI-1011	26	28	28	28	28	28	28	28
Condenser Spray Temp. ( R )	TR-1004	Not functioning correctly							
Eductor Water Pressure (L)	PI-1010	15	12	12	12	12	12	12	12
Recirc Pump Outlet Pressure (L)	PI-1009	30	30	30	30	30	30	30	30
Recirc Pump VFD Hertz (R)	SIC-1008	35	35	35	35	35	35	35	35
<b>Miscellaneous</b>	Inst Tag No.	Time in 30 minute increments (max)							
Overpak Drum Water Temp (L)	TC-1006	108	108	110	124	123	121	118	118
Recirc Tank Water Temp (L)		109	123	145	129	129	127	128	139
KWH Meter Reading (L)		67.4	88.1	91.3	97	99.8	103.7	115.5	121.8
PH / PH3 / Misc (L)									

Notes: Overflow began at 13:15. Still temperature 191



Time in 30 minute increments (max)

<b>Pan Still</b>	Inst Tag No.	17:00	17:30	18:00	18:30	19:00	19:30	20:00	20:30
Furnace Controller Temperature (L)	EuroTherm	1062	1160	1198	1234			1352	1311
Still Temperature (R)	Agitator	423	539	574	574			677	860
Vapor Outlet Temperature (R)	104	204	227	438	448			419	370
Vapor Outlet Pressure (R)	PR-1002	0.34	0.38	0.31	0.30			0.49	0.46
<b>Condenser</b>	Inst Tag No.	Time in 30 minute increments (max)							
Condenser Overflow Temp (R)	TR-1007	117	110	99	104			100	100
Condenser Outlet Temp (R)	TR-1012	82	79	70	68			73	71
Eductor Inlet Pressure (R)	PR-1003	-1.20	-1.23	-1.13	-1.27			-1.27	-1.47
<b>Water Circulation System</b>	Inst Tag No.	Time in 30 minute increments (max)							
Condenser Spray Pressure (L)	PI-1011	28	28	28	28			28	26
Condenser Spray Temp. ( R )	TR-1004	Not functioning correctly							
Eductor Water Pressure (L)	PI-1010	12	12	12	12			16	11
Recirc Pump Outlet Pressure (L)	PI-1009	30	30	30	30			30	30
Recirc Pump VFD Hertz (R)	SIC-1008	35	35	35	35			35	35
<b>Miscellaneous</b>	Inst Tag No.	Time in 30 minute increments (max)							
Overpak Drum Water Temp (L)	TC-1006	117	116	114	114			110	111
Recirc Tank Water Temp (L)		134	128	119	112			134	122
KWH Meter Reading (L)		138	143	154	160			183	193
PH / PH3 / Misc (L)									

Notes: High/High water level instrumentation malfunction at ~19:00.

Material Balance Summary in pounds. Sub = by subtraction

	Lab Analysis	Scale Weights
P4	sub 48.3	51.8
H2O	98.7	sub 90.1
Res	31.8	36.9

Observations: First test of the 2011 testing program. 178.8 pounds of clarifier material was loaded in the Still, basically a half batch. Projected to be 55% water and 60% P4 to solids ratio. Test 1 used the internal Still agitator. Water overflow started with the first hour of run time at a Still temperature of ~190. Experienced a high water level alarm in the condenser near the end of the test. Opened the PRV and completed system checks for water levels in the condenser. Water levels proved to be within the normal operating range. Condenser overflow water temperatures had dropped to 100 F. (condenser outlet around 70 F.). Condenser spray water temperature thermocouple not sending a signal. Probable connection to high level alarm being triggered by condenser spray water colder than normal operating temperature. Performed a vapor line test at 20:25 with significant flame and smoke. No flame or smoke from the vapor line at 20:50 and the vapor line temperature was consistently dropping. After shutoff, pressure in the Still raised to 80" w.c., vented the furnace thru the PRV and left the valve slightly open overnight. Still temperature was 412 at 06:30 the next morning. pH of condenser water at the end of the test = 4. Very little P4 collected in TK-100.

Residue: Condensed Phos acid burned when the Still lid was removed. The Phos acid was concentrated at the Still to lid gasket interface. The Still lid is heat traced with a thermon insulating cement coating. Castable refractory is scheduled to be installed over the heat tracing before Test 2. Residue is light gray in color and light weight similar to fly ash. There was an orange band of residue 6-8" around the Still circumference just below the lid to gasket interface. This layer of material has streaks of yellow at several locations within the orange material. (Digital pictures included).

High Temperature Residue. The following notes are provided by Kevin Ryan, consultant to Rhodia, who is assisting with the Tests.

By ~14:30 this afternoon (Jun 16th) the still from yesterdays test run had been removed and was opened. The residue at the bottom of the still was black/dark grey and did not ignite spontaneously. Also, an inch or more of residue was attached to the agitator and did not burn when the cover was pulled. We estimated that there were about 6 inches of residue spread unevenly throughout the bottom of the still. In order to assess whether or

not there was any sign of yellow or red phosphorus associated with the residue, we took a small sample and ran a flame over it. The sample did not ignite, suggesting that the phenomenon causing the rise in temperature of the residue does not appear to be phosphorus initiated.

After ~1.5 hours, the sample temperature probe within the isolated sample pan indicated 350 F. After 2 hours, the temperature probe within the isolated sample pan registered ~150 degrees F and the sides of the pan appeared cool to touch. However, when the thermocouple was removed and placed in another part of the pan - which causes some agitation - the thermocouple temperature rose to ~210 degrees.

Other than the curious result above, the main observation from the opening of the still was that the top 6" of the still had a thin red/orange crust of oxyacid with perhaps some Red phosphorus. We speculated that this may have been caused by condensation of some P4 near the top of the still and then subsequent conversion

There was an odor of perhaps phosphine, or sulphide, or some other emission. The Drager tube tests did confirm that there were phosphine emissions from the still residue and appropriate precautions were taken.

The temperature probe that we inserted into the residue indicated 191 degrees F. We collected an ~3 lb sample of the residue in a SS pan and inserted a smaller thermometer in it. We observed that the temperature of the residue continued to rise in the area of the thermocouple to >450 degrees F - local to the thermocouple! There appeared to be an exothermic reaction taking place within the residue. We isolated the sample and stored the SS container securely within a larger drum. The remainder of the residue we washed back into the clarifier.

**TEST 2**  
**OPERATOR LOG SHEETS**  
**2011 Rhodia Phosphorus**  

---

**Recovery Pilot Project**



## Time in 30 minute increments (max)

<b>Pan Still</b>	Inst Tag No.	8:00	8:30	9:00	9:30	10:00	10:30	11:00	11:30
Furnace Controller Temperature (L)	EuroTherm	96	615	687	710	714	701	821	965
Still T/C Temperature	Still	90.0	130.6	215.5	216.0	215.1	219.7	226.2	265.0
Vapor Outlet Temperature (R)	TR-1000	374	321	291	292	305	324	332	345
Vapor Outlet Pressure (R)	PR-1002	0.22	0.14	0.55	0.29	0.40	0.43	0.42	0.55
<b>Condenser</b>	Inst Tag No.	Time in 30 minute increments (max)							
Condenser Overflow Temp (R)	TR-1007	139	149	178	171	153	137	130	132
Condenser Outlet Temp (R)	TR-1012	126	149	115	154	137	124	115	121
Eductor Inlet Pressure (R)	PR-1003	-1.47	1.22	-0.12	1.38	-0.57	-0.61	-0.67	-0.57
<b>Water Circulation System</b>	Inst Tag No.	Time in 30 minute increments (max)							
Condenser Spray Pressure (L)	PI-1011	24	24	24	25	26	26	26	26
Condenser Spray Temp. ( R )	TR-1004	NOT READING							
Eductor Water Pressure (L)	PI-1010	18	21	7.5	12	7	7	14	14
Recirc Pump Outlet Pressure (L)	PI-1009	30	30	29	30	30	30	30	30
Recirc Pump VFD Hertz (R)	SIC-1008	35	35	35	35	35	35	35	35
<b>Miscellaneous</b>	Inst Tag No.	Time in 30 minute increments (max)							
Overpak Drum Water Temp (L)	TC-1006	79.2	81.3	84.2	85.6	88.0	90.1	92.1	94.3
Recirc Tank Water Temp (L)		151.9	152.2	169.3	160.9	137.8	142.7	133.5	135.0
KWH Meter Reading (L)		195.7	209.5	218.7	224.0	229.0	233.4	238.0	248.0
PH / PH3 / Misc (L)							+1000 ppm		
Notes / Comments	Furnace Raised to 1200F @ 11:00a								

## Time in 30 minute increments (max)

<b>Pan Still</b>	Inst Tag No.	12:00	12:30	13:00	13:30	14:00	14:30	15:00	15:30
Furnace Controller Temperature (L)	EuroTherm	1115	1207	1226	1239	1264	1270	1267	1253
Still T/C Temperature	Still	452.4	656.0	825.0	942.0	992.4	1095.0	1120.0	1128.0
Vapor Outlet Temperature (R)	TR-1000	374	390	396	400	394	391	385	369
Vapor Outlet Pressure (R)	PR-1002	0.46	0.22	0.33	0.20	0.21	0.19	0.15	0.21
<b>Condenser</b>	Inst Tag No.	Time in 30 minute increments (max)							
Condenser Overflow Temp (R)	TR-1007	136	128	130	124	121	117	118	116
Condenser Outlet Temp (R)	TR-1012	121	119	108	110	109	105	105	102
Eductor Inlet Pressure (R)	PR-1003	-0.63	-0.97	-0.72	-1.15	-1.04	-1.12	-1.16	-1.17
<b>Water Circulation System</b>	Inst Tag No.	Time in 30 minute increments (max)							
Condenser Spray Pressure (L)	PI-1011	26.0	26.0	26.0	27.0	25.5	26.5	27.0	27.0
Condenser Spray Temp. ( R )	TR-1004	NOT READING							
Eductor Water Pressure (L)	PI-1010	17	19	16	16	16.5	16	16	16
Recirc Pump Outlet Pressure (L)	PI-1009	30	30	30	30	30	30	30	30
Recirc Pump VFD Hertz (R)	SIC-1008	35	35	35	35	35	35	35	35
<b>Miscellaneous</b>	Inst Tag No.	Time in 30 minute increments (max)							
Overpak Drum Water Temp (L)	TC-1006	95	97	99	101	103	104	100	102
Recirc Tank Water Temp (L)		136.4	134	131	128	125	124	124	126
KWH Meter Reading (L)		255.6	262	268	272	276	280.9	283	287
PH / PH3 / Misc (L)		+1000 ppm		+1000 ppm	+1000 ppm				17 ppm
Notes / Comments	12:15 Still Temp 548 - Pumped 40 lbs of overflow water								
	Raised furnace temperature to 1250 @ 14:43 and to 1300 @ 15:40								
	15:20 Still Temp 1123 - Pumped 56 lbs of overflow water								



## Time in 30 minute increments (max)

<b>Pan Still</b>	Inst Tag No.	16:00	16:30	17:00	17:30				
Furnace Controller Temperature (L)	EuroTherm	1276	1291	1296	0				
Still T/C Temperature	Still	1140	1173	1191	1161				
Vapor Outlet Temperature (R)	TR-1000	360	352	339	0.273				
Vapor Outlet Pressure (R)	PR-1002	0.18	0.23	0.26	0.03				
<b>Condenser</b>	Inst Tag No.	Time in 30 minute increments (max)							
Condenser Overflow Temp (R)	TR-1007	116	114	117	111				
Condenser Outlet Temp (R)	TR-1012	101	89	98	84				
Eductor Inlet Pressure (R)	PR-1003	-1.25	-1.77	-1.28	1.30				
<b>Water Circulation System</b>	Inst Tag No.	Time in 30 minute increments (max)							
Condenser Spray Pressure (L)	PI-1011	27	27	27	27				
Condenser Spray Temp. ( R )	TR-1004	NOT READING							
Eductor Water Pressure (L)	PI-1010	17	8	15	11				
Recirc Pump Outlet Pressure (L)	PI-1009	30	30	30	30				
Recirc Pump VFD Hertz (R)	SIC-1008	35	35	35	35				
<b>Miscellaneous</b>	Inst Tag No.	Time in 30 minute increments (max)							
Overpak Drum Water Temp (L)	TC-1006	103	105	109	129				
Recirc Tank Water Temp (L)		126	126	126	123				
KWH Meter Reading (L)		290	294	298	298.4				
PH / PH3 / Misc (L)		25 ppm	50 ppm	7 ppm	0 ppm				
Notes / Comments	OFF @ 17:00								

Material Balance Summary in pounds. Sub = by subtraction

	Lab Analysis	Scale Weights
P4	sub 48.9	44.8
H2O	87.9	sub 65.2
Res	38.8	65.4

Observations: Test 2 was not agitated. 175.4 pounds of clarifier material was loaded in the Still. Test 2 was intended to be a comparable duplication of Test 1 without agitation. The final quantity of residue was much higher than lab analysis indicated with a corresponding reduction in the quantity of water removed. Total run time was similar but the water and yellow P4 phases were significantly shorter. Completion of the test or RAP phase was four times as long as Test 1. Recycle water temperatures were elevated (150 F) to start the run and were difficult to control thru the water boil phase. High condenser spray temperatures may have contributed to the additional quantity of P4 found in the water recycle tank. The TCV does not appear to respond quick enough to maintain the water temperature within +/- 10 F of the 130 F set point. For subsequent tests, recycle water temperatures will start at 100-110 F to compensate for heat loading from the water boil phase. Significantly higher Still temperatures were required to complete the test. 1190 F vs. 860 F for Test 1. Vapor line temperatures at the end of test were inverse, 273 F vs. 370 F for Test 1. Recovered P4 quality for both tests was good with little dirt carry over. Phosphine levels exceeded 1000 ppm within an hour of startup. Water overflow was noted 45 minutes after startup at ~195 F Still temperature.

Residue: Phos acid around the Still lid to gasket interface was much less than Test 1. Possibly due to no agitation of the light weight residue. A light layer of P4 contaminated material around the upper perimeter generated a small amount of smoke and flames. The residue was crusted over, approximately 6-8 inches deep. There was no detectable phosphine. There were large nodules attached to the Still shell in the heated zone with white and red deposits in the unheated upper portion of the Still. The residue was field tested for ignitability and reactivity with negative results. Samples were taken for TCLP analysis.



**TEST 3**

**OPERATOR LOG SHEETS**

**2011 Rhodia Phosphorus**

---

**Recovery Pilot Project**

## Time in 30 minute increments (max)

<b>Pan Still</b>	Inst Tag No.	7:00	7:30	8:00	8:30	9:00	9:30	10:00	10:30
Furnace Controller Temperature (L)	EuroTherm	0	624	706	704	836	1007	1211	1200
Still T/C Temperature	Still	114	164	210	214	216	227	463.9	563
Vapor Outlet Temperature (R)	TR-1000	256	232	216	218	235	251	282	318
Vapor Outlet Pressure (R)	PR-1002	0.34	0.38	0.60	0.24	0.29	0.21	0.13	0.19
<b>Condenser</b>	Inst Tag No.	Time in 30 minute increments (max)							
Condenser Overflow Temp (R)	TR-1007	94	101	136	146	145	129	110	105
Condenser Outlet Temp (R)	TR-1012	79	80	89	100	104	92	88	86
Eductor Inlet Pressure (R)	PR-1003	-0.47	0.69	-0.49	-0.78	-0.65	-0.61	-0.81	-0.76
<b>Water Circulation System</b>	Inst Tag No.	Time in 30 minute increments (max)							
Condenser Spray Pressure (L)	PI-1011	25	25	25	25	26	26	26	26
Condenser Spray Temp. ( R )	TR-1004	NOT READING							
Eductor Water Pressure (L)	PI-1010	14	14	14	16	17	17	17	17
Recirc Pump Outlet Pressure (L)	PI-1009	30	30	30	30	30	30	30	30
Recirc Pump VFD Hertz (R)	SIC-1008	35	35	35	35	35	35	35	35
<b>Miscellaneous</b>	Inst Tag No.	Time in 30 minute increments (max)							
Overpak Drum Water Temp (L)	TC-1006	117	118	118	118	119	119	119	119
Recirc Tank Water Temp (L)		114	115	133	147	149	140	134	129
KWH Meter Reading (L)		298.4	311.5	321.2	331.1	339.9	351.4	363.6	268.7
PH / PH3 / Misc (L)		0 ppm				6 ppm		+1000 ppm	
Notes / Comments	Overflow @ 7:37 and 190      Turned off heat to recycle system @ 8:00 0:5cfm @ 7:30								
	Reduced N2 @ Still to 0.5 CFM    08:30 Furnace 700 to 1200    Changed N2 @ 09:30								





Test 3 Notes.

June 23, 2011

Material Balance Summary. Sub = by subtraction

Water Collection Method		Lab Analysis		Scale Weights	
P4	44.1	sub	49.2		53.6
H2O	69.0		88.2	sub	74.7
Res	63.3	sub	39.0		48.1

Observations: Test 3 was intended to mirror Test 2 with the addition of the Still agitator. Drum 5 clarifier material was used for both tests. 176.4 pounds of clarifier material was loaded in the Still (+1 pound from Test 1). Test 3 was very efficient. Run time was 7 hours vs. 9 hours for Test 2. kWh per pound charged was slightly less for Test 3 than Test 2 (0.53 vs. 0.58) and much less than Test 1 (0.53 vs. 0.71). Phosphorus recovered was granular and appeared to be contaminated with dirt. Phosphine readings were much lower throughout the test, exceeding 1000 ppm only once on regular reading cycles. Overflow water to the clarifier began at ~40 minutes after startup and 190 F Still temperature. Started collecting overflow water (when possible) as another method of verifying the P4/solids/water ratios in the clarifier material tested. Results from this test are included above.

Residue: A phos acid ring was again evident around the Still lid to gasket interface. For reference, this location is the weld joint attaching the Still vessel to the mounting plate. A beveled joint is created providing a cavity for accumulation of P4 contaminated material. Additionally, the upper section of the Still is not externally heated for the 2011 tests creating a 'cold' joint for condensing acid. The acid ring for Test 3 was darker indicating more contamination. No flame and only moderate smoke was observed when opening the Still. Part of the P2O5 smoke originated from phos acid in the Vapor line outlet duct. Residue remaining in the Still was ambient temperature with no detectable phosphine. Field ignitability and reactivity test were negative. Samples were taken for TCLP testing.

**TEST 4**

**OPERATOR LOG SHEETS**

**2011 Rhodia Phosphorus**

---

**Recovery Pilot Project**

Time in 30 minute increments (max)

<b>Pan Still</b>	Inst Tag No.	8:00	8:30	9:00	9:30	10:00	10:30	11:00	11:30
Furnace Controller Temperature (L)	Yokogawa	569	680	720	794	823	896	990	1090
Still T/C Temperature	Still	111	215	214	217	218	466	551	555
Vapor Outlet Temperature (R)	TR-1000	216	270	258	256	268	308	493	491
Vapor Outlet Pressure (R)	PR-1002	0.15	0.13	0.16	0.43	0.32	0.15	0.52	0.43
<b>Condenser</b>	Inst Tag No.	Time in 30 minute increments (max)							
Condenser Overflow Temp (R)	TR-1007	115	156	166	162	156	125	127	143
Condenser Outlet Temp (R)	TR-1012	93	118	136	128	120	100	103	115
Eductor Inlet Pressure (R)	PR-1003	-0.60	-0.79	-0.97	-0.74	-0.76	-0.60	-0.43	-0.44
<b>Water Circulation System</b>	Inst Tag No.	Time in 30 minute increments (max)							
Condenser Spray Pressure (L)	PI-1011	29	29	28	28	28	28	28	28
Condenser Spray Temp. ( R )	TR-1004	Instrument not sending data							
Eductor Water Pressure (L)	PI-1010	11	17	20	16	15	15	15	15
Recirc Pump Outlet Pressure (L)	PI-1009	30	30	30	30	30	30	30	30
Recirc Pump VFD Hertz (R)	SIC-1008	35	35	35	35	35	35	35	35
<b>Miscellaneous</b>	Inst Tag No.	Time in 30 minute increments (max)							
Overpak Drum Water Temp (L)	TC-1006	112	115	116	117	118	117	117	117
Recirc Tank Water Temp (L)		126	139	144	133	141	135	136	142
KWH Meter Reading (L)		399	410	422	432	444	456	466	474
PH / PH3 / Misc (L)			330 ppm		1000+		1000+		1000+

Notes / Comments: Not able to produce a flame at the vent stack

Time in 30 minute increments (max)

<b>Pan Still</b>	Inst Tag No.	12:00	12:30	1:00	1:30	2:00	2:15 Off	2:45	
Furnace Controller Temperature (L)	Yokogawa	1215	1231	1210	1223	1209	1223	Off	
Still T/C Temperature	Still	655	852	915	945	965	974	953	
Vapor Outlet Temperature (R)	TR-1000	440	396	372	360	353	354	292	
Vapor Outlet Pressure (R)	PR-1002	0.03	-0.016	0.14	0.21	0.47	0.14		
<b>Condenser</b>	Inst Tag No.	Time in 30 minute increments (max)							
Condenser Overflow Temp (R)	TR-1007	129	118	114	114	113	114	113	
Condenser Outlet Temp (R)	TR-1012	116	104	100	99	104	100	93	
Eductor Inlet Pressure (R)	PR-1003	-1.14	-1.44	-0.95	-0.92	-0.67	-1.01	-3.56	
<b>Water Circulation System</b>	Inst Tag No.	Time in 30 minute increments (max)							
Condenser Spray Pressure (L)	PI-1011	29	29	28	28	28	28	28	28
Condenser Spray Temp. ( R )	TR-1004	Instrument not sending data							
Eductor Water Pressure (L)	PI-1010	11	17	20	16	15	15	15	15
Recirc Pump Outlet Pressure (L)	PI-1009	30	30	30	30	30	30	30	30
Recirc Pump VFD Hertz (R)	SIC-1008	35	35	35	35	35	35	35	35
<b>Miscellaneous</b>	Inst Tag No.	Time in 30 minute increments (max)							
Overpak Drum Water Temp (L)	TC-1006	118	119	120	120	121	120	118	
Recirc Tank Water Temp (L)		140	132	128	126	124	125	124	
KWH Meter Reading (L)		482	488	490	493	495	496	496	
PH / PH3 / Misc (L)			450 ppm		74 ppm				

Notes / Comments: Not able to produce a flame at the vent stack



Test 4 Notes.

June 28, 2011

Material Balance Summary in pounds. Sub = by subtraction

Water Collection Method	Lab Analysis	Scale Weights
P4 96.66	sub 102.92	93.7
H2O 99.20	102.42	sub 106.5
Res 52.14 sub	42.65	47.8

Observations: The Still and residue had a very pungent odor similar to sulphur. PH3 was 2.09 ppm when the still was opened. Several of the pictures show traces of a yellow substance on the sidewalls and in the residue. The yellow substance would not burn or smoke. When stirred the residue temperature elevated from ambient (48) to almost 90. 4 hours later the residue temperature is slightly elevated at 77. The residue material was light and fluffy with a density of 35 lb/ft<sup>3</sup>. The residue from Test 4 was retained in a drum. Samples were taken for TCLP analysis.

Dust carryover. There was significant quantity of dust carried over from the Still to the condenser. Photos of agglomerated dust and ?? are included. Samples from the P4 collection drum also showed a significant dirt layer sitting on top of and attached to the P4. The recycle water drum contained a small quantity of fine granular material more orange in color. No P4 was detected in the recycle water drum. Retrieved a sample of the P4 from Test 3. There was a layer of granulated P4 on top of the the normal P4 cake. Photos attached.

System contamination. A dark orange/red sticky material was found in the vapor line at the condenser inlet and in the plug valve at the furnace nozzle. Previous experience indicates this material is caused by air leakage. All potential leak points including the packing were inspected and no problems were apparent.

Test 4 run. Other than some water temperature excursions during the water boil phase, the test was uneventful. Added almost one hundred gallons of makeup water to control the temperatures. Several vapor valve tests were conducted to determine the end point. In hindsight, the run probably needed to continue 30-60 minutes longer with maybe a 50-100 deg. F increase in temperature. Ran the entire test at 0.5 cfm 500 deg F N2 on the packing and Still. Never was able to ignite the vent stack and the PH3 was over 1000 ppm for several hours during the middle of the Test.

Test 5. Wednesday 6<sup>th</sup>. Drum 3. 250 lb agitated charge with the Still N2 at 1.5 cfm and packing at 0.5 cfm.

Graciously accepting all constructive input or suggestions.....Tim



**TEST 5**  
**OPERATOR LOG SHEETS**  
**2011 Rhodia Phosphorus**  

---

**Recovery Pilot Project**

Time in 30 minute increments (max)

<b>Pan Still</b>	Inst Tag No.	7:00	7:30	8:00	8:30	9:00	9:30	10:00	10:30
Furnace Controller Temperature (L)	Yokogawa	438	480	514	561	575	618	635	714
Still T/C Temperature	Still	90	97	215	214	216	221	280	478
Vapor Outlet Temperature (R)	TR-1000	342	327	288	235	236	240	257	294
Vapor Outlet Pressure (R)	PR-1002	0.81	0.99	1.36	1.5	-0.03	1.42	1.41	1.21
<b>Condenser</b>	Inst Tag No.	Time in 30 minute increments (max)							
Condenser Overflow Temp (R)	TR-1007	91	98	130	135	129	131	128	122
Condenser Outlet Temp (R)	TR-1012	62	67	91	96	81	70	91	88
Eductor Inlet Pressure (R)	PR-1003	-0.21	-0.02	-0.27	0.07	-1.36	-1.47	-0.17	-0.5
<b>Water Circulation System</b>	Inst Tag No.	Time in 30 minute increments (max)							
Condenser Spray Pressure (L)	PI-1011	29	29	29	26	38	31	28	44
Condenser Spray Temp. ( R )	TR-1004	No Signal							
Eductor Water Pressure (L)	PI-1010	27	27	0	0	7	0	6	3
Recirc Pump Outlet Pressure (L)	PI-1009	31	31	31	28	42	33	30	46
Recirc Pump VFD Hertz (R)	SIC-1008	35	35	35	35	42	38	35	45
<b>Miscellaneous</b>	Inst Tag No.	Time in 30 minute increments (max)							
Overpak Drum Water Temp (L)	TC-1006	123	123	124	124	125	125	125	126
Recirc Tank Water Temp (L)		97	100	111	122	106	121	112	123
KWH Meter Reading (L)		504	510	518	529	540	552	563	576
PH / PH3 / Misc (L)		17 ppm							#NAME?
Notes / Comments: 08:00 working on plugged eductor.									

Time in 30 minute increments (max)

<b>Pan Still</b>	Inst Tag No.	11:00	11:30	12:00	12:30	1:00	1:30	2:00	2:30
Furnace Controller Temperature (L)	Yokogawa	766	890	911	1054	1207	1220	1230	1308
Still T/C Temperature	Still	546	551	561	605	721	848	909	938
Vapor Outlet Temperature (R)	TR-1000	419	497	442	392	371	365	348	264
Vapor Outlet Pressure (R)	PR-1002	1.34	1.74	0.28	0.29	1.25	0.17	0.33	0.23
<b>Condenser</b>	Inst Tag No.	Time in 30 minute increments (max)							
Condenser Overflow Temp (R)	TR-1007	123	135	129	106	104	105	102	84
Condenser Outlet Temp (R)	TR-1012	97	108	112	101	103	105	102	88
Eductor Inlet Pressure (R)	PR-1003	-0.71	-1.32	-1.58	-2.22	-1.56	-1.51	-1.28	-2.71
<b>Water Circulation System</b>	Inst Tag No.	Time in 30 minute increments (max)							
Condenser Spray Pressure (L)	PI-1011	44	28	45	36	37	47	47	46
Condenser Spray Temp. ( R )	TR-1004	No Signal							
Eductor Water Pressure (L)	PI-1010	3	25	38	20	20	27	27	39
Recirc Pump Outlet Pressure (L)	PI-1009	46	30	48	39	39	50	49	40
Recirc Pump VFD Hertz (R)	SIC-1008	45	35	45	40	40	45	45	45
<b>Miscellaneous</b>	Inst Tag No.	Time in 30 minute increments (max)							
Overpak Drum Water Temp (L)	TC-1006	126	126	126	126	126	127	127	127
Recirc Tank Water Temp (L)		124	127	118	115	1110	108	106	94
KWH Meter Reading (L)		583	598	606	6111	622	625	628	635
PH / PH3 / Misc (L)		+1000				150 ppm			39 ppm
Notes / Comments									



Time in 30 minute increments (max)

<b>Pan Still</b>	Inst Tag No.	15:00	15:30	16:00	16:30				
Furnace Controller Temperature (L)	Yokogawa	1243	1328	1340	1220				
Still T/C Temperature	Still	852	1057	1123	1177				
Vapor Outlet Temperature (R)	TR-1000	287	312	324	332				
Vapor Outlet Pressure (R)	PR-1002	0.76	-2.19	0.82	-0.6				
<b>Condenser</b>	Inst Tag No.	Time in 30 minute increments (max)							
Condenser Overflow Temp (R)	TR-1007	90	90	102	141				
Condenser Outlet Temp (R)	TR-1012	90	96	106	122				
Eductor Inlet Pressure (R)	PR-1003	-2.15	-0.62	-0.87	-2.07				
<b>Water Circulation System</b>	Inst Tag No.	Time in 30 minute increments (max)							
Condenser Spray Pressure (L)	PI-1011	47	37	28	28				
Condenser Spray Temp. ( R )	TR-1004	No Signal							
Eductor Water Pressure (L)	PI-1010	50	40	30	30				
Recirc Pump Outlet Pressure (L)	PI-1009	50	40	30	30				
Recirc Pump VFD Hertz (R)	SIC-1008	45	40	35	35				
<b>Miscellaneous</b>	Inst Tag No.	Time in 30 minute increments (max)							
Overpak Drum Water Temp (L)	TC-1006	126	126	126	126				
Recirc Tank Water Temp (L)		96	120	134	147				
KWH Meter Reading (L)		637	643	650	650				
PH / PH3 / Misc (L)									
Notes / Comments: Furnace temperature raised to 1300 at 15:00									

Test 5 Notes.

July 12, 2011

9:00 hours - 346.8 pounds - agitated

Material Balance Summary. Sub = by subtraction

Water Collection Method	Lab Analysis	Scale Weights	
P4	Not recorded	sub 118.6	142.6
H2O	Not recorded	160.6	140.2
Res	Not recorded	67.6	64.0

Observations: Shortly after starting Test 5 it became impossible to control the condenser and furnace pressures. The as the condenser outlet temperatures were low, the initial conclusion was that the educator was frozen. Attempts to thaw the educator with hot water were unsuccessful. It was then decided to control the system pressure utilizing additions condenser sprays while installing a blank in the condenser outlet to remove the educator. During this process it was determined the educator was pugged solid with small round particles of clear to white phosphorus a sixteenth or less in diameter. Also at this time a small hole was observed in the top of the educator. During dis-assembly the bottom of the 1-1/2" to 1/2" transition bushing was found to be filled with solids, mostly small particles of brown phosphorus contaminated material. In an attempt to complete repairs before completion of the water boil phase, the hole in the educator was stuffed with pig putty until there was no vapor trail. The pressure system continued to be difficult to control. Manual adjustment of the condenser spray valves was the most successful method of controlling pressure. Temperatures were maintained by adding fresh water thru the bypass valve. Collecting water for a water balance was problematic due to the volume of water added to the recycle loop. Approximately 400 gallons of makeup water was added to the system. During the repairs (~11:00) the N2 cylinder went empty. With no flow, both N2 heaters failed. The Test was completed with cold nitrogen.

Opening the Still after the run was complicated by the agitator being stuck to the pivot in the Still bottom. After removal of the packing the lid was removed with no fire or smoke. A material of light yellow color covered the inside of the Still lid. That material later washed out with cold water from a garden hose. The residue was light and fluffy with some traces of yellow. The residue was removed from the Still by vacuuming. After removing the residue, the agitator was extracted with little effort.

Very little acid or P4 was found in the system during post-test cleaning. The P4 produced during Test 5 did have a dirt layer on top of the P4. May have been carry over during the pressure excursions or with the N2 sweep gas at the end of the run. Reducing the agitator RPM at the end of the run might be of some help.

Was unable to ignite the vent stack at any time during the Test.

**TEST 6**

**OPERATOR LOG SHEETS**

**2011 Rhodia Phosphorus**

---

**Recovery Pilot Project**

## Time in 30 minute increments (max)

<b>Pan Still</b>	Inst Tag No.	12:00	12:30	1:00	1:30	2:00	2:30	3:00	3:30
Furnace Controller Temperature (L)	Yokogawa	653	662	685	679	711	735	717	714
Still T/C Temperature	Still	77	90	156	181	193	200	203	209
Vapor Outlet Temperature (R)	TR-1000	198	254	250	243	244	249	249	259
Vapor Outlet Pressure (R)	PR-1002	0.79	0.63	1.02	1.15	1.07	1.22	1.84	1.16
<b>Condenser</b>	Inst Tag No.	Time in 30 minute increments (max)							
Condenser Overflow Temp (R)	TR-1007	109	109	126	137	138	139	137	137
Condenser Outlet Temp (R)	TR-1012	112	109	108	117	116	116	116	115
Eductor Inlet Pressure (R)	PR-1003	-3.5	-3.35	-1.71	-1.73	-1.65	-1.47	-1.06	-1.69
<b>Water Circulation System</b>	Inst Tag No.	Time in 30 minute increments (max)							
Condenser Spray Pressure (L)	PI-1011	21	21	32	32	32	32	32	322
Condenser Spray Temp. ( R )	TR-1004	117	118	122	133	127	130	129	129
Eductor Water Pressure (L)	PI-1010	3	3	9	11	11	11	12	12
Recirc Pump Outlet Pressure (L)	PI-1009	30	30	42	40	39	40	38	39
Recirc Pump VFD Hertz (R)	SIC-1008	35	35	45	45	45	45	45	45
<b>Miscellaneous</b>	Inst Tag No.	Time in 30 minute increments (max)							
Overpak Drum Water Temp (L)	TC-1006	123	123	123	123	124	125	122	124
Recirc Tank Water Temp (L)		125	124	129	140	135	136	134	136
KWH Meter Reading (L)		650	659	668	677	686	693	697	702
PH / PH3 / Misc (L)				>1000 ppm		>1000 ppm		>1000 ppm	
Notes / Comments									



Time in 30 minute increments (max)

<b>Pan Still</b>	Inst Tag No.	16:00	16:30	17:00	17:30	18:00	18:30	19:00	19:30
Furnace Controller Temperature (L)	Yokogawa	822	1042	1134	1202	1224	1271	1305	1312
Still T/C Temperature	Still	213		292	406	481	526	668	751
Vapor Outlet Temperature (R)	TR-1000	284	309	333	364	356	372	395	385
Vapor Outlet Pressure (R)	PR-1002	1.06	-0.97	2.07	1.04	0.83	0.86	0.72	0.76
<b>Condenser</b>	Inst Tag No.	Time in 30 minute increments (max)							
Condenser Overflow Temp (R)	TR-1007	136	132	142	140	120	127	134	127
Condenser Outlet Temp (R)	TR-1012	118	114	120	114	107	116	118	116
Eductor Inlet Pressure (R)	PR-1003	-1.65	-1.73	-1.06	-1.56	-1.76	-1.66	-1.82	
<b>Water Circulation System</b>	Inst Tag No.	Time in 30 minute increments (max)							
Condenser Spray Pressure (L)	PI-1011	33	33	33	33	32	32	32	31
Condenser Spray Temp. ( R )	TR-1004	130	134	134	132	130	133	137	136
Eductor Water Pressure (L)	PI-1010	13	10	10	10	11	11	11	22
Recirc Pump Outlet Pressure (L)	PI-1009	38	40	40	39	39	39	39	27
Recirc Pump VFD Hertz (R)	SIC-1008	45	45	45	45	45	45	45	45
<b>Miscellaneous</b>	Inst Tag No.	Time in 30 minute increments (max)							
Overpak Drum Water Temp (L)	TC-1006	126	127	128	128	128	128	130	125
Recirc Tank Water Temp (L)		136	141	138	140	140	143	149	145
KWH Meter Reading (L)		707	720	725	732	737	742	749	752
PH / PH3 / Misc (L)		>1000 ppm		>1000 ppm		>1000 ppm		>1000 ppm	
Notes / Comments									



## Time in 30 minute increments (max)

<b>Pan Still</b>	Inst Tag No.	20:00	20:30	21:00	21:30	22:00	22:30	23:00	23:30
Furnace Controller Temperature (L)	Yokogawa	1340	1350	1342	1348	1340	1371	1391	1416
Still T/C Temperature	Still	906	1345	1028	1097	1169	1211	1211	1211
Vapor Outlet Temperature (R)	TR-1000	358	352	359	345	312	317	329	331
Vapor Outlet Pressure (R)	PR-1002	0.61	0.25	0.49	0.42	1.21		0.67	0.49
<b>Condenser</b>	Inst Tag No.	Time in 30 minute increments (max)							
Condenser Overflow Temp (R)	TR-1007	109	116	121	105	88	121	123	113
Condenser Outlet Temp (R)	TR-1012	105	104	102	99	95		119	109
Eductor Inlet Pressure (R)	PR-1003	-1.61	-1.78	-1.38	-1.2	-0.49	-2.04	-0.8	-1.02
<b>Water Circulation System</b>	Inst Tag No.	Time in 30 minute increments (max)							
Condenser Spray Pressure (L)	PI-1011	31	30	30	32	31	40	12	11
Condenser Spray Temp. ( R )	TR-1004	128	124	123	121	129	141	147	137
Eductor Water Pressure (L)	PI-1010	22	22	20	11	18	6	9	9
Recirc Pump Outlet Pressure (L)	PI-1009	27	27	30	40	34	49	28	14
Recirc Pump VFD Hertz (R)	SIC-1008	45	45	45	45	45	45	30	30
<b>Miscellaneous</b>	Inst Tag No.	Time in 30 minute increments (max)							
Overpak Drum Water Temp (L)	TC-1006	124	125	131	131	Draining Condenser			
Recirc Tank Water Temp (L)		138	134	134	132	137	151	160	144
KWH Meter Reading (L)		759	762	766	770	774	778	783	785
PH / PH3 / Misc (L)			>1000 ppm	>1000 ppm		>1000 ppm			>1000 ppm
Notes / Comments: Drained the condenser to the product drum. Auto-ignite on vapor valve tests.									

Time in 30 minute increments (max)

<b>Pan Still</b>	Inst Tag No.	24:00	24:30	01:00	01:30	02:00	02:30	03:00	03:30
Furnace Controller Temperature (L)	Yokogawa	1439	1454	1471	1477	1500	1500	1497	1499
Still T/C Temperature	Still	1211 *	1211 *	1211 *	1211 *	1211 *	1211 *	1211 *	1211 *
Vapor Outlet Temperature (R)	TR-1000	343	351	351	345	348	343	340	354
Vapor Outlet Pressure (R)	PR-1002	1.36	0.56	0.46	1.17	0.47	0.41	0.37	1.23
<b>Condenser</b>	Inst Tag No.	Time in 30 minute increments (max)							
Condenser Overflow Temp (R)	TR-1007	124	117	120	127	124	116	112	107
Condenser Outlet Temp (R)	TR-1012	125	126	128	126	126	121	117	118
Eductor Inlet Pressure (R)	PR-1003	-0.52	-1.14	-1.66	-0.77	-1.24	-1.16	-1.42	-0.62
<b>Water Circulation System</b>	Inst Tag No.	Time in 30 minute increments (max)							
Condenser Spray Pressure (L)	PI-1011	17	17	16	16	16	15	16	16
Condenser Spray Temp. ( R )	TR-1004	152	145	149	155	148	142	137	148
Eductor Water Pressure (L)	PI-1010	12	12	13	12	12	13	12	12
Recirc Pump Outlet Pressure (L)	PI-1009	18	18	18	18	18	18	18	18
Recirc Pump VFD Hertz (R)	SIC-1008	35	35	35	35	35	35	35	35
<b>Miscellaneous</b>	Inst Tag No.	Time in 30 minute increments (max)							
Overpak Drum Water Temp (L)	TC-1006						112	116	116
Recirc Tank Water Temp (L)		160	150	150	161	167	158	152	147
KWH Meter Reading (L)		792	795	800	804	809	811	815	819
PH / PH3 / Misc (L)				>1000 ppm		>1000 ppm		>1000 ppm	>1000 ppm
Notes / Comments: Still thermocouple upper limit set at 1200. Auto-ignite vapor valve @ 01:30. Vent stack auto-ignite, blue/green flame.									



## Time in 30 minute increments (max)

<b>Pan Still</b>	Inst Tag No.	04:00	04:30	05:00	05:30	06:00	06:30	07:00	07:30
Furnace Controller Temperature (L)	Yokogawa	1506	1486	1471	1482	1502	1484	1490	1503
Still T/C Temperature	Still	1211 *	1211 *	1211 *	1211 *	1211 *	1211 *	1211 *	1211 *
Vapor Outlet Temperature (R)	TR-1000	364	377	375	362	341	306	290	268
Vapor Outlet Pressure (R)	PR-1002	0.67	0.48	0.64	0.57	0.43	0.46	0.52	0.42
<b>Condenser</b>	Inst Tag No.	Time in 30 minute increments (max)							
Condenser Overflow Temp (R)	TR-1007	111	104	132	123	119	115	110	105
Condenser Outlet Temp (R)	TR-1012	126	118	124	115	107	101	96	97
Eductor Inlet Pressure (R)	PR-1003	-1.10	-1.50	-1.03	-1.17	-1.29	-1.26	-1.05	-1.22
<b>Water Circulation System</b>	Inst Tag No.	Time in 30 minute increments (max)							
Condenser Spray Pressure (L)	PI-1011	20	19	20	20	20	20	20	20
Condenser Spray Temp. ( R )	TR-1004	148	150	150	141	135	132	130	129
Eductor Water Pressure (L)	PI-1010	8	12	10	10	10	10	10	10
Recirc Pump Outlet Pressure (L)	PI-1009	32	20	22	22	22	22	22	22
Recirc Pump VFD Hertz (R)	SIC-1008	35	35	37	37	37	37	37	37
<b>Miscellaneous</b>	Inst Tag No.	Time in 30 minute increments (max)							
Overpak Drum Water Temp (L)	TC-1006	No Reading							
Recirc Tank Water Temp (L)		166	156	160	147	144	140	137	136
KWH Meter Reading (L)		822	826	829	833	836	840	844	847
PH / PH3 / Misc (L)			188 ppm		19 ppm			20 ppm	

Notes / Comments: Still thermocouple upper limit set at 1200. Flame on the vapor valve at 06:30. Intermittent auto-ingnite at the Vent stack.

Test 6 Notes.

July 19, 2011

19:30 hours – 347.7 pounds – not agitated

Material Balance Summary. Sub = by subtraction

Water Collection Method		Lab Analysis		Scale Weights
P4	99.7	sub	114.7	102.9
H2O	148.6		159.6	sub 140.2
Res	99.4	sub	73.4	99.2

Observations: Test 6 started at noon due to installation of a new educator. Was unable to obtain an exact duplicate of the damaged educator so a substitute was purchased. Eductor water and inlet pressures will be different from previous Tests. Overall system pressures are higher on the vapor line and lower on the educator. Time required to reach milestone temperatures were considerably longer as expected without agitation even though overflow during the water phase was observed at 12:20. Biggest news is the vent stack emissions. At approximately 18:30 the vent stack was producing a blue/green flame and P2O5 plume. This event continued off and on until 06:00 the next morning. Corresponding to the vent emissions, a self-igniting flame was observed at the vapor valve when tested.

Furnace/Still Temperatures: For the most part the furnace and Still temperatures exhibited characteristics of previous Tests. Around 20:00 there was reason to believe the RAP phase had begun so the P4 was drained from the condenser and preparations were made for shutting down in 2-4 hours. Still temperatures climbed to 1211 at 22:30 and remained there within 0.5 degree for over 9 hours. The furnace temperature was incrementally raised over this time frame to 1500 F. A vapor valve test at 06:30 still produced a small flame and P2O5 plume. Another vapor valve test was performed at 07:00 with no flame or plume. The furnace was shut off at 07:30.

Smoke and some flame was observed when opening the Still. A small quantity of phos acid had collected at the Still to lid gasket interface. This has occurred on several Tests. When the phos acid contaminates the residue material it is returned to the clarifier. The walls of the Still above the residue were bright yellow with a ½"-1" layer of material attached. When disturbed the wall material did not burn. Residue in the bottom of the Still was crusted over and came out in large chunks. Again the yellow tint throughout. Sending some digital pictures to better explain.

The P4 produced was of good quality. Due to the depth of P4 in the product drum it is difficult to break into chunks. A picture of the P4 collected from the recycle tanks is also attached.

**TEST 7**

**OPERATOR LOG SHEETS**

**2011 Rhodia Phosphorus**

---

**Recovery Pilot Project**

## Time in 30 minute increments (max)

<b>Pan Still</b>	Inst Tag No.	07:30	08:00	08:30	09:00	09:30	10:00	10:30	11:00
Furnace Controller Temperature (L)	Yokogawa	118	530	638	662	471	648	698	884
Still T/C Temperature	Still	118	124	216	217	218	219	241	390
Vapor Outlet Temperature (R)	TR-1000	194	238	276	266	270	275	303	320
Vapor Outlet Pressure (R)	PR-1002	-9.90	-0.38	1.15	2.59	0.42	0.73	0.42	0.42
<b>Condenser</b>	Inst Tag No.	Time in 30 minute increments (max)							
Condenser Overflow Temp (R)	TR-1007	112	111	148	147	143	137	131	129
Condenser Outlet Temp (R)	TR-1012	90	100	125	110	112	106	117	115
Eductor Inlet Pressure (R)	PR-1003	-0.45	-0.26	-0.15	1.38	-0.11	-0.36	-0.31	-0.57
<b>Water Circulation System</b>	Inst Tag No.	Time in 30 minute increments (max)							
Condenser Spray Pressure (L)	PI-1011	20	23	29	44	39	39	27	38
Condenser Spray Temp. ( R )	TR-1004	126	123	132	112	115	113	133	134
Eductor Water Pressure (L)	PI-1010	12	13	18	4	10	10	12	11
Recirc Pump Outlet Pressure (L)	PI-1009	27	27	30	48	41	41	40	41
Recirc Pump VFD Hertz (R)	SIC-1008	40	40	40	45	45	45	45	45
<b>Miscellaneous</b>	Inst Tag No.	Time in 30 minute increments (max)							
Overpak Drum Water Temp (L)	TC-1006	119	121	123	124	125	126	126	127
Recirc Tank Water Temp (L)		133	129	142	113	118	123	141	143
KWH Meter Reading (L)		847	854	864	876	887	892	900	908
PH / PH3 / Misc (L)				426 ppm		885 ppm		>1000 ppm	
Notes / Comments									



Time in 30 minute increments (max)

<b>Pan Still</b>	Inst Tag No.	11:30	12:00	12:30	13:00	13:25	14:00	14:30	15:00
Furnace Controller Temperature (L)	Yokogawa	929	1102	1181	1196	1190	1198	1201	1208
Still T/C Temperature	Still	528	555	566	635	746	873	941	996
Vapor Outlet Temperature (R)	TR-1000	446	467	414	438	370	351	290	240
Vapor Outlet Pressure (R)	PR-1002	0.19	1.02	0.72		0.90	0.25	0.90	1.09
<b>Condenser</b>	Inst Tag No.	Time in 30 minute increments (max)							
Condenser Overflow Temp (R)	TR-1007	117	120	118	126	123	122	121	121
Condenser Outlet Temp (R)	TR-1012	109	114	115	113	113	112	111	112
Eductor Inlet Pressure (R)	PR-1003	-0.62	-0.35	-0.57		-0.62	-1.71	-1.28	-0.92
<b>Water Circulation System</b>	Inst Tag No.	Time in 30 minute increments (max)							
Condenser Spray Pressure (L)	PI-1011	38	37	37		37	39	39	40
Condenser Spray Temp. ( R )	TR-1004	131	136	137	132	134	132	130	130
Eductor Water Pressure (L)	PI-1010	11	14	14		8	8	8	8
Recirc Pump Outlet Pressure (L)	PI-1009	40	39	39	38	43	44	45	44
Recirc Pump VFD Hertz (R)	SIC-1008	45	45	45	45	45	45	45	45
<b>Miscellaneous</b>	Inst Tag No.	Time in 30 minute increments (max)							
Overpak Drum Water Temp (L)	TC-1006	125	123	121	120	118	118	118	118
Recirc Tank Water Temp (L)		139	145	147	141	143	141	139	139
KWH Meter Reading (L)		918	929	937	942	947	952	955	959
PH / PH3 / Misc (L)		600 ppm		500 ppm			200 ppm		28 ppm

Notes / Comments: @13:00 while changing N2 bottles furnace 'burped'. Filled instrument lines with P4/water.

Test 7 Notes.

July 26, 2011

Run time. 7 hours, 30 minutes – 253.1 pound charge – agitated

Material Balance Summary. Sub = by subtraction

Water Collection Method		Lab Analysis		Scale Weights
P4	100.8	sub	105.0	112.2
H2O	108.2	sub *	104.5	sub 96.8
Res	44.1	sub	43.5	44.1

\* Water collection for material balance verification is difficult during the water boil phase as the recycle water temperature is currently being controlled manually. Over 200 gallons of makeup water was added during the water phase of Test 7.

Observations: Test 7 was the balance of the material from Drum 7. Drum 7 was the highest P4 content sample taken from the clarifier (41.5%), with an almost equal amount of water. Test 4 produced P4 with a significant dirt layer on top. Test 7 was to determine if the dirt carry over to the product drum could be reduced if the high water temperatures experienced on Test 4 were kept in a lower operating range. Repeatability of material balance and P4 production results are also important.

NOTE: KW was successful in utilizing our Tank Car sampling equipment to obtain a 6 to 8 inch sample of the P4 collected in the product drum. As a result we now know the P4 from every test to date has a 1" to 1-1/2" layer of dirt on top of the P4. A core sample completely thru the P4 plug has not been successful at this point. Dirt carry over will likely be a topic of conversation at the August 4<sup>th</sup> conference call. Digital pictures will be routed before the conference call.

Lessons Learned. During a nitrogen cylinder change at 13:00 hours, very near the end of the white P4 phase, the Still 'burped' and filled most of the magnehelic and transmitter tubing lines on the Vapor line as well as the nitrogen supply lines full of Still material. These tubing lines required replacement. Between Tests, a manifold with separate shut off valves between the nitrogen regulator and the N2 heaters was installed. Previously the Still pressure was erratic when the flow of nitrogen was interrupted, sometimes creating a suction on the Still. That problem should be resolved with the piping revisions.

Test 7 Residue. PH3 was 2.5 ppm when the Still was opened. Some yellow coloring in the residue. No distinctive odor was detected. Field tests on the residue were non-reactive and not ignitable. The Still lid showed only trace amounts of P4 in the outlet nozzle. There was once again phos acid around the inside of the Still to lid gasket joint. Due to residue contamination from this phos acid the residue from Test 7 was returned to the clarifier. A sample was taken for TCLP analysis



**TEST 8**

**OPERATOR LOG SHEETS**

**2011 Rhodia Phosphorus**

---

**Recovery Pilot Project**

Time in 30 minute increments (max)

<b>Pan Still</b>	Inst Tag No.	7:12	7:30	8:00	8:30	9:00	9:30	10:00	10:30
Furnace Controller Temperature (L)	Yokogawa	275	597	672	690	686	700	684	683
Still T/C Temperature	Still	92	93	111	215	217	216	218	217
Vapor Outlet Temperature (R)	TR-1000	263	307	290	252	247	249	249	256
Vapor Outlet Pressure (R)	PR-1002	0.27	0.43	0.93	-1.92	-0.12	1.82	1.66	0.25
<b>Condenser</b>	Inst Tag No.	Time in 30 minute increments (max)							
Condenser Overflow Temp (R)	TR-1007	85	92	132	129	126	129	127	118
Condenser Outlet Temp (R)	TR-1012	89	80	97	97	91	90	89	91
Eductor Inlet Pressure (R)	PR-1003	-0.36	-0.24	-0.3	-3.10	-1.27	0.33	0.27	-1.39
<b>Water Circulation System</b>	Inst Tag No.	Time in 30 minute increments (max)							
Condenser Spray Pressure (L)	PI-1011	49	50	39	34	31	22	23	33
Condenser Spray Temp. ( R )	TR-1004	100	98	110	105	106	103	99	98
Eductor Water Pressure (L)	PI-1010	2	3	12	11	10	9	6	11
Recirc Pump Outlet Pressure (L)	PI-1009	50	50	42	37	35	18	19	36
Recirc Pump VFD Hertz (R)	SIC-1008	45	45	45	45	45	45	45	45
<b>Miscellaneous</b>	Inst Tag No.	Time in 30 minute increments (max)							
Overpak Drum Water Temp (L)	TC-1006	111	112	113	114	115	116	117	118
Recirc Tank Water Temp (L)		105	103	117	123	115	111	104	106
KWH Meter Reading (L)		960	968	978	988	997	1000	1010	1016
PH / PH3 / Misc (L)		250 ppm	300 ppm	140 ppm	>1000 ppm		900 ppm		750 ppm
Notes / Comments									

Time in 30 minute increments (max)

<b>Pan Still</b>	Inst Tag No.	11:00	11:30	12:00	12:30	13:00	13:30	14:00	14:30
Furnace Controller Temperature (L)	Yokogawa	706	708	710	703	724	972	1114	1197
Still T/C Temperature	Still	217	217	216	218	216	292	446	552
Vapor Outlet Temperature (R)	TR-1000	270	282	299	306	310	314	326	345
Vapor Outlet Pressure (R)	PR-1002	1.15	1.18	1.16	0.94	1.02	1.02	5.57	0.84
<b>Condenser</b>	Inst Tag No.	Time in 30 minute increments (max)							
Condenser Overflow Temp (R)	TR-1007	120	120	109	112	116	119	117	112
Condenser Outlet Temp (R)	TR-1012	99	97	95	114	97	100	107	112
Eductor Inlet Pressure (R)	PR-1003	-0.44	-0.29	-0.37	-0.63	-0.59	-0.69	-5.35	-0.87
<b>Water Circulation System</b>	Inst Tag No.	Time in 30 minute increments (max)							
Condenser Spray Pressure (L)	PI-1011	40	37	28	38	37	36	46	47
Condenser Spray Temp. ( R )	TR-1004	118	110	101	110	114	117	117	117
Eductor Water Pressure (L)	PI-1010	6	8	6	7	8	8	2	3
Recirc Pump Outlet Pressure (L)	PI-1009	43	40	33	40	41	41	50	50
Recirc Pump VFD Hertz (R)	SIC-1008	45	45	45	45	45	45	45	45
<b>Miscellaneous</b>	Inst Tag No.	Time in 30 minute increments (max)							
Overpak Drum Water Temp (L)	TC-1006	120	120	121	122	123	124	125	126
Recirc Tank Water Temp (L)		125	116	109	117	121	123	123	123
KWH Meter Reading (L)		1022	1026	1029	1032	1033	1044	1049	1055
PH / PH3 / Misc (L)			900 ppm		>1000 ppm			>1000 ppm	
Notes / Comments									



## Time in 30 minute increments (max)

<b>Pan Still</b>	Inst Tag No.	15:00	15:30	16:00	16:30	17:00	17:30	18:00	18:30
Furnace Controller Temperature (L)	Yokogawa	1217	1214	1220	1201	1224	1208	1211	1225
Still T/C Temperature	Still	556	560	556	566	584	621	651	682
Vapor Outlet Temperature (R)	TR-1000	465	468	452	414	405	389	387	381
Vapor Outlet Pressure (R)	PR-1002	0.89	0.98	0.99	0.88	0.99	0.93	0.89	0.98
<b>Condenser</b>	Inst Tag No.	Time in 30 minute increments (max)							
Condenser Overflow Temp (R)	TR-1007	116	123	127	122	119	116	116	115
Condenser Outlet Temp (R)	TR-1012	116	121	126	123	120	117	119	118
Eductor Inlet Pressure (R)	PR-1003	-1.09	-1.19	-1.23	-1.25	-1.20	-1.14	-1.14	-1.09
<b>Water Circulation System</b>	Inst Tag No.	Time in 30 minute increments (max)							
Condenser Spray Pressure (L)	PI-1011	47	47	47	47	47	48	48	48
Condenser Spray Temp. ( R )	TR-1004	122	128	132	129	126	125	126	125
Eductor Water Pressure (L)	PI-1010	3	3	3	3	3	3	3	3
Recirc Pump Outlet Pressure (L)	PI-1009	50	50	50	50	50	50	50	50
Recirc Pump VFD Hertz (R)	SIC-1008	45	45	45	45	45	45	45	45
<b>Miscellaneous</b>	Inst Tag No.	Time in 30 minute increments (max)							
Overpak Drum Water Temp (L)	TC-1006	127	127	129	130	131	131	132	132
Recirc Tank Water Temp (L)		129	128	139	136	134	133	134	134
KWH Meter Reading (L)		1059	1062	1066	1070	1073	1075	1078	1079
PH / PH3 / Misc (L)		<1000 ppm		300 ppm		242 ppm			183 ppm
Notes / Comments									

Time in 30 minute increments (max)

<b>Pan Still</b>	Inst Tag No.	19:00	19:30	20:00	20:30	21:00	21:30	22:00	22:30
Furnace Controller Temperature (L)	Yokogawa	1217	1222	1198	1220	1223	1221	1313	1315
Still T/C Temperature	Still	706	723	748	763	779	787	803	816
Vapor Outlet Temperature (R)	TR-1000	369	368	377	354	332	314	299	293
Vapor Outlet Pressure (R)	PR-1002	0.89	0.88	0.9	0.97	0.94	0.93	-0.41	0.72
<b>Condenser</b>	Inst Tag No.	Time in 30 minute increments (max)							
Condenser Overflow Temp (R)	TR-1007	114	114	117	117	119	118	133	133
Condenser Outlet Temp (R)	TR-1012	124	118	121	121	122	122	120	90
Eductor Inlet Pressure (R)	PR-1003	-0.68	-0.66	-0.71	-0.39	-0.23	-0.31	-1.4	-0.45
<b>Water Circulation System</b>	Inst Tag No.	Time in 30 minute increments (max)							
Condenser Spray Pressure (L)	PI-1011	49	49	49	49	49	49	49	49
Condenser Spray Temp. ( R )	TR-1004	124	124	126	127	128	128	147	138
Eductor Water Pressure (L)	PI-1010	3	3	3	3	3	3	3	3
Recirc Pump Outlet Pressure (L)	PI-1009	50	50	50	50	50	50	40	30
Recirc Pump VFD Hertz (R)	SIC-1008	45	45	45	45	45	45	40	35
<b>Miscellaneous</b>	Inst Tag No.	Time in 30 minute increments (max)							
Overpak Drum Water Temp (L)	TC-1006	133	133	134	135	136	130	Draining Condenser	
Recirc Tank Water Temp (L)		133	133	135	136	138	136	154	146
KWH Meter Reading (L)		1082	1084	1086	1088	1091	1092	1097	1099
PH / PH3 / Misc (L)			166 ppm		30 ppm				
Notes / Comments: Raised furnace temperature to 1300 at 21:30									



Time in 30 minute increments (max)

<b>Pan Still</b>	Inst Tag No.	23:00	23:30	24:00	24:30	01:00				
Furnace Controller Temperature (L)	Yokogawa	1307	1313	1316	1303	1301				
Still T/C Temperature	Still	828	837	857	884	895				
Vapor Outlet Temperature (R)	TR-1000	304	301	288	278	271				
Vapor Outlet Pressure (R)	PR-1002	0.54	0.5	0.52	0.55	0.4				
<b>Condenser</b>	Inst Tag No.	Time in 30 minute increments (max)								
Condenser Overflow Temp (R)	TR-1007	122	117	108	109	102				
Condenser Outlet Temp (R)	TR-1012	93	88	77	75	64				
Eductor Inlet Pressure (R)	PR-1003	-0.63	-0.36	-0.43	-0.42	-0.47				
<b>Water Circulation System</b>	Inst Tag No.	Time in 30 minute increments (max)								
Condenser Spray Pressure (L)	PI-1011	39	29	29	29	29				
Condenser Spray Temp. ( R )	TR-1004	134	129	124	122	119				
Eductor Water Pressure (L)	PI-1010	2	2	2	2	2				
Recirc Pump Outlet Pressure (L)	PI-1009	30	30	30	30	30				
Recirc Pump VFD Hertz (R)	SIC-1008	35	35	35	35	35				
<b>Miscellaneous</b>	Inst Tag No.	Time in 30 minute increments (max)								
Overpak Drum Water Temp (L)	TC-1006	Draining Condenser and Recycle Tank								
Recirc Tank Water Temp (L)		144	139	135	132	129				
KWH Meter Reading (L)		1102	1104	1106	1108	1110				
PH / PH3 / Misc (L)										
Notes / Comments:										

Test 8 Notes.

July 28, 2011

Run time. 18 hours – 362 pound charge – agitated

Material Balance Summary. Sub = by subtraction

Water Collection Method		Lab Analysis		Scale Weights
P4	96.3	sub 89.4		108.6
H2O	192.2 sub *	199.1	sub	154.7
Res	73.5 sub	73.5		98.7

\* Water collection for material balance verification is difficult during the water boil phase as the recycle water temperature is currently being controlled manually.

Test 8 material balance was varied significantly from the lab analysis. Sample Drum 11 was selected for this test because the analysis was high water (55%) and low P4 (20.3), even tho the final weights indicated a lower water, higher P4 content. The water phase lasted over 6.5 hours.

Observations: Test 8 was unique from several perspectives. First and most significant was the P205 plume generated within 30 minutes of startup. The plume was dense at times and was visible across the clarifier (>100 feet). Furnace ramp rate was the standard 700 F. until the end of the water phase. The Still temperature recorded was 93 F. Further evidence of early P4 generation was demonstrated at 10:00 when the water recycle pump discharge pressure dropped from 35 psi to 18 psi due to a plugged strainer. We continued to run the Test while the strainer was cleaned. The material removed was pure P4 as expected. The recycle tank was drained several times during the Test anticipating a large carryover of P4. Final weights confirmed a higher than usual (16%) amount of P4 in the recycle drum.

Test 8 run time was 18 hours and should have been several hours longer based on the condition of the Still at opening. A conscious decision was made to terminate the run after 18 hours although there was a slight vapor trail on the vapor valve. The vapor trail did not self ignite but was clearly visible. Still temperatures were approaching 900 F. and the Vapor Line temperatures were declining (271 F.). Previous tests were terminated a temperatures from 950 F. to >1200 F. Previous large weight charges of 350 lbs we completed at 1150 F. or higher. Probably needed 2 additional hours or more based on Test 5.

Unique Operating Condition: Test 8 started with the agitator set at 1 rpm. Six hours into the run, right at the end of the water phase, the agitator started working it's way out of the Still. The agitator raised ½" to ¾" thru the packing. Raised the rpm to 2 and monitored the agitator. Two hours later the agitator was again sitting on the thrust washer. The rpm was reduced during the RAP phase with unusual behavior.

Residue: When the Still was opened there was a manageable amount of fire and smoke. High levels of PH3 was detected. The residue was contaminated and returned to the clarifier.



**TEST 9**

**OPERATOR LOG SHEETS**

**2011 Rhodia Phosphorus**

---

**Recovery Pilot Project**

Time in 30 minute increments (max)

<b>Pan Still</b>	Inst Tag No.	06:30	07:00	07:30	08:00	08:30	09:00	09:30	10:00
Furnace Controller Temperature (L)	Yokogawa	117	449	653	675	684	695	714	748
Still T/C Temperature	Still	95	95	182	217	216	216	217	217
Vapor Outlet Temperature (R)	TR-1000	252	313	311	286	289	292	304	321
Vapor Outlet Pressure (R)	PR-1002	0.65	0.65	0.85	1.27	1.22	1.24	1.17	0.86
<b>Condenser</b>	Inst Tag No.	Time in 30 minute increments (max)							
Condenser Overflow Temp (R)	TR-1007	85	82	110	136	136	129	124	125
Condenser Outlet Temp (R)	TR-1012	52	54	65	101	100	98	100	118
Eductor Inlet Pressure (R)	PR-1003	-1.45	-1.49	-1.39	-1.00	-1.24	-1.23	-1.21	-1.95
<b>Water Circulation System</b>	Inst Tag No.	Time in 30 minute increments (max)							
Condenser Spray Pressure (L)	PI-1011	29	30	30	29	26	26	26	26
Condenser Spray Temp. ( R )	TR-1004	98	98	100	107	108	105	113	126
Eductor Water Pressure (L)	PI-1010	3	3	3	3	3	3	3	3
Recirc Pump Outlet Pressure (L)	PI-1009	29	29	30	29	29	29	28	29
Recirc Pump VFD Hertz (R)	SIC-1008	35	35	35	35	35	35	35	35
<b>Miscellaneous</b>	Inst Tag No.	Time in 30 minute increments (max)							
Overpak Drum Water Temp (L)	TC-1006	112	113	114	115	115	116	116	117
Recirc Tank Water Temp (L)		105	105	107	114	114	111	120	135
KWH Meter Reading (L)		1111	1114	1124	1136	1144	1150	1154	1159
PH / PH3 / Misc (L)						488 ppm		780 ppm	
Notes / Comments									

## Time in 30 minute increments (max)

<b>Pan Still</b>	Inst Tag No.	10:30	11:00	11:30	12:00	12:30	13:00	13:30	14:00
Furnace Controller Temperature (L)	Yokogawa	720	725	721	731	1012	1139	1199	1204
Still T/C Temperature	Still	217	218	220	234	294	442	710	892
Vapor Outlet Temperature (R)	TR-1000	331	335	336	330	339	360	384	389
Vapor Outlet Pressure (R)	PR-1002	-0.86	1.3	0.92	0.86	0.63	0.69	0.76	0.7
<b>Condenser</b>	Inst Tag No.	Time in 30 minute increments (max)							
Condenser Overflow Temp (R)	TR-1007	135	130	117	115	130	132	134	131
Condenser Outlet Temp (R)	TR-1012	126	120	115	120	122	123	123	121
Eductor Inlet Pressure (R)	PR-1003	-1.52	-0.92	-1.18	-1.24	-1.29	-1.30	-1.39	-1.40
<b>Water Circulation System</b>									
Condenser Spray Pressure (L)	PI-1011	25	25	25	25	25	24	24	24
Condenser Spray Temp. ( R )	TR-1004	136	125	120	126	129	132	133	132
Eductor Water Pressure (L)	PI-1010	3	3	3	3	3	3	3	3
Recirc Pump Outlet Pressure (L)	PI-1009	29	29	29	29	29	29	29	28
Recirc Pump VFD Hertz (R)	SIC-1008	35	35	35	35	35	35	35	35
<b>Miscellaneous</b>	Inst Tag No.	Time in 30 minute increments (max)							
Overpak Drum Water Temp (L)	TC-1006	119	119	119	120	120	120	120	120
Recirc Tank Water Temp (L)		145	131	127	135	138	140	141	140
KWH Meter Reading (L)		1161	1164	1166	1168	1177	1186	1193	1198
PH / PH3 / Misc (L)		645 ppm		260 ppm	1000+ ppm		1000+ ppm		1000+ ppm
Notes / Comments: Raised furnace temperature to 1200 at 12:00									



Time in 30 minute increments (max)

<b>Pan Still</b>	Inst Tag No.	14:30	15:00	15:30	16:00	16:30	17:00	17:30	18:00
Furnace Controller Temperature (L)	Yokogawa	1203	1209	1206	1211	1192	1197	1206	1191
Still T/C Temperature	Still	1015	1085	1180	1212	1212	1212	1212	1212
Vapor Outlet Temperature (R)	TR-1000	390	389	388	376	380	403	426	345
Vapor Outlet Pressure (R)	PR-1002	0.79	0.91	0.73	0.78	0.77	0.81	0.87	0.79
<b>Condenser</b>	Inst Tag No.	Time in 30 minute increments (max)							
Condenser Overflow Temp (R)	TR-1007	131	132	129	129	125	124	123	118
Condenser Outlet Temp (R)	TR-1012	127	127	127	126	123	123	121	118
Eductor Inlet Pressure (R)	PR-1003	-1.32	-1.30	-1.50	-1.35	-1.39	-1.33	-1.36	-1.28
<b>Water Circulation System</b>									
Condenser Spray Pressure (L)	PI-1011	24	24	24	24	24	24	25	25
Condenser Spray Temp. ( R )	TR-1004	132	133	131	131	128	127	126	123
Eductor Water Pressure (L)	PI-1010	3	3	3	3	3	3	3	3
Recirc Pump Outlet Pressure (L)	PI-1009	28	28	28	28	28	28	28	29
Recirc Pump VFD Hertz (R)	SIC-1008	35	35	35	35	35	35	35	35
<b>Miscellaneous</b>	Inst Tag No.	Time in 30 minute increments (max)							
Overpak Drum Water Temp (L)	TC-1006	120	121	121	121	122	122	122	117
Recirc Tank Water Temp (L)		140	140	139	139	136	135	133	130
KWH Meter Reading (L)		1203	1207	1210	1213	1218	1220	1224	1228
PH / PH3 / Misc (L)			1000+ ppm		1000+ ppm		1000+ ppm	238 ppm	
Notes / Comments:									

Time in 30 minute increments (max)

<b>Pan Still</b>	Inst Tag No.	18:30	19:00	19:30	20:00	20:30	21:00		
Furnace Controller Temperature (L)	Yokogawa	1194	1192	1191	1191	1192	1192		
Still T/C Temperature	Still	1212	1212	1212	1212	1212	1212		
Vapor Outlet Temperature (R)	TR-1000	315	269	227	215	197	179		
Vapor Outlet Pressure (R)	PR-1002	0.73	0.59	0.64	0.67	0.61	-0.15		
<b>Condenser</b>	Inst Tag No.	Time in 30 minute increments (max)							
Condenser Overflow Temp (R)	TR-1007	116	113	112	115	106	108		
Condenser Outlet Temp (R)	TR-1012	115	113	113	114	101	120		
Eductor Inlet Pressure (R)	PR-1003	-1.43	-1.39	-1.40	-1.44	-1.66	-2.94		
<b>Water Circulation System</b>									
Condenser Spray Pressure (L)	PI-1011	25	25	25	26	26	28		
Condenser Spray Temp. ( R )	TR-1004	120	117	118	120	122	120		
Eductor Water Pressure (L)	PI-1010	3	3	3	3	3	3		
Recirc Pump Outlet Pressure (L)	PI-1009	29	29	29	29	28	29		
Recirc Pump VFD Hertz (R)	SIC-1008	35	35	35	35	35	35		
<b>Miscellaneous</b>	Inst Tag No.	Time in 30 minute increments (max)							
Overpak Drum Water Temp (L)	TC-1006	124	125	125	125	126	127		
Recirc Tank Water Temp (L)		127	124	125	128	130	126		
KWH Meter Reading (L)		1229	1232	1234	1236	1238	1241		
PH / PH3 / Misc (L)		220 ppm	122 ppm		18 ppm				
Notes / Comments: pH of condenser water = 3, recycle tank = 1									

Test 9 Notes.

August 9, 2011

Run time. 14 hours – 247 pound charge – not agitated

Material Balance Summary. Sub = by subtraction

	Lab Analysis		Scale Weights	
P4	sub	81.8		55.9
H2O		107.0	sub	127.2
Res		63.3		64.1

Water collection during Phase II and Phase III. Water was collected during the yellow P4 and RAP phases of the Test using the 250F-630F and 630F to end of Test criteria. Water collection (by displacement) projected to 45.9 pounds of P4 but most interesting was the split, 15.3 pounds during Phase II and 30.6 pounds during Phase III. There may be a correlation to the length of Phase II in the non-agitated Tests. In each of the three non-agitated Tests the percentage of run time in Phase II was significantly less than that of the Tests utilizing the agitator. Perhaps there is more yellow P4 being converted to RAP.

Observations: Water overflow started within 15 minutes of startup. During the water boil phase, within two hours of startup a P2O5 plume began to drift from the vent stack, carrying at times up to 100 feet. The nitrogen supply was reduced from 1.5 cfm to 0.5 cfm and a second condenser spray was partially opened which reduced the plume to +/- 10 feet. At the end of the water phase the condenser and recycle water tank were sampled for dust carryover. There was a small quantity of fine red and yellow color material in the water sampled that appeared to be P4. Condenser water PH was 3 and the recycle tank water was 5. Approximately 150 gallons of makeup water had been added prior to the samples.

Began checking the vapor valve for P2O5 about 11 hours into the Test (18:00) with self-ignition until 19:30. Light P2O5 smoke continued until 20:30 when a self-igniting blue/green flame about 2" long appeared while sampling the vapor valve. There was a slight wisp of P2O5 with the blue/green flame and at 21:00 it was decided to terminate the Test.

Residue. When the Still was opened there was very little smoke and no flames. Temperature of the residue was 147F. There was consistent yellow coloring in the residue and on the Still walls. Digital photos distributed describe the contents and Still best. No Phos acid was found around the Still to lid interface. The residue did not ignite when exposed to flame and was not reactive when mixed with water. PH3 readings were zero but the strong smell similar to H2S (but still different) was evident.

Tested the condenser and recycle tank water PH when the phosphorus in each tank was drained to drums. Condenser = PH of 1. Recycle tank = PH of 3.

See the digital pictures provided for visual evidence of the dirt layer on top of the P4 produced.

**TEST 10**

**OPERATOR LOG SHEETS**

**2011 Rhodia Phosphorus**

---

**Recovery Pilot Project**



Time in 30 minute increments (max)

<b>Pan Still</b>	Inst Tag No.	08:15	08:30	09:00	09:30	10:00	10:30	11:00	11:30
Furnace Controller Temperature (L)	Yokogawa	123	179	664	702	686	808	960	1036
Still T/C Temperature	Still	Instrument not sending data							
Vapor Outlet Temperature (R)	TR-1000	175	179	214	216	216	221	265	332
Vapor Outlet Pressure (R)	PR-1002	0.41	0.53	1.06	1.25	1.36	1.45	1.44	0.87
<b>Condenser</b>	Inst Tag No.	Time in 30 minute increments (max)							
Condenser Overflow Temp (R)	TR-1007	95	106	137	133	135	139	139	126
Condenser Outlet Temp (R)	TR-1012	60	60	66	97	114	107	105	105
Eductor Inlet Pressure (R)	PR-1003	-0.35	-0.39	-0.17	-0.35	-1.35	-1.47	-1.69	-1.60
<b>Water Circulation System</b>									
Condenser Spray Pressure (L)	PI-1011	28	28	28	20	26	16	15	30
Condenser Spray Temp. ( R )	TR-1004	110	108	127	119	118	119	120	115
Eductor Water Pressure (L)	PI-1010	3	3	3	6	3	7	10	13
Recirc Pump Outlet Pressure (L)	PI-1009	30	30	30	23	28	21	19	33
Recirc Pump VFD Hertz (R)	SIC-1008	35	35	35	35	35	35	35	45
<b>Miscellaneous</b>	Inst Tag No.	Time in 30 minute increments (max)							
Overpak Drum Water Temp (L)	TC-1006	109	109	110	110	111	123	113	113
Recirc Tank Water Temp (L)		119	115	138	126	125	127	126	122
KWH Meter Reading (L)		1243	1247	1261	1270	1277	1286	1297	1306
PH / PH3 / Misc (L)		20 ppm	31 ppm		1000+ ppm	1000+ ppm	1000+ ppm	1000+ ppm	1000+ ppm
Notes / Comments:									

Time in 30 minute increments (max)

<b>Pan Still</b>	Inst Tag No.	12:00	12:30	13:00	13:30	14:00	14:30	15:00	15:30
Furnace Controller Temperature (L)	Yokogawa	1123	1217	1224	1243	1230	1220	1206	1206
Still T/C Temperature	Still	Instrument not sending data							
Vapor Outlet Temperature (R)	TR-1000	377	398	406	411	402	401	390	386
Vapor Outlet Pressure (R)	0.84	0.62	0.57	0.33	0.65	0.63	0.63	0.63	0.51
<b>Condenser</b>	Inst Tag No.	Time in 30 minute increments (max)							
Condenser Overflow Temp (R)	TR-1007	122	129	133	134	130	128	128	129
Condenser Outlet Temp (R)	TR-1012	103	111	117	119	113	113	111	110
Eductor Inlet Pressure (R)	PR-1003	-0.01	-1.78	-1.73	-2.11	-1.87	-1.91	-1.95	-2.06
<b>Water Circulation System</b>									
Condenser Spray Pressure (L)	PI-1011	30	30	32	32	36	36	36	36
Condenser Spray Temp. ( R )	TR-1004	120	129	131	133	130	129	131	132
Eductor Water Pressure (L)	PI-1010	13	13	14	14	9	9	9	9
Recirc Pump Outlet Pressure (L)	PI-1009	33	33	35	35	40	40	40	40
Recirc Pump VFD Hertz (R)	SIC-1008	45	45	45	45	45	45	45	45
<b>Miscellaneous</b>	Inst Tag No.	Time in 30 minute increments (max)							
Overpak Drum Water Temp (L)	TC-1006	114	115	115	115	116	117	116	117
Recirc Tank Water Temp (L)		128	136	138	140	137	136	136	139
KWH Meter Reading (L)		1314	1322	1326	1130	1136	1138	1342	1344
PH / PH3 / Misc (L)		1000+ ppm	1000+ ppm	1000+ ppm	1000+ ppm	1000+ ppm	1000+ ppm	1000+ ppm	1000+ ppm
Notes / Comments:									



Time in 30 minute increments (max)

<b>Pan Still</b>	Inst Tag No.	16:00	16:30	17:00	17:30	18:00	18:30	19:00	19:30
Furnace Controller Temperature (L)	Yokogawa	1200	1200	1202	1205	1213	1201	1209	1202
Still T/C Temperature	Still	Instrument not sending data							
Vapor Outlet Temperature (R)	TR-1000	376	372	368	364	363	350	315	254
Vapor Outlet Pressure (R)	0.84	0.48	0.56	0.7	0.67	0.55	0.75	0.77	0.7
<b>Condenser</b>	Inst Tag No.	Time in 30 minute increments (max)							
Condenser Overflow Temp (R)	TR-1007	130	130	1129	129	129	126	126	124
Condenser Outlet Temp (R)	TR-1012	113	112	108	107	109	105	102	102
Eductor Inlet Pressure (R)	PR-1003	-2.33	-1.99	-2.01	-2.06	-2.15	-1.99	-2.06	-2.19
<b>Water Circulation System</b>									
Condenser Spray Pressure (L)	PI-1011	38	40	40	40	40	41	42	43
Condenser Spray Temp. ( R )	TR-1004	133	133	132	132	132	130	129	126
Eductor Water Pressure (L)	PI-1010	9	7	7	7	7	6	6	6
Recirc Pump Outlet Pressure (L)	PI-1009	40	41	41	41	41	43	43	43
Recirc Pump VFD Hertz (R)	SIC-1008	45	45	45	45	45	45	45	45
<b>Miscellaneous</b>	Inst Tag No.								
Overpak Drum Water Temp (L)	TC-1006	118	118	118	118	118	117	117	117
Recirc Tank Water Temp (L)		140	140	139	140	139	138	137	135
KWH Meter Reading (L)		1348	1351	1353	1356	1359	1362	1364	1368
PH / PH3 / Misc (L)		1000+ ppm		1000+ ppm	1000+ ppm		226 ppm	196 ppm	260 ppm
Notes / Comments:									

Time in 30 minute increments (max)

<b>Pan Still</b>	Inst Tag No.	20:00	20:30	21:00	21:30				
Furnace Controller Temperature (L)	Yokogawa	1213	1201	1207	1218				
Still T/C Temperature	Still	Instrument not sending data							
Vapor Outlet Temperature (R)	TR-1000	235	211	187	175				
Vapor Outlet Pressure (R)	0.84	0.73	0.71	0.79	-7.21				
<b>Condenser</b>	Inst Tag No.	Time in 30 minute increments (max)							
Condenser Overflow Temp (R)	TR-1007	124	123	121	119				
Condenser Outlet Temp (R)	TR-1012	104	95	90	112				
Eductor Inlet Pressure (R)	PR-1003	-1.91	-2.27	-1.46	-5.80				
<b>Water Circulation System</b>									
Condenser Spray Pressure (L)	PI-1011	42	45	28	30				
Condenser Spray Temp. ( R )	TR-1004	126	125	123	121				
Eductor Water Pressure (L)	PI-1010	6	4	4	3				
Recirc Pump Outlet Pressure (L)	PI-1009	43	45	29	30				
Recirc Pump VFD Hertz (R)	SIC-1008	45	45	35	35				
<b>Miscellaneous</b>	Inst Tag No.								
Overpak Drum Water Temp (L)	TC-1006	117	118	116	116				
Recirc Tank Water Temp (L)		134	134	132	129				
KWH Meter Reading (L)		1370	1373	1375	1376				
PH / PH3 / Misc (L)			0 ppm	0 ppm	0 ppm				
Notes / Comments:									

Test 10 Notes.

August 16, 2011

Run time. 13 hours – 248 pound charge – not agitated

Material Balance Summary. Sub = by subtraction

	Lab Analysis		Scale Weights
P4	sub 74.9		78.4
H2O	117.4	sub	107.9
Res	55.6		61.8

Material balance was less than 4% variance between lab analysis and actual weights.

Test Summary. Was not able to establish a connection between the Still T/C and the data recorder so establishing a clearly defined break point between the phases for water collection was not possible. Using the Vapor Line temperature and Kwh consumption also makes it more difficult to predict the completion of the Test. Once again the Vapor Line temperature fell rapidly over the final 3-4 hours of the run and testing the vapor line valve regularly provided an acceptable end result. The final hour of run time produced the same self-igniting blue/green flame from the vapor valve as previous tests.

A P2O5 trail from the vent stack began at 8:15. Added 60 SCFH of nitrogen to the top of the recycle tank to reduce the emissions. Tested various volumes of cold N2 in the recycle tank to reduce the P2O5 plume. 30 SCFH kept the vapor trail at about 3 feet. PH3 readings were +1000 ppm.

Vapor line valve leak. While washing the vapor line at the end of the test, steam started coming out of a disconnected nitrogen supply line attached to the Still. The plug valve on top of the Still lid was pressure tested later and confirmed to be leaking. Still pictures from Test 9 and Test 10 (attached) indicate the plug valve was most likely leaking during cleanup on Test 9. Test 8 was a failed test so Still pictures are not available.

Residue. When the Still was opened there was very little smoke and no flames. Temperature of the residue was 220F. as the Still was removed from the furnace that morning. There was very little yellow coloring in the residue or on the Still walls. Digital photos are attached. No Phos acid was found around the Still to lid interface. The residue did not ignite when exposed to flame and was not reactive when mixed with water. PH3 readings were 0.60 with a slight H2S or sulfur odor. A residue sample was tested and yielded 6 ppm for H2S (Draeger tubes). There are potential phosphine interference issues to be considered and additional testing will be conducted on Test 11 and 12.

Tested the condenser and recycle tank water PH when the phosphorus in each tank was drained to drums. Condenser = PH of 4. Recycle tank = PH of 2.

**TEST 11**

**OPERATOR LOG SHEETS**

**2011 Rhodia Phosphorus**

---

**Recovery Pilot Project**

---

---

---



Time in 30 minute increments (max)

<b>Pan Still</b>	Inst Tag No.	07:35	08:00	08:30	09:00	09:30	10:00	10:30	11:00
Furnace Controller Temperature (L)	Yokogawa	219	626	670	677	692	681	687	687
Still T/C Temperature	Still	Instrument not sending data						206 *	207
Vapor Outlet Temperature (R)	TR-1000	180	204	257	259	253	264	258	261
Vapor Outlet Pressure (R)	PR-1002	0.58	0.65	-6.90	-1.76	-1.05	1.58	1.82	-0.85
<b>Condenser</b>	Inst Tag No.	Time in 30 minute increments (max)							
Condenser Overflow Temp (R)	TR-1007	99	100	144	143	139	140	138	132
Condenser Outlet Temp (R)	TR-1012	89	70	92	106	100	103	98	99
Eductor Inlet Pressure (R)	PR-1003	-0.88	-0.65	-7.82	-0.13	-2.69	-0.60	-0.81	-0.92
<b>Water Circulation System</b>	Inst Tag No.	Time in 30 minute increments (max)							
Condenser Spray Pressure (L)	PI-1011	28	28	35	30	28	28	28	28
Condenser Spray Temp. ( R )	TR-1004	109	109	126	117	111	112	111	100
Eductor Water Pressure (L)	PI-1010	2	2	3	5	6	6	6	6
Recirc Pump Outlet Pressure (L)	PI-1009	29	30	36	31	29	29	30	30
Recirc Pump VFD Hertz (R)	SIC-1008	35	35	40	40	40	40	40	40
<b>Miscellaneous</b>	Inst Tag No.	Time in 30 minute increments (max)							
Overpak Drum Water Temp (L)	TC-1006	124	124	125	125		125		
Recirc Tank Water Temp (L)		116	116	1132	123	118	119	118	116
KWH Meter Reading (L)		1378	1388	1396	1406	1416	1427	1436	1447
PH / PH3 / Misc (L)			320 ppm		0 ppm		75 ppm		530 ppm
Notes / Comments: Using 2'0 long digital temperature gauge (358 deg. F max.)									



## Time in 30 minute increments (max)

<b>Pan Still</b>	Inst Tag No.	15:30	16:00	16:30	17:00	17:17			
Furnace Controller Temperature (L)	Yokogawa	1198	1199	1199	1201	1188			
Still T/C Temperature	Still	1180 *	1193	1193	1187	1184			
Vapor Outlet Temperature (R)	TR-1000	331	260	218	182	176			
Vapor Outlet Pressure (R)	PR-1002	0.64	0.83	0.93	-0.28	0.28			
<b>Condenser</b>	Inst Tag No.	Time in 30 minute increments (max)							
Condenser Overflow Temp (R)	TR-1007	123	122	121	120	123			
Condenser Outlet Temp (R)	TR-1012	112	112	112	111	100			
Eductor Inlet Pressure (R)	PR-1003	-1.37	-1.33	-1.28	-2.26	-1.76			
<b>Water Circulation System</b>	Inst Tag No.	Time in 30 minute increments (max)							
Condenser Spray Pressure (L)	PI-1011	11	11	28	28	25			
Condenser Spray Temp. ( R )	TR-1004	131	131	129	128	126			
Eductor Water Pressure (L)	PI-1010	5	5	5	5	3			
Recirc Pump Outlet Pressure (L)	PI-1009	31	31	30	30	28			
Recirc Pump VFD Hertz (R)	SIC-1008	40	40	40	40	35			
<b>Miscellaneous</b>	Inst Tag No.	Time in 30 minute increments (max)							
Overpak Drum Water Temp (L)	TC-1006	125	125	123	123	123			
Recirc Tank Water Temp (L)		137	137	136	134	134			
KWH Meter Reading (L)		1503	1506	1509	1511	1512			
PH / PH3 / Misc (L)		33 ppm							
Notes / Comments: Hard wired spare T/C direct to data recorder									

## Time in 30 minute increments (max)

<b>Pan Still</b>	Inst Tag No.	11:30	12:00	12:30	13:00	13:30	14:00	14:30	15:00
Furnace Controller Temperature (L)	Yokogawa	747	961	1115	1163	1185	1186	1199	1196
Still T/C Temperature	Still	222 *	297						
Vapor Outlet Temperature (R)	TR-1000	279	300	330	372	437	418	365	351
Vapor Outlet Pressure (R)	PR-1002	1.27	1.20	-0.87	0.89	0.77	0.92	0.66	0.72
<b>Condenser</b>	Inst Tag No.	Time in 30 minute increments (max)							
Condenser Overflow Temp (R)	TR-1007	132	129	129	128	123	123	118	122
Condenser Outlet Temp (R)	TR-1012	107	103	109	105	109	111	115	112
Eductor Inlet Pressure (R)	PR-1003	-0.92	-0.97	-1.29	-1.17	-1.78	-1.23	-1.34	-1.36
<b>Water Circulation System</b>	Inst Tag No.	Time in 30 minute increments (max)							
Condenser Spray Pressure (L)	PI-1011	26	22	22	22	22	23	24	27
Condenser Spray Temp. ( R )	TR-1004	122	125	129	129	128	129	130	130
Eductor Water Pressure (L)	PI-1010	5	8	8	8	8	6	6	5
Recirc Pump Outlet Pressure (L)	PI-1009	30	26	26	26	26	28	28	31
Recirc Pump VFD Hertz (R)	SIC-1008	40	40	40	40	40	40	40	40
<b>Miscellaneous</b>	Inst Tag No.	Time in 30 minute increments (max)							
Overpak Drum Water Temp (L)	TC-1006	128		125	125	1124	124	125	124
Recirc Tank Water Temp (L)		128	132	136	136	135	136	137	137
KWH Meter Reading (L)		1453	1463	1473	1480	1488	1494	1497	1500
PH / PH3 / Misc (L)		1000+ ppm			1000+ ppm	1000+ ppm			38 ppm
Notes / Comments: Using 2'0 long digital temperature gauge (358 deg. F max.)									

Test 11 Notes.

August 23, 2011

Run time. 9:42 hours – 253 pound charge – not agitated

Material Balance Summary. Sub = by subtraction

	Lab Analysis (lbs)		Scale Weights (lbs)
P4	sub 91.8		34.5
H2O	98.5	sub	163.9
Res	55.6		49.7

The lab analysis to actual weights variance was huge. As the bulk of the difference was P4 and water the error was likely in determining the quantity of water in the lab sample.

Test Summary. Continued difficulties establishing a wireless connection between the Still T/C and the data recorder. Utilized a long probe digital temperature gauge during the water phase (up to 350F) to record the Still temperatures shown on the operator log. Was able to hard wire the Still T/C to the data recorder late in the run. Still temperatures recorded after 15:30 should be accurate. Added 1-2 gallons of makeup water thru out the water phase to control recycle water temperatures.

Residue. When the Still was opened there was very little smoke and no flames. Temperature of the residue was 50F. There was a light yellow colored dust layer on the Still walls. Easily removed with hand tools. The Still lid was very clean. Digital photos are attached. No Phos acid was found around the Still to lid flange. The residue did not ignite when exposed to flame and was not reactive when mixed with water. PH3 and H2S readings were 0.00. Tested the condenser and recycle tank water PH when the phosphorus in each tank was drained to drums. Condenser = PH of 2. Recycle tank = PH of 1.

The small quantity of P4 produced was of very good quality. There was no measurable dirt layer on top of the P4. 37% of the phosphorus recovered was from the recycle water tank.

Test 12 is Thursday, August 25<sup>th</sup>. 249 lb charge – agitated.

**TEST 12**  
**OPERATOR LOG SHEETS**  
**2011 Rhodia Phosphorus**  

---

**Recovery Pilot Project**

---



## Time in 30 minute increments (max)

<b>Pan Still</b>	Inst Tag No.	09:00	09:30	10:00	10:30	11:00	11:30	12:00	12:30
Furnace Controller Temperature (L)	Yokogawa	137	611	643	674	671	695	718	754
Still T/C Temperature	Still	132	155	203	202	202	203	202	203
Vapor Outlet Temperature (R)	TR-1000	374	332	268	266	261	262	265	290
Vapor Outlet Pressure (R)	PR-1002	0.59	0.72	1.68	1.37	0.52	1.44	1.35	1.01
<b>Condenser</b>	Inst Tag No.	Time in 30 minute increments (max)							
Condenser Overflow Temp (R)	TR-1007	92	113	145	141	145	143	135	123
Condenser Outlet Temp (R)	TR-1012	61	71	80	81	77	83	82	84
Eductor Inlet Pressure (R)	PR-1003	-0.99	-0.89	-0.31	-0.76	-1.49	-0.91	-0.92	-1.17
<b>Water Circulation System</b>	Inst Tag No.	Time in 30 minute increments (max)							
Condenser Spray Pressure (L)	PI-1011	27	25	25	25	25	25	25	25
Condenser Spray Temp. ( R )	TR-1004	113	109	121	120	127	128	124	120
Eductor Water Pressure (L)	PI-1010	3	3	3	3	3	3	3	3
Recirc Pump Outlet Pressure (L)	PI-1009	29	29	29	29	29	29	29	29
Recirc Pump VFD Hertz (R)	SIC-1008	35	35	35	35	35	35	35	35
<b>Miscellaneous</b>	Inst Tag No.	Time in 30 minute increments (max)							
Overpak Drum Water Temp (L)	TC-1006	125	125	126	125	126	126	125	124
Recirc Tank Water Temp (L)		119	116	124	127	134	135	131	127
KWH Meter Reading (L)		1513	1522	1532	1542	1550	1558	1565	1571
PH / PH3 / Misc (L)			350 ppm		414 ppm		464 ppm	436 ppm	
Notes / Comments:									

## Time in 30 minute increments (max)

<b>Pan Still</b>	Inst Tag No.	13:00	13:30	14:00	14:30	15:00	15:30	16:00	16:30
Furnace Controller Temperature (L)	Yokogawa	733	975	987	1113	1050	1107	1187	1225
Still T/C Temperature	Still	217	473	492	512	562	637	748	827
Vapor Outlet Temperature (R)	TR-1000	306	329	450	474	409	388	387	375
Vapor Outlet Pressure (R)	PR-1002	0.76	0.80	1.07	1.17	0.95	0.91	0.99	0.91
<b>Condenser</b>	Inst Tag No.	Time in 30 minute increments (max)							
Condenser Overflow Temp (R)	TR-1007	122	120	120	133	133	121	131	131
Condenser Outlet Temp (R)	TR-1012	85	87	83	92	88	86	92	93
Eductor Inlet Pressure (R)	PR-1003	-0.88	-0.87	-0.82	-0.82	-0.75	-0.84	-0.92	-0.87
<b>Water Circulation System</b>	Inst Tag No.	Time in 30 minute increments (max)							
Condenser Spray Pressure (L)	PI-1011	25	25	25	25	25	25	25	25
Condenser Spray Temp. ( R )	TR-1004	121	122	123	133	136	132	133	133
Eductor Water Pressure (L)	PI-1010	3	3	3	3	3	3	3	3
Recirc Pump Outlet Pressure (L)	PI-1009	29	29	29	28	28	29	29	29
Recirc Pump VFD Hertz (R)	SIC-1008	35	35	35	35	35	35	35	35
<b>Miscellaneous</b>	Inst Tag No.	Time in 30 minute increments (max)							
Overpak Drum Water Temp (L)	TC-1006	123	123	123	123	122	122	122	122
Recirc Tank Water Temp (L)		128	129	129	142	144	144	140	141
KWH Meter Reading (L)		1576	1586	1596	1609	1612	1613	1623	1625
PH / PH3 / Misc (L)			1000+ ppm		1000+ ppm		175 ppm		2 ppm
Notes / Comments:									



## Time in 30 minute increments (max)

<b>Pan Still</b>	Inst Tag No.	17:00	17:30	18:10	18:40				
Furnace Controller Temperature (L)	Yokogawa	1207	1205	1193	1200				
Still T/C Temperature	Still	902	934	961	978				
Vapor Outlet Temperature (R)	TR-1000	326	272	229	216				
Vapor Outlet Pressure (R)	PR-1002	0.79	0.82	0.73	0.68				
<b>Condenser</b>	Inst Tag No.	Time in 30 minute increments (max)							
Condenser Overflow Temp (R)	TR-1007	131	130	127	124				
Condenser Outlet Temp (R)	TR-1012	88	81	76	76				
Eductor Inlet Pressure (R)	PR-1003	-0.90	-1.11	-1.86	-2.23				
<b>Water Circulation System</b>	Inst Tag No.	Time in 30 minute increments (max)							
Condenser Spray Pressure (L)	PI-1011	25	26	26	27				
Condenser Spray Temp. ( R )	TR-1004	133	132	129	128				
Eductor Water Pressure (L)	PI-1010	3	2	2	2				
Recirc Pump Outlet Pressure (L)	PI-1009	28	28	28	29				
Recirc Pump VFD Hertz (R)	SIC-1008	35	35	35	35				
<b>Miscellaneous</b>	Inst Tag No.	Time in 30 minute increments (max)							
Overpak Drum Water Temp (L)	TC-1006	122	122	122	122				
Recirc Tank Water Temp (L)		141	141	138	138				
KWH Meter Reading (L)		1629	1632	1634	1637				
PH / PH3 / Misc (L)			3 ppm		0 ppm				
Notes / Comments:									

Run time. 9 hours 45 minutes – 249 pound charge – agitated

Material Balance Summary. Sub = by subtraction

	Lab Analysis		Scale Weights
P4	sub 86.7		81.3
H2O	109.1	sub	120.5
Residue	53.3		47.2

Test Summary. Test 12 water overflow from Phase I was within 30 minutes of startup with a Still temperature of 155F which is less than the expected +190F. The Phase I temperature plateau was also ~15F lower than the 215-217F normally experienced. During the water boil phase it is almost impossible to fine tune the vapor line and eductor pressures with the fluctuations being more severe than those in Phase II. During Test 12 the system pressure was controlled with a second condenser spray without using the eductor at all. A second condenser spray also appeared to help control recycle water temperature spikes during Phase I. A P2O5 vapor trail from the vent stack was also observed with 30 minutes of startup. Adding cold nitrogen to the top of the recycle tank helps reduce the plume.

About 6 hours into the run, the furnace controller tripped off. Typical electrical checks conducted were normal. The problem was finally traced to a faulty over temperature thermocouple at the furnace. Testing resumed shortly after isolating the T/C.

Another repeat indication of dust carryover during agitated test runs is the vapor line wash water. Test 11, non-agitated, had clean, clear wash water and only slightly cloudy recycle water. Test 12 vapor line wash water color was similar to chocolate milk and the recycle water was brown to dark gray. The pH of the condenser and recycle tank at the conclusion of the Test was 4 and 2 respectively. A picture of P4 produced is attached.

Residue. When the Still was opened there was no smoke or fire. Temperature of the residue was just above ambient. Digital photos are attached to provide a clearer definition of the residue material. No Phos acid was found around the Still to lid interface. The residue sample taken did not ignite when exposed to flame and was not reactive when mixed with water. PH3 readings were negligible. There was no indication of H2S in the Draeger tube, although there was a slight 'other' odor. There was a crust of residue continuous around the Still walls equal in depth to the gap between the agitator and Still wall. When the crust was disturbed, the cross section showed both a red and yellow layer. The digital photo will more accurately describe the finding. The Still wall would be on the left. The sample shown was quarantined for several days and re-examined. The red layer from the photo is no longer visible in the sample. Also note in another photo there is burning P4 in the residue at the bottom of the agitator. Similar to other agitated tests, the gap between the bottom of the agitator and the Still (~1/2") is very hard and will have to be removed with a chipping hammer. It is possible that the run was not complete even though the temperature indicators and vapor line valve checks indicated the run was finished. A spreadsheet of temperatures for agitated and non-agitated Tests is attached for additional information.

## **7.7 Pilot Recovery System Summary**

Rhodia Pilot Phosphorus Recovery System  
Summary of Test Runs 2011

Note: Times are Mountain

Variable	Test #1	Test #2	Test #3	Test #4	Test #5	Test #6	Test #7	Test #8	Test #9	Test #10	Test #11	Test #12	Averages & Sums
A Date	15-Jun-11	21-Jun-11	23-Jun-11	28-Jun-11	12-Jul-11	19-Jul-11	26-Jul-11	28-Jul-11	9-Aug-11	16-Aug-11	23-Aug-11	25-Aug-11	
B Day	Wed	Tues	Thurs	Thurs	Tues	Tues	Tues	Thurs	Tues	Tues	Tues	Thurs	
C Start Time	13:17	9:00	8:00	7:38	7:00	12:30	7:37	7:05	6:49	8:17	7:35	9:05	
D End Time	21:55	18:00	15:00	14:15	16:00	7:26	15:05	1:05	21:00	21:15	17:17	6:45	
E Duration Hrs.	8.63	9	7	6.62	9	19.4	7.5	18	14.22	13	9.75	9.67	11.0
F Drum/Sample #	12A	5B	5B	7	8	10	7	11	1	9	3	2	
G Charge Weight lbs.	178.8	175.4	176.4	248	346.8	347.7	253.1	362	247	248.1	253	249	257.1
H kwh consumed/batch	127.7	102.3	93.6	104.9	153.8	202	113	151	143.65	142.6	136	125.6	133.0
J N2 consumed/batch c.f.	540.5	762	760	400	see note	1925		2128	811	712	608	1574	1022.1
K Fce Ramp Rate	700 F Hrs. 3.5	3	1.5	0.4	3	4	3	5	5.5	2	4	4	
	1200 F Hrs. 0.75	3.75	5	6.2	3	3.5	4.5	8.5	8.72	11	5.75	5.67	
	1250 F Hrs. 2.5	2	0.5										
	1300 F Hrs. 2				2.5			4.5					
	1350 F Hrs.				0.5	1.25							
	1400 F Hrs.					3.75							
	1500 F Hrs.					7							
Total Heating Time	8.75	8.75	7	6.6	9	19.5	7.5	18	14.22	13	9.75	9.67	11.0
Lab Analysis													
L %P4	27	27.9	27.9	41.5	34.2	33	41.5	24.7	31.1	30.2	37	34.8	32.6
M % Residue	17.8	22.1	22.1	17.2	19.5	21.1	17.2	20.3	25.6	22.4	23.3	21.4	20.8
N % Water	55.2	50	50	41.3	46.3	45.9	41.3	55	43.3	47.3	39.7	43.8	46.6
Calculated Wt of Mtl from Lab Anal.													
P4	48.28	48.94	49.22	102.92	118.61	114.74	105.04	89.41	76.82	74.93	93.61	86.65	
Residue	31.83	38.76	38.98	42.66	67.63	73.36	43.53	73.49	63.23	55.57	58.95	53.29	
Water	98.70	87.70	88.20	102.42	160.57	159.59	104.53	199.10	106.95	117.35	100.44	109.06	
Total Weight Charged	178.80	175.40	176.40	248.00	346.80	347.70	253.10	362.00	247.00	247.85	253.00	249.00	
O Ratio P4/P4 + Residue%	60.3	55.8	55.8	70.7	63.7	61.0	70.7	54.9	54.9	57.4	61.4	61.9	60.7
P Ratio P4/Residue %	152	126	126	241	175	156	241	122	121	135	159	163	159.8
Q Clarifier Sample Location	Northeast	West B	West B	Southeast	Southeast	Southeast	Southeast	Northeast	Northeast	Southeast	West	West	
R Clarifier Depth	12'	4'	4'	4'	8'	8'	4'	8'	4'	12'	8'	8'	
Mtl Accounted For - Measured													
S P4 lbs	51.8	44.8	53.6	93.7	142.6	102.9	112.2	108.6	55.9	78.4	34.5	81.3	
T Residue lbs	36.9	65.4	48.1	47.8	64	99.2	44.1	98.7	64.1	61.8	49.7	47.2	
U Water (By Delta in Runs 1,2,5 & 6)	90.1	65.2	69	95.76	140.2	145.6	96.8	154.7	127.2	107.9	163.9	120.5	
V Unaccounted	0	0	5.7	10.9		0							
% Mtl Accounted For													
P4	29.0	25.5	30.4	37.8	41.1	29.6	44.3	30.0	22.6	31.6	13.6	32.7	33.5
Residue	20.6	37.3	27.3	19.3	18.5	28.5	17.4	27.3	26.0	24.9	19.6	19.0	24.5
Water	50.4	37.2	39.1	38.6	40.4	41.9	38.2	42.7	51.5	43.5	64.8	48.4	41.1
Unaccounted	0	0	3.2	4.4	0.0	0.0	0.0	0.0	0.0	0.0	0.0	0.0	
W Ratio P4/Residue measured %	140	69	111	196	223	104	254	110	87	127	69	172	150.9
X Phase 1 - Water Boil (start - 250F)													
Time - Hrs.	4.35	3.33	2.53	2.57	2.92	4.75	3	6.22	5.48	2.58		4	
Percentage Time Phase 1	50.4	37.0	36.1	38.8	32.4	24.5	40.0	34.6	38.5	19.8	0.0	41.4	36.7
Y Water Collected Phase 1 lbs			69	98.7		148.6		192.2					
Z Phase 2 - P4 Boil (250F - 630 F)													
Time - Hrs.	3.12	1.08	2.03	1.75	2.72	2.13	2.43	4.43	1.05			2.37	
Percentage Time Phase 2	36.2	12.0	29.0	26.4	30.2	11.0	32.4	24.6	7.4	0.0	0.0	24.5	25.2
AA Water Coll Phase 2 (Vol conv. to P4)			40.5	95.76		88.7		96.3	15.3				
BB Phase 3 - RAP Phase (630F - End)													
Time - Hrs.	1.16	4.58	2.28	2.3	3.37	12.52	2.07	7.22	7.68			3.3	
Percentage Time Phase 3	13.4	50.9	32.6	34.7	37.4	64.5	27.6	40.1	54.0	0.0	0.0	34.1	37.7
CC Water Coll Phase 3 (Vol conv. To P4)			3.6	0.9		11			30.6				
DD Total P4 Collected	51.8	44.8	44.1	96.66	142.6	99.7	112.2	96.3	45.9	78.4	0		
EE % RAP Vaporized (Estimated)			8.2	0.90%		11.0							
FF Residue Collected	36.9	65.4	48.1	47.8	64	99.2	44.1	98.7	64.1	61.8	49.7	47.2	
GG Total Material Accounted For lbs.			161.2	243.16		347.5		387.2	110	140.2	49.7	47.2	
Total Material Accounted For %			91.4	98.0		99.9		107					
HH Total Material Unaccounted For lbs.			15.2	4.84		0.2		-25.2					
Total Material Unaccounted For %			8.6	2.0		0.1		-7					
JJ AGITATION YES/NO	Yes	No	Yes	Yes	Yes	No	Yes	Yes	No	No	No	Yes	
KK Kwh/lb Charged	0.71	0.58	0.53	0.42	0.44	0.58	0.45	0.42	0.58	0.57	0.54	0.50	0.5
LL lbs treated/hr	20.72	19.49	25.20	37.46	38.53	17.92	33.75	20.11	17.37	19.08	25.95	25.75	26.6
Misc Info/Comments:	Hi Water Level Emer Valve Open ~19:00hr	Actual amt of residue much greater than lab analysis with correspondingly less water	Complete run dry black inert residue	P4 Rich Feed	Distinct Water and Yellow P4 Boils	Vent Stack Auto Lite 10:00-06:00	Water Coll. Difficult - >200 Gal of Makeup Water added Dur Water Ph.	Agit set to 0.5 RPM; Raised to 2 RPM @ 12:45	More H2 Coll in Ph. 3 than Ph. 2	Still temp not rec properly; cannot estim times of phases/when run comp	Con't diff in meas still temp; used long probe	Good Co-relat Lab & Mat Bal	
	Top 6" of still red/orange crust		very efficient run	P4 Recovery Dirty - 1-1.5" layer of dust on Top of P4	Eductor Probs	Still Temp Drops fr 521F to 457 F(84De) at ~18:00-18:10	Same Mtl as Test 4 - Hi P4 Content	~21:40 Press & Lo Temp Charts Bounce	up to 100' P2O5 plume within 2 hr of startup; reduced to 10' by cutting N2 & adding 2nd Condenser spray	Mtl Bal within 4% of Lab Analysis	Big Diff in Lab Anal. Vs amt of collected P4	H2O OF fr Ph 1 within 30 min (155F)	
	still opened hot residue had autocatalytic TR (RAP or Phosphide)	The Phase 3 (RAP phase) much longer than Test #1	P4 recovered was granular & some dirt contamination	Evidence of yellow crust on walls of still	Highest P4/Residue Ratio		Still "Burped" filled lines w Still Mtl at 13:00 hrs. - Near end of P4 Boil Ph ~630F in Still Note Temp Spike on Vap Line Temp & Pressure Spike AT 13:00	P2O5 plume within 30' of startup. At times dense & >100'	H2O O'Flow with in 15 min of SU	Final Hr prod same self igniting blue green flame	Very good qual P4 coll. 37% from Recyc Tank	Ph 1 Temp Plateau ~15 deg Lower than normal (215)	
		Residue crusted ~6" - 8" deep	first attempt to collect water to close balance	Odor in Residue	Odor in Residue	Odor in Residue		10:00 am water recycle pump strainer plugged w P4 - pressure drop fr 35-18 psi	Cond H2O pH 3; Recy Tk pH 5;	P2O5 plume from stack within 1st hr. N2 flow @ 30 cfh kept trail @ 3'	Residue Very little smoke; no flame; little yellow on walls; no PH3 or H2S; Non flam or react w H2O	2nd Cond Spray Helped control Recyc temp & System Press	
			phos acid ring around still lid to gasket interface	Sign carry over of dust in prod drum				Residue still had P4 upon opening	Fine red/yellow mtl in recy tank at end of water phase; P4?	PH3 read 1000 ppm			
			field ignitability & water reactivity tests negative					At end of H2O Ph agitator backing out of still 1/2 to 3/4" thru packing	Vap line self ign fr 18:00 to 19:30; ~20:30 light blue flame w small P2O5	Plug Valve on top of still leaking - also likely on run 9 & possibly 8 (Cause of P2O5 plume?)	Cond pH 2; Rec Tank pH 1;	P2O5 Vapor Tr within 30 min Adding Cold N2 to top of Recyc Tank helped plume	
								Residue smoky; PH3 liberated No TCLP Test Run SD early Poor Flamy residue	Res - little smoke no flame 220 F Little yellow color Did not ignite or react w water; PH3 read 0.6 Slight H2S or S Odor	Cond pH 4; Recyc Tank pH 2		About 6 hrs into run fce controller tripped for 42 min due to faulty TC TC isolated & power restored	
													Dust Carryover during agit runs; Vap line wash water like choc milk
													pHs of cond & recyc tanks 4 & 2 respectively
Table Color Legend:	White	1 and 3	175 #	Yes									
	Green	2	175 #	No									
	Yellow	4,7 & 12	250 #	Yes									
	Blue	9,10 & 11	250 #	No									
	Tan	5 and 8	350 #	Yes									
	Orange	6	350 #	No									
KK TCLP Test Results mg/l (Regul'd Level)													
Arsenic (5.0)	<.50	<.50	<.50	<.05	<.05	<.05		Residue Contaminated	Residue Contaminated	<.5	<.5	<.5	Residue Contaminated
Barium (100)	<.50	<.50	<.50		0.13	0.08		No TCLP Test	No TCLP Test	<.5	<.5	<.5	No TCLP Test
Cadmium (1.0)	2.69	0.72	2.03	0.43	1.56	2.53				2.65	1.45	<.5	
Chromium (5.0)	<.50	<.50	<.50	<.05	<.05	0.15				<.5	<.5	<.5	
Lead (5.0)	0.66	1.07	1.79	0.83	3.05	3.15			1.31	<.5	<.5	1.4	no smoke or fire on opening still
Mercury (0.2)	<.1	0.11	<.1	<.01	<.01	0.06				<.1	<.1	<.1	Some red/yellow on still sidewall
Selenium (1.0)	<.50	<.50	<.50	<.05	<.05	<.05				<.5	<.5	<.5	
Silver (5.0)	<.50	<.50	<.50	<.05	<.05	<.05				<.5	<.5	<.5	
	Fail	Pass	Fail	Pass	Fail	Fail			Fail	Fail	Pass		
													PH3 & H2S low/negligible; slight "other" odor
													After several days red layer in wall crust no longer visible
RETESTS													
TCLP Test Results mg/l (Regul'd Level)													
Arsenic (5.0)	<.05	<.05											Some evidence of P4 (RAP?) in residue at bottom of agitator ~1/2" very hard chipped out
Barium (100)	<.05	<.05											
Cadmium (1.0)		1.86	3.06										
Chromium (5.0)		0.11	&lt										

## **7.8 Graphs of Raw Data**



Run 1

6/15/2011

### Hi-Temperature Trend Chart

Vapor Line Temp °F    Furnace Temp °F    Still Temp °F

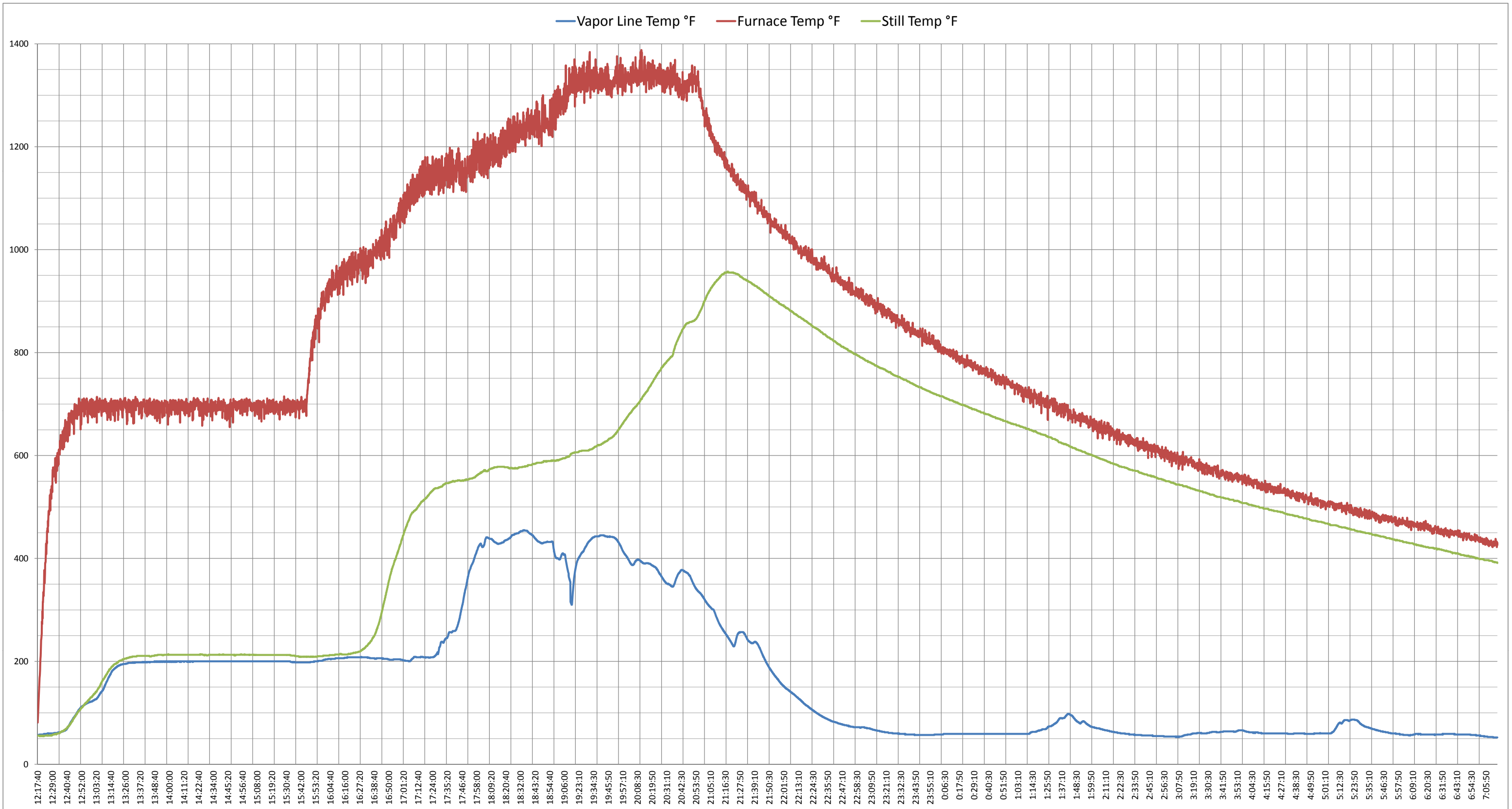

Run 1

6/15/2011

### Lo-Temperature Trend Chart

Cond O Flow Temp °F    Cond Outlet Temp °F

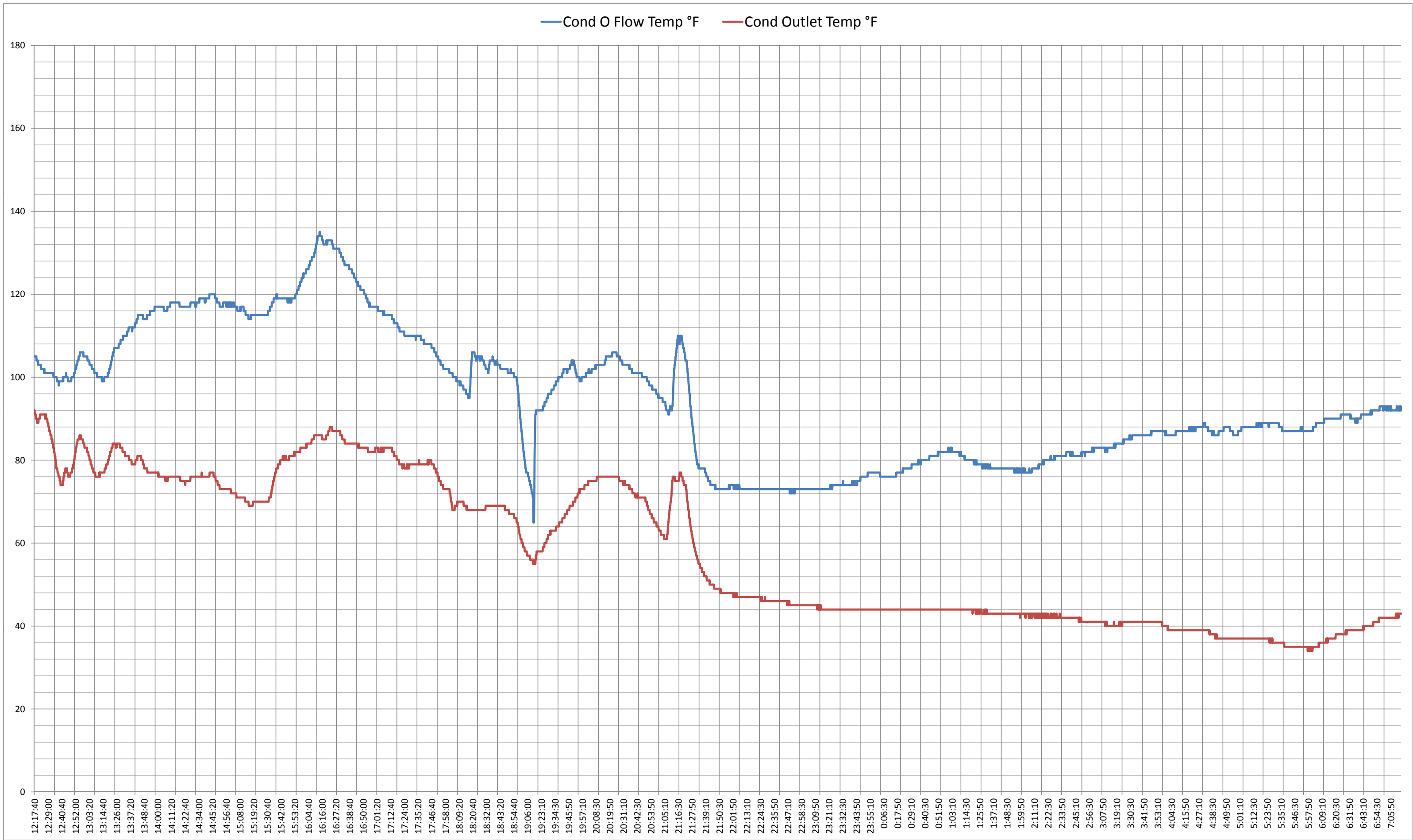

Run 1

6/15/2011

Pressure Trend Chart

Vapor Line Press WC Educor In Press WC

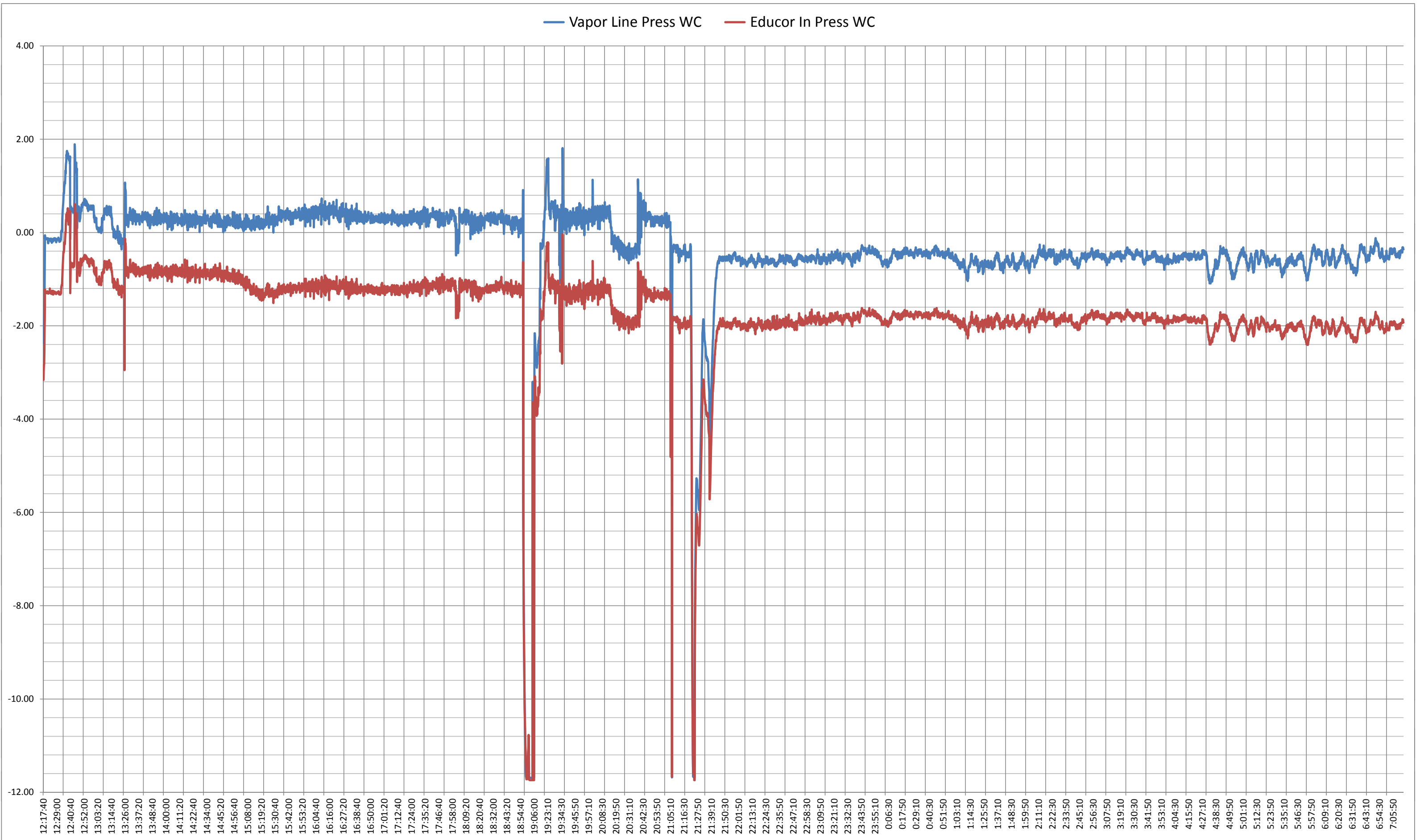

Run 1

6/15/2011

### Cumulative Power Trend Chart

— Cumulative kWh

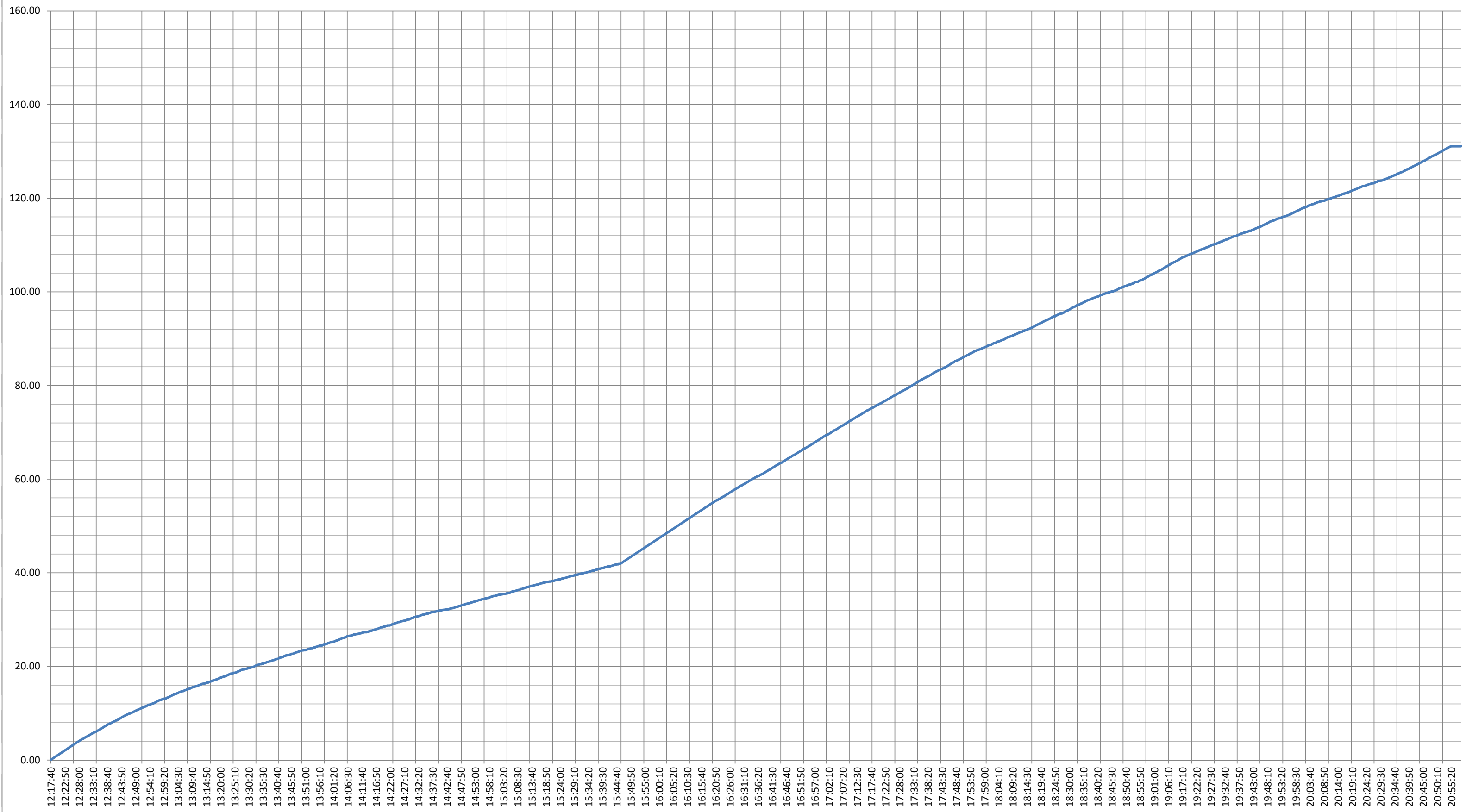

Run 2

6/23/2011

### Hi-Temperature Trend Chart

— Vapor Line Temp °F — Furnace Temp °F — Still Temp °F

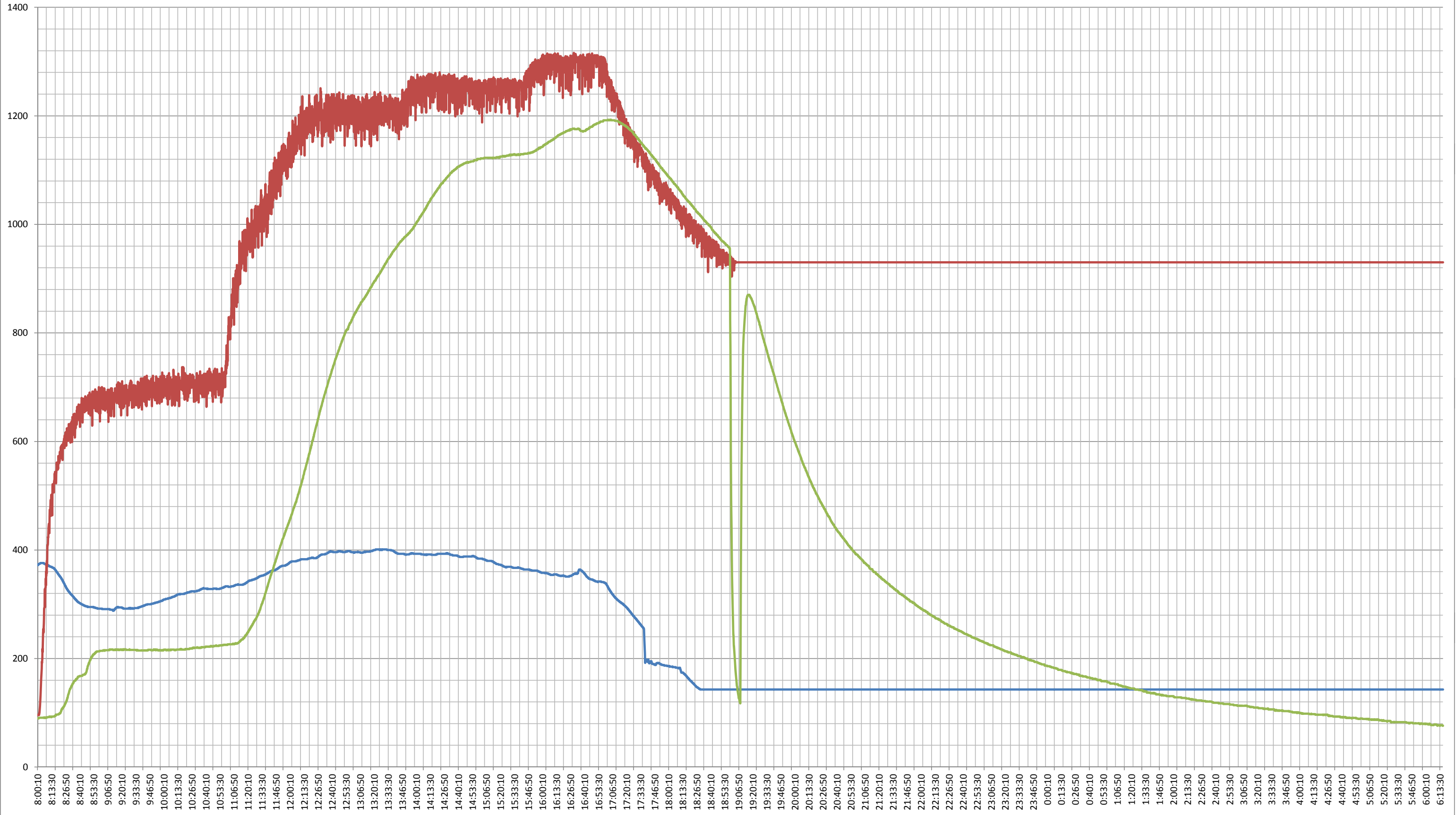



Run 2

6/23/2011

### Lo-Temperature Trend Chart

Cond O Flow Temp °F    Cond Outlet Temp °F

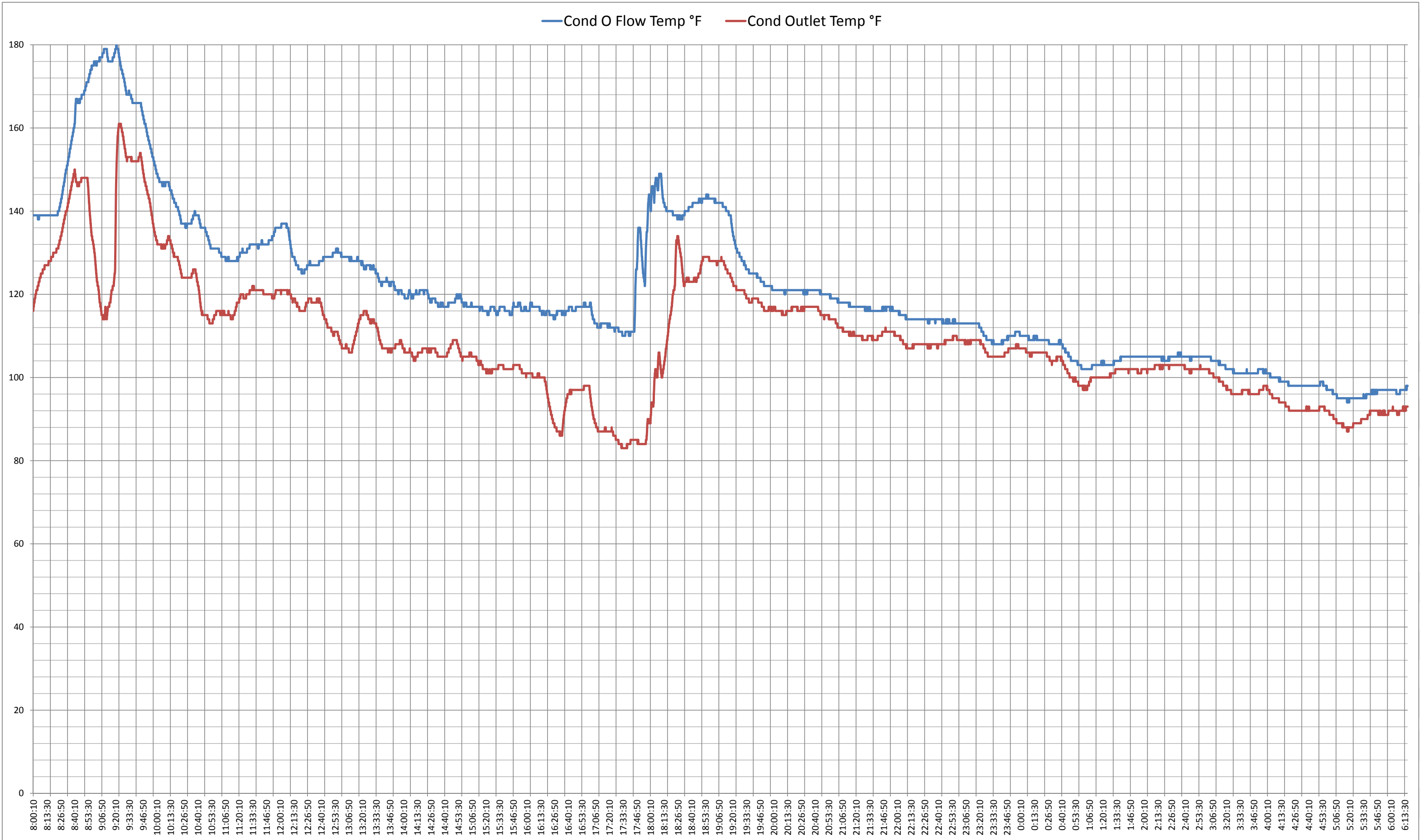

Vapor Line Press WC Educor In Press WC

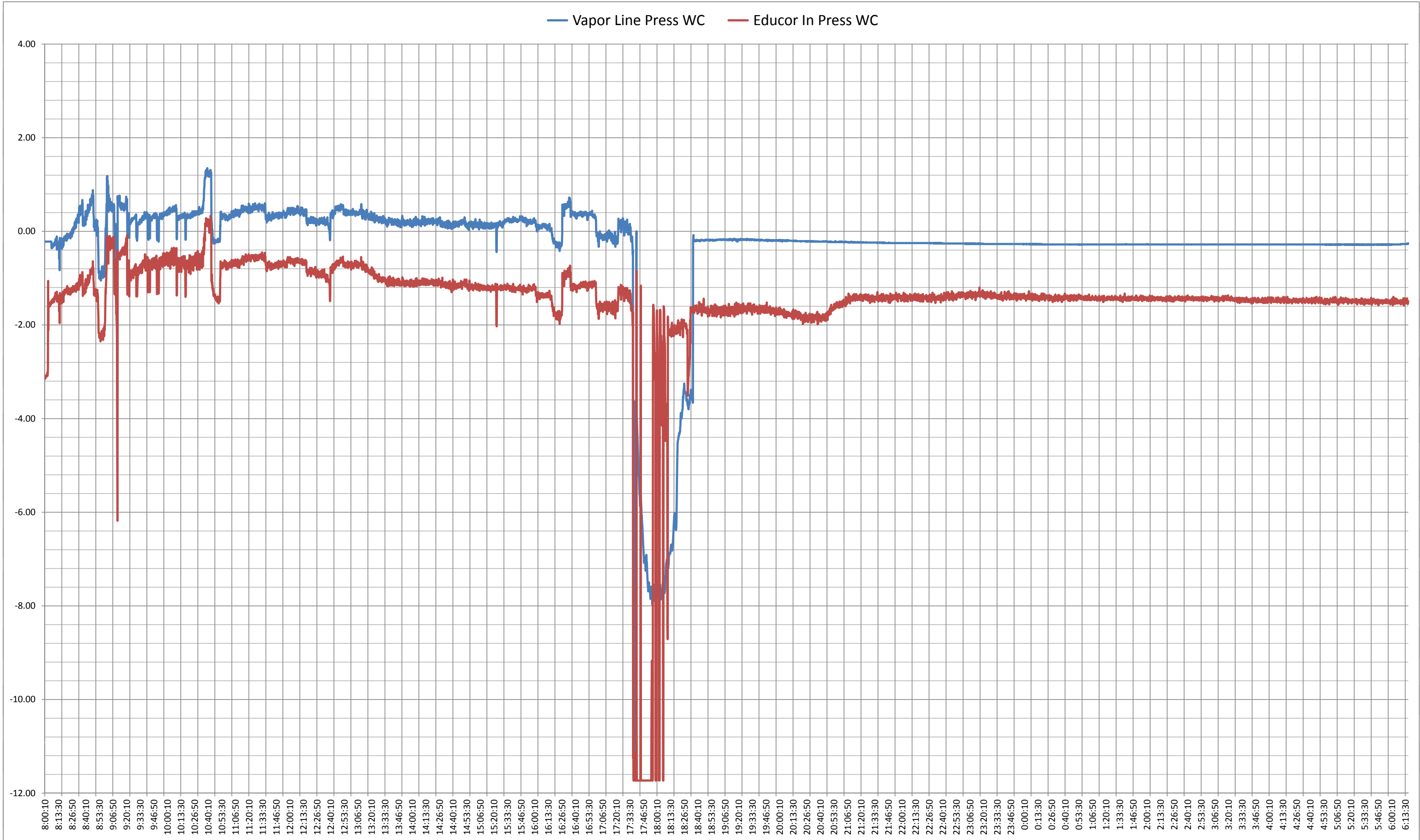

Cumulative kWh

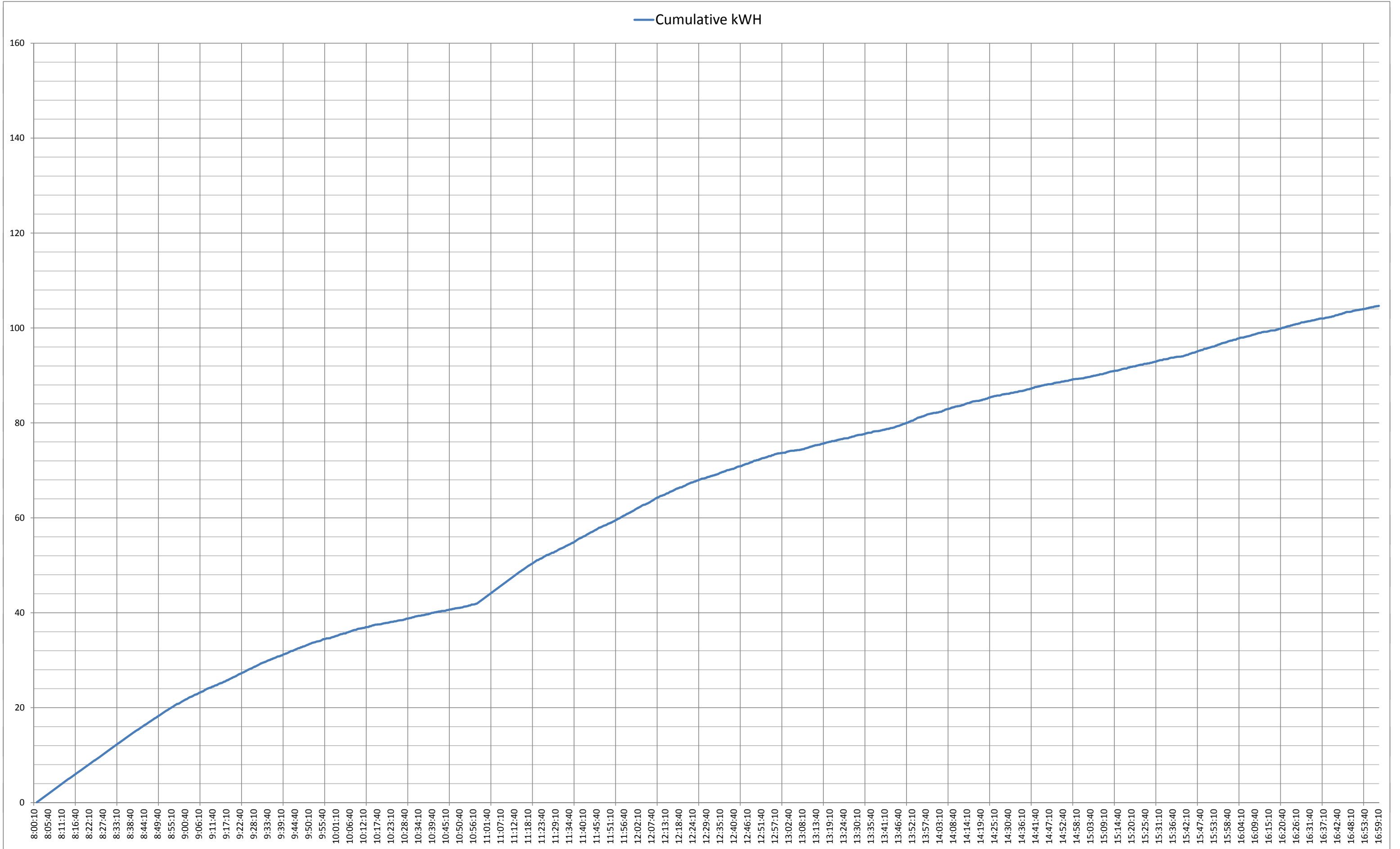

— Vapor Line Temp °F — Furnace Temp °F — Still Temp °F

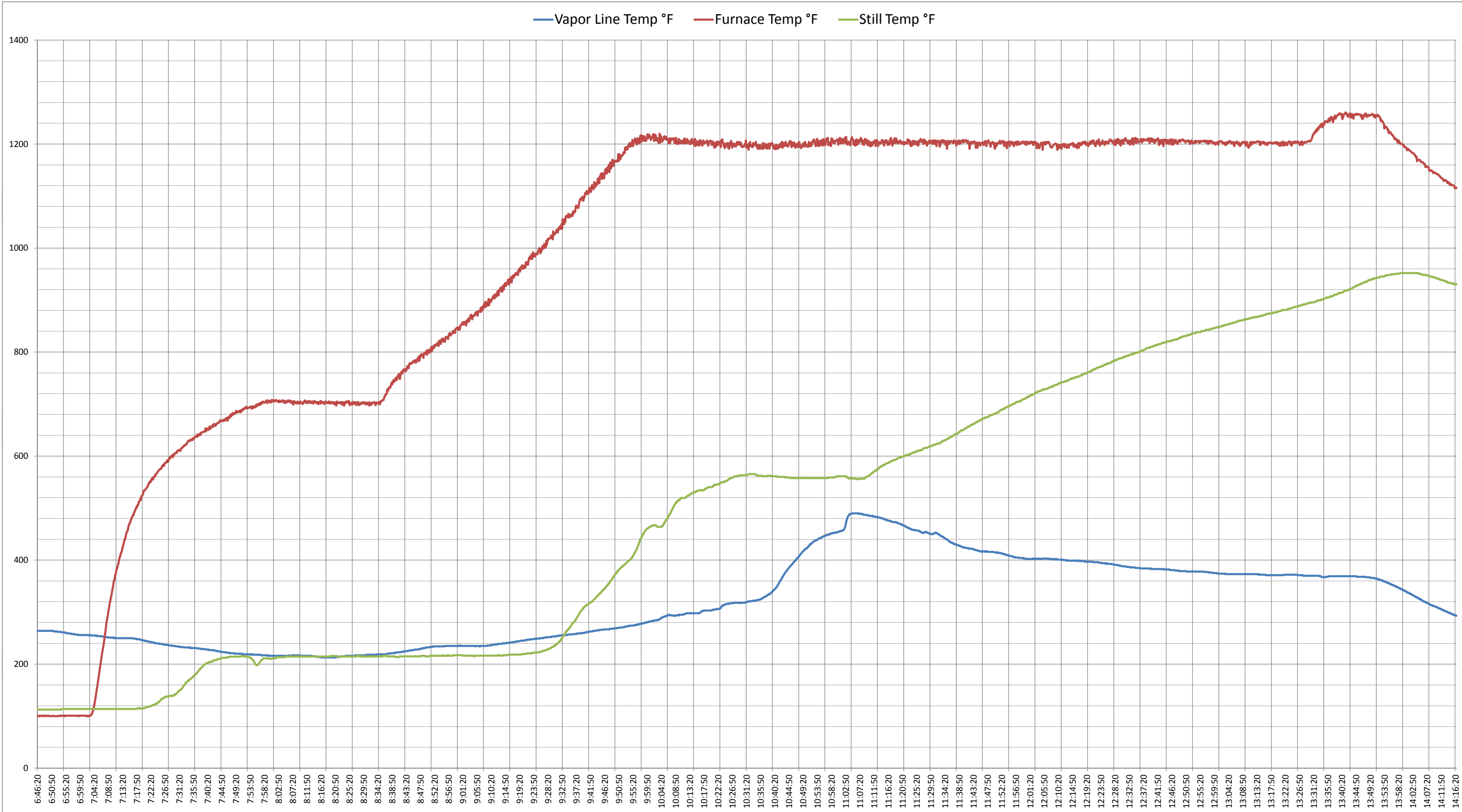

Cond O Flow Temp °F    Cond Outlet Temp °F

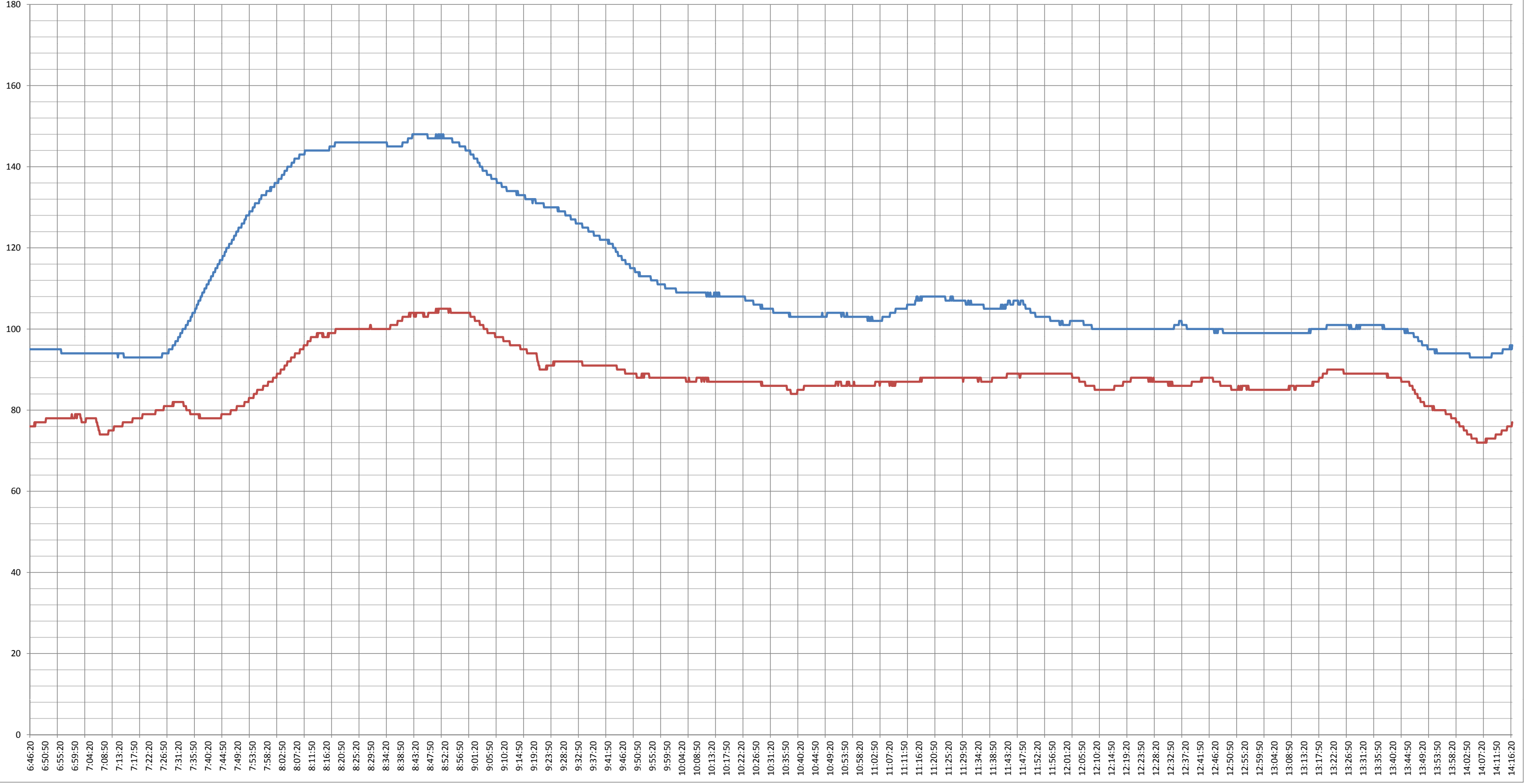

— Vapor Line Press WC — Educor In Press WC

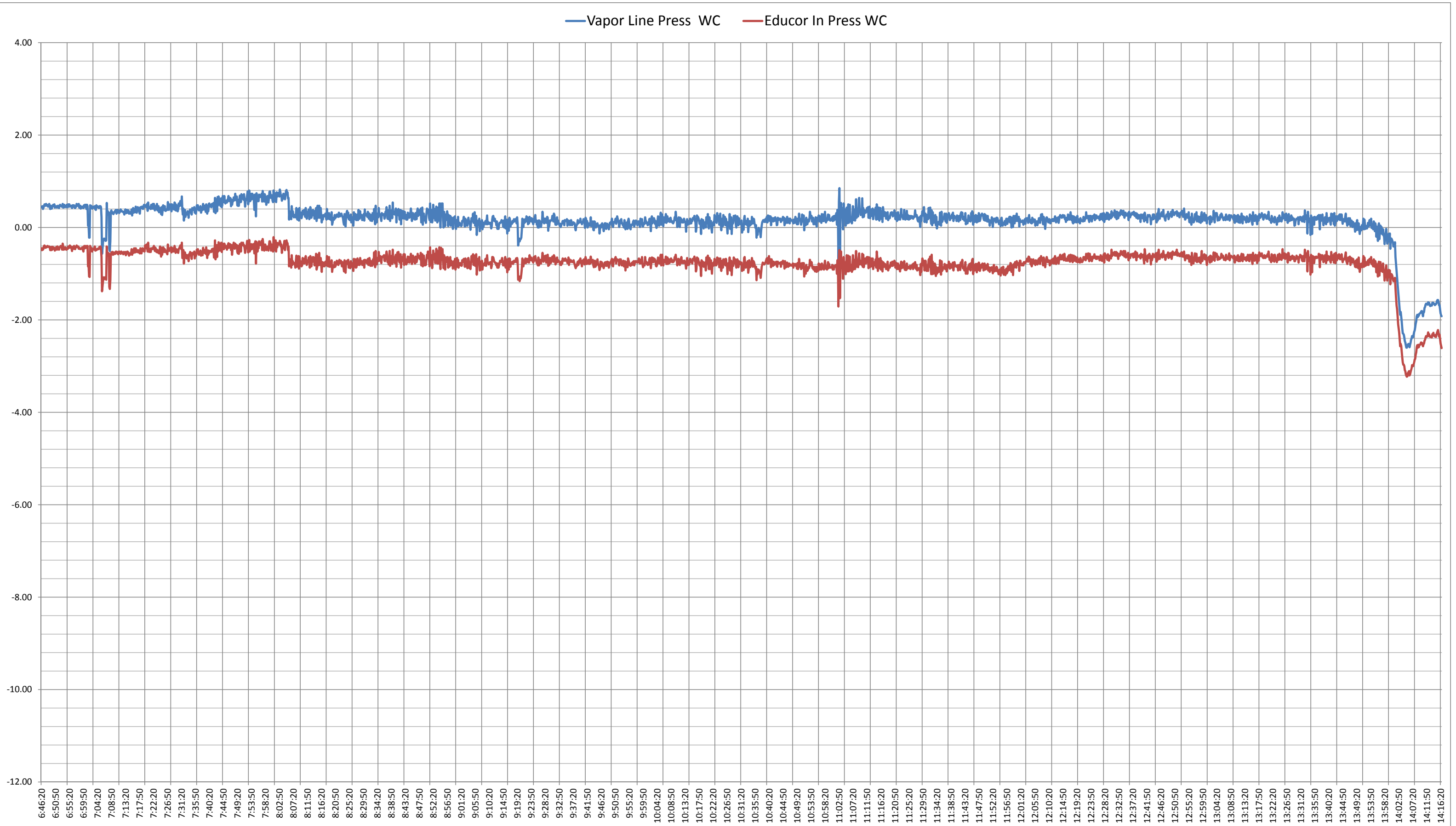



Cumulative kWh

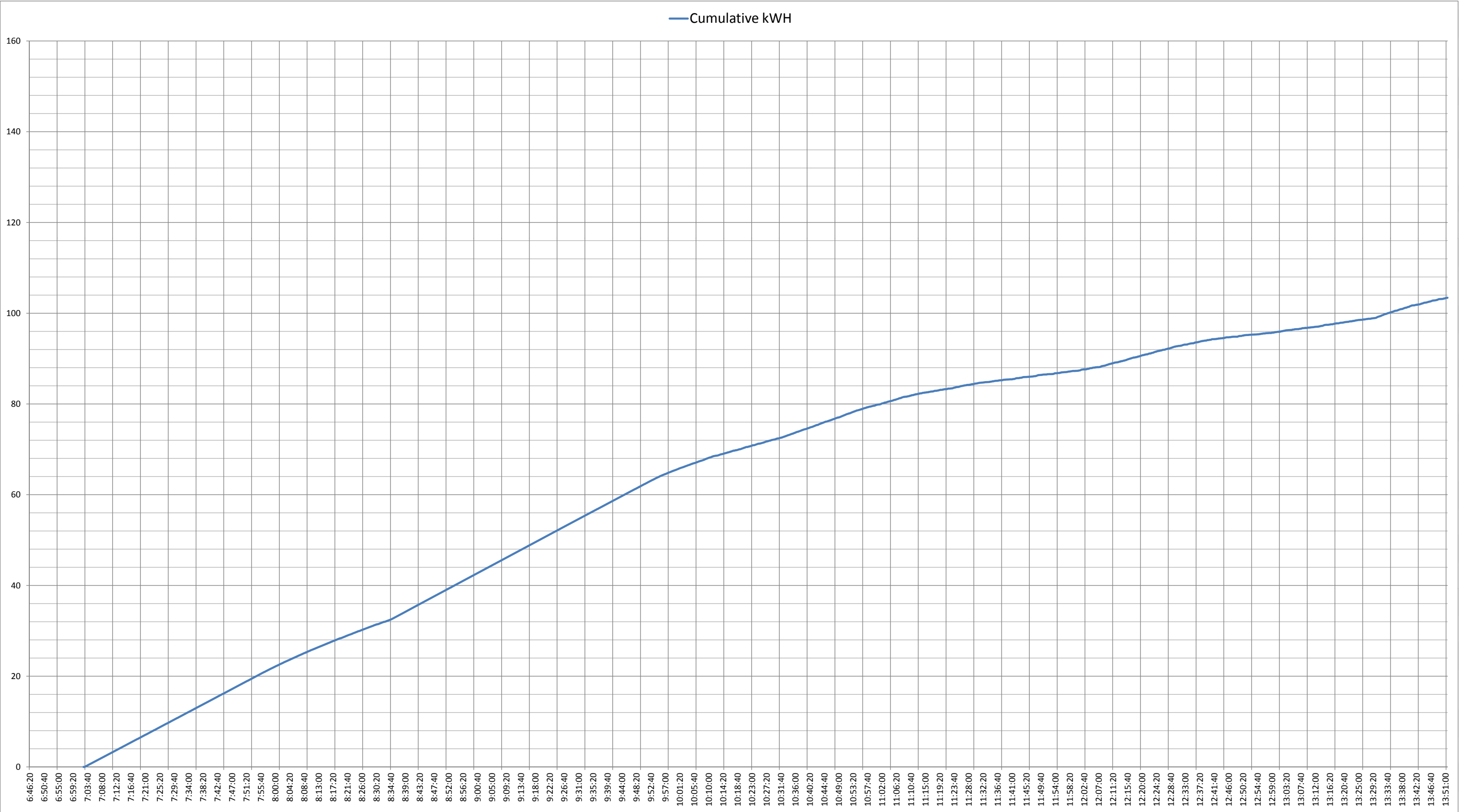

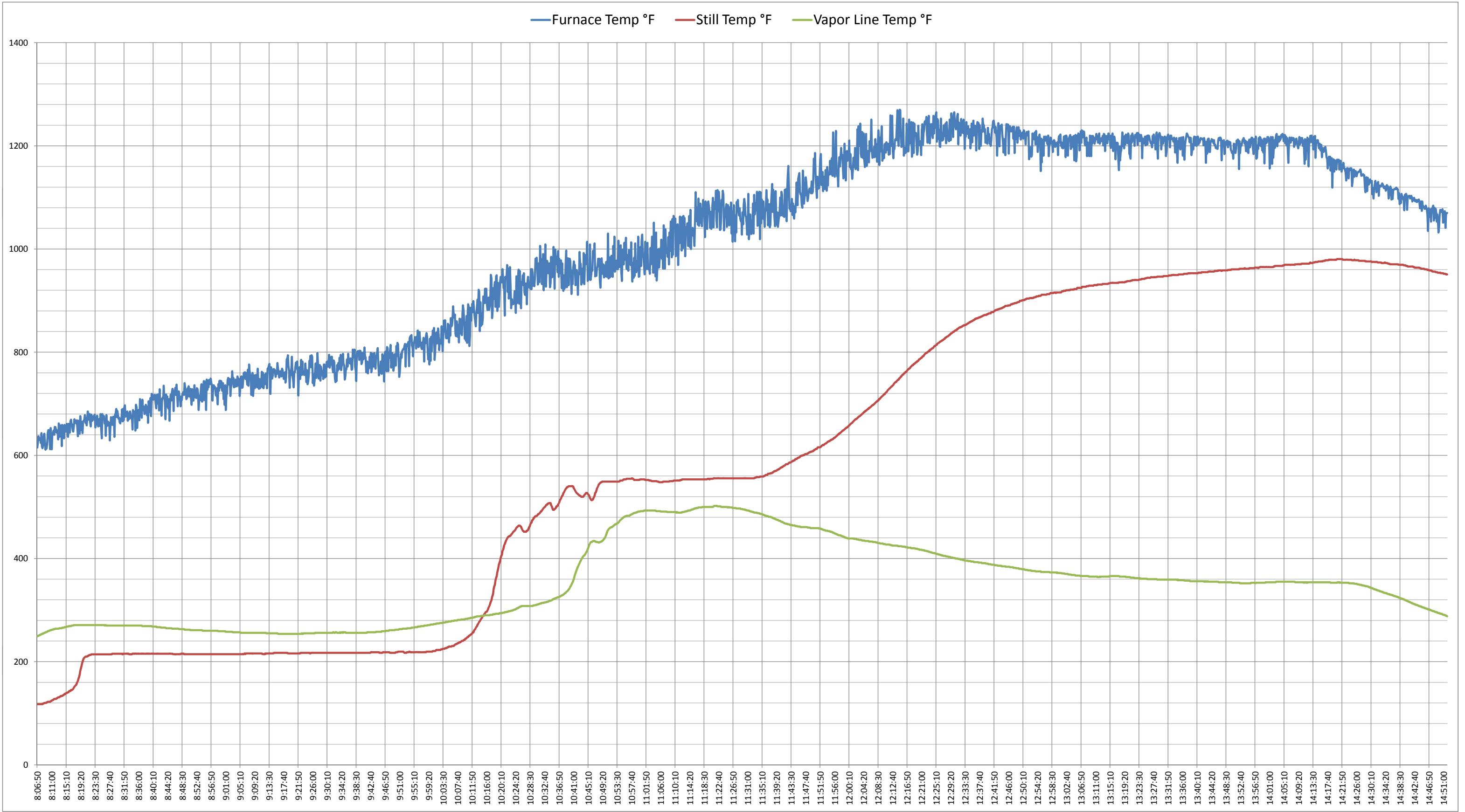

Run 4

6/28/2011

### Lo-Temperature Trend Chart

— Cond O Flow Temp °F — Cond Outlet Temp °F

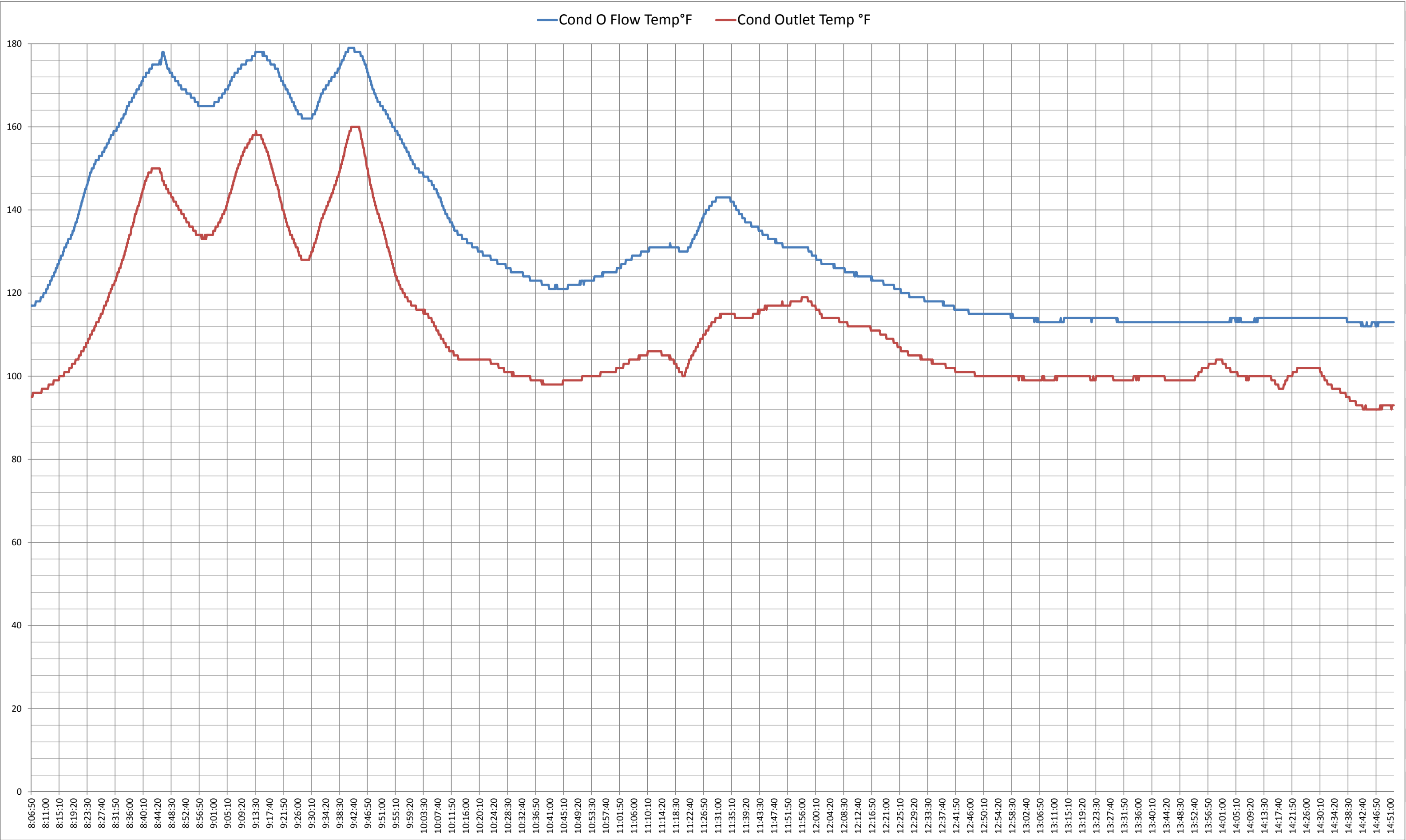

Run 4

6/28/2011

Pressure Trend Chart

Vapor Line Press WC Educor In Press WC

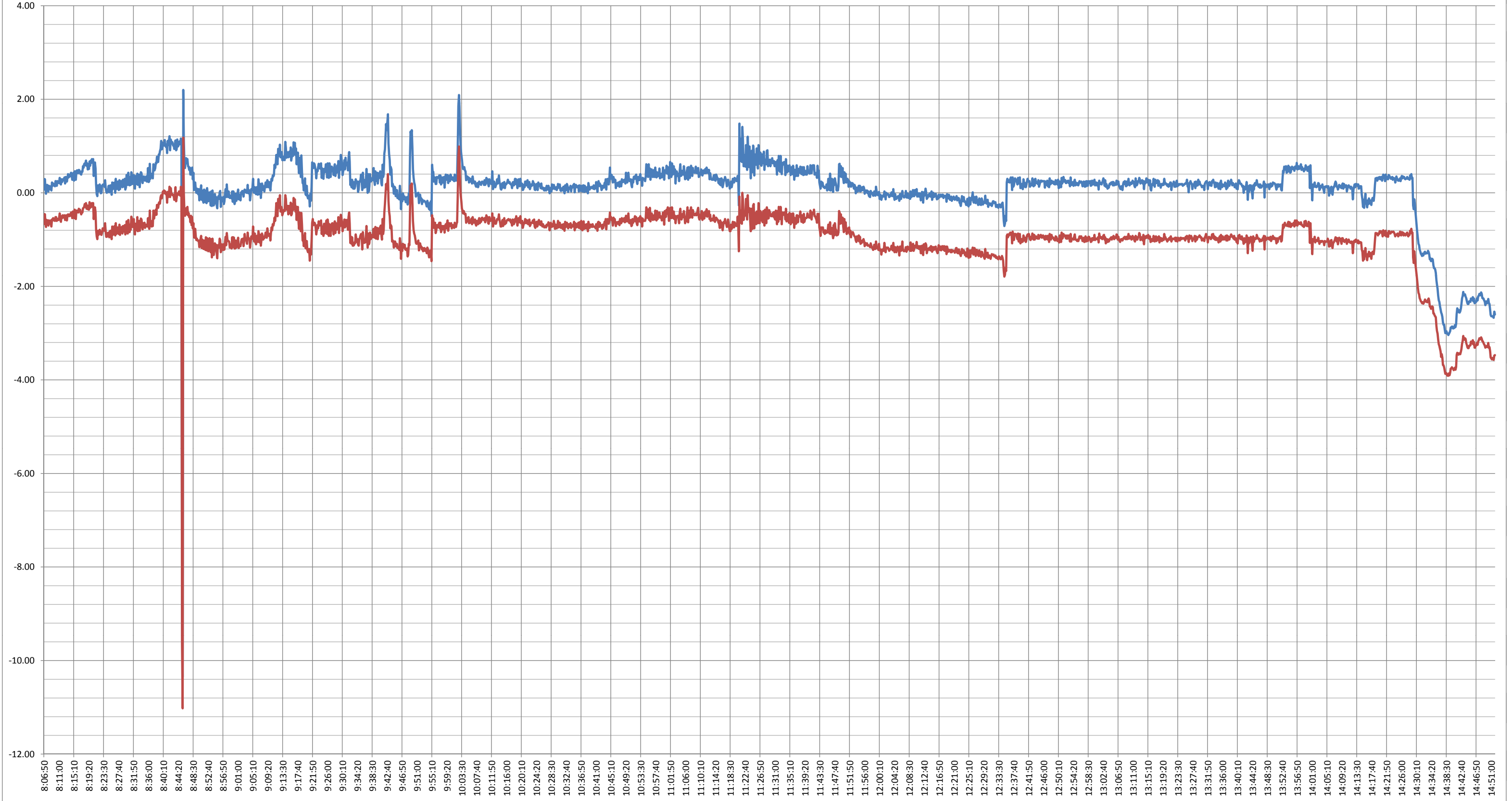

Cumulative kWh

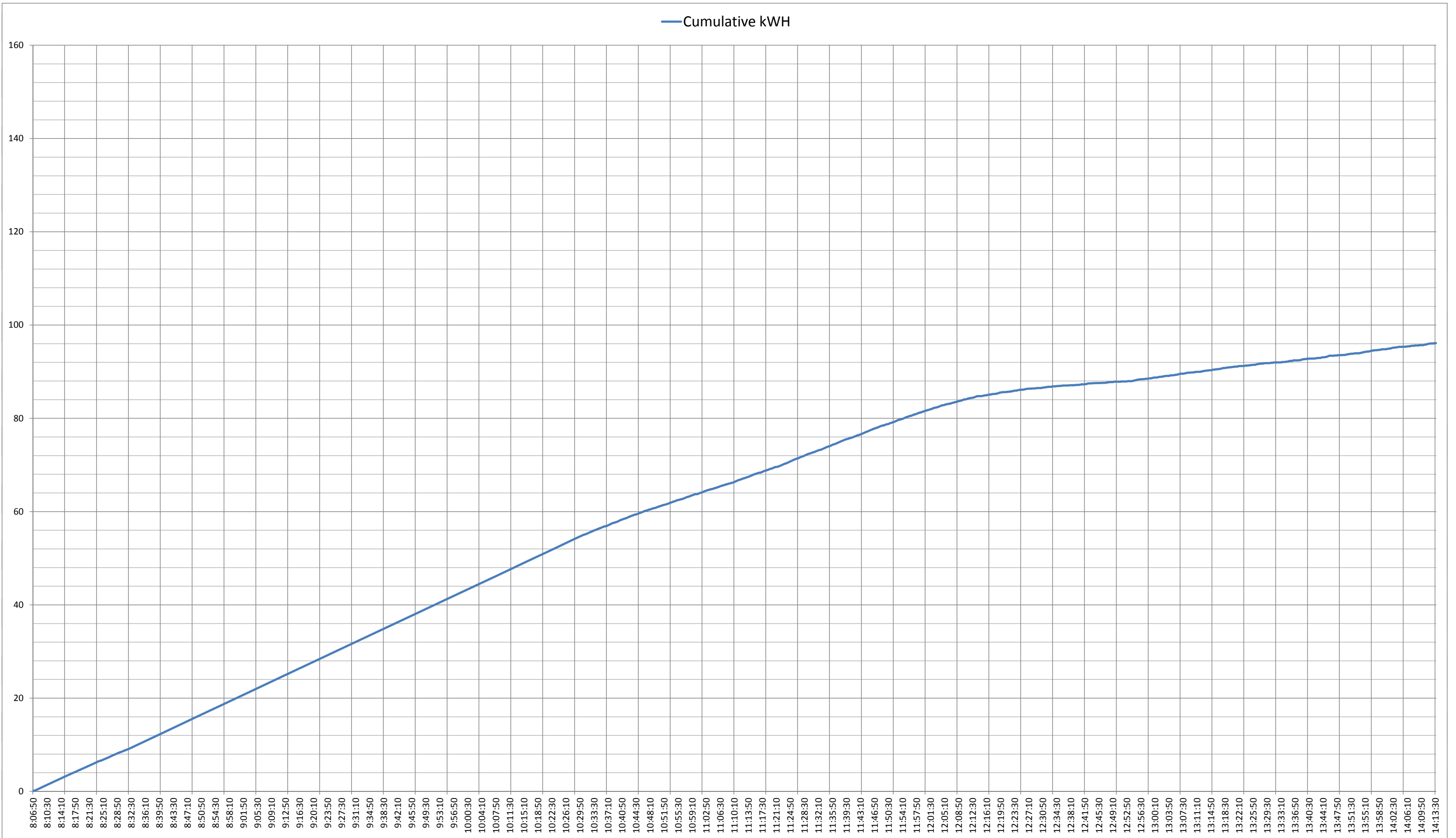

Run 5

7/12/2011

### Hi-Temperature Trend Chart

— Vapor Line Temp °F — Furnace Temp °F — Still Temp °F

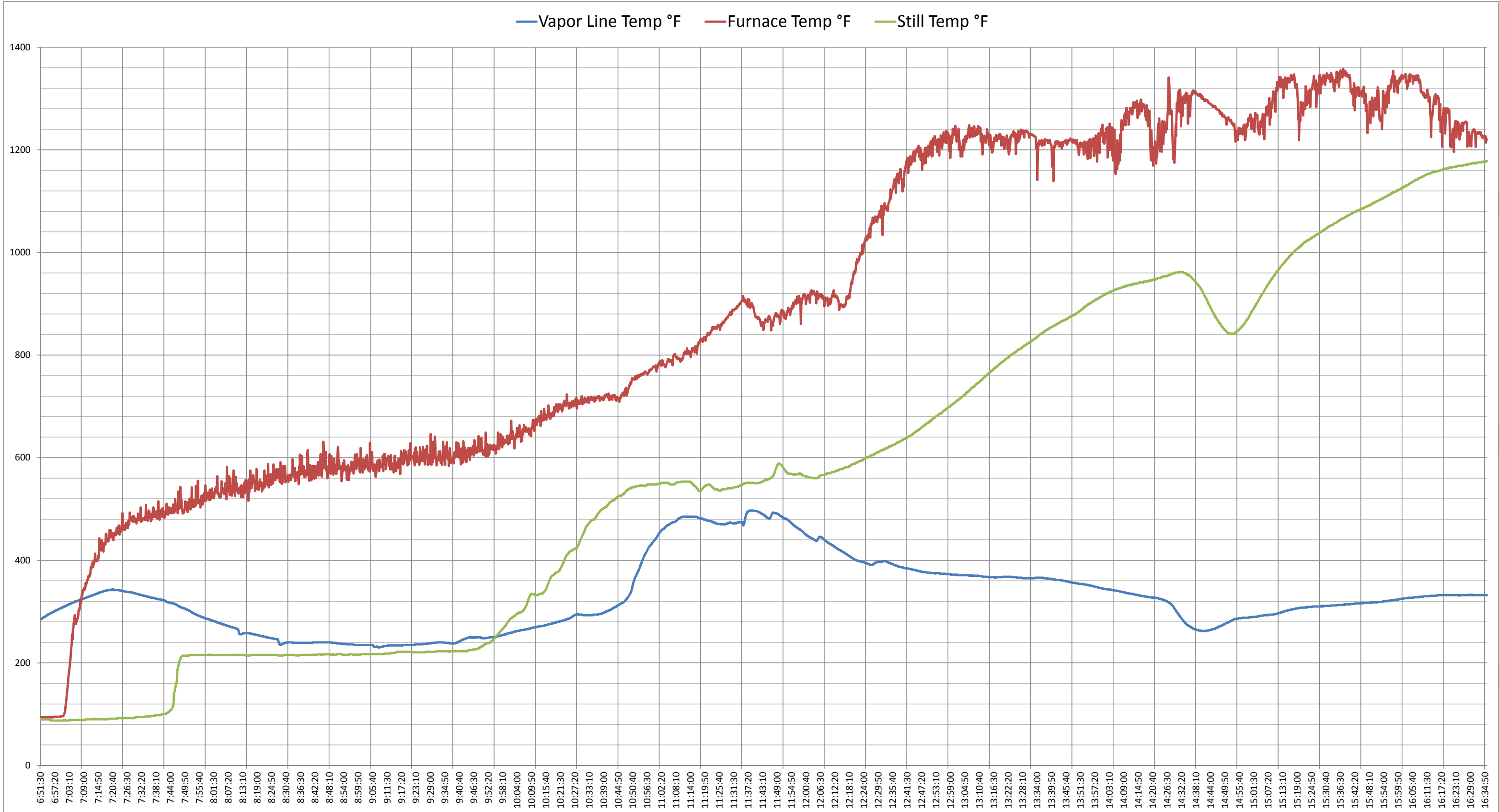



— Cond O Flow Temp °F — Cond Outlet Temp °F

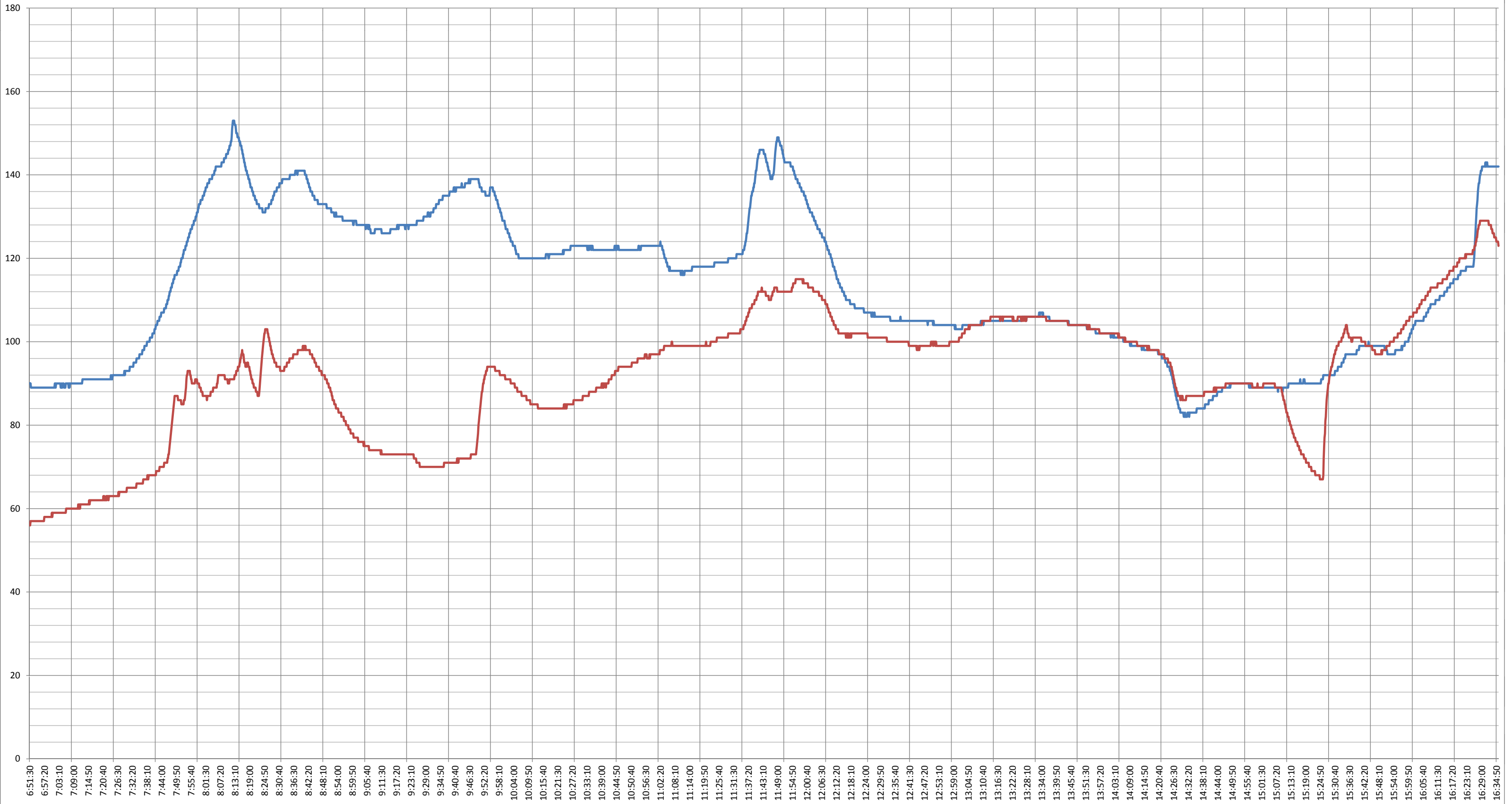

Run 5

7/12/2011

### Pressure Trend Chart

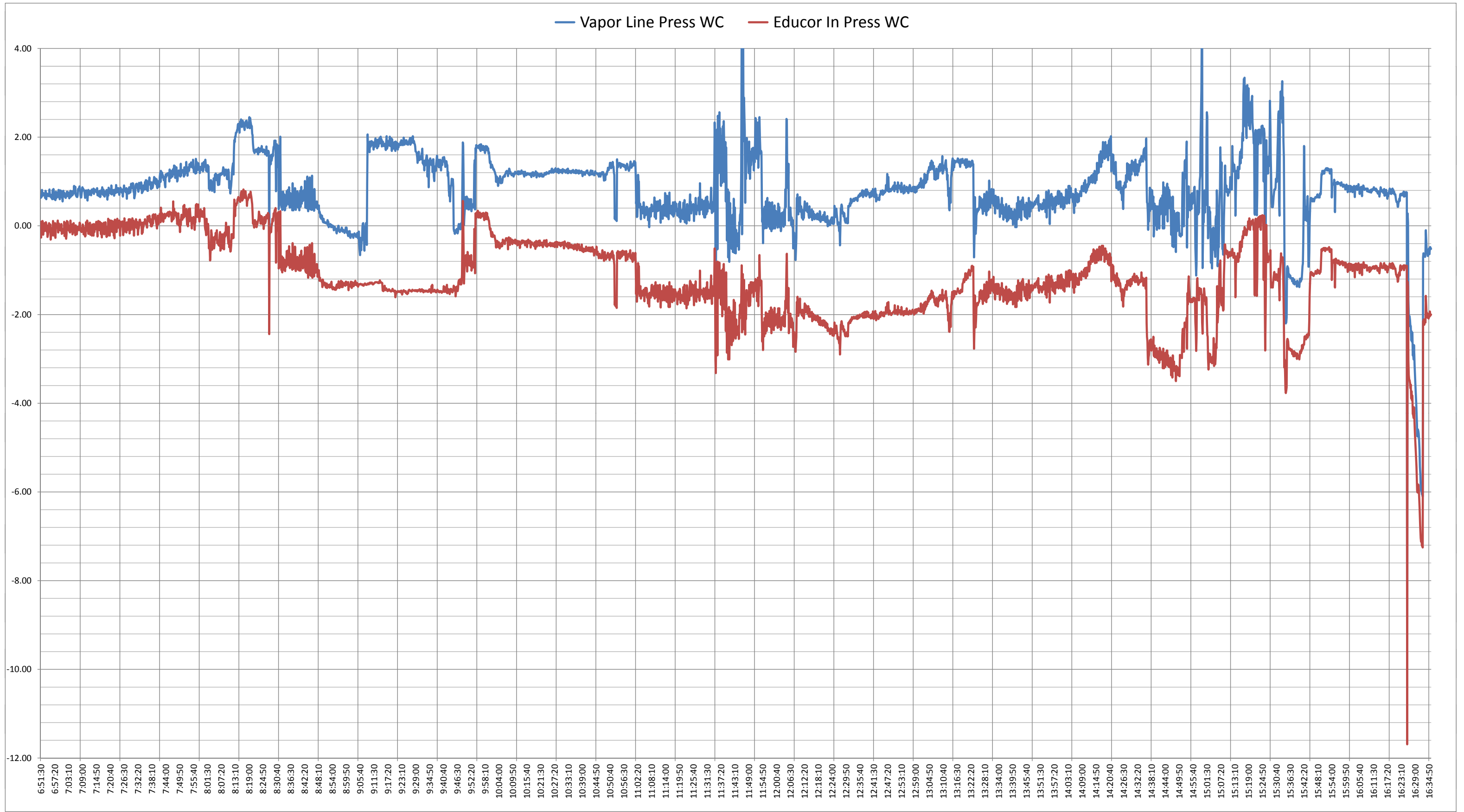

Cumulative kWh

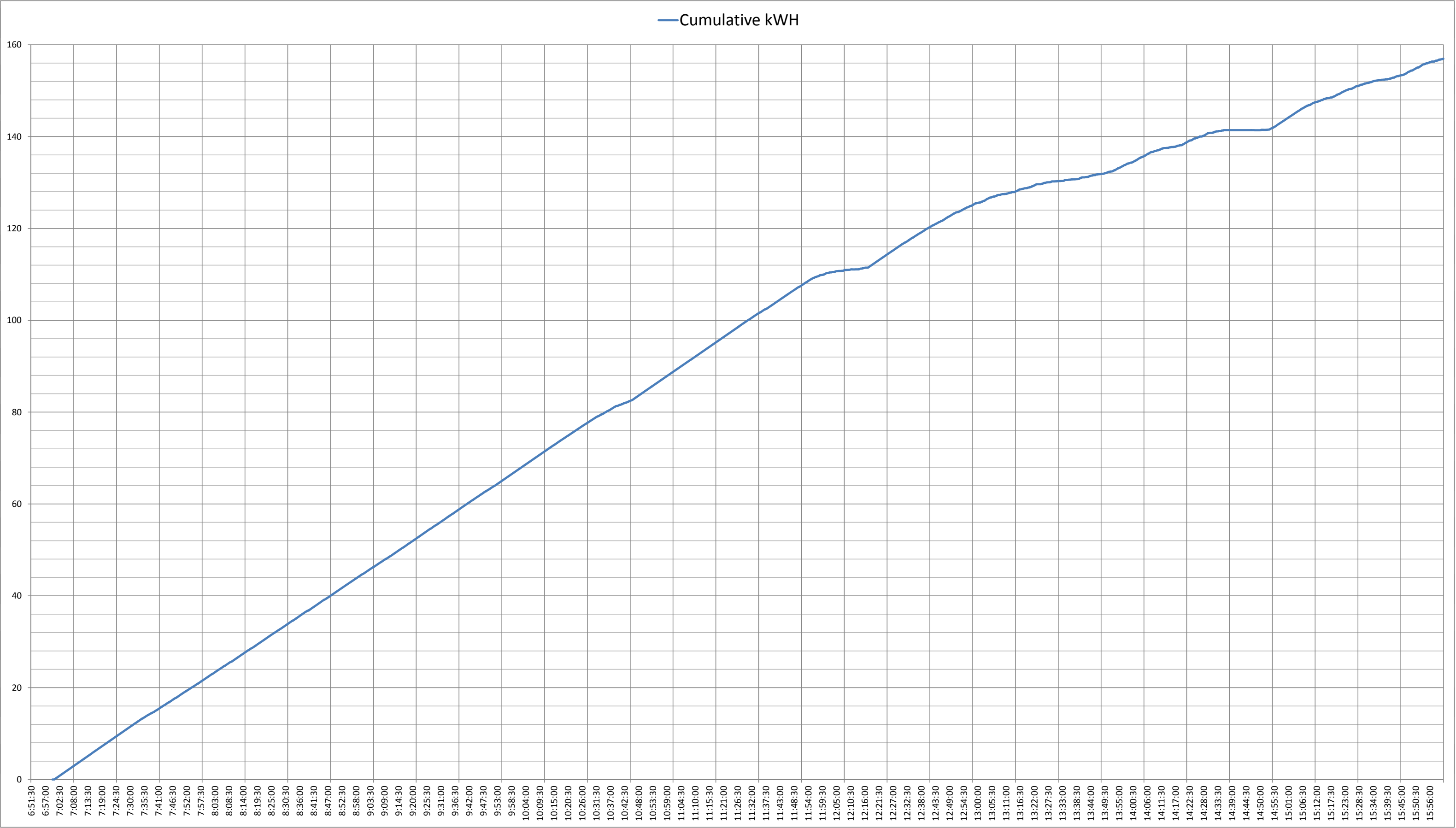

Furnace Temp °F Still Temp °F Vapor Line Temp °F

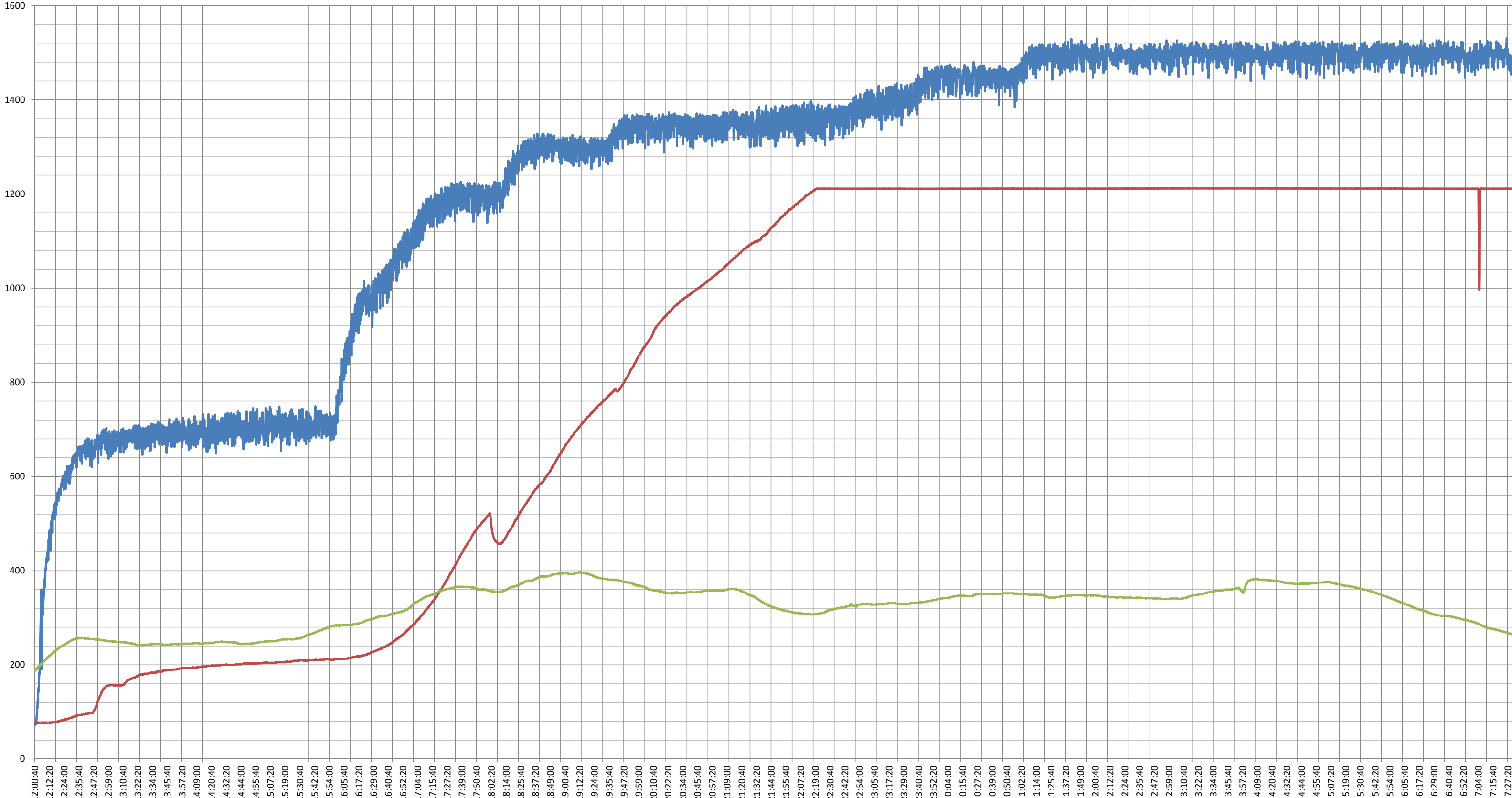

— Cond O Flow Temp °F — Cond Outlet Temp °F — Cond Spray Temp °F

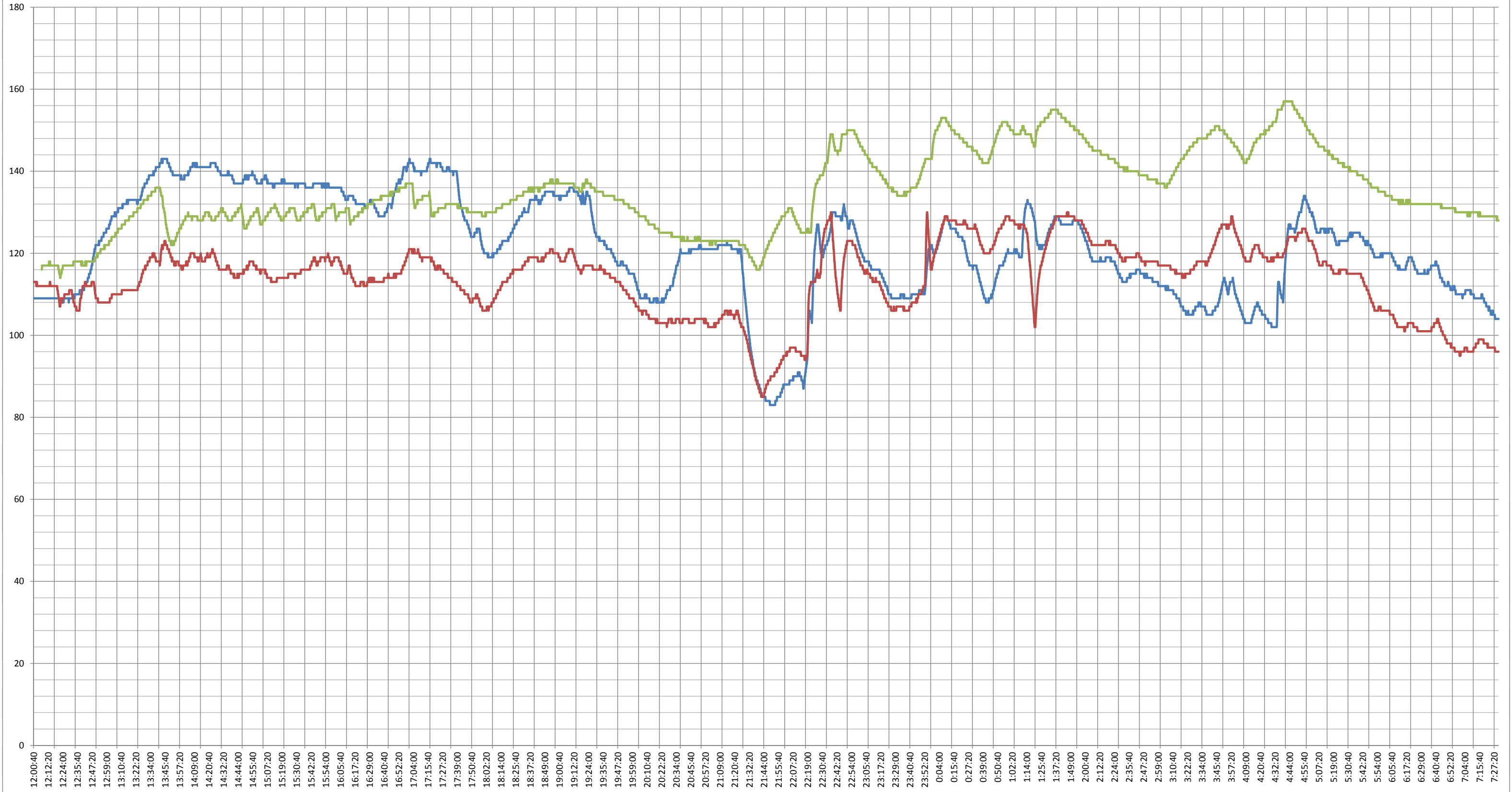

Run 6

7/19/2011

Pressure Trend Chart

Vapor Line Press WC Educor In Press WC

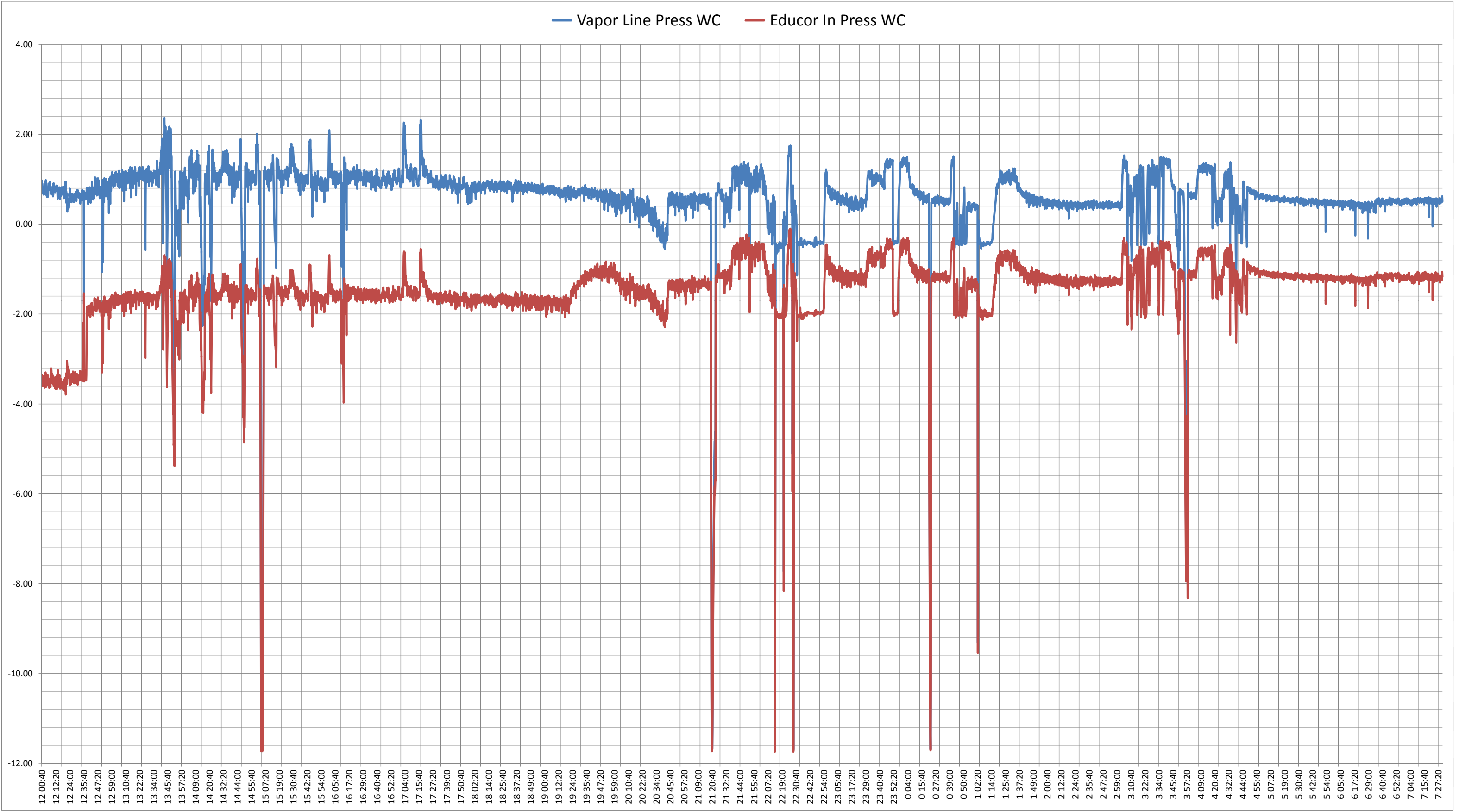



— Cumulative kWh

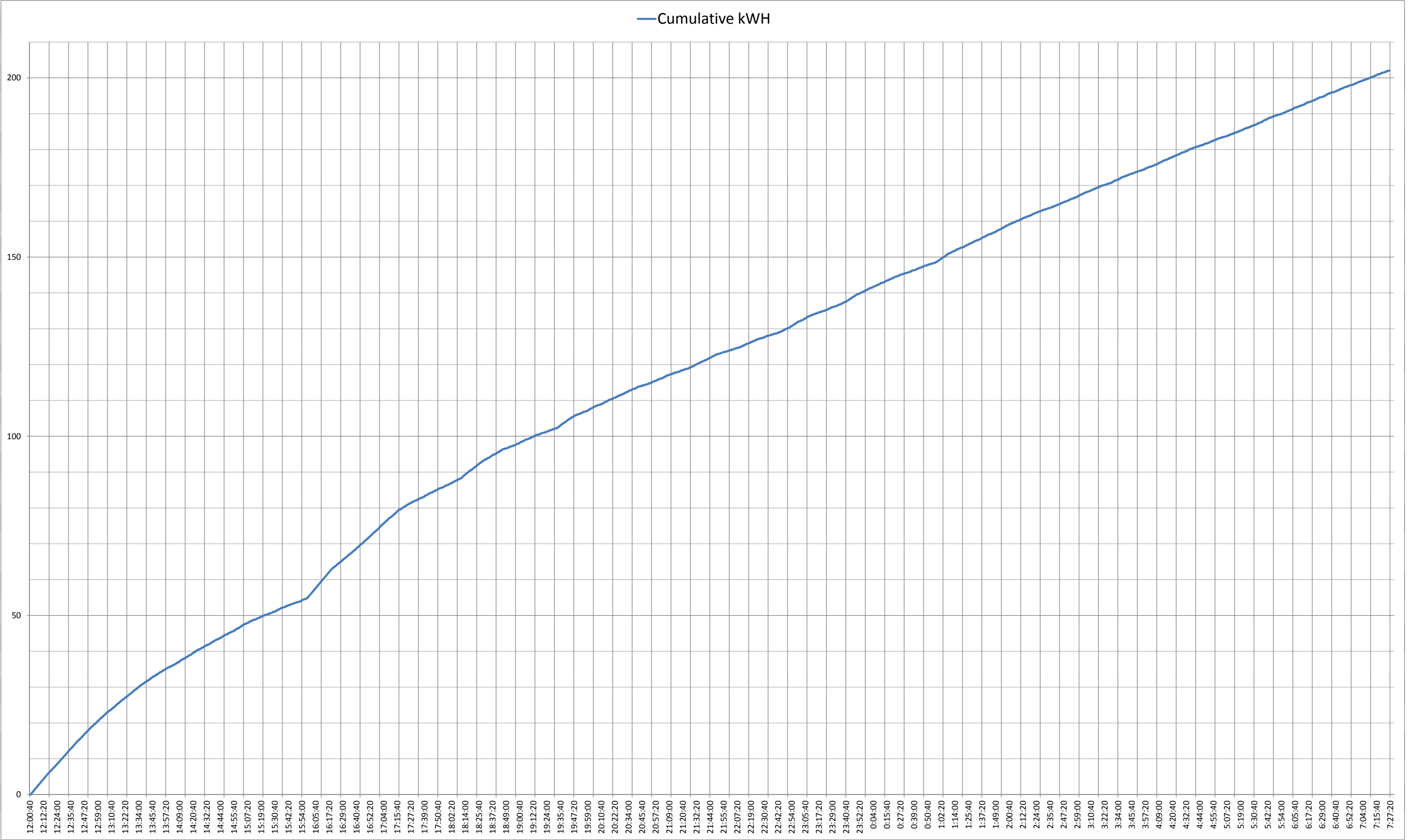

Still Temp °F Vapor Line Temp °F Furnace Temp °F

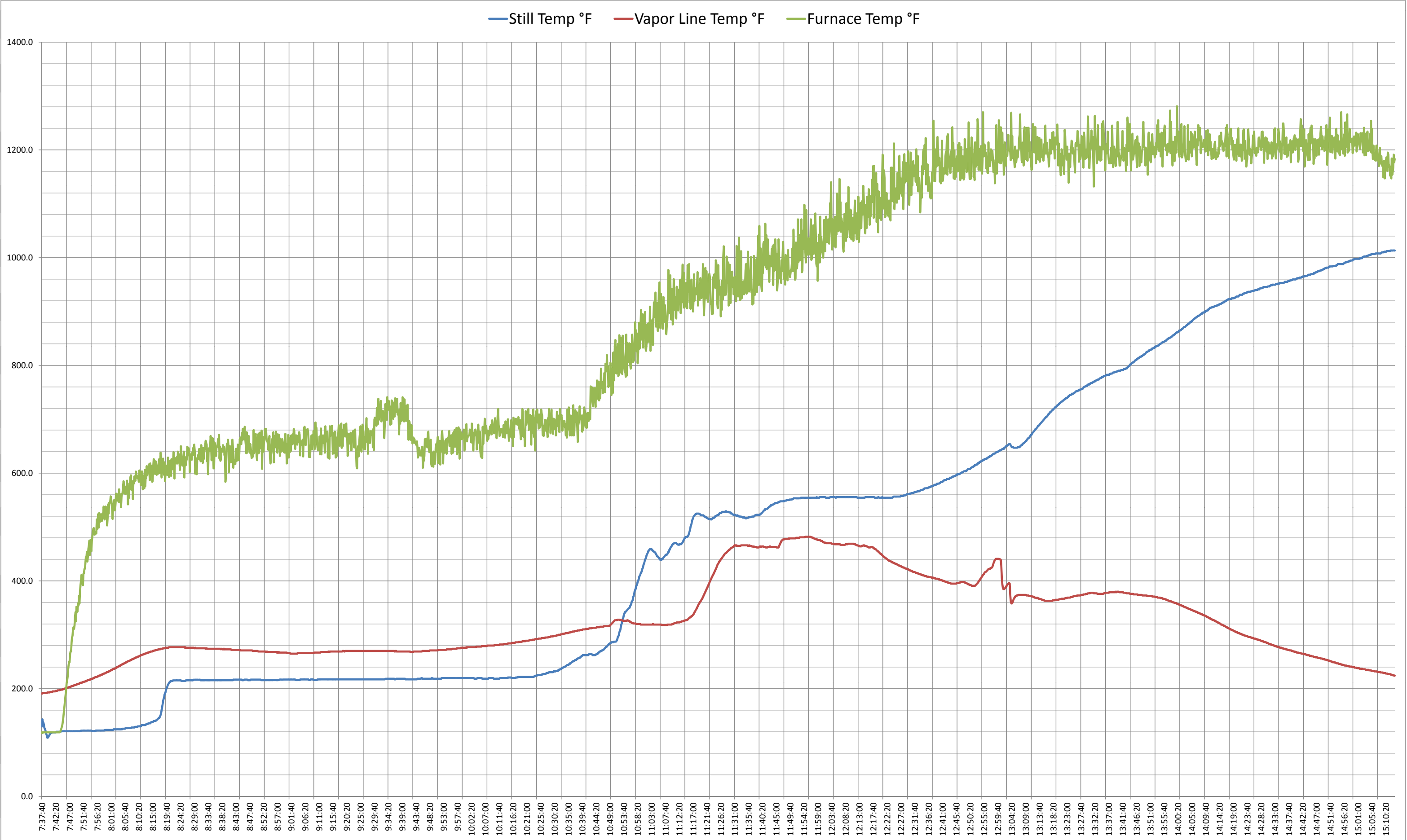

— Cond O Flow Temp °F — Cond Outlet Temp °F — Cond Spray Temp °F

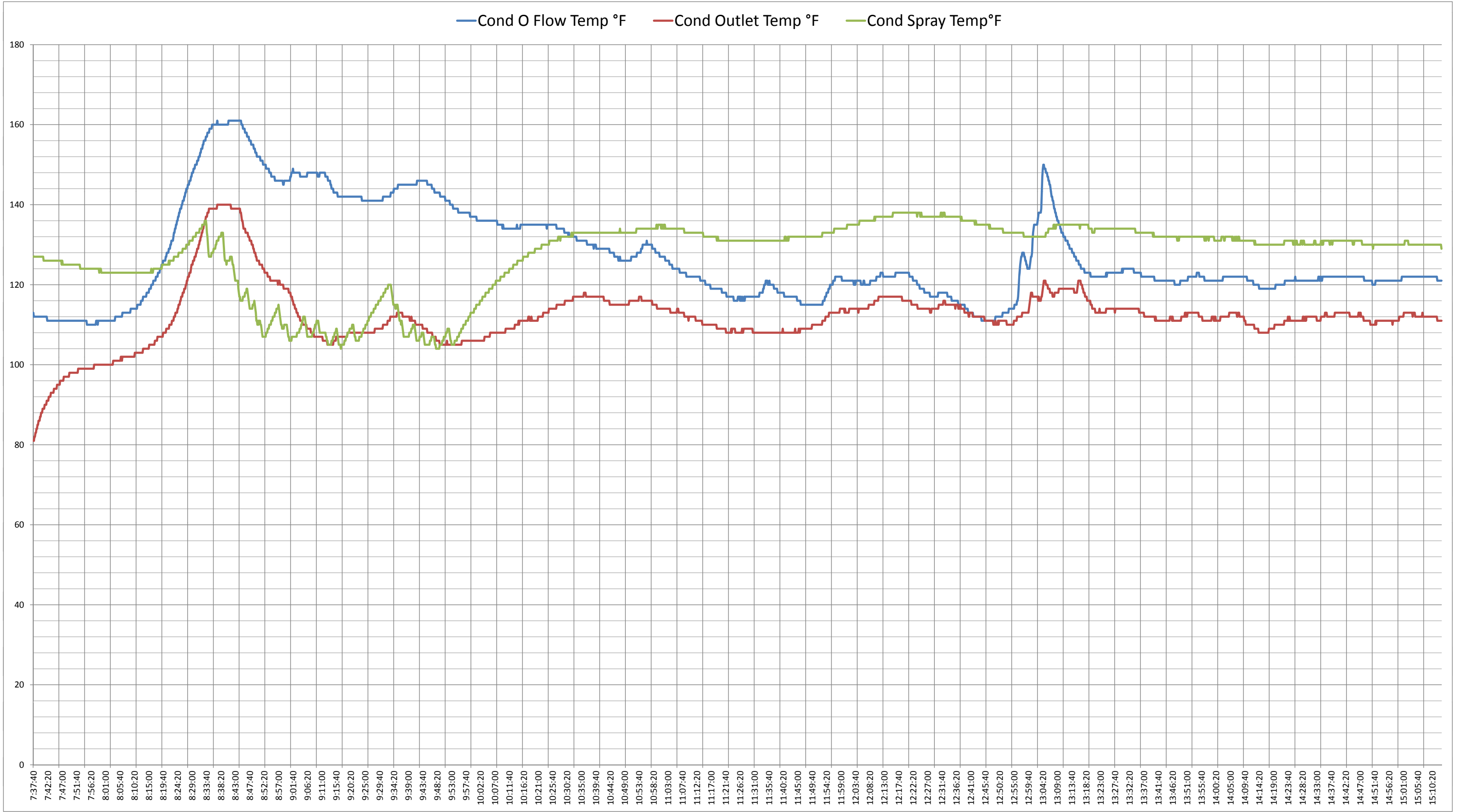

Run 7

7/26/2011

Pressure Trend Chart

— Vapor Line Press WC — Educor In Press WC

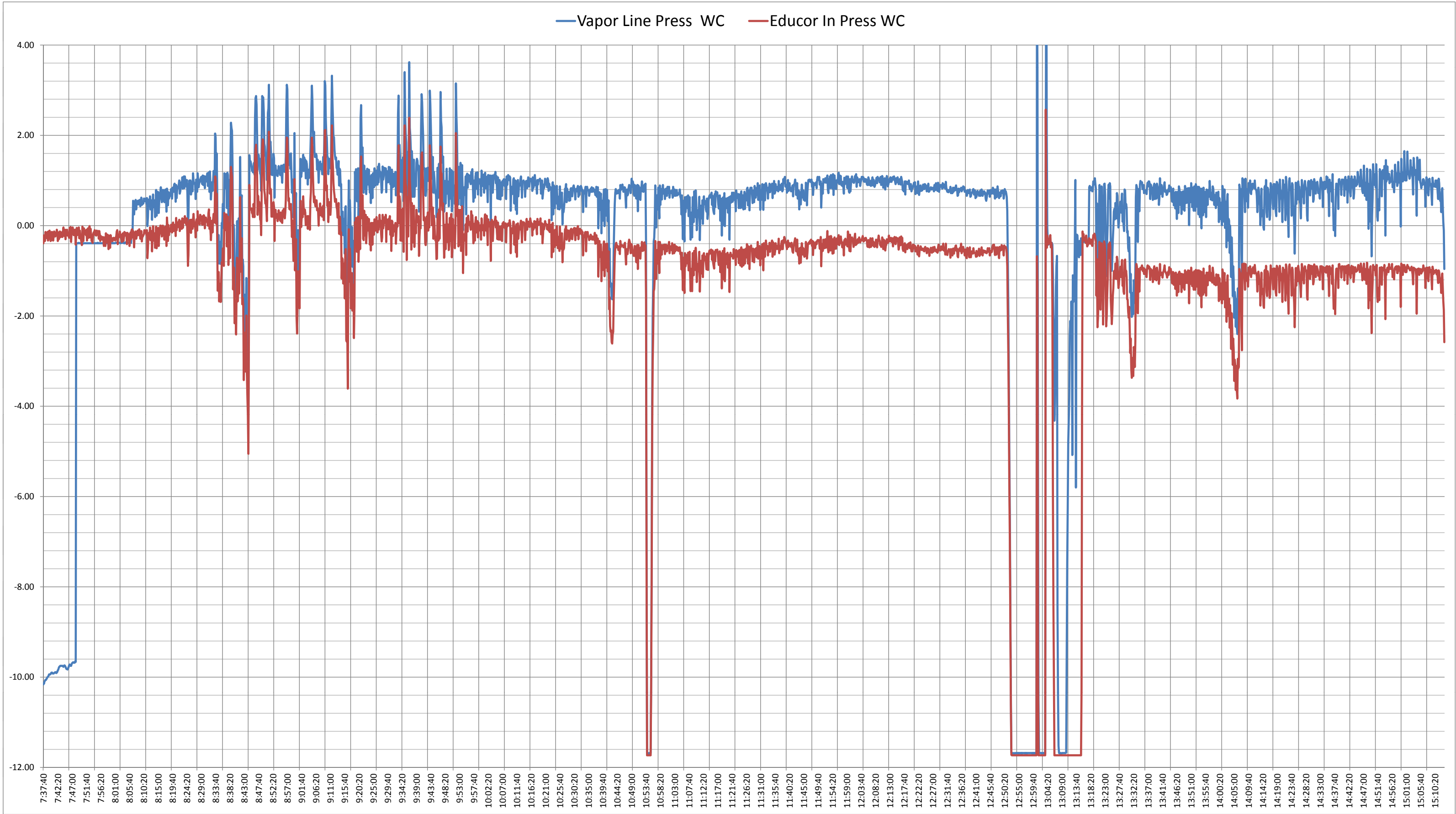

— Cumulative kWh

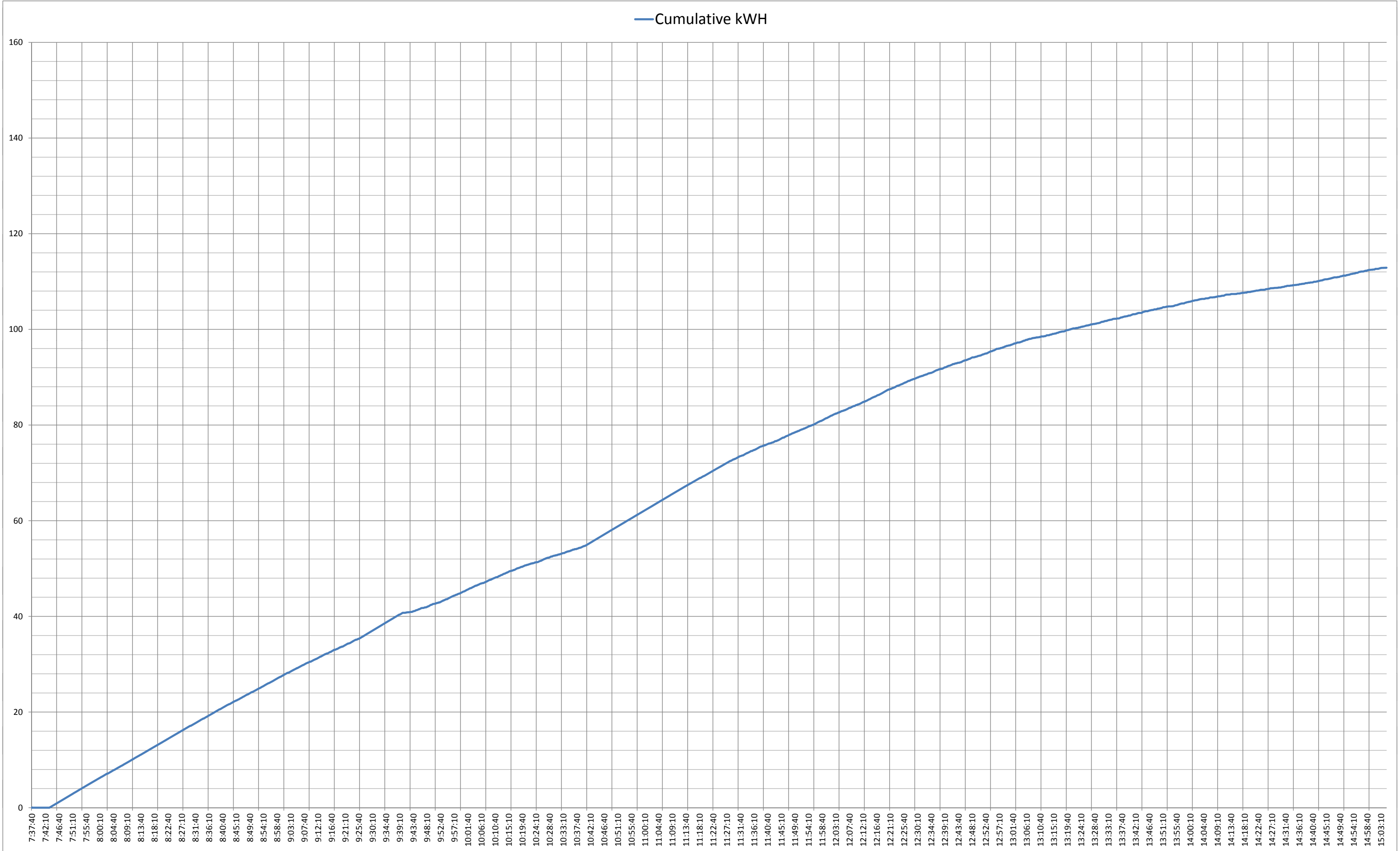

Run 8

7/28/2011

### Hi-Temperature Trend Chart

Furnace Temp °F   Vapor Line Temp °F   Still Temp °F

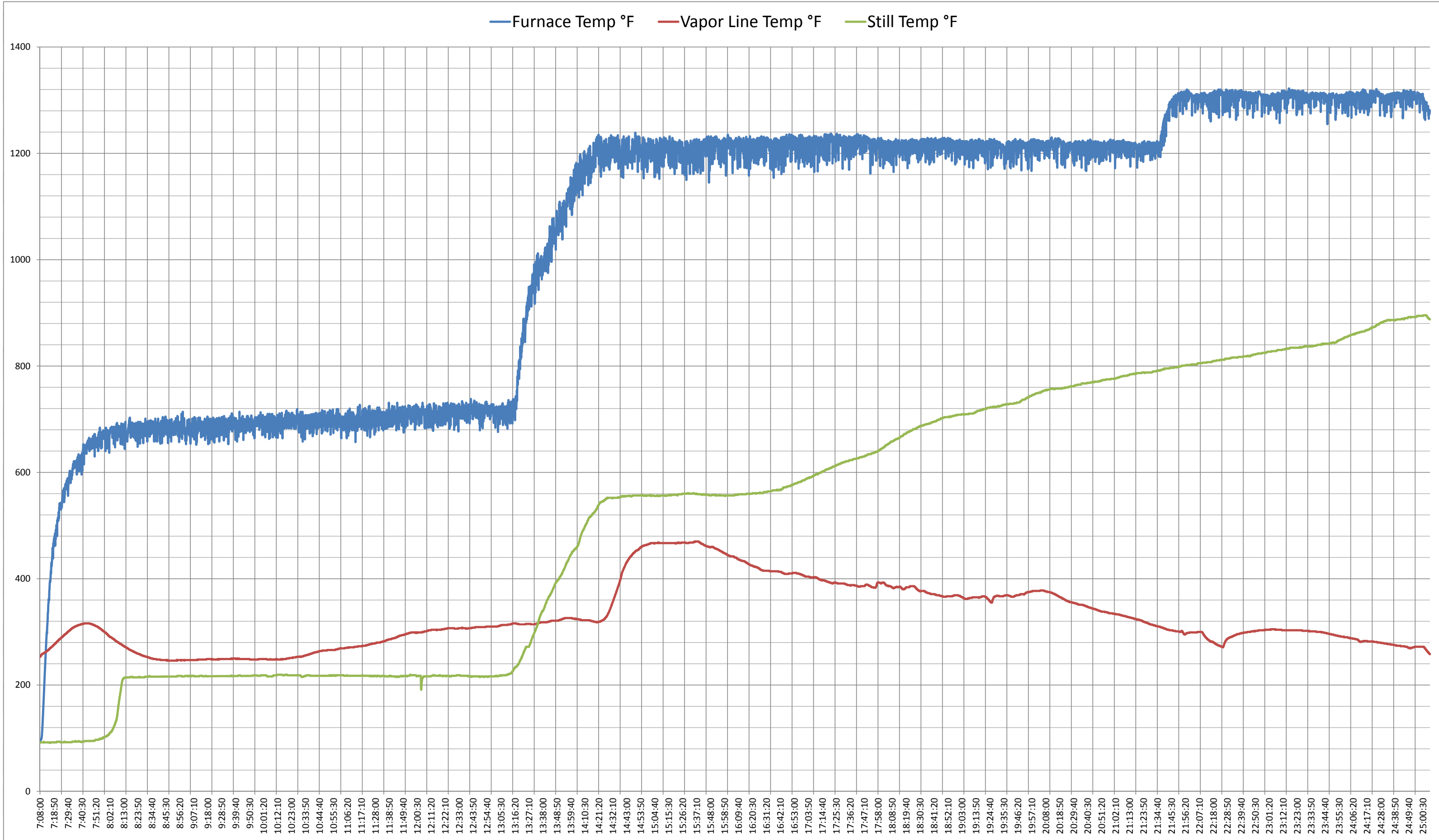



— Cond O Flow Temp °F — Cond Outlet Temp °F — Cond Spray Temp °F

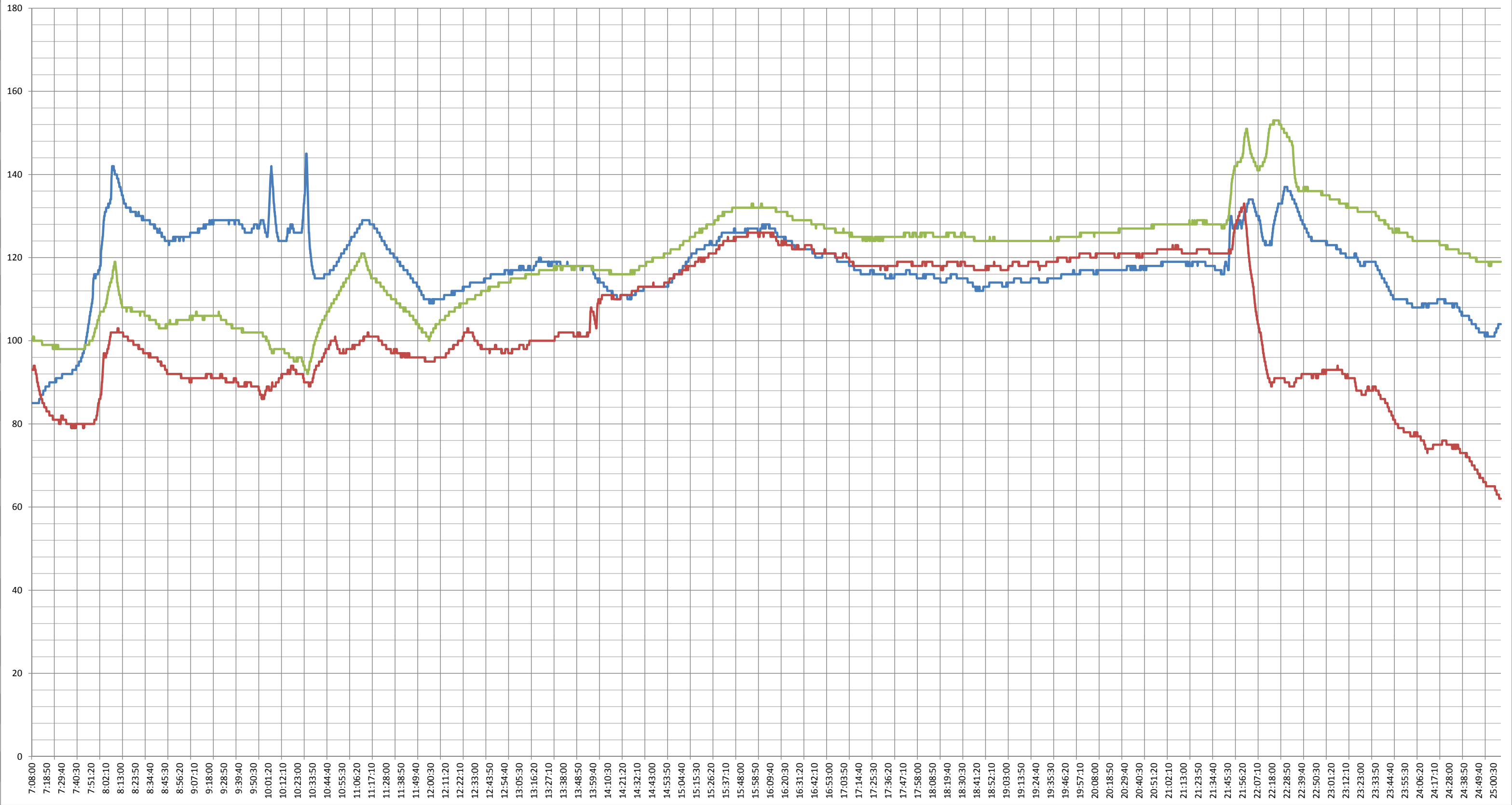

Run 8

7/28/2011

Pressure Trend Chart

Vapor Line Press WC Educor In Press WC

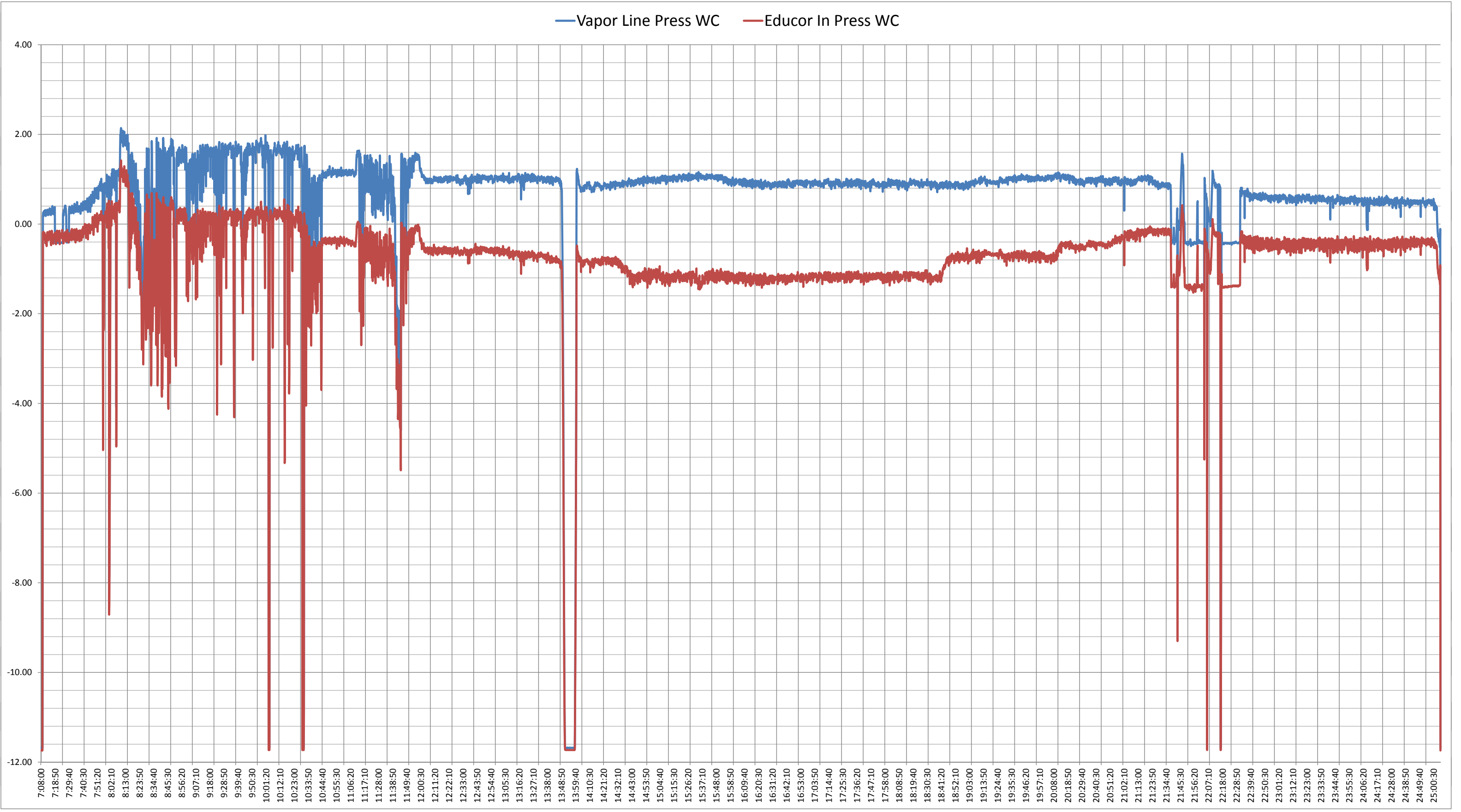

Run 8

7/28/2011

### Cumulative Power Trend Chart

Cumulative kWh

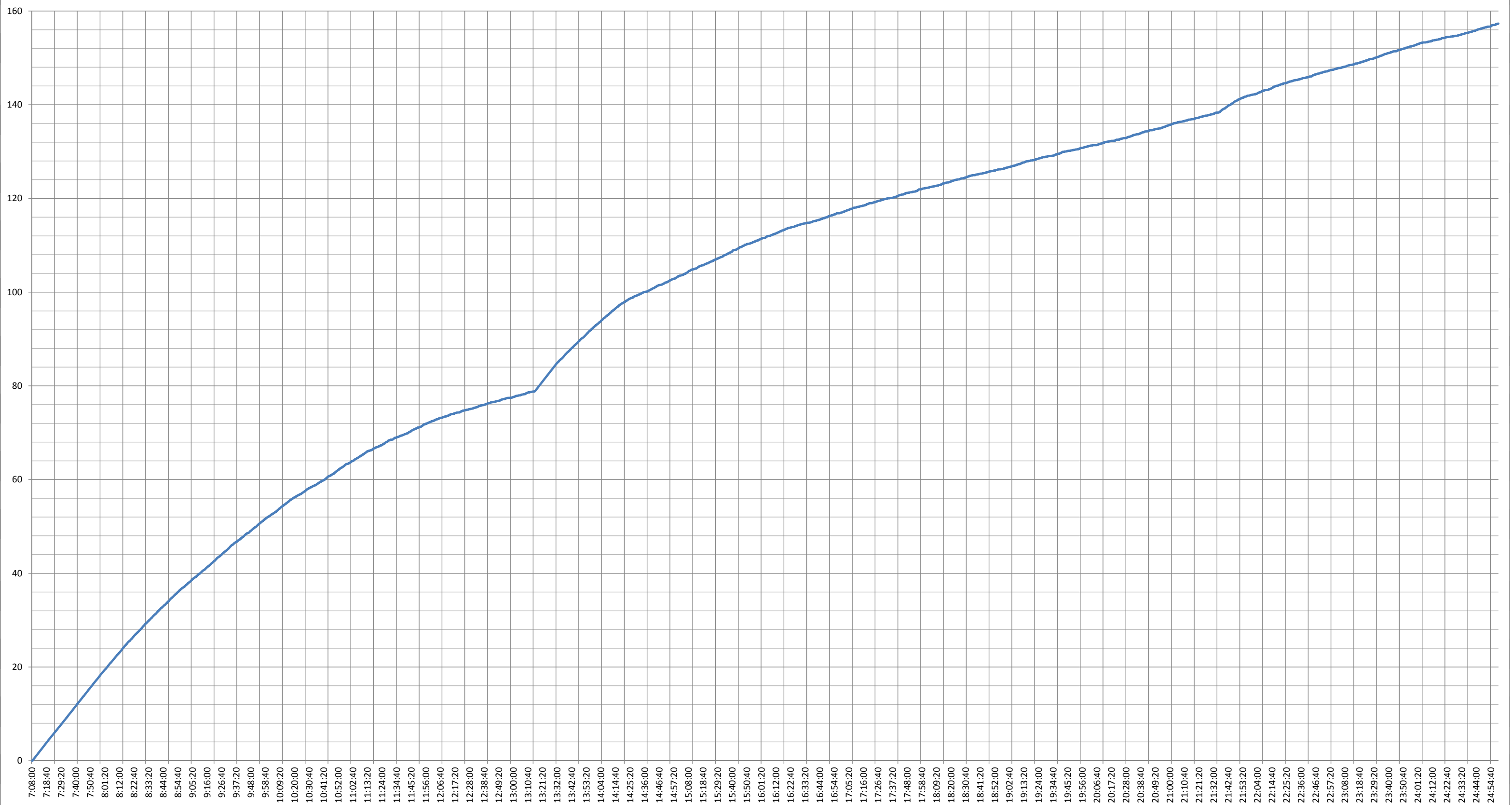

Run 9

8/9/2011

### Hi-Temperature Trend Chart

— Vapor Line Temp °F    — Furnace Temp °F    — Still Temp °F

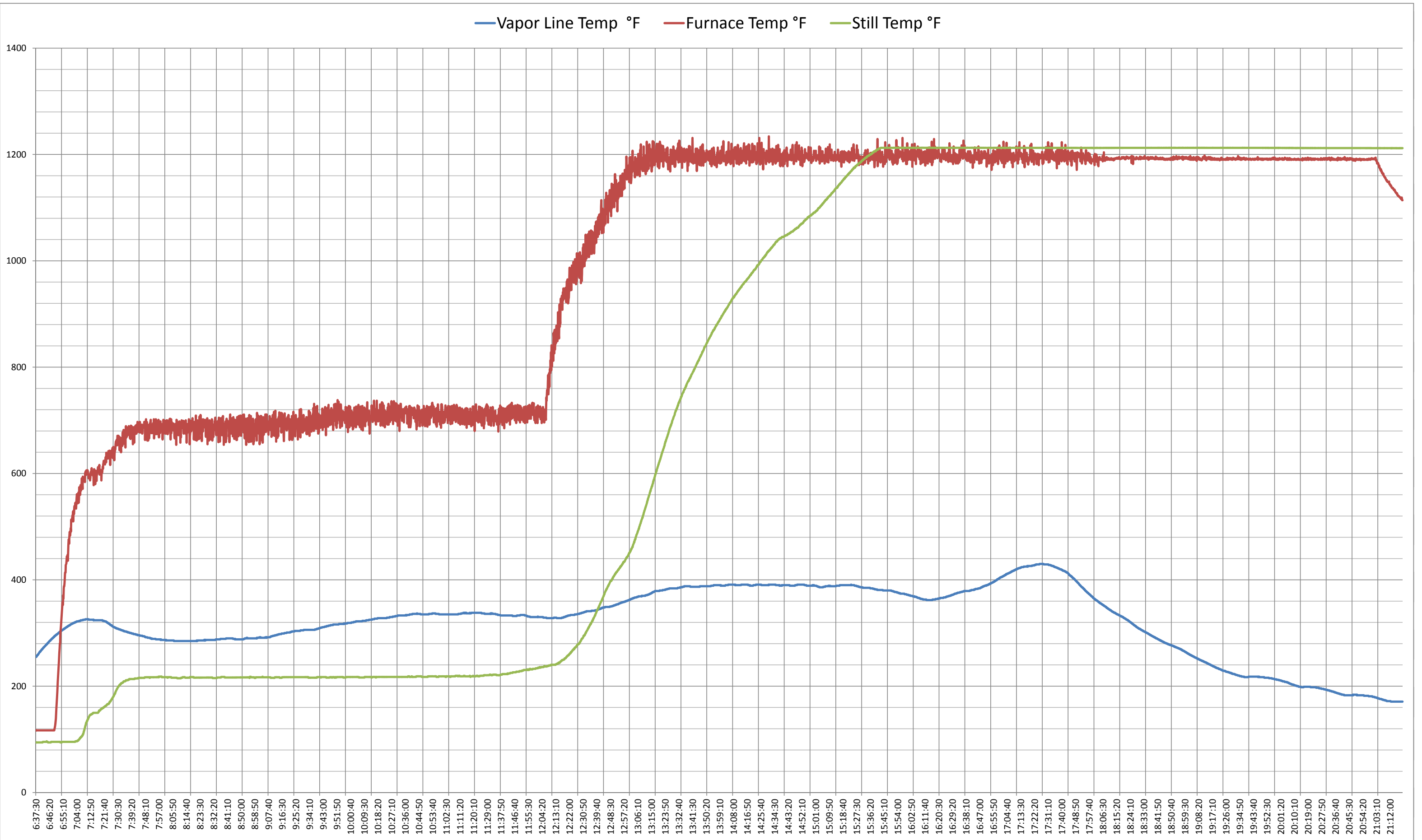

Run 9

8/9/2011

Lo-Temperature Trend Chart

Cond O Flow Temp °F   Cond Outlet Temp °F   Cond Spray Temp °F

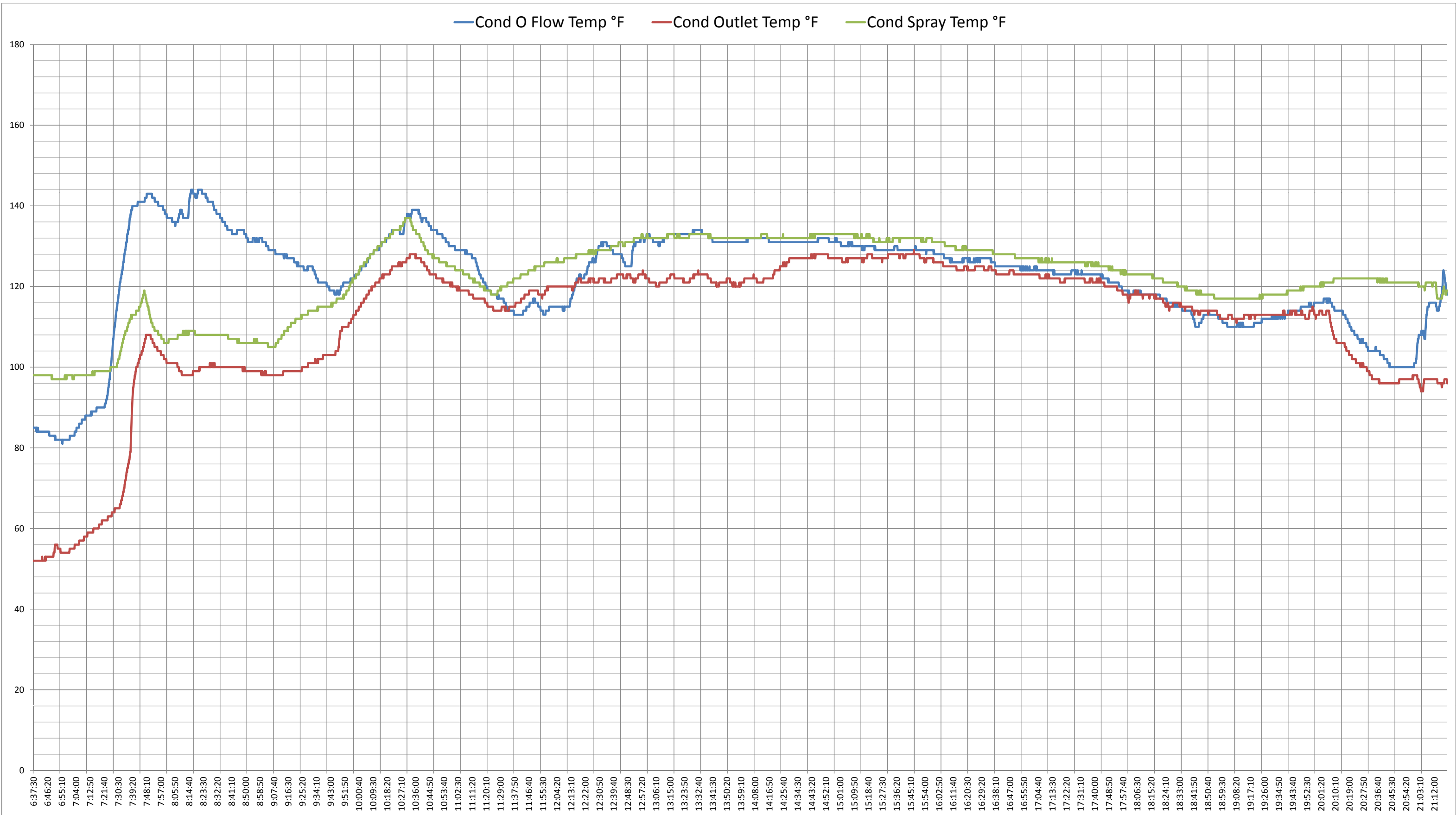

Run 9

8/9/2011

Pressure Trend Chart

Vapor Line Press WC Educor In Press WC

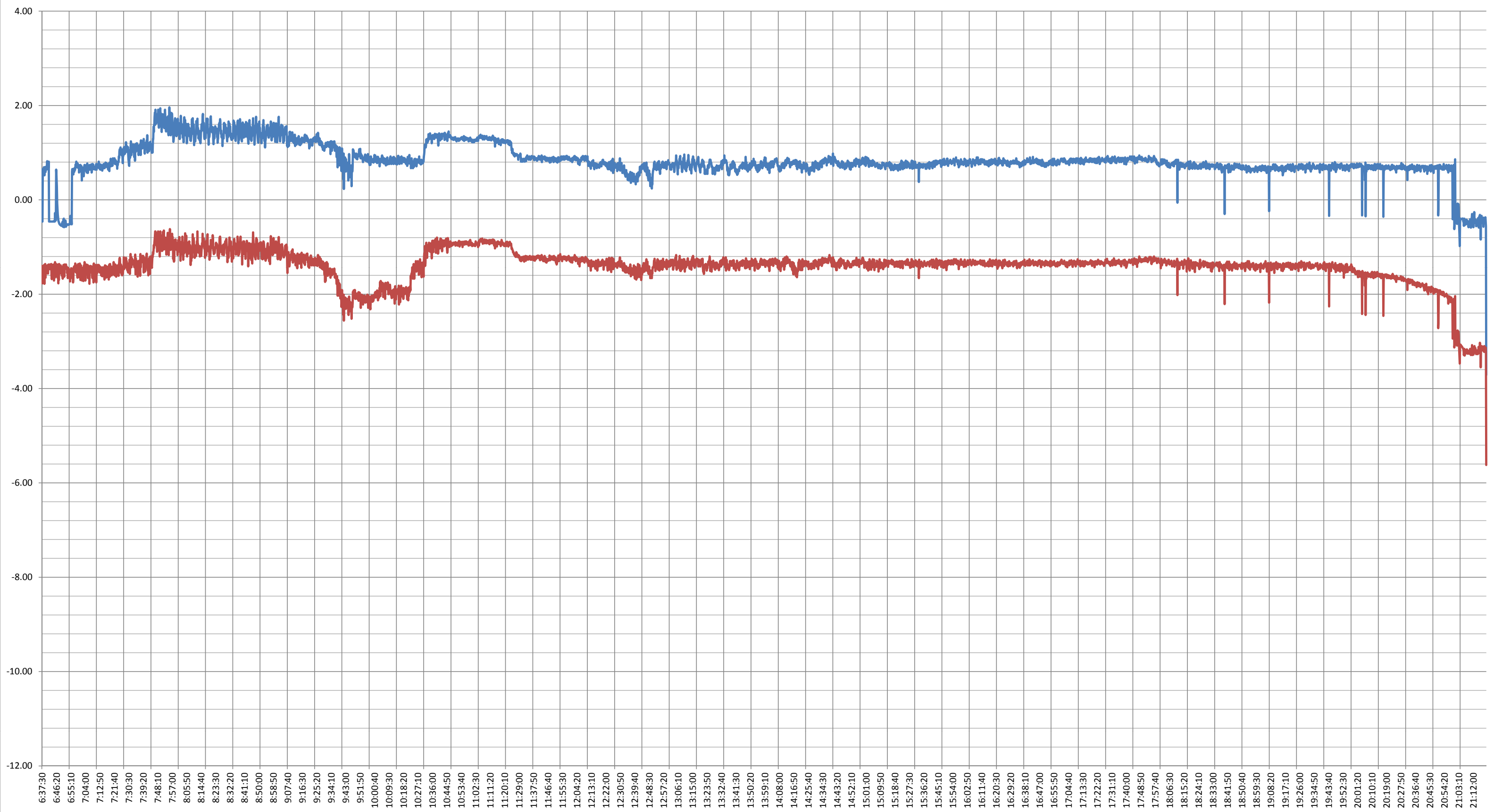



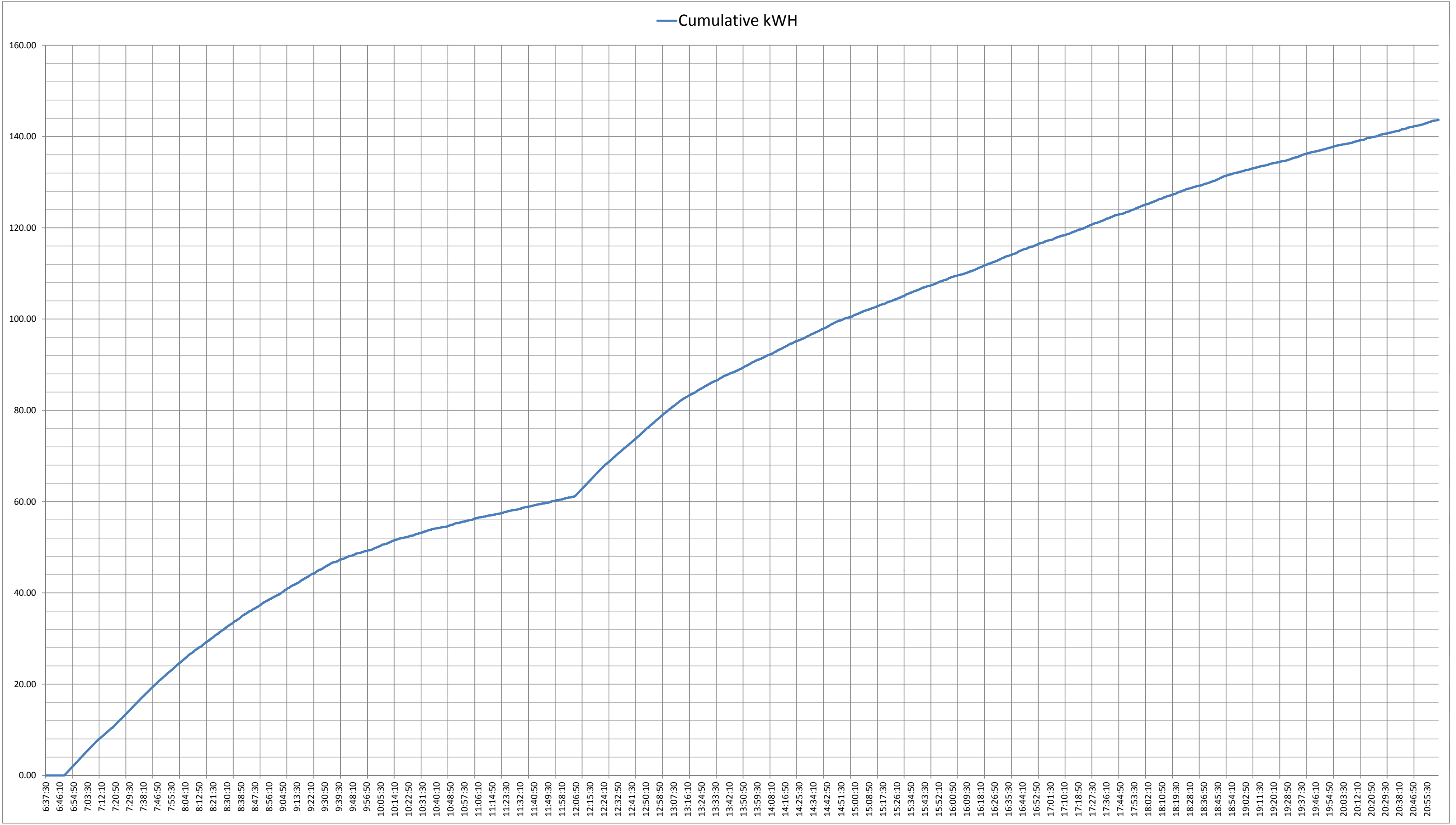

Run 10

8/16/2011

### Hi-Temperature Trend Chart

— Vapor Line Temp °F — Furnace Temp °F

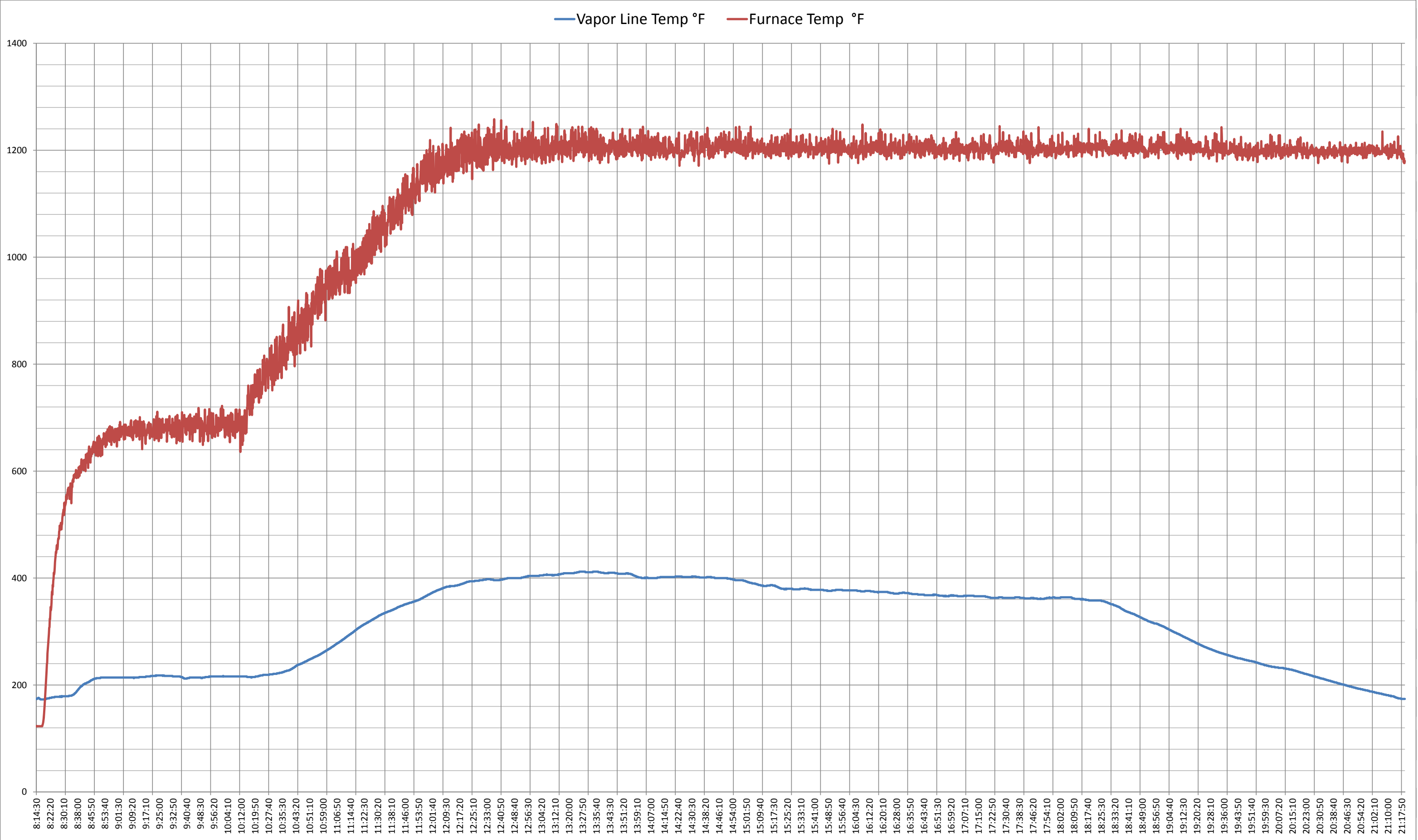

Run 10

8/16/2011

### Lo-Temperature Trend Chart

— Cond O Flow Temp °F    — Cond Outlet Temp °F    — Cond Spray Temp °F

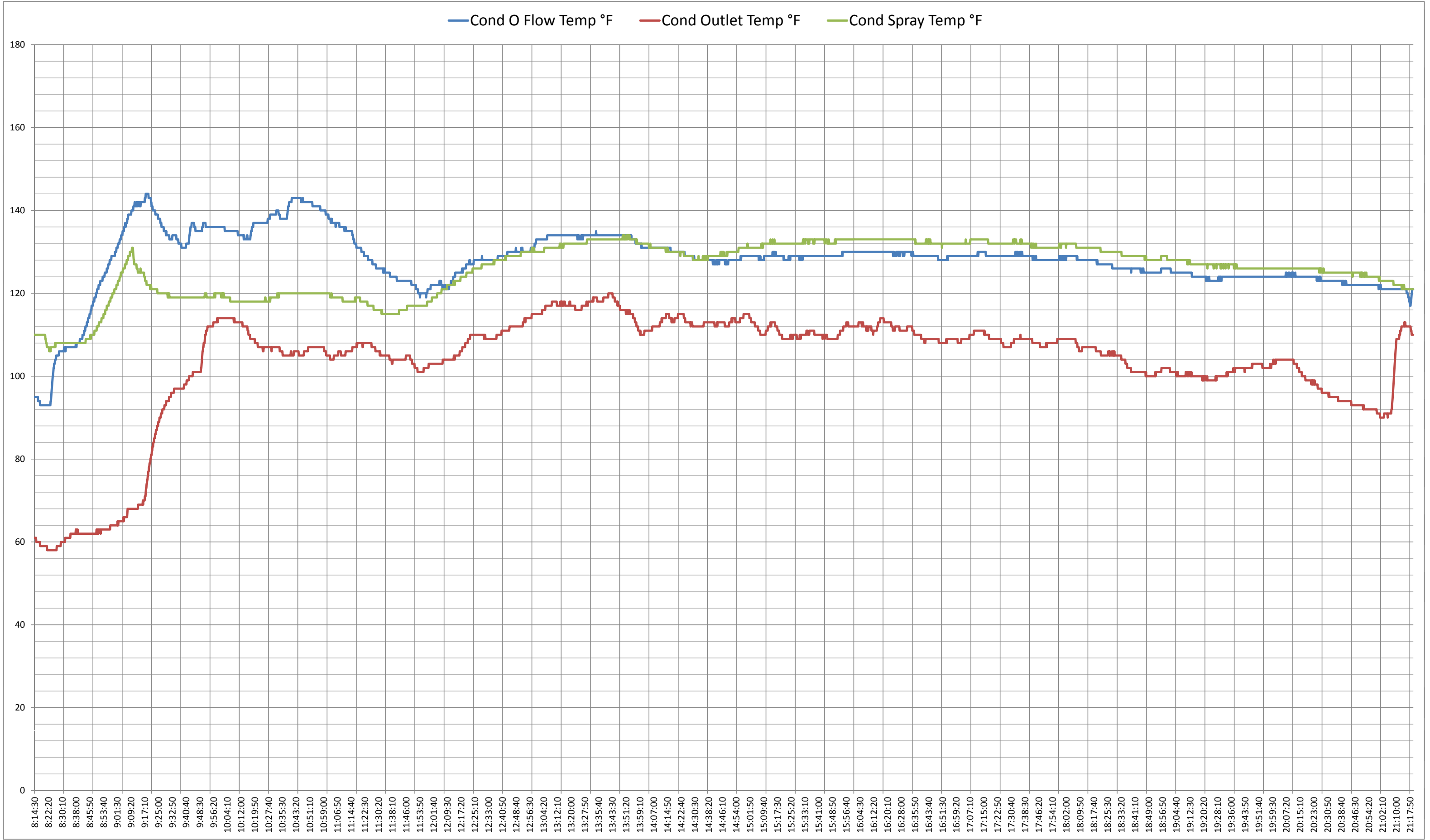

Run 10

8/16/2011

### Pressure Trend Chart

— Vapor Line Press WC — Educor In Press WC

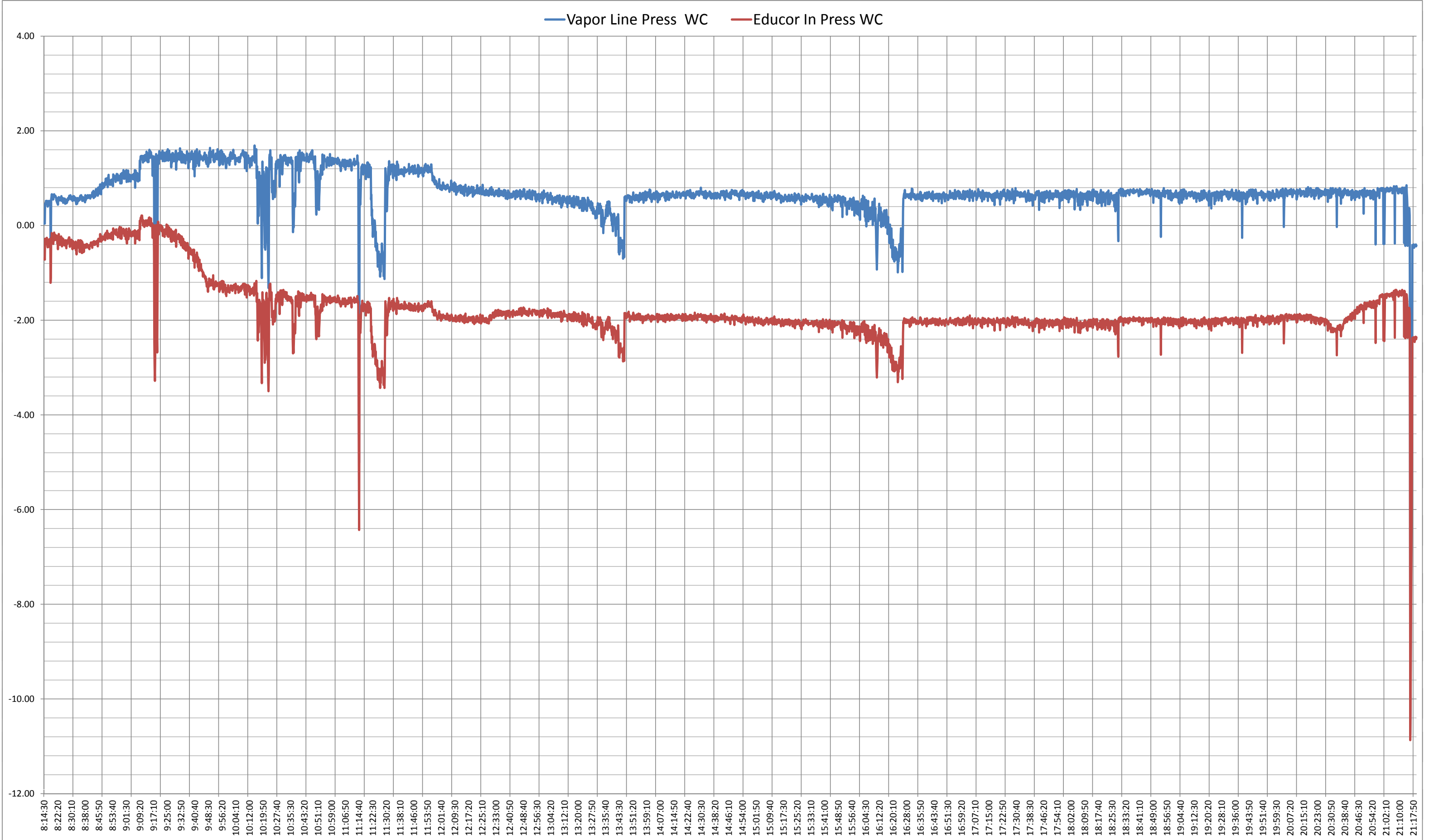

Cumulative kWH

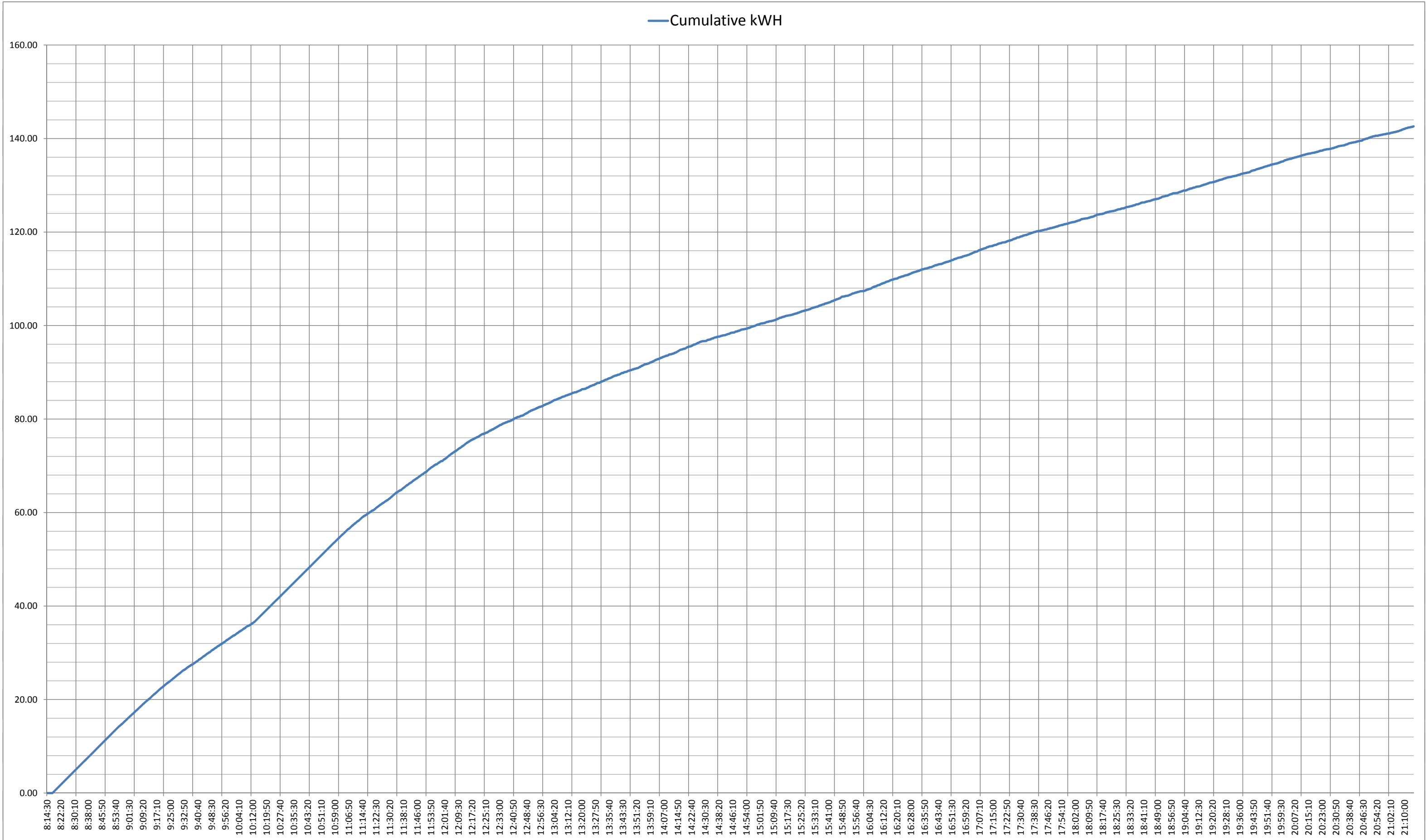

Vapor Line Temp °F    Furnace Temp °F    Still Temp °F

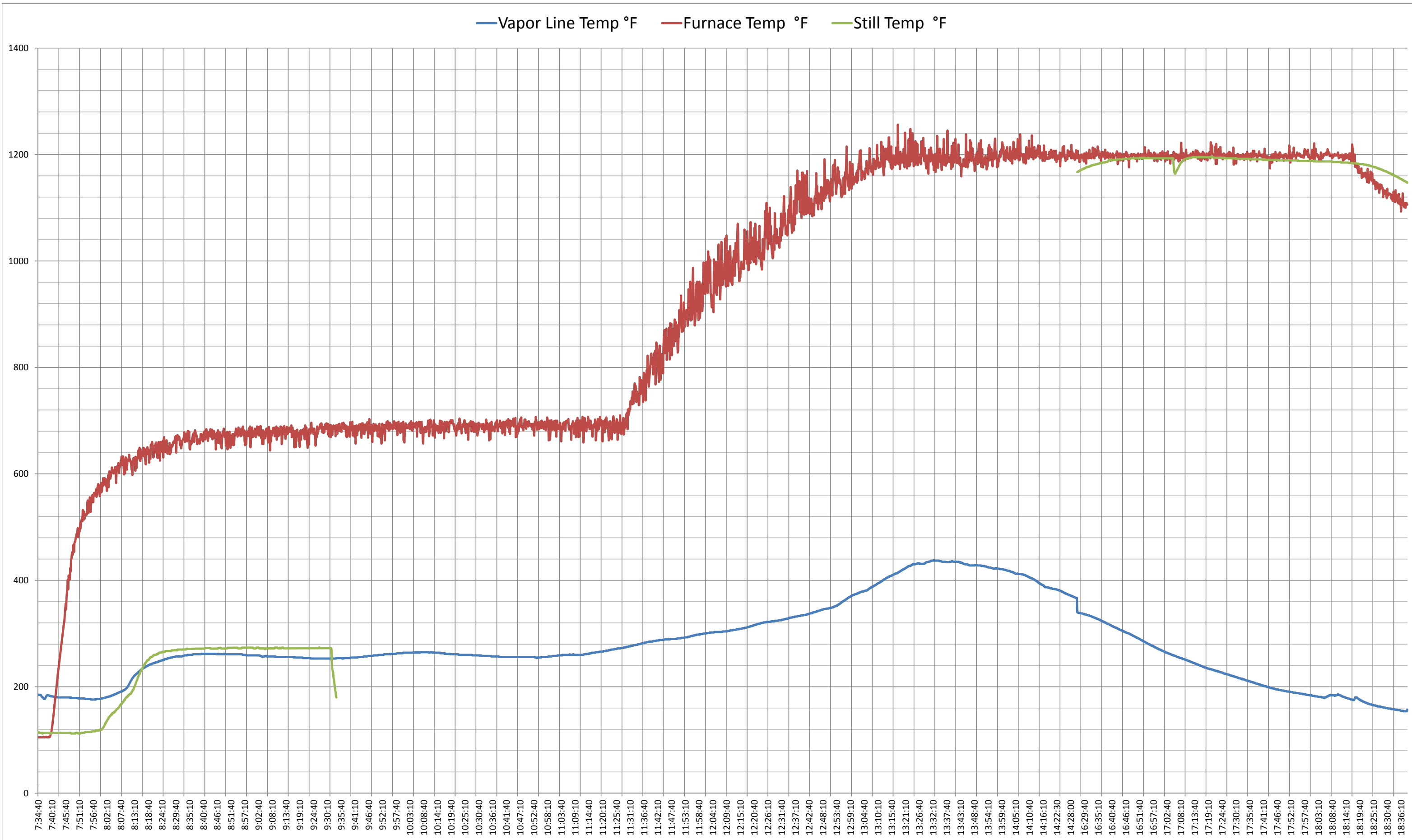



— Cond O Flow Temp °F — Cond Outlet Temp °F — Cond Spray Temp °F

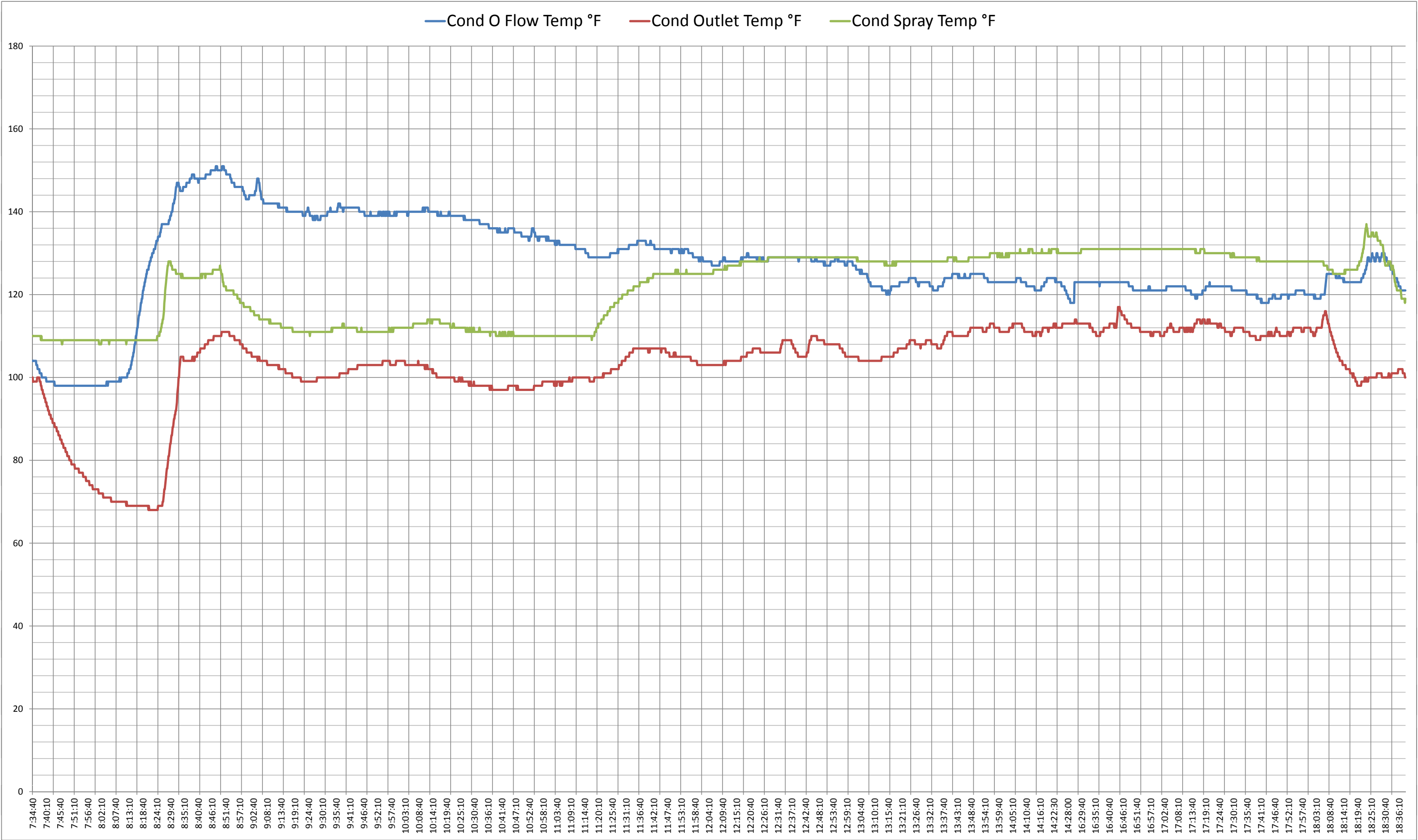

— Vapor Line Press WC — Educor In Press WC

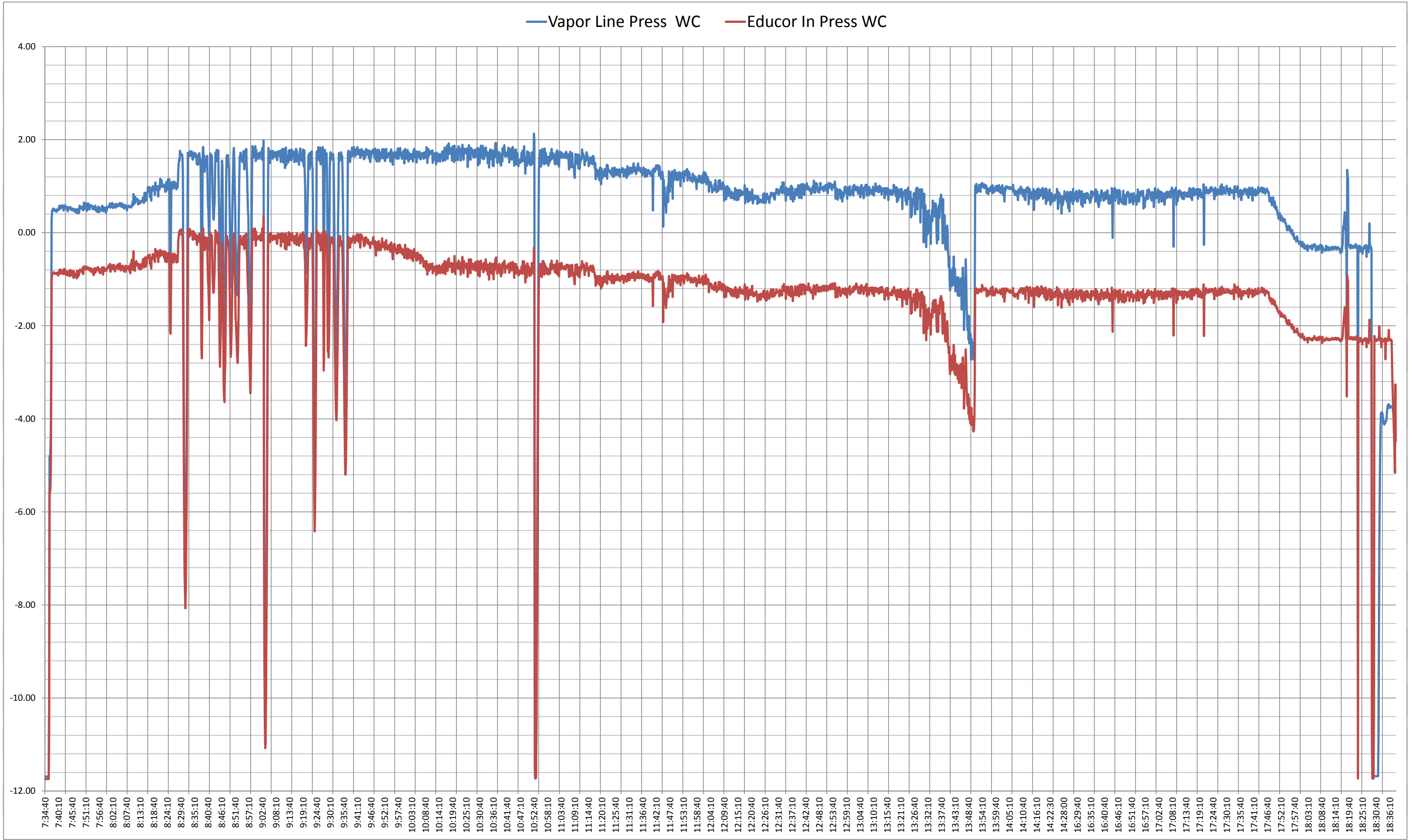

— Cumulative kWh

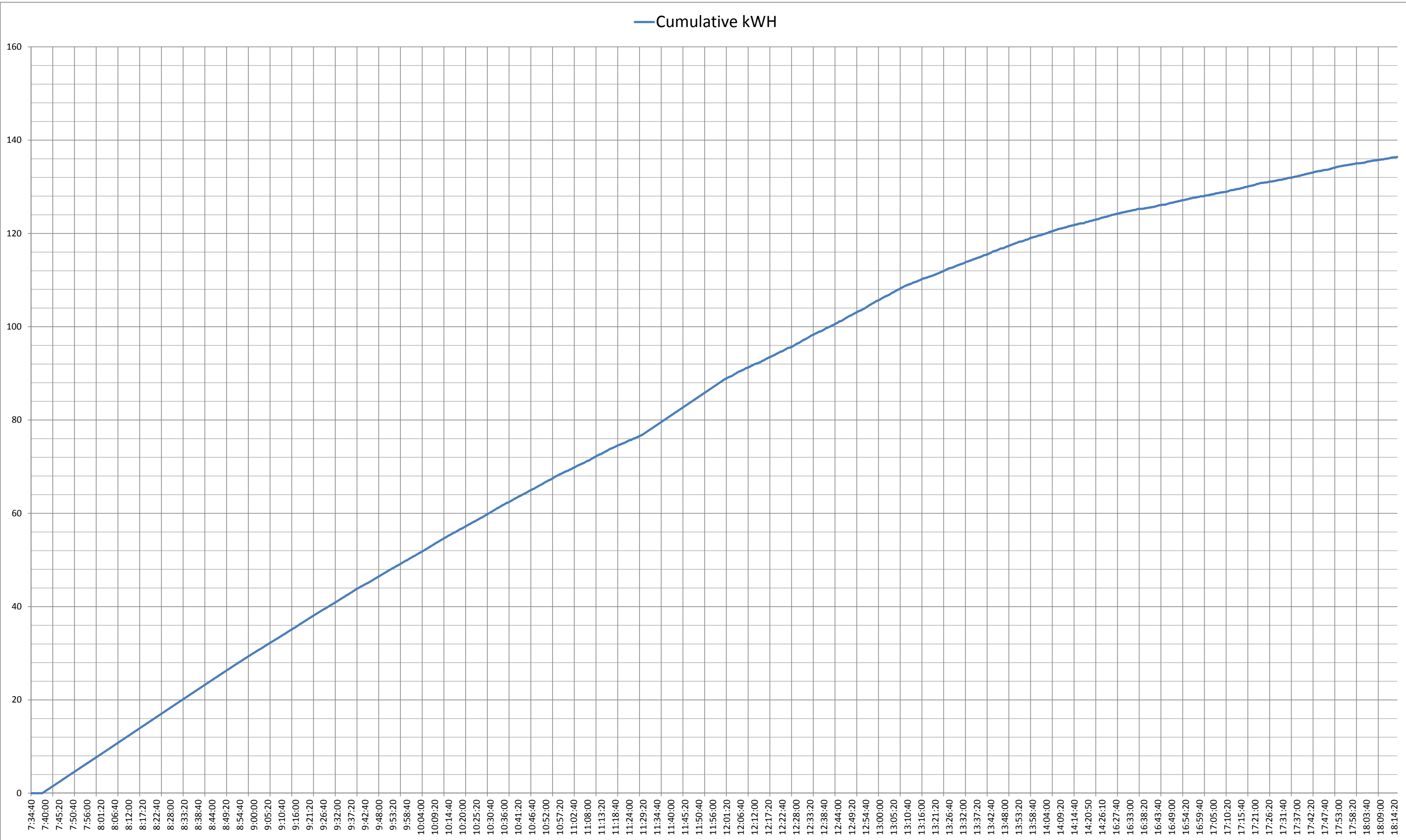

— Vapor Line Temp °F — Furnace Temp °F — Still Temp °F

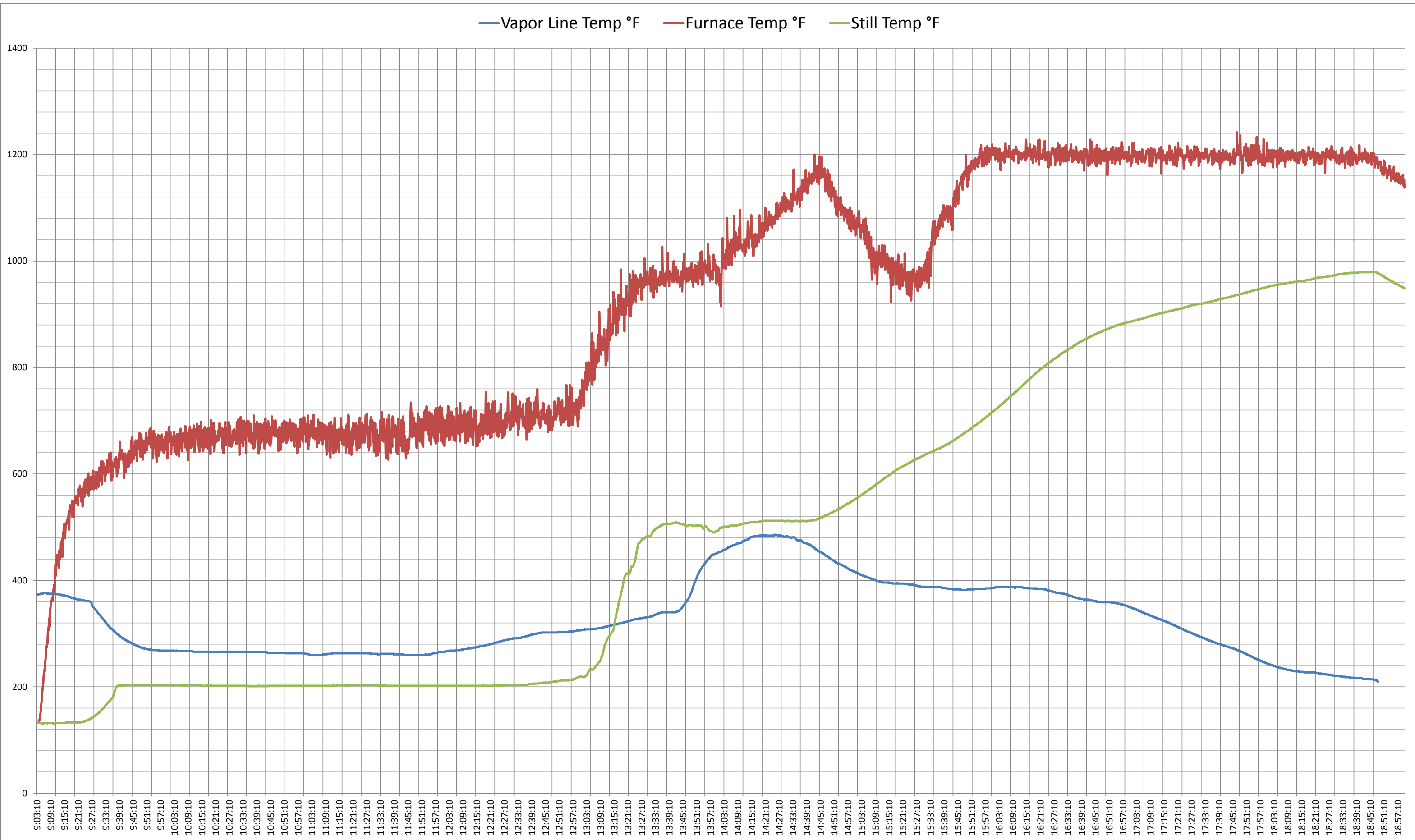

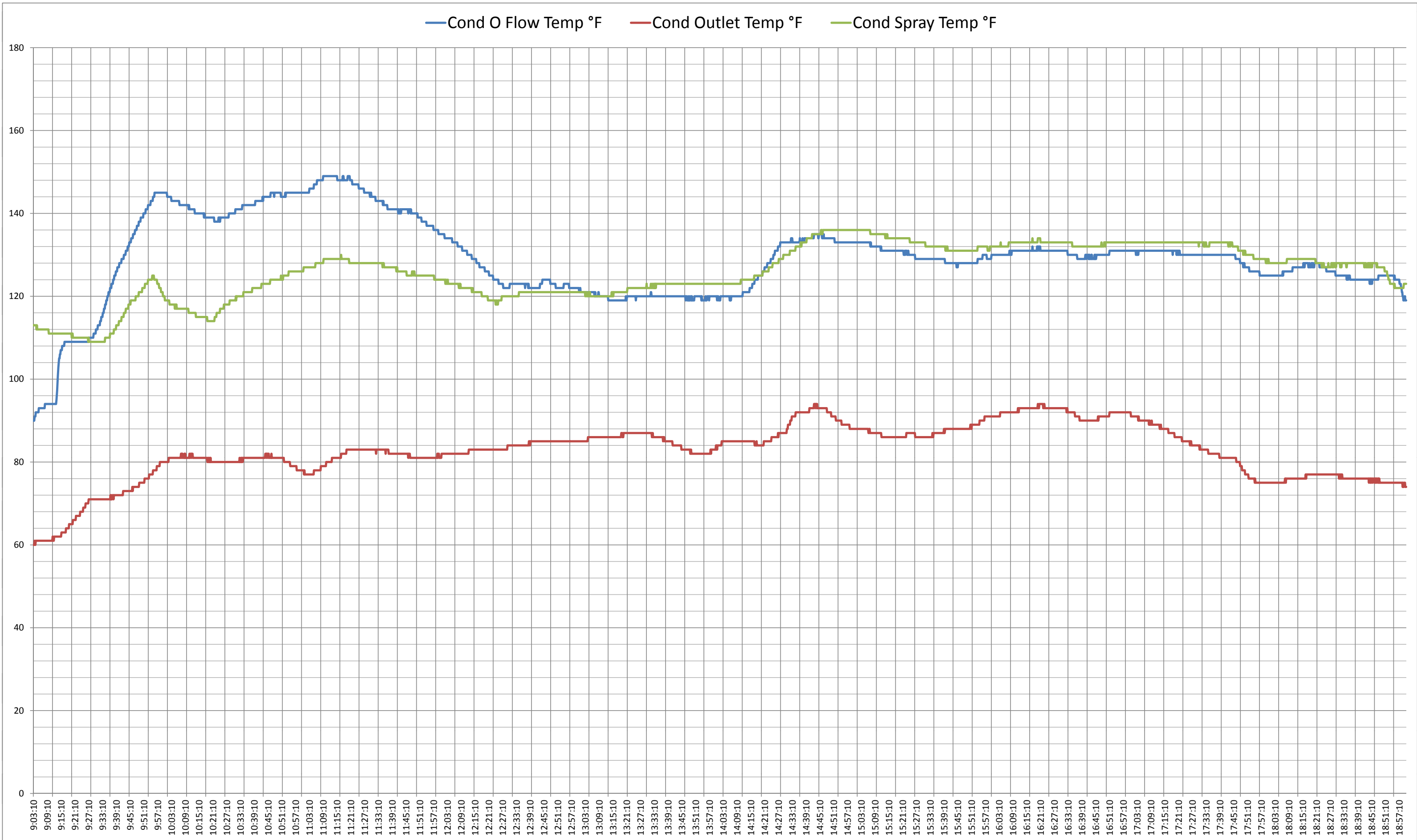

Vapor Line Press WC Educor In Press WC

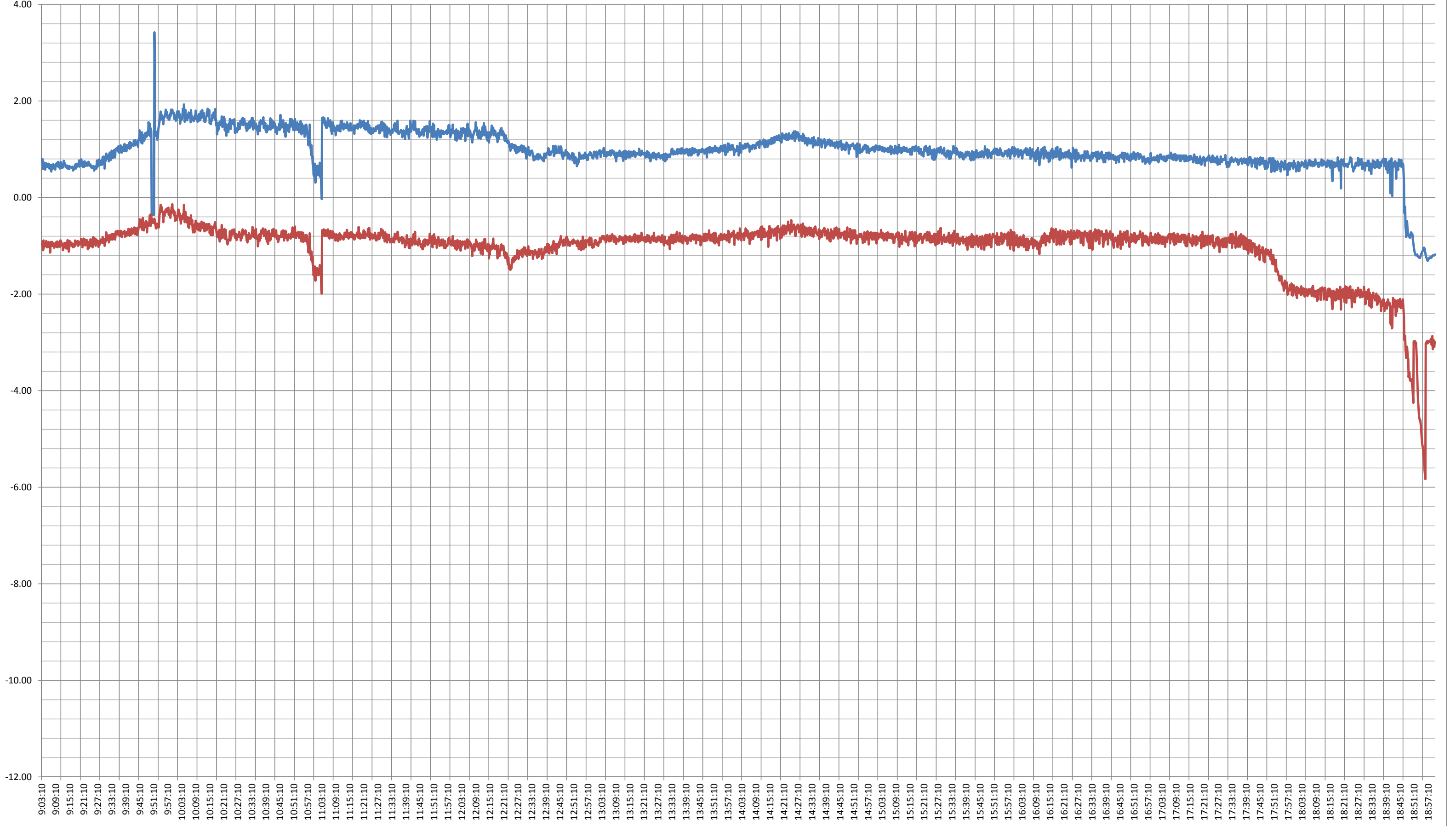



Cumulative kWh

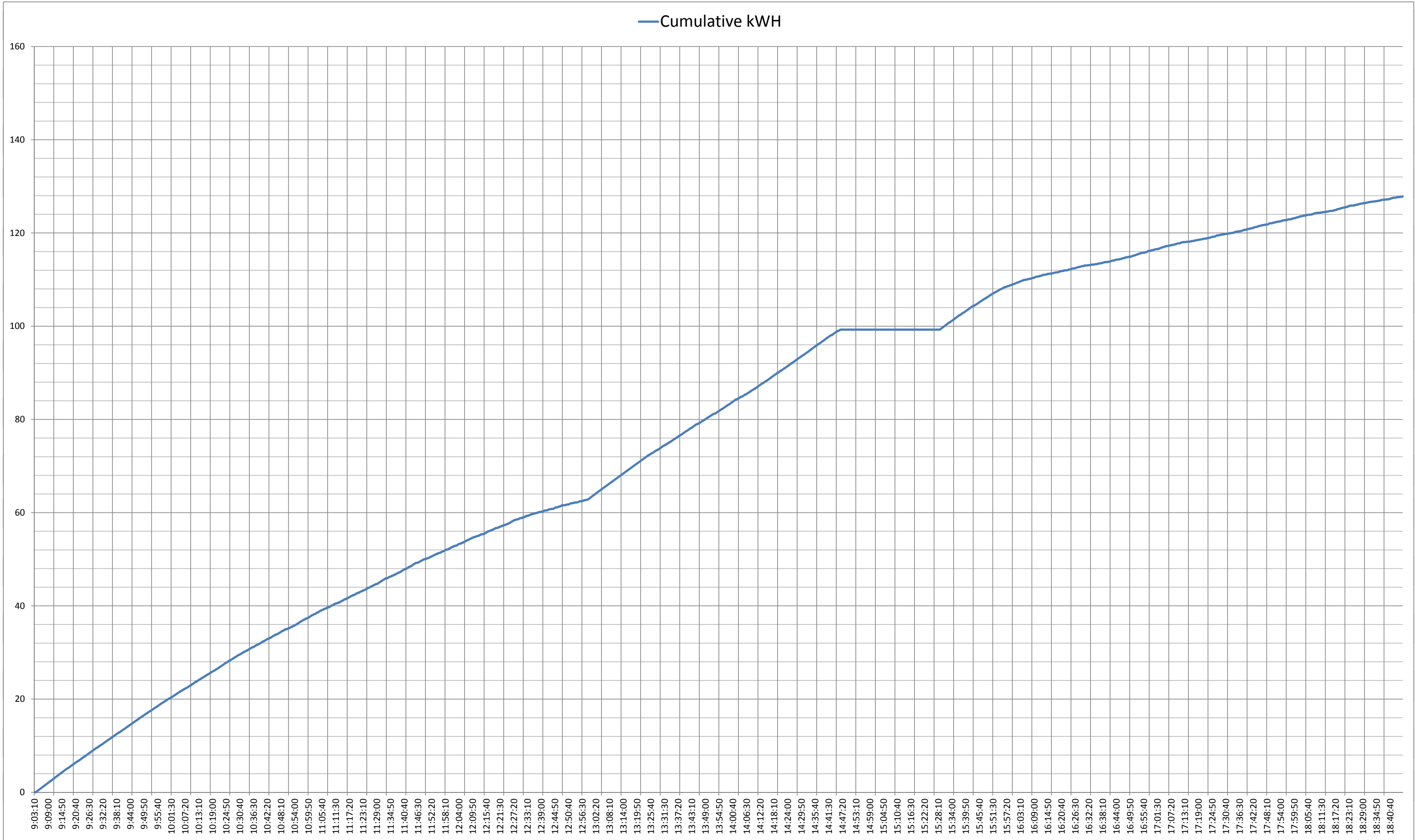

## **7.9 HMB Summary Sheets and Analysis Charts**

## HMB SUMMARY - ANALYSIS INFORMATION FOR ALL RUNS - 2011 CAMPAIGN

		Run #1	Run #2	Run #3	Run #4	Run #5	Run #6	Run #7	Run #8	Run #9	Run #10	Run #11	Run #12					
	<b>Variable</b>	<b>Units</b>												<b>Average</b>	<b>Sum</b>			
	Energy per Run	kWh	127.7	102.3	93.6	104.9	153.8	202	113	151	143.65	142.6	136	125.6	133.0	1596.15		
	Total Heating Time	hours	8.75	8.75	7	6.6	9	19.5	7.5	18	14.22	13	9.75	9.67	11.0	131.74		
	Agitation	Yes/No	Yes	No	Yes	Yes	Yes	No	Yes	Yes	No	No	No	Yes				
<b>Material as measured from Runs:</b>														<b>Average</b>	<b>Sum</b>	<b>% of Total</b>	<b>Laboratory Analysis Average</b>	
	Charge Weight	lbs	178.8	175.4	176.4	248	346.8	347.7	253.1	362	247	248.1	253	249	257.11	3085.3		
	P4	lbs	51.8	44.8	53.6	93.7	142.6	102.9	112.2	108.6	55.9	78.4	34.5	81.3	80.03	960.3	31.3%	32.6%
	Residue	lbs	36.9	65.4	48.1	47.8	64	99.2	44.1	98.7	64.1	61.8	49.7	47.2	60.58	727	23.7%	20.8%
	Water	lbs	90.1	65.2	69	95.76	140.2	145.6	96.8	154.7	127.2	107.9	163.9	120.5	114.74	1376.86	44.9%	46.6%
<b>Calculated Variables and Ratios:</b>														<b>Average</b>	<b>Ratio from Sums Above</b>		<b>Ratio from Laboratory Analysis Above</b>	
	P4/Residue	lb/lb	1.40	0.69	1.11	1.96	2.23	1.04	2.54	1.10	0.87	1.27	0.69	1.72	1.39	1.32		1.563
	P4/Time	lb/hour	5.92	5.12	7.66	14.20	15.84	5.28	14.96	6.03	3.93	6.03	3.54	8.41	8.08			
	kWh/P4	kWh/lb	2.47	2.28	1.75	1.12	1.08	1.96	1.01	1.39	2.57	1.82	3.94	1.54	1.91			
	kWh/Run Charged	kWh/lb	0.71	0.58	0.53	0.42	0.44	0.58	0.45	0.42	0.58	0.57	0.54	0.50	0.53			
	Time/Residue	hr/lb	0.24	0.13	0.15	0.14	0.14	0.20	0.17	0.18	0.22	0.21	0.20	0.20	0.18			
<b>HMB Variables:</b>														<b>Average</b>				
	Calculated Process Energy Used	kWh	49.27	47.86	43.87	55.92	79.92	81.35	58.93	77.75	68.65	60.36	78.64	62.43	63.75			
	Heat lost to inefficiencies	kWh	78.43	54.44	49.73	48.98	73.88	120.65	54.07	73.25	75.00	82.24	57.36	63.17	69.27			
	Per cent energy inefficiencies	%	61.4%	53.2%	53.1%	46.7%	48.0%	59.7%	47.8%	48.5%	52.2%	57.7%	42.2%	50.3%	51.7%			
	Per cent process energy usage as water	%	60%	45%	52%	57%	58%	58%	54%	66%	61%	59%	69%	63%	58.7%			

## HMB SUMMARY - ANALYSIS INFORMATION FOR ALL RUNS - NO AGITATION - 2011 CAMPAIGN

		Run #2	Run #6	Run #9	Run #10	Run #11					
Variable	Units						Average	Sum			
		Energy per Run	kWh	102.3	202	143.65	142.6	136	145.3	726.55	
Total Heating Time	hours	8.75	19.5	14.22	13	9.75	13.0	65.22			
Agitation	Yes/No	No	No	No	No	No					
							Average	Sum	% of Total	Laboratory Analysis Average	
<b>Material as measured from Runs:</b>	Charge Weight	lbs	175.4	347.7	247	248.1	253	254.24	1271.2		
	P4	lbs	44.8	102.9	55.9	78.4	34.5	63.30	316.5	25.0%	
	Residue	lbs	65.4	99.2	64.1	61.8	49.7	68.04	340.2	26.9%	
	Water	lbs	65.2	145.6	127.2	107.9	163.9	121.96	609.8	48.1%	
							Average	Ratio from Sums Above		Ratio from Laboratory Analysis Above	
<b>Calculated Variables and Ratios:</b>	P4/Residue	lb/lb	0.69	1.04	0.87	1.27	0.69	0.91	0.93	1.563	
	P4/Time	lb/hour	5.12	5.28	3.93	6.03	3.54	4.78			
	kWh/P4	kWh/lb	2.28	1.96	2.57	1.82	3.94	2.52			
	kWh/Run Charged	kWh/lb	0.58	0.58	0.58	0.57	0.54	0.57			
	Time/Residue	hr/lb	0.13	0.20	0.22	0.21	0.20	0.19			
							Average				
<b>HMB Variables:</b>	Calculated Process Energy Used	kWh	47.86	81.35	68.65	60.36	78.64	67.37			
	Heat lost to inefficiencies	kWh	54.44	120.65	75.00	82.24	57.36	77.94			
	Per cent energy inefficiencies	%	53.2%	59.7%	52.2%	57.7%	42.2%	53.0%			
	Per cent process energy usage as water	%	45%	58%	61%	59%	69%	58.6%			

## HMB SUMMARY - ANALYSIS INFORMATION FOR ALL RUNS - AGITATED - 2011 CAMPAIGN

		Run #1	Run #3	Run #4	Run #5	Run #7	Run #8	Run #12					
	Variable	Units							Average	Sum			
	<b>Material as measured from Runs:</b>	Energy per Run	kWh	127.7	93.6	104.9	153.8	113	151	125.6	124.2	869.6	
Total Heating Time		hours	8.75	7	6.6	9	7.5	18	9.67	9.5	66.52		
Agitation		Yes/No	Yes	Yes	Yes	Yes	Yes	Yes	Yes	Yes			
<b>Material as measured from Runs:</b>										<b>Average</b>	<b>Sum</b>	<b>% of Total</b>	<b>Laboratory Analysis Average</b>
	Charge Weight	lbs	178.8	176.4	248	346.8	253.1	362	249	259.16	1814.1		
	P4	lbs	51.8	53.6	93.7	142.6	112.2	108.6	81.3	91.97	643.8	35.8%	32.6%
	Residue	lbs	36.9	48.1	47.8	64	44.1	98.7	47.2	55.26	386.8	21.5%	20.8%
	Water	lbs	90.1	69	95.76	140.2	96.8	154.7	120.5	109.58	767.06	42.7%	46.6%
<b>Calculated Variables and Ratios:</b>										<b>Average</b>	<b>Ratio from Sums Above</b>		<b>Ratio from Laboratory Analysis Above</b>
	P4/Residue	lb/lb	1.40	1.11	1.96	2.23	2.54	1.10	1.72	1.72	1.66		1.563
	P4/Time	lb/hour	5.92	7.66	14.20	15.84	14.96	6.03	8.41	10.43			
	kWh/P4	kWh/lb	2.47	1.75	1.12	1.08	1.01	1.39	1.54	1.48			
	kWh/Run Charged	kWh/lb	0.71	0.53	0.42	0.44	0.45	0.42	0.50	0.50			
	Time/Residue	hr/lb	0.24	0.15	0.14	0.14	0.17	0.18	0.20	0.17			
<b>HMB Variables:</b>										<b>Average</b>			
	Calculated Process Energy Used	kWh	49.27	43.87	55.92	79.92	58.93	77.75	62.43	61.16			
	Heat lost to inefficiencies	kWh	78.43	49.73	48.98	73.88	54.07	73.25	63.17	63.07			
	Per cent energy inefficiencies	%	61.4%	53.1%	46.7%	48.0%	47.8%	48.5%	50.3%	50.8%			
	Per cent process energy usage as water	%	60%	52%	57%	58%	54%	66%	63%	58.7%			

## HMB SUMMARY - ANALYSIS INFORMATION FOR ALL RUNS - 2011 CAMPAIGN

		Run #5	Run #6	Run #8					
	Variable	Units				Average	Sum		
		Energy per Run	kWh	153.8	202	151	168.9	506.8	
Total Heating Time		hours	9	19.5	18	15.5	46.5		
Agitation		Yes/No	Yes	No	Yes				
						Average	Sum	% of Total	Laboratory Analysis Average
<b>Material as measured from Runs:</b>	Charge Weight	lbs	346.8	347.7	362	352.17	1056.5		
	P4	lbs	142.6	102.9	108.6	118.03	354.1	33.5%	32.6%
	Residue	lbs	64	99.2	98.7	87.30	261.9	24.8%	20.8%
	Water	lbs	140.2	145.6	154.7	146.83	440.5	41.7%	46.6%
<b>Calculated Variables and Ratios:</b>						Average	Ratio from Sums Above		Ratio from Laboratory Analysis Above
	P4/Residue	lb/lb	2.23	1.04	1.10	1.46	1.35		1.563
	P4/Time	lb/hour	15.84	5.28	6.03	9.05			
	kWh/P4	kWh/lb	1.08	1.96	1.39	1.48			
	kWh/Run Charged	kWh/lb	0.44	0.58	0.42	0.48			
	Time/Residue	hr/lb	0.14	0.20	0.18	0.17			
<b>HMB Variables:</b>						Average			
	Calculated Process Energy Used	kWh	79.92	81.35	77.75	79.67			
	Heat lost to inefficiencies	kWh	73.88	120.65	73.25	89.26			
	Per cent energy inefficiencies	%	48.0%	59.7%	48.5%	52.1%			
	Per cent process energy usage as water	%	58%	58%	66%	60.8%			

## HMB SUMMARY - ANALYSIS INFORMATION FOR 250# RUNS - 2011 CAMPAIGN

		Run #4	Run #7	Run #9	Run #10	Run #11	Run #12				
Variable	Units							Average	Sum		
	Energy per Run	kWh	104.9	113	143.65	142.6	136	125.6	127.6	765.75	
Total Heating Time	hours	6.6	7.5	14.22	13	9.75	9.67	10.1	60.74		
Agitation	Yes/No	Yes	Yes	No	No	No	Yes				
								Average	Sum	% of Total	Laboratory Analysis Average
<b>Material as measured from Runs:</b>	Charge Weight	lbs	248	253.1	247	248.1	253	249	249.70	1498.2	
	P4	lbs	93.7	112.2	55.9	78.4	34.5	81.3	76.00	456	30.8%
	Residue	lbs	47.8	44.1	64.1	61.8	49.7	47.2	52.45	314.7	21.2%
	Water	lbs	95.76	96.8	127.2	107.9	163.9	120.5	118.68	712.06	48.0%
								Average	Ratio from Sums Above		Ratio from Laboratory Analysis Above
<b>Calculated Variables and Ratios:</b>	P4/Residue	lb/lb	1.96	2.54	0.87	1.27	0.69	1.72	1.51	1.45	1.563
	P4/Time	lb/hour	14.20	14.96	3.93	6.03	3.54	8.41	8.51		
	kWh/P4	kWh/lb	1.12	1.01	2.57	1.82	3.94	1.54	2.00		
	kWh/Run Charged	kWh/lb	0.42	0.45	0.58	0.57	0.54	0.50	0.51		
	Time/Residue	hr/lb	0.14	0.17	0.22	0.21	0.20	0.20	0.19		
								Average			
<b>HMB Variables:</b>	Calculated Process Energy Used	kWh	55.92	58.93	68.65	60.36	78.64	62.43	64.15		
	Heat lost to inefficiencies	kWh	48.98	54.07	75.00	82.24	57.36	63.17	63.47		
	Per cent energy inefficiencies	%	46.7%	47.8%	52.2%	57.7%	42.2%	50.3%	49.5%		
	Per cent process energy usage as water	%	57%	54%	61%	59%	69%	63%	60.7%		



## HMB SUMMARY - ANALYSIS INFORMATION FOR 175# RUNS - 2011 CAMPAIGN

		Run #1	Run #2	Run #3					
	Variable	Units				Average	Sum		
		Energy per Run	kWh	127.7	102.3	93.6	107.9	323.6	
	Total Heating Time	hours	8.75	8.75	7	8.2	24.5		
	Agitation	Yes/No	Yes	No	Yes				
						Average	Sum	% of Total	Laboratory Analysis Average
<b>Material as measured from Runs:</b>	Charge Weight	lbs	178.8	175.4	176.4	176.87	530.6		
	P4	lbs	51.8	44.8	53.6	50.07	150.2	28.6%	32.6%
	Residue	lbs	36.9	65.4	48.1	50.13	150.4	28.7%	20.8%
	Water	lbs	90.1	65.2	69	74.77	224.3	42.7%	46.6%
						Average	Ratio from Sums Above		Ratio from Laboratory Analysis Above
<b>Calculated Variables and Ratios:</b>	P4/Residue	lb/lb	1.40	0.69	1.11	1.07	1.00		1.563
	P4/Time	lb/hour	5.92	5.12	7.66	6.23			
	kWh/P4	kWh/lb	2.47	2.28	1.75	2.17			
	kWh/Run Charged	kWh/lb	0.71	0.58	0.53	0.61			
	Time/Residue	hr/lb	0.24	0.13	0.15	0.17			
						Average			
<b>HMB Variables:</b>	Calculated Process Energy Used	kWh	49.27	47.86	43.87	47.00			
	Heat lost to inefficiencies	kWh	78.43	54.44	49.73	60.87			
	Per cent energy inefficiencies	%	61.4%	53.2%	53.1%	55.9%			
	Per cent process energy usage as water	%	60%	45%	52%	52.5%			

# TOTAL HEATING TIME vs. MATERIAL CHARGE QUANTITIES

◆ Total Charge (lbs)    ▲ Residue (lbs)    ▲ Water (lbs)

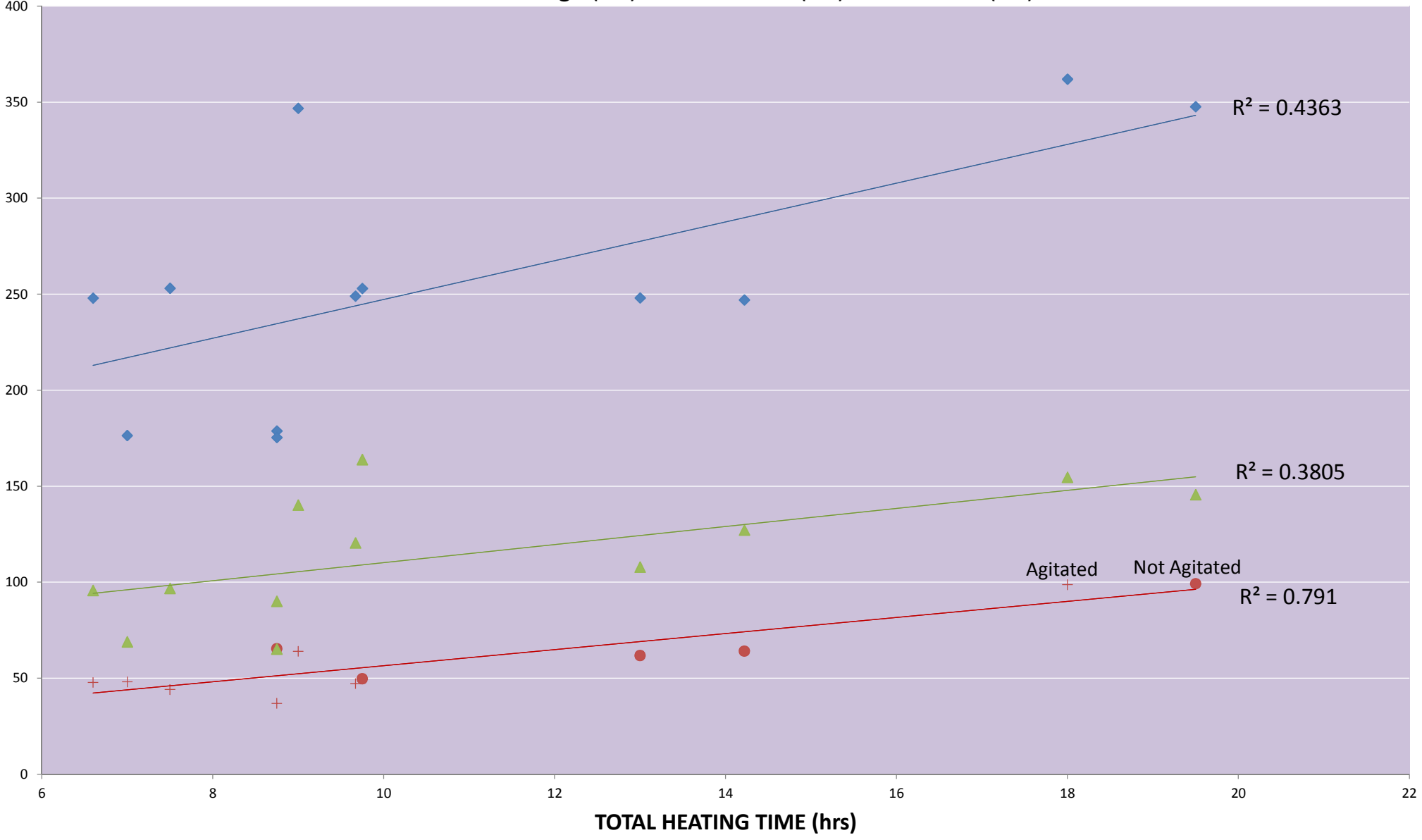

# PER CENT PROCESS ENERGY AS WATER vs. WATER CHARGED (lbs)

◆ % Process Energy as H2O

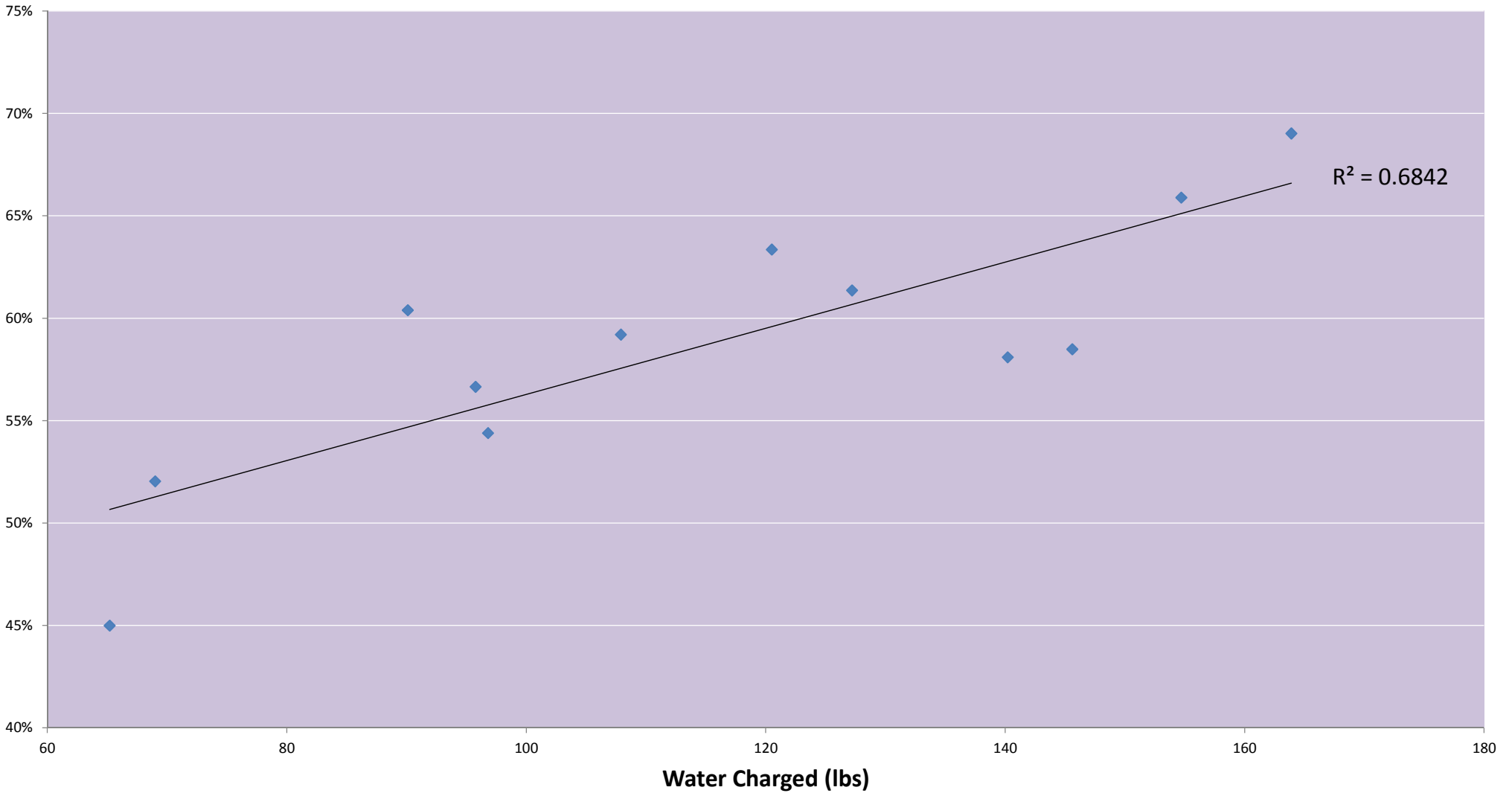

## **7.10 Residue Analysis Summary**

## Rhodia Phosphorus Recovery Pilot Plant 2011 Residue Summary

Residue Collection Date	Test Number	Drum Number	A/B Sample	Field Flammability Test	Field Test for PH3 Generation	EPA 1030 Ignitability Test	Burn Rate Test	Residue Density	TCLP Sample to Lab	TCLP Results	Sample Residue Disposal Location	
6/15/2011	Test 1	12	A	Negative	Negative	Negative	Not Reqd.	30.41	6/28/2011	Failed for Cadmium - 2.69 mg/L	Clarifer	
6/22/2011	Test 2	5	B	Negative	Negative	Negative	Not Reqd.	30.76	6/28/2011	Passed all TCLP analysis	Clarifer	
6/22/2011	Test 2 Re-run	5	B	Negative	Negative	Negative	Not Reqd.	30.76	7/22/2011	Failed for Cadmium - 1.86 mg/L	Clarifer	
6/24/2011	Test 3	5	B	Negative	Negative	Negative	Not Reqd.	30.76	7/7/2011	Failed for Cadmium - 2.03 mg/L	Residue Drum 1	
6/24/2011	Test 3 Re-run	5	B	Negative	Negative	Negative	Not Reqd.	30.76	7/22/2011	Failed for Cadmium - 3.06 mg/L	Residue Drum 1	
6/29/2011	Test 4	7	A	Negative	Negative	Negative	Not Reqd.	31.69	7/7/2011	Passed all TCLP analysis	Residue Drum 2	
7/13/2011	Test 5	8	A	Negative	Negative	Negative	Not Reqd.	34.05	7/22/2011	Failed for Cadmium - 1.86 mg/L	Residue Drum 3	
7/20/2011	Test 6	10	A	Negative	Negative	Negative	Not Reqd.	31.49	7/22/2011	Failed for Cadmium - 2.53 mg/L	Residue Drum 4	
	Test 7	7	A	Negative	Negative	Negative	Not Reqd.	33.47		Residue contaminated - No TCLP Analysis	Clarifer	
	Test 8	11	A	Residue contaminated with RAP. Unable to obtain samples.							Residue contaminated - No TCLP Analysis	Clarifer
8/10/2011	Test 9	1	A	Negative	Negative	Negative	Not Reqd.	34.00	8/19/2011	Failed for Cadmium - 2.65 mg/L	Clarifier	
8/16/2011	Test 10	9	A	Negative	Negative	Negative	Not Reqd.	30.87	8/19/2011	Failed for Cadmium - 1.45 mg/L	Clarifier	
8/24/2011	Test 11	3	A	Negative	Negative	Negative	Not Reqd.	30.95	8/19/2011	Passed all TCLP analysis	Residue Drum 5	
	Test 12	2	A	Negative	Negative	Negative	Not Reqd.	31.56		Residue contaminated - No TCLP Analysis	Clarifier	

## **8.0 PICTURES**



General Pilot Plant Arrangement



Trackhoe Sampling the Clarifier





Loading the Sample Drum



Loading the Still





Loaded Still Ready to be Placed in Furnace





Residue in Still after Completed Batch



Recovered P4