



Superfund Radiation Risk Assessment Calculator Training

Stuart Walker, OSRTI
Fred Dolislager, ORNL

Purpose of Training

- Facilitate remedy selection and cleanup at radioactively-contaminated sites.
- Establish knowledge base on radiation, radiation risk assessment, and CERCLA requirements and other relevant policy.
- Simplify radiation risk assessment through use of 8 radionuclide guidance calculators.
- Demonstrate similar risk assessment capabilities in SADA using GIS
- Demonstrate the compatibility with RSL chemical calculator.

Outline of Training

1. How Radiation Fits in Superfund
2. Radiation Risk Assessment Video & Community Toolkit
3. PRG Calculator
4. DCC Calculator
5. RSL for Total Uranium
6. BPRG and BDCC Calculators
7. SPRG and SDCC Calculators
8. Differences between EPA and DOE Tools
9. BCG Calculator
10. CPM Calculator
11. SADA
12. Radiation Science Primer
13. Radiation Risk Assessment Basics



Radiation Risk Assessment Calculator Training

Section 1: How Radiation Fits Into Superfund



United States
Environmental Protection
Agency

Superfund Radiation Risk
Assessment Calculator Training

Superfund sites: Number and Progress

- ◆ 1,320 NPL sites
 - 66 are radiation sites
 - 59 more sites proposed for NPL
 - 1 is a radiation site
- ◆ 1,174 NPL sites are “construction completion”
 - 38 are radiation sites
- ◆ 389 Sites have been deleted from NPL
 - 9 are radiation sites

How to Address Radiation in a Chemical Program?

- ◆ With only 66 radioactively contaminated sites out of 1,320 total, the focus of the Superfund program has been on chemicals.
- ◆ **Question:** How best address radiation?
- ◆ **Answer:** Address radiation in a consistent manner with chemicals, except to account for the technical differences posed by radiation
 - Radiation easily fits within Superfund framework
 - Improves public confidence by taking mystery out of radiation

Why Does Radiation Easily Fit within the Superfund Framework?

- ◆ Primary effect is cancer
- ◆ People ingest, inhale, eat, same amount of contaminated dust and food whether it is chemical or radioactive contamination,
- ◆ Dust gets resuspended the same whether it is chemically or radioactively contaminated
- ◆ Inorganic elements move through the subsurface whether they are radioactive or not

Nine CERCLA Remedy Selection Criteria

- ◆ Two threshold criteria (both must be met)
 1. Protect human health and the environment
 2. Comply (attain or waive) with other federal and state laws: Applicable or Relevant and Appropriate Requirements (ARARs)
 - Protect current or future sources of drinking water (e.g., attain MCLs or more stringent state standards)



Nine CERCLA Remedy Selection Criteria (continued)

◆ 6 CERCLA ARAR waivers

1. Interim Measure
2. Greater Risk to Health and the Environment
3. Technical Impracticability
4. Equivalent Standard of Performance
5. Inconsistent Application of State Requirements
6. Fund Balancing



Nine CERCLA Remedy Selection Criteria (continued)

- ◆ Five balancing criteria (used to evaluate between potential remedies that meet threshold criteria)
 1. Long-term effectiveness and permanence
 2. Reduction of waste toxicity, mobility, or volume
 3. Short-term effectiveness
 4. Implementability
 5. Cost



Nine CERCLA Remedy Selection Criteria (continued)

- ◆ Two modifying criteria (information from public comment period that may modify remedial action)
 1. State acceptance
 2. Community acceptance



CERCLA Cleanup Levels

- ◆ ARARs often determine cleanup levels
- ◆ Where ARARs are not available or protective, EPA sets site-specific cleanup levels that
 - For carcinogens, represent an increased cancer risk of 1×10^{-6} to 1×10^{-4}
 - 10^{-6} used as “point of departure”
 - PRGs are established at 1×10^{-6}
 - For non-carcinogens, will not result in adverse effects to human health (hazard index (HI) <1)
- ◆ Address ecological concerns
- ◆ To-be-considered (TBC) material may help determine cleanup level

CERCLA Cleanup Levels Are NOT Based On

- ◆ NRC decommissioning requirements (e.g., 25, 100 mrem/yr dose limits) 10 CFR 20 Subpart E
 - If used as an ARAR, 10^{-6} still used as point of departure, and 10^{-4} to 10^{-6} risk range must be met
- ◆ Guidance outside risk range and/or if expressed as a dose (# mrem/year). This includes:
 - DOE orders, NRC guidance (e.g., NUREGs), ICRP guidance, IAEA guidance, NCRP guidance, ANSI/HPS guidance, EPA/DHS PAGs, and Federal guidance

Guidance: Risk Assessment Q&A

Originally Issued 1999

- ◆ *Radiation Risk Assessment at CERCLA Sites: Q&A* (12/99) OSWER Directive 9200.4-31P
- ◆ Provides **overview of then current** EPA guidance for radiation risk assessment
- ◆ Written for users familiar with Superfund but not radiation
- ◆ Added some new guidance
 - Dose assessment only for ARAR compliance
 - No dose-based TBCs (including **No** 15 mrem/yr [0.15 mSv/yr])
 - Direct exposure rate may supplement sampling



Guidance: Risk Assessment Q&A

Revised Issued 2014

- ◆ *Radiation Risk Assessment at CERCLA Sites: Q&A* (6/14) OSWER Directive 9200.4-40
- ◆ Provides **overview of now current** EPA guidance for radiation risk assessment
- ◆ Written for users familiar with Superfund but not radiation
- ◆ Updates old overview and adds some new guidance
 - See following slides

Reflect Superfund Recommended guidance issued since 1999

1. Rad SSG User Guide 2000
2. Rad SSG TBD 2000
3. PRG calculator 2002
4. Common Rads found at Superfund sites 2002
5. DCC calculator 2004
6. SF Rad Risk Assessment & How You Can Help 2005
7. BPRG calculator 2006
8. SPRG calculator 2009
9. BDCC calculator 2010
10. SDCC calculator 2010
11. CPM calculator 2016?
12. Eco calculator 2016?



United States
Environmental Protection
Agency

Superfund Radiation Risk
Assessment Calculator Training

Update Policies Based on Newer Science

- ◆ For an effective dose standard ARAR to be considered protective, it should be 12 mrem/yr or less.
 - Change from 15 mrem/yr based on risk to dose estimate in Federal Guidance 13
 - Cleanup levels not based on an ARAR continue to be based on cancer risk range (10-4 to 10-6) not dose

Update Policies Based on Newer Science, cont.

- ◆ To comply with UMTRCA indoor radon standards as an ARAR, users may assume the following concentrations correspond to 0.02 Working Levels:
 - 5 pCi/l of Rn-222
 - 7.5 pCi/l of Rn-220
- ◆ The methodology for making these conversions is discussed in ICRP “Lung Cancer Risk from Radon and Progeny”

More consistency on Risk Assessments (Rad & Chem)

- ◆ Explain what type of circumstances these Superfund guidance and tools are recommended
- ◆ Reiterate more strongly that risk assessments (e.g., models used) should be consistent with chemicals at site and with other regional sites
- ◆ Don't use a steady state model for chemical and a transfer/dynamic model for radionuclides
 - Such as using RSL calculator for chemicals then RESRAD for radionuclides, more on this later

More consistency on Surveys (Rad & Chem)

- ◆ Explain what type of circumstances these Superfund guidance and tools are recommended
- ◆ Reiterate more strongly that site surveys (e.g., characterization and confirmation) should be consistent with chemicals at site and with other regional sites
- ◆ Don't use not-to-exceed (NTE) for chemicals and area averaging (AA) for radionuclides for residential
 - NTE for residential cleanup of chemicals but AA approach like MARSIMM for the radionuclides





Radiation Risk Assessment Calculator Training

Section 2: Radiation Risk Assessment Video & Community Toolkit

Video: Radiation Risk Assessment

- ◆ *Superfund Radiation Risk Assessment and How you can Help, an Overview (3/05)*
OSWER Directive 9200.4-37
- ◆ Video for the general public. It contains information on:
 - The Superfund risk assessment process when addressing radioactive contamination
 - How the public is involved site-specifically

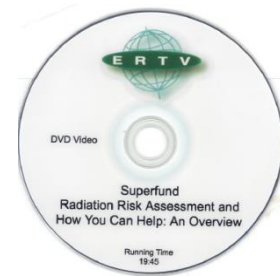

Community Toolkit

- This toolkit was developed to help the public understand more about the risk assessment process used at Superfund sites with radioactive contamination.
 - Text is written in plain English (8th grade level)

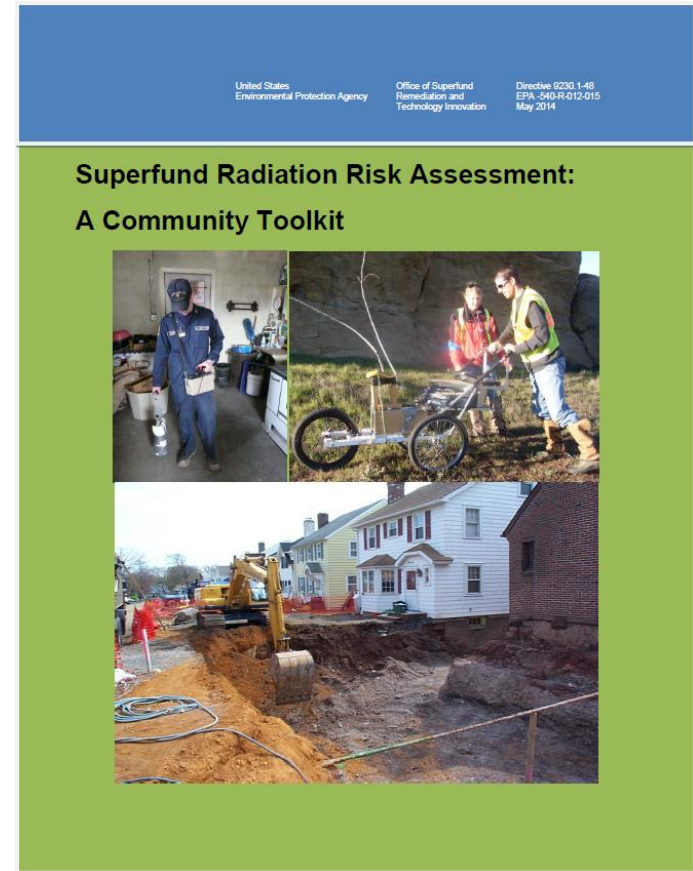

Toolkit Organization

- ◆ The Toolkit is made up of a collection of 22 fact sheets.
 - Not every fact sheet will be useful at each site.
 - Regions will also continue to use other community involvement tools and site-specific fact sheets
- ◆ The first 2 fact sheets in this toolkit are:
 1. Superfund Radiation Fact Sheet (10 pages)
 2. Superfund Radiation Risk Assessment Fact Sheet (8 pages)

Superfund Radiation Fact Sheet

- ◆ Provides information answering the following questions
 - What is Superfund?
 - What are atoms?
 - What is Radiation?
 - What is Radioactivity?
 - What happens to radionuclides as they decay?
 - What is half-life?

Superfund Radiation Fact Sheet continued

- How is radioactivity measured?
- Why are radionuclides harmful to human health?
- How can you be exposed to harmful radiation?
- How is radiation exposure measured?
- How does EPA calculate risks to human health from radiation exposure at Superfund sites?
- What is background radiation?

Superfund Radiation Fact Sheet continued



Superfund Radiation Fact Sheet

What is Superfund? The Superfund program is administered by U.S. Environmental Protection Agency (EPA) in cooperation with state and tribal governments. It allows EPA to clean up hazardous waste sites and to force responsible parties to perform cleanups or reimburse the government for cleanups led by EPA.

For a variety of reasons, hazardous commercial and industrial wastes were mismanaged and may pose unacceptable risks to human health and the environment. This waste was dumped on the ground or in waterways, left out in the open, or otherwise improperly managed. As a result, thousands of hazardous waste sites were created throughout the United States. These hazardous waste sites commonly include manufacturing facilities, processing plants, landfills, and mining sites.



Superfund is the informal name for the Comprehensive Environmental Response, Compensation, and Liability Act (CERCLA). In 1980, Congress enacted CERCLA in response to growing concerns over the health and environmental risks posed by hazardous waste sites. This law was enacted in the wake of the discovery of chemically contaminated toxic waste dumps such as Love Canal and Valley of the Drums in the 1970s.

Some Superfund sites contain radioactive contamination. This document was developed by EPA to answer questions about radiation hazards and how EPA assesses health risks from potential exposure to radioactive contamination at Superfund sites.

Superfund was established in 1980 by an act of Congress, giving EPA the funds and authority to clean up polluted sites

Goals of Superfund:

- Protect human health and the environment by cleaning up polluted sites
- Involve communities in the Superfund process
- Make responsible parties pay for work performed at Superfund sites

-1-

Ionizing Radiation Found at Superfund Sites

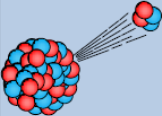
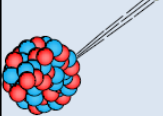
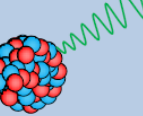
	Alpha Particles	Beta Particles	Gamma Rays
Description	 <ul style="list-style-type: none"> • Two protons and two neutrons bound together into a single particle • Heaviest and slowest moving type of ionizing radiation • Positively charged 	 <ul style="list-style-type: none"> • Made up of an electron ejected from nucleus • Fast moving, low mass particle • Negatively charged 	 <ul style="list-style-type: none"> • Pure energy traveling at the speed of light • Often accompanies the emission of alpha or beta particles • Has no rest mass and no charge
Ionizing Power	<ul style="list-style-type: none"> • HIGH • Interacts strongly with surrounding material • Very energetic 	<ul style="list-style-type: none"> • MODERATE • Interact less strongly than alpha particles but more strongly than gamma rays with surrounding material 	<ul style="list-style-type: none"> • LOW • Since they have no mass and no charge, gamma rays interact with matter less than alpha and beta particles
Penetrating Power	<ul style="list-style-type: none"> • LOW • Travels no more than a few centimeters in air • Can be stopped by a sheet of paper • Unable to penetrate skin 	<ul style="list-style-type: none"> • MODERATE • Able to travel several meters through air • Can be stopped by a thin layer of metal or plastic • Can penetrate outer layers of skin 	<ul style="list-style-type: none"> • HIGH • Able to travel hundreds of meters through air • Can be stopped by a thick concrete wall • Able to pass through the human body
Human Health Effects	<ul style="list-style-type: none"> • No health effects from external exposure since they are unable to penetrate skin • Very harmful if alpha-emitting radionuclide is taken into the body by ingestion, breathing, or through an open wound 	<ul style="list-style-type: none"> • Can cause skin burns from external exposure • Harmful if taken into the body (though not usually as harmful as alpha particles) 	<ul style="list-style-type: none"> • Can cause harm from external exposure • Can pass into the body and cause internal radiation exposure

-4-

Superfund Radiation Fact Sheet continued

Some Common Ways to be Exposed to Radionuclides at Contaminated Sites

Residential Soil Exposure



Agricultural Soil Exposure

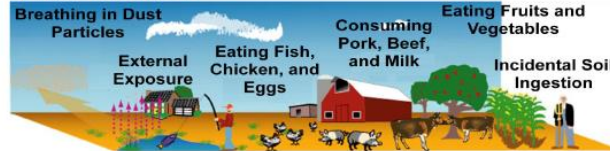

Soil to Ground Water Exposure

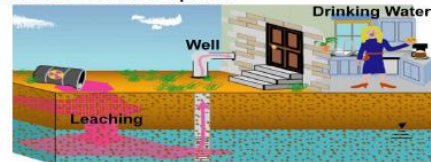

Tap Water Exposure



- 8 -

RELATIVE DOSES FROM RADIATION SOURCES Millirem Doses

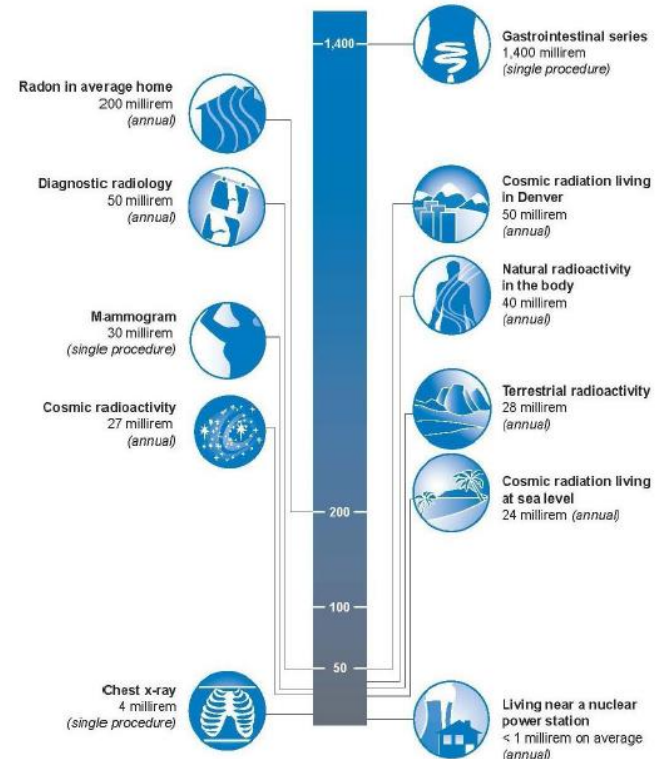

Superfund Radiation Risk Assessment Fact Sheet

- ◆ Describes each of the 4 steps of the Superfund risk assessment process at radioactively contaminated sites
 1. Data Collection and Evaluation
 2. Exposure Assessment
 3. Toxicity Assessment
 4. Risk Characterization

Superfund Radiation Risk Assessment Fact Sheet, continued



Superfund Radiation Risk Assessment Fact Sheet

The Superfund program uses a process called **risk assessment** to calculate health risks posed by hazardous contamination and waste. A risk assessment conducted at Superfund sites with radioactive contamination is divided into four parts:



The first three steps allow EPA to answer key questions about the contaminated site:

- What type of radioactive contamination is present?
- Where is the radioactive contamination located?
- How could people be exposed to the contamination?
- What are the potential harmful health effects from the contamination?
- And what are the uncertainties?

All of this information is then incorporated in the risk characterization, which is used to make a decision about how to clean up the site.

-1-

Step 3: Toxicity Assessment

The toxicity assessment phase answers two key questions: what potential harmful health effects can the radionuclide cause, and how much exposure to the radionuclide does it take to pose a significant risk to people?

The toxicity assessment is concerned with the potential for radionuclides to cause cancer. All radionuclides can cause cancer and are assumed to be potentially harmful even at low doses. The risk of cancer from radiation increases as the exposure increases. Uranium radionuclides are the only radionuclides where the noncancer effects are also considered during Superfund site cleanup.

In estimating the toxicity of a radionuclide, EPA must take into account the type of radiation it emits and how the radiation affects different organs in the



Understanding Radiation Toxicity

At much higher radiation exposures than would be expected at a Superfund site, harmful effects can be produced in a relatively short time. An example of this is the sickness seen in atomic bomb survivors. Since exposure at Superfund sites is usually much lower, EPA focuses primarily on the cancer risk from exposure to radionuclides.

body. Alpha particles, for example, inflict about 20 times more damage to living tissue than beta particles or gamma rays. In addition, different organs in the body have different cancer rates even when exposed to the same level of radiation. As a result, EPA must consider both whole body radiation exposure as well as specific organ exposure for certain radionuclides.

EPA has developed two methods to assess the harmful effects of exposure to specific radionuclides:

- Slope factors provide cancer risk posed by lifetime exposure to specific

-5-

Compendium of Information on the PRG & DCC Calculators

- ◆ Attachment A provides 1 Page Fact Sheets on each of the Superfund risk and dose assessment models
 3. Primer on EPA PRG and DCC Calculators
 4. Preliminary Remediation Goals (PRG) Calculator
 5. Dose Compliance Concentration (DCC) Calculator
 6. Building Preliminary Remediation Goals (BPRG) Calculator
 7. Building Dose Compliance Concentration (BDCC) Calculator
 8. Surface Preliminary Remediation Goals (SPRG) Calculator
 9. Surface Dose Compliance Concentration (SDCC) Calculator

Compendium of Information on the PRG & DCC Calculators, continued

- ◆ The PRG & DCC calculator fact sheets explain:
 - What is a PRG or DCC?
 - What media are addressed in the calculator?
 - What exposure pathways are addressed in the calculator?

Preliminary Remediation Goals (PRG) Calculator Fact Sheet



Preliminary Remediation Goals (PRG) Calculator



Stuart Walker – walker.stuart@epa.gov, (703) 603-8748
Office of Superfund Remediation and Technology Innovation, US Environmental Protection Agency

PRG: <http://epa-prgs.ornl.gov/radionuclides>

What is PRG?

- PRG stands for **Preliminary Remediation Goal**.
- PRGs are the initial cleanup goals at a Superfund site and usually are not final cleanup levels.
- Used when there is no appropriate government regulation of cleanup levels.

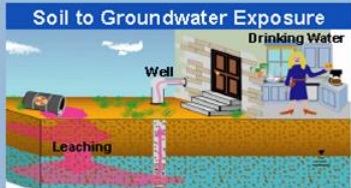

PRG Calculator

- The **PRG Calculator** is a tool that allows EPA to calculate initial cleanup levels for radiation in soil, water, and air at Superfund sites.
- Uses **slope factors** to calculate cleanup levels based on a **target cancer risk of 10^{-6}** .
 - Slope factors** provide cancer risk posed by lifetime exposure to specific radionuclides. Slope factors also take into account the type of exposure (inhalation, ingestion, or external) and amount of exposure. For example, a resident on a site would expect to have a different exposure level than a worker on the same site.
 - Target cancer risk of 10^{-6}** means that a person exposed to the contamination has a one in a million chance of developing cancer. (Target is based on highest estimated level of exposure. Most people will have less of a chance of developing cancer.)
- The exposure pathways calculated by the PRG calculator are shown in the diagrams below.

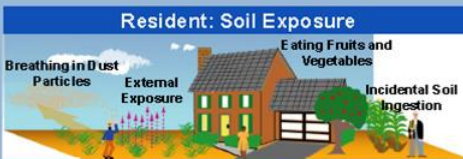
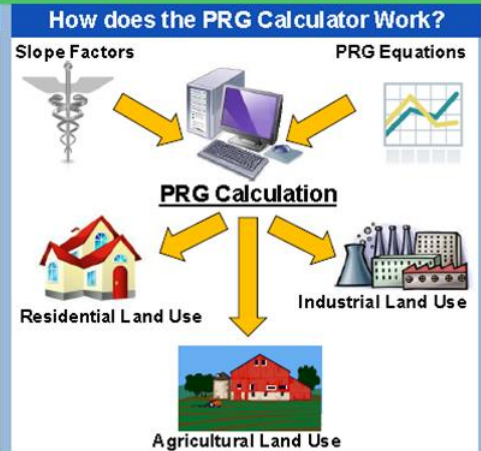

Fact Sheets on Radionuclides Commonly Found at Superfund Sites

- ◆ Attachment B provides 2-3 page Fact Sheets on Radionuclides Commonly Found at Superfund Sites
 - 10. Primer on Radionuclides Commonly Found at Superfund Sites
 - 11. Americium-241
 - 12. Cesium-137
 - 13. Cobalt-60
 - 14. Iodine
 - 15. Plutonium
 - 16. Radium
 - 17. Radon
 - 18. Strontium-90
 - 19. Technecium-99
 - 20. Thorium
 - 21. Tritium
 - 22. Uranium



Fact Sheets on Radionuclides Commonly Found at Superfund Sites

- ◆ Similar to the 2002 booklet that is replaced by this toolkit, each of these fact sheets contains information on:
 - Potential health effects of exposure to radionuclides commonly found at Superfund sites
 - EPA policies for cleaning up these radionuclides

Cesium-137 Fact Sheet



EPA Facts about Cesium-137

What is cesium-137?

Radioactive cesium-137 is produced spontaneously when other radioactive materials, such as uranium and plutonium, absorb neutrons and undergo fission. Fission is the process in which the nucleus of a radionuclide splits into smaller parts. Cesium-137 is a common radionuclide produced when nuclear fission of uranium and plutonium occurs in a reactor or atomic bomb.

What are the uses of cesium-137?

Cesium-137 and its decay product, barium-137m, are used in food sterilization, including wheat, spices, flour, and potatoes. Cesium-137 is used in a wide variety of industrial instruments, such as level and thickness gauges and moisture density gauges. Cesium-137 is also commonly used in hospitals for diagnosis and treatment. Large sources can be used to sterilize medical equipment.

How does cesium change in the environment?

Cesium-137 decays in the environment by emitting beta particles. As noted above, cesium-137 decays to a short-lived decay product, barium-137m. The latter isotope emits gamma radiation of moderate energy, which further decays to a stable form of barium. The time required for a radioactive substance to lose 50 percent of its radioactivity by decay is known as the half-life. Cesium-137 is significant because of

its prevalence, relatively long half life (30 years), and its potential effects on human health. Barium-137, the daughter product of cesium-137 decay, has a half-life of 2.6 minutes.

How are people exposed to cesium-137?

People may be exposed externally to gamma radiation emitted by cesium-137 decay products. If very high doses are received, skin burns can result. Gamma photons emitted from the barium decay product, barium-137m, can pass through the human body, delivering radiation exposure to internal tissue and organs. People may also be exposed internally if they swallow or inhale cesium-137.

Large amounts of cesium-137 were produced during atmospheric nuclear weapons tests conducted in the 1950s and 1960s. As a result of atmospheric testing and radioactive fallout, this cesium was dispersed and deposited worldwide.

Sources of exposure from cesium-137 include fallout from previous nuclear weapons testing, soils and waste materials at radioactively contaminated sites, radioactive waste associated with operation of nuclear reactors, spent fuel reprocessing plants, and nuclear accidents such as Chernobyl and Fukushima. Cesium-137 is also a component of low-level radioactive waste at hospitals, radioactive source manufacturing, and research facilities.

How does cesium-137 get into the body?

Cesium-137 can enter the body when it is inhaled, ingested, or absorbed through the skin. After radioactive cesium is ingested, it is

distributed fairly uniformly throughout the body's soft tissues. Slightly higher concentrations are found in muscle; slightly lower concentrations are found in bone and fat. Cesium-137 remains in the body for a relatively short time. It is eliminated more rapidly by infants and children than by adults.

Is there a medical test to determine exposure to cesium-137?

Generally, levels of cesium in the body are inferred from measurements of urine samples using direct gamma spectrometry. Because of the presence of the gamma-emitting barium daughter product, a technique called whole-body counting may also be used; this test relies on detection of gamma photon energy. Skin contamination can be measured directly using a variety of portable instruments. Other techniques that may be used include taking blood or fecal samples, then measuring the level of cesium.

How can cesium-137 affect people's health?

Based on experimentation with ionizing radiation and human epidemiology, exposure to radiation from cesium-137 can cause cancer. Great Britain's National Radiological Protection Board (NRPB) predicts that there will be up to 1,000 additional cancers over the next 70 years among the population in Western Europe exposed to fallout from the accident at Chernobyl.

The magnitude of the health risk would depend on exposure conditions for scenarios involving nuclear accidents or waste materials, such as:

- Types of radioactivity encountered,
- Nature of exposure, and
- Length of exposure.

What recommendations has the U.S. Environmental Protection Agency made to protect human health?

Please note that the information in this section is limited to recommendations EPA has made to protect human health from exposure to cesium-137. General recommendations EPA has made to protect human health at Superfund sites (the 10^{-4} to 10^{-6} cancer risk range), which cover all radionuclides including cesium-137, are summarized in the fact sheet "Primer on Radionuclides Commonly Found at Superfund Sites."

EPA has established a Maximum Contaminant Level (MCL) of 4 millirems per year for beta particle and photon radioactivity from man-made radionuclides in drinking water. Cesium-137 would be covered under this MCL. The average concentration of cesium-137, which is assumed to yield 4 millirems per year, is 200 picocuries per liter (pCi/L). If other radionuclides that emit beta particles and photon radioactivity are present in addition to cesium-137, the sum of the annual dose from all the radionuclides cannot exceed 4 millirems/year.

For more information about how EPA addresses cesium-137 at Superfund sites
Contact Stuart Walker of EPA:
[703] 603-8748 or walker.stuart@epa.gov,
or visit EPA's Superfund Radiation Webpage:
<http://www.epa.gov/superfund/resources/radiation/>

Show Video

- ◆ Quick primer of material we have covered





Radiation Risk Assessment Calculator Training

Section 3 -- PRG Calculator



United States
Environmental Protection
Agency

Superfund Radiation Risk
Assessment Calculator Training

PRG Outline

- PRGs Background
- Development Approach in CERCLA
- Calculator Walkthrough
 - Scenarios
 - Inputs
 - Outputs

About PRG Calculator

“The Radionuclide PRG calculator is part of a continuing effort by EPA’s Office of Superfund Remediation and Technology Innovation (OSRTI) to provide updated guidance for addressing radioactively contaminated sites consistent with EPA’s guidance for addressing chemically contaminated sites, except to account for the technical differences between radionuclides and chemicals.”

PRGs Background

- Preliminary Remediation Goals for radionuclides
- Two general sources
 - Concentrations based on ARARs. Often the determining factors in establishing cleanup levels at CERCLA sites.
 - Risk-based, site-specific concentrations, derived from equations combining standardized exposure assumptions with EPA toxicity data.
 - Use standard equations when ARARs are not available or are not sufficiency protective.



Site-specific Data

- PRGs can be calculated generically (w/out site-specific info).
- Then can be recalculated using site-specific data.
- Generic PRGs considered to be protective for humans, incl. the most sensitive groups.

Use in Site Assessment

- PRGs are not de-facto cleanup standards and should not be applied as such.
- Use for **site-screening** and as **initial cleanup goals** when applicable.
 - Role in site-screening: help identify areas, contaminants, and conditions that do not require further attention.
 - Initial cleanup goals provide long-term targets to use during analysis of remedial alternatives.

Use in Site Assessment (cont.)

- At site where contaminant conc. fall below PRGs, no further action or study is warranted.
- Conc. above PRGs do not automatically trigger a “dirty” designation or response action.
- Specific for individual chemicals for specific medium and land use combinations at sites.

Carcinogenicity

- PRGs calculated for risk-based carcinogenicity of the analytes.
- Uranium is the only radionuclide for which chemical toxicity is comparable or greater than the radiotoxicity.
 - An RfD has been established for chemical kidney toxicity.
 - Use EPA Superfund RSL calculator to develop uranium PRG based on HI, use PRG calculators for 10^{-6} cancer risk PRG.

Expression

- Quantities expressed in units of activity (e.g. pCi) and units of mass (e.g. mg).
 - Typically units of activity are used to quantify the concentration of radioactive material in soil because carcinogenic risks of exposure in rad soils are more related to the decay rate than to its mass.
 - Mass is provided to help evaluate the efficacy of remediation technologies
- Do not address non-human health endpoints such as ecological impacts.



PRG Calculator

- The PRG calculator establishes PRG concentrations for each radionuclide, as if it were the only radionuclide present.
- Cancer risk from all radiological and non-radiological contaminants should be summed to provide risk estimates to people exposed to both types of carcinogenic contaminants.

CERCLA Risk and Dose Calculators

Human Health - Radiological

Cancer risk (1×10^{-6})

- ◆ PRG (soil, water and air) 2002
- ◆ BPRG (inside buildings) 2007
- ◆ SPRG (outside surfaces) 2009

Dose (millirem per year)

- ◆ DCC (soil, water and air) 2004
- ◆ BDCC (inside buildings) 2010
- ◆ SDCC (outside surfaces) 2010

Human Health - Chemical

- ◆ RSL (soil, water, and air) 2008

Developmental Approach

- Identify PRGs at scoping.
- Create conceptual site model
- Modify PRGs as needed at end of RI or during FS based on site-specific info from baseline risk assessment.
- Select remediation levels in ROD.

Development Approach – Conceptual Site Model

- Exposure pathways of concern and site conditions must match screening level assumptions.
- Developing CSM is necessary to identify:
 - Likely contaminant source areas
 - Exposure pathways
 - Potential receptors

Development Approach – Conceptual Site Model (cont.)

- Info from CSM can also be used to determine or assist with:
 - Applicability of screening levels at site
 - Prioritizing multiple sites within a facility or exposure units
 - Setting dose-based detection limits for contaminants of potential concern (COPCs)
 - Focusing future dose assessment efforts

Development Approach – Conceptual Site Model (cont.)

- Final CSM represents linkages among:
 - Contaminant sources
 - Release mechanisms
 - Exposure pathways
 - Routes and receptors
- CSM should address following questions:
 - Are there potential ecological concerns?
 - Is there potential for land use other than those covered by PRG levels?
 - Are there other likely human exposure pathways that were not considered in development of PRG levels?
 - Are there unusual site conditions?

Example Conceptual Site Model – Overview of Contaminant Migration

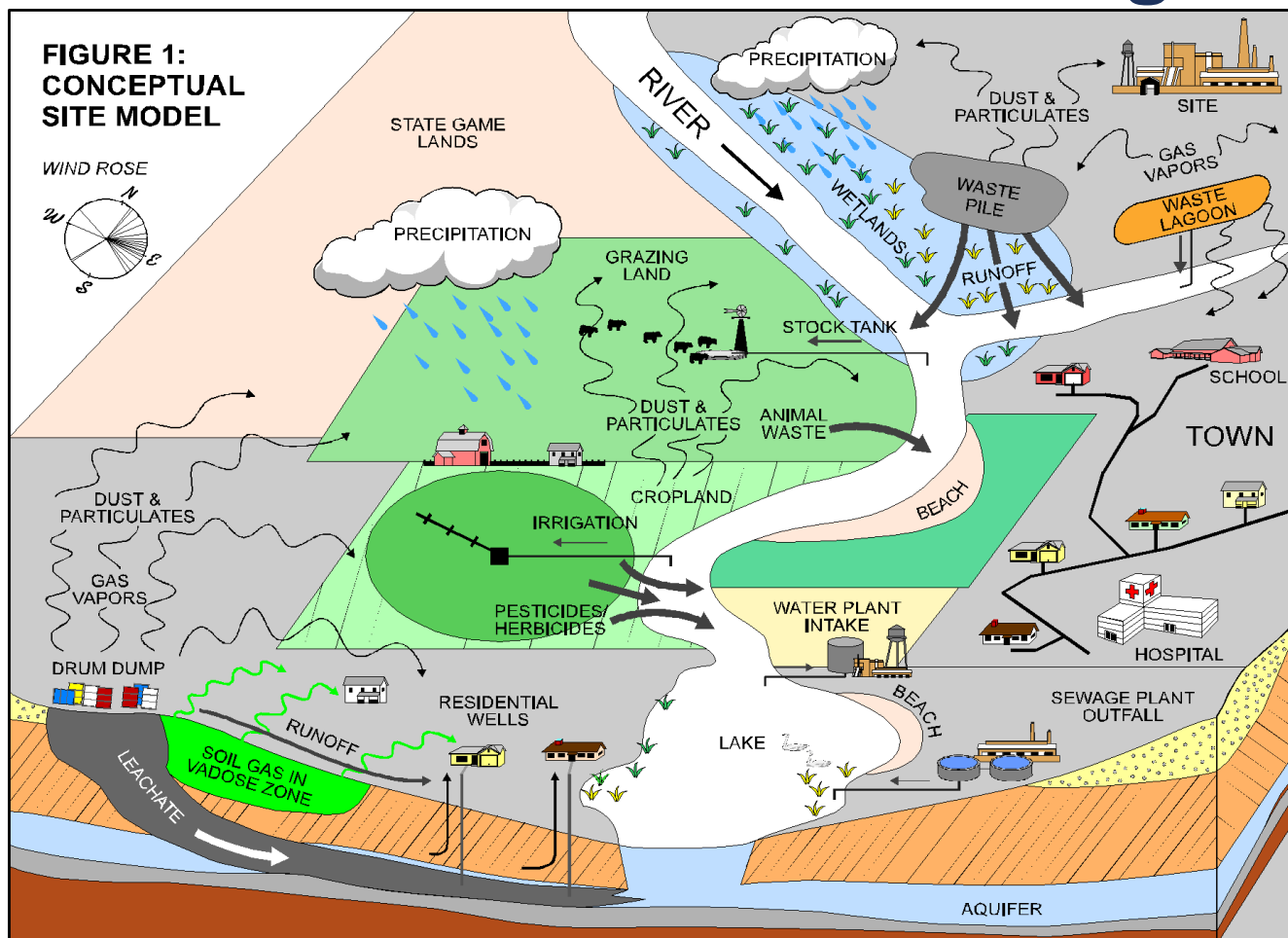

Example Conceptual Site Model for PRG and DCC

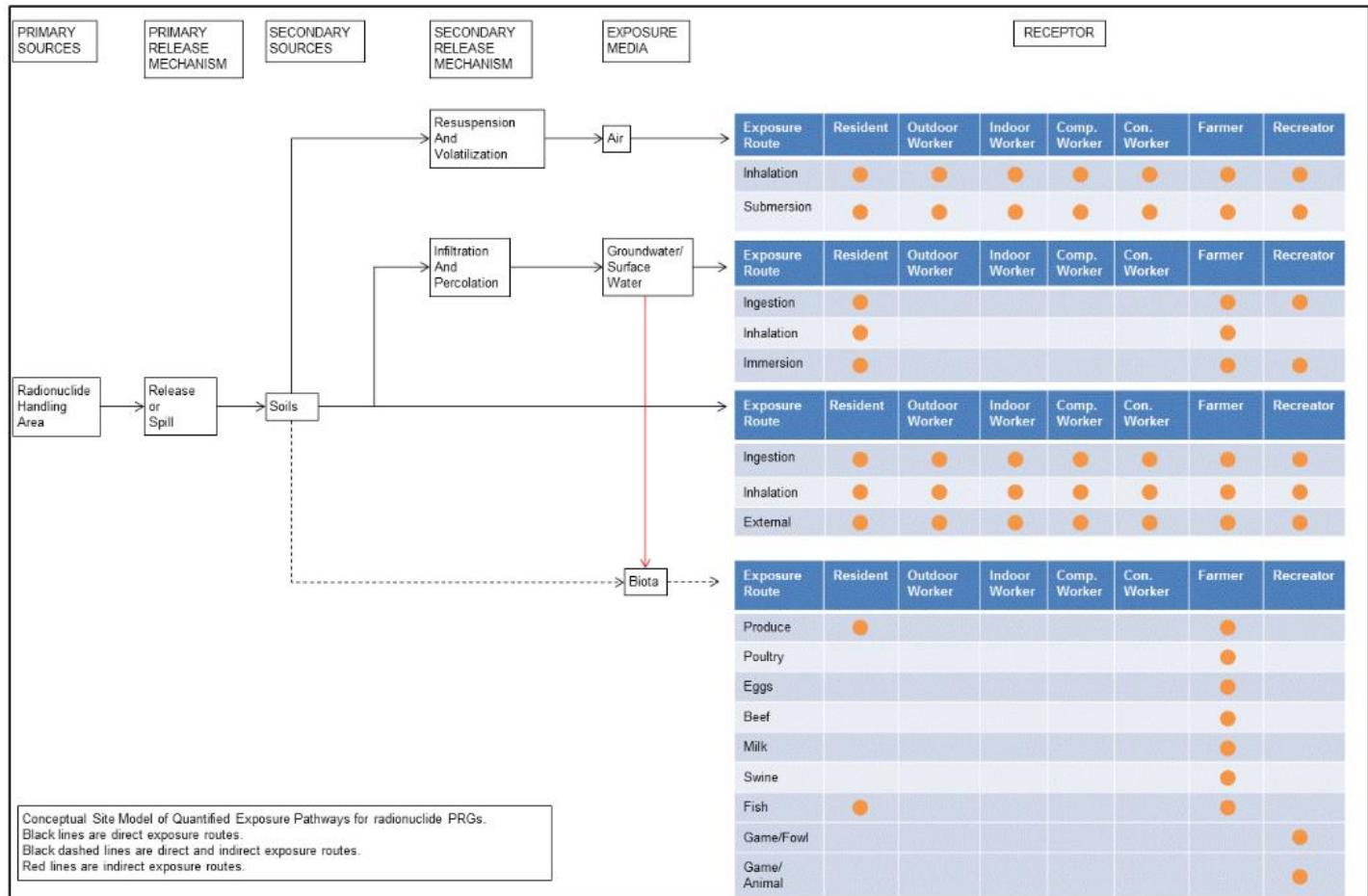

Calculator Walkthrough

- Overview
 - Select scenario
 - Select PRG type
 - Select units
 - Select isotopes of interest
- Scenarios
- Site-specific considerations

PRG Calculator Overview

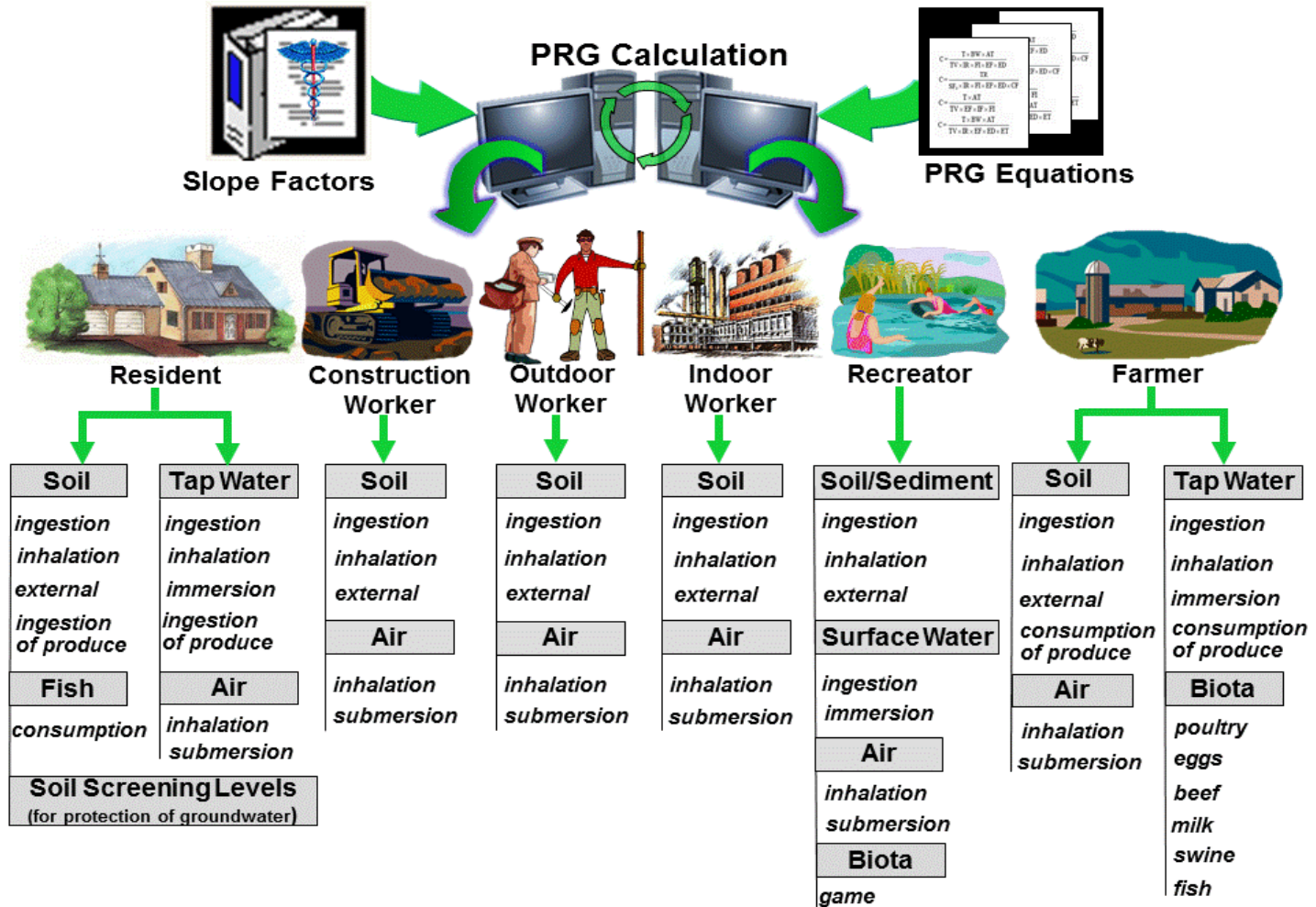

PRG Calculator Inputs

Using the PRG Calculator

Select Scenario

- Resident
- Composite Worker
- Outdoor Worker
- Indoor Worker
- Construction Worker - Standard Unpaved Road Vehicle Traffic (Site-specific only)
- Construction Worker - Wind Erosion and Other Construction Activities (Site-specific only)
- Recreator (Site-specific only)
- Farmer
- Soil to Groundwater

Select Media:

- Soil
- Air
- 2-D External Exposure
- Tap Water
- Fish

Select PRG type

- Defaults
- Site-specific

Select Risk Output:

- No
- Yes

Select Units

- pCi
- Bq

Select Individual Isotopes

Complete List

- Te-127m
- Te-129
- Te-129m
- Te-131
- Te-131m
- Te-132
- Te-133
- Te-133m
- Te-134
- Test Isotope

Common Isotopes

- Am-241
- Co-60
- Cs-137+D
- H-3
- I-129
- I-131
- Pu-240
- Ra-226+D
- Ra-228+D
- Rn-220

Selected

- AC-225+D
- AC-226
- Pu-238
- Pu-239+D



Or Select All

ALL

Retrieve

Select scenario

- Exposure scenario affects allowed toxicity levels based on length, frequency, and intensity of exposure.
- Scenarios
 - Resident
 - Composite worker
 - Outdoor worker
 - Indoor worker
 - Construction Worker - Standard Unpaved Road Vehicle Traffic (Site-specific only)
 - Construction Worker - Wind Erosion and Other Construction Activities (Site-specific only)
 - Recreator (Site-specific only)
 - Farmer
 - Soil to Groundwater

Select PRG Type, Units, Isotopes

- Use default site parameters
- Enter site-specific parameters
 - Select chemical info type: database hierarchy defaults or user-provided.
- Select units of activity: pCi/g or Bq/g
- Select isotopes of interest

Calculator Site-Specific Inputs

Resident Exposure to Air

Inhalation and External Exposure

Air Inhalation

$$PRG_{res-air-inh-decay} \left(pCi/m^3 \right) = \frac{TR \times t_r \left(yr \right) \times \lambda \left(\frac{1}{yr} \right)}{\left(1 - e^{-\lambda t_r} \right) \times SF_i \left(\frac{risk}{pCi} \right) \times IFA_{r-adj} \left(161,000 m^3 \right)}$$

where:

$$IFA_{r-adj} \left(161,000 m^3 \right) = \left(EF_{r-c} \left(\frac{350 \text{ day}}{yr} \right) \times ED_{r-c} \left(6 \text{ yr} \right) \times ET_{r-c} \left(\frac{24 \text{ hr}}{\text{day}} \right) \times \left(\frac{1 \text{ day}}{24 \text{ hours}} \right) \times IRA_{r-c} \left(\frac{10 m^3}{\text{day}} \right) \right) + \left(EF_{r-a} \left(\frac{350 \text{ day}}{yr} \right) \times ED_{r-a} \left(20 \text{ yr} \right) \times ET_{r-a} \left(\frac{24 \text{ hr}}{\text{day}} \right) \times \left(\frac{1 \text{ day}}{24 \text{ hours}} \right) \times IRA_{r-a} \left(\frac{20 m^3}{\text{day}} \right) \right)$$

Air Inhalation (without decay)

Air Submersion

Air Submersion (without decay)

Air Total

Air Total (without decay)

Click
exposure
pathways
for
equations.



United States
Environmental Protection
Agency

Superfund Radiation Risk
Assessment Calculator Training

Calculator Site-Specific Inputs

<input type="text" value="26"/>	ED_r (exposure duration - resident) yr	<input type="text" value="24"/>	ET_{r-c} (exposure time - resident child) hr
<input type="text" value="20"/>	ED_{r-a} (exposure duration - resident adult) yr	<input type="text" value="1.0"/>	GSF_a (gamma shielding factor - air) unitless
<input type="text" value="6"/>	ED_{r-c} (exposure duration - resident child) yr	<input type="text" value="161000"/>	IFA_{r-adj} (age-adjusted inhalation factor) m^3
<input type="text" value="350"/>	EF_r (exposure frequency) day/yr	<input type="text" value="20"/>	IRA_{r-a} (inhalation rate - resident adult) m^3/day
<input type="text" value="350"/>	EF_{r-a} (exposure frequency - resident adult) day/yr	<input type="text" value="10"/>	IRA_{r-c} (inhalation rate - resident child) m^3/day
<input type="text" value="350"/>	EF_{r-c} (exposure frequency - resident child) day/yr	<input type="text" value="26"/>	t_r (time - resident) yr
<input type="text" value="24"/>	ET_r (exposure time - resident) hr	<input type="text" value="1.0E-6"/>	TR (target cancer risk) unitless
<input type="text" value="24"/>	ET_{r-a} (exposure time - resident adult) hr		

- Blue fields are not user-changeable.
- Values determined by other inputs.
 - Ex: IRA_{r-adj} depends on IRA_{r-a} , IRA_{r-c} , ED_{r-a} , and ED_{r-c}

Residential Scenario

- The resident spends most, if not all, of the day at home except for the hours spent at work.
- The activities for this receptor involve typical homemaking chores (cooking, cleaning, and laundering) as well as gardening.
- Adults and children exhibit different ingestion rates for soil and produce. The equations account for age adjustment.
 - For example, the child resident is assumed to ingest 200 mg per day while the adult ingests 100 mg per day.

Residential Exposure Pathways

- Ambient air
- Tap water
- Soil
- 2D direct external exposure
- Soil to groundwater
- Fish



United States
Environmental Protection
Agency

Superfund Radiation Risk
Assessment Calculator Training

Resident Common Parameters

- ◆ These are used in most resident equations. Changes here get carried to other areas.

Parameters Common to all Exposure Route Equations	
<input type="text" value="26"/> ED_r (exposure duration - resident) yr	<input type="text" value="24"/> ET_r (exposure time - resident) hr
<input type="text" value="20"/> ED_{r-a} (exposure duration - resident adult) yr	<input type="text" value="24"/> ET_{r-a} (exposure time - resident adult) hr
<input type="text" value="6"/> ED_{r-c} (exposure duration - resident child) yr	<input type="text" value="24"/> ET_{r-c} (exposure time - resident child) hr
<input type="text" value="350"/> EF_r (exposure frequency - resident) day/yr	<input type="text" value="26"/> t_r (time - resident) yr
<input type="text" value="350"/> EF_{r-a} (exposure frequency - resident adult) day/yr	<input type="text" value="1.0E-6"/> TR (target cancer risk) unitless
<input type="text" value="350"/> EF_{r-c} (exposure frequency - resident child) day/yr	

Residential Ambient Air

- Two sets of equations
 - With half-life decay function – contaminants in air **are not being replenished** (e.g. contaminated settled dust from a previous release that is being resuspended)
 - Without half-life decay function – contaminants in air have a continual source (e.g. indoor radon from radium in the soil)
- Exposure routes: inhalation, external exposure to ionizing radiation



Residential Ambient Air SS Inputs Inhalation and External Exposure

61 ED_r (exposure duration - resident) yr

55 ED_{r-a} (exposure duration - resident adult) yr

6 ED_{r-c} (exposure duration - resident child) yr

350 EF_r (exposure frequency) day/yr

350 EF_{r-a} (exposure frequency - resident adult) day/yr

350 EF_{r-c} (exposure frequency - resident child) day/yr

24 ET_r (exposure time - resident) hr

24 ET_{r-a} (exposure time - resident adult) hr

24 ET_{r-c} (exposure time - resident child) hr

1.0 GSF_a (gamma shielding factor - air) unitless

406000 IFA_{r-adj} (age-adjusted inhalation factor) m^3

20 IRA_{r-a} (inhalation rate - resident adult) m^3/day

10 IRA_{r-c} (inhalation rate - resident child) m^3/day

61 t_r (time - resident) yr

1.0E-6 TR (target cancer risk) unitless

NOTES:

1. SF_i =inhalation slope factor (risk/pCi).
2. SF_{sub} =submersion slope factor (risk/pCi)
3. $t_r = ED_r = ED_{r-c} + ED_{r-a}$
4. λ =decay constant

Residential Tapwater

- Resident is exposed to radionuclides in tapwater delivered into the home.
- Exposure routes:
 - Ingestion
 - External Exposure - Immersion
 - Inhalation of volatiles
 - Only for radionuclides that volatilize: C-14, H-3, Ra-224, Ra-226, Ra-226+D
 - From household water uses: showering, laundering, dishwashing, etc.
 - Consumption of fruits and vegetables grown on contaminated soil

Residential Tapwater

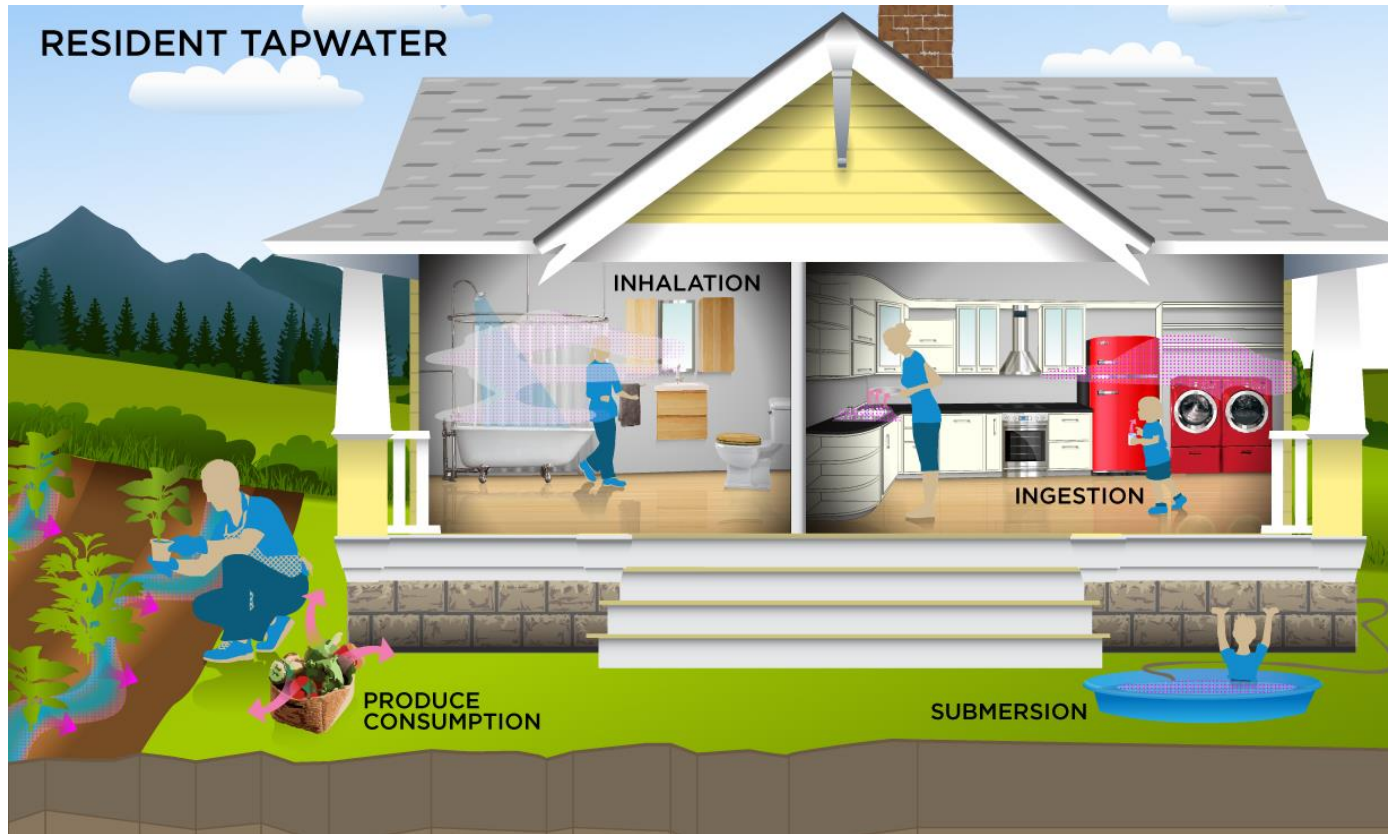

United States
Environmental Protection
Agency

Superfund Radiation Risk
Assessment Calculator Training

Residential Tapwater SS Inputs Ingestion and Inhalation Exposure

DFA_{r-adj} (age-adjusted immersion factor - resident) hr

ED_r (exposure duration - resident) yr

ED_{r-a} (exposure duration - resident adult) yr

ED_{r-c} (exposure duration - resident child) yr

EF_{r-a} (exposure frequency - resident adult) day/yr

EF_{r-c} (exposure frequency - resident child) day/yr

ET_{r-a} (exposure time - resident adult) hr

ET_{r-c} (exposure time - resident child) hr

EV_{r-a} (bathing events per day - resident adult) event/day

I_r (irrigation rate) L/m^2 -day

IRW_{r-a} (water intake rate - resident adult) L/day

IRW_{r-c} (water intake rate - resident child) L/day

K (volatilization factor of Andelman) L/m^3

λ_{HL} (soil leaching rate) 1/day

MLF (produce plant mass loading factor) unitless

P (area density for root zone) kg/m^2

T (translocation factor) unitless

$t_{a-event}$ (duration of bathing event - adult) hr/event

t_b (long term deposition and buildup) day

Residential Tapwater SS Inputs Ingestion and Inhalation Exposure (cont.)

EV_{r-c} (bathing events per day - resident child)
event/day

F (irrigation period) unitless

IFA_{r-adj} (age-adjusted inhalation factor - resident)
 m^3

I_f (interception fraction) unitless

IFW_{r-adj} (adjusted intake factor - resident) L-
yr/kg-day

IRA_{r-a} (inhalation rate - resident adult) m^3 /day

IRA_{r-c} (inhalation rate - resident child) m^3 /day

$t_{c-event}$ (duration of bathing event - child) hr/event

TR (target cancer risk) unitless

t_v (above ground exposure time) day

t_w (weathering half-life) day

Y_v (plant yield - wet) kg/m^2

NOTES:

1. SF_o =oral ingestion slope factor (risk/pCi).
2. SF_f =food ingestion slope factor (risk/pCi).
3. SF_i =inhalation slope factor (risk/pCi).
4. SF_{imm} =immersion external exposure slope factor (risk-g/pCi-yr).
5. $t_r = ED_r = ED_{r-c} + ED_{r-a}$

Residential Soil

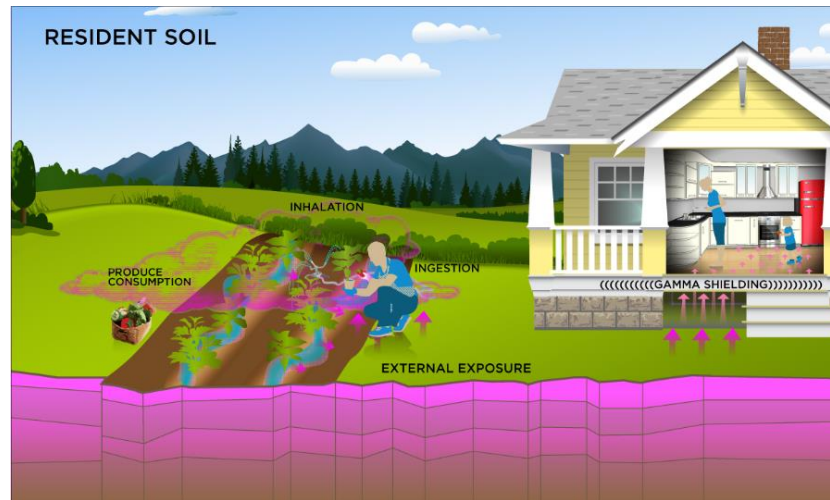

- Exposure routes:
 - Incidental ingestion of soil
 - Inhalation of particles emitted from soil (wind-blown dust)
 - External exposure to ionizing radiation
 - Consumption of fruits and vegetables grown on contaminated soil

Residential Soil SS Inputs

Ingestion, External, Inhalation and Produce

Select a slab size ▾ Slab size for ACF

Select a soil thickness cover layer ▾ Select cover layer thickness for GSF_o (gamma shielding factor - outdoor)

26 ED_r (exposure duration - resident) yr

20 ED_{r-a} (exposure duration - resident adult) yr

6 ED_{r-c} (exposure duration - resident child) yr

350 EF_r (exposure frequency - resident) day/yr

350 EF_{r-a} (exposure frequency - resident adult) day/yr

350 EF_{r-c} (exposure frequency - resident child) day/yr

24 ET_{r-a} (exposure time - resident adult) hr/day

24 ET_{r-c} (exposure time - resident child) hr/day

16.416 ET_{r-i} (exposure time - indoor resident) hr/day

1.752 ET_{r-o} (exposure time - outdoor resident) hr/day

0.4 GSF_i (gamma shielding factor - indoor) unitless

161000 IFA_{r-adj} (age-adjusted soil inhalation factor - resident) m^3

1120000 IFS_{r-adj} (age-adjusted soil ingestion factor - resident) mg

20 IRA_{r-a} (inhalation rate - resident adult) m^3/day

10 IRA_{r-c} (inhalation rate - resident child) m^3/day

100 IRS_{r-a} (soil intake rate - resident adult) mg/day

200 IRS_{r-c} (soil intake rate - resident child) mg/day

0.26 MLF (produce plant mass loading factor) unitless

26 t_r (time - resident) yr

1.0E-6 TR (target cancer risk) unitless

NOTES:

1. SF_o =oral ingestion dose conversion factor (mrem/pCi).
2. SF_i =inhalation slope factor (risk/pCi).
3. SF_{ext-sv} =external exposure slope factor (risk-g/pCi-yr).
4. $t_r = ED_r = ED_{r-c} + ED_{r-a}$
5. λ =decay constant
6. Q/C_{wind} =calculations based on site size and climactic zone. Further details on the derivation of Q/C_{wind} can be found in [Appendix D](#)
7. A, B, C = PEF region-specific dispersion constants (unitless)

Residential Soil SS Inputs

Ingestion, External, Inhalation and Produce Exposure (cont.)

Produce Ingestion Parameters

Produce Consumption - direct

CPF_r (contaminated plant fraction) unitless

IFF_{r-adj} (age-adjusted fruit ingestion factor - resident) g

IFV_{r-adj} (age-adjusted vegetable ingestion factor - resident) g

IRF_{r-a} (fruit consumption rate - resident adult) g/day

IRF_{r-c} (fruit consumption rate - resident child) g/day

IRV_{r-a} (vegetable consumption rate - resident adult) g/day

IRV_{r-c} (vegetable consumption rate - resident child) g/day

Residential Soil SS Inputs Particulate Emission Factor

Particulate Emission Factor	
Particulate Emission Factor	
Default	City (Climatic Zone) - Selection based on most likely climatic conditions for the site
0.5	A_s (acres)
1359344438	PEF (particulate emission factor) m^3/kg
93.77	Q/C_{wp} / inverse of the ratio of the geometric mean air concentration to the emission flux at center of a square source ($g/m^2 \cdot s$ per kg/m^3) PEF Selection
16.2302	A (Dispersion Constant)
18.7762	B (Dispersion Constant)
216.108	C (Dispersion Constant)
0.194	$F(x)$ / function dependant on U_m/U_t derived using Cowherd et al. (1985) (unitless)
0.5	V / fraction of vegetative cover (unitless)
4.69	U_m / mean annual wind speed (m/s)
11.32	U_t / equivalent threshold value (m/s)

Res 2D Direct External Exposure

- Alternate equations for external exposure solely for ionizing radiation of radionuclides in soil (no ing or inh).
- Designed to look at external exposure contamination from different area sizes.
- Area sizes considered (m²):
 - 1
 - 2
 - 5
 - 10
 - 20
 - 50
 - 100
 - 200
 - 500
 - 1000
 - 2000
 - 5000
 - 10,000
 - 20,000
 - 50,000



Res 2D Direct External Exposure Scenarios

- Infinite soil depth – “3D” model
- 1 cm soil depth
- 5 cm soil depth
- 15 cm soil depth
 - Soil depth models based on mass (pCi/g)
- Contaminant dust on ground plane.
 - Based on area, expressed in pCi/cm².



Buried Waste

- ◆ Revised PRG and DCC added option for buried waste. Depth-specific gamma shielding factors ($GSF_{0,s}$) are now given for:
 - Various slope and dose conversion factors (ground plane, 1 cm, 5 cm, 15 cm and infinite depth) and various soil cover depths
 - Does not account for radionuclide transport (e.g., radon through the cap, radionuclide leaching to groundwater)
 - Assumes cover does not degrade
 - Covers of 0, 10, 20, 30, 40, 50, 60, 70, 80, 90 and 100 cm available.

Buried Waste (cont.)

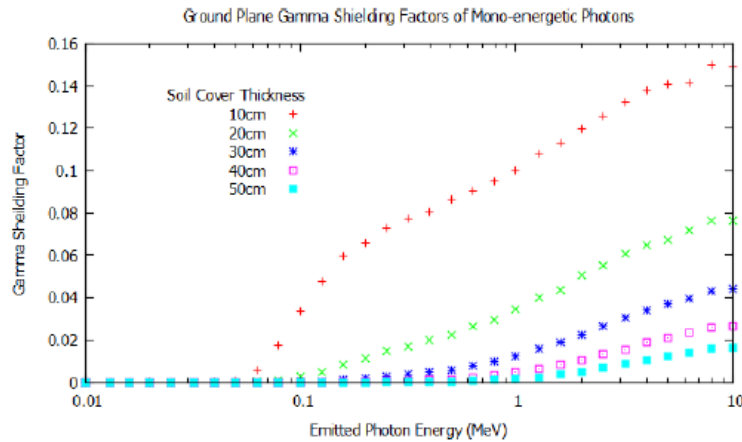

Figure 2: Ground Plane GSF of Mono-energetic Photons with Cover Thickness 10cm through 50cm

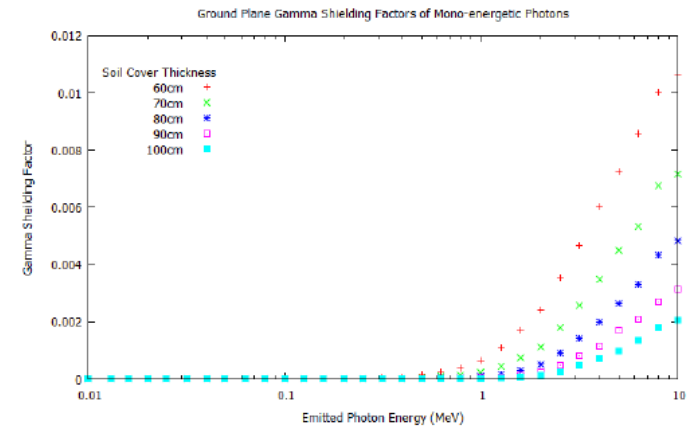

Figure 3: Ground Plane GSF of Mono-energetic Photons with Cover Thickness 60cm through 100cm

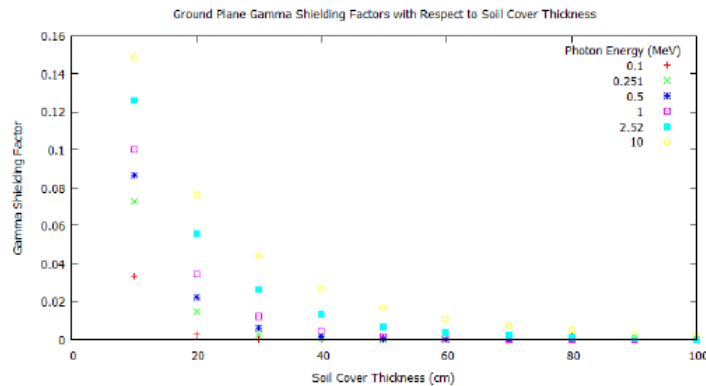

Figure 4: Ground Plane GSF of Mono-energetic Photons versus Cover Thickness at Various Energies

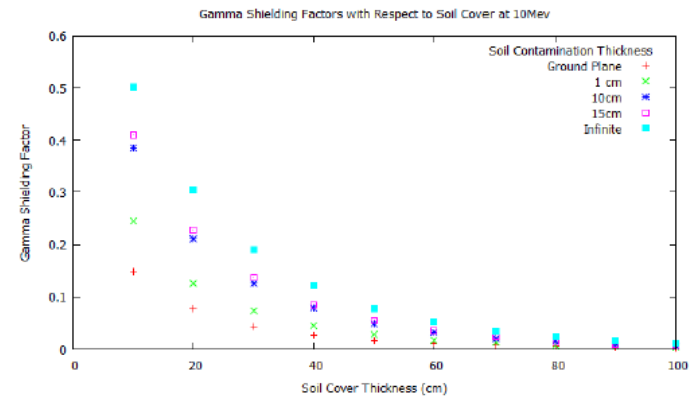

Figure 5: GSF at 10 MeV using Various Contamination Thicknesses with Respect to Soil Cover Depth

Residential 2D SS Inputs

Resident Exposure to Alternate External Sources

ED_r (exposure duration - resident) yr

EF_r (exposure frequency - resident) day/yr

ET_{r-i} (exposure time - indoor resident) hr/day

ET_{r-o} (exposure time - outdoor resident) hr/day

GSF_i (gamma shielding factor - indoor) unitless

t_r (time - resident) yr

TR (target cancer risk) unitless

NOTES:

1. Slab size for ACF in alternate external exposure equations is determined by area selected in soil section above
2. Soil thickness for GSF_o in alternate external exposure equations is determined by area selected in soil section above
3. SF_{ext-gp} =ground plane external exposure slope factor (mrem-cm²/pCi-yr).
4. SF_{ext-sv} =infinite soil volume external exposure slope factor (mrem-g/pCi-yr).
5. $SF_{ext-1cm}$ =soil volume at 1 cm external exposure slope factor (mrem-g/pCi-yr).
6. $SF_{ext-5cm}$ =soil volume at 5 cm external exposure slope factor (mrem-g/pCi-yr).
7. $SF_{ext-15cm}$ =soil volume at 15 cm external exposure slope factor (mrem-g/pCi-yr).
8. λ =decay constant
9. $ED_r = t_r$



United States
Environmental Protection
Agency

Superfund Radiation Risk
Assessment Calculator Training

Residential Soil to Groundwater

- Identifies concentrations in soil that have the potential to contaminate groundwater above risk-based concentrations (RBCs) such as PRGs or MCLs.
- Migration of contaminants from soil to groundwater can be envisioned as a two-stage process. Scenario considers both of these fate and transport mechanisms.
 - Release of contaminant from soil to soil leachate.
 - Transport of the contaminant through the underlying soil and aquifer to a receptor well.

Residential Soil to Groundwater

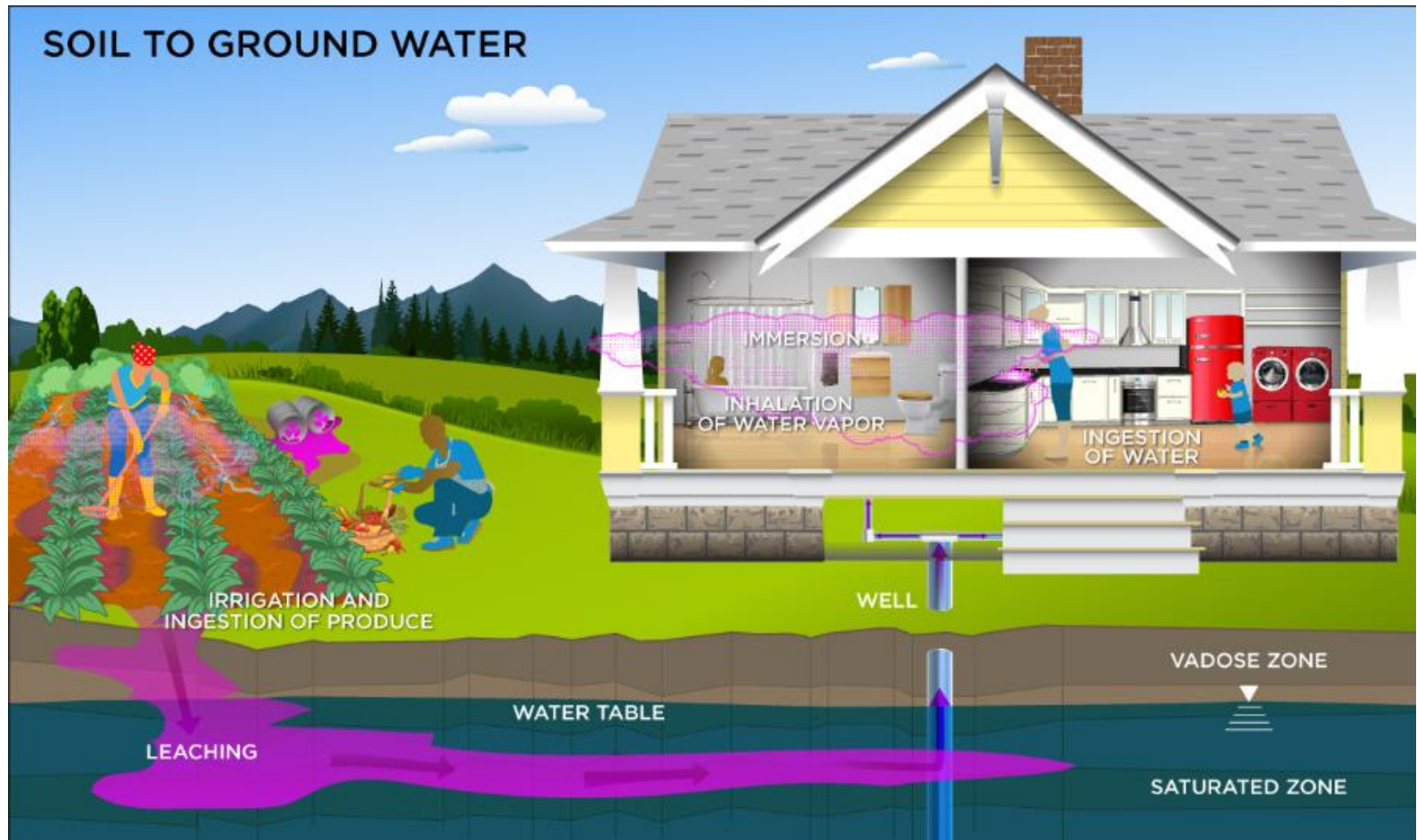

Res Soil to GW – Soil Screening Levels

- SSLs accommodate partitioning between soil and water using Kds per guidance.
- Designed for use during early states of site evaluation when info about subsurface conditions is limited.
- Based on conservative, simplifying assumptions about release and transport of contaminants in subsurface.
- Other models from SSG, rad SSG 2000 and TBD Part 3 are available.

Steps to Calculate SSLs

- Acceptable groundwater concentration is multiplied by a dilution factor to obtain a target leachate concentration.
- Partition equation is then used to calculate the total soil concentration corresponding to this soil leachate concentration.

Residential Soil to Groundwater SS Inputs – Dilution Factor for Migration to Groundwater

Dilution Factor for Migration to Groundwater	
<u>Dilution Attenuation Factor</u>	$DAF = 1 + \frac{\left(K \left(\frac{m}{yr} \right) \times i \left(\frac{m}{m} \right) \times d(m) \right)}{\left(i \left(\frac{m}{yr} \right) \times L(m) \right)}$
<u>Mixing Zone Depth</u>	$d(m) = \left(0.0112 \times L(m)^2 \right)^{0.5} + d_a(m) \times \left\{ 1 - e^{\left[\frac{-L(m) \times i \left(\frac{m}{yr} \right)}{K \left(\frac{m}{yr} \right) \times i \left(\frac{m}{m} \right) \times d_a(m)} \right]} \right\}$
<input type="text" value="1"/> DAF (dilution attenuation factor) unitless	<input type="text" value="."/> d_a (aquifer thickness) m - site-specific
<input type="text" value="."/> K (aquifer hydraulic conductivity) m/yr	<input type="text" value="."/> i (hydraulic gradient) m/m
<input type="text" value="."/> L (source length parallel to ground water flow) m	<input type="text" value="0.18"/> I (infiltration rate) m/yr
<input type="text" value="."/> d (mixing zone depth) m - site-specific	
<p>NOTES:</p> <ol style="list-style-type: none"> The dilution factor (DAF) has a default of 1 for a <= 0.5-acre source. If DAF is known, enter it above. Or, to calculate DAF, enter your own site-specific values for the variables in the necessary fields above. When DAF is entered or calculated, the values for the blue DAF boxes in the Migration to Groundwater sections below will be populated. If DAF is not entered or calculated, the default value of 1 will be used. 	

Residential Soil to Groundwater SS Inputs – Partitioning Equation for Migration to Groundwater

Partitioning Equation for Migration to Groundwater

Method 1

$$SSL \left(\frac{pCi}{g} \right) = C_w \left(\frac{pCi}{L} \right) \times 10^{-3} \left(\frac{kg}{g} \right) \times \left(K_d \left(\frac{L}{kg} \right) + \frac{\theta_w \left(\frac{L_{water}}{L_{soil}} \right)}{\rho_b \left(\frac{kg}{L} \right)} \right) \times \frac{t \times \lambda}{(1 - e^{-\lambda t})}$$

where:

$$C_w = MCL \text{ or } PRG \times DAF$$

DAF (dilution attenuation factor) unitless

t (time) yr

ρ_b (dry soil bulk density) kg/L

θ_w (water-filled soil porosity) L_{water}/L_{soil}

NOTES:

1. The Partitioning Equation for Migration to Ground Water is used by default. To use the [Mass-Limit Equation](#), enter values for the required parameters in the section below.
2. The dilution factor (DAF) has a default of 1 for a ≤ 0.5 -acre source.
3. If DAF is known, enter it in the [Dilution Factor](#) section above. When DAF is entered or calculated in the section above, the value for the blue DAF box in this section will be populated. If DAF is not entered or calculated, the default value of 1 will be used.

Residential Soil to Groundwater SS Inputs – Mass-Limit Equation for Migration to Groundwater

Mass-Limit Equation for Migration to Groundwater

Method 2

$$SSL \left(\frac{pCi}{g} \right) = \frac{C_w \left(\frac{pCi}{L} \right) \times I \left(\frac{m}{yr} \right) \times ED_{gw} (70 \text{ yr}) \times 10^{-3} \left(\frac{kg}{g} \right) \times t \times \lambda}{\rho_b \left(\frac{kg}{L} \right) \times d_s (m) \times (1 - e^{-\lambda t})}$$

where:

$$C_w = MCL \text{ or } PRG \times DAF$$

DAF (dilution attenuation factor) unitless

ED_{gw} (exposure duration) yr

d_s (depth of source) m - site-specific

ρ_b (dry soil bulk density) kg/L

NOTES:

1. The [Partitioning Equation](#) for Migration to Groundwater above is used by default. To use the Mass-Limit Equation, enter values for ED, d_s, and P_b in this section and enter a value for I in the [Dilution Factor](#) section above.
2. The dilution factor (DAF) has a default of 1 for a <= 0.5-acre source.
3. If DAF is known, enter it in the [Dilution Factor](#) section above. When DAF is entered or calculated in the section above, the value for the blue DAF box in this section will be populated. If DAF is not entered or calculated, the default value of 1 will be used.

Residential Fish



- Radionuclide concentration in fish tissue consumed.
- Consumption rate for fish is not age-adjusted like the farmer scenario is.



Residential Fish SS Inputs

Resident Exposure to Consumption of Fish

Ingestion Exposure

Fish Ingestion

$$PRG_{\text{res-fsh-ing}} (\text{pCi/g}) = \frac{TR}{SF_{\text{fsh}} \left(\frac{\text{risk}}{\text{pCi}} \right) \times EF_r \left(\frac{350 \text{ day}}{\text{yr}} \right) \times ED_r (26 \text{ yr}) \times IRF_a \left(\frac{54 \text{ g}}{\text{day}} \right) \times CF_{\text{fish}} (1)}$$

26 ED_r (exposure duration - resident) yr

350 EF_r (exposure frequency - resident) day/yr

54 IRF_a (fish intake rate - adult) g/day

26 t_r (time - resident) yr

1.0E-6 TR (target cancer risk) unitless

NOTES:

1. SF_o = food dose conversion factor (mrem/pCi). rad-specific

Composite Worker Scenario

- Combines the most protective exposure assumptions of the outdoor and indoor workers.
- Only difference from outdoor worker is that composite worker uses the more-protective exposure frequency of 250 days/year from the indoor worker scenario.

Composite Worker Scenario



Composite Worker Scenario



Outdoor Worker Scenario

- Long-term receptor exposed during the work day who is a full-time employee working on-site and who spends most of the workday conducting maintenance activities outdoors.
- Activities (e.g. moderate digging, landscaping) typically involve on-site exposures to surface soils.

Outdoor Worker Scenario

- Expected to have an elevated soil ingestion rate (100 mg/day); most highly exposed receptor in the outdoor environment under commercial/industrial conditions.
- Exposure pathways:
 - Ambient air
 - Soil
 - 2D direct external exposure

Outdoor Worker Common Parameters

Parameters Common to all Exposure Route Equations

<input type="text" value="25"/>	ED _{ow} (exposure duration - outdoor worker) yr	<input type="text" value="25"/>	t _{ow} (time - outdoor worker) yr
<input type="text" value="225"/>	EF _{ow} (exposure frequency - outdoor worker) day/yr	<input type="text" value="1.0E-6"/>	TR (target cancer risk) unitless
<input type="text" value="8"/>	ET _{ow} (exposure time - outdoor worker) hr/day		

Outdoor Worker Ambient Air

- Two equations:
 - With half-life decay function for contaminant in air that is not being replenished.
 - Without half-life decay function for contaminant in air that is being replenished.
- Exposure Pathways
 - Inhalation
 - External exposure to contaminants in air

Outdoor Worker Ambient Air SS Inputs – Internal and External Exposure

<input type="text" value="25"/> ED _{ow} (exposure duration - outdoor worker) yr	<input type="text" value="60"/> IRA _{ow} (inhalation rate - outdoor worker) m ³ /day
<input type="text" value="225"/> EF _{ow} (exposure frequency - outdoor worker) day/yr	<input type="text" value="25"/> t _{ow} (time - outdoor worker) yr
<input type="text" value="8"/> ET _{ow} (exposure time - outdoor worker) hr	<input type="text" value="1.0E-6"/> TR (target cancer risk) unitless
<input type="text" value="1"/> GSF _a (gamma shielding factor - air) unitless	

NOTES:

1. SF_i=inhalation slope factor (risk/pCi). rad-specific
2. SF_{sub}=submersion slope factor (risk/pCi). rad-specific
3. λ=decay constant

Outdoor Worker Soil

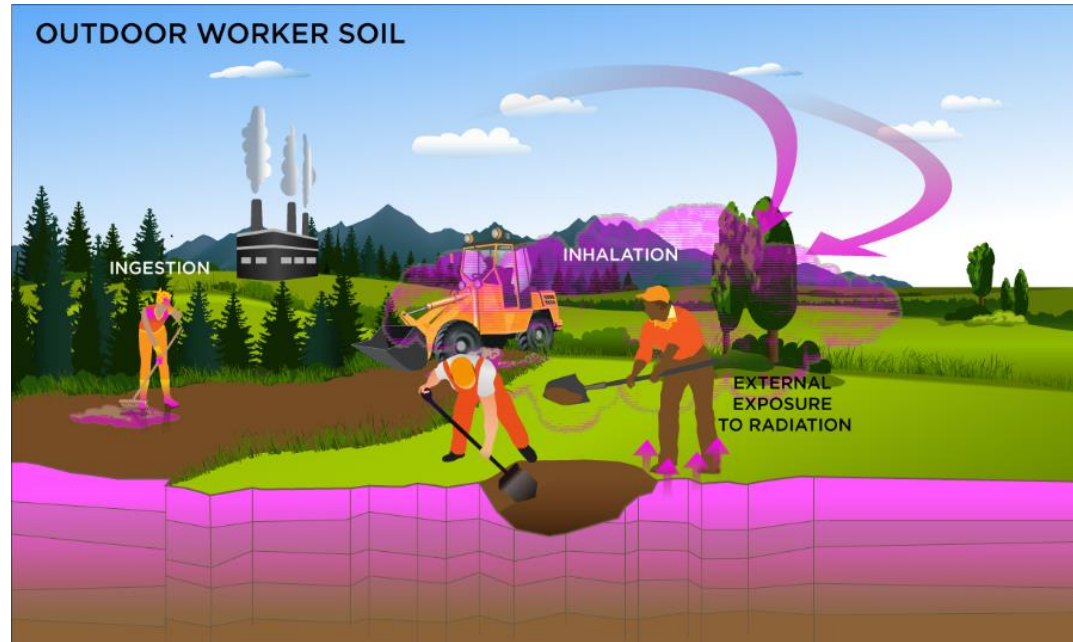

- Exposure pathways
 - Incidental ingestion of soil
 - Inhalation of dust particulates emitted from soil
 - External exposure to ionizing radiation

Outdoor Worker Soil SS Inputs

Ingestion, External, and Inhalation Exposure

Select a slab size ▾ Slab size for ACF

Select a soil thickness cover layer ▾ Select cover layer
thickness for GSF_o (gamma shielding factor - outdoor)

25 ED_{ow} (exposure duration - outdoor worker) yr

225 EF_{ow} (exposure frequency - outdoor worker)
day/yr

8 ET_{ow} (exposure time - outdoor worker) hr/day

60 IRA_{ow} (inhalation rate - outdoor worker) m^3/day

100 IR_{ow} (soil intake rate - outdoor worker) mg/day

25 t_{ow} (time - outdoor worker) yr

1.0E-6 TR (target cancer risk) unitless

NOTES:

1. SF_i =inhalation slope factor (risk/pCi). rad-specific
2. SF_o =ingestion slope factor (risk/pCi). rad-specific
3. SF_{ext-sv} =external exposure slope factor (risk-yr/pCi-g). rad-specific
4. $t_{ow}=ED_{ow}$
5. λ =decay constant
6. Q/C_{wind} =calculations based on site size and climactic zone. Further details on the derivation of Q/C_w can be found in [Appendix D](#)
7. A, B, C = PEF region-specific dispersion constants (unitless)

Outdoor Worker 2D Direct External Exposure

- Consider external exposure for different area sizes. Isotope-specific area correction factor (ACF) used in analysis.
- ACF is now source depth specific.
- Site scenarios
 - Infinite depth (3D)
 - 1 cm soil depth
 - 5 cm soil depth
 - 15 cm soil depth
 - Contaminated dust

Outdoor Worker 2D Direct External Exposure (cont.)

25 ED_{ow} (exposure duration - outdoor worker) yr

225 EF_{ow} (exposure frequency - outdoor worker)
day/yr

8 ET_{ow} (exposure time - outdoor worker) hr

25 t_{ow} (time - outdoor worker) yr

1.0E-6 TR (target cancer risk) unitless

NOTES:

1. Slab size for ACF in alternate external exposure equations is determined by area selected in soil section above
2. SF_{ext-gp}=ground plane external exposure slope factor (risk-yr/pCi-g). rad-specific
3. SF_{ext-sv}=infinite soil volume external exposure slope factor (risk-yr/pCi-g). rad-specific
4. SF_{ext-1cm}=soil volume at 1 cm external exposure slope factor (risk-yr/pCi-g). rad-specific
5. SF_{ext-5cm}=soil volume at 5 cm external exposure slope factor (risk-yr/pCi-g). rad-specific
6. SF_{ext-15cm}=soil volume at 15 cm external exposure slope factor (risk-yr/pCi-g). rad-specific
7. t_{ow}=ED_{ow}
8. λ=decay constant

Buried Waste

- ◆ Revised PRG and DCC added option for buried waste. Depth-specific gamma shielding factors ($GSF_{0,s}$) are now given for:
 - Various slope and dose conversion factors (ground plane, 1 cm, 5 cm, 15 cm and infinite depth) and various soil cover depths
 - Does not account for radionuclide transport (e.g., radon through the cap, radionuclide leaching to groundwater)
 - Assumes cover does not degrade
 - Covers of 0, 10, 20, 30, 40, 50, 60, 70, 80, 90 and 100 cm available.



Buried Waste (cont.)

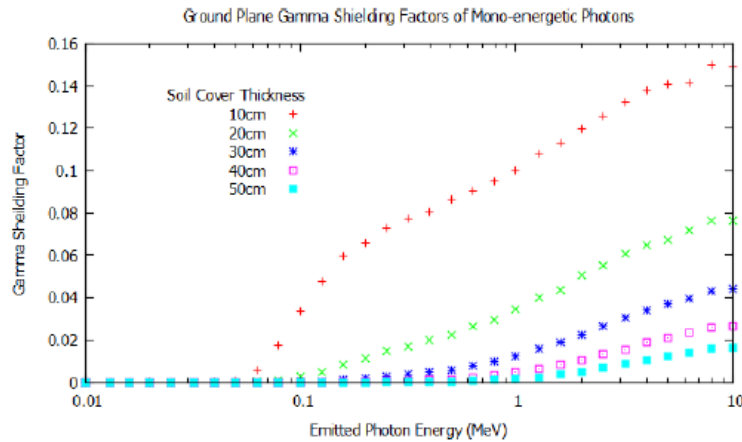

Figure 2: Ground Plane GSF of Mono-energetic Photons with Cover Thickness 10cm through 50cm

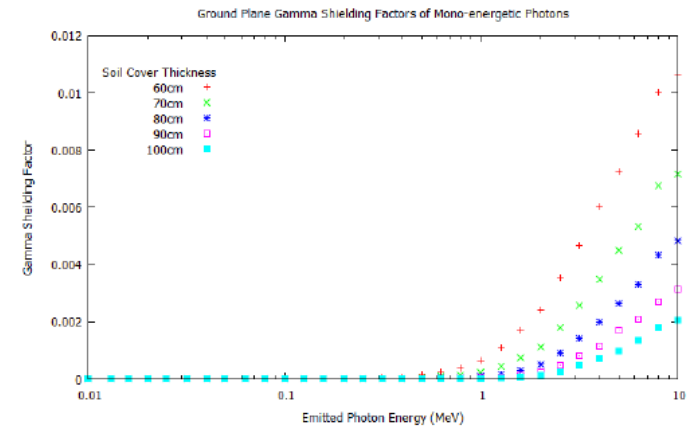

Figure 3: Ground Plane GSF of Mono-energetic Photons with Cover Thickness 60cm through 100cm

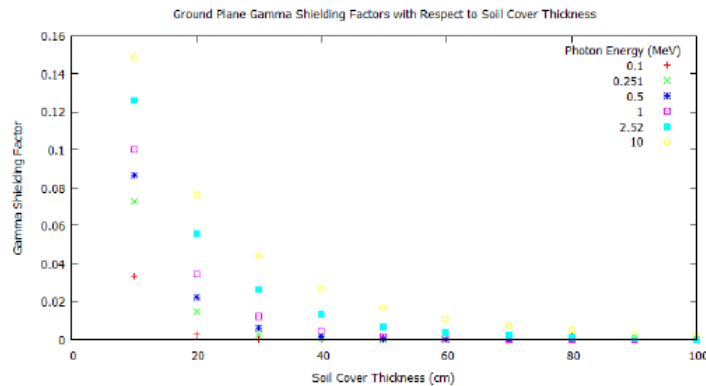

Figure 4: Ground Plane GSF of Mono-energetic Photons versus Cover Thickness at Various Energies

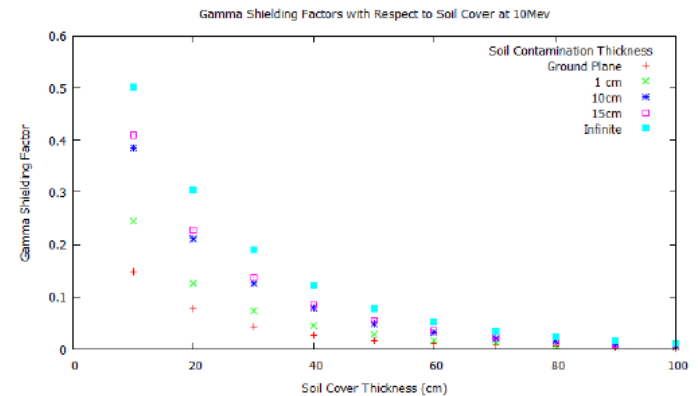

Figure 5: GSF at 10 MeV using Various Contamination Thicknesses with Respect to Soil Cover Depth

Indoor Worker Scenario

- Long-term receptor for an indoor worker spends most, if not all, of the workday indoors. Thus, an indoor worker has no direct contact with outdoor soils.
- PRGs calculated for this receptor are expected to be protective of both workers engaged in low intensity activities (e.g. office work) and those engaged in more strenuous activity (e.g. factory or warehouse workers).



Indoor Worker Exposure Pathways

- Ambient air
- Soil
- 2D alternate external exposure

INDOOR WORKER SOIL 2-D EXTERNAL EXPOSURE

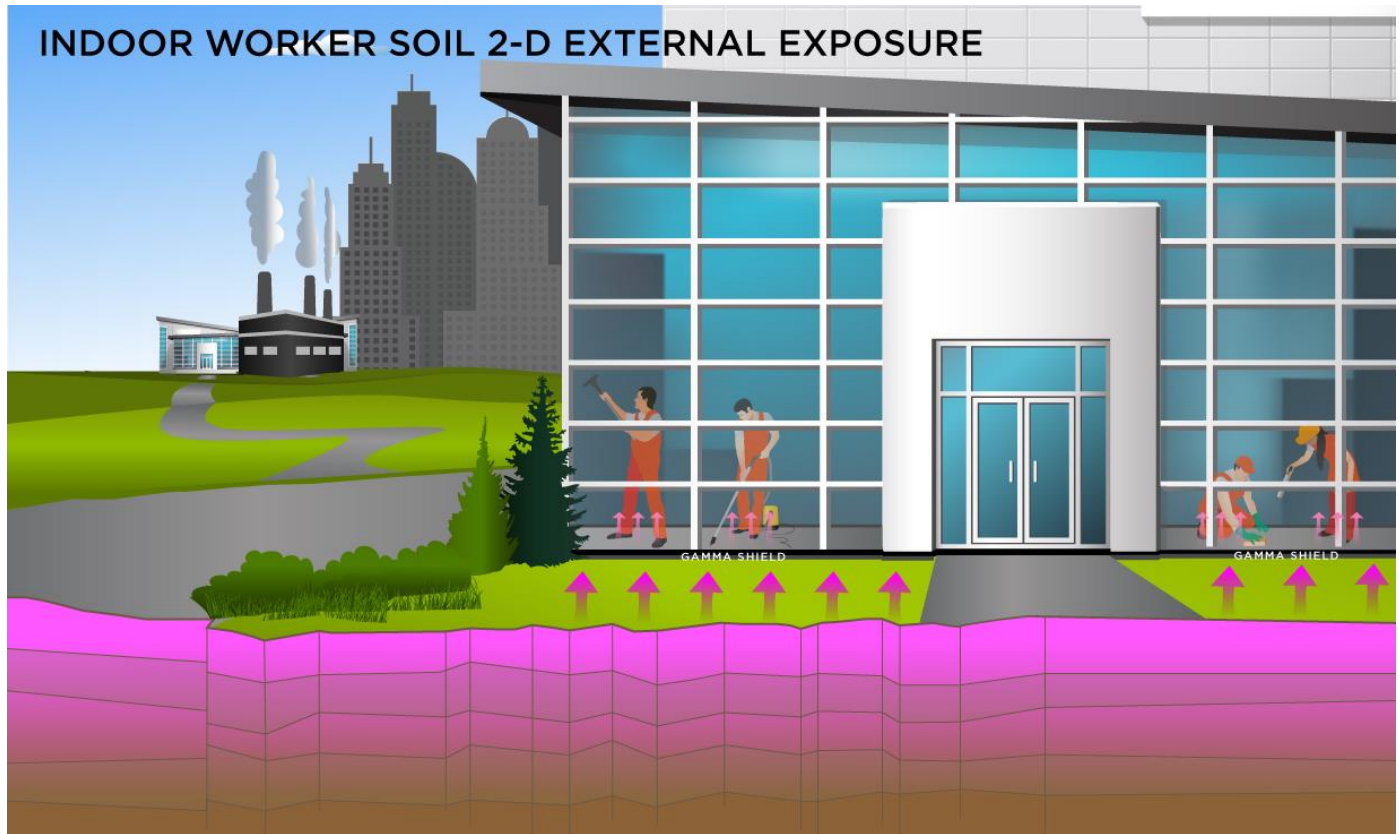

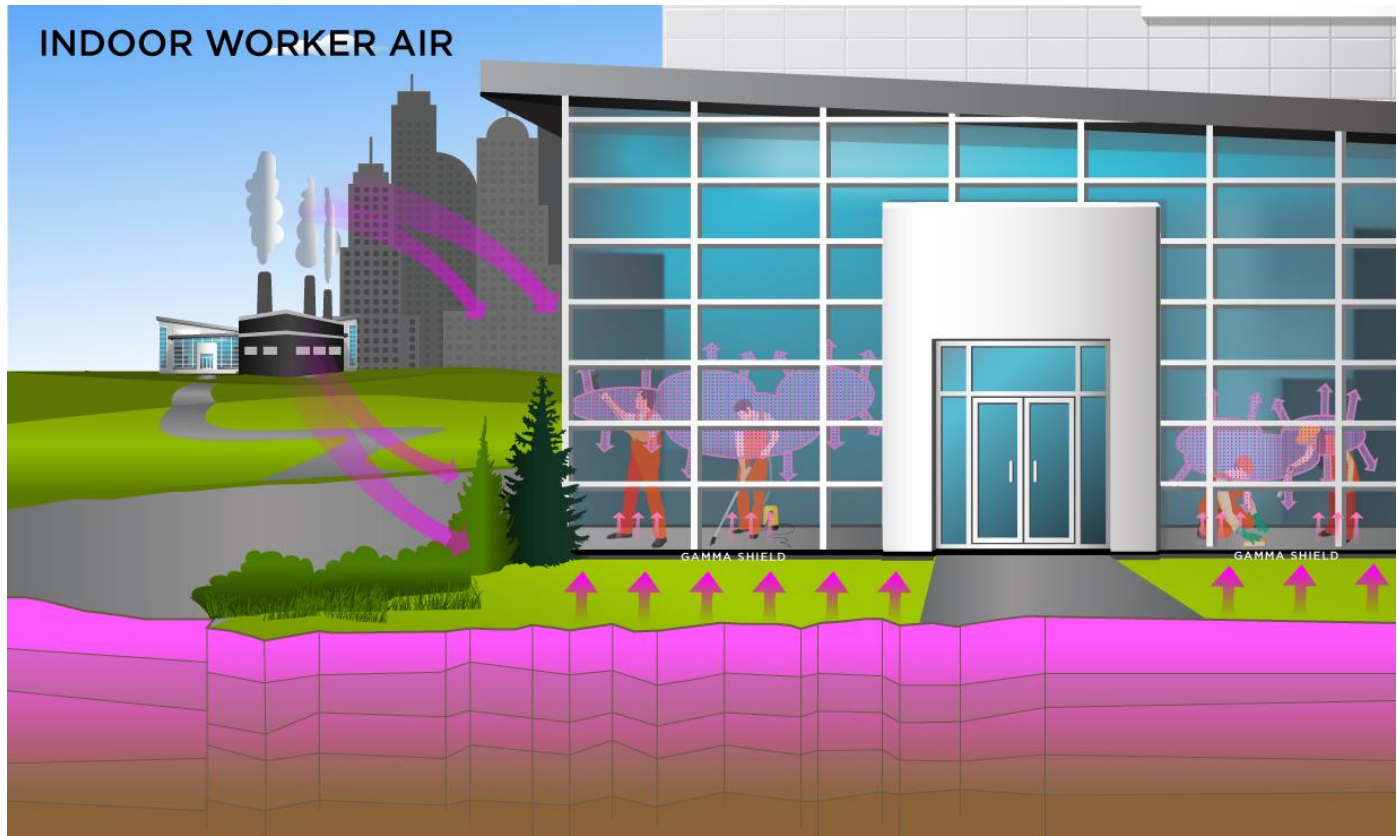

Indoor Worker Ambient Air

- Two equations:
 - With half-life decay function for contaminant in air that is not being replenished.
 - Without half-life decay function for contaminant in air that is being replenished.
- Exposure Pathways
 - Inhalation
 - External exposure to contaminants in air

Parameters Common to all Exposure Route Equations

<input type="text" value="25"/>	ED _{iw} (exposure duration - indoor worker) yr	<input type="text" value="25"/>	t _{iw} (time - indoor worker) yr
<input type="text" value="250"/>	EF _{iw} (exposure frequency - indoor worker) day/yr	<input type="text" value="1.0E-6"/>	TR (target cancer risk) unitless
<input type="text" value="8"/>	ET _{iw} (exposure time - indoor worker) hr/day		

Indoor Worker Ambient Air SS Inputs – Inhalation and External Exposure

<input type="text" value="25"/> ED_{iw} (exposure duration - indoor worker) yr	<input type="text" value="60"/> IRA_{iw} (inhalation rate - indoor worker) m^3/day
<input type="text" value="250"/> EF_{iw} (exposure frequency - indoor worker) day/yr	<input type="text" value="25"/> t_{iw} (time - indoor worker) yr
<input type="text" value="8"/> ET_{iw} (exposure time - indoor worker) hr	<input type="text" value="1.0E-6"/> TR (target cancer risk) unitless
<input type="text" value="1.0"/> GSF_a (gamma shielding factor - air) unitless	

NOTES:

1. SF_i =inhalation slope factor (risk/pCi). rad-specific
2. SF_{sub} =submersion slope factor (risk/pCi). rad-specific
3. λ =decay constant

Indoor Worker Soil

- No direct contact with outdoor soil.
- Exposure Pathways
 - Incidental ingestion of contaminated soils incorporated into indoor dust
 - Inhalation of dust particulates emitted from soil
 - External exposure to ionizing radiation
 - Gamma rays from radionuclides in soil penetrate the building foundations and flooring.

Indoor Worker Soil

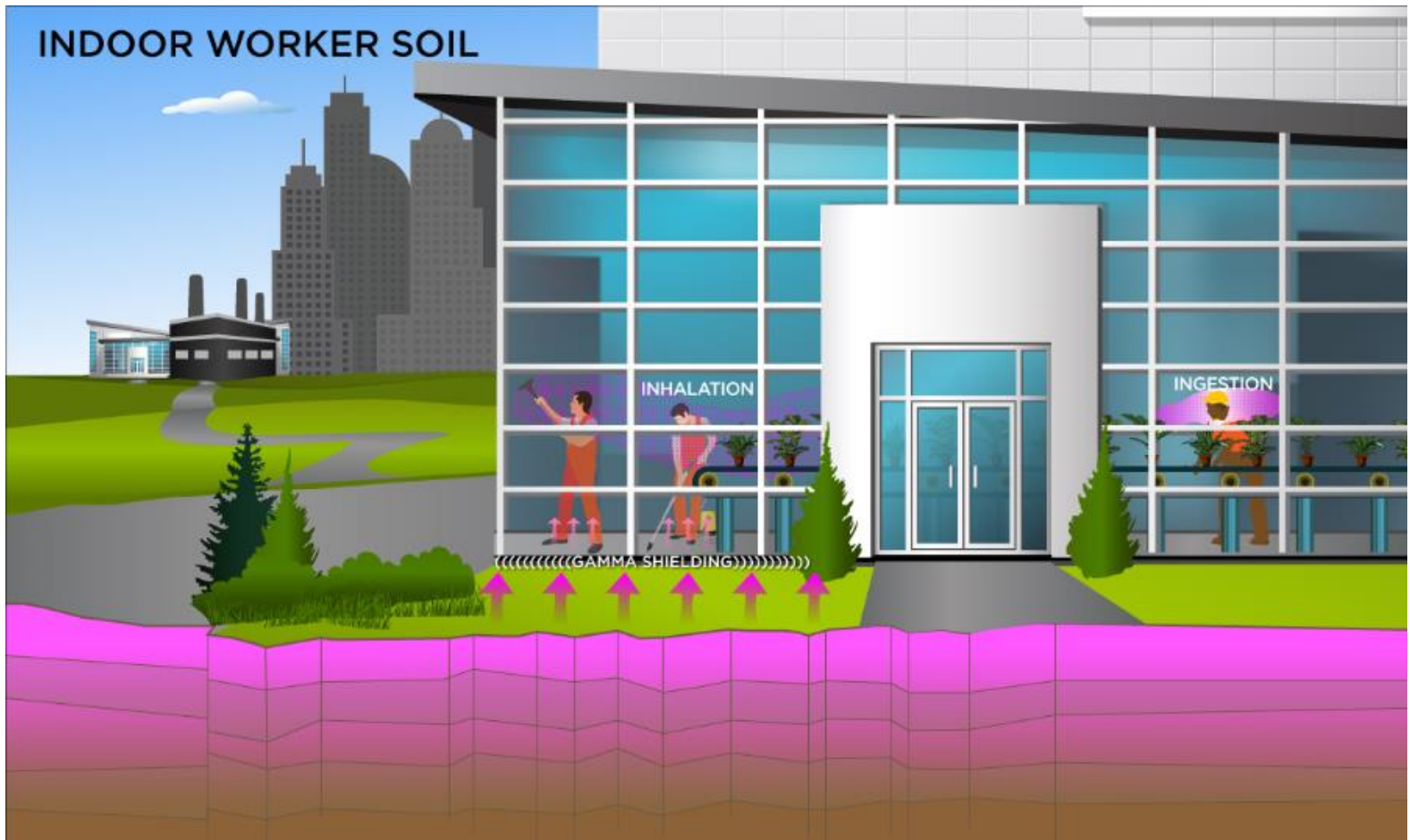

Indoor Worker Soil SS Inputs

Ingestion, External, and Inhalation Exposure

Select a slab size ▾ Slab size for ACF	60 <input type="text"/> IRA_{iw} (inhalation rate - indoor worker) m^3/day
25 <input type="text"/> ED_{iw} (exposure duration - indoor worker) yr	50 <input type="text"/> IRS_{iw} (soil intake rate - indoor worker) mg/day
250 <input type="text"/> EF_{iw} (exposure frequency - indoor worker) day/yr	25 <input type="text"/> t_{iw} (time - indoor worker) yr
8 <input type="text"/> ET_{iw} (exposure time - indoor worker) hr/day	1.0E-6 <input type="text"/> TR (target cancer risk) unitless
0.4 <input type="text"/> GSF_i (gamma shielding factor - indoor) unitless	

NOTES:

1. SF_i =inhalation slope factor (risk/pCi). rad-specific
2. SF_o =ingestion slope factor (risk/pCi). rad-specific
3. SF_{ext-sv} =external exposure slope factor (risk-yr/pCi-g). rad-specific
4. $t_{iw}=ED_{iw}$
5. λ =decay constant
6. Q/C_{wind} =calculations based on site size and climactic zone. Further details on the derivation of Q/C_w can be found in [Appendix D](#)
7. A, B, C = PEF region-specific dispersion constants (unitless)

Indoor Worker 2D Alternate External Exposure

- Exposure to ionizing radiation (namely gamma rays) penetrating building foundation and floor.
- Gamma shielding factor (GSF) accounts for the shielding provided by the building.
 - GSF is the ratio of external gamma radiation level indoors on site to the radiation outdoors on site.

Indoor Worker 2D Alternate External Exposure

- Site scenarios
 - Infinite depth (3D)
 - 1 cm soil depth
 - 5 cm soil depth
 - 15 cm soil depth
 - Contaminated dust

Indoor Worker 2D SS Inputs (cont.)

<input type="text" value="25"/> ED _{iw} (exposure duration - indoor worker) yr	<input type="text" value="0.4"/> GSF _i (gamma shielding factor - indoor) unitless
<input type="text" value="250"/> EF _{iw} (exposure frequency - indoor worker) day/yr	<input type="text" value="25"/> t _{iw} (time - indoor worker) yr
<input type="text" value="8"/> ET _{iw} (exposure time - indoor worker) hr	<input type="text" value="1.0E-6"/> TR (target cancer risk) unitless

NOTES:

1. Slab size for ACF in alternate external exposure equations is determined by area selected in soil section above
2. SF_{ext-gp}=ground plane external exposure slope factor (risk-yr/pCi-g). rad-specific
3. SF_{ext-sv}=infinite soil volume external exposure slope factor (risk-yr/pCi-g). rad-specific
4. SF_{ext-1cm}=soil volume at 1 cm external exposure slope factor (risk-yr/pCi-g). rad-specific
5. SF_{ext-5cm}=soil volume at 5 cm external exposure slope factor (risk-yr/pCi-g). rad-specific
6. SF_{ext-15cm}=soil volume at 15 cm external exposure slope factor (risk-yr/pCi-g). rad-specific
7. t_{iw}=ED_{iw}
8. λ=decay constant



Construction Worker

Standard Unpaved Road Vehicle Traffic (Site-specific only)

- ◆ This is a short-term receptor exposed during the work day working around vehicles suspending dust in the air.
- ◆ The construction worker is expected to have an elevated soil ingestion rate
- ◆ Exposure pathways
 - Incidental ingestion of soil
 - Inhalation of dust particulates emitted from soil
 - External exposure to ionizing radiation

Construction Worker

Standard Unpaved Road Vehicle Traffic (Site-specific only)



Construction Worker

Standard Unpaved Road Vehicle Traffic (Site-specific only)

Parameters Common to all Exposure Route Equations

DW_{cw} (days worked - construction worker) day/wk

ED_{cw} (exposure duration - construction worker)
yr

EF_{cw} (exposure frequency - construction worker)
day/yr

ET_{cw} (exposure time - construction worker) hr

EW_{cw} (weeks worked - construction worker) wk/yr

t_{cw} (time - construction worker) yr

TR (target cancer risk) unitless

Construction Worker

Standard Unpaved Road Vehicle Traffic (Site-specific only)

5 DW_{cw} (days worked - construction worker)

day/wk

1 ED_{cw} (exposure duration - construction worker)

yr

250 EF_{cw} (exposure frequency - construction worker)

day/yr

8 ET_{cw} (exposure time - construction worker) hr

50 EW_{cw} (weeks worked - construction worker)

wk/yr

1 GSF_a (gamma shielding factor - air) unitless

60 IRA_{cw} (inhalation rate - construction worker) m^3/day

1 t_{cw} (time - construction worker) yr

1.0E-6 TR (target cancer risk) unitless

NOTES:

1. SF_i =inhalation slope factor (risk/pCi).
2. SF_{sub} =submersion slope factor (risk/pCi)
3. $t_{cw} = ED_{cw}$
4. λ =decay constant



United States
Environmental Protection
Agency

Superfund Radiation Risk
Assessment Calculator Training

Construction Worker

Standard Unpaved Road Vehicle Traffic (Site-specific only)

5 DW_{cw} (days worked - construction worker)

day/wk

1 ED_{cw} (exposure duration - construction worker)

yr

250 EF_{cw} (exposure frequency - construction worker)

day/yr

8 ET_{cw} (exposure time - construction worker) hr

50 EW_{cw} (weeks worked - construction worker)

wk/yr

1 t_{cw} (time - construction worker) yr

1.0E-6 TR (target cancer risk) unitless

NOTES:

1. Slab size for ACF in alternate external exposure equations is determined by area selected in soil section above
2. SF_{ext-gp} = ground plane external exposure slope factor (mrem-cm²/pCi-yr).
3. SF_{ext-sv} = infinite soil volume external exposure slope factor (mrem-g/pCi-yr).
4. $SF_{ext-1cm}$ = soil volume at 1 cm external exposure slope factor (mrem-g/pCi-yr).
5. $SF_{ext-5cm}$ = soil volume at 5 cm external exposure slope factor (mrem-g/pCi-yr).
6. $SF_{ext-15cm}$ = soil volume at 15 cm external exposure slope factor (mrem-g/pCi-yr).
7. λ = decay constant
8. $ED_r = t_r$

Construction Worker

Standard Unpaved Road Vehicle Traffic (Site-specific only)

Select a slab size ▾ Slab size for ACF	<input type="text" value="50"/> EW_{cw} (weeks worked - construction worker) wk/yr
Select a soil thickness cover layer ▾ Select cover layer thickness for GSF_o (gamma shielding factor - outdoor)	<input type="text" value="60"/> IRA_{cw} (soil inhalation rate - construction worker) m^3/day
<input type="text" value="5"/> DW_{cw} (days worked - construction worker) day/wk	<input type="text" value="330"/> IRS_{cw} (soil ingestion rate - construction worker) mg/day
<input type="text" value="1"/> ED_{cw} (exposure duration - construction worker) yr	<input type="text" value="1"/> t_{cw} (time - construction worker) yr
<input type="text" value="250"/> EF_{cw} (exposure frequency - construction worker) day/yr	<input type="text" value="1.0E-6"/> TR (target cancer risk) unitless
<input type="text" value="8"/> ET_{cw} (exposure time - construction worker) hr	

NOTES:

- EF_{cw} = freq (weeks/year) * days (days/week);

Construction Worker (PEF)

Standard Unpaved Road Vehicle Traffic (Site-specific only)

<input type="text" value="20"/>	W_R (width of road segment) ft	<input type="text"/>	tons/truck
<input type="text" value="0.2"/>	M_{dry} (road surface material moisture content under dry, uncontrolled conditions) %	<input type="text"/>	p (Rainfall Zone) (number of days with at least 0.0 cm precipitation) day/year
<input type="text"/>	number of cars	<input type="text" value="8.5"/>	s (road surface silt content) %
<input type="text"/>	number of trucks	<input type="text" value="0.5"/>	A_s / (acres) PEF
<input type="text"/>	tons/car		
<input type="text" value="12.9351"/>	A (Dispersion Constant)	<input type="text"/>	ΣVKT (sum of fleet vehicle km traveled) km
<input type="text" value="147.58077"/>	L_R (length of road segment) ft	<input type="text"/>	W (mean vehicle weight) tons
<input type="text" value="274.21393"/>	A_R (surface area of contaminated road segment) m^2	<input type="text" value="0.04498"/>	distance (road length) km/day
<input type="text" value="5.7383"/>	B (Dispersion Constant)	<input type="text"/>	PEF_{sc} (particulate emission factor) m^3/kg
<input type="text" value="71.7711"/>	C (Dispersion Constant)	<input type="text" value="23.01785"/>	Q/C_{sr} (inverse of the ratio of the 1-h. geometri mean air concentration to the emission flux along a straight road segment bisecting a square site (g/l) $g/m^2\cdot s$ per kg/m^3)
<input type="text" value="0.185837208"/>	F_D Unitless Dispersion Correction Factor	<input type="text" value="8400"/>	t_c (duration of construction) hours
<input type="text"/>	total number of vehicles	<input type="text" value="7200000"/>	T (time over which traffic occurs) s

Construction Worker (PEF)

Standard Unpaved Road Vehicle Traffic (Site-specific only)

$$PEF_{sc} \left(\frac{m^3_{air}}{kg_{soil}} \right) = \frac{Q}{C_{sr}} \left(\frac{\left(\frac{g}{m^2 \cdot s} \right)}{\left(\frac{kg}{m^3} \right)} \right) \times \frac{1}{F_D} \times \left[\frac{T(s) \times A_R(m^2)}{2.6 \times \left(\frac{s}{12} \right)^{0.8} \times \left(\frac{W(tons)}{3} \right)^{0.4} \times \frac{\left(365 \frac{days}{year} - p \frac{days}{year} \right)}{365 \frac{days}{year}} \times 281.9 \times \Sigma VKT(km)}{\left(\frac{M_{dry}}{0.2} \right)^{0.3}} \right]$$

$$\frac{Q}{C_{sr}} \left(\frac{\left(\frac{g}{m^2 \cdot s} \right)}{\left(\frac{kg}{m^3} \right)} \right) = A \times \exp \left[\frac{(\ln A_S(\text{acre}) - B)^2}{C} \right]$$

$$A_R(m^2) = L_R(\text{ft}) \times W_R(20 \text{ ft}) \times 0.092903 \left(\frac{m^2}{ft^2} \right)$$

$$W(\text{tons}) = \frac{\left(\text{number of cars} \times \frac{\text{tons}}{\text{car}} + \text{number of trucks} \times \frac{\text{tons}}{\text{truck}} \right)}{\text{total vehicles}}$$

$$\Sigma VKT(km) = \text{total vehicles} \times \text{distance} \left(\frac{km}{day} \right) \times EW_{cw} \left(\frac{weeks}{year} \right) \times DW_{cw} \left(\frac{days}{week} \right)$$

$$T(7200000 \text{ s}) = ED_{cw}(1 \text{ yr}) \times EF_{cw} \left(\frac{250 \text{ days}}{year} \right) \times ET_{cw} \left(\frac{8 \text{ hrs}}{day} \right) \times \left(\frac{3600 \text{ s}}{hr} \right)$$

$$F_D(0.18584) = 0.1852 + \left(5.3537 / t_c \right) + \left(-9.6318 / t_c^2 \right)$$

$$t_c(8400 \text{ hr}) = ED_{cw}(1 \text{ yr}) \times EW_{cw} \left(\frac{50 \text{ wks}}{year} \right) \times \left(\frac{7 \text{ days}}{week} \right) \times \left(\frac{24 \text{ hrs}}{day} \right)$$

Construction Worker

Wind Erosion and Other Construction Activities (Site-specific only)

- ◆ This is a short-term receptor exposed during the work day working around heavy machinery suspending dust in the air.
- ◆ The construction worker is expected to have an elevated soil ingestion rate
- ◆ Exposure pathways
 - Incidental ingestion of soil
 - Inhalation of dust particulates emitted from soil
 - External exposure to ionizing radiation



Construction Worker

Wind Erosion and Other Construction Activities (Site-specific only)



Construction Worker (PEF)

Wind Erosion and Other Construction Activities (Site-specific only)

<input type="text"/>	$A_{c\text{-doz}}$ (areal extent of dozing) acres	<input type="text"/>	$N_{A\text{-grade}}$ (number of times site was graded)
<input type="text"/>	A_{excav} (area of excavation site) m^2	11.4	S_{doz} (dozing speed) kph
<input type="text"/>	$A_{c\text{-grade}}$ (areal extent of grading) acres	11.4	S_{grade} (dozing speed) kph
<input type="text"/>	A_{till} (areal extent of tilling) acres	<input type="text"/>	d_{excav} (average depth of excavation site) m
<input type="text"/>	B_I (dozing blade length) m	1.68	ρ_{soil} (density) g/cm^3 - chemical-specific
<input type="text"/>	B_I (grading blade length) m	0.5	$A_c /$ (acres) PEF
7.9	$M_{m\text{-doz}}$ (Gravimetric soil moisture content) %	6.9	S_{doz} (soil silt content) %
12	$M_{m\text{-excav}}$ (Gravimetric soil moisture content) %	18	S_{till} (soil silt content) %
2	$N_{A\text{-dump}}$ (number of times soil is dumped)	4.69	U_m (mean annual wind speed) m/s
2	$N_{A\text{-till}}$ (number of times soil is tilled)	11.32	U_t (equivalent threshold value) m/s
<input type="text"/>	$N_{A\text{-doz}}$ (number of times site was dozed)	0	V (fraction of vegetative cover)
2.4538	A (Dispersion Constant)	<input type="text"/>	M_{till} (dust emitted from tilling operations) g
2023.43	A_{surf} (areal extent of site) m^2	51288.84717	M_{wind} (dust emitted by wind erosion) g
17.5660	B (Dispersion Constant)	<input type="text"/>	ΣVKT_{doz} (sum of fleet vehicle km traveled) km
189.0426	C (Dispersion Constant)	<input type="text"/>	$\Sigma VKT_{\text{grade}}$ (sum of fleet vehicle km traveled) km
0.185837208	F_D Unitless Dispersion Correction Factor	0.194	$F(x)$ (function dependant on U_m/U_t derived using Cowherd et al. (1985))
<input type="text"/>	J_T ($g/m^2\cdot s$)	<input type="text"/>	PEF_{sc} (particulate emission factor) m^3/kg
<input type="text"/>	M_{doz} (dust emitted from dozing operations) g	14.31407	Q/C_{sa} (inverse of the ratio of the geometric mean air concentration to the emission flux at the center of a square source) $g/m^2\cdot s$ per kg/m^3
<input type="text"/>	M_{excav} (dust emitted from excavation soil dumping) g	8400	t_c (duration of construction) hours
<input type="text"/>	M_{grade} (dust emitted from grading operations) g	7200000	T (time over which traffic occurs) s

Construction Worker (PEF)

Wind Erosion and Other Construction Activities (Site-specific only)

$$PEF'_{sc} \left(\frac{m^3_{air}}{kg_{soil}} \right) = \frac{Q}{C_{sa}} \left(\frac{\frac{g}{m^2 \cdot s}}{\frac{kg}{m^3}} \right) \times \frac{1}{F_D} \times \frac{1}{\langle J_T \rangle \left(\frac{g}{m^2 \cdot s} \right)}$$

$$\text{where: } \frac{Q}{C_{sa}} \left(\frac{\frac{g}{m^2 \cdot s}}{\frac{kg}{m^3}} \right) = A \times \exp \left[\frac{(\ln A_C (\text{acre}) - B)^2}{C} \right]$$

$$\langle J_T \rangle \left(\frac{g}{m^2 \cdot s} \right) = \frac{M_{wind}^{PC} (g) + M_{excav} (g) + M_{doz} (g) + M_{grade} (g) + M_{till} (g)}{A_{surf} (m^2) \times T (s)}$$

$$M_{wind}^{PC} (g) = 0.036 \times (1-V) \times \left(\frac{U_m \left(\frac{m}{s} \right)}{U_t \left(\frac{m}{s} \right)} \right)^3 \times F(x) \times A_{surf} (m^2) \times ED (yr) \times 8760 \left(\frac{hr}{yr} \right)$$

$$M_{excav} (g) = 0.35 \times 0.0016 \times \frac{\left(\frac{U_m \left(\frac{m}{s} \right)}{2.2} \right)^{1.3}}{\left(\frac{M_{m-excav} (\%)}{2} \right)^{1.4}} \times P_{soil} \left(\frac{Mg}{m^3} \right) \times A_{excav} (m^2) \times d_{excav} (m) \times N_{A-dump} \times 1000 \left(\frac{g}{kg} \right)$$

$$M_{doz} (g) = 0.75 \times \frac{0.45 \times s_{doz} (\%)^{1.5}}{(M_{m-doz} (\%))^{1.4}} \times \frac{\sum VKT_{doz} (km)}{S_{doz} \left(\frac{km}{hr} \right)} \times 1000 \left(\frac{g}{kg} \right)$$

$$M_{grade} (g) = 0.60 \times 0.0056 \times S_{grade} \left(\frac{km}{hr} \right)^{2.0} \times \sum VKT_{grade} (km) \times 1000 \left(\frac{g}{kg} \right)$$

and:

$$M_{till} (g) = 1.1 \times s_{till} (\%)^{0.6} \times A_{C-till} (\text{acres}) \times 4047 \left(\frac{m^2}{\text{acre}} \right) \times 10^{-4} \left(\frac{ha}{m^2} \right) \times 1000 \left(\frac{g}{kg} \right) \times N_{A-till}$$

$$\text{where: } \sum VKT_{grade} (km) = A_{C-grade} (\text{acres}) \times 4047 \left(\frac{m^2}{\text{acre}} \right) \times \frac{1}{B_g (m)} \times \frac{1}{1000 \left(\frac{m}{km} \right)} \times N_{A-grade}$$

$$\text{where: } \sum VKT_{doz} (km) = A_{C-doz} (\text{acres}) \times 4047 \left(\frac{m^2}{\text{acre}} \right) \times \frac{1}{B_g (m)} \times \frac{1}{1000 \left(\frac{m}{km} \right)} \times N_{A-doz}$$

$$T (7200000 \text{ s}) = ED_{cw} (1 \text{ yr}) \times EF_{cw} \left(\frac{250 \text{ days}}{\text{year}} \right) \times ET_{cw} \left(\frac{8 \text{ hrs}}{\text{day}} \right) \times \left(\frac{3600 \text{ s}}{\text{hr}} \right)$$

$$F_D (0.18584) = 0.1852 + (5.3537 / t_c) + (-9.6318 / t_c^2)$$

$$t_c (8400 \text{ hr}) = ED_{cw} (1 \text{ yr}) \times EW_{cw} \left(\frac{50 \text{ wks}}{\text{year}} \right) \times \left(\frac{7 \text{ days}}{\text{week}} \right) \times \left(\frac{24 \text{ hrs}}{\text{day}} \right)$$

Recreator Scenario

- Extension of residential scenario.
- There are no default exposure parameters.
- Age-adjusted for change in intake as the receptor ages.
- Main pathways: soil, water, wild game, air

Recreator Common Parameters

Parameters Common to all Exposure Route Equations

<input type="text" value="."/> ED _{rec} (exposure duration - recreator) yr	<input type="text" value="."/> ET _{rec} (exposure time - recreator) hr
<input type="text" value="."/> ED _{rec-a} (exposure duration - recreator adult) yr	<input type="text" value="."/> ET _{rec-a} (exposure time - recreator adult) hr
<input type="text" value="."/> ED _{rec-c} (exposure duration - recreator child) yr	<input type="text" value="."/> ET _{rec-c} (exposure time - recreator child) hr
<input type="text" value="."/> EF _{rec} (exposure frequency - recreator) day/yr	<input type="text" value="."/> t _{rec} (time - recreator) yr
<input type="text" value="."/> EF _{rec-a} (exposure frequency - recreator adult) day/yr	<input type="text" value="1.0E-6"/> TR (target cancer risk) unitless
<input type="text" value="."/> EF _{rec-c} (exposure frequency - recreator child) day/yr	

NOTES: Changes in these parameters will be copied down to all the media containers, however you may change each media value independently as well in the fields below.

Recreator Soil

- Exposure pathways
 - Incidental ingestion of soil
 - Inhalation of particulates emitted from soil
 - External exposure to ionizing radiation
 - Consumption of game

Recreator Surface Water

- Exposure pathways
 - Incidental ingestion of water
 - Inhalation of vapors NOT addressed
 - External exposure to ionizing radiation
 - Consumption of game

Recreator SS Inputs for Soil

Select a slab size ▾ Slab size for ACF Select a soil thickness cover layer ▾ Select cover layer thickness for GSF _o (gamma shielding factor - outdoor)	<input type="text" value="."/> ET _{recs-c} (exposure time - recreator) hr/day <input type="text" value="."/> IFA _{rec-adj} (age-adjusted inhalation rate - recreator) m ³ <input type="text" value="."/> IFS _{rec-adj} (age-adjusted soil intake rate - recreator) mg <input type="text" value="20"/> IRA _{recs-a} (inhalation rate - recreator adult) m ³ /day <input type="text" value="10"/> IRA _{recs-c} (inhalation rate - recreator child) m ³ /day <input type="text" value="100"/> IRS _{recs-a} (soil intake rate - recreator adult) mg/day <input type="text" value="200"/> IRS _{recs-c} (soil intake rate - recreator child) mg/day <input type="text" value="."/> t _{rec} (time - recreator) yr <input type="text" value="1.0E-6"/> TR (target cancer risk) unitless
<input type="text" value="."/> ED _{rec} (exposure duration - recreator) yr <input type="text" value="."/> ED _{recs-a} (exposure duration - recreator adult) yr <input type="text" value="."/> ED _{recs-c} (exposure duration - recreator child) yr <input type="text" value="."/> EF _{rec} (exposure frequency - recreator) day/yr <input type="text" value="."/> EF _{recs-a} (exposure frequency - recreator adult) day/yr <input type="text" value="."/> EF _{recs-c} (exposure frequency - recreator child) day/yr <input type="text" value="."/> ET _{rec} (exposure time - recreator) hr/day <input type="text" value="."/> ET _{recs-a} (exposure time - recreator) hr/day	
NOTES: <ol style="list-style-type: none"> SF_o=oral ingestion dose conversion factor (risk/pCi). SF_i=inhalation slope factor (risk/pCi). SF_{ext-sv}=external exposure slope factor (risk-g/pCi-yr). ED_{rec} = t_{rec} 	

Recreator SS Inputs for Air

<input type="text" value="."/> ED_{rec} (exposure duration - recreator) yr	<input type="text" value="."/> ET_{rec-c} (exposure time - recreator child) hr
<input type="text" value="."/> ED_{rec-a} (exposure duration - recreator adult) yr	<input type="text" value="1.0"/> GSF_a (gamma shielding factor - air) unitless
<input type="text" value="."/> ED_{rec-c} (exposure duration - recreator child) yr	<input type="text" value="."/> $IFA_{rec-adj}$ (age-adjusted inhalation factor) m^3
<input type="text" value="."/> EF_{rec} (exposure frequency) day/yr	<input type="text" value="20"/> IRA_{rec-a} (inhalation rate - recreator adult) m^3/day
<input type="text" value="."/> EF_{rec-a} (exposure frequency - recreator adult) day/yr	<input type="text" value="10"/> IRA_{rec-c} (inhalation rate - recreator child) m^3/day
<input type="text" value="."/> EF_{rec-c} (exposure frequency - recreator child) day/yr	<input type="text" value="."/> t_{rec} (time - recreator) yr
<input type="text" value="."/> ET_{rec} (exposure time - recreator) hr	<input type="text" value="1.0E-6"/> TR (target cancer risk) unitless
<input type="text" value="."/> ET_{rec-a} (exposure time - recreator adult) hr	

NOTES:

1. SF_i =inhalation slope factor (risk/pCi).
2. SF_{sub} =submersion slope factor (risk/pCi)
3. $t_r = ED_r = ED_{r-c} + ED_{r-a}$
4. λ =decay constant



Recreator SS Inputs for 2-D Analysis

<input type="text"/> ED_{rec} (exposure duration - recreator) yr	<input type="text"/> t_{rec} (time - recreator) yr
<input type="text"/> EF_{rec} (exposure frequency - recreator) day/yr	<input type="text" value="1.0E-6"/> TR (target cancer risk) unitless
<input type="text"/> ET_{rec} (exposure time - recreator) hr	

NOTES:

1. Slab size for ACF in alternate external exposure equations is determined by area selected in soil section above
2. SF_{ext-gp} = ground plane external exposure slope factor (mrem-cm²/pCi-yr).
3. SF_{ext-sv} = infinite soil volume external exposure slope factor (mrem-g/pCi-yr).
4. $SF_{ext-1cm}$ = soil volume at 1 cm external exposure slope factor (mrem-g/pCi-yr).
5. $SF_{ext-5cm}$ = soil volume at 5 cm external exposure slope factor (mrem-g/pCi-yr).
6. $SF_{ext-15cm}$ = soil volume at 15 cm external exposure slope factor (mrem-g/pCi-yr).
7. λ = decay constant
8. $ED_{rec} = t_{rec}$



Recreator SS Inputs for Surface Water

<input type="text" value="."/>	DFA _{recw-adj} (age-adjusted immersion factor - recreator) L	<input type="text" value="."/>	ET _{recw-c} (exposure time - recreator child) hr/day
<input type="text" value="."/>	ED _{rec} (exposure duration - recreator) yr	<input type="text" value="."/>	EV _{recw-a} (number of bathing events per day - recreator adult) event/day
<input type="text" value="."/>	ED _{recw-a} (exposure duration - recreator adult) yr	<input type="text" value="."/>	EV _{recw-c} (number of bathing events per day - recreator child) event/day
<input type="text" value="."/>	ED _{recw-c} (exposure duration - recreator child) yr	<input type="text" value="."/>	IFW _{recw-adj} (age-adjusted water intake rate - recreator) L
<input type="text" value="."/>	EF _{recw-a} (exposure frequency - recreator adult) day/yr	<input type="text" value="0.05"/>	IRW _{recw-a} (water intake rate - recreator adult) L/hr
<input type="text" value="."/>	EF _{recw-c} (exposure frequency - recreator child) day/yr	<input type="text" value="0.05"/>	IRW _{recw-c} (water intake rate - recreator child) L/hr
<input type="text" value="."/>	ET _{recw-a} (exposure time - recreator adult) hr/day	<input type="text" value="1.0E-6"/>	TR (target cancer risk) unitless

NOTES:

1. SF_o=oral ingestion slope factor (risk/pCi).
2. SF_f=food ingestion slope factor (risk/pCi).
3. SF_i=inhalation slope factor (risk/pCi).
4. ED_{rec} = t_{rec}

Recreator SS Inputs for Game

<input type="text" value="1"/>	CF_{rec-fo} (fowl contaminated fraction) unitless	<input type="text" value="0.25"/>	MLF (game pasture plant mass loading factor)
<input type="text" value="1"/>	CF_{rec-ga} (game contaminated fraction) unitless	unitless	
<input type="text" value="."/>	ED_{rec} (exposure duration - recreator) yr	<input type="text" value="."/>	Q_{p-fowl} (fowl fodder intake rate) kg/day
<input type="text" value="."/>	EF_{rec} (exposure frequency - recreator) day/yr	<input type="text" value="."/>	Q_{p-game} (land game fodder intake rate) kg/day
<input type="text" value="1"/>	f_{p-fowl} (fowl on-site fraction) unitless	<input type="text" value="."/>	Q_{s-fowl} (fowl soil intake rate) kg/day
<input type="text" value="1"/>	f_{p-game} (land game on-site fraction) unitless	<input type="text" value="."/>	Q_{s-game} (land game soil intake rate) kg/day
<input type="text" value="1"/>	f_{s-fowl} (fraction of year fowl is on site) unitless	<input type="text" value="."/>	Q_{w-fowl} (fowl water intake rate) kg/day
<input type="text" value="1"/>	f_{s-game} (fraction of year land game is on site)	<input type="text" value="."/>	Q_{w-game} (land game water intake rate) kg/day
unitless		<input type="text" value="."/>	
<input type="text" value="."/>	$IRGL_{rec}$ (fowl consumption rate) g/day	<input type="text" value="1.0E-6"/>	TR (target cancer risk) unitless
<input type="text" value="."/>	$IRGF_{rec}$ (land game consumption rate) g/day		

NOTES:

- SF_o =food ingestion slope factor (risk/pCi). rad-specific

Farmer Scenario

- Extension of residential scenario.
- Evaluates direct consumption of farm products for a subsistence farmer.
- Evaluates consumption of farm products back-calculated to soil and water.
- Age-adjusted for change in intake as the receptor ages.
- Main pathways: soil and livestock consumption

Farmer Scenario

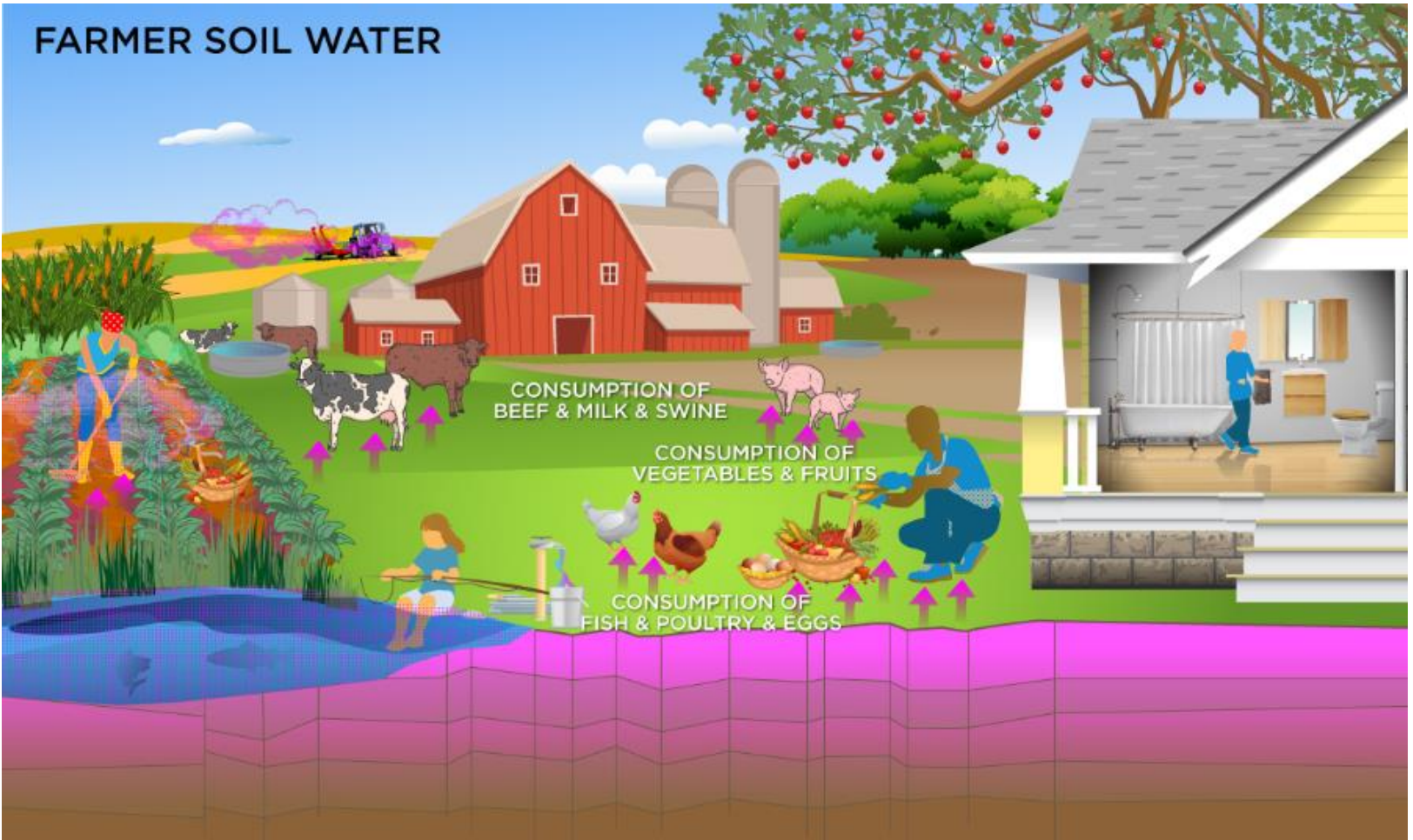

Farmer Soil

- Exposure pathways
 - Incidental ingestion of soil
 - Inhalation of particulates emitted from soil
 - External exposure to ionizing radiation
 - Consumption of fruits and vegetables
 - 100% home grown

Farmer Water

- Exposure pathways
 - Incidental ingestion of water
 - Inhalation of volatiles from water
 - External exposure to ionizing radiation
 - Consumption of fruits and vegetables
 - 100% home grown

Farmer Livestock Consumption

- 100% homegrown livestock consumption
- All feed for animal products considered grown on contaminated media on site.
- Scenarios:
 - Beef
 - Milk
 - Fish
 - Fruit
 - Swine
 - Eggs
 - Poultry
 - Vegetables

Farmer SS Inputs

Common Parameters

Parameters Common to all Exposure Route Equations

ED_f (exposure duration - farmer) yr

ED_{f-a} (exposure duration - farmer adult) yr

ED_{f-c} (exposure duration - farmer child) yr

EF_f (exposure frequency - farmer) day/yr

EF_{f-a} (exposure frequency - farmer adult) day/yr

EF_{f-c} (exposure frequency - farmer child) day/yr

ET_f (exposure time - farmer) hr

ET_{f-a} (exposure time - farmer adult) hr

ET_{f-c} (exposure time - farmer child) hr

t_f (time - farmer) yr

TR (target cancer risk) unitless

Farmer SS Inputs for Air

ED_f (exposure duration - farmer) yr

ED_{f-a} (exposure duration - farmer adult) yr

ED_{f-c} (exposure duration - farmer child) yr

EF_f (exposure frequency - farmer) day/yr

EF_{f-a} (exposure frequency - farmer adult) day/yr

EF_{f-c} (exposure frequency - farmer child) day/yr

ET_f (exposure time - farmer) hr

ET_{f-a} (exposure time - farmer adult) hr

ET_f (exposure time - farmer child) hr

GSF_a (gamma shielding factor - air) unitless

IFA_{f-adj} (age-adjusted inhalation factor - farmer)
 m^3

IRA_{f-a} (inhalation rate - farmer adult) m^3/day

IRA_{f-c} (inhalation rate - farmer child) m^3/day

t_f (time - farmer) yr

TR (target cancer risk) unitless

NOTES:

1. SF_i =inhalation slope factor (risk/pCi).
2. SF_{sub} =submersion slope factor (risk/pCi)
3. λ =decay constant

Farmer SS Inputs for Soil

Select a slab size ▾ Slab size for ACF	
Select a soil thickness cover layer ▾ Select cover layer thickness for GSF_o (gamma shielding factor - outdoor)	
<input type="text" value="40"/> ED_f (exposure duration - farmer) yr	<input type="text" value="12.168"/> ET_{f-o} (outdoor exposure time fraction) hr/day
<input type="text" value="34"/> ED_{f-a} (exposure duration - farmer adult) yr	<input type="text" value="0.4"/> GSF_i (gamma shielding factor - indoor)
<input type="text" value="6"/> ED_{f-c} (exposure duration - farmer child) yr	<input type="text" value="259000"/> IFA_{f-adj} (age-adjusted soil inhalation factor) m^3
<input type="text" value="350"/> EF_f (exposure frequency) day/yr	<input type="text" value="1610000"/> IFS_{f-adj} (age-adjusted soil ingestion factor) mg
<input type="text" value="350"/> EF_{f-a} (exposure frequency - farmer adult) day/yr	<input type="text" value="20"/> IRA_{f-a} (inhalation rate - farmer adult) m^3/day
<input type="text" value="350"/> EF_{f-c} (exposure frequency - farmer child) day/yr	<input type="text" value="10"/> IRA_{f-c} (inhalation rate - farmer child) m^3/day
<input type="text" value="24"/> ET_{f-a} (exposure time - farmer adult) hr/day	<input type="text" value="100"/> IRS_{f-a} (soil ingestion rate - farmer adult) mg/day
<input type="text" value="24"/> ET_{f-c} (exposure time - farmer child) hr/day	<input type="text" value="200"/> IRS_{f-c} (soil ingestion rate - farmer child) mg/day
<input type="text" value="10.008"/> ET_{f-i} (indoor exposure time fraction) hr/day	<input type="text" value="40"/> t_f (time - farmer) yr
	<input type="text" value="1.0E-6"/> TR (target cancer risk) unitless

Farmer SS Inputs for Beef

Equations and Parameters for Consumption of Beef

Beef Consumption - back calculated to soil

Beef Consumption - direct

<input type="text" value="1"/> $f_{p\text{-beef}}$ (animal on-site fraction) unitless	<input type="text" value="11.77"/> $Q_{p\text{-beef}}$ (beef fodder intake rate) kg/day
<input type="text" value="1"/> $f_{s\text{-beef}}$ (fraction of year animal on site) unitless	<input type="text" value="0.39"/> $Q_{s\text{-beef}}$ (beef soil intake rate) kg/day
<input type="text" value="0.25"/> MLF_{beef} (plant mass loading factor) unitless	
<hr/>	
<input type="text" value="53"/> $Q_{w\text{-beef}}$ (beef water intake rate) L/day	
<hr/>	
<input type="text" value="1"/> CF_{beef} (beef contaminated fraction) unitless	<input type="text" value="179.7"/> $IRB_{f\text{-a}}$ (beef ingestion rate - farmer adult) g/day
<input type="text" value="2222640"/> $IFB_{f\text{-adj}}$ (age-adjusted beef ingestion factor) g	<input type="text" value="40.1"/> $IRB_{f\text{-c}}$ (beef ingestion rate - farmer child) g/day

Farmer SS Inputs for Produce

Equations and Parameters for Consumption of Produce

Produce Consumption - back calculated to soil

Produce Consumption - direct

$MLF_{produce}$ (produce plant mass loading factor)
unitless

T (translocation factor) unitless

F (irrigation period) unitless

I_f (interception fraction) unitless

Ir (irrigation rate) L/m²-day

λ_{HL} (soil leaching rate) 1/day

MLF (produce plant mass loading factor) unitless

P (area density for root zone) kg/m²

t_b (long term deposition and buildup) day

t_v (above ground exposure time) day

t_w (weathering half-life) day

Y_v (plant yield - wet) kg/m²

CPF_f (contaminated produce fraction) unitless

ED_{f-a} (exposure duration - farmer adult) yr

ED_{f-c} (exposure duration - farmer child) yr

EF_{f-a} (exposure frequency - farmer adult) day/yr

EF_{f-c} (exposure frequency - farmer child) day/yr

IFF_{f-adj} (age-adjusted fruit ingestion factor) g

IFV_{f-adj} (age-adjusted vegetable ingestion factor)
g

IRF_{f-a} (fruit ingestion rate - farmer adult) g/day

IRF_{f-c} (fruit ingestion rate - farmer child) g/day

IRV_{f-a} (vegetable ingestion rate - farmer adult) g/day

IRV_{f-c} (vegetable ingestion rate - farmer child) g/day

Farmer SS Inputs for Milk

Equations and Parameters for Consumption of Dairy

Dairy Consumption - back calculated to soil

Dairy Consumption - direct

ρ_m (density of milk) kg/L

MLF_{dairy} (plant mass loading factor) unitless

$f_{p-dairy}$ (animal on-site fraction) unitless

$Q_{p-dairy}$ (dairy fodder intake rate) kg/day

$f_{s-dairy}$ (fraction of year animal on site) unitless

$Q_{s-dairy}$ (dairy soil intake rate) kg/day

$Q_{w-dairy}$ (dairy water intake rate) L/day

CF_{dairy} (dairy contaminated fraction) unitless

IRD_{f-a} (dairy ingestion rate - farmer adult) g/day

IFD_{f-adj} (age-adjusted dairy ingestion factor) g

IRD_{f-c} (dairy ingestion rate - farmer child) g/day

Farmer SS Inputs for Swine

Equations and Parameters for Consumption of Swine

Swine Consumption - back calculated to soil

Swine Consumption - direct

<input type="text" value="1"/> $f_{p-swine}$ (animal on-site fraction) unitless	<input type="text" value="4.7"/> $Q_{p-swine}$ (swine fodder intake rate) kg/day
<input type="text" value="1"/> $f_{s-swine}$ (fraction of year animal on site) unitless	<input type="text" value="0.37"/> $Q_{s-swine}$ (swine soil intake rate) kg/day
<input type="text" value="0.25"/> MLF_{swine} (plant mass loading factor) unitless	
<input type="text" value="11.4"/> $Q_{w-swine}$ (swine water intake rate) L/day	
<input type="text" value="1"/> CF_{sw} (swine contaminated fraction) unitless	<input type="text" value="97.8"/> $IRSW_{f-a}$ (swine ingestion rate - farmer adult) g/day
<input type="text" value="1202670"/> $IFSW_{f-adj}$ (age-adjusted swine ingestion factor) g	<input type="text" value="18.5"/> $IRSW_{f-c}$ (swine ingestion rate - farmer child) g/day



United States
Environmental Protection
Agency

Superfund Radiation Risk
Assessment Calculator Training

Farmer SS Inputs for Egg & Poultry

Equations and Parameters for Consumption of Eggs and Poultry

Egg Consumption - back calculated to soil

Egg Consumption - direct

Poultry Consumption - back calculated to soil

Poultry Consumption - direct

<input type="text" value="1"/>	f_{p-po} (animal on-site fraction) unitless	<input type="text" value="0.2"/>	Q_{p-po} (poultry fodder intake rate) kg/day
<input type="text" value="1"/>	f_{s-po} (fraction of year animal on site) unitless	<input type="text" value="0.022"/>	Q_{s-po} (poultry soil intake rate) kg/day
<input type="text" value="0.25"/>	$MLF_{poultry}$ (plant mass loading factor) unitless		

<input type="text" value="0.4"/>	Q_{w-po} (poultry water intake rate) L/day
----------------------------------	--

<input type="text" value="1"/>	CF_{egg} (egg contaminated fraction) unitless	<input type="text" value="53.3"/>	IRE_{f-a} (egg ingestion rate - farmer adult) g/day
<input type="text" value="1"/>	CF_{po} (poultry contaminated fraction) unitless	<input type="text" value="10.95"/>	IRE_{f-c} (egg ingestion rate - farmer child) g/day
<input type="text" value="657265"/>	IFE_{f-adj} (age-adjusted egg ingestion factor) g	<input type="text" value="106.5"/>	IRP_{f-a} (poultry ingestion rate - farmer adult) g/day
<input type="text" value="1316910"/>	IFP_{f-adj} (age-adjusted poultry ingestion factor) g	<input type="text" value="23.6"/>	IRP_{f-c} (poultry ingestion rate - farmer child) g/day

Farmer SS Inputs for Fish

Equations and Parameters for Consumption of Fish

Fish Consumption - back calculated to soil

$$PRG_{\text{soil-f-fish-ing}} (\text{pCi/g}) = \frac{PRG_{\text{f-fish-ing}} (\text{pCi/g}) \times kd \left(\frac{\text{L}}{\text{kg}} \right) \times \left(\frac{t_r (\text{yr}) \times \lambda \left(\frac{1}{\text{yr}} \right)}{1 - e^{-\lambda t_r}} \right)}{BCF \left(\frac{\text{L}}{\text{kg}} \right)}$$

Fish Consumption - direct

$$PRG_{\text{f-fish-ing}} (\text{pCi/g}) = \frac{TR}{SF_f \left(\frac{\text{risk}}{\text{pCi}} \right) \times IFFI_{\text{f-adj}} (1,932,420 \text{ g}) \times CF_{\text{fish}} (1)}$$

where:

$$IFFI_{\text{f-adj}} (1,932,420 \text{ g}) = \left(EF_{\text{f-c}} \left(\frac{350 \text{ day}}{\text{yr}} \right) \times ED_{\text{f-c}} (6 \text{ yr}) \times IRFI_{\text{f-c}} \left(\frac{32.8 \text{ g}}{\text{day}} \right) \right) + \left(EF_{\text{f-a}} \left(\frac{350 \text{ day}}{\text{yr}} \right) \times ED_{\text{f-a}} (34 \text{ yr}) \times IRFI_{\text{f-a}} \left(\frac{156.6 \text{ g}}{\text{day}} \right) \right)$$

CF_{fish} (fish contaminated fraction) unitless

$IRFI_{\text{f-a}}$ (fish ingestion rate - farmer adult) g/day

$IFFI_{\text{f-adj}}$ (age-adjusted fish ingestion factor) g

$IRFI_{\text{f-c}}$ (fish ingestion rate - farmer child) g/day

Farmer Total Equations

Total Soil

$$PRG_{\text{soil-f-tot}} \text{ (pCi/g)} = \frac{1}{\frac{1}{PRG_{\text{soil-f-sol-ing}}} + \frac{1}{PRG_{\text{soil-f-sol-inh}}} + \frac{1}{PRG_{\text{soil-f-sol-ext}}} + \frac{1}{PRG_{\text{soil-f-prod-ing}}} + \frac{1}{PRG_{\text{soil-f-egg-ing}}} + \frac{1}{PRG_{\text{soil-f-po-ing}}} + \frac{1}{PRG_{\text{soil-f-fish-ing}}} + \frac{1}{PRG_{\text{soil-f-beef-ing}}} + \frac{1}{PRG_{\text{soil-f-dairy-ing}}} + \frac{1}{PRG_{\text{soil-f-sw-ing}}}}$$

Total Agricultural products - back calculated to water

$$PRG_{\text{wat-f-tot}} \text{ (pCi/L)} = \frac{1}{\frac{1}{PRG_{\text{water-f-ing}}} + \frac{1}{PRG_{\text{water-f-inh}}} + \frac{1}{PRG_{\text{water-f-imm}}} + \frac{1}{PRG_{\text{water-f-prod-ing}}} + \frac{1}{PRG_{\text{water-f-egg-ing}}} + \frac{1}{PRG_{\text{wat-water-f-po-ing}}} + \frac{1}{PRG_{\text{water-f-fish-ing}}} + \frac{1}{PRG_{\text{water-f-beef-ing}}} + \frac{1}{PRG_{\text{water-f-dairy-ing}}} + \frac{1}{PRG_{\text{water-f-sw-ing}}}}$$

Total Water

$$PRG_{\text{water-f-tot}} \text{ (pCi/g)} = \frac{1}{\frac{1}{PRG_{\text{water-f-ing}}} + \frac{1}{PRG_{\text{water-f-inh}}} + \frac{1}{PRG_{\text{water-f-imm}}} + \frac{1}{PRG_{\text{water-f-prod}}}}$$



Farmer Soil and Water Graph

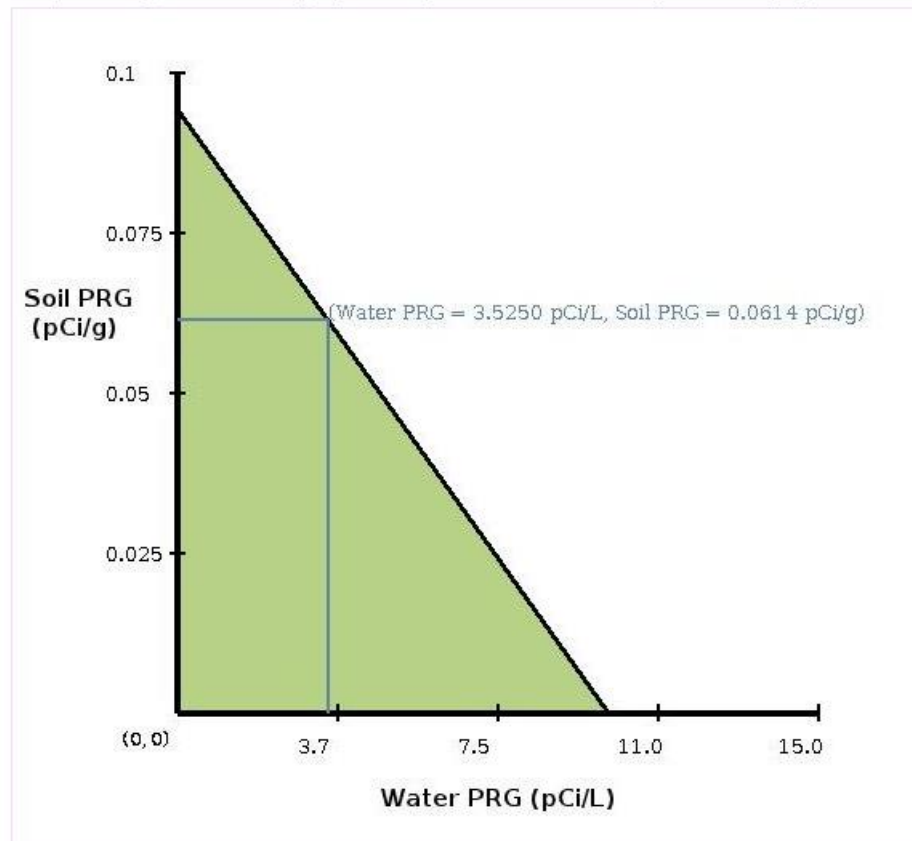

Site-specific Factors

- Blue input fields in the calculator are variable-dependent and automatically adjusted based on site-specific inputs.
- Particular Emission Factor (PEF)
- Volatilization Factor (VF)
- Soil to Groundwater transport
- Radionuclide decay constant (λ)
- Area Correction Factor (ACF)
- Gamma Shielding Factor (soil) GSF_o

Particulate Emission Factor

- Expresses the dispersion of particulate matter in a specific climate. Varies with weather conditions.
- Determines impact of adsorbed radionuclides on dispersed particulate matter.
- Required for calculations in soil scenarios for residential, farmer, and outdoor, indoor, and composite workers.
- Does not significantly affect most PRGs with exception of a few radionuclides

US Climactic Zones – For Calculating PEF

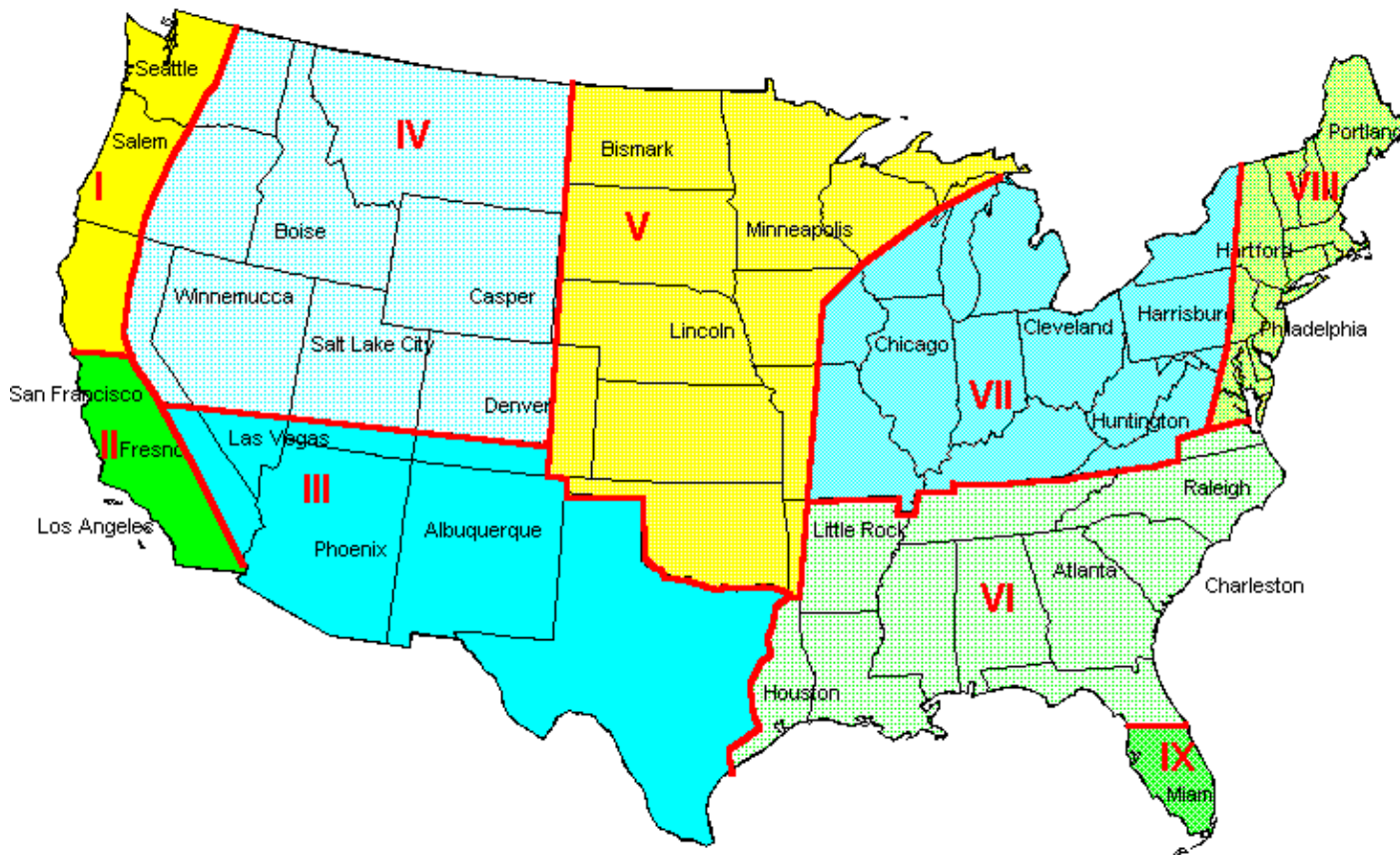

Soil to GW Equations – Dilution Factor

- For residential soil to groundwater, the PRGs can be calculated with one of two methods:
 - Partitioning equation for migration to groundwater: employs default partitioning equation for migration. Dilution factor defaults to 1 for 0.5-acre source.
 - Mass-limit equation for migration to groundwater. Use if all the parameters needed to calculate a dilution factor are available.

Volatilization Factor

- Replaces PEF for tritium (^3H) assessment.
- Default value is $17 \text{ m}^3/\text{kg}$
- VF value is based on steady state model that assumes, on average, ^3H in soil pore water and in air

Groundwater Transport – K_D

- K_D – soil-to-water partition coefficient.
- Accounts for partitioning of contaminants in soil to groundwater migration.
- Use for farmer soil land use in fish, milk, beef, and swine exposure routes.

Radionuclide Decay Constant (λ)

- Residential air, soil, workers, and farmer soil have a decay constant term based on the half-life of the isotope.
- Make realistic PRGs by including contributions from short-lived decay products.
- Should be used to establish the actual degree of equilibrium between parent nuclide and daughters.
- Should use +D values if data is not sufficient to calculate λ .

Area Correction Factor

- Infinite slab assumption – thickness of contaminated zone and its aerial extent are so large that it effectively behaves as if it were infinite in its physical dimensions.
- In practice, soil contaminated to depth $> 15\text{cm}$, aerial extent $> 10,000\text{ m}^2$ creates a radiation field comparable to infinite slab.

Area Correction Factor

- In most residential settings, infinite slab assumption results in an overly conservative PRG.
- ACF used to compensate and adjust source area.
- ACF is variable by isotope, source thickness and area for site-specific analysis.
- PRG calculator has 19 different site area choices. If no size is selected for finite analysis, the ACF for the most protective size is selected.

Residential Generic Outputs

Ambient Air

Isotope	Inhalation Slope Factor (risk/pCi)	Submersion External Exposure Slope Factor (risk/yr per pCi/m ³)	Lambda
K-40	2.22E-10	7.25E-10	5.54E-10

Halflife (years)	Inhalation PRG (pCi/m ³)	External Exposure PRG (pCi/m ³)
1.25E+09	2.80E-02	5.53E+01

Ambient Air PRG (pCi/m ³)	Inhalation PRG (no decay) (pCi/m ³)	External Exposure PRG (no decay) (pCi/m ³)	Ambient Air PRG (no decay) (pCi/m ³)
2.80E-02	2.80E-02	5.53E+01	2.80E-02

Tapwater

Isotope	ICRP Lung Absorption Type	Water Ingestion Slope Factor (risk/pCi)	Inhalation Slope Factor (risk/pCi)
K-40	F	2.47E-11	2.22E-10

Food Ingestion Slope Factor (risk/pCi)	Immersion Slope Factor (risk/yr per pCi/L)	Halflife (days)
3.42E-11	1.56E-12	4.57E+11

λ_i (1/day)	λ_B (1/day)	λ_E (1/day)	Wet Soil-to-plant transfer factor (pCi/g-fresh plant per pCi/g-wet soil)
1.52E-12	2.70E-05	4.95E-02	6.44E-01

Irr _{rup} (L/kg)	Irr _{res} (L/kg)	Irr _{dep} (L/kg)	Ingestion PRG (pCi/L)
2.30E+01	9.29E+00	3.64E+00	2.12E+00

Inhalation PRG (pCi/L)	Immersion PRG (pCi/L)	Produce Consumption PRG (pCi/L)	Total PRG (pCi/L)	Total PRG (mg/L)
-	9.17E+05	1.38E+00	8.35E-01	1.17E-04

Residential Generic Outputs

Soil

Isotope	ICRP Lung Absorption Type	Inhalation Slope Factor (risk/pCi)	External Exposure Slope Factor (risk/yr per pCi/g)	Food Ingestion Slope Factor (risk/pCi)	Soil Ingestion Slope Factor (risk/pCi)
K-40	F	2.22E-10	7.99E-07	3.42E-11	5.85E-11

Particulate Emission or Volatilization factor (m ³ /kg)	Lambda	Halflife (years)	Default Soil Volume Area Correction Factor	Default Soil Volume Gamma Shielding Factor	Wet Soil-to-plant transfer factor (pCi/g-fresh plant per pCi/g-wet soil)
1.36E+09	5.54E-10	1.25E+09	1.00E+00	1.00E+00	6.44E-01

Ingestion PRG (pCi/g)	Inhalation PRG (pCi/g)	External Exposure PRG (pCi/g)	Produce Consumption PRG (pCi/g)	Total PRG (pCi/g)	Total PRG (mg/kg)
1.53E+01	3.80E+04	1.45E-01	5.48E-02	3.97E-02	5.56E-03

Residential Generic Outputs

2D Direct External Exposure

Isotope	External Exposure Slope Factor (risk/yr per pCi/g)	External Exposure Slope Factor (1 cm) (risk/yr per pCi/g)	External Exposure Slope Factor (5 cm) (risk/yr per pCi/g)	External Exposure Slope Factor (15 cm) (risk/yr per pCi/g)
K-40	7.99E-07	1.42E-07	4.09E-07	6.62E-07

Ground Plane External Exposure Slope Factor (risk/yr per pCi/cm ²)	Default Soil Volume Area Correction Factor	Default Ground Plane Area Correction Factor	Default 1 cm Area Correction Factor	Default 5 cm Area Correction Factor	Default 15cm Area Correction Factor
1.42E-07	1.00E+00	1.00E+00	1.00E+00	1.00E+00	1.00E+00

Default Soil Volume Gamma Shielding Factor	Default Ground Plane Gamma Shielding Factor	Default 1 cm Gamma Shielding Factor	Default 5 cm Gamma Shielding Factor	Default 15 cm Gamma Shielding Factor	Default Lambda
1.00E+00	1.00E+00	1.00E+00	1.00E+00	1.00E+00	5.54E-10

Halflife (years)	Soil Volume PRG (pCi/g)	Soil Volume @ 1cm PRG (pCi/g)	Soil Volume @ 5cm PRG (pCi/g)	Soil Volume @ 15cm PRG (pCi/g)	Ground Plane PRG (pCi/cm ²)	Soil Volume PRG (mg/kg)
1.25E+09	1.45E-01	8.17E-01	2.83E-01	1.75E-01	8.12E-01	2.03E-02

Residential Generic Outputs

Soil to Groundwater

Isotope	ICRP Lung Absorption Type	Food Ingestion Slope Factor (risk/pCi)	Water Ingestion Slope Factor (risk/pCi)	Inhalation Slope Factor (risk/pCi)	Immersion Slope Factor (risk/yr per pCi/L)
K-40	F	3.42E-11	2.47E-11	2.22E-10	1.56E-12

Halflife (days)	λ_i (1/day)	λ_B (1/day)	λ_E (1/day)	Wet Soil-to-plant transfer factor (pCi/g-fresh plant per pCi/g-wet soil)	Irr _{rup} (L/kg)	Irr _{res} (L/kg)	Irr _{dep} (L/kg)
4.57E+11	1.52E-12	2.70E-05	4.95E-02	6.44E-01	2.30E+01	9.29E+00	3.64E+00

MCL (pCi/L)	K_d Distribution coefficient (L/kg)	Lambda decay	Ingestion PRG (pCi/L)	Inhalation PRG (pCi/L)	Immersion PRG (pCi/L)	Produce Consumption PRG (pCi/L)	Tap Water PRG (pCi/L)	
1.88E+00	1.30E+01	5.54E-10	1.4403E-8	2.12E+00	-	9.17E+05	1.38E+00	8.35E-01

Total PRG (mg/L)	Groundwater Risk-based Concentration (activity)	Groundwater MCL-based Concentration (activity)	SSL Risk-based (pCi/g)	SSL Risk-based (mg/kg)	SSL MCL-based (pCi/g)	SSL MCL-based (mg/kg)
1.17E-04	8.35E-01	1.88E+00	1.10E-02	1.54E-03	2.49E-02	3.48E-03

Residential Generic Outputs

Fish

Default

Resident PRGs for Contaminated Fish

Isotope	Food Ingestion Slope Factor (risk/pCi)	Ingestion of Fish PRG TR=1.0E-6 (pCi/g)	Ingestion of Fish PRG TR=1.0E-6 (mg/kg)
K-40	3.42E-11	5.95E-02	8.34E-03



Radiation Risk Assessment Calculator Training

Section 4: DCC Calculator



United States
Environmental Protection
Agency

Superfund Radiation Risk
Assessment Calculator Training

DCC Outline

- Background
- Use of Dose Assessment at Superfund Sites
- Development Approach
- Calculator Walkthrough
 - Scenarios
 - Inputs
 - Outputs

DCC Background

- Dose compliance concentrations (DCCs) are isotope activities that correspond to fixed levels of dose.
- Dose conversion factors (DCFs) for a given radionuclide represent the dose equivalent per unit intake or external exposure of that radionuclide.

DCFs

- Used to convert a radionuclide concentration in soil, air, water or foodstuffs to a radiation dose.
- May be specified for specific body organs or tissues of interest, or as a weighted sum of individual organ dose (EDE).
- DCF sets: present DCFs that may be used to calculate either organ DE or EDE for ingestion and inhalation
 - ICRP 30
 - ICRP 60
 - ICRP 107 (ORNL) – based on more recent findings

Radiation Standards

- Standards consist of Effective Dose or Organ Equivalent Dose critical organ dose annual limits
- Equivalent Dose Limits may consider:
 - Specific target tissue or organ (e.g. thyroid)
 - The most radiosensitive tissue or organ
 - Tissue or organ receiving highest dose
- Dose to an organ from internally-deposited radionuclides is generally calculated separately from dose due to external exposure. However, the annual limit is based on the sum of external and internal organ dose.



Dose Assessment in Superfund Sites

- Superfund is **NOT** a dose-based program.
 - Dose assessments should only be conducted under CERCLA when necessary to demonstrate ARAR compliance.
- Dose recommendations (e.g. DOE orders, NRC regulatory guides) should generally not be used as TBCs.

Dose Assessment in Superfund Sites (cont.)

- Dose is not used because dose-based guidance would result in unnecessary inconsistency regarding how radiological and non-radiological (chemical) contaminants are addressed at Superfund sites.
 - Estimates of risk from a given dose estimate may vary by an order of magnitude or more.

Dose Assessment in Superfund Sites (cont.)

- Dose-based guidance generally begins an analysis for determining a site-specific cleanup level at a minimally acceptable risk level rather than the 10^{-6} departure set by NCP.
- ARARs above dose of 12 mrem/yr are not considered sufficiently protective.
 - Do not use to establish cleanup levels.
 - Cleanup levels not based on ARAR should be based on carcinogenic risk range of 10^{-4} to 10^{-6} .



Development Approach – Addressing Radionuclide Background

- Natural background radiation should be considered prior to applying DCCs as cleanup levels.
- Some ARARs are established as increments above background concentrations – obey ARAR procedure.



United States
Environmental Protection
Agency

Superfund Radiation Risk
Assessment Calculator Training

Development Approach – Potential Problems

- To avoid misuse of DCCs, the following should be avoided:
 - Applying DCCs w/out adequate CSM
 - Use of DCCs as cleanup levels w/out considering other relevant criteria
 - Use of DCCs as cleanup levels w/out verifying numbers with a health physicist/risk assessor
 - Use of outdated, superseded DCC tables
 - Not considering effects from presence of multiple isotopes

DCC Calculator Overview

Using the DCC Calculator

Select Scenario

- Resident
- Composite Worker
- Outdoor Worker
- Indoor Worker
- Construction Worker - Standard Unpaved Road Vehicle Traffic (Site-specific only)
- Construction Worker - Wind Erosion and Other Construction Activities (Site-specific only)
- Recreator (Site-specific only)
- Farmer
- Soil to Groundwater

Select Media:

- Soil
- Air
- 2-D External Exposure
- Tap Water
- Fish

Select Units

- pCi
- Bq

Select ICRP rule

- 107 - Center for Radiation Protection Knowledge
- 60/68/72
- 30

Select DCC type

- Defaults
- Site-specific

Select Isotope Info Type: Database defaults ▾

- select-
- Database defaults
- User-provided

Select Dose Output:

- No
- Yes

Select Individual Isotopes

Complete List

Ac-223
Ac-223+D
Ac-223+E
Ac-224
Ac-225
Ac-225+D
Ac-225+E
Ac-226
Ac-227
Ac-228

<< >>

Selected

Common Isotopes

Am-241
Co-60
Cs-137+D
Cs-137+E
H-3
I-129
I-131
Pu-238
Pu-239+E
Pu-240

<< >>

To add an isotope not in the list, select "Site Specific", "User-provided", then "Test Isotope".

Or Select All

ALL

Retrieve

DCC Calculator Walkthrough

- Select exposure scenario
 - Same scenarios as discussed in PRG
- Select DCC type: defaults or site-specific
- Select units: units of activity in pCi or Bq
- Select ICRP rule (170, 60 or 30)
- Select isotopes of interest



Residential SS Inputs

Common Parameters

Parameters Common to all Exposure Route Equations

AAF_a (annual age fraction - resident adult)

unitless

AAF_c (annual age fraction - resident child)

unitless

DL (dose limit) mrem

ED_r (exposure duration - resident) yr

ED_{ra} (exposure duration - resident adult) yr

ED_{rc} (exposure duration - resident child) yr

EF_r (exposure frequency - resident) day/yr

EF_{ra} (exposure frequency - resident adult) day/yr

EF_{rc} (exposure frequency - resident child) day/yr

ET_r (exposure time - resident) hr

ET_{ra} (exposure time - resident adult) hr

ET_{rc} (exposure time - resident child) hr

t_r (time - resident) yr

Residential SS Inputs

Soil- Ingestion, External, Inhalation & Produce

Select a slab size ▾ Slab size for ACF	24	ET_{r-c} (exposure time - resident child) hr/day
Select a soil thickness cover layer ▾ Select cover layer thickness for GSF_o (gamma shielding factor - outdoor)	16.416	ET_{r-i} (exposure time - indoor resident) hr/day
0.77 AAF_a (annual age fraction - resident adult) unitless	1.752	ET_{r-o} (exposure time - outdoor resident) hr/day
0.23 AAF_c (annual age fraction - resident child) unitless	0.4	GSF_i (gamma shielding factor - indoor) unitless
1 DL (dose limit) mrem	6195	IFA_{r-adj} (age-adjusted soil inhalation factor - resident) m^3
26 ED_r (exposure duration - resident) yr	43050	IFS_{r-adj} (age-adjusted soil ingestion factor - resident) mg
20 ED_{r-a} (exposure duration - resident adult) yr	20	IRA_{r-a} (inhalation rate - resident adult) m^3/day
6 ED_{r-c} (exposure duration - resident child) yr	10	IRA_{r-c} (inhalation rate - resident child) m^3/day
350 EF_r (exposure frequency - resident) day/yr	100	IRS_{r-a} (soil intake rate - resident adult) mg/day
350 EF_{r-a} (exposure frequency - resident adult) day/yr	200	IRS_{r-c} (soil intake rate - resident child) mg/day
350 EF_{r-c} (exposure frequency - resident child) day/yr	0.26	MLF (produce plant mass loading factor) unitless
24 ET_{r-a} (exposure time - resident adult) hr/day	26	t_r (time - resident) yr

NOTES:

1. DCF_o =oral ingestion dose conversion factor (mrem/pCi).
2. DCF_i =inhalation dose conversion factor (mrem/pCi).
3. DCF_{ext-sv} =external exposure dose conversion factor (mrem-g/pCi-yr).
4. t_r =time of exposure (yr) = ED_r = ED_{r-c} = ED_{r-a}
5. λ =decay constant
6. Q/C_{wind} =calculations based on site size and climactic zone. Further details on the derivation of Q/C_{wind} can be found in [Appendix D](#)
7. A, B, C = PEF region-specific dispersion constants (unitless)
8. $0 \leq GSF_i \leq 1$

Residential SS Inputs

Produce

Produce Ingestion Parameters

Produce Consumption - direct

CPF_r (contaminated plant fraction) unitless

IFF_{r-adj} (age-adjusted fruit ingestion factor - resident) g

IFV_{r-adj} (age-adjusted vegetable ingestion factor - resident) g

IRF_{r-a} (fruit consumption rate - resident adult) g/day

IRF_{r-c} (fruit consumption rate - resident child) g/day

IRV_{r-a} (vegetable consumption rate - resident adult) g/day

IRV_{r-c} (vegetable consumption rate - resident child) g/day

Residential SS Inputs

Air – External and Inhalation

AAF_a (annual age fraction - resident adult)

unitless

AAF_c (annual age fraction - resident child)

unitless

DL (dose limit) mrem

ED_r (exposure duration - resident) yr

ED_{r-a} (exposure duration - resident adult) yr

ED_{r-c} (exposure duration - resident child) yr

EF_r (exposure frequency) day/yr

EF_{r-a} (exposure frequency - resident adult) day/yr

EF_{r-c} (exposure frequency - resident child) day/yr

ET_r (exposure time - resident) hr

ET_{r-a} (exposure time - resident adult) hr

ET_{r-c} (exposure time - resident child) hr

GSF_a (gamma shielding factor) unitless

IFA_{r-adj} (age-adjusted inhalation factor) m³

IRA_{r-a} (inhalation rate - resident adult) m³/day

IRA_{r-c} (inhalation rate - resident child) m³/day

t_r (time - resident) yr

NOTES:

1. DCF_i=inhalation dose conversion factor (mrem/pCi)
2. DCF_{sub}=submersion dose conversion factor (mrem/pCi)
3. t_r=time of exposure (yr) = ED_r = ED_{r-c} = ED_{r-a}
4. λ=decay constant
5. 0 ≤ GSF_o ≤ 1

Residential SS Inputs

Tapwater – Ingestion, External, Inhalation, & Produce

AAF_a (annual age fraction - resident adult)
unitless

AAF_c (annual age fraction - resident child)
unitless

DFA_{r-adj} (age-adjusted immersion factor - resident) hr

DL (dose limit) mrem

ED_r (exposure duration - resident) yr

ED_{r-a} (exposure duration - resident adult) yr

ED_{r-c} (exposure duration - resident child) yr

EF_{r-a} (exposure frequency - resident adult) day/yr

EF_{r-c} (exposure frequency - resident child) day/yr

ET_{r-a} (exposure time - resident adult) hr

ET_{r-c} (exposure time - resident child) hr

EV_{r-a} (bathing events per day - resident adult)
event/day

EV_{r-c} (bathing events per day - resident child)
event/day

F (irrigation period) unitless

IFA_{r-adj} (age-adjusted inhalation factor - resident)
m³

I_f (interception fraction) unitless

IFW_{r-adj} (adjusted intake factor - resident) L-
yr/kg-day

IRA_{r-a} (inhalation rate - resident adult) m³/day

IRA_{r-c} (inhalation rate - resident child) m³/day

I_r (irrigation rate) L/m²-day

IRW_{r-a} (water intake rate - resident adult) L/day

IRW_{r-c} (water intake rate - resident child) L/day

K (volatilization factor of Andelman) L/m³

λ_{HL} (soil leaching rate) 1/day

MLF (produce plant mass loading factor) unitless

P (area density for root zone) kg/m²

T (translocation factor) unitless

t_{a-event} (duration of bathing event - adult) hr/event

t_b (long term deposition and buildup) day

t_{c-event} (duration of bathing event - child) hr/event

t_v (above ground exposure time) day

t_w (weathering half-life) day

Y_v (plant yield - wet) kg/m²

Residential SS Inputs

Soil – 2-D Analysis

DL (dose limit) mrem

ED_r (exposure duration - resident) yr

EF_r (exposure frequency - resident) day/yr

ET_{r-i} (exposure time - indoor resident) hr/day

ET_{r-o} (exposure time - outdoor resident) hr/day

GSF_i (gamma shielding factor - indoor) unitless

t_r (time - resident) yr

NOTES:

1. Slab size for ACF in alternate external exposure equations is determined by size selected in soil section above
2. DCF_{ext-gp} = ground plane external exposure dose conversion factor (mrem-cm²/pCi-yr).
3. DCF_{ext-sv} = infinite soil volume external exposure dose conversion factor (mrem-g/pCi-yr).
4. $DCF_{ext-1cm}$ = soil volume at 1 cm external exposure dose conversion factor (mrem-g/pCi-yr).
5. $DCF_{ext-5cm}$ = soil volume at 5 cm external exposure dose conversion factor (mrem-g/pCi-yr).
6. $DCF_{ext-15cm}$ = soil volume at 15 cm external exposure dose conversion factor (mrem-g/pCi-yr).
7. t_r = time of exposure (yr) = ED_r
8. λ = decay constant
9. $0 \leq GSF_i \leq 1$



United States
Environmental Protection
Agency

Superfund Radiation Risk
Assessment Calculator Training

Residential SS Inputs

Particulate Emission Factor

$$PEF_w \left(\frac{m^3_{air}}{kg_{soil}} \right) = \frac{Q}{C_{wind}} \left(\frac{\left(\frac{g}{m^2 \cdot s} \right)}{\left(\frac{kg}{m^3} \right)} \right) \times \frac{3,600 \left(\frac{s}{hour} \right)}{0.036 \times (1-V) \times \left(\frac{U_m \left(\frac{m}{s} \right)}{U_t \left(\frac{m}{s} \right)} \right)^3 \times F(x)}$$

$$\text{and: } \frac{Q}{C_{wind}} = A \times \exp \left[\frac{(\ln A_s (\text{acre}) - B)^2}{C} \right]$$

Default City (Climatic Zone) - Selection based on most likely climatic conditions for the site

0.5 A_s (acres)

1359344438 PEF (particulate emission factor) m³/kg

93.77 Q/C_{wp} / inverse of the ratio of the geometric mean air concentration to the emission flux at center of a square source (g/m²-s per kg/m³) PEF Selection

16.2302 A (Dispersion Constant)

18.7762 B (Dispersion Constant)

216.108 C (Dispersion Constant)

0.5 V / fraction of vegetative cover (unitless)

4.69 U_m / mean annual wind speed (m/s)

11.32 U_t / equivalent threshold value (m/s)

0.194 F(x) / function dependant on U_m/U_t derived using Cowherd et al. (1985) (unitless)

Residential SS Inputs

Fish

Resident Exposure to Consumption of Fish

Ingestion Exposure

Fish Ingestion

DL (dose limit) mrem

ED_r (exposure duration - resident) yr

EF_r (exposure frequency - resident) day/yr

IRF_a (fish intake rate - adult) g/day

t_r (time - resident) yr

NOTES:

1. DCF_o=food dose conversion factor (mrem/pCi). rad-specific

Residential SS Inputs

Soil to Groundwater – Dilution Factor

Dilution Factor for Migration to Groundwater	
<u>Dilution Attenuation Factor</u>	
<u>Mixing Zone Depth</u>	
<input type="text" value="1"/> DAF (dilution attenuation factor) unitless	<input type="text" value="."/> d_a (aquifer thickness) m - site-specific
<input type="text" value="."/> K (aquifer hydraulic conductivity) m/yr	<input type="text" value="."/> i (hydraulic gradient) m/m
<input type="text" value="."/> L (source length parallel to ground water flow) m	<input type="text" value="0.18"/> I (infiltration rate) m/yr
<input type="text" value="."/> d (mixing zone depth) m - site-specific	
<p>NOTES:</p> <ol style="list-style-type: none"> 1. The dilution factor (DAF) has a default of 1 for a ≤ 0.5-acre source. 2. If DAF is known, enter it above. Or, to calculate DAF, enter your own site-specific values for the variables in the necessary fields above. 3. When DAF is entered or calculated, the values for the blue DAF boxes in the Migration to Groundwater sections below will be populated. If DAF is not entered or calculated, the default value of 1 will be used. 	

Residential SS Inputs

Soil to Groundwater – Partition Equation

Partitioning Equation for Migration to Groundwater

Method 1

DAF (dilution attenuation factor) unitless

t (time) yr

ρ_b (dry soil bulk density) kg/L

θ_w (water-filled soil porosity) $L_{\text{water}}/L_{\text{soil}}$

NOTES:

1. The Partitioning Equation for Migration to Ground Water is used by default. To use the [Mass-Limit Equation](#), enter values for the required parameters in the section below.
2. The dilution factor (DAF) has a default of 1 for a ≤ 0.5 -acre source.
3. If DAF is known, enter it in the [Dilution Factor](#) section above. When DAF is entered or calculated in the section above, the value for the blue DAF box in this section will be populated. If DAF is not entered or calculated, the default value of 1 will be used.



United States
Environmental Protection
Agency

Superfund Radiation Risk
Assessment Calculator Training

Residential SS Inputs

Soil to Groundwater – Mass Limit

Mass-Limit Equation for Migration to Groundwater

Method 2

DAF (dilution attenuation factor) unitless

ED_{gw} (exposure duration) yr

d_s (depth of source) m - site-specific

ρ_b (dry soil bulk density) kg/L

NOTES:

1. The [Partitioning Equation](#) for Migration to Groundwater above is used by default. To use the Mass-Limit Equation, enter values for ED, d_s, and P_b in this section and enter a value for I in the [Dilution Factor](#) section above.
2. The dilution factor (DAF) has a default of 1 for a <= 0.5-acre source.
3. If DAF is known, enter it in the [Dilution Factor](#) section above. When DAF is entered or calculated in the section above, the value for the blue DAF box in this section will be populated. If DAF is not entered or calculated, the default value of 1 will be used.



United States
Environmental Protection
Agency

Superfund Radiation Risk
Assessment Calculator Training

DCC Residential Generic Output

Soil

Isotope	ICRP Lung Absorption Type	Inhalation DCF (mrem/pCi)	External Exposure DCF (mrem/yr per pCi/g)	Ingestion DCF (mrem/pCi)	Particulate Emission or Volatilization factor (m ³ /kg)
K-40	F	7.77E-6	0.994045	0.0000229	1.36E+09

Lambda (1/yr)	Halflife (years)	1000029 m ² Soil Volume Area Correction Factor	cm Soil Volume Gamma Shielding Factor	Wet Soil-to-plant transfer factor (pCi/g-fresh plant per pCi/g-wet soil)	Ingestion PRG (pCi/g)
5.54E-10	1.25E+09	1.00E+00	1.00E+00	6.44E-01	1.01E+03

Inhalation PRG (pCi/g)	External Exposure PRG (pCi/g)	Produce Consumption PRG (pCi/g)	Total PRG (pCi/g)	Total PRG (mg/kg)
2.82E+07	1.16E-01	2.04E+00	1.10E-01	1.54E-02



United States
Environmental Protection
Agency

Superfund Radiation Risk
Assessment Calculator Training

DCC Residential Generic Output

Air

Isotope	Inhalation DCF (mrem/pCi)	External Exposure DCF (Submersion) (mrem/yr per pCi/m ³)	Lambda (1/yr)	Halflife (years)
K-40	7.77E-6	0.0009243	5.54E-10	1.25E+09

Inhalation PRG (pCi/m ³)	External Exposure PRG (pCi/m ³)	Ambient Air PRG (pCi/m ³)	Inhalation PRG (no decay) (pCi/m ³)	External Exposure PRG (no decay) (pCi/m ³)	Ambient Air PRG (no decay) (pCi/m ³)
2.08E+01	4.34E+01	1.40E+01	2.08E+01	4.34E+01	1.40E+01

Fish

Isotope	Ingestion DCF (mrem/pCi)	Ingestion of Fish PRG DL=1 (pCi/g)	Ingestion of Fish PRG DL=1 (mg/kg)
K-40	0.0000229	8.87E-02	1.24E-02

DCC Residential Generic Output

Tapwater

Isotope	ICRP Lung Absorption Type	Water Ingestion DCF (mrem/pCi)	Inhalation DCF (mrem/pCi)	Ingestion DCF (mrem/pCi)	Immersion DCF (mrem/yr per pCi/L)
K-40	F	-	7.77E-06	2.29E-05	1.96E-06

Halflife (days)	λ_i (1/day)	λ_B (1/day)	λ_E (1/day)	Wet Soil-to-plant transfer factor (pCi/g-fresh plant per pCi/g-wet soil)	Irr_{rup} (L/kg)	Irr_{res} (L/kg)	Irr_{dep} (L/kg)
4.57E+11	1.52E-12	2.70E-05	4.95E-02	6.44E-01	2.30E+01	9.29E+00	3.64E+00

Ingestion PRG (pCi/L)	Inhalation PRG (pCi/L)	Immersion PRG (pCi/L)	ingpp	Produce Consumption PRG (pCi/L)	Total PRG (pCi/L)	Total PRG (mg/L)
-	-	1.90E+07	1.8475483	5.14E+01	5.14E+01	7.20E-03



DCC Residential Generic Output

2-D

Isotope	External Exposure DCF (mrem/yr per pCi/g)	External Exposure DCF (1 cm) (mrem/yr per pCi/g)	External Exposure DCF (5 cm) (mrem/yr per pCi/g)	External Exposure DCF (15 cm) (mrem/yr per pCi/g)
K-40	0.994045	0.177175	0.50355	0.8206

External Exposure DCF (Ground Plane) (mrem/yr per pCi/cm ²)	1000029 m ² Soil Volume Area Correction Factor	1000029 m ² Ground Plane Area Correction Factor	1000029 m ² 1 cm Area Correction Factor	1000029 m ² 5 cm Area Correction Factor	1000029 m ² 15cm Area Correction Factor
0.238068	1.00E+00	1.00E+00	1.00E+00	1.00E+00	1.00E+00

cm Soil Volume Gamma Shielding Factor	cm Ground Plane Gamma Shielding Factor	cm 1 cm Gamma Shielding Factor	cm 5 cm Gamma Shielding Factor	cm 15 cm Gamma Shielding Factor	Lambda	Halflife (years)
1.00E+00	1.00E+00	1.00E+00	1.00E+00	1.00E+00	5.54E-10	1.25E+09

Soil Volume PRG (pCi/g)	Soil Volume @ 1cm PRG (pCi/g)	Soil Volume @ 5cm PRG (pCi/g)	Soil Volume @ 15cm PRG (pCi/g)	Ground Plane PRG (pCi/cm ²)	Soil Volume PRG (mg/kg)
1.47E+00	8.25E+00	2.90E+00	1.78E+00	6.14E+00	2.06E-01

DCC Residential Generic Output

Soil to Groundwater

Isotope	ICRP Lung Absorption Type	Ingestion DCF (mrem/pCi)	Water Ingestion DCF (mrem/pCi)	Inhalation DCF (mrem/pCi)	Immersion DCF (mrem/yr per pCi/L)
K-40	F	2.29E-05	-	7.77E-06	1.96E-06

Halflife (days)	λ_i (1/day)	λ_B (1/day)	λ_E (1/day)	Wet Soil-to-plant transfer factor (pCi/g-fresh plant per pCi/g-wet soil)	Irr_{rup} (L/kg)	Irr_{res} (L/kg)	Irr_{dep} (L/kg)
4.57E+11	1.52E-12	2.70E-05	4.95E-02	6.44E-01	2.30E+01	9.29E+00	3.64E+00

MCL (pCi/L)	Distribution coefficient (L/kg)	Lambda (1/yr)	decay	Ingestion PRG (pCi/L)	Inhalation PRG (pCi/L)	Immersion PRG (pCi/L)
1.88E+00	1.30E+01	5.54E-10	1.4403E-8	-	-	7.32E+05

Produce Consumption PRG (pCi/L)	Tap Water PRG (pCi/L)	Total PRG (mg/L)	Groundwater Risk-based Concentration (activity)	Groundwater MCL-based Concentration (activity)	SSL Risk-based (pCi/g)	SSL Risk-based (mg/kg)	SSL MCL-based (pCi/g)	SSL MCL-based (mg/kg)
2.05E+00	2.05E+00	2.88E-04	2.05E+00	1.88E+00	2.71E-02	3.80E-03	2.49E-02	3.48E-03



Radiation Risk Assessment Calculator Training

Section 5: RSL for Total Uranium



United States
Environmental Protection
Agency

Superfund Radiation Risk
Assessment Calculator Training

RSL Calculator Inputs

http://epa-prgs.ornl.gov/cgi-bin/chemicals/csl_search

Using the RSL Calculator

Select Scenario

- Resident
- Composite Worker (presented in Generic Tables)
- Construction Worker (RSL only)
- Indoor Worker (RSL only)
- Outdoor Worker RSL only
- Fish (RSL only)
- Soil to Groundwater (RSL only)
- Recreator (Site Specific RSL only)

Select Media: Select RfD/RfC Type:

- Soil
- Air Chronic
- Tapwater Subchronic

Select SL type

- Defaults
- Site Specific

Select Risk Output:

- No
- Yes

Select Individual Chemicals

ALAR (1596845)
Acenaphthene (83329)
Acenaphthylene (208968)
Acephate (30560191)
Acetaldehyde (75070)
Acetochlor (34256821)
Acetone (67641)
Acetone Cyanohydrin (75865)
Acetonitrile (75058)
Acetophenone (98862)
Acetylaminofluorene, 2- (53963)
Acifluorfen (50594666)

Or Select Individual CAS Numbers

50000
50328
50293
50011
51752
51365
51365
51796
51285
52857
53703
53963

<< >>

Selected

<< >>

To add a chemical not in the list, select "Site Specific", "User-provided", then "Test Chemical".

Or Select All

ALL

Include Metadata

Yes

Retrieve

RSL SS Parameters - soil

Age Segment (yr)	AF (mg/cm ²)	BW (kg)	ED (yr)	EF (day/yr)	ET (hr/event)	IRS (mg/day)	SA (cm ² /day)
0-2	0.2	15	2	350	24	200	2373
2-6	0.2	15	4	350	24	200	2373
6-16	0.07	80	10	350	24	100	6032
16-26	0.07	80	10	350	24	100	6032
Child (0-6)	0.2	15	6	350	24	200	2373
Adult (6-26)	0.07	80	20	350	24	100	6032

RSL SS Parameters - air

Inhalation Exposure

[Air Carcinogenic Inhalation](#)

[Air Carinogenic-\(Vinyl Chloride\) Inhalation](#)

[Air Non-Carcinogenic Inhalation](#)

ED_r (exposure duration - resident) year

EF_r (exposure frequency) day/year

ET_r (exposure time) hour/day

THQ (target hazard quotient) unitless

LT (lifetime - resident) year

TR (target cancer risk) unitless

NOTES:

1. Input fields with a "pink" background are a required entry.
2. Input fields with a "blue" background are calculated dynamically.
3. IUR=inhalation unit risk ($\mu\text{g}/\text{m}^3$)⁻¹. chemical-specific
4. RfC=inhalation reference concentration (mg/m^3). chemical-specific

RSL SS Parameters - tapwater

Exposure Assessment Details							
Age Segment (yr)	BW (kg)	ED (yr)	EF (day/yr)	ET (hr/event)	EV (events/day)	IRW (L/day)	SA (cm ²)
0-2	15	2	350	0.54	1	0.78	6378
2-6	15	4	350	0.54	1	0.78	6378
6-16	80	10	350	0.71	1	2.5	20900
16-26	80	10	350	0.71	1	2.5	20900
Child (0-6)	15	6	350	0.54	1	0.78	6378
Adult (6-26)	80	20	350	0.71	1	2.5	20900

RSL SS Output - soil

Chemical	CAS Number	Mutagen?	VOC?	Ingestion SF (mg/kg-day) ⁻¹	SFO Ref	Inhalation Unit Risk (ug/m ³) ⁻¹	IUR Ref
Uranium (Soluble Salts)	NA	No	No	-		-	

Chronic RfD (mg/kg-day)	Chronic RfD Ref	Chronic RfC (mg/m ³)	Chronic RfC Ref	GIABS	ABS	RBA	Particulate Emission Factor (m ³ /kg)
3.00E-03	I	4.00E-05	A	1	-	1	1.36E+09

Ingestion SL TR=1.0E-6 (mg/kg)	Dermal SL TR=1.0E-6 (mg/kg)	Inhalation SL TR=1.0E-6 (mg/kg)	Carcinogenic SL TR=1.0E-6 (mg/kg)	Ingestion SL Child HQ=1 (mg/kg)	Dermal SL Child HQ=1 (mg/kg)	Inhalation SL Child HQ=1 (mg/kg)	Noncarcinogenic SL Child HI=1 (mg/kg)
-	-	-	-	2.35E+02	-	5.67E+04	2.34E+02

RSL SS Output - air

Chemical	CAS Number	Mutagen?	VOC?	Inhalation Unit Risk (ug/m ³) ⁻¹	IUR Ref	Chronic RfD (mg/kg-day)
Uranium (Soluble Salts)	NA	No	No	-		3.00E-03

Chronic RfC (mg/m ³)	Chronic RfC Ref	Carcinogenic SL TR=1.0E-6 (ug/m ³)	Noncarcinogenic SL HI=1 (ug/m ³)	Screening Level (ug/m ³)
4.00E-05	A	-	4.17E-02	4.17E-02 nc

RSL SS Output - tapwater

Chemical		CAS Number	Mutagen?	VOC?	Chemical Type	Ingestion SF (mg/kg-day) ⁻¹	SFO Ref			
Uranium (Soluble Salts)		NA	No	No	Inorganics	-				
Chronic RfD (mg/kg-day)	RfD Ref	Chronic RfC (mg/m ³)	RfC Ref	GIABS	K _p (cm/hr)	MW	B (unitless)	t (hr)	τ _{event} (hr/event)	FA (unitless)
3.00E-03	I	4.00E-05	A	1	0.001	238.03	0.0059339	5.4328535	2.2636889	1
In EPD?	DA _{event} (ca)	DA _{event} (nc child)	DA _{event} (nc adult)	MCL ug/L						
Yes	-	0.0073579	0.0119754	3.00E+01						
Ingestion SL Child HQ=1 (µg/L)	Dermal SL Child HQ=1 (µg/L)	Inhalation SL Child HQ=1 (µg/L)	Noncarcinogenic SL Child HI=1 (µg/L)	Ingestion SL Adult HQ=1 (µg/L)	Dermal SL Adult HQ=1 (µg/L)	Inhalation SL Adult HQ=1 (µg/L)	Noncarcinogenic SL Adult HI=1 (µg/L)			
6.02E+01	1.36E+04	-	5.99E+01	1.00E+02	1.69E+04	-	9.95E+01			



Radiation Risk Assessment Calculator Training

Section 6: BPRG and BDCC Calculators



United States
Environmental Protection
Agency

Superfund Radiation Risk
Assessment Calculator Training

BPRG Background

- Establish 10^{-6} risk-based PRGs inside radioactively contaminated buildings.
- Presented for settled dust and fixed 3D external exposure for residents and indoor workers.
- Based on default exposure parameters, RME conditions.
- BPRGs in both activity and mass units.
- CSFs from ORNL.

Building Calculator Walkthrough

- Scenarios
 - Residential
 - Commercial/industrial indoor worker
- Exposure pathways
 - Settled dust
 - Ambient air
 - 3D direct external exposure to contaminated building materials
 - 3D direct external exposure to settled dust on indoor surface

BDCC Background

- Establish DCCs inside radioactively contaminated buildings.
- Calculate RME concentrations from standardized equations that combine exposure and toxicity info in the form of DCFs.
- Choice of ICRP 30, 60 and 107 DCFs.
- Same exposure scenarios and pathways as BPRG.

Example CSM – BPRG and BDCC

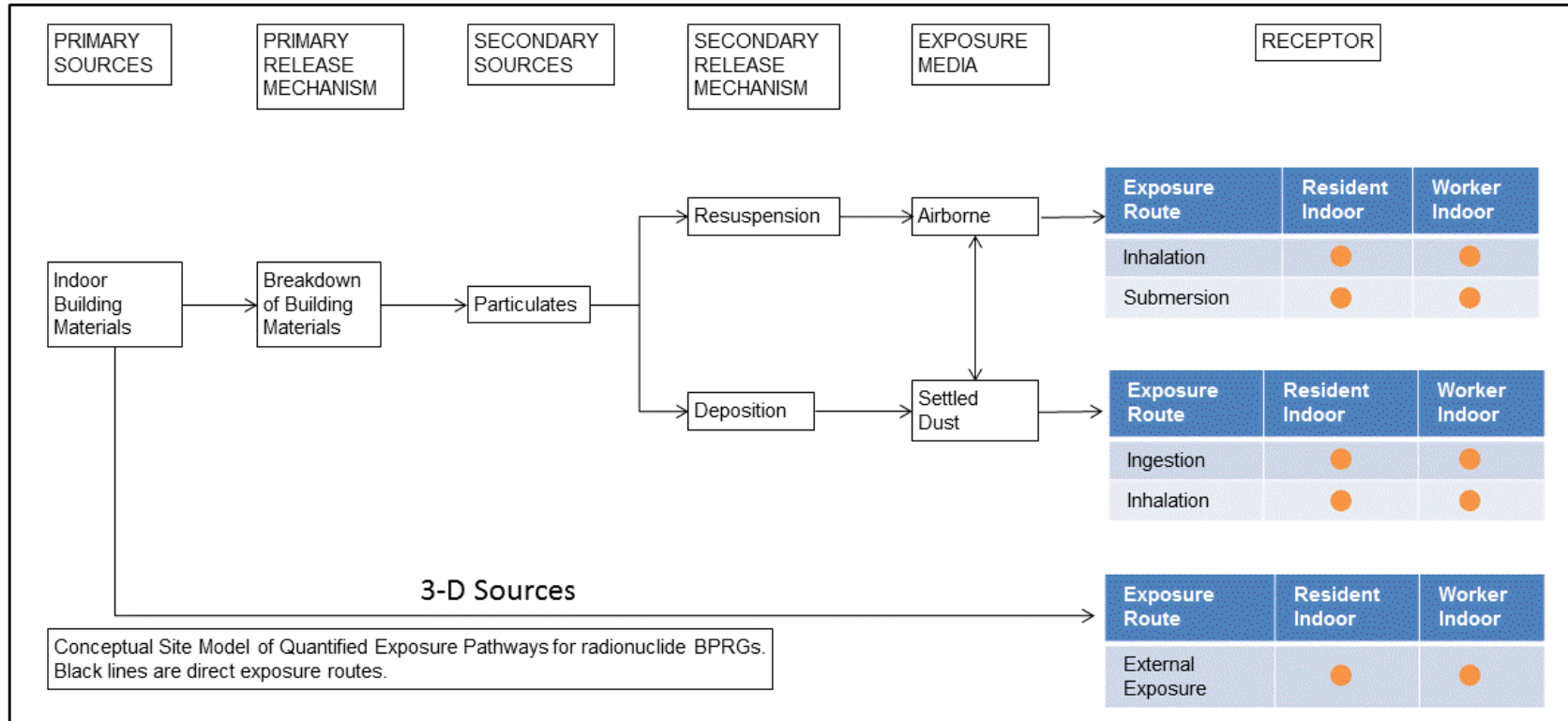

BPRG Calculator Overview

Using the BPRG Calculator

Select Scenario

- Resident
 Indoor Worker

Select Media:

- Dust
 Air
 3-D External Exposure

Select Units

- pCi
 Bq

Select BPRG type

- Defaults
 Site-specific

Select Risk Output:

- No
 Yes

Select Individual Isotopes

Complete List

Ac-223
Ac-223+D
Ac-224
Ac-225
Ac-225+D
Ac-226
Ac-227
Ac-228
Ac-230
Ac-231



Selected

Common Isotopes

Am-241
Co-60
Cs-137+D
H-3
I-129
I-131
Pu-238
Pu-239+D
Pu-240
Ra-226+D



To add an isotope not in the list, select "Site Specific", "User-provided", then "Test Isotope".

Or Select All

ALL

Retrieve

BDCC Calculator Overview

Using the BDCC Calculator

Select Scenario

- Resident
 Indoor Worker

Select Media:

- Dust
 Air
 3-D External Exposure

Select BDCC Type

- Defaults
 Site-specific

Select Dose Output:

- No
 Yes

Select Units

- pCi
 Bq

Select ICRP rule

- 107 - Center for Radiation Protection Knowledge
 60/68/72
 30

Select Individual Isotopes

Complete List

Ac-223
Ac-223+D
Ac-223+E
Ac-224
Ac-225
Ac-225+D
Ac-225+E
Ac-226
Ac-227
Ac-228

Selected



Common Isotopes

Am-241
Co-60
Cs-137+E
H-3
I-129
I-131
Pu-238
Pu-239+E
Pu-240
Ra-226+E



To add an isotope not in the list, select "Site Specific", "User-provided", then "Test Isotope".

Or Select All

- ALL

Retrieve

Residential Settled Dust

- Exposure to radionuclides in settled dust on indoor surfaces.
- Two exposure routes
 - External exposure
 - Ingestion: occurs when hands contact dust-laden surface, then come in contact with mouth
- Variation allowed for hard and soft surfaces, as transfer to skin varies by surface type.



Residential Settled Dust

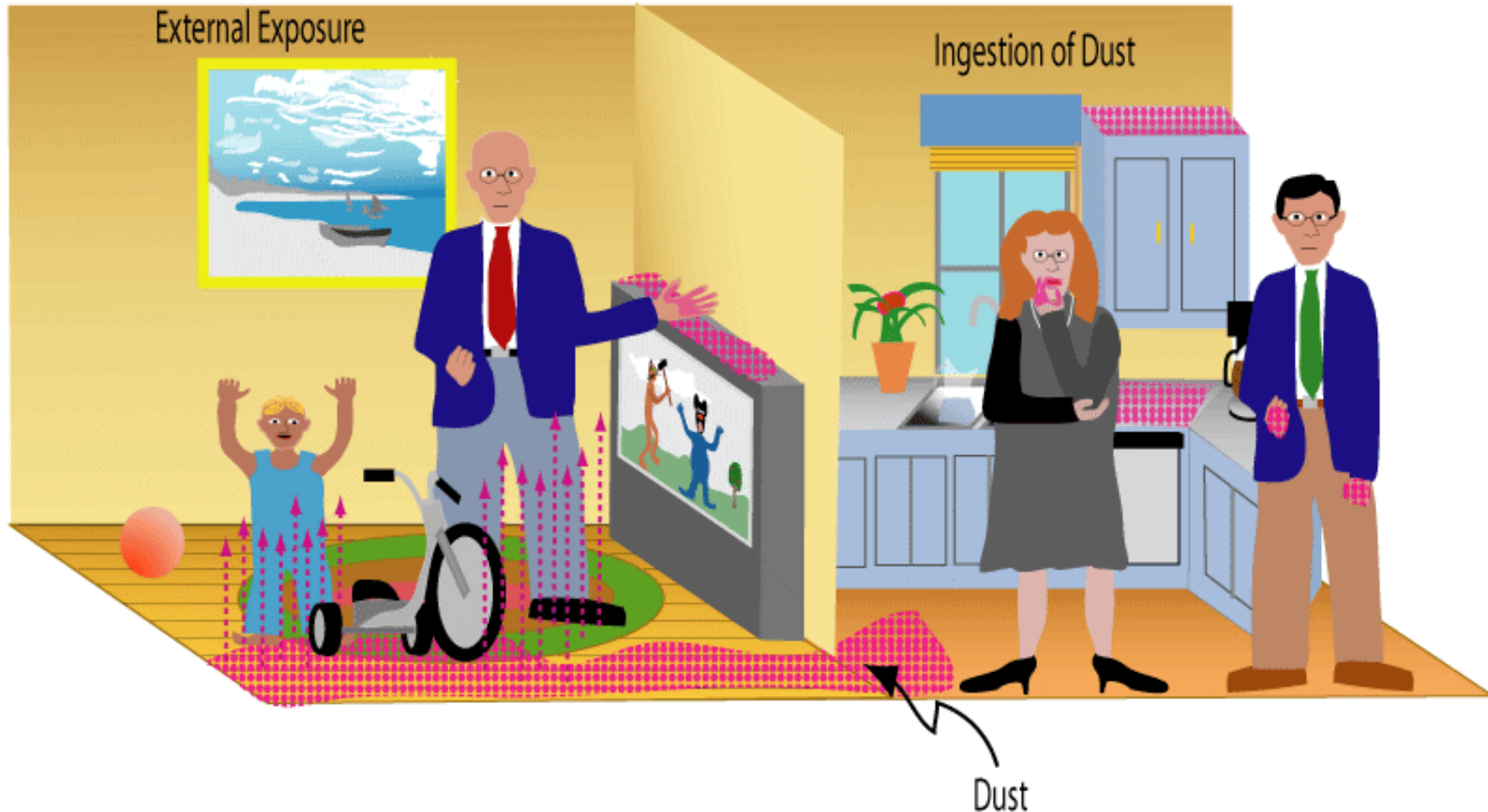

Residential SS Input Settled Dust on Surfaces

◆ Combined Ingestion and Ground Plane External Exposure

<input type="text" value="26"/>	ED _r (exposure duration - resident) yr	<input type="text" value="1"/>	F _{in} (fraction time spent indoors) unitless
<input type="text" value="20"/>	ED _{r-a} (exposure duration - resident adult) yr	<input type="text" value="1"/>	F _{OFF-SET} (off-set factor) unitless
<input type="text" value="6"/>	ED _{r-c} (exposure duration - resident child) yr	<input type="text" value="3"/>	FQ _a (frequency of hand to mouth - adult) event/hr
<input type="text" value="350"/>	EF _r (exposure frequency - resident) day/yr	<input type="text" value="17"/>	FQ _c (frequency of hand to mouth - child) event/hr
<input type="text" value="350"/>	EF _{r-a} (exposure frequency - resident adult) day/yr	<input type="text" value="0.5"/>	FTSS _h (fraction transferred surface to skin - hard surface) unitless
<input type="text" value="350"/>	EF _{r-c} (exposure frequency - resident child) day/yr	<input type="text" value="0.1"/>	FTSS _s (fraction transferred surface to skin - soft surface) unitless
<input type="text" value="24"/>	ET _r (exposure time) hr/day	<input type="text" value="3200400"/>	IFD _{r-adj} (age-adjusted dust ingestion rate - resident) cm ²
<input type="text" value="6"/>	ET _{r-a,h} (exposure time - resident adult hard surface) hr/day	<input type="text" value="0.0"/>	k (dissipation rate constant) yr ⁻¹
<input type="text" value="6"/>	ET _{r-c,h} (exposure time - resident child hard surface) hr/day	<input type="text" value="49"/>	SA _{r-a} (surface area of fingers - resident adult) cm ²
<input type="text" value="10"/>	ET _{r-a,s} (exposure time - resident adult soft surface) hr/day	<input type="text" value="16"/>	SA _{r-c} (surface area of fingers - resident child) cm ²
<input type="text" value="10"/>	ET _{r-c,s} (exposure time - resident child soft surface) hr/day	<input type="text" value="0.5"/>	SE (saliva extraction factor) unitless
<input type="text" value="1"/>	F _{AM} (area and material factor) unitless	<input type="text" value="26"/>	t _r (time - resident) yr
<input type="text" value="1"/>	F _i (fraction of time spent in compartment) unitless	<input type="text" value="1.0E-6"/>	TR (target cancer risk) unitless



Residential SS Input Settled Dust on Surfaces (cont.)

NOTES:

1. SF_{d-oral} =oral slope factor (risk/pCi) - radionuclide-specific
2. SF_{d-ext} =ground-plane external exposure slope factor (risk/yr per pCi/cm²) - radionuclide-specific
3. $ED_r = t_r = ED_{r-c} + ED_{r-a}$
4. λ =decay constant - radionuclide-specific
5. When $k = 0$, the dissipation term is not included in the calculation to prevent division by zero which would result a BPRG of zero.



United States
Environmental Protection
Agency

Superfund Radiation Risk
Assessment Calculator Training

Residential Ambient Air

- Exposure routes
 - Inhalation: assumed to occur for entire 24-hr day
 - Submersion: external exposure to contaminated air

Residential Ambient Air

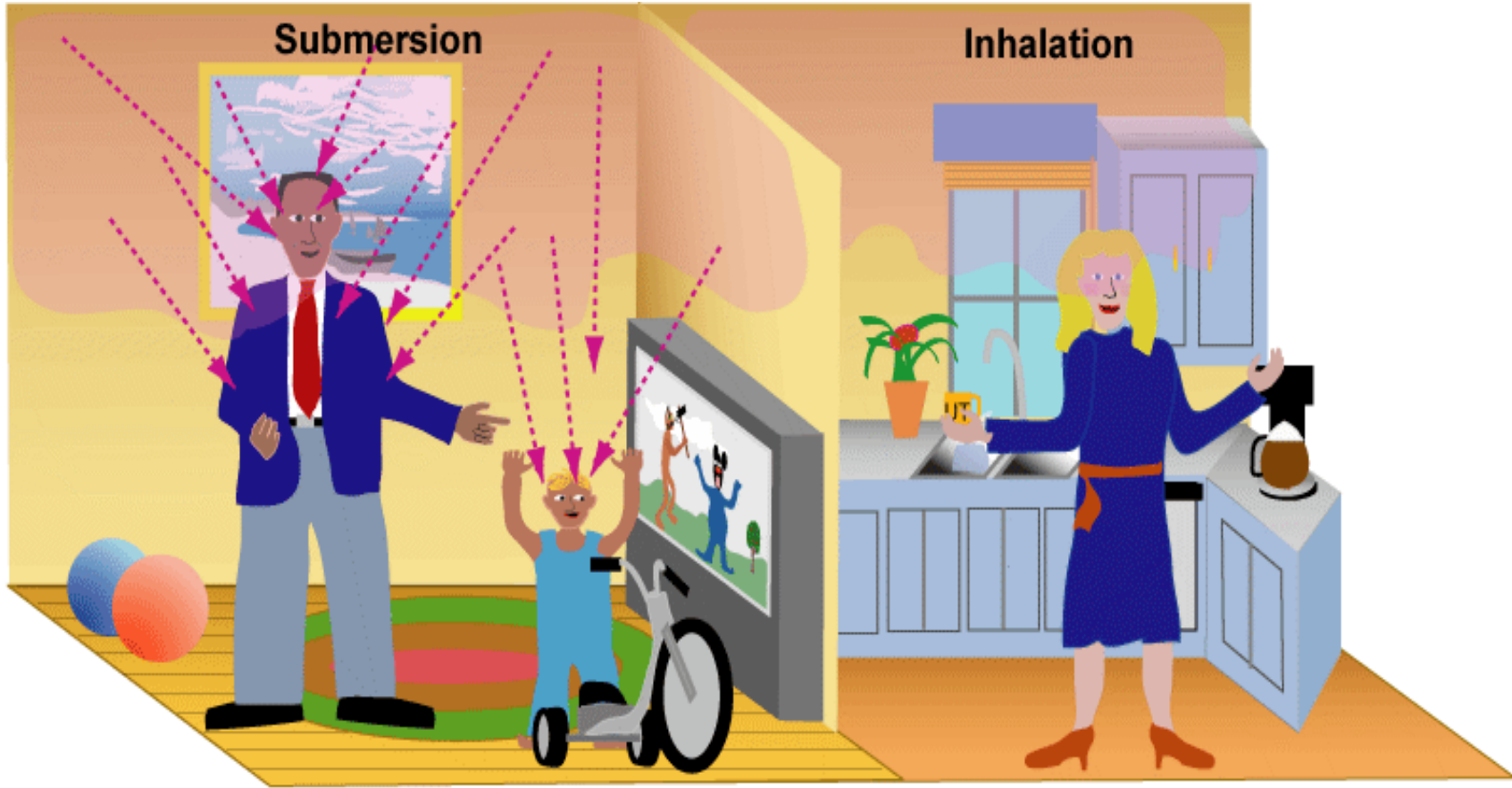

Residential SS Inputs

Ambient Air

◆ Combined Inhalation & Submersion External Exposure

ED_r (exposure duration - resident) yr

ED_{r-a} (exposure duration - resident adult) yr

ED_{r-c} (exposure duration - resident child) yr

EF_r (exposure frequency - resident) day/yr

EF_{r-a} (exposure frequency - resident adult) day/yr

EF_{r-c} (exposure frequency - resident child) day/yr

ET_r (exposure time - resident) hr

ET_{r-a} (exposure time - resident adult) hr

ET_{r-c} (exposure time - resident child) hr

F_i (fraction of time spent in compartment)

unitless

F_{in} (fraction of time spent indoors) unitless

GSF_a (gamma shielding factor - air) unitless

IFA_{r-adj} (age-adjusted inhalation rate - resident) m^3

IRA_{r-a} (inhalation rate - resident adult) m^3/day

IRA_{r-c} (inhalation rate - resident child) m^3/day

t_r (time - resident) yr

TR (target cancer risk) unitless

NOTES:

1. SF_i =inhalation slope factor (risk/pCi) - radionuclide-specific
2. SF_{sub} =submersion external exposure slope factor (risk/yr per pCi/ m^3) - radionuclide-specific
3. $ED_r = t_r = ED_{r-c} + ED_{r-a}$
4. λ =decay constant - radionuclide-specific

Res 3D Direct Ext Exposure to Contaminated Building Materials

- Direct external exposure to radionuclides in building materials of walls and floors.
- Uses 4 source thickness volume slope factors.

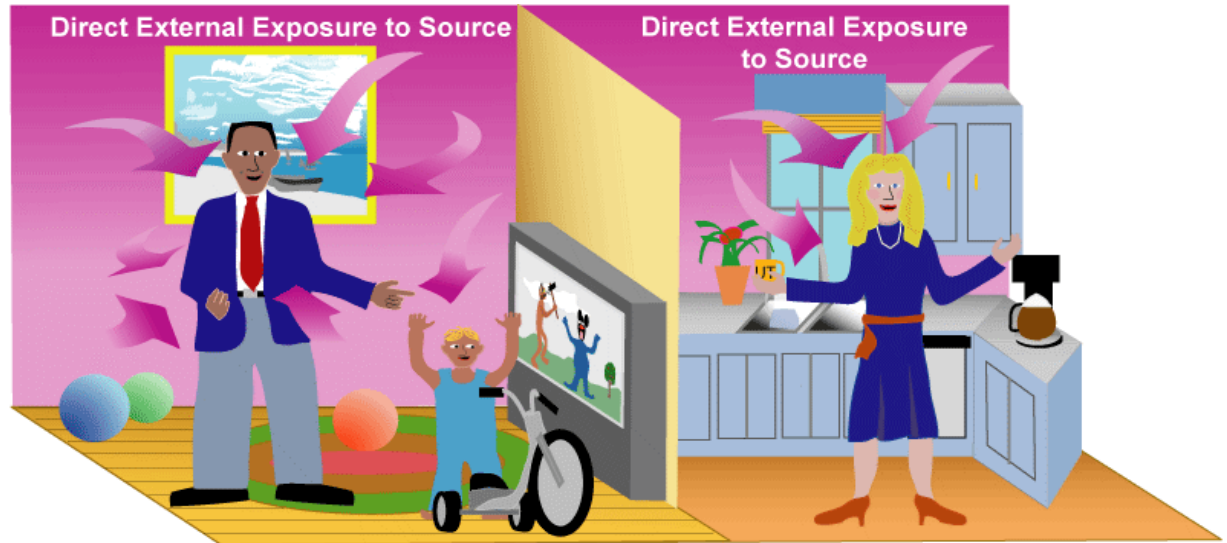

Res 3D Direct Ext Exposure to Settled Dust on Indoor Surfaces

- Direct external exposure to radionuclides in settled dust on floors and walls.
- Uses ground plane slope factors.



Residential SS Input

3D Direct External Exposure

◆ Soil Volume & Ground Plane External Exposure

<input type="text" value="26"/>	ED _{res} (exposure duration – resident) yr	<input type="text" value="1"/>	GSF _b (building gamma shielding factor) unitless
<input type="text" value="350"/>	EF _{res} (exposure frequency) day/yr	Select a room material ▼	Select room material
<input type="text" value="24"/>	ET _{res} (exposure time – resident) hr/day	Select a room position ▼	Select room position
<input type="text" value="1"/>	F _{am} (area and materials factor) unitless	Select a room size ▼	Select room size (ft)
<input type="text" value="1"/>	F _i (fraction of time spent in compartment) unitless	<input type="text" value="26"/>	t _{res} (time – resident) yr
<input type="text" value="1"/>	F _{in} (fraction time spent indoors) unitless	<input type="text" value="1.0E-6"/>	TR (target cancer risk) unitless
<input type="text" value="1"/>	F _{OFF-SET} (off-set factor) unitless		

NOTES:

1. SF_{ext-gp}=ground plane external exposure slope factor (risk-cm²/pCi-yr)
2. SF_{ext-sv}=infinite soil volume external exposure slope factor (risk-g/pCi-yr)
3. SF_{ext-1cm}=soil volume at 1 cm external exposure slope factor (risk-g/pCi-yr)
4. SF_{ext-5cm}=soil volume at 5 cm external exposure slope factor (risk-g/pCi-yr)
5. SF_{ext-15cm}=soil volume at 15 cm external exposure slope factor (risk-g/pCi-yr)
6. ED_{res} = t_{res}
7. λ=decay constant
8. F_{SURF}=Ratio of the dose rate in the room to that for an infinite plane source
9. Composite 1 room material = drywall room, glass window, wooden doors, drywall walls, concrete floor, drywall ceiling
10. Composite 2 room material = concrete room, wooden doors, concrete floor, drywall ceiling

Indoor Worker Settled Dust



Indoor Worker Ambient Air



IW 3D Direct Ext Exposure to Contaminated Building Materials

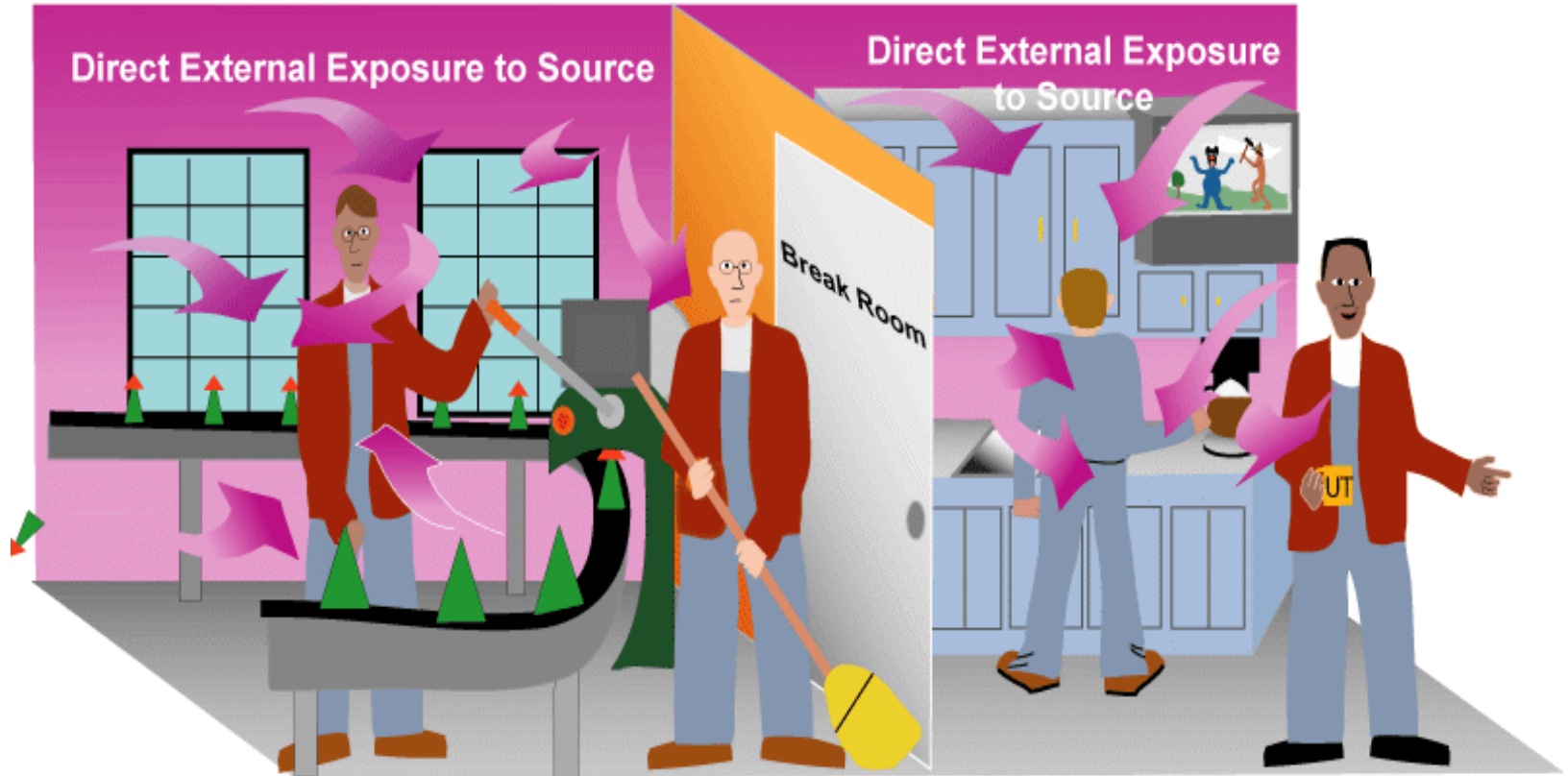

IW 3D Direct Ext Exposure to Settled Dust on Indoor Surfaces



BPRG Residential Generic Output

Settled Dust

Radionuclide	Soil Ingestion Slope Factor (risk/pCi)	External Exposure Slope Factor (Ground Plane) (risk/yr per pCi/cm ²)
K-40	5.85E-11	1.42E-07

Lambda	Dissipation	Decay	Halflife (years)
5.54E-10	1	1.4403E-8	1.25E+09

Ingestion BPRG (pCi/cm ²)	External Exposure BPRG (pCi/cm ²)	Dust BPRG (pCi/cm ²)	Dust BPRG (mg/cm ²)
5.34E-03	2.82E-01	5.25E-03	7.35E-07

Ambient Air

Radionuclide	Inhalation Slope Factor (risk/pCi)	External Exposure Slope Factor (Submersion) (risk/yr per pCi/m ³)
K-40	2.22E-10	7.25E-10

Lambda	Halflife (years)	Inhalation BPRG (pCi/m ³)	External Exposure BPRG (pCi/m ³)
5.54E-10	1.25E+09	2.80E-02	5.53E+01

Ambient Air BPRG (pCi/m ³)	Ambient Air BPRG (mg/m ³)	Inhalation BPRG (no decay) (pCi/m ³)
2.80E-02	3.92E-06	2.80E-02

External Exposure BPRG (no decay) (pCi/m ³)	Ambient Air BPRG (no decay) (pCi/m ³)	Ambient Air BPRG (no decay) (mg/m ³)
5.53E+01	2.80E-02	3.92E-06

BPRG Residential Generic Output

3D Direct External Exposure

Radionuclide	Soil Volume External Exposure Slope Factor (risk/yr per pCi/g)	External Exposure Slope Factor (Ground Plane) (risk/yr per pCi/cm ²)	Soil Volume External Exposure Slope Factor (1 cm) (risk/yr per pCi/g)	Soil Volume External Exposure Slope Factor (5 cm) (risk/yr per pCi/g)
K-40	7.99E-07	1.42E-07	1.42E-07	4.09E-07

Soil Volume External Exposure Slope Factor (15 cm) (risk/yr per pCi/g)	F _{SURF}	Lambda	Half-life (years)	3-D External Soil Volume BPRG (pCi/g)	3-D External Ground Plane BPRG (pCi/cm ²)
6.62E-07	1.01	5.54E-10	1.25E+09	4.97E-02	2.79E-01

3-D External Soil Volume BPRG (1 cm) (pCi/g)	3-D External Soil Volume BPRG (5 cm) (pCi/g)	3-D External Soil Volume BPRG (15 cm) (pCi/g)	3-D External Soil Volume BPRG (mg/kg)	3-D External Ground Plane BPRG (mg/kg)
2.80E-01	9.71E-02	6.00E-02	6.97E-03	3.91E-05

3-D External Soil Volume BPRG (1 cm) (mg/kg)	3-D External Soil Volume BPRG (5 cm) (mg/kg)	3-D External Soil Volume BPRG (15 cm) (mg/kg)
3.93E-02	1.36E-02	8.40E-03

BPRG & BDCC What's next

- ◆ Source Thickness will be added to the surface factors.
- ◆ Multiple materials will be available for user to select.
- ◆ A composite room will be added that consists of glass, drywall, steel and concrete.



Radiation Risk Assessment Calculator Training

Section 7: SPRG and SDCC Calculators



United States
Environmental Protection
Agency

Superfund Radiation Risk
Assessment Calculator Training

SPRG Background

- ◆ Establish 10^{-6} risk-based PRGs for radioactively contaminated outside hard surfaces.
 - Examples: street slabs, pavement, sidewalks, and sides of buildings.
- ◆ Standardized SPRGs based on default exposure parameters and incorporate exposure factors that present RME conditions.

Exposure

- ◆ Scenarios: residential, outdoor worker, indoor worker
- ◆ Pathways
 - Settled dust on outdoor surfaces
 - 3D direct external exposure to fixed contaminated building materials
 - 3D direct external exposure to fixed settled dust on outdoor surfaces
 - 2D direct external exposure to fixed contaminated finite slabs
 - 2D direct external exposure to settled dust on finite slabs

SDCC Background

- ◆ Establish DCCs based on RMEs for contaminated outside hard surfaces.
- ◆ Choice of ICRP 30, 60 and 107 DCFs.
- ◆ Same exposure scenarios and pathways as SPRG.

Example CSM – SPRG and SDCC

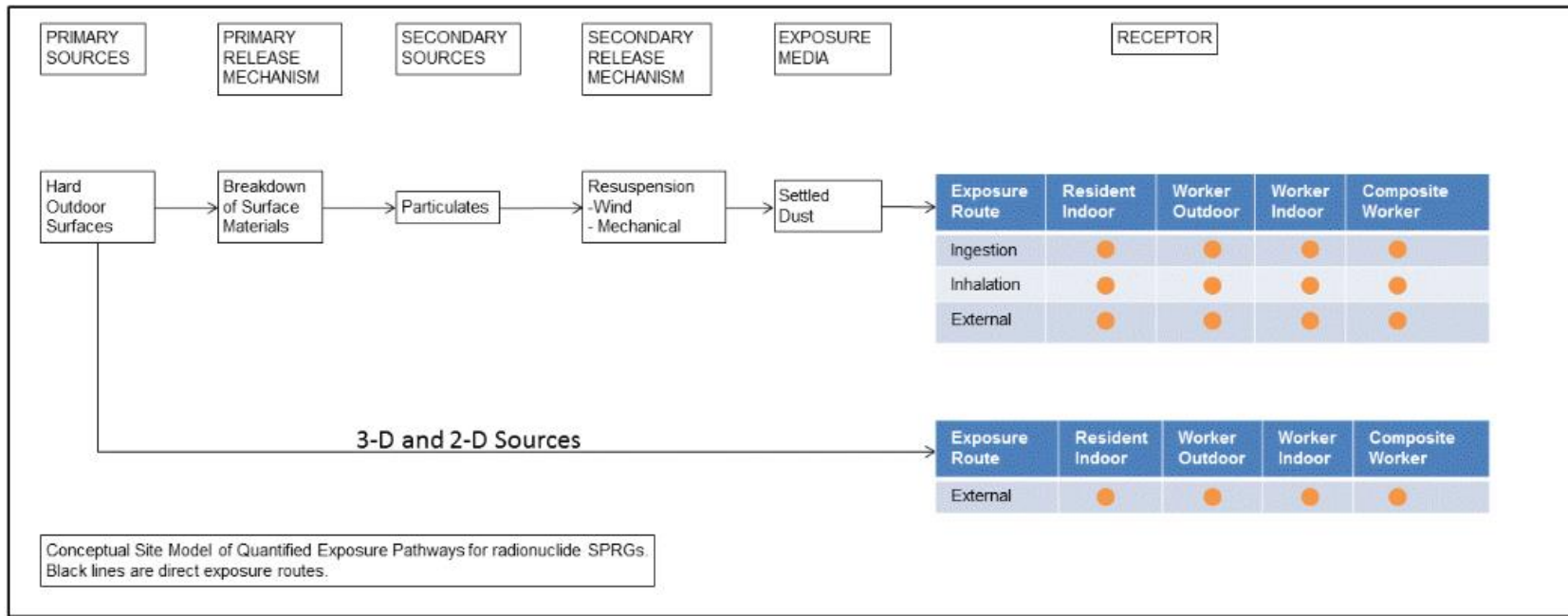

SDCC Calculator

- ◆ Permits SDCC calculations using default values, site-specific, and state values.
- ◆ State values permit more specific calculations in absence of site-specific information.
 - Select most likely road conditions based on state, location (urban or rural), and road type.

SPRG Calculator Overview

Using the SPRG Calculator

Select Scenario

- Residential
- Composite Worker
- Outdoor Worker
- Indoor Worker

Select Media:

- Dust
- 3-D External Exposure
- 2-D External Exposure

Select SPRG type

- Defaults
- State
- Site-specific

Select Risk Output:

- No
- Yes

Select Units

- PCi
- Bq

Select Individual Isotopes

Complete List

Ac-223
Ac-223+D
Ac-224
Ac-225
Ac-225+D
Ac-226
Ac-227
Ac-228
Ac-230
Ac-231

Common Isotopes

Am-241
Co-60
Cs-137+D
H-3
I-129
I-131
Pu-238
Pu-239+D
Pu-240
Ra-226+D

Selected



To add an isotope not in the list, select "Site Specific", "User-provided", then "Test Isotope".

Or Select All

ALL

Retrieve

SDCC Calculator Overview

Using the SDCC Calculator

Select Scenario (streets, outside surfaces)

- Resident
- Indoor Worker
- Outdoor Worker
- Composite Worker

Select Media:

- Dust
- 3-D External Exposure
- 2-D External Exposure

Select Result Type

- Defaults
- State
- Site-specific

Select Dose Output:

- No
- Yes

Select Units

- pCi
- Bq

Select ICRP rule

- 107 - Center for Radiation Protection Knowledge
- 60/68/72
- 30

Select Individual Isotopes

Complete List

Ac-223
Ac-223+D
Ac-223+E
Ac-224
Ac-225
Ac-225+D
Ac-225+E
Ac-226
Ac-227
Ac-228



Selected

Common Isotopes

Am-241
Co-60
Cs-137+E
H-3
I-129
I-131
Pu-238
Pu-239+E
Pu-240
Ra-226+E



To add an isotope not in the list, select "Site Specific", "User-provided", then "Test Isotope".

Or Select All

- ALL

Retrieve

Exposure to Settled Dust on Outdoor Surfaces

◆ Exposure routes

- Exposure to contamination deposited on surfaces via incidental ingestion
- Inhalation of resuspended particulates
- External exposure to ionizing radiation from dust settled on contaminated surfaces

Exposure to Settled Dust on Outdoor Surfaces (cont.)

- ◆ Resident spends some time inside and some time outside.
 - For indoor time, equation includes GSF for external exposure.
- ◆ Outdoor worker spends entire shift outside
- ◆ Indoor worker spends entire shift indoors.
 - Includes GSF for external exposure.

Residential Exposure to Settled Dust on Outdoor Surfaces

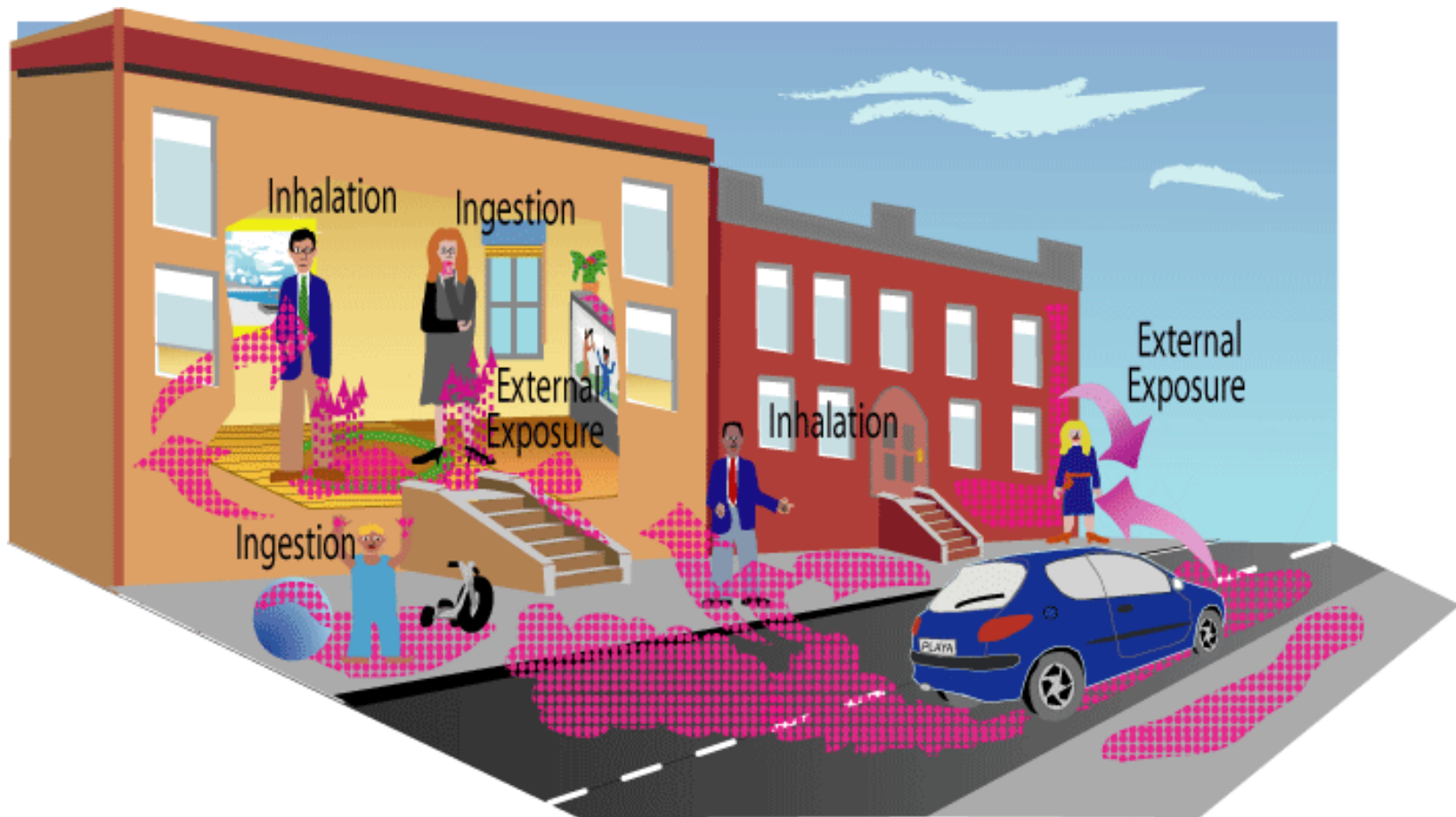

Outdoor Worker Exposure to Settled Dust on Outdoor Surfaces



Indoor Worker Exposure to Settled Dust on Outdoor Surfaces



United States
Environmental Protection
Agency

Superfund Radiation Risk
Assessment Calculator Training

3D Direct Ext Exposure to Fixed Contaminated Building Materials

- ◆ Exposure route: external exposure to ionizing radiation.
- ◆ Assume that street (horizontal) and building walls (vertical) on both sides of street are constructed with contaminated materials.

Res 3D Direct Ext Exposure to Fixed Contaminated Building Materials



OW 3D Direct Ext Exposure to Fixed Contaminated Building Materials



United States
Environmental Protection
Agency

Superfund Radiation Risk
Assessment Calculator Training

IW 3D Direct Ext Exposure to Fixed Contaminated Building Materials



3D Direct Ext Exposure to Fixed Settled Dust on Outdoor Surfaces

- ◆ Exposure route: external exposure to ionizing radiation.
- ◆ Assume that street and building walls on both sides of street are radioactively contaminated.
- ◆ Resident (indoor portion) and indoor worker include GSF for external exposure.

Res 3D Direct Ext Exposure to Fixed Settled Dust on Outdoor Surfaces



OW 3D Direct Ext Exposure to Fixed Settled Dust on Outdoor Surfaces

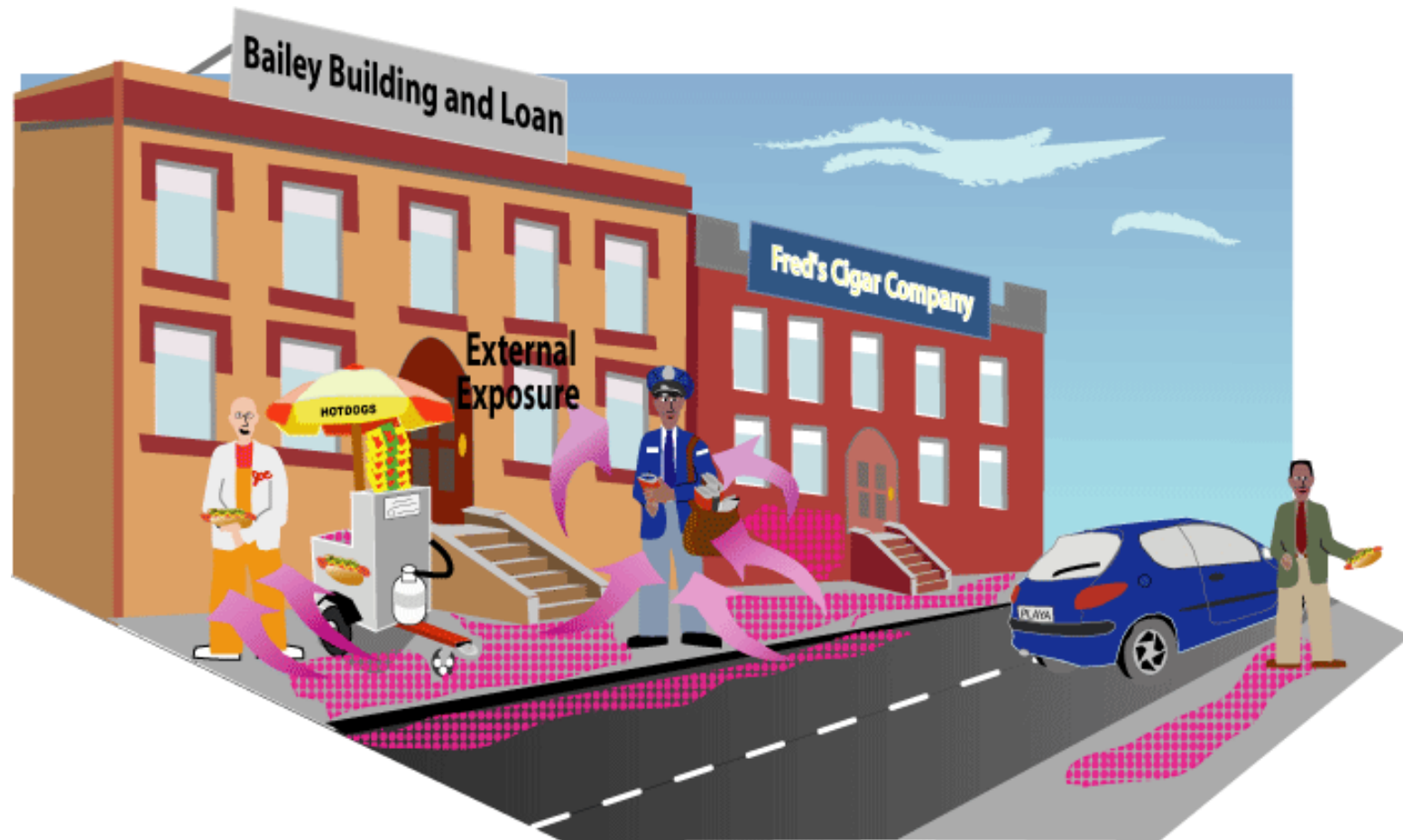

IW 3D Direct Ext Exposure to Fixed Settled Dust on Outdoor Surfaces



2D Direct External Exposure to Fixed Contaminated Finite Slabs

- ◆ Exposure route: external exposure to ionizing radiation.
- ◆ Assume that finite slab (horizontal) is constructed with contaminated materials.
- ◆ Scenario details
 - Resident assumed to live in structure built on top of the middle of the slab.
 - Indoor worker assumed to be employed in structure built on top of the middle of the slab.

Res 2D Direct Ext Exposure to Fixed Contaminated Finite Slabs

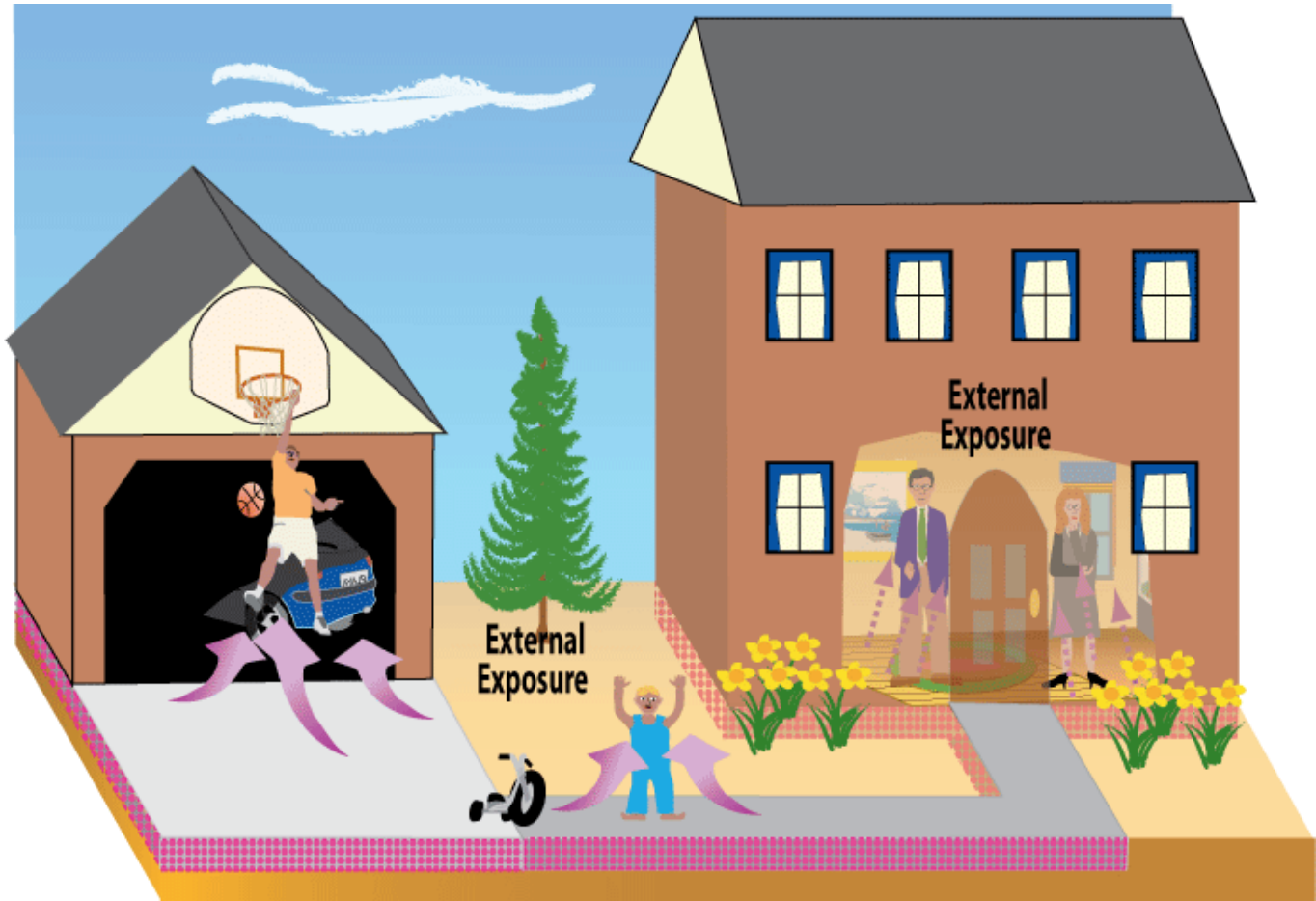

OW 2D Direct Ext Exposure to Fixed Contaminated Finite Slabs

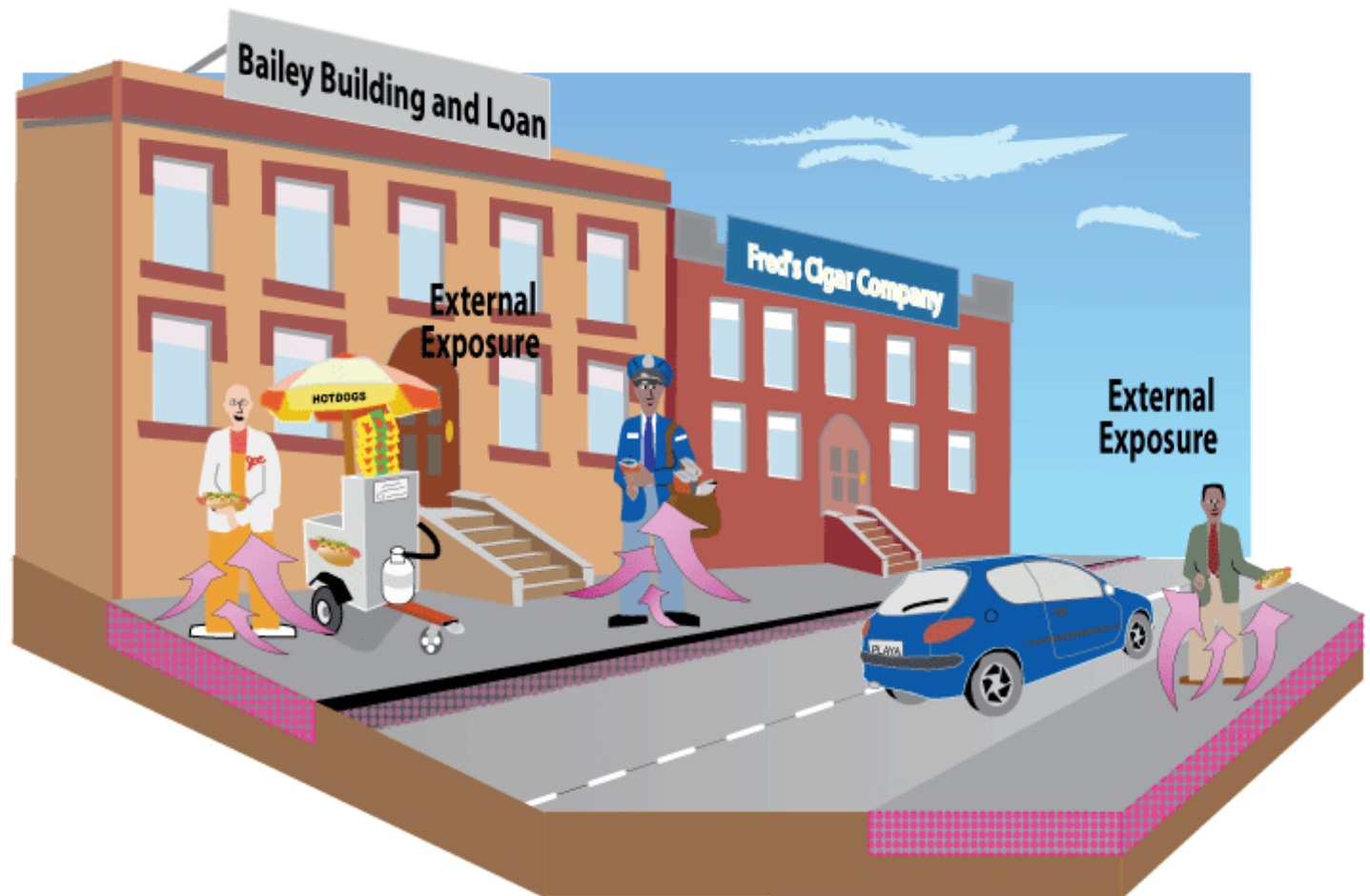

United States
Environmental Protection
Agency

Superfund Radiation Risk
Assessment Calculator Training

IW 2D Direct Ext Exposure to Fixed Contaminated Finite Slabs

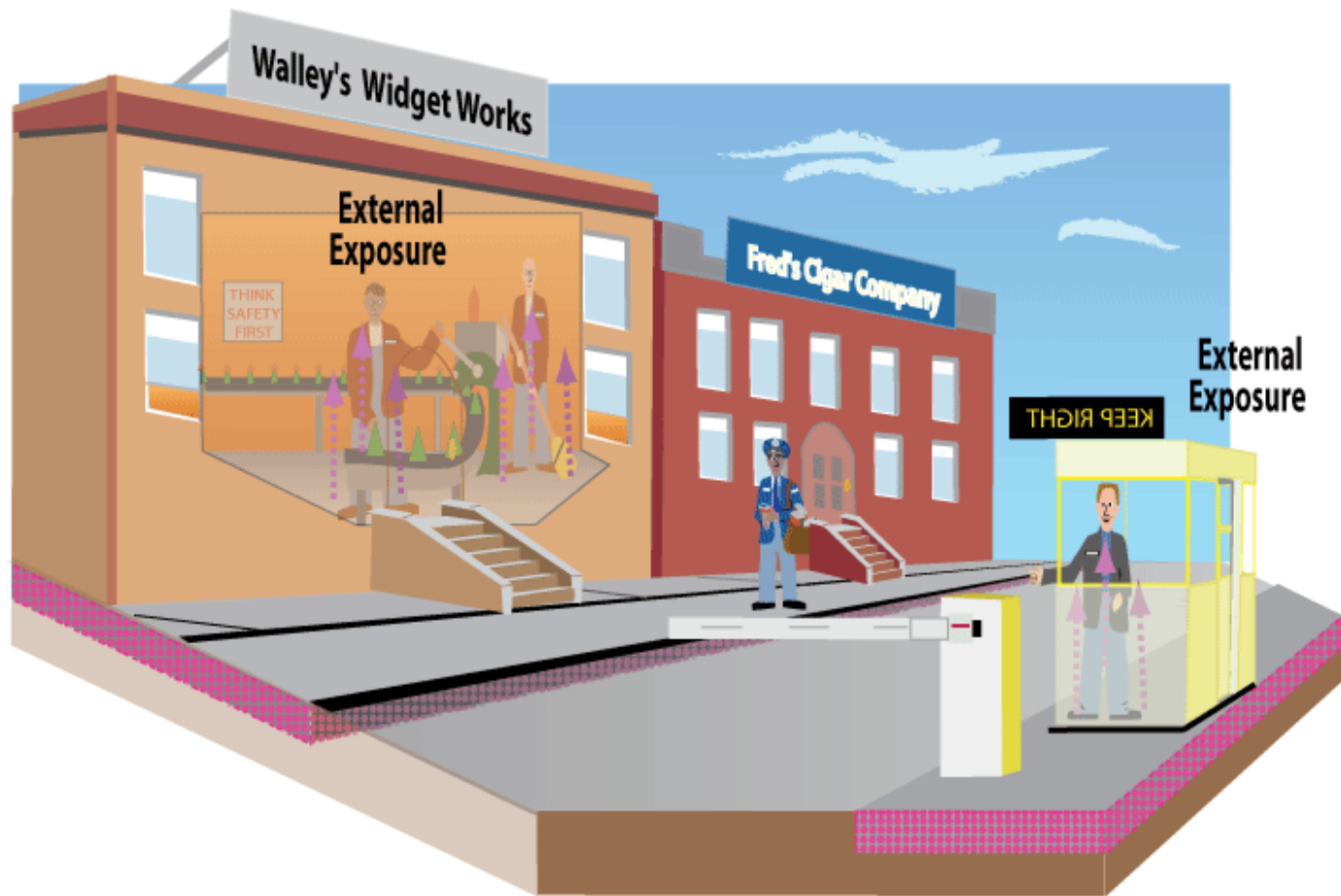

2D Direct External Exposure to Settled Dust on Finite Slabs

- ◆ Exposure route: external exposure to ionizing radiation.
- ◆ Assume that dust on finite slab (horizontal) is radioactively contaminated.
- ◆ Scenario details:
 - Resident assumed to live in structure built on top of the middle of the slab.
 - Indoor worker assumed to be employed in structure built on top of the middle of the slab.

Res 2D Direct External Exposure to Settled Dust on Finite Slabs

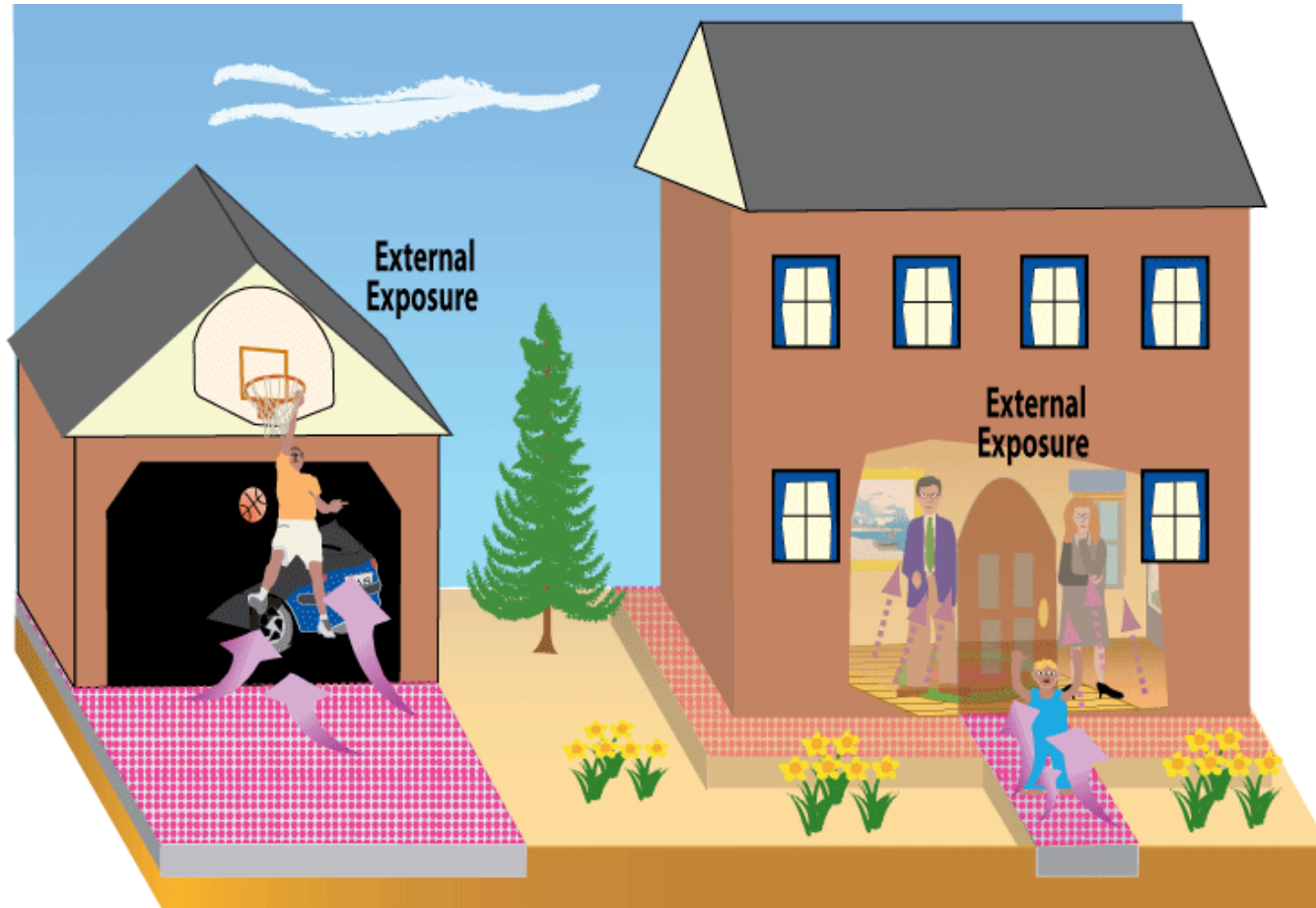

OW 2D Direct External Exposure to Settled Dust on Finite Slabs

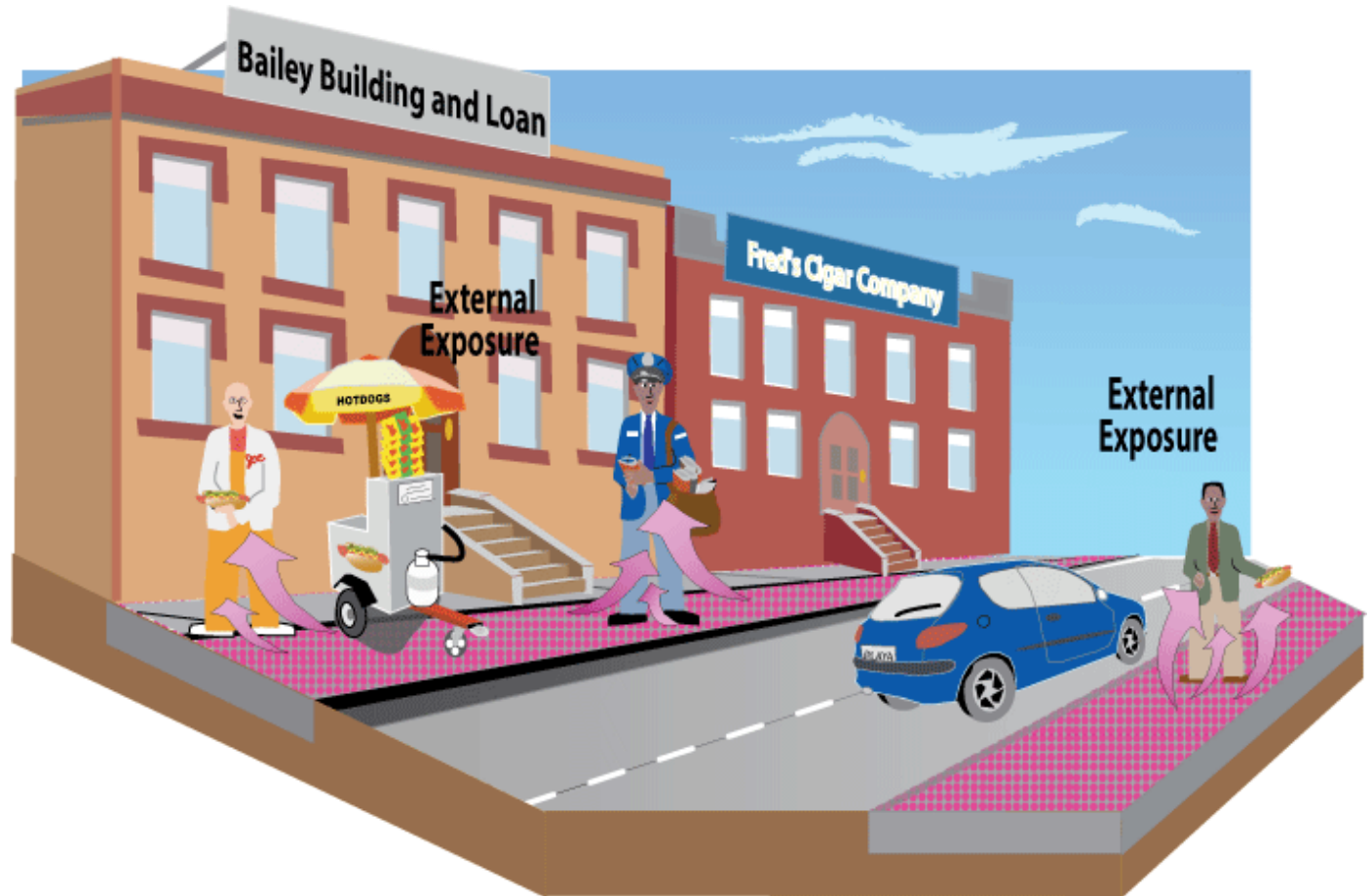

IW 2D Direct External Exposure to Settled Dust on Finite Slabs

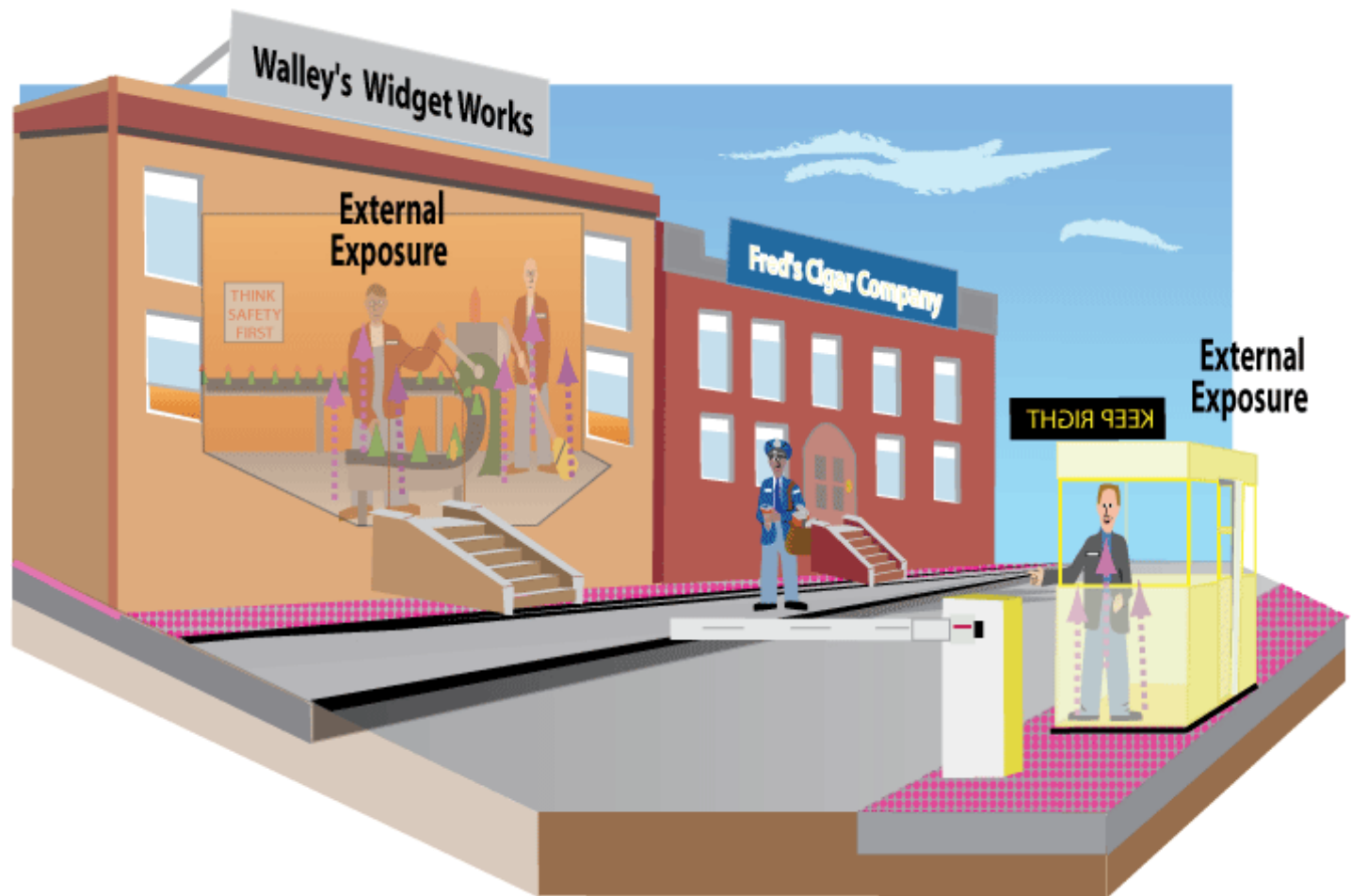

Residential State Inputs

PEF Wind Driven

Particulate Emission Factor Wind Driven

PEF Wind Equation

Default	City (Climatic Zone) - Selection based on most likely climatic conditions for the site
0.5	A_s (acres)
1.36E+09	PEF_w / Wind Particulate Emission Factor (m^3/kg)
93.77	Q/C_{wind} / inverse of the ratio of the geometric mean air concentration to the emission flux at center of a square source (g/m^2-s per kg/m^3)
0.5	V / fraction of vegetative cover (unitless)
4.69	U_m / mean annual wind speed (m/s)
11.32	U_t / equivalent threshold value
0.194	$F(x)$ / function dependant on U_m/U_t derived using Cowherd et al. (1985) (unitless)
16.2302	A (Dispersion Constant)
18.7762	B (Dispersion Constant)
216.108	C (Dispersion Constant)



United States
Environmental Protection
Agency

Superfund Radiation Risk
Assessment Calculator Training

Residential State Inputs

PEF Mechanically Driven for Public Paved Roads

Select a State Select Geographic Setting

Particulate Emission Factor Mechanically Driven for Public Paved Roads

PEF Equation

2.11E+07	PEF _{m-pp} / Mechanical Particulate Emission Factor - paved public (m ³ /kg)
93.77	Q/C _w / inverse of the ratio of the geometric mean air concentration to the emission flux at center of a square source (g/m ² -s per kg/m ³). Calculated from A _s above. (default Minneapolis)
0.185811027	F _D / Dispersion correction factor (unitless)
31536000	T / Time in seconds (calculated from worker ED)
8760	t _c / Time in hours (calculated from worker ED)
274.2134	A _R / Area (m ²)
147.5805	L _R / Length of road segment (ft); Calculated from A _s above.
0.015	sL / Road surface silt loading (g/m ²)
112015000000	AKV / Annual vehical kilometers per road class (km/yr)
2821594.655	Σ VKT / Sum of fleet vehicle kilometers traveled during ED (km/yr)
1786	km per road class
3.2	W / (mean vehicle weight) tons
20	W _R / Width of road segment (ft)
4.6	k-pp / Particle size multiplier for public-paved road (g/VKT)
0.1317	C / Emission factor for fleet exhaust, brake and tire wear
150	p / number of days in a year with at least 0.001 inches of precipitation
16.2302	A (Dispersion Constant)
18.7762	B (Dispersion Constant)
216.108	C (Dispersion Constant)

Site-Specific Inputs

Select Scenario (streets, outside surfaces)

- Resident
- Indoor Worker
- Outdoor Worker
- Composite Worker

Select Media:

- Dust
- 3-D External Exposure
- 2-D External Exposure

Select Result Type

- Defaults
- State
- Site-specific

Select Road Type:

- select-
- Public Paved
- Public Unpaved
- Industrial Unpaved

Select Isotope Info:

Residential SS Inputs

Settled Dust – Combined Ingestion & Ground Plane External Exposure

Combined Ingestion and Ground Plane External Exposure

Dust Total

0.8	AAF _{r-a} (annual age fraction - resident adult)
0.2	AAF _{r-c} (annual age fraction - resident child)
1	DL (dose limit) unitless
1	ED _r (exposure duration - resident) yr
350	EF _r (exposure frequency - resident) day/yr
16.4	ET _{i,r} (indoor exposure time - resident) hr/day
1.752	ET _{o,r} (outdoor exposure time - resident) hr/day
1	F _{AM} (area and material factor) unitless
1	F _{OFF-SET} (off-set factor) unitless
0.4	GSF _i (Indoor Gamma Shielding Factor) unitless
1	GSF _o (Outdoor Gamma Shielding Factor) unitless
18	IFA _{r-adj} (age-adjusted dust inhalation rate - resident) m ³ /day
64.5	IFD _{r-adj} (age-adjusted dust ingestion rate - resident) cm ² /day
0.0	k (dissipation rate constant) yr ⁻¹
6.67E+08	SLF (Silt Loading Factor) cm ² /kg

1	t _r (time - resident) yr
1	ED _{r-a} (exposure duration - resident adult) yr
1	ED _{r-c} (exposure duration - resident child) yr
4	ET _{r-a,h} (exposure time - resident adult hard surface) hr/day
4	ET _{r-c,h} (exposure time - resident child hard surface) hr/day
Select a slab size ▾ Slab size for ACF	
1	FQ _{r-a} (frequency of hand to mouth - resident adult) event/hr
9.5	FQ _{r-c} (frequency of hand to mouth - resident child) event/hr
0.5	FTSS _h (fraction transferred surface to skin - hard surface) unitless
20	IRA _{r-a} (inhalation rate - resident adult) m ³ /day
10	IRA _{r-c} (inhalation rate - resident child) m ³ /day
45	SA _{r-a} (surface area of fingers - resident adult) cm ²
15	SA _{r-c} (surface area of fingers - resident child) cm ²
0.5	SE (saliva extraction factor) unitless

Residential SS Inputs (cont.)

Settled Dust – Combined Ingestion & Ground Plane External Exposure

NOTES:

1. λ =decay constant
2. When $k = 0.0$, the dissipation term is not included in the calculation to prevent division by zero which would result a PRG of zero.
3. A, B, and C are constants.
4. $ED_r = ED_{r-a} = ED_{r-c} = t_r$
5. DCF_{d-oral} = ingestion dose conversion factor
6. DCF_{inh} = inhalation dose conversion factor
7. DCF_{d-ext} = external exposure dose conversion factor
8. IFD_{r-adj} = age-adjusted ingestion factor
9. IFA_{r-adj} = age-adjusted inhalation factor
10. $L_r = (A_s * 43560)^{0.5}$

Residential SS Inputs

Settled Dust – PEF Wind Driven

PEF Wind Equation

$$PEF_w = Q/C_w \left(\frac{\text{g}}{\text{m}^2\text{-s}} \right) \left(\frac{\text{kg}}{\text{m}^3} \right) \times \frac{3,600 \left(\frac{\text{s}}{\text{hr}} \right)}{0.036 \times (1-V) \times \left(U_m \left(\frac{\text{m}}{\text{s}} \right) / U_t \left(\frac{\text{m}}{\text{s}} \right) \right)^3} \times F(x)$$

where

$$\frac{Q}{C_w} \left(\frac{\text{g}}{\text{m}^2\text{-s}} \right) \left(\frac{\text{kg}}{\text{m}^3} \right) = A \times \exp \left[\frac{(\ln A_s (\text{acres}) - B)^2}{C} \right]$$

Default ▾ City (Climatic Zone) - Selection based on most likely climatic conditions for the site

0.5 ▾ A_s (acres)

1.36E+09 PEF_w / Wind Particulate Emission Factor (m³/kg)

93.77 Q/C_{wind} / inverse of the ratio of the geometric mean air concentration to the emission flux at center of a square source (g/m²-s per kg/m³)

0.5 V / fraction of vegetative cover (unitless)

4.69 U_m / mean annual wind speed (m/s)

11.32 U_t / equivalent threshold value

0.194 F(x) / function dependant on U_m/U_t derived using Cowherd et al. (1985) (unitless)

16.2302 A (Dispersion Constant)

18.7762 B (Dispersion Constant)

216.108 C (Dispersion Constant)

Residential SS Inputs

Settled Dust – PEF Mechanically Driven for Public Paved Roads

2.11E+07	PEF _{m-pp} / Mechanical Particulate Emission Factor - paved public (m ³ /kg)
93.77	Q/C _w / Inverse of the ratio of the geometric mean air concentration to the emission flux Calculated from A _s above. (default Minneapolis)
0.185811027	F _D / Dispersion correction factor (unitless)
31536000	T / Time in seconds (calculated from worker ED)
8760	t _c / Time in hours (calculated from worker ED)
274.2134	A _R / Area (m ²)
147.5805	L _R / Length of road segment (ft); Calculated from A _s above.
3.2	W / (mean vehicle weight) tons
2821594.655	Σ VKT / Sum of fleet vehicle kilometers traveled during ED (km/yr)
1786	km per road class
20	W _R / Width of road segment (ft)
4.6	k-pp / Particle size multiplier for public-paved road (g/VKT)
0.015	sL / Road surface silt loading (g/m ²)
0.1317	C / Emission factor for fleet exhaust, brake and tire wear
150	p / number of days in a year with at least 0.001 inches of precipitation
16.2302	A (Dispersion Constant)
18.7762	B (Dispersion Constant)
216.108	C (Dispersion Constant)
.	# of trips per day * Required
.	# of days per week the trip is taken * Required
.	# of weeks per year the site is traveled * Required
.	average # of cars per day * Required
.	average # of trucks per day * Required
.	Tons/car * Required
.	Tons/truck * Required

Residential SS Inputs (cont.)

3D – Soil Volume & Ground Plane External Exposure

Soil Volume and Ground Plane External Exposure																											
3-D Direct External Exposure (1 cm)																											
3-D Direct External Exposure (15 cm)																											
3-D Direct External Exposure (5 cm)																											
3-D Direct External Exposure (ground plane)																											
3-D Direct External Exposure (sv)																											
<table border="1"> <tr> <td>Select a sidewalk/street position ▾</td> <td>Select sidewalk/street position</td> </tr> <tr> <td>Select a building height (ft) ▾</td> <td>Select building height (ft)</td> </tr> <tr> <td>1</td> <td>DL (dose limit) unitless</td> </tr> <tr> <td>1</td> <td>ED_r (exposure duration - resident) yr</td> </tr> <tr> <td>350</td> <td>EF_r (exposure frequency - resident) day/yr</td> </tr> <tr> <td>16.4</td> <td>ET_{i,r} (exposure time - resident indoor) hr/day</td> </tr> <tr> <td>1.752</td> <td>ET_{o,r} (exposure time - resident outdoor) hr/day</td> </tr> </table>	Select a sidewalk/street position ▾	Select sidewalk/street position	Select a building height (ft) ▾	Select building height (ft)	1	DL (dose limit) unitless	1	ED _r (exposure duration - resident) yr	350	EF _r (exposure frequency - resident) day/yr	16.4	ET _{i,r} (exposure time - resident indoor) hr/day	1.752	ET _{o,r} (exposure time - resident outdoor) hr/day	<table border="1"> <tr> <td>1</td> <td>F_{AM} (area and material factor) unitless</td> </tr> <tr> <td>1</td> <td>F_{CD} (depth and cover function) unitless</td> </tr> <tr> <td>1</td> <td>F_{OFF-SET} (off-set factor) unitless</td> </tr> <tr> <td>0.4</td> <td>GSF_i (gamma shielding factor - indoor) unitless</td> </tr> <tr> <td>1</td> <td>GSF_o (gamma shielding factor - outdoor) unitless</td> </tr> <tr> <td>1</td> <td>t_r (time - resident) yr</td> </tr> </table>	1	F _{AM} (area and material factor) unitless	1	F _{CD} (depth and cover function) unitless	1	F _{OFF-SET} (off-set factor) unitless	0.4	GSF _i (gamma shielding factor - indoor) unitless	1	GSF _o (gamma shielding factor - outdoor) unitless	1	t _r (time - resident) yr
Select a sidewalk/street position ▾	Select sidewalk/street position																										
Select a building height (ft) ▾	Select building height (ft)																										
1	DL (dose limit) unitless																										
1	ED _r (exposure duration - resident) yr																										
350	EF _r (exposure frequency - resident) day/yr																										
16.4	ET _{i,r} (exposure time - resident indoor) hr/day																										
1.752	ET _{o,r} (exposure time - resident outdoor) hr/day																										
1	F _{AM} (area and material factor) unitless																										
1	F _{CD} (depth and cover function) unitless																										
1	F _{OFF-SET} (off-set factor) unitless																										
0.4	GSF _i (gamma shielding factor - indoor) unitless																										
1	GSF _o (gamma shielding factor - outdoor) unitless																										
1	t _r (time - resident) yr																										
<p>NOTES:</p> <ol style="list-style-type: none"> 1. SF_{ext}=soil-volume external exposure slope factor (risk/yr per pCi/g). radionuclide-specific 2. λ=decay constant. radionuclide-specific 3. F_{SURF}=Ratio of the surface dose rate to that for an infinite plane source - radionuclide-specific 4. ED_r = t_r 																											



Residential SS Inputs

2D – Soil Volume & Ground Plane External Exposure

Soil Volume and Ground Plane External Exposure

[2-D Direct External Exposure \(1 cm\)](#)

[2-D Direct External Exposure \(15 cm\)](#)

[2-D Direct External Exposure \(5 cm\)](#)

[2-D Direct External Exposure \(ground plane\)](#)

[2-D Direct External Exposure \(sv\)](#)

NOTES:

1. Equation parameters from 3-D external exposure will be used in addition to slab size
2. ACF - radionuclide-specific
3. Slab size for ACF in 2-D alternate external equation is determined by area selected in dust section above



United States
Environmental Protection
Agency

Superfund Radiation Risk
Assessment Calculator Training

SPRG Residential Generic Output

Surfaces

Radionuclide	Soil Ingestion DCF (mrem/pCi)	Inhalation DCF (mrem/pCi)	External Exposure DCF (Ground Plane) (mrem/yr per pCi/cm ²)
K-40	2.29E-05	7.77E-06	2.38E-01

Area Correction Factor	Lambda	Halflife (years)
6.18E-01	5.54E-10	1.25E+09

PEF _w	PEF _m	SDCC (Wind) (pCi/cm ²)	SDCC (Mechanical) (pCi/cm ²)
1.36E+09	2.81E+10	1.71E+00	1.76E+00

3D Direct External Exposure

Radionuclide	Soil Volume External Exposure DCF (Infinite Volume) (mrem/yr per pCi/g)	Soil Volume External Exposure DCF (1 cm) (mrem/yr per pCi/g)
K-40	9.94E-01	1.77E-01

Soil Volume External Exposure DCF (5 cm) (mrem/yr per pCi/g)	Soil Volume External Exposure DCF (15 cm) (mrem/yr per pCi/g)	External Exposure DCF (Ground Plane) (mrem/yr per pCi/cm ²)
5.04E-01	8.21E-01	2.38E-01

F _{surf}	Lambda	Halflife (years)	Soil Volume SDCC (pCi/g)	Soil Volume 1cm SDCC (pCi/g)
9.95E-01	5.54E-10	1.25E+09	3.04E+00	1.71E+01

Soil Volume 5cm SDCC (pCi/g)	Soil Volume 15cm SDCC (pCi/g)	Ground Plane SDCC (pCi/cm ²)	Soil Volume SDCC (mg/kg)
6.01E+00	3.69E+00	1.27E+01	4.27E-01



Radiation Risk Assessment Calculator Training

Section 8: Differences between EPA and DOE tools



United States
Environmental Protection
Agency

Superfund Radiation Risk
Assessment Calculator Training

Why Does Radiation Easily Fit within the Superfund Framework?

- ◆ Primary effect is cancer
- ◆ People ingest, inhale, eat, same amount of contaminated dust and food whether it is chemical or radioactive contamination,
- ◆ Dust gets resuspended the same whether it is chemically or radioactively contaminated
- ◆ Inorganic elements move through the subsurface the same whether they are radioactive or not

RSL, PRG, DCC, Similar Look and Feel

Using the RSL Calculator

Select Scenario

- Resident
- Composite Worker (presented in Generic Tables)
- Construction Worker (RSL only)
- Indoor Worker (RSL only)
- Outdoor Worker RSL only)
- Fish (RSL only)
- Soil to Groundwater (RSL only)
- Recreator (Site Specific RSL only)

Select Media:

- Soil
- Air
- Tapwater

Select SL type

- Defaults
- Site Specific

Select Risk Output:

- No
- Yes

Using the PRG Calculator

Select Scenario

- Resident
- Farmer
- Soil to Groundwater
- Indoor Worker
- Outdoor Worker
- Composite Worker
- Recreator (Site-specific only)
- Construction Worker – Unpaved Road Traffic (Site-specific only)
- Construction Worker – Wind Erosion and Other Construction Activities (Site-specific only)

Select Media:

- Soil
- Air
- 2-D External Exposure
- Tap Water
- Fish

Select PRG type

- Defaults
- Site Specific

Select Risk Output:

- No
- Yes

Select Units

- pCi
- Bq

Using the DCC Calculator

Select Scenario

- Resident
- Composite Worker
- Outdoor Worker
- Indoor Worker
- Construction Worker – Standard Unpaved Road Vehicle Traffic (Site-specific only)
- Construction Worker – Wind Erosion and Other Construction Activities (Site-specific only)
- Recreator (Site-specific only)
- Farmer
- Soil to Groundwater

Select Media:

- Soil
- Air
- 2-D External Exposure
- Tap Water
- Fish

Select DCC type

- Defaults
- Site-specific

Select Dose Output:

- No
- Yes

Select Units

- pCi
- Bq

RSL, PRG, DCC, Consistent Exposure Assumptions

RSL Calculator

- RSL Home
- User's Guide
- What's New
- FAQ
- Equations
- Generic Tables
- RSL Calculator
- Risk Calculator

Soil

Resident Exposure to Soil

Instructions

Exposure Assessment Details

Substitute Soil Saturation Concentration (CSAT) for soil inhalation RSL?

Substitute theoretical ceiling limit for total soil RSL?

Age Segment (yr)	AF (mg/cm ²)	BIW (kg)	ED (yr)	EF (day/yr)	ET (hr/event)	IRS (mg/day)	SA (cm ² /day)
0-2	0.2	15	2	350	24	200	2373
2-6	0.2	15	4	350	24	200	2373
6-16	0.07	80	10	350	24	100	6032
16-26	0.07	80	10	350	24	100	6032
Child (0-6)	0.2	15	6	350	24	200	2373
Adult (6-26)	0.07	80	20	350	24	100	6032

Preliminary Remediation Goals for Radionuclides

Select a slab size Slab size for ACF

Select a soil thickness cover layer Select cover layer thickness for GSF_o (gamma shielding factor - outdoor)

ED_r (exposure duration - resident) yr

ED_{r-a} (exposure duration - resident adult) yr

ED_{r-c} (exposure duration - resident child) yr

EF_r (exposure frequency - resident) day/yr

EF_{r-a} (exposure frequency - resident adult) day/yr

EF_{r-c} (exposure frequency - resident child) day/yr

ET_{r-a} (exposure time - resident adult) hr/day

ET_{r-c} (exposure time - resident child) hr/day

ET_{r-i} (exposure time - indoor resident) hr/day

ET_{r-o} (exposure time - outdoor resident) hr/day

GSF_i (gamma shielding factor - indoor) unitless

IFA_{r-adj} (age-adjusted soil inhalation factor - resident) m³

IFS_{r-adj} (age-adjusted soil ingestion factor - resident) mg

IRA_{r-a} (inhalation rate - resident adult) m³/day

IRA_{r-c} (inhalation rate - resident child) m³/day

IRS_{r-a} (soil intake rate - resident adult) mg/day

IRS_{r-c} (soil intake rate - resident child) mg/day

MLF (produce plant mass loading factor) unitless

t_r (time - resident) yr

TR (target cancer risk) unitless

Dose Compliance Concentrations for Radionuclides (DCC)

Select a slab size Slab size for ACF

Select a soil thickness cover layer Select cover layer thickness for GSF_o (gamma shielding factor - outdoor)

AAF_a (annual age fraction - resident adult) unitless

AAF_c (annual age fraction - resident child) unitless

DL (dose limit) mrem

ED_r (exposure duration - resident) yr

ED_{r-a} (exposure duration - resident adult) yr

ED_{r-c} (exposure duration - resident child) yr

EF_r (exposure frequency - resident) day/yr

EF_{r-a} (exposure frequency - resident adult) day/yr

EF_{r-c} (exposure frequency - resident child) day/yr

ET_{r-a} (exposure time - resident adult) hr/day

ET_{r-c} (exposure time - resident child) hr/day

ET_{r-i} (exposure time - indoor resident) hr/day

ET_{r-o} (exposure time - outdoor resident) hr/day

GSF_i (gamma shielding factor - indoor) unitless

IFA_{r-adj} (age-adjusted soil inhalation factor - resident) m³

IFS_{r-adj} (age-adjusted soil ingestion factor - resident) mg

IRA_{r-a} (inhalation rate - resident adult) m³/day

IRA_{r-c} (inhalation rate - resident child) m³/day

IRS_{r-a} (soil intake rate - resident adult) mg/day

IRS_{r-c} (soil intake rate - resident child) mg/day

MLF (produce plant mass loading factor) unitless

t_r (time - resident) yr

RSL, PRG, DCC

Consistent treatment of inorganics

- ◆ Resuspension – same
- ◆ Soil to groundwater – same
- ◆ All 3 steady state models. Not depleting source (transfer/dynamic) models

Guidance: World Trade Center (WTC) Benchmark

- ◆ Document used to establish 1×10^{-4} risk based cleanup levels for the reuse of chemically contaminated buildings after the 9/11 attacks.
- ◆ Equations and parameters were the latest EPA chemical methodology
- ◆ Ingestion, inhalation, and dermal
 - http://www.epa.gov/wtc/reports/contaminants_of_concern_benchmark_study.pdf

Guidance: World Trade Center (WTC) Benchmark (continued)

- ◆ WTC benchmark document includes 1 land use scenario
 - Residential
- ◆ This land use includes 2 exposure routes
 - Settled dust
 - Ambient air



Select Differences

- ◆ Some examples that have come up during site issues
 - Input parameters and default values
 - Steady state vs dynamic/transfer
 - Depleting source in soil
 - Movement of dust through buildings
- ◆ Not an attempt at any comprehensive analysis of differences, these are issues which have been on sites and/or interagency discussions

Steady State vs Dynamic Transfer

- ◆ EPA PRG, DCC, and RSL calculators are steady state models
 - Conservative assumption of no lessening of contaminated source, except radioactive decay
 - This assumption is in early EPA CERCLA risk assessment documents (RAGs, SSG, Rad SSG)
- ◆ RESRAD assumes source is depleting from erosion (soil runoff) and leaching into the subsurface
 - Not conservative compared to EPA

Factors Affecting Source Loss

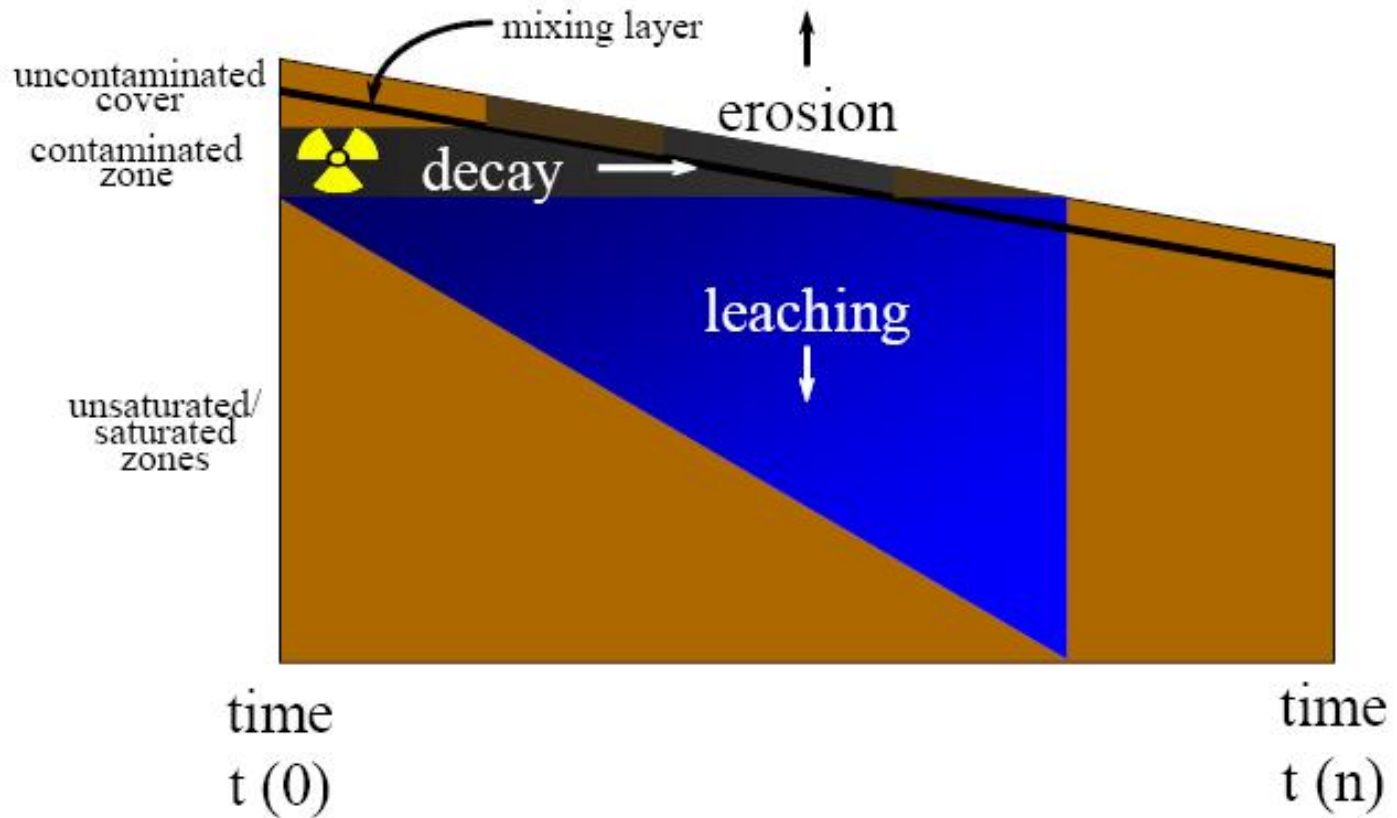

Settled Dust & Indoor Air Resuspension

- ◆ EPA BPRG and BDCC calculators and WTC document

BPRG – Indoor Air

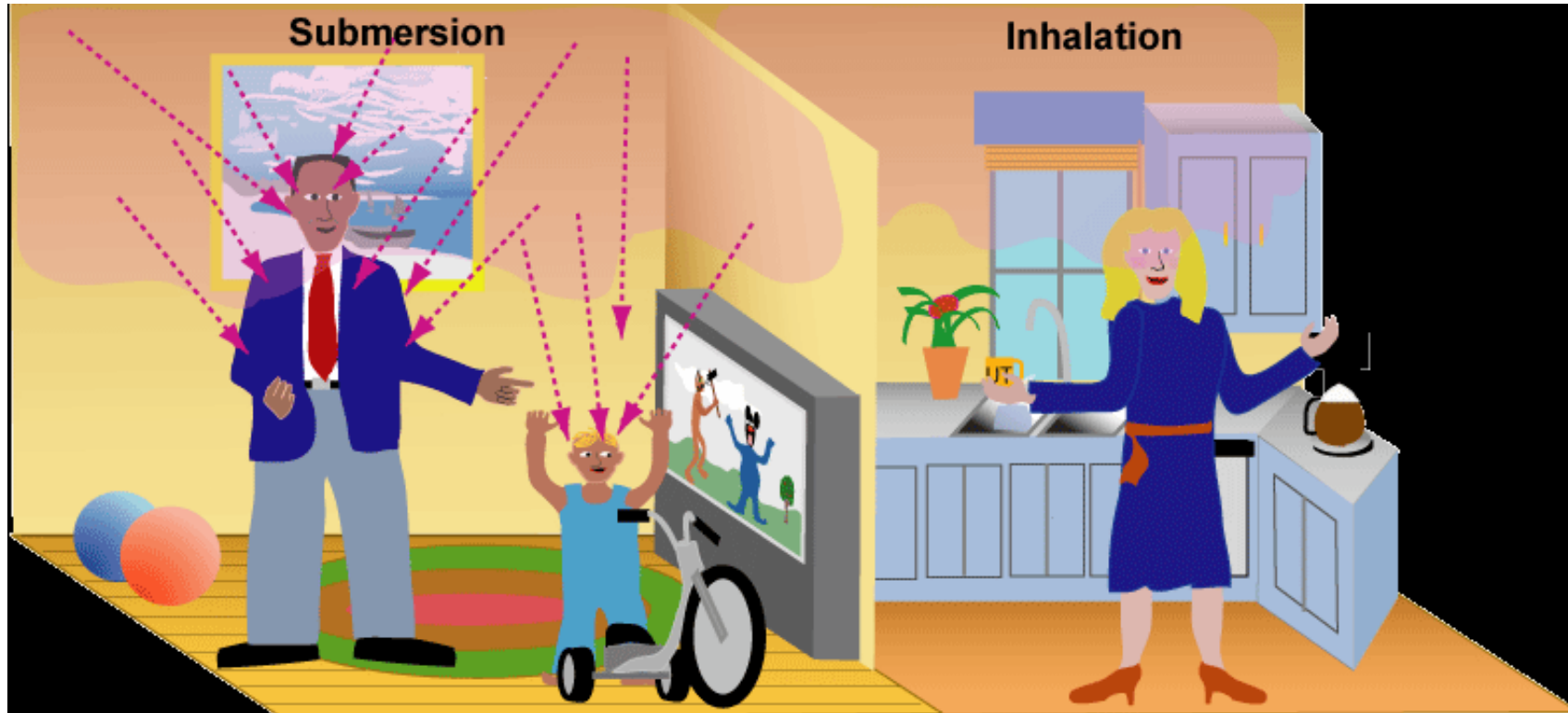

BPRG – Settled Dust

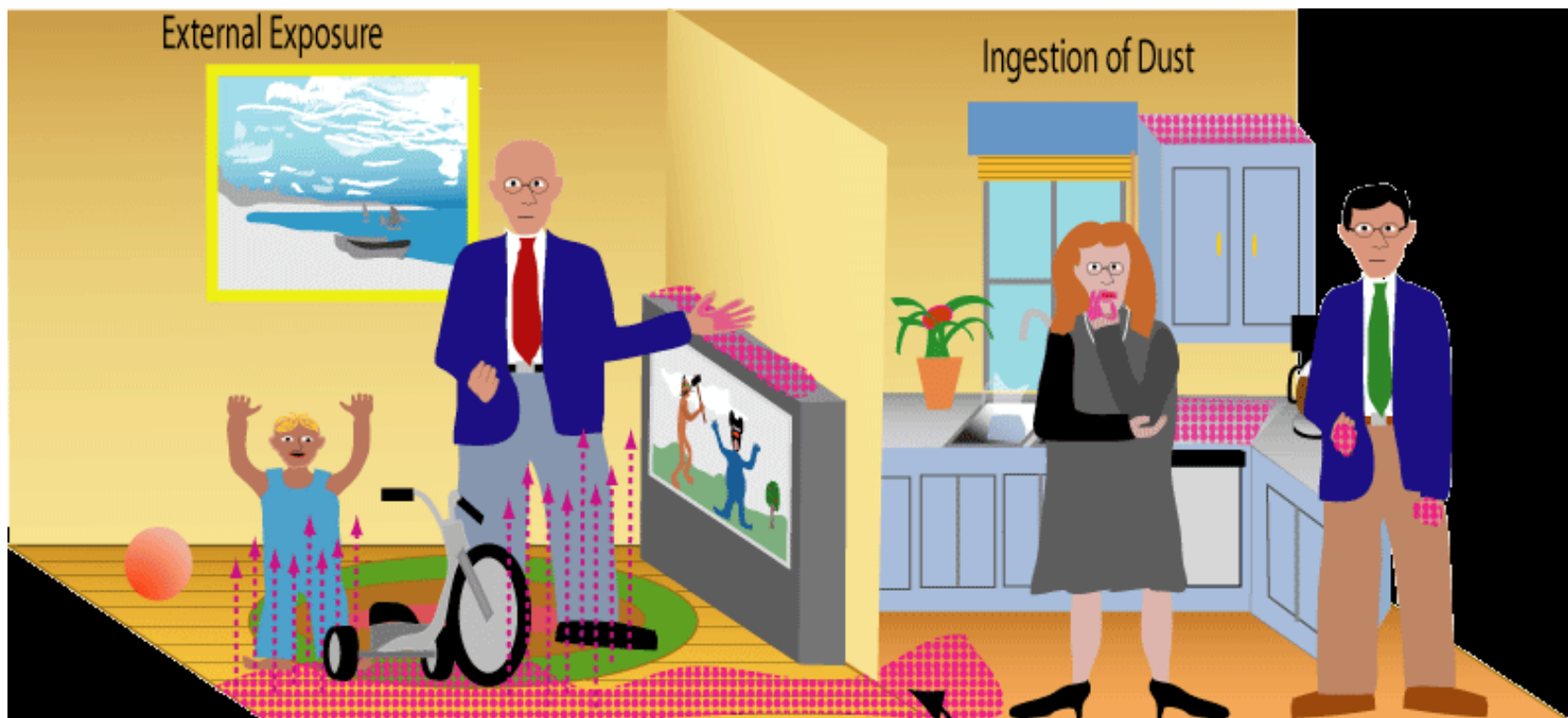

Source Removal/Injection - Point, Line, Area Sources

- Source removal and injection treated the same for point, line and area
- Parameters affecting source removal
 - Removable fraction
 - Source lifetime
- Parameters affecting source injection
 - Source lifetime
 - Removable fraction
 - Air fraction
- Source is linearly removed over the source lifetime
 - "Erosion Rate" or removal rate
 - *Removable Fraction/ Source Lifetime*
 - *20% over 10 years*
 - 2% per year
- Radioactive decay occurs simultaneously

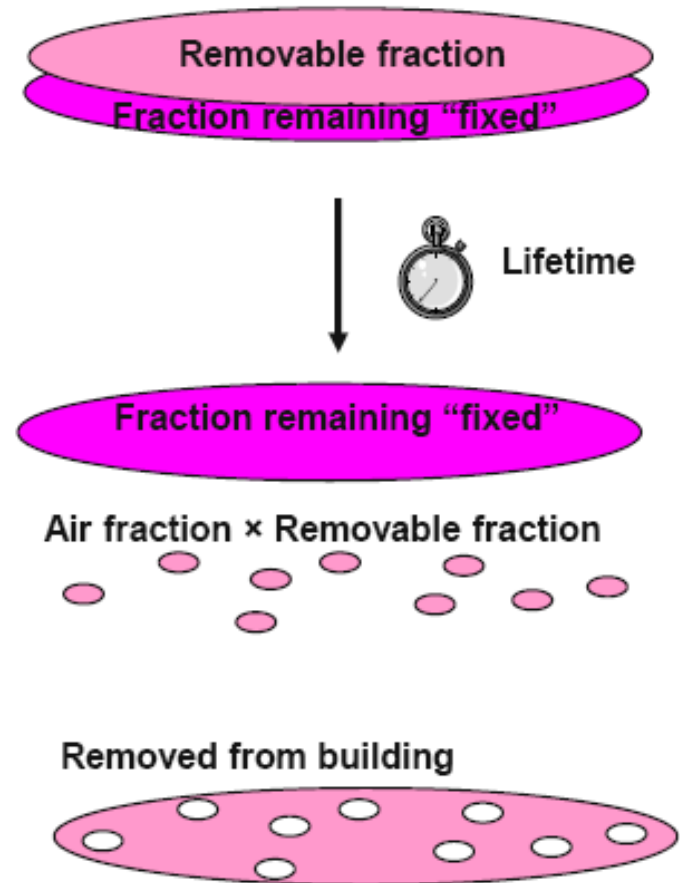

Source Injection to Air Pathways

- Models the release of the radionuclides from the source to the air
 - Building renovation
 - Building occupancy
- The airflow in the building will transport the airborne nuclides from room to room
- Nuclides will deposit and will be resuspended
- Pathways considered
 - External
 - Submersion, deposited nuclides
 - Inhalation
 - Ingestion
 - Deposited nuclides

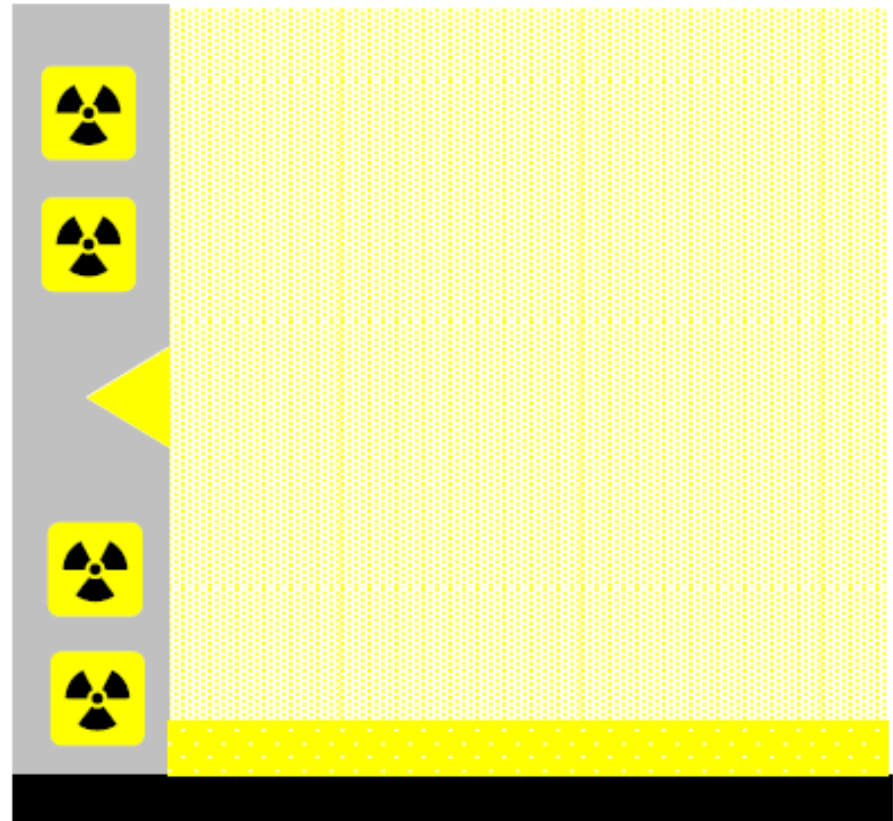

RESRAD-BUILD One Room Air Flow Model

$$V \frac{dC}{dt} = I - QC - \lambda VC + \lambda VC_p - \lambda_D VC + \lambda_R \lambda_D VC / (\lambda_R + \lambda)$$

Change of Activity
in the room

Exchange
with outside

Decay of
parent in Air

Resuspension

Injection
Rate

Decay in Air

Deposition

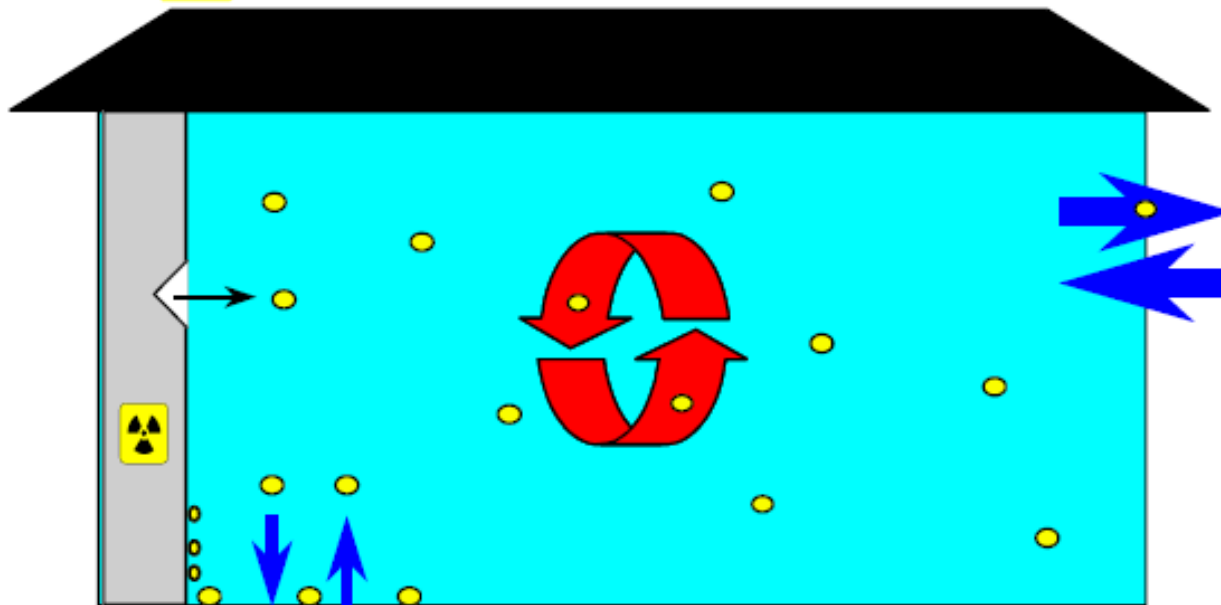

Default Parameters

- ◆ **EPA.** Inhalation and ingestion parameters and default input values the same for radiation and chemical risk assessment methods.
- ◆ **DOE.** Uses different parameters and different defaults input parameters for radiation vs chemical risk assessment methods.
 - DOE differs from both EPA radiation and chemical parameters and default input values
 - There is no scientific reason for these differences
 - It was a policy decision by RESRAD developers

PRG and RSL Inhalation

Default City (Climatic Zone) - Selection based on most likely climatic conditions for t
0.5 A_s (acres)

1359344438 PEF (particulate emission factor) m³/kg

93.77 Q/C_{wp} / Inverse of the ratio of the geometric mean air concentration to the emission source (g/m²-s per kg/m³) PEF Selection

16.2302 A (Dispersion Constant)

18.7762 B (Dispersion Constant)

216.108 C (Dispersion Constant)

0.5 V / fraction of vegetative cover (unitless)

4.69 U_m / mean annual wind speed (m/s)

11.32 U_t / equivalent threshold value (m/s)

0.194 F(x) / function dependant on U_m/U_t derived using Cowherd et al. (1985) (unitless)

26 ED_r (exposure duration - resident) yr

20 ED_{r-a} (exposure duration - resident adult) yr

6 ED_{r-c} (exposure duration - resident child) yr

350 EF_r (exposure frequency) day/yr

350 EF_{r-a} (exposure frequency - resident adult) day/yr

350 EF_{r-c} (exposure frequency - resident child) day/yr

24 ET_r (exposure time - resident) hr

24 ET_{r-a} (exposure time - resident adult) hr

24 ET_{r-c} (exposure time - resident child) hr

1.0 GSF_a (gamma shielding factor - air) unitless

161000 IFA_{r-adj} (age-adjusted inhalation factor) m³

20 IRA_{r-a} (inhalation rate - resident adult) m³/day

10 IRA_{r-c} (inhalation rate - resident child) m³/day

26 t_r (time - resident) yr

1.0E-6 TR (target cancer risk) unitless

Default City (Climatic Zone) - Selection based on most likely climatic conditions for t

0.5 A_s (acres)

1359344438 PEF (particulate emission factor) m³/kg

93.77 Q/C_{wp} (g/m²-s per kg/m³) PEF Selection

16.2302 A (PEF Dispersion Constant)

18.7762 B (PEF Dispersion Constant)

216.108 C (PEF Dispersion Constant)

0.194 F(x) (function dependant on U_m/U_t) unitless

0.5 V (fraction of vegetative cover) unitless

4.69 U_m (mean annual wind speed) m/s

Age Segment (yr)	AF (mg/cm ²)	BW (kg)	ED (yr)	EF (day/yr)	ET (hr/event)	IRS (mg/day)	SA (cm ² /day)
0-2	0.2	15	2	350	24	200	2373
2-6	0.2	15	4	350	24	200	2373
6-16	0.07	80	10	350	24	100	6032
16-26	0.07	80	10	350	24	100	6032
Child (0-6)	0.2	15	6	350	24	200	2373
Adult (6-26)	0.07	80	20	350	24	100	6032

RESRAD and RESCHEM Inhalation

```

C:\WINDOWS\system32\cmd.exe
RESRAD-C: Chemical Risk Assessment Program Path(s): 1,2,3,4,5,6,7,8,9
Inhalation and General Exposure Parameters <C018>
  Inhalation rate: 20 m**3/day
  Mass loading for inhalation: .0002 grams/m**3
  Dilution length for airborne dust (inhalation): 3 meters
  Wind speed in mixing zone: 2 meters/sec
  Shielding factor for inhalation: .4

  Time fraction on-site, outdoors: .33
  Exposure duration for child: 6 years
  Total exposure duration: 30 years
  Average body weight of child: 15 kilograms
  Average body weight of adult: 70 kilograms
  Average life span: 70 years

Press "F1" or "F2" for HELP, or "Esc" to IGNORE CHANGES and return to main menu.
Press "F9" for Sensitivity Analysis. Press "F10" to SAVE DATA AND CONTINUE.
What is the inhalation rate?
  
```

Inhalation and External Gamma

Inhalation rate: 8400 m**3/year
 Mass loading for inhalation: .0001 grams/m**3
 Mean Onsite mass loading: .0001 grams/m**3
 Indoor to outdoor dust concentration: .4
 External gamma penetration factor: .7

Shape of Primary Contamination
 Occupancy Factors
 Save
 Cancel

Atmospheric Transport

Release height: 1 meters
 Release heat flux: 0 cal/s
 Anemometer height: 10 meters
 Ambient temperature: 285 Kelvin
 AM atmospheric mixing height: 400 meters
 PM atmospheric mixing height: 1600 meters

Dispersion Model Coefficients
 Pasquill-Gifford Coefficients
 Briggs Rural Coefficients
 Briggs Urban Coefficients

Windspeed Terrain
 Rural
 Urban

Offsite location
 Fruit, grain, non-leafy vegetables plot: 0
 Leafy vegetables plot: 0
 Pasture, silage growing area: 0
 Grain fields: 0
 Dwelling site: 0
 Surface water body: 0

Elevation of offsite location, relative to ground level at primary contamination: 0 m
 Grid spacing for areal integration: 10 m
 Read Meteorological STAR file

Wind speed: 0.89, 2.46, 4.47, 6.93, 9.61, 12.52 m/s
 Stability class: Joint frequency of wind speed and stability class for wind from S to N

Stability class	0.89	2.46	4.47	6.93	9.61	12.52
A	1	0	0	0	0	0
B	0	0	0	0	0	0
C	0	0	0	0	0	0
D	0	0	0	0	0	0
E	0	0	0	0	0	0
F	0	0	0	0	0	0

Save
 Cancel

RESCHEM and RESRAD look and feel

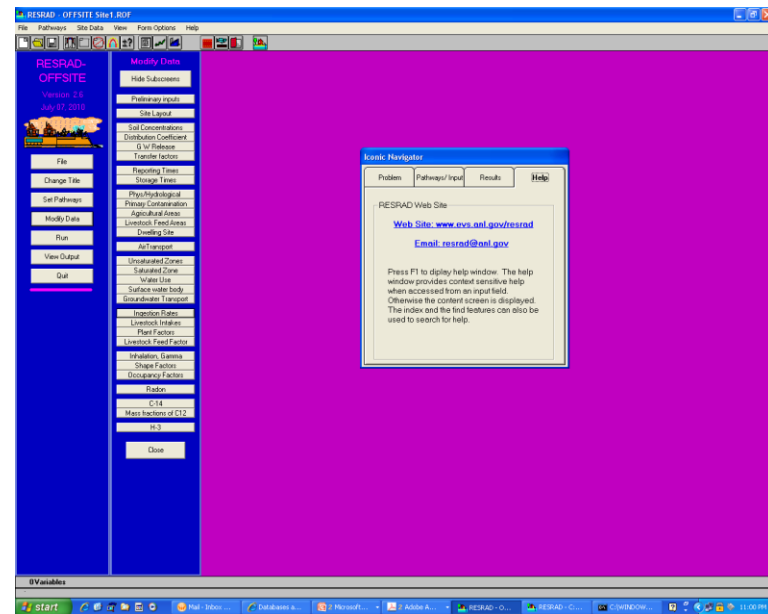
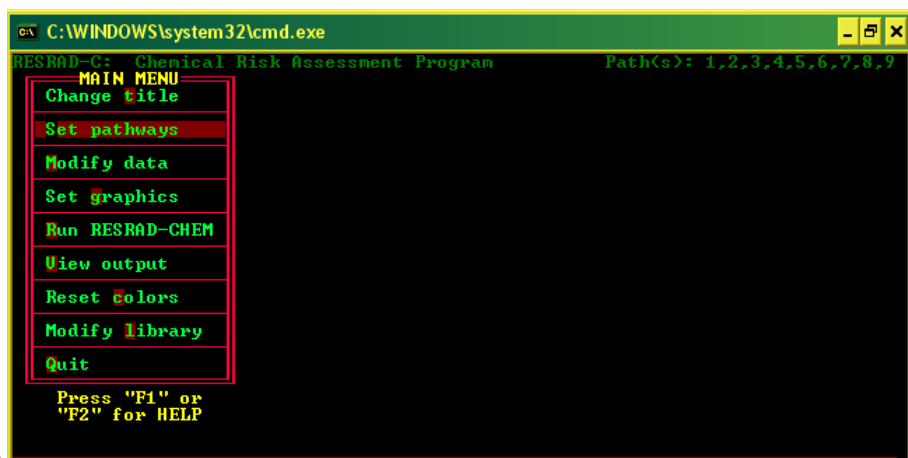

Implications

- ◆ RME exposure defined by EPA through its guidance
 - When using RESRAD, you are protecting a different RME than using EPA guidance
- ◆ Use of RESRAD or RESCHEM results in unnecessary inconsistency how chemicals and radionuclides are addressed at the same site
 - RESRAD differs from EPA's PRG and RSL, and even with RESCHEM

Why is this important?

- ◆ EPA cannot defer to states, DOE, DOD, or other entities for remedy selection.
- ◆ EPA is a signature on the ROD.
- ◆ EPA **needs to fully understand** what is being said and be able to stand behind it based on the NCP, CERCLA, and EPA guidance.
 - This includes what concentrations constitute meeting the risk range and/or ARARs.

EPA As the Decision Maker (cont.)

- ◆ Federal Facilities Disputes ultimately resolved by the EPA Administrator
- ◆ Mather AFB/George AFB Dispute by Adm. Carol Browner (April 1993) regarding interpretation of a State standard:
 - “Thus, while state law is applied, the decision is made by EPA, not the state...As the remedial decision is made by EPA the interpretive decision is necessarily EPA’s as well.”

EPA is the Decision Maker

- ◆ EPA determines the levels needed for protections and compliance with ARARs and guidance (TBCs)
- ◆ EPA needs to be able to justify the level selected.
- ◆ EPA's PRG calculators are recommended for Superfund radiation risk assessments.
 - If another model is to be used, EPA needs to:
 1. run both models
 2. have a thorough understanding of both models
 3. be able to explain the differences.

EPA Policy

2014 Risk Assessment Q&A

- ◆ 3 PRG (PRG, BRPG, SPRG) and 3 DCC (DCC, BDCC, and SDCC) calculators are EPA's recommended models for risk and dose assessment
- ◆ Reiterate more strongly that risk assessments (e.g., models used) should be consistent with chemicals at site and with other regional sites
- ◆ Don't use a steady state model for chemical and a transfer/dynamic model for radionuclides
 - Such as using RSL calculator for chemicals then RESRAD for radionuclides



EPA Policy

2014 Risk Assessment Q&A, continued

- ◆ If EPA regions are considering use of model other than PRG or DCC calculators, for some portion of the risk or dose assessment then they should:
 1. Consult with EPA HQ (Stuart Walker)
 2. Region should run PRG/DCC calculators and alternative model using PRG/DCC default input parameters
 3. Region should have technical justification why alternative model would replace preferred PRG/DCC calculator for some portion of risk/dose assessment



Radiation Risk Assessment Calculator Training

Section 9: BCG Calculator

BCG Outline

- ◆ Background
- ◆ Development approach
 - Representative species
 - DCFs
 - CSM
- ◆ Calculator walkthrough
 - Exposure scenarios
 - Species- and site-specific

BCG Background

- ◆ Biota Concentration Guides (BCGs), also known as ecological screening benchmarks, are used in ecological risk assessment at CERCLA sites.
- ◆ BCGs are environmental concentrations of radionuclides that would result in an exposure of radiation equal to NOAEL biota dose limits.
 - NOAEL: No Observed Adverse Effect Level

BCG Background – NOAEL

- ◆ NOAEL: level of exposure at which there is no biologically or statistically significant increase in severity of adverse effects in exposed population.
- ◆ Critical points: impairment of reproductive capability; alteration of morphology, functional capacity, growth, development, or lifespan;
- ◆ Does not consider biota risk from mechanisms other than cell death.

BCG Background (cont.)

- ◆ Develops conservatively protective ecological benchmarks based on cell death.
- ◆ Protective of populations, not individuals.
- ◆ Does not address human cancer risk.
- ◆ Does not address nonradioactive toxicity.
- ◆ Calculates generic steady-state BCGs. Can also be used to find species- or site-specific BCGs.

Biota Dose Limits

- ◆ Thresholds of protection:
 - Terrestrial and riparian animals: 1 mGy/day (0.1 rad/day)
 - Aquatic animals: 10 mGy/day (1 rad/day)
 - Aquatic and terrestrial plants: 10 mGy/day (1 rad/day)

Developmental Approach - Selecting a Representative Species

Considerations:

- ◆ Home range (prefer small)
- ◆ Susceptibility to ionizing radiation (prefer radiosensitive)
- ◆ Represent major exposure pathways for aquatic and terrestrial biota
- ◆ Indigenous to and utilizes evaluation area
- ◆ Familiarity with general public
- ◆ Data available from literature or site-specific studies.
- ◆ Keystone or focal species of ecosystem evaluated.

Developmental Approach – Dose Conversion Factors

◆ External DCFs

- Give dose rates for external exposure per unit concentration of radionuclides in environmental media.
- Only penetrating radiation (photons, electrons) of concern.
- For terrestrial biota, contaminated air is not an important source medium.

Developmental Approach – Dose Conversion Factors

◆ Internal DCFs

- Give dose rates from internal exposure per unit concentration of radionuclides in wet tissue.
- Dose factors calculated as sum of all decay energies and multiplied by appropriate unit conversion factors.
- The default RBE is 20 for exposure to alpha particles.
- Dose factors calculated as Gy/y per Bq/kg of wet tissue.

Developing a Conceptual Site Model

- ◆ CSM should address the following checklists:
 - Terrestrial Habitat Checklist for
 - Wooded
 - Shrub/scrub
 - Open field
 - Miscellaneous
 - Aquatic Habitat Checklist – non-flowing systems
 - Aquatic Habitat Checklist – flowing systems
 - Wetlands Habitat Checklist

Additional Considerations for Developing a CSM for Biota

- ◆ Are there potential human health concerns?
- ◆ Is there potential for future land uses other than those covered by the BCGs?
- ◆ Are there other likely species not considered in the development of the BCG levels?
- ◆ Are there unusual site conditions that might make the site attractive for certain species?



BCG Calculator Walkthrough

◆ Source media

- Water
- Sediment
- Soil

◆ Exposure scenarios

- Riparian animal (living on shore/banks of bodies of water)
- Terrestrial animal
- Aquatic animal
- Aquatic plant
- Terrestrial plant

Riparian Animal

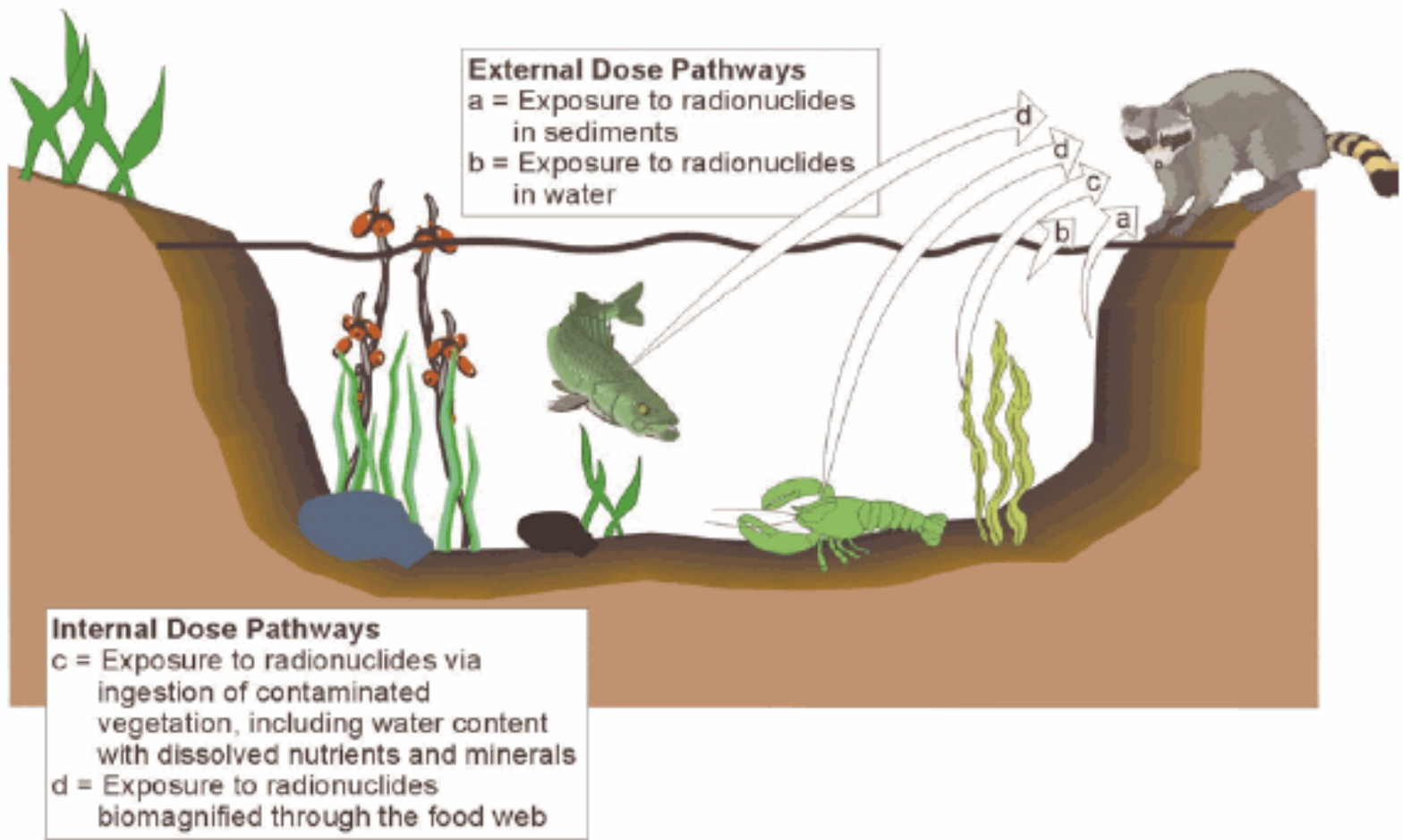

United States
Environmental Protection
Agency

Superfund Radiation Risk
Assessment Calculator Training

Terrestrial Animal

Internal Dose Pathways

- c = Exposure to radionuclides via ingestion of contaminated vegetation, including water content with dissolved nutrients and minerals
- d = Exposure to radionuclides via ingestion of contaminated food and soil, and via inhalation of soil
- e = Exposure to radionuclides via ingestion of contaminated water

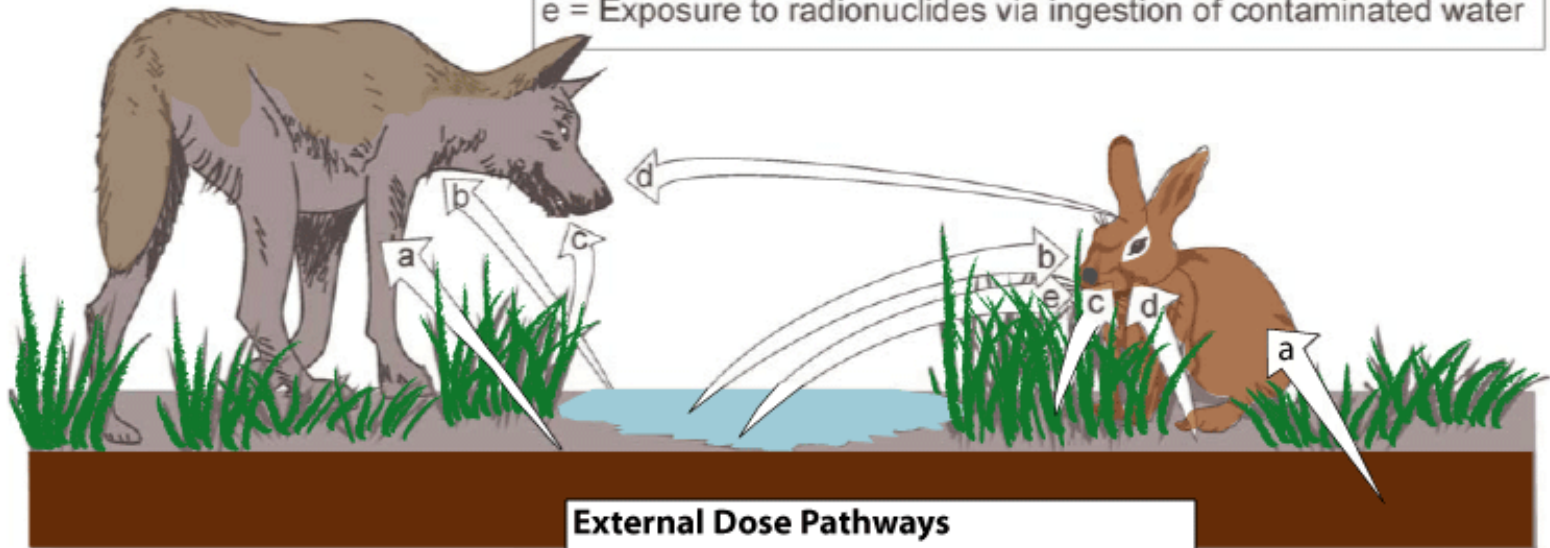

External Dose Pathways

- a = Exposure to radionuclides in soil
- b = Exposure to radionuclides in water

Aquatic Animal

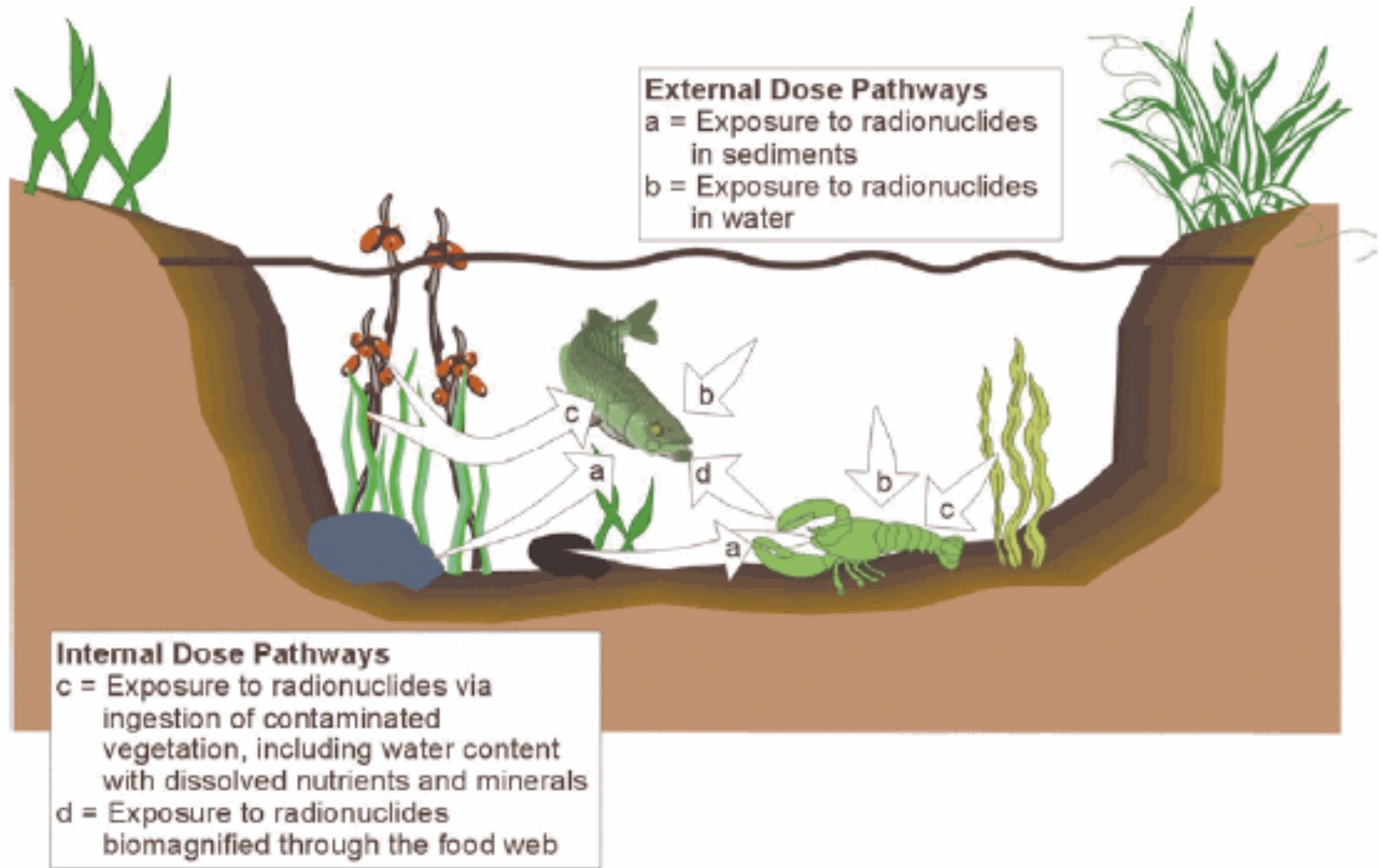

United States
Environmental Protection
Agency

Superfund Radiation Risk
Assessment Calculator Training

Aquatic Plant

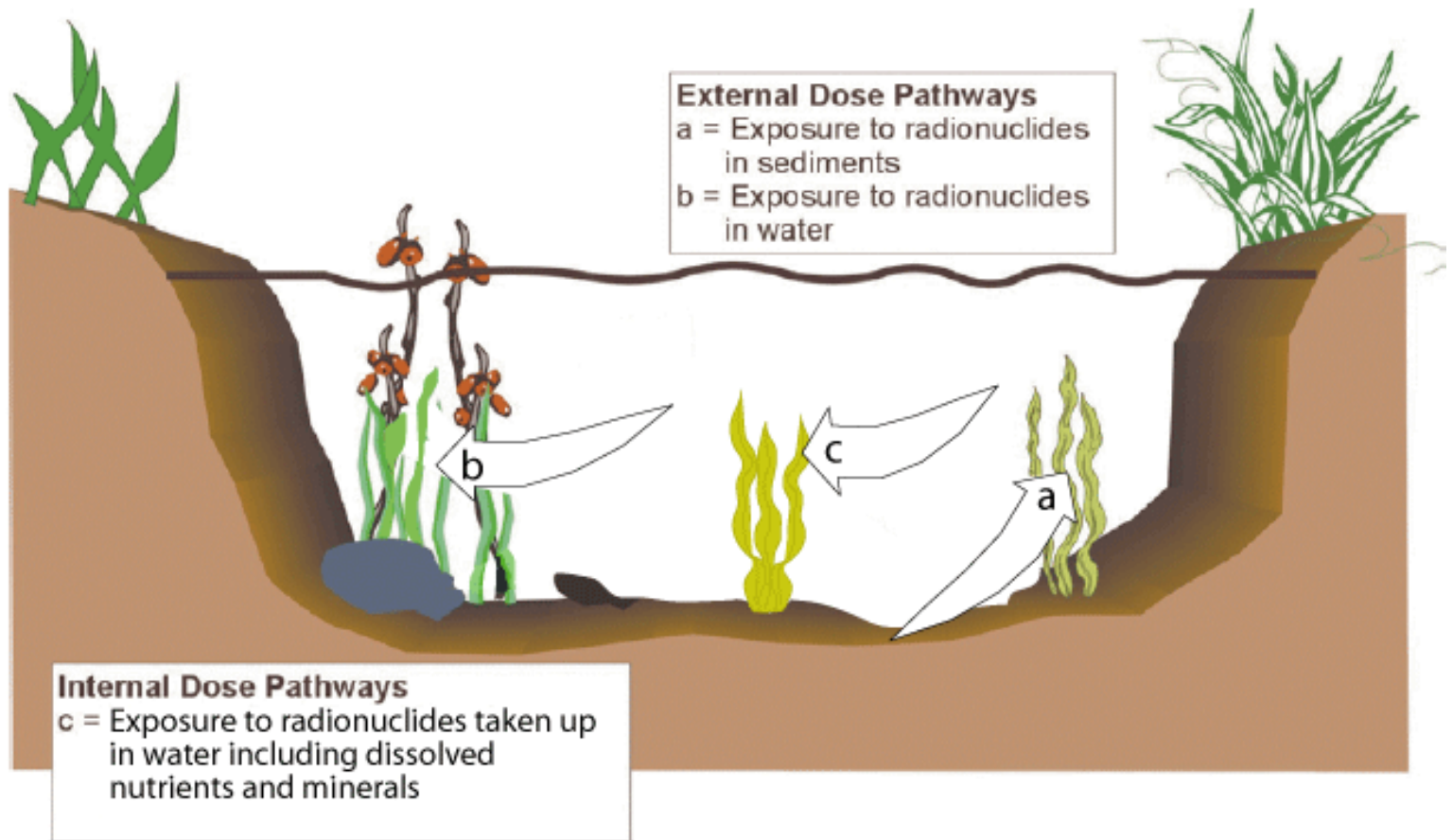

United States
Environmental Protection
Agency

Superfund Radiation Risk
Assessment Calculator Training

Terrestrial Plant

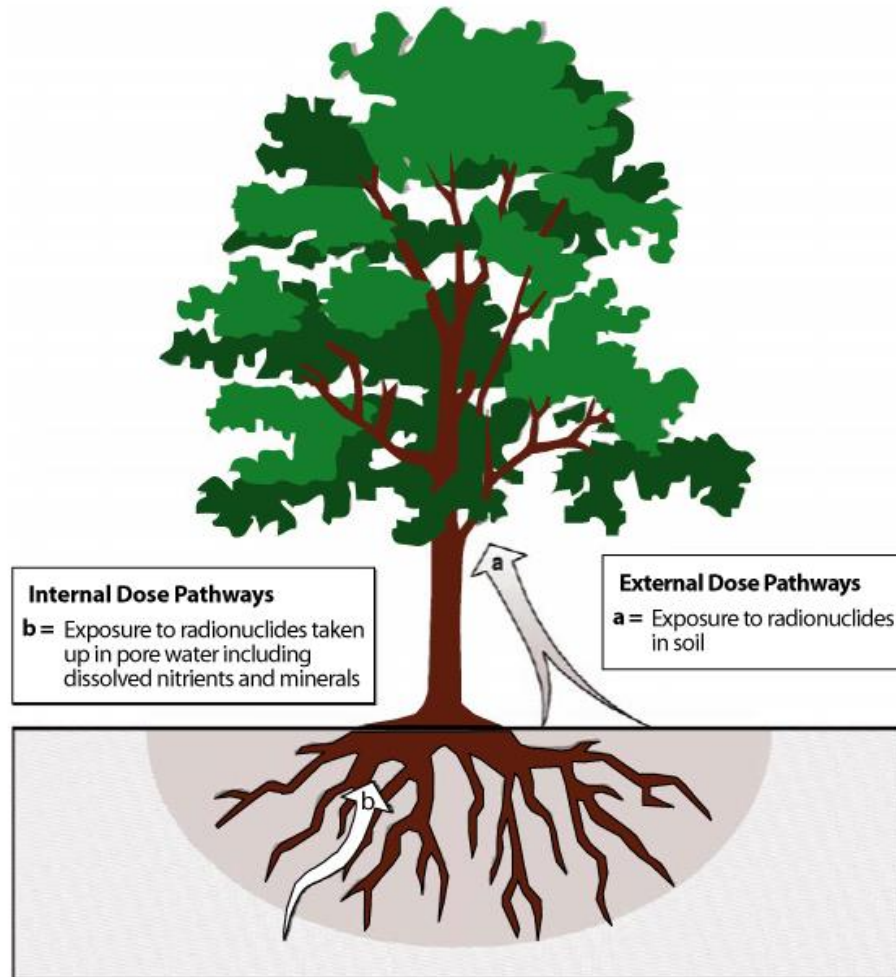

United States
Environmental Protection
Agency

Superfund Radiation Risk
Assessment Calculator Training

Animal Exposure Pathways

	Aquatic	Riparian	Terrestrial
External: rad in soil	✓	✓	✓
External: rad in water	✓	✓	✓
Internal: ingestion of contaminated vegetation	✓	✓	✓
Internal: ingestion of contaminated food and soil, inhalation of soil	✓	✓	✓
Internal: ingestion of contaminated water			✓
Internal: biomagnified through food web	✓		

Plant Exposure Pathways

	Aquatic	Terrestrial
External: rad in sediments	✓	
External: rad in water	✓	
External: rad in soil		✓
Internal: rad taken up in (pore) water, incl. dissolved nutrients and minerals	✓	✓

Calculator Walkthrough

Select Generic Composite Benchmarks.

- Sediment Aquatic Animals (generic only)
- Water Aquatic Animals (generic only)
- Sediment Aquatic Plants (generic only)
- Water Aquatic Plants (generic only)
- Sediment Riparian Animals
- Water Riparian Animals
- Soil Terrestrial Plants (generic only)
- Water Terrestrial Plants (generic only)
- Soil Terrestrial Animals
- Water Terrestrial Animals

Select Species-Specific/Site-Specific Benchmarks.

- Sediment Riparian Animals
- Water Riparian Animals-carnivorous
- Water Riparian Animals-herbivorous
- Soil Terrestrial Animals-carnivorous
- Soil Terrestrial Animals-herbivorous
- Water Terrestrial Animals

- ▶ Generic composite benchmarks require input of DL and CF.
- ▶ Species-specific and site-specific benchmarks permit more detailed input about diet, physiology, etc.

Calculator Walkthrough (cont.)

20 [RBE \$\alpha\$ parameter](#)

Please select desired units option:

- pCi
 Bq

Select Chemicals. Select one or more

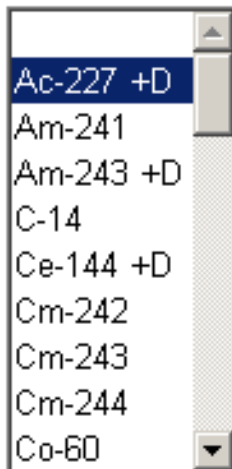

A screenshot of a dropdown menu for selecting chemicals. The menu is open, showing a list of radionuclides and their decay chains. The first item, 'Ac-227 +D', is highlighted in blue. The other items are: Am-241, Am-243 +D, C-14, Ce-144 +D, Cm-242, Cm-243, Cm-244, and Co-60.

Ac-227 +D
Am-241
Am-243 +D
C-14
Ce-144 +D
Cm-242
Cm-243
Cm-244
Co-60

- ◆ RBE of alpha radiation. Default is 20.
- ◆ Units in pCi or Bq.
- ◆ Select radionuclides and/or radionuclide decay chains.

BCG Generic Input

Aquatic Animals – Sediment

$$\text{BCG (sed)}_{\text{aquatic animal}} \left(\frac{\text{pCi}}{\text{g}} \right) = \frac{\text{DL}_{\text{aa}} \left(\frac{\text{rad}}{\text{d}} \right)}{\text{CF}_{\text{aa}} \times \text{DCF}_{\text{ext-sed}} \left(\frac{\text{rad/day}}{\text{pCi/g}} \right)}$$

Variables with Defaults

DL_{aa} = Target Dose Limit - terrestrial animal (rad/day)

CF_{aa} = Area/Residence Time Correction Factor (unitless)

BCG Site/species-specific Input

Sediment Riparian Animals

$$BCG_{\text{sed}}^{\text{riparian animal}} \left(\frac{\text{pCi}}{\text{g}} \right) = \frac{DL_{\text{ra}} \left(\frac{\text{rad}}{\text{d}} \right)}{CF_{\text{ra}} \times \left\{ \left[\frac{f_1 \times f \times r \times \left[1 - e^{-\left(k_{\text{rad}} \left(\frac{1}{\text{d}} \right) + k_{\text{bio}} \left(\frac{1}{\text{d}} \right) \right) \times 365.25 \left(\frac{\text{d}}{\text{yr}} \right) \times T \right]}{\left(k_{\text{rad}} \left(\frac{1}{\text{d}} \right) + k_{\text{bio}} \left(\frac{1}{\text{d}} \right) \right) \times M(\text{kg})} \right] \times DCF_{\text{int}} \left(\frac{\text{rad/day}}{\text{pCi/g}} \right) \right] + \left[DCF_{\text{ext-sed}} \left(\frac{\text{rad/day}}{\text{pCi/g}} \right) \right]} \right\}}$$

where:

$$T = \text{Lifespan of Organism (yr)} = C_L \times M(\text{kg})^{b_L}$$

$$r = \text{Food Intake Rate (kg/d)} = 10^{-3} \times \left(\frac{a}{d \times c} \right) \times 70 \times M^{b_i}$$



United States
Environmental Protection
Agency

Superfund Radiation Risk
Assessment Calculator Training

BCG Site/species-specific Input

Sediment Riparian Animals

Variables with Defaults

<input type="text" value="0.1"/>	DL_{ra} = Target Dose Limit - riparian animal (rad/day)
<input type="text" value="1"/>	CF_{ra} = Area/Residence Time Correction Factor (unitless)
<input type="text" value="0.1"/>	f = Fraction of Daily Diet coming from Sediment (unitless) [Recommended Range: 0.01 - 0.55]
<input type="text" value="2"/>	a = Ratio of Active of Maintenance Metabolic Rate to the Basal Metabolic Rate (unitless) [Recommended Range: 0.5 - 3.0]
<input type="text" value="0.65"/>	d = Fraction of Energy Ingested that is Assimilated and Oxidized (unitless) [Recommended Range: 0.3 - 0.9]
<input type="text" value="5"/>	c = Caloric Value of Food (kcal/g) [Recommended Range: 4 - 9]
<input type="text" value="1"/>	M = Live Body Weight (kg) [Recommended Range: 0.02 - 6000]
<input type="text" value="0.75"/>	b_i = Exponent in allometric relationship detailing consumption as a function of body mass (unitless) [Recommended Range: 0.68 - 0.8]
<input type="text" value="1.02"/>	C_L = Constant detailing lifespan as a function of body mass (unitless) [Recommended Range: 0.9 - 2.0]
<input type="text" value="0.3"/>	b_L = Exponent detailing lifespan as a function of body mass (unitless) [Recommended Range: 0.25 - 0.33]

BCG Generic Calculator Output

Aquatic Animals – Sediment

Radionuclide	Decay Energy (MeV)	Total Alpha	k_{rad}	$k_{bio-sdra}$	$k_{bio-swrac}$	$k_{bio-swrah}$	$k_{bio-sotac}$	$k_{bio-sotah}$	$k_{bio-swta}$	f_1	B_{aa}	B_{ap}	B_{ra}
C-14	0.0495	0	3.3119E-7	-	-	-	-	-	-	0	0	1	0

LP_{ra-sed}	$LP_{ta-soil}$	$LP_{tp-soil}$	$LP_{ta-water}$	Sediment External DC (rad/d per pCi/g)	Water External DC (rad/d per pCi/L)	Soil External DC (rad/d per pCi/g)	Internal DC (rad/d per pCi/g)	Default Sediment BCG for Aquatic Animals (pCi/g)
0	0	0	0	1.27E-06	1.27E-09	2.53E-06	2.54E-06	7.89E+05

Species-specific and Site-specific

- ◆ Examine internal exposure pathways in greater detail.
- ◆ Generic equations estimate internal tissue concentrations using lumped parameters from measurements of contamination in environmental media.
- ◆ Alternative approach is kinetic/allometric:
 - Fills in data gaps from lumped parameters
 - Provides more sophisticated method for evaluating dose.



Radiation Risk Assessment Calculator Training

Section 10: CPM Calculator



United States
Environmental Protection
Agency

Superfund Radiation Risk
Assessment Calculator Training

CPM Background

- ◆ Counts per minute is a measure of radioactivity: number of atoms in a given quantity of radioactive material that are detected to have decayed in 1 minute.
- ◆ Similar to DPM (or DPS), but the efficiency of the radiation detector must be accounted for in CPM.
- ◆ CPM vs. DPM: number of atoms measured to have decayed vs. number of atoms that have decayed.

CPM Background

- ◆ Field screening tool.
- ◆ Helps equate detector measurement in CPM to a remedial level in pCi/cm² or pCi/g given in ARAR, PRG, or DCC.
- ◆ No current EPA guidance on correlating CPM field reading with risk, dose, or ARAR-based concentrations.

CPM Background

- ◆ Intended to facilitate use of real-time measurement techniques to **supplement** sampling.
- ◆ **Not** to replace sampling.

CPM Calculator Scenarios

- ◆ 3 major sub-calculators
 - Ground-based scanning of surface contamination
 - Ground-based scanning of volumetric contamination
 - Air-based scanning of contamination (under consideration)

CPM Model Assumptions

- ◆ Only addresses gamma emitters.
 - Alpha and beta rad omitted because field measurements are difficult.
 - Nuclides w/gamma yield <0.1% omitted.
 - Only uses primary gamma particle.
- ◆ Does addresses ingrowth of daughters.
 - Daughter radionuclides included in output.

CPM Model Assumptions

- ◆ Uniform contamination.
- ◆ Source surface free from all substances (oil, moisture, etc.)
- ◆ Background radiation not considered.
- ◆ Omits shielding factors.
- ◆ Backscatter or buildup in surface not accounted for.

CPM Model Equation

- ◆ Goal detector response is the total calculated response of the detector in cpm for the desired remedial activity of the particular radionuclides in soil.
- ◆ MARSSIM equation is used to find the goal detector response:

$$\textit{Goal Detector Response} = \frac{1}{\frac{\textit{ratio}_1}{C_{r,1}} + \frac{\textit{ratio}_2}{C_{r,2}} + \dots + \frac{\textit{ratio}_n}{C_{r,n}}}$$

CPM Calculator Walkthrough

[Using the Area CPM Calculator](#)

I have read and understand the limitations of this model set forth in the User Guide and FAQ.

Radionuclides (and daughter progeny)	Radionuclides of Interest
<ul style="list-style-type: none">Ac-223Ac-224Ac-225Ac-226Ac-227Ac-228Ag-102Ag-103Ag-104Ag-104mAg-105Ag-106Ag-106mAg-108Ag-108m	<div style="text-align: center;"><< >></div>

Include daughter products (Recommended)

m = metastable state
n = second metastable state
nat = naturally occurring

CPM Calculator Walkthrough

Using the Area CPM Calculator

Radionuclide	Field Activity Concentration (pCi/cm ²)	Target Activity Concentration (pCi/cm ²)
Am-243	<input type="text" value="9"/>	<input type="text" value="9"/>
Br-80	<input type="text" value="9"/>	<input type="text" value="9"/>
U-233	<input type="text" value="9"/>	<input type="text" value="9"/>

Counts Per Minute (CPM)

Using the Area CPM Calculator

Select Detector size	<input type="text" value="0.5 x 1"/>
Enter distance between detector and surface (cm.):	<input type="text"/>

- 0.5 x 1
- 0.5 x 1**
- 1 x 1
- 2 x 2
- 3 x 3

CPM Calculator Walkthrough

Using the Area CPM Calculator

Input and calculation parameters							
Radiouclide	Daughter	Fractional Activity of Parent	Number of Photons	Field Activity (pCi/cm ²)	Target Activity (pCi/cm ²)	Field Activity (CPM)	Target Activity (CPM)
Am-243			1	9	9	550	550
	Np-239	1.000E+00	12				
Br-80			5	9	9	16	16
U-233			0	9	9	-	-

Gross Detector Response for user supplied detector parameters

Gamma Detector Size	0.5 x 1
Distance between detector and surface (cm.)	100
Gross Detector Response (CPM)	283

Gross Detector Response (GDR) is the instrument reading that must be achieved in order to meet the target activity entered by the user. A Field or Target Activity (CPM) result of "-" indicates that no photons are generated by the radionuclide's decay chain and thus cannot be detected by a gamma scintillation detector. Radionuclides with 0 photons do not contribute to the total GDR. This tool only works for gamma emitters.

CPM Calculator Walkthrough

[Using the Volume CPM Calculator](#)

I have read and understand the limitations of this model set forth in the User Guide and FAQ.

Radionuclides (and daughter progeny)	Radionuclides of Interest
Ac-223	
Ac-224	
Ac-225	
Ac-226	
Ac-227	
Ac-228	
Ag-102	
Ag-103	
Ag-104	
Ag-104m	
Ag-105	
Ag-106	
Ag-106m	
Ag-108	
Ag-108m	

Include daughter products (Recommended)

m = metastable state
n = second metastable state
nat = naturally occurring

CPM Calculator Walkthrough

Using the Volume CPM Calculator

Radionuclide	Field Activity Concentration (pCi/g)	Target Activity Concentration (pCi/g)
Am-243	<input type="text" value="50"/>	<input type="text" value="5"/>
Br-80	<input type="text" value="50"/>	<input type="text" value="5"/>
U-233	<input type="text" value="50"/>	<input type="text" value="5"/>

Back

Next



United States
Environmental Protection
Agency

Superfund Radiation Risk
Assessment Calculator Training

CPM Calculator Output

Using the Volume CPM Calculator

Select Source Material	Soil ▾
Select Source Depth	100 cm ▾
Select Detector size	0.5 x 1 ▾
Select Detector Height	10 cm ▾

Using the Volume CPM Calculator

Input and calculation parameters							
Radiouclide	Daughter	Fractional Activity of Parent	Number of Photons	Field Activity (pCi/g)	Target Activity (pCi/g)	Field Activity (CPM)	Target Activity (CPM)
Am-243			1	5	5	1390	139
	Np-239	1.000E+00	12				
Br-80			5	5	5	397	40
U-233			0	5	5	-	-

Gross Detector Response for user supplied detector parameters	
Source Material	Soil
Source Depth	100 cm.
Detector Size	0.5 x 1
Detector Height	10 cm.
Gross Detector Response (CPM)	89

Calculator Links

- ◆ PRG: <http://epa-prgs.ornl.gov/radionuclides/>
- ◆ DCC: <http://epa-dccs.ornl.gov/>
- ◆ SPRG: <http://epa-sprg.ornl.gov/>
- ◆ SDCC: <http://epa-sdcc.ornl.gov/>
- ◆ BPRG: <http://epa-bprg.ornl.gov/>
- ◆ BDCC: <http://epa-bdcc.ornl.gov/>
- ◆ BCG: In development. Scheduled finalization 2016.
- ◆ CPM: In development. Scheduled finalization 2016.
- ◆ SADA: <http://www.sadaproject.net/>





Radiation Risk Assessment Calculator Training

Section 11: SADA

Spatial Analysis & Decision Assistance

- ◆ SADA project engages research and development at the nexus of geospatial analytics, risk assessment, and decision analysis.
- ◆ Goals are to embed risk assessment (environmental, decision, etc.) , uncertainty modeling, and downstream decision processes entirely within a spatial context
- ◆ Two lanes define project activities
 - Advancing methods in a variety of areas particularly well connected to environmental regulatory community, characterization, remediation, RCRA, Superfund, MARSSIM etc
 - Freeware desktop application (SADA) integrating environmental risk analytics, spatial modeling, and decision sciences



Questions That SADA Addresses

- What exposure scenarios are likely dangerous?
- What contaminants are driving the risk?
- What pathways (ingestion, inhalation, etc)?
- What is the risk or concentration limit for an exposure time of 30 years?, 1 day? 1 hour?
- Where is exposure unsafe? Who might be in harms way? How sure are we?
- Where should we apply risk mitigation measures?
- Where and what type of additional information would support the model?
- What are our decision risks?

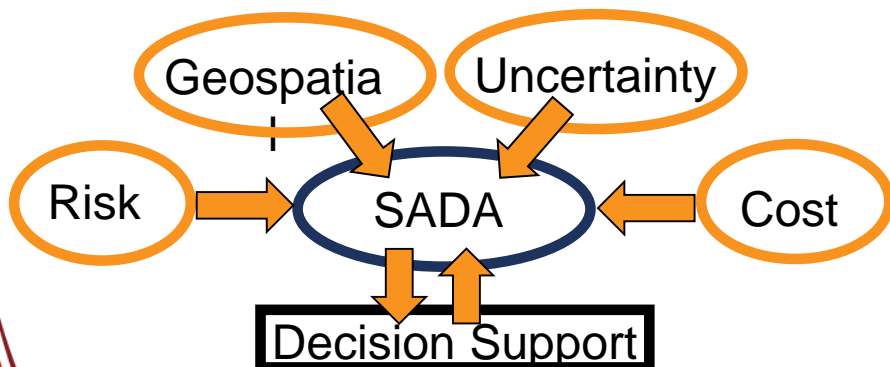

Answers that SADA V5&6 Provide

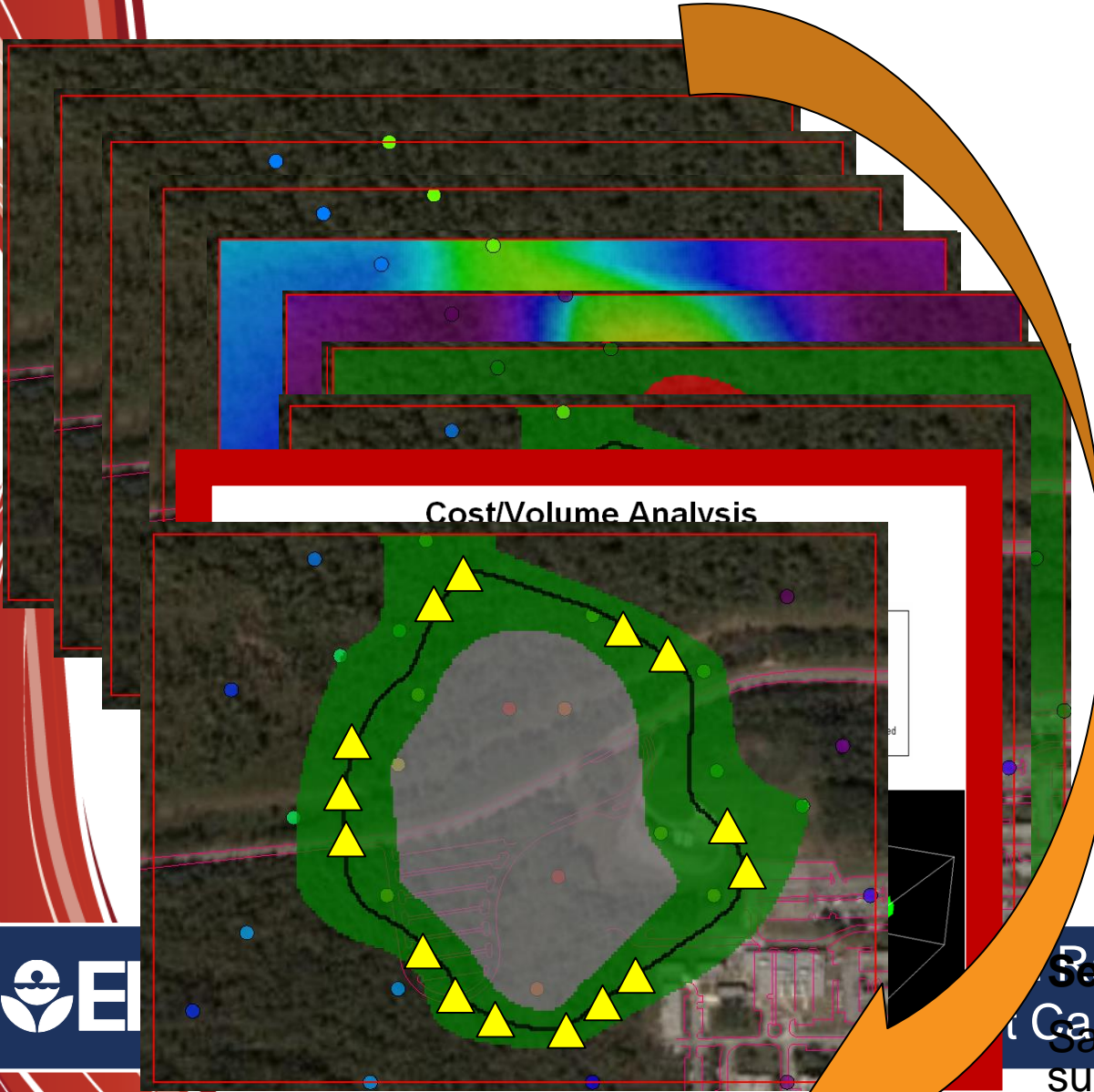

Traditionally, risk was used in an either/or rolling decision
Risk Based Sample Designs
 Data Collection
 Radiometric
 Data in context
 SADA integrates spatial
 Area of Investigation
 Multiple Contaminants
 that supports spatial
 uncertainty through the risk
State Referenced
 Moving Maps all or
 Full range of distance
 enabled by spatially
 based
 decision making offer better
 choices to stakeholders
 individual behaviors uncertainty
 3D Spatial Models
 Database of 1000s of
Cost Benefit Analytics

Built on risk-space models
 Permit what if's
 Quantify cost and *decision*
 risk reduction

Radiation Risk
Secondary Sample Designs
Calculator Training
 Sample where model needs most
 support....



How SADA Version 5 Looks

The screenshot displays the SADA (Spatial Analysis and Data Analysis) Version 5.0 software interface. The main window title is "SADA (C:\Program Files\SADA 5.0\ExampleSADAFfile.sda)". The menu bar includes File, Graphics, Data, Setup, Reports, Statistics, Export, Tools, and Help. The toolbar contains various icons for file operations, data manipulation, and visualization.

A red arrow points to the "Interpolate my data" option in the File menu. Below the menu is a task list with 15 numbered items:

4. Set grid specs
5. Interpolation methods
6. Choose helper data
7. Assess helper data
8. Correlation modeling
9. Search neighborhood
10. Show the results
11. Autodocumentation
12. Manage model results
13. Cross validation
14. Format picture
15. Export to file

Navigation buttons at the bottom include "<<Back", "Help", "Next >>", and a "Show The Results" button.

A dialog box is open, showing parameters for interpolation. It includes a "Percentile" dropdown set to "0.5" and a checked "Use this percentile" option. The "Type of Cokriging" is set to "Intrinsic Coregionalization". The "Data Transform" is set to "Unit transform (0 mean)". The "Intrinsic Model Variable" is set to "Primary".

A graph titled "Cost vs. Concentration Cleanup Goal" is displayed. The Y-axis is "Cost \$" ranging from 0.00 to 73,816,312.36. The X-axis is "Concentration Cleanup Goal" ranging from -0.02 to 4.02. The graph shows four curves: "Contaminated" (grey dashed line), "Might Be Clean" (yellow solid line), "Overburden" (blue solid line), and "Might Be Contaminated" (green solid line). The "Overburden" curve shows a sharp peak at a concentration goal of approximately 0.78, while the "Might Be Contaminated" curve shows a sharp peak at a concentration goal of approximately -0.02.

Version 6 Inputs

Contaminant Identification Results

An attempt has been made to match your contaminants with contaminants found in source file by Name and/or CAS number. Accept (register) or modify the results below as needed.

Matched

Anthracene (120127) Anthracene (120127)

Partial

Arsenic (7440382) Arsenic, Inorganic (7440382)

No Match

Registered

Ac-225 (14265851) as Ac-225 (14265851)
Barium (7440393) as Barium (7440393)

Set Human Health Exposure Parameters

Ac-225

Residential Recreator Farmer Indoor Worker Outdoor Worker Composite Worker Construction

Age-adjusted Parameters

	Adult	Child	Adjusted
Exposure frequency (days/year)	350	350	350
Exposure duration (years)	20	6	26
Exposure time (hours/day)	24	24	24
Soil ingestion rate (mg/day)	100	200	1120000
Soil inhalation rate (m3/day)	20	10	2064
Fruit ingestion rate (g/day)	178.1	68.1	1389710
Vegetable ingestion rate (g/day)	126.2	41.7	970970
Body weight (kg)	80	15	
Surface area (cm2/day)	6032	2690	
Adherence factor (mg/cm2)	0.07	0.02	
Dermal factor (mg/kg)			

General Parameters

Slab size (square m) 1

Cover layer thickness (cm) 0 (No cover)

Area of site (square m) 0.5

Averaging Time (day/year) 365

Lifetime (years) 70

Indoor gamma shielding factor (unitless) 0.4

Outdoor exposure time (hr/day) 1.752

Indoor exposure time (hr/day) 16.416

Fraction of vegetative cover 0.5

Plant Mass Loading Factor 0.26

SADA Risk and PRG results

Human Health Risk Results

Residential

Pathways

Ingestion External Beef
 Inhalation Fish Dairy
 Dermal Produce Swine

Rads/Soil/Residential/Carcinogen

	Name	CAS	Conc	Inhalation	External	Produce	Total
▶	Ac-225	14265851	2.9910786	2.49E-09	1.53E-11	1.62E-09	1.91E-07
*	Total			2.49E-09	1.53E-11	1.62E-09	1.91E-07

Human Health Risk Results

Residential

Pathways

Ingestion External Beef Poultry Fowl
 Inhalation Fish Dairy Egg Total
 Dermal Produce Swine Game

/Soil/Residential/Noncarcinogenic

	Name	CAS	Conc	Ingestion	Hazard (Adult)	Hazard (Child)
▶						
	Barium	7440393	74.4157051	4.46E-04	4.76E-03	
	Arsenic, Inor...	7440382	34.8220336	1.39E-01	1.48E+00	
	Anthracene	120127	3.0336929	1.21E-05	1.29E-04	
*	Total			1.40E-01	1.49E+00	

SADA Version 6

- ◆ Modern GIS infrastructure
- ◆ Advanced 3d visualization and scene creation

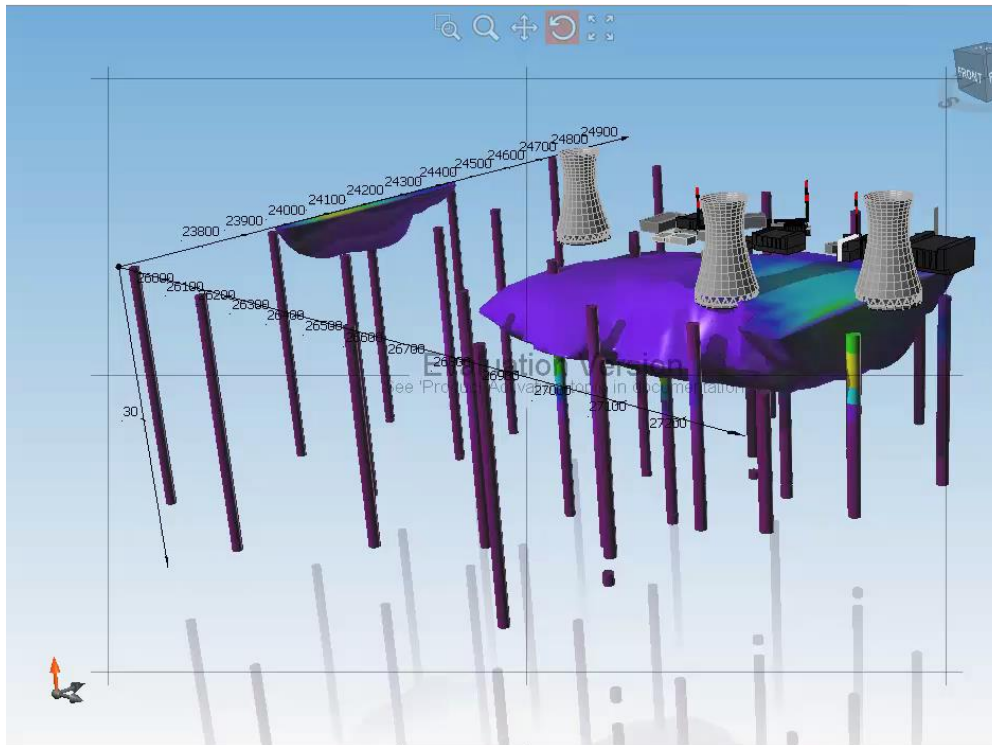

SADA Version 6

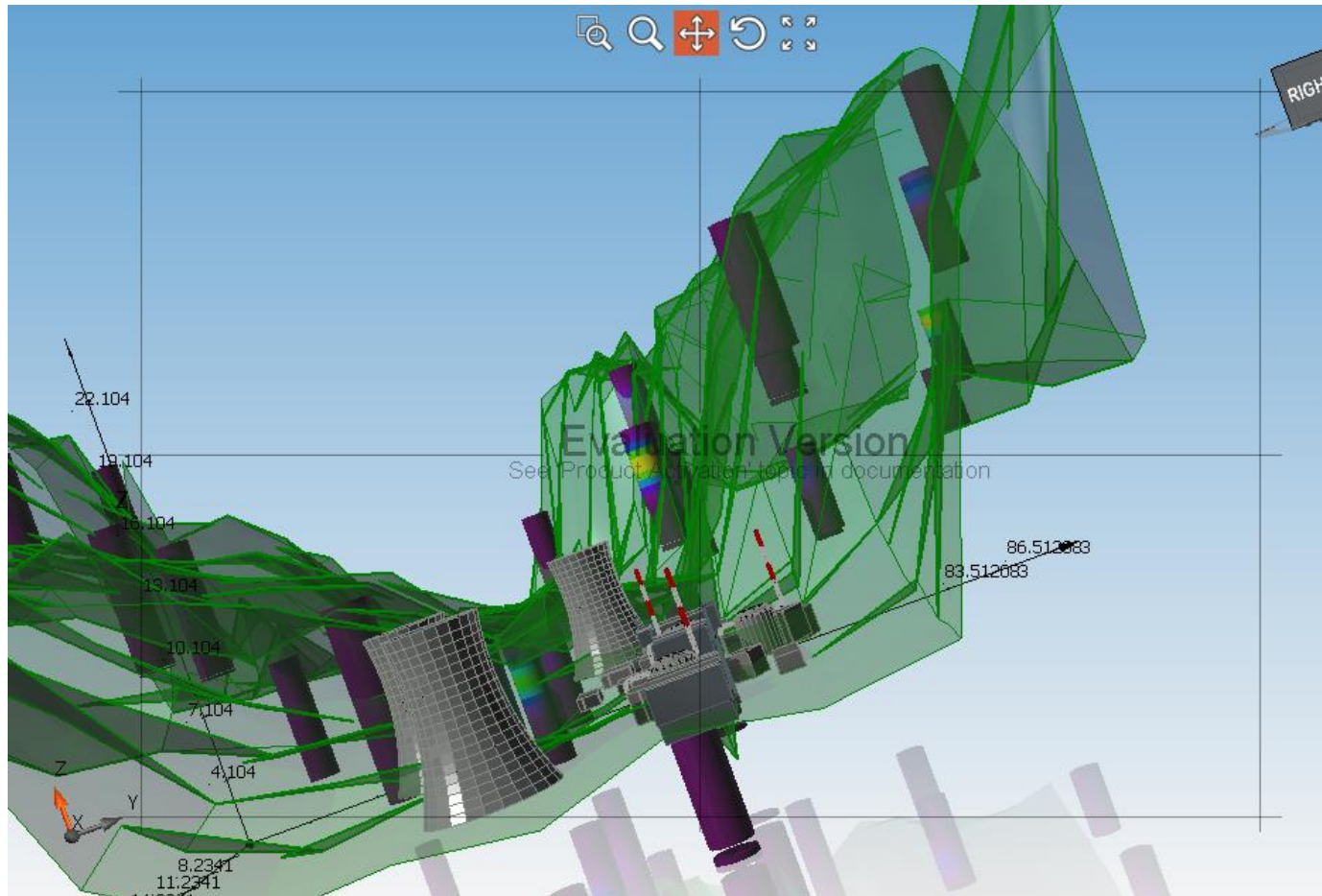

Thank You for Participating

◆ Contact: Stuart Walker

- walker.stuart@epa.gov
- (703) 603-8748

◆ Additional Resources

- Calculator Links (next slide)
- ITRC: <http://www.clu-in.org/conf/itrc/radsdd/resource.cfm>



Radiation Risk Assessment Calculator Training

Section 12: Radiation Primer

Radiation Outline

- Definitions/background
- Toxic effects
- Types of radiation
- Radiation Concepts and Units
- Decay products
- Decay chains
- Transfer and accumulation
- Common radionuclides

Background

- The primary stressor from radiological contamination is ionizing radiation resulting from the decay of unstable isotopes that have been released to the environment.

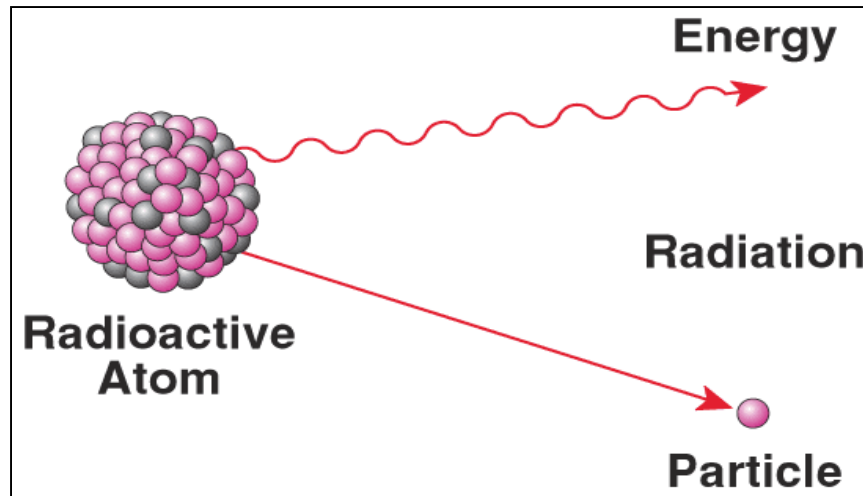

Ionizing Radiation

- Either particle or electromagnetic radiation
- Individual particles/photons carry enough energy to ionizing atoms by removing an electron from orbit.

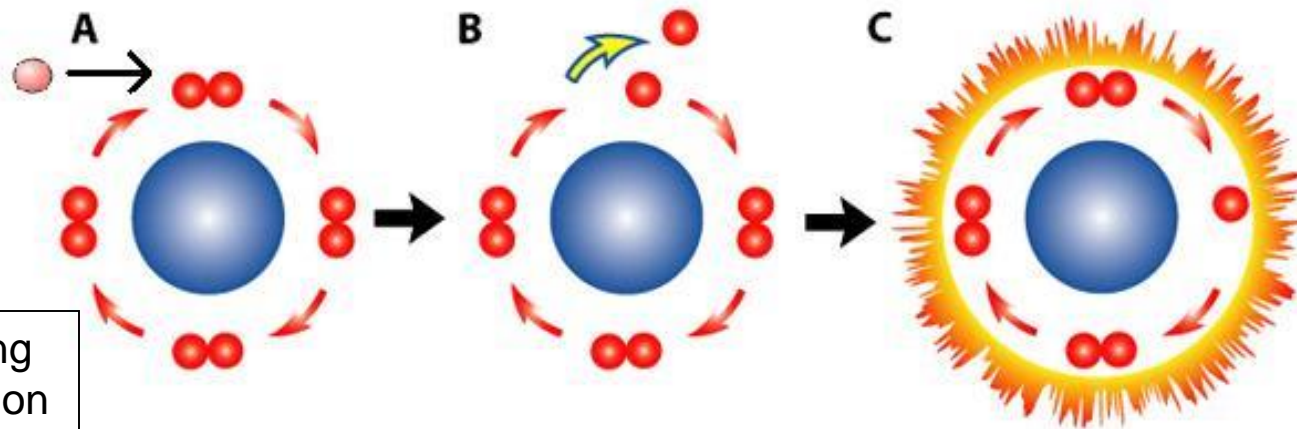

Ionizing
Radiation

Ionizing Radiation

- Ionized atoms/molecules can become free radicals, oxidants, and other highly reactive molecules.
- Can damage living tissue through DNA damage and mutation.
- Carcinogen, mutagen, and teratogen.

Toxic Effects

- Primarily effects at cellular level, rather than organ level.
- Possible outcomes of toxic effects.
 - Cells experience DNA damage; able to detect and repair the damage.
 - Cells experience DNA damage; unable to repair the damage. Cells go through programmed cell death, eliminating the potential genetic damage from the larger tissue.
 - Cells experience a nonlethal DNA mutation that is passed on to subsequent cell divisions. This mutation may contribute to the formation of a cancer.
- Cells and organisms can repair a limited amount of radiation damage.



Types of Radiation

- Alpha particles (α)
- Beta particles (β)
- Gamma rays (γ)

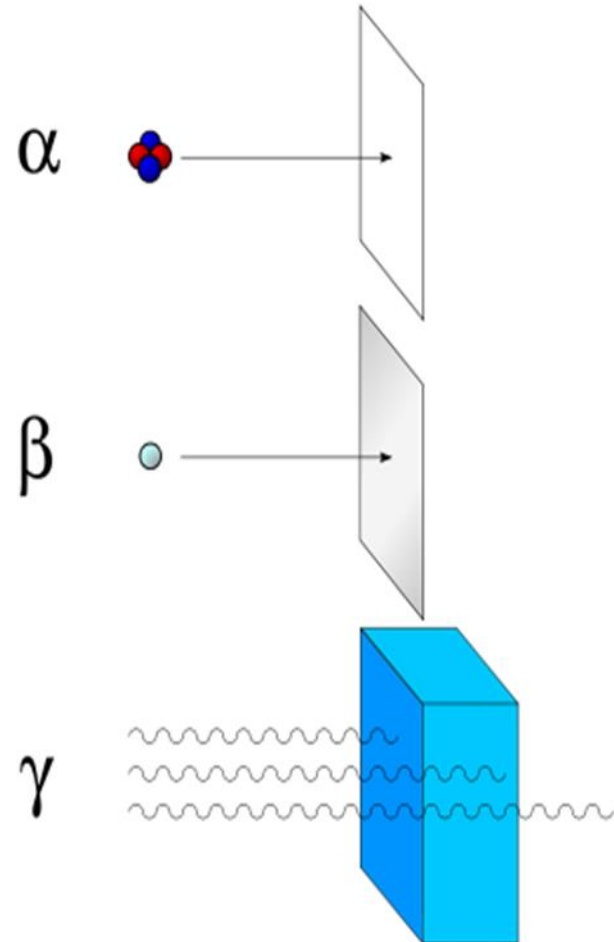

Alpha radiation:

- Consists of two protons and two neutrons bound together; helium atom stripped of electrons. ${}^4_2\text{He}^{2+}$
- Highly ionizing
- Low penetration, but highly destructive.
- Not considered dangerous unless ingested or inhaled.
- Not a significant source of risk in external dose pathways because of low penetration power.
- Primary source of risk in internal dose pathways.



Beta radiation

- High-speed, charged particles (electrons)
- Moderate penetrating power
 - Can penetrate skin
 - Require thin shielding (thin metal, clothes)
- Can enter body through ingestion, inhalation, unprotected open wounds, lens of eye

Gamma radiation

- Emission of electromagnetic radiation from nucleus.
- High-frequency, low wavelength
- High penetrating power
 - Penetrates deeply into tissue and damages internal organs.
 - Can travel long distances in air.

Radionuclides – Source of Ionizing Radiation

- A **radionuclide** is an atom with an unstable nucleus.
- The radionuclide can undergo radioactive decay and emit gamma rays and/or subatomic particles. These particles and rays constitute ionizing radiation.

Radionuclides

- A radionuclide will normally exhibit all the usual chemical characteristics of that atom/molecule.
 - Molecules that exhibit chemical toxicity will need to be addressed through standard risk assessment methods as well as the method used for ionizing radiation.
 - Fate and transport of radionuclides in the environment is generally determined by chemical properties, rather than isotopic properties.

Activity

- Transformation (or disintegration, or decay) rate of a radioactive substance.
- Measured in disintegrations per second (dps).
- Units
 - 1 Becquerel (Bq) = 1 dps
 - SI unit
 - 1 Curie (Ci) = 3.7×10^{10} dps = 3.7×10^{10} Bq
 - Usually use pCi. 1 pCi = 1×10^{-12} Ci

Absorbed Dose

- Energy imparted by radiation onto an absorbing material, or energy deposited per unit mass.
- Also known as Total Ionizing Dose (TID)
- Not a good indicator of biological effect because it does not account for RBE of different types of radiation.
- Units
 - 1 Gray (Gy) = 1 J/kg (SI unit)
 - 1 rad = 100 Gy (obsolete unit)

Dose Equivalent

- Dose in terms of its biological effect.
- $DE = \text{absorbed dose} \times W_R$
- $W_R = N * Q$
 - Q (quality factor) = RBE
 - Q = 1 for gamma, x-ray, and beta radiation
 - Q = 20 for alpha radiation
 - N – product of other multiplying factors
 - Depends on organ type, time and volume over which dose is spread, and species.

Dose Equivalent (cont.)

- The effectiveness of radiation in producing tissue damage is related to linear energy transfer (LET).
 - Greater LET indicates greater effectiveness of radiation in producing tissue damage.
- Units
 - Sievert (Sv) – same units as Gray
 - SI unit
 - 1 rem (Roentgen equivalent man) = 100 Sv
 - Obsolete unit

Exposure

- Ability of radiation to ionize air and create electric charges.
- Units
 - 1 Roentgen (R) = amount of radiation required to liberate positive and negative charges of 1 esu from 1 cm³ of dry air at STP
 - 1 R = 2.58×10^{-4} C/kg air

Decay Products

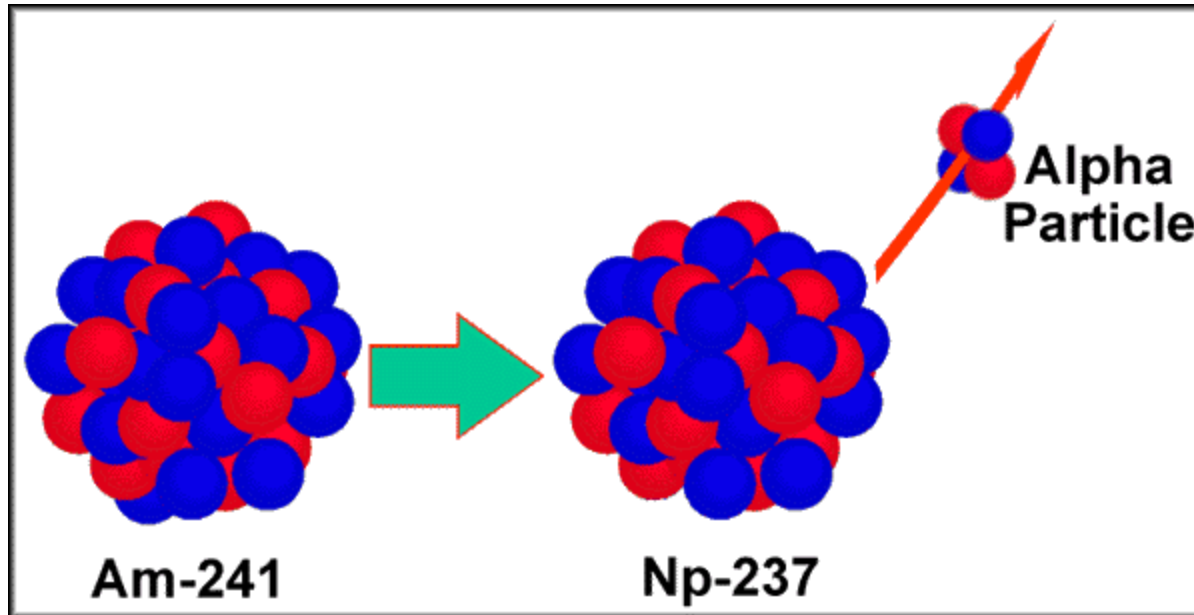

Alpha Decay of Americium-241 to Neptunium-237

The decay product (Np-237) is called a daughter product, daughter isotope or daughter nuclide.

Decay Products

- Alpha: subtract the ${}^4_2\text{He}^{2+}$ particle:
 - Atomic mass decreases by 4 amu.
 - Atomic number decreases by 2.
- Beta:
 - Atomic mass does not change.
 - Atomic number increases by 1 as a neutron is transmuted to an additional proton.
- Gamma:
 - Atomic particles are not emitted.
 - Atomic mass and number do not change.



Decay Chains

- Most radioactive elements do not decay directly to a stable state, but rather undergo a series of decays until a stable isotope is reached.
- A parent isotope decays to form a daughter isotope. The daughter may be stable, or can decay to form a daughter isotope of its own.

Decay Chains in Calculator

- Risk/dose coefficients are provided for several different decay chains for individual radionuclides. They factor in the decay energies for the parent isotope and subsequent daughter isotopes.
 - +D: 100-yr environmental commitment period
 - +E: 1000-yr environmental commitment pd.
 - +pD: Partial inclusion of daughters. When a long-lived daughter in decay chain is reached, the summing of decay energies are stopped.

Transfer and Accumulation

Exposure to ionizing radiation generally does not cause ambient media or biological tissues to become radioactive. This occurs through the transfer and accumulation of radionuclides that are the source of ionizing radiation.



Ionizing radiation is sometimes used to sterilize food and medical equipment.



Additivity of Exposure

- The absorbed dose (or dose rate) of ionizing radiation from all radionuclides, in all media, should be added together.
- Dose conversion factors (DCFs) are used to account for differences in ionizing energy and exposure.
- The safe exposure levels or Biota Dose Limits that have been established are based on the total absorbed dose of ionizing radiation.



Common Radionuclides

Some radionuclides commonly found at Superfund sites:

Americium-241

Cesium-137

Cobalt-60

Iodine-129, 131

Plutonium-239, 240,
241

Radium-226, 228

Radon-220, 222

Strontium-90

Technetium-99

Thorium-230, 232

^3H (Tritium)

Uranium-234, 235,
238



Radiation Risk Assessment Calculator Training

Section 13: Radiation Risk Assessment Basics



United States
Environmental Protection
Agency

Superfund Radiation Risk
Assessment Calculator Training

Basis of Radiological Risk Assessments

- Ionizing radiation is a carcinogen, a mutagen, and a teratogen.
- Cancer risks are usually the most harmful, so most assessments of harmful effects only consider carcinogenic effects.
- Risks from radiological exposure are generally estimated in a manner similar to exposures to chemical contaminants.
- Total incremental lifetime cancer risk from radiation exposure = sum of risks from all radionuclides in all exposure pathways.



Risk Approach

- Risk = exposure x cancer slope factor
- Exposure: estimated lifetime intake or external exposure (in Roentgen units)
- CSF: estimate of the probability of response; i.e. the probability of an individual developing cancer per unit intake.
 - CSF takes intake, uses set of assumptions and calculates absorbed dose.
 - Dose is compared to human exposure/cancer data and a risk of cancer is assigned.



Dose Approach

- **Dose = exposure x dose conversion factor**
- DCF: assigns a unit dose for every unit exposure. Based on an annual exposure to radiation.
- DCFs depend on:
 - Type of radiation
 - Relative strength of radiation
 - Target organs and tissues
 - Cancer induction rates

Dose Definitions

- **Absorbed dose:** expression of energy imparted per unit mass of tissue. Units: rad, Gray (Gy). $1 \text{ Gy} = 1 \text{ J/Kg} = 100 \text{ rads}$.
- **Dose equivalent (DE):** measure of the energy absorbed by living tissue, adjusted by the quality factor of different types of radiation. Units: rem, Sievert (Sv). $1 \text{ Sv} = 100 \text{ rems}$.

Dose Definitions (cont.)

- **Effective Dose Equivalent (EDE):** DE adjusted by organ-based weighting factors to provide a risk-based equivalence to external radiation dose.
- **Committed Effective Dose Equivalent (CEDE):** EDE summed over projected 50-yr exposure from internal radiation
- **Total Effective Dose Equivalent (TEDE) =** EDE (external) + CEDE (internal)

Example: Inhalation Pathway

- Risk =
(Inhalation slope factor) x (radionuclide concentration in air) x (breathing rate) x exposure duration
- Dose =
(DCF) x (radionuclide concentration in air) x (breathing rate) x (exposure duration)

Risk and Dose Approaches

Risk	Dose
Used by EPA.	Used by NRC and DOE.
Approach: cleanup of sites to a particular cancer risk	Approach: safe dose that protects workers and public from ongoing nuclear operations on site.
Lifetime exposure to an individual with a RME (EPA)	Annual exposure to an average member of critical group
Risk is unitless measurement of likelihood of an adverse effect.	Dose equivalent is measured in units of rem, mrem, or sievert.

Basis for Risk and Dose Approaches (cont.)

Risk	Dose
Standards expressed in terms of risk (e.g. CERCLA 10 ⁻⁴ to 10 ⁻⁶ range)	Standards expressed in terms of dose equivalent (e.g. NRC 25 mrem/year)
CSFs based primarily on US population.	DCFs based on populations from other nations.
Age- and sex-dependent risk models in CSFs	Age-dependent DCFs
CSFs do not consider genetic risk	DCFs consider genetic risk

Basis for Risk and Dose Approaches (cont.)

Risk	Dose
Considers causes of death other than rad-induced cancer.	Does not consider other competing causes of death.
Low-LET and high-LET estimates considered separately for each target organ.	DE includes both low-LET and high-LET rad multiplied by appropriate RBE factors
RBE for most sites = 20 RBE for breast = 10 RBE for leukemia = 1	RBE for alpha rad, all sites = 20

Basis for Risk and Dose Approaches (cont.)

Risk	Dose
Estimates of absorbed dose to 16 target organs/tissues, considered for 13 specific cancer sites, plus residual risk	Effective dose considers dose estimates to 12 target organs plus average of 10 other organs
Lung dose based on weighted sum of absorbed dose to tracheobronchial (80% weight) and pulmonary regions (20%)	Lung dose based on average dose to total lung (tracheobronchial, nasopharyngeal, and pulmonary regions)
Variable length to integration period (<110 years). Depends on organ-specific risk models and considerations of competing risks.	Fixed length of 50 years for integration period

Basis for Risk and Dose Approaches (cont.)

- **Reasonable maximum exposure (RME):** highest exposure that is reasonably expected to occur at a site; resulting from a combination of all intake variables.
- **Average member of critical group:** the group of individuals reasonably expected to receive the greatest exposure to residual radioactivity for any applicable set of circumstances.

Summary: Risk vs Dose

- EPA believes that the SF method produces a more reliable estimate of risk.
- Most national and international guidelines/standards for rad protection are in terms of dose or concentration.
 - Most standards are concerned w/radiological doses. No need to calculate associated risk – simply compare the dose to an appropriate dose-based standard.

Summary: Risk vs Dose (cont.)

- Dose can be converted into risk and vice versa using a probability coefficient.
 - Risk = total dose x probability coefficient (risk/unit dose)
 - Fed Guide 13: 8.46×10^{-4} /rem
- EPA believes that DCFs are **NOT** adequate for assessing risks, especially from internal exposure to alpha- and beta-emitting radionuclides.

Updates to Dose Equivalent Approach

- Most standards are based on DCFs in ICRP Publications 26/30 (1979)
- Revised DCFs in ICRP Publication 72 (1996).
 - Based on additional scientific data
 - More applicable to general public
 - Correspond to current cancer slope factors
- 2014 ORNL DCFs based on ICRP 107.



Updates to Slope Factor Approach

- Old slope factors issued in 2001
- Based on updated and improved radiation risk coefficients in Federal Guidance Report No. 13 (EPA 1999) and ICRP Publication 72.
- Updated risk coefficients are based on developments in radiation risk and dosimetry.
- New Slope Factors issued in 2014 from ORNL based on ICRP 107.

Updates to Slope Factor Approach (cont.)

- Changes to Slope Factors (ORNL 2014) include:
 - Cancer risk model updated
 - Biokinetic and dosimetry models
 - External dosimetry models
 - Exposure pathways expanded
 - Population group now based on average member of general public (vs. adult worker)