

ERDC/EL TR-03-1

Environmental Laboratory



**US Army Corps  
of Engineers®**  
Engineer Research and  
Development Center

# **Evaluation of Dredged Material Proposed for Disposal at Island, Nearshore, or Upland Confined Disposal Facilities — Testing Manual**

U.S. Army Corps of Engineers

January 2003

The contents of this report are not to be used for advertising, publication, or promotional purposes. Citation of trade names does not constitute an official endorsement or approval of the use of such commercial products.

The findings of this report are not to be construed as an official Department of the Army position, unless so designated by other authorized documents.



PRINTED ON RECYCLED PAPER

ERDC/EL TR-03-1  
January 2003

# **Evaluation of Dredged Material Proposed for Disposal at Island, Nearshore, or Upland Confined Disposal Facilities — Testing Manual**

by U.S. Army Corps of Engineers  
U.S. Army Engineer Research and Development Center  
3909 Halls Ferry Road  
Vicksburg, MS 39180-6199

Final report

Approved for public release; distribution is unlimited

Prepared for U.S. Army Corps of Engineers  
Washington, DC 20314-1000

# Contents

---

Preface .....	xvi
1—Introduction .....	1-1
1.1 Background .....	1-1
1.2 Purpose and Scope .....	1-3
1.3 CDF Contaminant Pathways .....	1-3
1.4 Applicability.....	1-5
1.4.1 Disposal in CDFs.....	1-5
1.4.2 This Manual Does Not Address.....	1-5
1.4.3 Relationship to Other Dredged Material Management Efforts .....	1-6
1.5 Organization and Approach for Evaluations .....	1-7
1.6 Statutory and Regulatory Overview .....	1-8
1.6.1 Statutory Overview .....	1-9
1.6.2 Other Regulatory Considerations.....	1-11
1.7 References .....	1-12
2—Structure and Approach of the UTM .....	2-1
2.1 Tiered Structure for Evaluations and Testing.....	2-1
2.1.1 Tier I.....	2-2
2.1.2 Tier II.....	2-2
2.1.3 Tier III .....	2-2
2.1.4 Tier IV .....	2-4
2.1.5 Progressing through the Tiers .....	2-5
2.1.6 Decisions after Each Tier.....	2-6
2.1.7 Management Actions .....	2-6
2.2 Considerations for Risk Assessment .....	2-7
2.2.1 Overview of Risk Assessment .....	2-7
2.2.2 Contaminants of Concern .....	2-10
2.2.3 Receptors of Concern .....	2-10
2.2.4 Basis of Management Action Decisions .....	2-10
2.3 Fundamentals of Testing and Evaluation .....	2-13
2.3.1 Sampling and Chemical Analysis .....	2-13
2.3.2 Applicable Standards.....	2-13
2.3.3 Consideration of Mixing/Attenuation/Dispersion Zones .....	2-14
2.3.4 Control Material .....	2-14
2.3.5 Reference Material for Plant and Animal Uptake Evaluations ...	2-15
2.3.6 Statistical Considerations.....	2-17
2.4 References .....	2-17

3—Initial Evaluations .....	3-1
3.1 Determination of the Need for Contaminant Evaluations.....	3-1
3.2 Identification of Relevant Pathways .....	3-2
3.2.1 Environmental Setting and General Characteristics.....	3-2
3.2.2 CDF Design and Management Characteristics .....	3-3
3.2.3 Dredged Material Characteristics.....	3-4
3.2.4 Identifying Relevant Pathways .....	3-4
3.3 Compilation of Information.....	3-5
3.4 Identification of Contaminants of Concern (COC).....	3-8
3.4.1 Need for Sediment Chemistry.....	3-9
3.4.2 Characteristics of Contaminants of Concern.....	3-9
3.4.3 Documentation of COC .....	3-11
3.5 Consideration of Prior Evaluations and Testing.....	3-12
3.6 Tier I Decisions.....	3-12
4—Effluent During Disposal Operations.....	4-1
4.1 General Considerations .....	4-1
4.1.1 Effluent Processes.....	4-1
4.1.2 Method of Filling.....	4-2
4.1.3 Regulatory Considerations.....	4-3
4.1.4 Mixing Zones.....	4-3
4.1.5 Data Requirements .....	4-4
4.1.6 CDF Design for Dredged Material Retention .....	4-5
4.1.7 Summary of Tiered Evaluations for Effluent.....	4-5
4.1.8 Sampling Requirements.....	4-7
4.2 Tier I - Initial Evaluation of Effluent.....	4-7
4.3 Tier II - Water Quality Screens for Effluent.....	4-7
4.3.1 Tier II – Effluent Quality Screen - Assumed Total Dissolved Release .....	4-8
4.3.2 Tier II - Effluent Quality Screen - Equilibrium Partitioning.....	4-9
4.3.3 Tier II – Effluent Decisions .....	4-9
4.4 Tier III – Effluent Water Quality and Toxicity Evaluations.....	4-10
4.4.1 Tier III - Effluent Total Suspended Solids Evaluation.....	4-10
4.4.2 Tier III - Effluent Water Quality Evaluation – Effluent Elutriate Test (EET).....	4-11
4.4.3 SETTLE – Computer-Assisted Settling Data Analysis.....	4-13
4.4.4 EFQUAL - Computer Assisted Analysis of Effluent Water Quality.....	4-14
4.4.5 Tier III - Effluent Elutriate - Water Quality Decision .....	4-15
4.4.6 Tier III - Effluent Toxicity Evaluation .....	4-15
4.4.7 LAT-E - Computer-Assisted Effluent Toxicity Evaluation .....	4-16
4.4.8 Tier III - Effluent Toxicity Decision .....	4-16
4.5 Tier IV - Effluent Risk Assessment.....	4-17
4.5.1 Evaluation.....	4-17
4.5.2 Tier IV Effluent Decision .....	4-17
4.6 Effluent Management Actions .....	4-17
4.7 References.....	4-18
5—Surface Runoff After Disposal Operations .....	5-1
5.1 General Considerations .....	5-1

5.1.1	Runoff Processes .....	5-2
5.1.2	Influence of CDF Design and Operation on Runoff .....	5-3
5.1.3	Regulatory Considerations.....	5-3
5.1.4	Mixing Zones.....	5-3
5.1.5	Data Requirements .....	5-4
5.1.6	CDF Design for Runoff Control .....	5-4
5.1.7	Overview of Evaluations for Runoff Discharges .....	5-5
5.2	Tier I - Initial Evaluation of Runoff .....	5-5
5.3	Tier II – Water Quality Screen for Runoff .....	5-7
5.3.1	Tier II - Runoff Water Quality Screen - Equilibrium Partitioning.....	5-7
5.3.2	Tier II - Runoff Water Quality Decision .....	5-8
5.4	Tier III – Runoff Water Quality and Toxicity Evaluations.....	5-9
5.4.1	Tier III - Runoff Simulation Approaches.....	5-9
5.4.2	Tier III - Simplified Laboratory Runoff Procedure (SLRP).....	5-9
5.4.3	Tier III - Rainfall Simulator/Lysimeter System (RSLs).....	5-10
5.4.4	RUNQUAL Computer Assisted Analysis of Runoff Quality .....	5-11
5.4.5	Tier III - Runoff Water Quality Decision.....	5-12
5.4.6	Tier III - Runoff Toxicity Evaluation.....	5-12
5.4.7	LAT-R Computer Assisted Runoff Toxicity Evaluation.....	5-13
5.4.8	Tier III - Runoff Toxicity Decision.....	5-13
5.5	Tier IV – Runoff Risk Assessment.....	5-14
5.5.1	Tier IV Runoff Evaluation.....	5-14
5.5.2	Tier IV Runoff Decision .....	5-14
5.6	Runoff Management Actions .....	5-14
5.7	References and Bibliography .....	5-15
6	Leachate to Groundwater .....	6-1
6.1	General Considerations .....	6-1
6.1.1	Leachate and Contaminant Transport Considerations.....	6-2
6.1.2	Water Quality Standards for Leachate .....	6-4
6.1.3	Consideration of Attenuation.....	6-5
6.1.4	Data Requirements .....	6-5
6.1.5	Disposal Area Design .....	6-6
6.1.6	Summary of Tiered Evaluations for Leachate.....	6-6
6.2	Tier I Leachate Evaluation .....	6-8
6.3	Tier II Leachate Quality Evaluations.....	6-8
6.3.1	Tier II - Leachate Quality Screen.....	6-8
6.3.2	Tier II - Leachate Decision .....	6-9
6.4	Tier III - Leachate Quality Evaluations .....	6-9
6.4.1	Tier III - Sequential Batch Leachate Test (SBLT) .....	6-11
6.4.2	Tier III - Pancake Column Leachate Testing (PCLT) .....	6-12
6.4.3	Tier III - SBLT or PCLT Adsorption or Challenge Testing.....	6-12
6.4.4	Tier III - Groundwater Modeling .....	6-13
6.4.5	Tier III Leachate Quality Decision.....	6-15
6.5	Tier IV - Leachate Risk Assessment .....	6-16
6.5.1	Evaluation.....	6-16
6.5.2	Tier IV Leachate Decision .....	6-16
6.6	Leachate Management Actions .....	6-16
6.7	References and Bibliography .....	6-17

7—Guidance for Evaluation of Volatile Emissions .....	7-1
7.1 General Considerations .....	7-1
7.1.1 Volatilization Processes .....	7-1
7.1.2 Condition 1 - Submerged Dredged Material .....	7-3
7.1.3 Condition 3 - Exposed Dredged Material .....	7-3
7.1.4 Regulatory Considerations.....	7-4
7.1.5 Data Requirements .....	7-5
7.1.6 Summary of Tiered Evaluations for Volatile Emissions .....	7-5
7.1.7 OSHA Air Quality Standards .....	7-6
7.2 Tier I – Initial Evaluation of Volatile Emissions .....	7-8
7.3 Tier II – Volatile Emissions Screen.....	7-8
7.3.1 Tier II – Volatilization Screen .....	7-9
7.3.2 Tier II - Volatile Emissions Decision.....	7-9
7.4 Tier III – Volatile Flux Chamber Test.....	7-10
7.4.1 Volatile Emissions Laboratory Test Procedure - Volatile Flux Chamber (VFC).....	7-10
7.4.2 Tier III - Volatile Emissions Decision .....	7-10
7.5 Dispersion Evaluations for Volatile Emissions .....	7-11
7.6 Tier IV – Volatile Emissions Risk Assessment .....	7-12
7.6.1 Evaluation.....	7-12
7.6.2 Tier IV - Volatile Emissions Decision .....	7-12
7.7 Volatile Emissions Controls .....	7-13
7.8 References and Bibliography .....	7-13
8—Animal Bioaccumulation .....	8-1
8.1 General Considerations .....	8-1
8.1.1 Animal Bioaccumulation Processes.....	8-1
8.1.2 Regulatory Considerations.....	8-1
8.1.3 Data Requirements .....	8-3
8.1.4 Summary of Tiered Evaluation of Animal Bioaccumulation .....	8-3
8.2 Tier I – Initial Evaluation of Animal Bioaccumulation .....	8-5
8.2.1 Compilation and Evaluation of Existing Information .....	8-6
8.2.2 Development of Conceptual Site Model.....	8-6
8.2.3 Tier I - Evaluation Procedure.....	8-9
8.2.4 Tier I - Animal Bioaccumulation Decision.....	8-10
8.3 Tier II – Theoretical Bioaccumulation Potential .....	8-10
8.3.1 Tier II – Theoretical Bioaccumulation Potential Procedure .....	8-11
8.3.2 Tier II – Theoretical Bioaccumulation Potential Decision .....	8-12
8.4 Tier III – Animal Bioaccumulation Test .....	8-12
8.4.1 Tier III – Animal Uptake Test Procedure .....	8-12
8.4.2 Tier III - Animal Bioaccumulation Decision .....	8-13
8.5 Tier IV – Animal Bioaccumulation Risk Assessment .....	8-14
8.5.1 Evaluation.....	8-14
8.5.2 Tier IV - Animal Bioaccumulation Decision .....	8-14
8.6 Animal Bioaccumulation Management Actions.....	8-15
8.7 References .....	8-15
9—Plant Bioaccumulation .....	9-1
9.1 General Considerations .....	9-1
9.1.1 Plant Bioaccumulation Processes.....	9-1

9.1.2 Regulatory Considerations.....	9-1
9.1.3 Data Requirements .....	9-3
9.1.4 Summary of Tiered Evaluation of Plant Bioaccumulation.....	9-3
9.2 Tier I – Initial Evaluation of Plant Bioaccumulation.....	9-4
9.2.1 Compilation and Evaluation of Existing Information .....	9-4
9.2.2 Tier I - Evaluation Procedure.....	9-5
9.2.3 Tier I - Plant Bioaccumulation Decision.....	9-5
9.3 Tier II – Prediction of Plant Bioaccumulation Potential.....	9-7
9.3.1 Tier II - Prescreen Evaluation of Field Plant Tissue .....	9-7
9.3.2 DTPA Procedure for Prediction of Plant Bioaccumulation Potential .....	9-7
9.3.3 Tier II - Plant Uptake Program (PUP).....	9-8
9.3.4 Tier II - Plant Bioaccumulation DTPA Decision .....	9-8
9.4 Tier III – Plant Bioaccumulation Test .....	9-9
9.4.1 Tier III - Plant Survival and Growth.....	9-10
9.4.2 Tier III - Plant Bioaccumulation of Contaminants .....	9-10
9.4.3 Tier III - Plant Bioaccumulation Decision .....	9-11
9.5 Tier IV – Plant Bioaccumulation Risk Assessment.....	9-11
9.5.1 Evaluation.....	9-11
9.5.2 Tier IV - Plant Bioaccumulation Decision.....	9-12
9.5.3 Plant Bioaccumulation Management Actions.....	9-12
9.6 References.....	9-12
10—CDF Contaminant Management Actions .....	10-1
10.1 Operational Management Actions.....	10-2
10.2 Treatment of Effluent, Runoff, and Leachate Discharges .....	10-3
10.3 Engineered Control Measures .....	10-3
10.3.1 Barrier systems .....	10-4
10.3.2 Surface covers.....	10-4
10.3.3 Liners.....	10-4
10.4 Treatment of Dredged Material Solids .....	10-5
10.5 Guidance for CDF Management Actions .....	10-5
10.6 References.....	10-5
Appendix A: Glossary .....	A1
Appendix B: Column Settling Test and Effluent Elutriate Procedures.....	B1
B.1 Introduction .....	B1
B.2 Effluent Elutriate Tests for Water Quality Evaluation.....	B1
B.2.1 Apparatus.....	B2
B.2.2 Effluent elutriate test procedure .....	B3
B.2.3 Chemical analyses.....	B6
B.2.4 Effluent contaminant concentrations.....	B7
B.3 Effluent Elutriate for Water Column Toxicity .....	B8
B.3.1 Effluent elutriate apparatus .....	B8
B.3.2 Effluent elutriate procedure.....	B8
B.3.3 Effluent Elutriate Toxicity Evaluation .....	B9
B.4 Column Settling Tests for Effluent TSS/Turbidity .....	B9
B.4.1 Column settling test apparatus .....	B9
B.4.2 Column settling test procedure.....	B13



B.5 References .....	B14
Appendix C: Test Procedures for Surface Runoff Discharges.....	C1
C.1 Introduction .....	C1
C.2 Simplified Laboratory Runoff Procedure for Runoff Quality	
Evaluation.....	C1
C.2.1 Materials and apparatus .....	C2
C.2.2 Procedure .....	C3
C.3 Rainfall Simulator/Lysimeter System (RSLs) Procedure for Evaluation of	
Surface Runoff Quality.....	C6
C.3.1 Materials and apparatus .....	C6
C.3.2 Sediment characterization .....	C8
C.3.3 RSLs procedure.....	C8
C.3.4 Characterization of runoff samples and preparation for analysis...	C8
C.3.5 Other analyses of runoff water .....	C9
C.3.6 Interpretation of results .....	C9
C.4 Runoff Toxicity Evaluation .....	C9
C.4.1 Runoff water preparation for water column toxicity test.....	C10
C.4.2 Apparatus.....	C10
C.4.3 Test procedure.....	C10
C.4.4 LAT-R computer-assisted runoff toxicity evaluation .....	C11
C.5 References .....	C11
Appendix D: Leachate Testing Procedures.....	D1
D.1 Introduction .....	D1
D.2 Theoretical Basis and Considerations for Testing .....	D1
D.2.1 Equilibrium Assumption.....	D1
D.2.2 Equilibrium-controlled desorption in a CDF .....	D4
D.2.3 Oxidation status of sediment.....	D5
D.2.4 Ionic Strength.....	D5
D.2.5 Considerations in Test Selection and Test Conditions .....	D8
D.3 Sequential Batch Leach Test (SBLT) for Freshwater Sediments .....	D9
D.3.1 Materials and apparatus .....	D10
D.3.2 Procedure .....	D11
D.3.3 Data presentation .....	D12
D.4 Pancake Column Leach Test for Estuarine Sediments .....	D13
D.4.1 Column materials and apparatus .....	D13
D.4.2 Column Preparation Procedure .....	D15
D.4.3 Collection and preservation of column leachate samples for	
total metal, chloride ion, total organic carbon, pH, and electrical	
conductivity analyses .....	D16
D.4.4 Collection and preservation of column leachate samples for	
analysis of organic constituents .....	D19
D.5 References .....	D21
Appendix E: Evaluation of Mixing in Surface Waters .....	E1
E.1 Introduction .....	E1
E.1.1 Background .....	E1
E.1.2 Regulatory considerations .....	E2
E.1.3 Potential applications of initial mixing.....	E2

E.1.4 Evaluation of dissolved contaminant concentrations by comparison with WQS .....	E3
E.1.5 Evaluation of concentrations of suspended plus dissolved constituents by comparison with toxicity test results.....	E3
E.1.6 Physical characteristics of dredged material discharges .....	E3
E.1.7 Confined disposal facility (CDF) effluent discharge .....	E3
E.1.8 Surface runoff discharge .....	E4
E.2 Applicability of Models and Techniques .....	E4
E.2.1 General considerations .....	E4
E.2.2 Considerations for tidally influenced rivers and estuaries .....	E4
E.2.3 Recommended models and techniques.....	E5
E.3 Cornell Mixing Zone Expert System (CORMIX).....	E5
E.4 Macintyre Analytical Method for CDF Discharge in Riverine Conditions .....	E6
E.4.1 Introduction.....	E6
E.4.2 Data requirements .....	E7
E.4.3 Calculation procedure .....	E7
E.4.4 Example mixing-zone calculation .....	E11
E.5 Fasttabs Modeling System for Evaluation of Hydrodynamic Transport .....	E14
E.6 Dilution Volume Method for CDF Effluent Discharges.....	E15
E.6.1 Approach.....	E15
E.6.2 Sample computations .....	E18
E.7 References .....	E19
Appendix F: Laboratory Evaluation of Volatile Emissions and Volatile Dispersion Modeling .....	F1
F.1 Introduction.....	F1
F.2 Laboratory Volatile Emission Test Procedure.....	F1
F.2.1 Apparatus .....	F2
F.2.2 Flux chamber.....	F2
F.2.3 Sediment preparation.....	F3
F.2.4 Laboratory conditions.....	F4
F.2.5 Laboratory volatile emissions test procedure.....	F4
F.2.6 Data analysis.....	F5
F.3 Volatile Exposure Evaluation .....	F6
F.3.1 Site exposure concentration.....	F6
F.3.2 Off-site exposure concentration.....	F7
F.4 References.....	F8
Appendix G: Animal Bioaccumulation Test Procedures .....	G1
G.1 Introduction .....	G1
G.2 Tier II - Theoretical Bioaccumulation Potential (TBP) of Nonpolar Organic Chemicals.....	G1
G.3 Tier III – Terrestrial Animal Bioaccumulation Test .....	G3
G.3.1 Terrestrial species selection .....	G3
G.3.1.1 Life history .....	G3
G.3.1.2 Taxonomy .....	G4
G.3.2 Laboratory procedures .....	G4
G.3.2.1 Test variations .....	G6

G.3.2.2 Chemical analysis.....	G6
G.3.3 Data presentation and analysis .....	G6
G.4 References .....	G7
Appendix H: Plant Bioaccumulation Procedures.....	H1
H.1 Introduction .....	H1
H.2 DTPA Extraction Procedure for Plant Bioaccumulation .....	H1
H.2.1 Materials .....	H2
H.2.2 Sediment preparation .....	H2
H.2.3 Sediment characterization .....	H2
H.2.4 DTPA extraction procedure .....	H3
H.2.5 Prediction of plant bioaccumulation and comparison to reference.....	H3
H.2.6 Comparison of DTPA results to reference .....	H4
H.3 Laboratory Plant Bioaccumulation Procedures.....	H5
H.3.1 Plant bioaccumulation/toxicity assessment .....	H5
H.3.2 Apparatus and materials.....	H5
H.3.3 Sediment collection and preparation .....	H7
H.3.4 Sediment characterization .....	H7
H.3.5 Greenhouse operation and bioaccumulation techniques .....	H8
H.3.6 Plant tissue collection and preparation for analysis.....	H9
H.3.7 Data presentation and analysis .....	H9
H.4 References .....	H9
Appendix I: Reserved .....	I1
Appendix J: Reserved.....	J1
Appendix K: Reserved.....	K1
Appendix L: Statistical Methods .....	L1
L.1 Introduction .....	L1
L.1.1 Basic statistics .....	L3
L.1.2 Hypothesis testing .....	L6
L.1.3 Experimental design .....	L8
L.2 Statistical Methods for Water Column Tests .....	L9
L.2.1 Water column toxicity tests .....	L9
L.2.1.1 Comparison of 100 percent elutriate and dilution water .....	L9
L.2.1.1.1 Methods.....	L9
L.2.1.1.2 Analysis of example data.....	L15
L.2.1.2 Calculating median lethal concentration .....	L19
L.2.1.2.1 Methods for calculating LC <sub>50</sub> .....	L20
L.2.1.2.2 Analysis of example data.....	L24
L.2.2 Linear regression .....	L25
L.3 Statistical Methods for Bioaccumulation .....	L27
L.3.1 Methods for multiple comparisons .....	L27
L.3.2 Analysis of example data.....	L30
L.3.2.1 Comparisons with a reference sediment.....	L30
L.3.2.2 Comparison with an action level.....	L36
L.3.3 Bioaccumulation from field data .....	L39

L.4 SAS Programs and Output for Example Data.....	L40
L.4.1 Program WATTOX.SAS for water column toxicity test data analysis.....	L40
L.4.1.1 WATTOX.SAS program statements.....	L41
L.4.1.2 WATTOX.SAS program output.....	L44
L.4.2 Program BIOACC.SAS for bioaccumulation test data analysis ..	L48
L.4.2.1 BIOACC.SAS program statements.....	L49
L.4.2.2 BIOACC.SAS program output .....	L53
L.5 References .....	L60

SF 298

## List of Figures

---

Figure 1-1.	Schematic of upland, nearshore, and island CDFs (after USACE/EPA 1992).....	1-2
Figure 1-2.	Schematic of contaminant migration pathways for upland CDFs.....	1-4
Figure 1-3.	Schematic of contaminant migration pathways for nearshore CDFs .....	1-5
Figure 2-1.	Flowchart illustrating the overall evaluation process for CDF pathways .....	2-3
Figure 2-2.	Schematic illustration of the relationship of the four major components of risk assessment.....	2-9
Figure 2-3.	Lower levels of biological organization are more tractable for testing than higher levels, but are less ecologically relevant.....	2-11
Figure 4-1.	Schematic of supernatant water interaction in an active confined disposal facility affecting effluent quality .....	4-2
Figure 4-2.	Flowchart illustrating tiered evaluation approach for the effluent pathway .....	4-6
Figure 4-3.	Photo of 8-inch settling column test .....	4-11
Figure 4-4.	Photo of typical laboratory setup for the effluent elutriate test .....	4-12
Figure 4-5.	Possible conditions for comparison of effluent concentrations with standards.....	4-14
Figure 5-1.	Illustration of the CDF surface runoff process.....	5-2

Figure 5-2.	Flowchart illustrating tiered evaluation approach for the runoff pathway.....	5-6
Figure 5-3.	Photo of the simplified laboratory runoff procedure (SLRP) apparatus.....	5-10
Figure 5-4.	Photo of the Rainfall Simulator/Lysimeter System (RSLs).....	5-11
Figure 6-1.	Illustration of potential CDF leachate pathways .....	6-2
Figure 6-2.	Illustration of the vadose zone, saturated groundwater flow zone, and leachate pathway to groundwater receptors .....	6-3
Figure 6-3.	Flowchart illustrating tiered evaluation approach for the leachate pathway.....	6-7
Figure 6-4.	Photo of Sequential Batch Leachate Test setup .....	6-10
Figure 6-5.	Photo of Pancake Column Leach Test setup.....	6-10
Figure 7-1.	Illustration of locales or conditions for volatile emissions from CDFs .....	7-3
Figure 7-2.	Flowchart illustrating tiered approach for evaluation of the volatile pathway .....	7-6
Figure 7-3.	Photo of the volatile flux chamber device.....	7-10
Figure 8-1.	Flowchart illustrating tiered evaluation approach for the animal uptake pathway .....	8-4
Figure 8-2.	Photo of the animal uptake bioassay setup .....	8-13
Figure 9-1.	Flowchart illustrating tiered evaluation approach for the plant uptake pathway .....	9-6
Figure 9-2.	Photo of the plant bioassay test setup .....	9-9
Figure B-1.	Schematic of Effluent Elutriate Test.....	B4
Figure B-2.	Schematic of the Long Tube Column Settling Test .....	B10
Figure B-3a.	Specifications and Plan for Long Tube Settling Column.....	B11
Figure B-3b.	Plans for top and bottom sections of Long Tube Settling Column .....	B12
Figure D-1.	Model of dredged material leaching .....	D2
Figure D-2.	Interphase transfer processes and factors affecting interphase transfer processes.....	D3
Figure D-3.	Illustration of local equilibrium assumption for leaching in a CDF .....	D5

Figure D-4.	Desorption isotherms for slope-derived and single-point distribution coefficients .....	D6
Figure D-5.	Desorption isotherm illustrating nonconstant and constant partitioning .....	D7
Figure D-6.	Schematic of the Pancake Column Leach Test Apparatus.....	D14
Figure E-1.	Schematic of typical single-source effluent discharging into a receiving water body with unidirectional flow.....	E7
Figure E-2.	Simplified shape assumed for mixing zone associated with an effluent discharge.....	E16
Figure F-1.	Flux chamber for quantifying volatile emissions in a laboratory setting .....	F3
Figure F-2.	Laboratory sampling schematic .....	F5
Figure F-3.	Phenanthrene fluxes from a contaminated dredged material.....	F6
Figure H-1.	Plant bioaccumulation double bucket apparatus.....	H6
Figure L-1.	Water column toxicity test decision tree .....	L18
Figure L-2.	LC <sub>50</sub> decision tree .....	L21
Figure L-3.	SAS probit plot of water column toxicity test example data .....	L25
Figure L-4a.	Bioaccumulation Test Decision Tree (Parametric Tests).....	L33
Figure L-4b.	Bioaccumulation Test Decision Tree (Nonparametric Tests) .....	L34
Figure L-5.	Comparison of mean dredged material contaminant tissue levels and 95 percent upper confidence level (UCL) with hypothetical action level .....	L38

## List of Tables

---

Table 2-1.	Summary of Evaluation Structure and Procedures in UTM .....	2-4
Table 4-1.	Summary of Data Requirements for Prediction of the Quality of Effluent from Confined Dredged Material Disposal Areas.....	4-5

Table 5-1.	Summary of Data Requirements for Prediction of the Quality of Runoff from Confined Dredged Material Disposal Areas.....	5-4
Table 6-1.	Summary of Data Requirements for Prediction of the Quality of Leachate from Confined Dredged Material Disposal Areas.....	6-6
Table 7-1.	Variables for Volatile Emissions Evaluation .....	7-5
Table 7-2.	OSHA Regulations (Standards – 29 CFR) Limits for Air Contaminants.....	7-7
Table 10-1.	Applicability of Various Management Actions to CDF Pathways.....	10-2
Table B-1.	Recommended Resuspension Factors for Various Poned Areas and Depths.....	B4
Table C-1.	Target Suspended Solids and Required Sediment for Simulated Runoff Samples from Wet Sediment.....	C5
Table C-2.	Target Suspended Solids and Required Sediment for Simulated Runoff Samples from Dry Sediment.....	C5
Table D-1.	Sample Collection Chart.....	D18
Table E-1.	Summary of Hydrodynamic Conditions and Applicable Models for CDF Effluent and Surface Runoff Discharges .....	E5
Table F-1.	Contaminant-Specific Air Sampling Tubes Available through Supelco, Inc., Bellefonte, PA, and Accompanying Analytical Method .....	F3
Table F-2.	Model Input Parameters for Evaluation of Volatile COC.....	F4
Table G-1.	Test Specifications for the 28-Day <i>Eisenia fetida</i> Bioaccumulation Test .....	G5
Table H-1.	Summary of DTPA-Predicted Plant Bioaccumulation from Dredged Material Compared to Reference Material.....	H4
Table H-2.	DTPA-Predicted Plant Metal Concentrations and Total Plant Bioaccumulation.....	H5
Table L-1.	Types of Errors in Hypothesis Testing and Associated Probabilities .....	L7
Table L-2.	Suggested a Levels to Use for Tests of Assumptions .....	L11
Table L-3.	Number of Survivors in a Hypothetical Water Column Toxicity Test after 96 hr .....	L16
Table L-4.	Tests of Assumptions and Hypothesis Tests on Arcsine-Transformed Water Column Toxicity Test Example Data.....	L19

Table L-5.	Calculated $LC_{50}$ Values for Example Water Column Toxicity Test Data .....	L24
Table L-6.	Results from a Hypothetical Bioaccumulation Test, Showing Contaminant Concentrations in Tissues of Animals Exposed to Different Treatments.....	L30
Table L-7.	Tests of Assumptions and Parametric Hypothesis Tests on Untransformed and $\text{Log}_{10}$ -Transformed Bioaccumulation Example Data .....	L31
Table L-8.	Tests of Assumptions and Nonparametric Hypothesis Tests on Bioaccumulation Example Data Converted to Rankits and Ranks .....	L32



# Preface

---

This manual, the Evaluation of Dredged Material Proposed for Disposal at Island, Nearshore, or Upland Confined Disposal Facilities - Testing Manual, commonly referred to as the Upland Testing Manual or UTM, is a resource document providing technical guidance for evaluation of potential contaminant migration pathways from confined disposal facilities (CDFs).

The UTM provides the best available technical guidance regarding how dredged material proposed for placement in CDFs should be evaluated and/or tested. The UTM is intended solely as guidance and does not alter the statutory and regulatory framework for permitting decisions under applicable laws or regulations. The UTM is not intended, nor can it be relied upon, to create rights or obligations enforceable by any party. The UTM does not, and is not intended to impose legally binding requirements on Federal agencies, States, or the regulated community.

The U.S. Army Corps of Engineers (USACE) and the Environmental Protection Agency (EPA) have jointly developed a series of guidance documents pertaining to dredged material management. This series includes a document entitled **“Evaluating Environmental Effects of Dredged Material Management Alternatives - A Technical Framework”** (Technical Framework – EPA/CE 1992).<sup>1</sup> The Technical Framework provides guidance for evaluation and selection of alternatives for the full range of management options to include open water placement, CDF placement, and beneficial use applications. The UTM was developed by the USACE to be consistent with and support the Technical Framework by providing detailed procedures for assessment of contaminant-related impacts for placement of contaminated sediments in CDFs.

The UTM was developed under the Dredging Operations Technical Support (DOTS) Program and Center for Contaminated Sediments at the USACE Environmental Laboratory (EL), Engineer Research and Development Center (ERDC), Vicksburg, MS. The procedures in the UTM are based on extensive research and field experience gained by USACE. The contributions made by many individuals in developing this manual are gratefully acknowledged. The initial drafts of the manual were completed by a workgroup consisting of Dr. Michael R. Palermo and Dr. Robert M. Engler, ERDC, EL; Dr. Richard K. Peddicord, Dick Peddicord & Company, Inc.; and Dr. Thomas Wright,

---

<sup>1</sup> Reference information located at end of Chapter 1.

independent consultant. Primary chapter authors were: Drs. Palermo and Peddicord and Mr. Joseph R. Wilson, Headquarters, USACE, Chapter 1; Drs. Peddicord and Wright, Chapters 2 and 3; Dr. Palermo, Chapter 4 and Appendix B; Mr. Richard A. Price, ERDC, EL, Chapter 5 and Appendix C; Dr. Paul Schroeder, Dr. Tommy Myers, and Dr. Jim Brannon, ERDC, Chapter 6 and Appendix D; Dr. Schroeder, Appendix E; Ms. Cindy Price, ERDC EL, and Dr. Schroeder, Chapter 7 and Appendix F; Dr. John Simmers, ERDC, EL, and Dr. Peddicord, Chapter 8 and Appendix G; Mr. Price and Dr. Peddicord, Chapter 9 and Appendix H; Drs. Palermo and Schroeder, Chapter 10 and Appendices I and K; and Ms. Joan Clarke, ERDC, EL, Appendix J. All authors contributed to Appendix A.

Review of this manual was conducted by individuals with technical and/or programmatic experience related to dredged material management from Headquarters, USACE, field offices and research laboratories; the EPA Office of Water; and the EPA Office of Emergency and Remedial Response. Appreciation is expressed to Mr. Wilson, Headquarters, USACE, Mr. Norman R. Francingues, ERDC; Mr. Rob Hauch, USAE District, Galveston; and Mr. Steve Calver, USAE District, Savannah, for their input and comments.

Updates and revisions to the UTM will be made as additional research is completed and field experience is gained. Users are encouraged to obtain the most recent version of the manual, maintained on the USACE DOTS website at [www.wes.army.mil/el/dots](http://www.wes.army.mil/el/dots).

This manual should be cited as follows:

U.S. Army Corps of Engineers. 2003. "Evaluation of dredged material proposed for disposal at island, nearshore, or upland confined disposal facilities - Testing Manual," Technical Report ERDC/EL TR-03-1, U.S. Army Engineer Research and Development Center, Vicksburg, MS.

*The contents of this report are not to be used for advertising, publication, or promotional purposes. Citation of trade names does not constitute an official endorsement or approval of the use of such commercial products.*

# 1 Introduction

---

## 1.1 Background

This manual, “Evaluation of Dredged Material Proposed for Disposal at Island, Nearshore, or Upland Confined Disposal Facilities - Testing Manual,” commonly referred to as the Upland Testing Manual or UTM, is a resource document providing technical guidance for evaluation of potential contaminant migration pathways from confined disposal facilities (CDFs).<sup>1</sup>

A CDF is an engineered structure consisting of dikes or other structures that extend above any adjacent water surface and enclose a disposal area for containment of dredged material, isolating the dredged material from adjacent waters or land (USACE/EPA 1992).<sup>2</sup> Approximately 300 million cubic yards of material is dredged annually in the United States to maintain navigation, but only 5 to 10 percent of that total volume is deemed unsuitable for conventional open water disposal because of potential contaminant impacts. Disposal of dredged material in CDFs is one of the most commonly considered alternatives for such material. CDFs are also an option commonly considered for disposal of contaminated sediments dredged for purposes of sediment remediation, either as temporary rehandling sites or for final disposal. CDFs are also used for disposal of clean sediments where other options are too costly or present additional environmental problems. From a technical standpoint, the procedures in this manual are equally applicable to both navigation dredging (or dredging activities of essentially the same character as navigation dredging, such as dredging soft-bottom flood control channels or reservoirs) and contaminated sediment remediation projects.

If contaminated sediments are placed in a CDF, consideration of pathways for migration of contaminants from the site and potential contaminant impacts may be required. A suite of evaluation procedures and laboratory test procedures has been developed to evaluate CDF contaminant pathways. These procedures are presented in detail in this manual. Some of these procedures and tests have been field verified and are now in general use, while others are newly developed and field verification is underway or planned.

---

<sup>1</sup> A glossary of terms related to CDFs is provided in Appendix A.

<sup>2</sup> References for this manual are listed at the end of each chapter.

Figure 1-1 illustrates the various categories of CDFs. CDFs may be constructed as upland sites, nearshore sites with part of the perimeter on shore and part in water, or as island containment areas. CDFs also vary considerably in size, dike type, and method of filling. The isolation of the dredged material from adjacent waters and land during and following disposal distinguishes a CDF from other forms of disposal such as unconfined upland, open water, wetland, or contained aquatic disposal (CAD), which is a form of subaqueous confinement with capping.

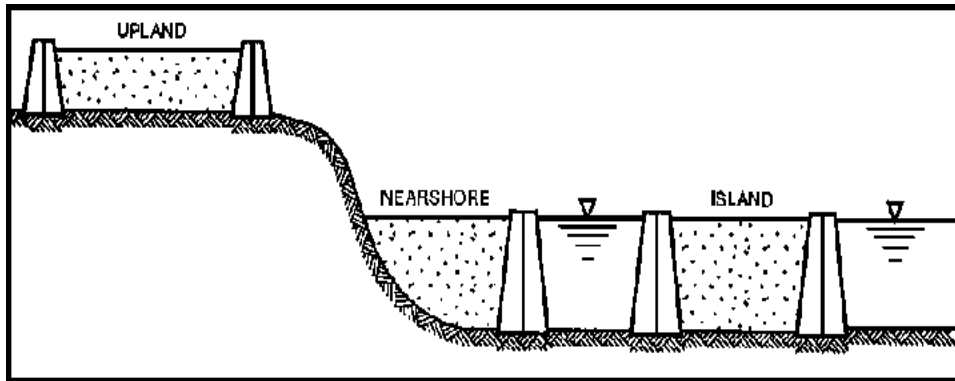

Figure 1-1. Schematic of upland, nearshore, and island CDFs (after USACE/EPA 1992)

A totally upland CDF would allow for all dredged material fill to be placed above the water table. Over time, the material in an upland site will dry and exhibit terrestrial conditions. CDFs constructed in water may become upland sites once the fill reaches elevations above the mean high water elevation. A true nearshore site will take advantage of the shoreline as a part of the containment structure for the site, with in-water dikes or other containment structures required only for the outer walls of the total enclosure. Island CDFs are similar to nearshore CDFs, except that they are constructed totally in water with no direct physical connection to the shore.

Dredged material in CDFs in any of the three types of locations (upland, nearshore, and island) may constitute any of three types of habitats (aquatic, wetland, and terrestrial). The resulting biogeochemical conditions determine potential contaminant activity and receptors potentially at risk, and therefore, the appropriate evaluative procedures.

CDF Locations	Habitat Types	Biogeochemical Conditions
Upland, Nearshore, and Island	Aquatic	- Dredged material remains water-saturated, reduced, and anoxic - Receptors are aquatic organisms and their predators
	Wetland	- Dredged material remains water-saturated, reduced, and anoxic - Receptors are wetland organisms and their predators
	Terrestrial	- Dredged material dries and oxidizes over time - Receptors are terrestrial organisms and their predators

Any of the three habitat types may occur in CDFs in any of the three types of locations. A particular CDF may evolve through a succession of habitat types during its life. As sites are filled, aquatic habitat may be replaced by wetland and then terrestrial habitat. At any point in time, the portions of a single CDF near the inflow point may exhibit terrestrial habitat characteristics, which may shift to wetland habitat and then to aquatic habitat near the weir.

CDFs are not solid waste landfills. They are designed and constructed specifically for disposal of dredged sediment and are designed for the unique properties of sediments, such as high water content and return flow of excess water as effluent to surface waters. However, if needed, CDFs can be designed with control measures, such as liners or surface covers, to provide containment equivalent to that of an engineered landfill.

## 1.2 Purpose and Scope

The purpose of the UTM is to provide technical guidance for evaluation, where appropriate, of potential contaminant migration pathways for proposed disposal of dredged material in CDFs. Procedures in the UTM will:

1. Determine potential contaminant releases and contaminant-related environmental effects from CDFs.
2. Determine whether pathway-specific contaminant controls or management actions are necessary for the proposed CDF to avoid unacceptable adverse effects outside the site.

This manual is intended as a *resource* of technical guidance for use by U.S. Army Corps of Engineers (USACE), Federal, and State regulatory and resource agencies, dredging permit applicants, and others (e.g., scientists and engineers, managers, and other involved or concerned individuals). It is intended to facilitate decision-making with regard to the management of dredged material. Because this manual is national in scope, the guidance provided is generic and may be applied within various regulatory settings. Application of this guidance in some site-specific situations will require best professional judgement, appropriately documented. Users of the UTM are strongly encouraged to consult with their appropriate USACE District experts for additional guidance.

## 1.3 CDF Contaminant Pathways

Contaminant migration pathways (hereinafter referred to as pathways) are routes by which contaminants or constituents of concern (COCs) associated with dredged material may move from the dredged material within the site into the environment outside the site.

The possible pathways from an upland CDF are illustrated in Figure 1-2. These pathways are:

1. Effluent discharges to surface water during filling operations and subsequent settling and dewatering.
2. Precipitation surface runoff.
3. Leachate into groundwater.
4. Volatilization to the atmosphere.
5. Direct uptake by plants and animals living on the dredged material and subsequent cycling through food webs. For evaluation in the UTM, the direct uptake pathway is subdivided into animal bioaccumulation and plant bioaccumulation.

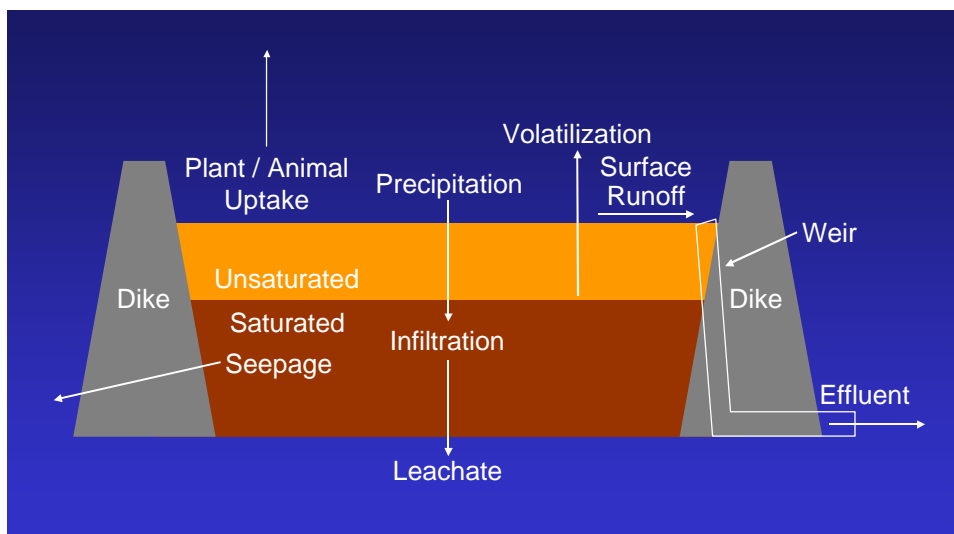

Figure 1-2. Schematic of contaminant migration pathways for upland CDFs

Effects on surface water quality, groundwater quality, air quality, plants, and animals depend on the characteristics of the dredged material, management, and operation of the site during and after filling, and the proximity of the CDF to potential receptors of the contaminants.

Pathways for a nearshore CDF are illustrated in Figure 1-3 and include a number of the pathways that are considered for upland CDFs. However, the relative importance of pathways for a nearshore CDF differs from an upland CDF. A primary advantage of the nearshore CDF is that contaminated dredged material may remain within the saturated zone so that anaerobic conditions prevail and contaminant mobility is minimized. A disadvantage is water level fluctuation via water level changes or other mechanisms, which cause a pumping action through the exterior dikes, which are generally constructed of permeable material. The pumping action may result in soluble convection through the dike in the partially saturated zone and soluble diffusion from the saturated zone through the dike.

Pathways for island CDFs would be similar to nearshore sites. That portion of a nearshore or island CDF raised to above the mean high water elevation will essentially function as an upland CDF.

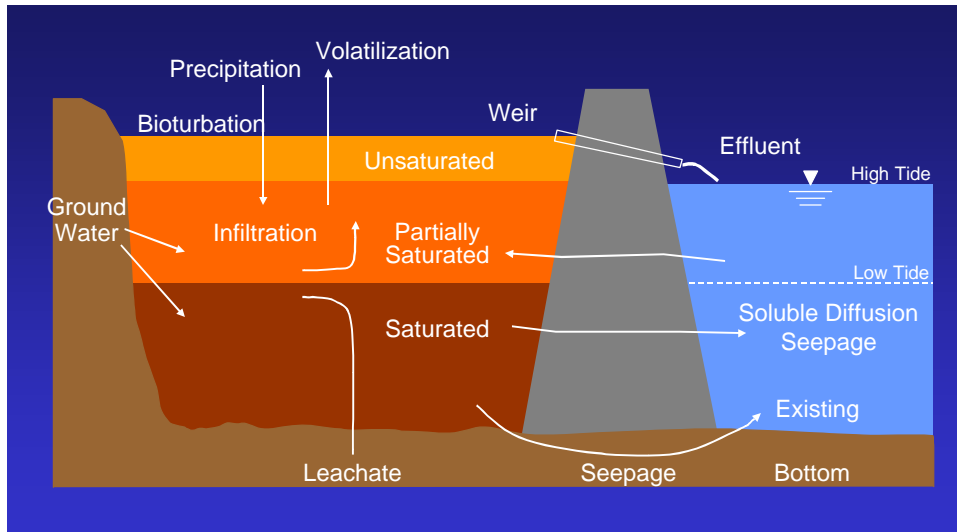

Figure 1-3. Schematic of contaminant migration pathways for nearshore CDFs

## 1.4 Applicability

### 1.4.1 Disposal in CDFs

The UTM provides methods for assessment, where appropriate, of potential effects of proposed disposal of dredged material in upland, nearshore, and island CDFs. It uses physical, chemical, and biological analyses as necessary to provide effects-based conclusions within a tiered framework regarding potential contaminant-related impacts outside the CDF associated with the five potential pathways (USACE/EPA 1992): effluent, precipitation runoff, leachate and seepage, volatilization, and direct uptake by wetland and terrestrial plants and animals.

### 1.4.2 This Manual Does Not Address

- Impacts at the dredging site associated with the dredging activity itself.
- Physical impacts related to construction of the CDF and the disposal of dredged material.
- Impacts associated with material excavated from drainage ditches and land clearing activities.
- Impacts associated with the discharge of fill material.
- Submerged confined disposal, such as CAD, disposal in CAD pits, capping, or other disposal activities in the aquatic environment.
- Any unconfined disposal (e.g., beach nourishment), whether on land, in wetlands, nearshore, or in water.
- Microbiological impacts unless there may be human health concerns.

- Impacts associated with beneficial site use or beneficial use of dredged material removed from CDFs.<sup>1</sup>

### 1.4.3 Relationship to Other Dredged Material Management Efforts

The USACE and EPA have long recognized the need for a consistent technical framework for decision-making regarding alternatives for dredged material management (Engler et al. 1988; Francingues et al. 1985; Wright and Saunders 1990). The UTM was developed by the USACE to supplement a series of guidance documents developed by EPA and the USACE in response to that recognition. The complete set of guidance documents consists of:

- “Evaluating Environmental Effects of Dredged Material Management Alternatives - A Technical Framework” (USACE/EPA 1992), commonly referred to as the Technical Framework. The Technical Framework articulates those factors (including the potential for and degree of contaminant-related impacts) to be considered in identifying the environmental effects of dredged material management alternatives on a continuum from uplands to oceans, and which meet the substantive and procedural requirements of applicable laws and regulations. The UTM and the testing manuals for open water disposal alternatives described below are all consistent with and support the Technical Framework by providing detailed procedures for assessment of contaminant-related impacts.
- “Evaluation of Dredged Material Proposed for Ocean Disposal – Testing Manual” (EPA/USACE 1991), commonly referred to as the “Green Book,” Ocean Testing Manual, or OTM. Dredged material transported for purposes of disposal in the ocean is regulated under the Marine Protection, Research and Sanctuaries Act (MPRSA), commonly referred to as the Ocean Dumping Act. The OTM contains guidance for the evaluation of potential contaminant-related environmental impacts of the ocean disposal of dredged material (regulated under Section 103 of the MPRSA) through chemical, physical, and biological evaluations. The OTM procedures evaluate the suitability of dredged material for disposal at ocean sites, focusing on potential contaminant-related water column and benthic effects.
- “Evaluation of Dredged Material Proposed for Discharge in Waters of the U.S. – Testing Manual” (EPA/USACE 1998), commonly referred to as the Inland Testing Manual (ITM). Dredged material placed in waters of

---

<sup>1</sup> The procedures in the UTM are aimed at evaluation of CDFs as disposal options for dredged material. It is recognized that various natural habitats will often become established on inactive CDFs. Other CDFs may be intentionally managed to provide or encourage certain beneficial site uses or beneficial use of the dredged material, along with their primary function as disposal options for dredged material. Even though the approach and procedures in the UTM are not structured to evaluate specific beneficial site uses, they may be applicable for such evaluations within other frameworks for evaluation of beneficial site use.



the U.S. is regulated under the Clean Water Act (CWA). The ITM contains guidance for determining the potential for contaminant-related impacts associated with the discharge of dredged material in waters of the United States (nearshore, estuarine, riverine, and lake waters) through chemical, physical, and biological evaluations. The ITM provides detailed procedures for evaluating the suitability of dredged material for open water disposal, focusing, in a manner similar to the OTM, on potential contaminant-related water column and benthic effects.

- “Evaluation of Dredged Material Proposed for Disposal at Island, Nearshore, or Upland Confined Disposal Facilities – Testing Manual” (this document), commonly referred to as the Upland Testing Manual or UTM. The UTM supplements the Technical Framework document by providing more detailed procedures for evaluation of contaminant-related impacts related to CDF pathways.

The Technical Framework and supporting manuals such as the OTM, ITM, and UTM provide guidance for thorough evaluation of potential contaminant-related impacts of major dredged material management options.

## 1.5 Organization and Approach for Evaluations

The UTM is organized into 10 chapters and a number of appendices.

Chapter 1 (this chapter) provides the background related to evaluation of effects outside a CDF of contaminants associated with dredged material during and after disposal; the purpose, scope, and approach for the evaluations; and a discussion of regulatory considerations for disposal of dredged material in CDFs.

Chapter 2 provides general considerations common to evaluation of all the contaminant pathways. These include fundamentals of the evaluation and testing process and the tiered approach for testing and evaluations used throughout the manual. The tiered approach for each pathway is consistent. Tier I is concerned with initial evaluations of existing information common to each pathway. Tiers II and III generate site-specific information relevant to the CDF and dredged material being evaluated. Tier IV is concerned with risk assessment for the pathways of concern. While this manual does not include detailed guidance for conducting risk assessments, it is important to note that all the testing and evaluation approaches in the earlier tiers are risk-based, and the results directly support the conduct of a formal risk assessment if necessary.

Chapter 3 describes the Initial Evaluations common to all pathways conducted under Tier I. These include consideration of the need for evaluations, evaluation of existing project information to include prior evaluations and testing, identification of pathways of concern, and identification of contaminants of concern.

Each pathway of concern requires a separate evaluation, each with its own tiered approach. Therefore, Chapters 4 through 9 are similarly structured chapters

describing the evaluations for the five contaminant migration pathways. These chapters describe the rationale and sequence of chemical and biological evaluations and tests under the tiered approach. Chapter 10 introduces contaminant controls and management actions that may be considered for each pathway. Each of the chapters is supported by appendices that provide the detailed systematic procedures for specific tests or evaluations.

## 1.6 Statutory and Regulatory Overview

The sections that follow provide an overview of the laws and regulations governing disposal of dredged material in CDFs. As with the evolution of the testing protocols for CDFs, the regulatory scheme has also evolved with the passage of legislation going back to the National Environmental Policy Act (NEPA) of 1969 and subsequent regulations and the development of the Technical Framework for evaluation of dredged material disposal alternatives (USACE/EPA 1992). Inasmuch as some of the policies are continuing to evolve, this regulatory overview sets forth the USACE approach for ensuring that appropriate regulatory practices are followed for disposal of dredged material in CDFs. Importantly, the goal is and will continue to be to ensure that consistent, predictable, and reliable regulatory practices are employed when dredged material is proposed for disposal in CDFs.

Disposal of dredged material in inland, near-coastal, and ocean waters has a clear regulatory basis. The discharge of dredged material into waters of the United States is regulated under the Clean Water Act. Waters of the United States subject to the Clean Water Act are defined in 33 CFR Part 328 and 40 CFR 230.3(s) and are made up of waters inland of, and including, the territorial sea. The ITM referenced in Section 1.4.3 was specifically developed to evaluate proposed discharges of dredged material into waters of the United States (waters regulated under CWA Section 404). The CWA states that any “discharge of dredged or fill material into the navigable waters” would be regulated.

The MPRSA, also called the Ocean Dumping Act, regulates the transportation of dredged material for the purpose of disposal into ocean waters. Ocean waters subject to the MPRSA are made up of the territorial sea and the waters lying seaward. While the CWA governs inland and near-coastal waters and the MPRSA applies to the open ocean, they share jurisdiction in the territorial sea (measured from the baseline, usually the mean low water mark, out 3 miles). In general, dredged material disposed of in the territorial sea is evaluated under the MPRSA, and material discharged for the purpose of fill (e.g., island creation, underwater berms, beach nourishment, and some beneficial use applications) is evaluated under the Clean Water Act. The CWA also includes discharges at CDFs that have a return flow to waters of the United States.

The regulatory path for disposal of dredged material in CDFs is not as clear. However, both the CWA and NEPA provide strong mandates for USACE regulation of placement in CDFs. The discharge of return flow (effluent and surface runoff) to waters of the United States is specifically defined as a dredged material discharge under the CWA (Section 1.6.1). Under NEPA, the USACE

must evaluate direct, indirect, and cumulative impacts associated with an action that may significantly affect the environment (Section 1.6.1); therefore the USACE must evaluate the potential environmental impacts associated with all aspects of CDFs to include potential releases of contaminants from all pathways.

Coupled with regulatory application is determining which, if any, permitting regimes apply to the various contaminant pathways. A purpose of the discussions in this section is to clarify how the USACE intends to apply the regulatory regimes to the five contaminant pathways under the jurisdiction of the various statutes when dredged material is proposed for disposal in CDFs.

### 1.6.1 Statutory Overview

**National Environmental Policy Act (NEPA).** NEPA and its implementing regulations (at 40 CFR 1500-1508) is the basic national charter for protecting the environment. Assessing the short- and long-term effects of proposed Federal actions (e.g., proposals, permits, and legislation) is among NEPA's many requirements. Section 1502.16 requires an assessment of the "(a) Direct effects and their significance" and the "(b) Indirect effects and their significance." Importantly, Section 1508.8 requires an evaluation of the "Indirect effects, which are caused by the action and are later in time or farther removed in distance, but are still reasonably foreseeable." Furthermore, Section 1508.25 requires that cumulative impacts, along with direct and indirect impacts, shall be considered in environmental impact assessments. Cumulative impact (Section 1508.7) "is the impact on the environment which results from the incremental impact of the action when added to other past, present, and reasonably foreseeable future actions regardless of what agency (Federal or non-Federal) or person undertakes such other actions." When placing dredged material in CDFs, the USACE and applicants for USACE permits are bound to the fundamental principle that ensures those discharges into the CDF itself are adequately evaluated and adverse impacts managed. While NEPA does not require permits, it does, through the Council on Environmental Quality regulations, require that potential adverse environmental impacts are evaluated and managed (See 40 CFR 1500.2(e) and (f), 1502.16, 1505.3 and 1508.8).

**Clean Water Act (CWA).** The CWA, specifically Section 404 (b)(1), requires the development and application of environmental guidelines covering a broad range of effects to human health and ecological systems. The 404(b)(1) Guidelines (referred to here as the "Guidelines") are at 40 CFR 230 and contain a number of evaluation provisions applicable when proposing dredged material disposal in CDFs. Section 230.10(b)(1) prohibits the disposal of dredged material that might violate applicable water quality standards, after consideration of disposal site dilution and dispersion. This provision is aimed at the effluent or runoff discharges from the CDF. That same section requires consideration of "effects on municipal water supplies" and is reinforced at Section 230.50. This section specifically addresses municipal and private water supplies including groundwater, which is a potential concern for the CDF leachate pathway. Section 230.11(h) requires consideration of a broad range of secondary effects from

proposed dredged material discharges. Pathways from a CDF such as plant or animal uptake could be considered secondary effects under this section.

Other sections of the Guidelines address methods to minimize adverse effects at CDFs, such as the use of chemical flocculants to enhance deposition of suspended particulates, or treatment to neutralize contaminants. Other actions at CDFs suggested in CFR Section 230.72 might include liners to reduce leaching, cover crops to reduce erosion, and containing discharged material to prevent point and nonpoint sources of pollution.

Many of the compliance measures of the Guidelines are aimed at protecting ecological and human health from proposed dredged or fill material discharges into waters of the United States. The Guidelines do not focus on CDFs nor do they exclude use of the Guidelines to capture potential contaminant releases from CDFs. Instead, the Guidelines take a common sense approach to potential contaminant releases from proposed dredged material discharge activities. The USACE supports that common sense approach and has developed this manual to take full advantage of existing regulatory and evaluation procedures of the Guidelines to the extent they cover contaminant pathways of concern.

The CWA regulatory mandate for CDF effluent and runoff discharges is very specific. The discharge of effluent from a CDF is defined as a dredged material discharge in 33 CFR 323.2 (d) and 40 CFR 232.2 (e):

“The term ‘discharge of dredged material’ means any addition of dredged material into waters of the United States. The term includes, without limitation, the addition of dredged material to a specified discharge site located in waters of the United States and the runoff or overflow from a contained land or water disposal area.”

In addition, Section 401 of the Clean Water Act provides the States a certification role as to project compliance with applicable State water quality standards; effluent limitations may be set as a condition of the certification.

For purposes of the USACE regulatory program “The return water from a contained disposal area is administratively defined as a discharge of dredged material by 33 CFR 323.2(d) even though the disposal itself occurs on the upland and thus does not require a Section 404 permit.” The USACE has issued a Nationwide Permit at 33 CFR 330.5(16) to satisfy the technical requirements for a Section 404 permit for the return water where the quality of the return water is regulated by the State through the Section 401 certification process. USACE authorizations and evaluations are therefore not required when uncontaminated dredged material is placed in a CDF where the effluent or runoff into waters of the United States is certified as complying with applicable state Section 401 water quality certification requirements. Thus, the procedures and evaluation protocols of this manual *do not apply* to discharges of *uncontaminated* dredged material into CDFs where there is no reason to believe that contaminants might be released into the environment.

However, the nationwide permit does not authorize the disposal of contaminated sediments at CDFs where there might be release of contaminants into the environment. In that the discharge is nationwide permitted does not relieve the USACE or permit applicants from ensuring that contaminants are not released into the environment either at the effluent discharge point or from the disposal site proper. In fact, special conditions at 33 CFR 330 require that “any discharge of dredged or fill material shall consist of suitable material free from toxic pollutants.” Therefore, this manual *does apply* in cases where *contaminated* dredged material is proposed for disposal in a CDF, and there is the potential for release of contaminants via the five pathways. In the UTM, regulation of the effluent, runoff, leachate, and seepage fall within the broad purview of the CWA and NEPA. When effluent, runoff, or leachate pathways are of concern, evaluations are performed and predicted contaminant concentrations or toxicity results are compared to applicable standards, considering mixing or attenuation.

**Resource Conservation and Recovery Act (RCRA).** One of the purposes of RCRA is to ensure that generated waste “should be treated, stored, or disposed of so as to minimize the present and future threat to human health and the environment.” Since April 1988, with publication of the USACE maintenance dredging and disposal regulations at 33 CFR 335-338, the USACE has asserted that dredged material is not a hazardous waste and should not be regulated under RCRA (Federal Register Vol 53, No. 80, April 28, 1988, pages 14903 and 14910). Throughout the 1990’s, the USACE made a concerted effort to demonstrate that the CWA/MPRSA protocols provided a level of environmental protection commensurate with that accorded under RCRA. Based on that demonstrated experience, the EPA excluded dredged material as a hazardous waste on 30 November 1998, providing the dredged material is regulated under either the CWA or MPRSA (Federal Register Vol 63, No. 229, November 30, 1998). The effective rule date was 1 June 1999. Specifically, 40 CFR 261.4 of that rule provides that dredged material regulated under “a permit that has been issued under Section 404 of the Federal Water Pollution Control Act (33 U.S.C. 1344) or Section 103 of the Marine Protection, Research, and Sanctuaries Act of 1972 (33 U.S.C. 1413) is not a hazardous waste.” The term permit also applies to congressionally authorized Civil Works projects undertaken by the USACE using the CWA or MPRSA regulatory regimes.

The RCRA exclusion for dredged material only applies to activities permitted under either the MPRSA or CWA. Since CDFs would not typically be located in ocean waters, the protocols of the CWA Guidelines are used in this manual. The link between the RCRA rule exclusion and CDFs rests with the CWA Section 404 permit required for the effluent discharges from the CDF. Although that discharge is permitted nationwide at 33 CFR 330.5, the nationwide permit does not authorize the disposal of contaminated dredged material into a CDF where there is potential contaminant release to the environment.

## 1.6.2 Other Regulatory Considerations

**Volatile Emissions.** Volatile emissions may be of concern for dredged material containing high concentrations of volatile organic contaminants. Volatile

emissions from dredged material in CDFs are not regulated under the Clean Air Act (CAA), since the CAA regulates point and mobile sources. CDFs are neither. In most cases, air quality is regulated under the CAA only for gaseous emissions that could be sampled from a waste stream, not for volatilization from an areal source. Air quality from areal sources is more typically regulated, considering the resulting quality at a point of compliance or at the nearest receptor. Moreover, there have been no documented CAA concerns with any CDF anywhere in the nation. However, the Occupational Safety and Health Administration (OSHA) air quality standards apply when workers are exposed to inhalation or dermal contact with vapors while handling and managing dredged material containing certain volatile organic compounds in CDFs. In the UTM, when volatile emissions are of concern, evaluations are performed and predicted emission concentrations are compared to OSHA standards to determine compliance.

**Plant and Animal Uptake.** The direct uptake or bioaccumulation of contaminants by wetland and terrestrial plants and animals is not directly governed by any specific regulations. The plant and animal uptake pathways for CDFs receiving dredged material are unique in that dredged material is not sewage sludge, solid waste, or an industrial byproduct. Essentially, dredged material placed in a CDF is a wet soil, usually from an adjacent waterway, possibly containing a mixture of low levels of contaminants from various anthropogenic sources. As explained in the RCRA discussion, none of the current statutory or regulatory regimes used for land application of sludges or industrial waste products are appropriate for CDF disposal of dredged material. However, the general mandate under NEPA requires evaluations of the uptake pathways, since uptake and subsequent movement of contaminants into food webs may result in impacts outside the CDF. In the UTM, the potential uptake of contaminants into plant and animal tissue is compared to that for a reference material representative of soils in the vicinity of the CDF had no dredged material disposal ever occurred there, and if the dredged material uptake exceeds that for the reference, the potential environmental impact of the uptake pathways is evaluated in the context of a risk assessment.

## 1.7 References

Engler, R. M., Wright, T. D., Lee, C. R., and Dillon, T. M. (1988). "Corps of Engineers' procedures and policies on dredging and dredged material disposal (the Federal Standard)," EEDP-04-8. U.S. Army Engineer Waterways Experiment Station (USAEWES), Vicksburg, MS.

Environmental Protection Agency/U.S. Army Corps of Engineers. (1991). "Evaluation of dredged material proposed for ocean disposal – Testing manual," EPA 503/8-91/001, Office of Water, Washington, DC.

\_\_\_\_\_. (1998). "Evaluation of dredged material proposed for discharge in waters of the U.S. – Testing manual," EPA-823-B-98-004, Office of Water, Washington, DC.

- Francingues, N. R., Jr., Palermo, M. R., Lee, C. R., and Peddicord, R. K. (1985). "Management strategy for disposal of dredged material: Contaminant testing and controls," MP D-85-1, USAEWES, Vicksburg, MS.
- U.S. Army Corps of Engineers/Environmental Protection Agency. (1992). "Evaluating environmental effects of dredged material management alternatives – A technical framework," EPA 842-B-92-008, Office of Water, Washington, DC.
- Wright, T. D., and Saunders, L. H. (1990). "U.S. Army Corps of Engineers dredged material testing procedures," *Environ. Profess.* 12, 13-17.

## **2 Structure and Approach of the UTM**

---

This chapter describes the tiered testing approach used in the UTM. This approach is very similar in concept to the tiered structure of the OTM and ITM, both of which were designed to provide information needed to determine the potential for contaminant-related impacts of proposed discharges without necessitating unnecessary testing evaluations. The conceptual similarity between the steps in each tier of the UTM evaluation process, the risk assessment process, and fundamentals of testing and evaluations common to multiple pathways are also described.

### **2.1 Tiered Structure for Evaluations and Testing**

The UTM uses a four-tiered evaluation process for each of the five pathways. This tiered approach should be initiated at Tier I for each pathway and is designed to aid in generating appropriate and sufficient, but not more than necessary, information to make decisions regarding the need for management actions. This allows optimal use of resources by focusing the least evaluative effort on projects where the potential need (or lack thereof) for management actions is clear, and expending the most effort on operations requiring more extensive investigation to determine the need for management actions.

To achieve this objective, the evaluative guidance for each of the five pathways is arranged in a series of tiers, or levels of intensity of investigation. At the outset of a typical evaluation of a particular pathway, it may be possible to conduct evaluations in general terms. Evaluation at successive tiers involves more extensive and specific information about the potential need for management actions. Successive tiers may involve more time-consuming and expensive procedures but provide more extensive information allowing more detailed evaluations of the need for management actions. The progressive increase in information from successive tiers means that a project is carried through the tiered evaluation structure until the information necessary and sufficient for a decision is obtained, and no further.

It is not true that increased information obtained from evaluation in progressively higher tiers always results in greater confidence in the decision. As a simple illustration, if dredged material clearly meets the criteria indicating



contamination is not likely to be a concern, further evaluation in subsequent tiers will not increase the degree of confidence or certainty about the nature of the material. Evaluation in progressively higher tiers should be conducted *only* if the information at a given tier is not sufficient to make a decision regarding the need for management actions. Once the information necessary and sufficient to make a decision is available, further evaluation in subsequent tiers *will not* increase the confidence in the decision, is a waste of time and resources, and should *not* be conducted.

The overall evaluation process is illustrated as a flowchart in Figure 2-1. The tiered structure for each pathway is illustrated in matrix form in Table 2-1. The general intent of each of the tiers is described below. More detailed tiered structures specific to each pathway are discussed in Chapters 4 through 9.

### **2.1.1 Tier I**

Tier I uses readily available existing information. The Tier I evaluation should determine the need for evaluation of pathways, identify the pathways (if any) that should be evaluated further, and identify receptors of concern (ROC) and COC (if any) for further evaluation.

Although gathering such information may require searching libraries, archives, and similar sources, such as previous project files, the collection of field data or pathway tests is outside the scope and intentions of this tier. For dredged material with a readily apparent need for management actions (or lack thereof), the information collected in Tier I should be sufficient for making management decisions. However, more extensive evaluation in subsequent tiers will be needed if Tier I information is inadequate for management decisions.

### **2.1.2 Tier II**

If a decision cannot be made at Tier I, Tier II evaluations consist of determining the need for management actions derived from very conservative techniques that use the chemical, physical, and biological characteristics of the dredged material and basic information about the CDF. Because of their conservative nature, if these evaluations indicate that management actions are not needed, it is very unlikely that further evaluations will indicate such a need. However, because of their conservative nature, “false positives” may occur and, depending on the magnitude of such results, further evaluation in higher tiers may be warranted. Tier II includes tests to evaluate the need for management actions to meet applicable water quality standards, groundwater standards, etc.

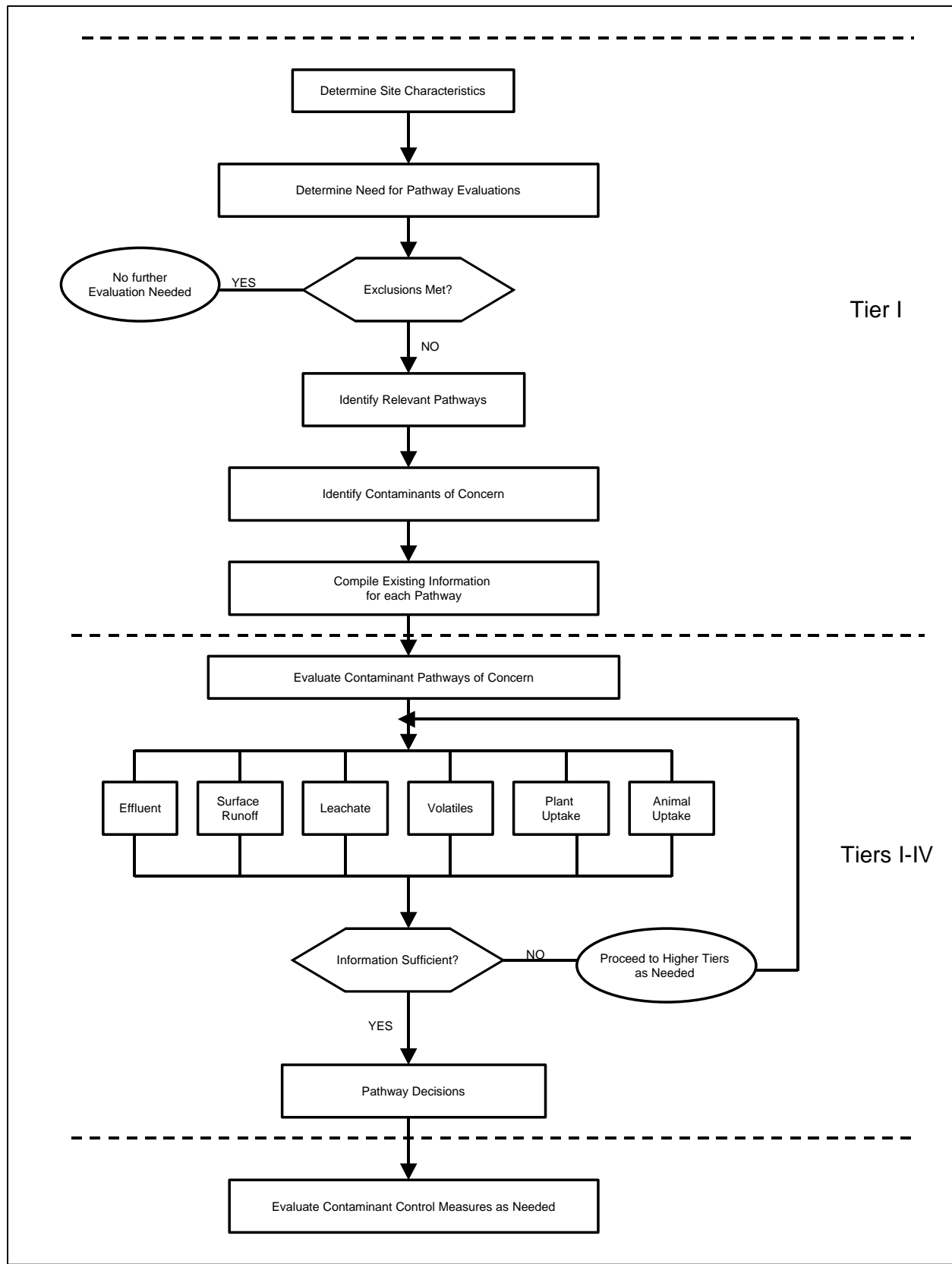

Figure 2-1. Flowchart illustrating the overall evaluation process for CDF pathways

### 2.1.3 Tier III

If the need for management actions cannot be determined in Tiers I and II, it may be necessary to use Tier III to obtain more detailed information. The evaluations in Tier III include effects-based testing and are generally more complex, costly, data intensive, and time-consuming than those in the previous tiers. For contaminant pathways for which there are no Tier II procedures or for which Tier II yields equivocal results, it may be necessary to employ Tier III to obtain more detailed information. It is important to note that carrying decisions to Tier III that could have been made at an earlier tier may not improve the confidence in those decisions.

Tier	Contaminant Migration Pathways for CDFs					
	Effluent	Runoff	Leachate	Volatilization	Plant Uptake	Animal Uptake
Tier I	Existing information	Existing information	Existing information	Existing information	Existing information, conceptual site model, complete exposure routes	Existing information, conceptual site model, complete exposure routes
Tier II	Total release screen and/or Solubility partitioning screen	Solubility partitioning screen	Solubility partitioning screen	Volatility partitioning screen	DTPA Extract, COC elimination	TBP Calculation, COC elimination
Tier III	LTCST turbidity/TSS EET chemistry EET toxicity	SLRP and/or RSLs chemistry SLRP and/or RSLs toxicity	SBLT chemistry and/or PCLT chemistry	VFC chemistry	Plant bioaccumulation test	Animal bioaccumulation test
Tier IV	Case Specific Study or Risk Assessment	Case Specific Study or Risk Assessment	Case Specific Study or Risk Assessment	Case Specific Study or Risk Assessment	Case Specific Study or Risk Assessment	Case Specific Study or Risk Assessment

DTPA = Diethylenetriamine-pentaacetic acid  
TBP = Theoretical Bioaccumulation Procedure  
LTCST = Long Tube Column Settling Test  
TSS = Total suspended solids  
EET = Effluent Elutriate Test  
SLRP = Simplified Laboratory Runoff Procedure  
RSLs = Rainfall Simulator/Lysimeter System  
SBLT = Sequential Batch Leachate Procedure  
PCLT = Pancake Column Leach Test  
VFC = Volatile Flux Chamber;

### 2.1.4 Tier IV

Tier IV consists of case-specific studies or formal quantitative risk assessment designed to answer specific, well-defined questions, and should rarely be necessary for navigation projects. Tier IV is useful if, *and only if*:

1. Contamination is substantial.
2. Specific scientific information essential for a decision is not otherwise available.
3. Essential information will be generated by Tier IV evaluations.

A quarter-century of experience clearly demonstrates that these conditions seldom exist at dredged material aquatic and nonaquatic disposal sites. In the great majority of cases, the environmental consequences of disposal were sufficiently known after Tier III or earlier to make a technical decision; Tier IV might have further refined the prediction of consequences but would not have fundamentally changed it. In such cases, socio-economic and political considerations are more important than technical information, and no amount of further testing will provide additional socio-economic or political insight. Under these circumstances, it is an inappropriate use of time and money to carry the evaluation to Tier IV in hopes that the additional technical detail will resolve nontechnical controversies.

At any tier except Tier IV, failure to make a decision regarding the need for management actions results in additional testing at a subsequent, more complex tier unless a decision is made to seek other disposal alternatives. The final tier (Tier IV) consists of detailed site-specific evaluations intended to provide whatever technical information is necessary for a decision, within the limits of the present scientific state-of-the-practice.

### **2.1.5 Progressing through the Tiers**

It is necessary to proceed through the tiers only until information sufficient to make a decision about the pathway being evaluated has been obtained. For example, if the available information is sufficient to make a decision in Tier I about surface runoff, no further evaluation of surface runoff is required. The evaluation would then shift to the next pathway, which might have to be carried through Tier III to generate sufficient information to make a decision. The approach is to enter Tier I and proceed as far through the sequence of tiers as necessary to make a decision. Although the goal is to make a decision about each pathway in the earliest possible tier, enough information should be available to make technically defensible decisions about every pathway. It is acceptable and often desirable to carry evaluations of different pathways through different tiers to generate the information necessary and sufficient to make technically defensible decisions regarding the need for management actions. It is important to recognize that management actions implemented for one pathway may influence other pathways.

As the investigation progresses through the tiers within a pathway, as many questions as possible should be answered at each tier. Only specific questions that cannot be answered satisfactorily after one tier should be evaluated further in the next tier. It is neither necessary nor appropriate, and is counter-productive, to shift all questions to the subsequent tier and repeat the investigation of questions that have already been answered sufficiently.

The system is structured so that Tier I should be conducted for every pathway that is evaluated, sufficient information for a decision will almost always be available after Tier II or Tier III, and Tier IV will seldom be necessary. Prior to initiating testing, it is essential that the informational requirements of each tier be thoroughly understood and that the information necessary for interpreting results at the advanced tiers be assembled. For example, it is always appropriate to gather

all relevant available information and identify COC (Section 2.2.2) and ROC (Section 2.2.3) for the CDF and dredged material being investigated, even though it may be clear without formal Tier I evaluation that further assessment will be necessary. It may be possible to skip some Tier II evaluations if it appears likely that it will ultimately be necessary to go to Tier III. As evaluation of a pathway progresses through the tiers, more and more information becomes available, so that in most cases there is sufficient information for a decision by the end of Tier III or earlier. If it is necessary to go to Tier IV, only a few specific and well-defined questions should remain to be addressed at the Tier IV level of intensity.

The procedures in this manual can be applied within a given tier using several levels of sophistication with respect to the data required. Pathway evaluations require consideration of several types of site and CDF information to include physical and chemical characteristics of the material proposed for disposal in the CDF, the characteristics of the CDF itself, operational variables regarding the dredging and disposal process, and characteristics of the receiving environments for the pathways. These data can be derived from simple estimates to extensive prediction or modeling efforts and should be considered in conjunction with data on dredged material pathway behavior. These data may vary from conservative estimates based on simple partitioning principles to data derived from detailed pathway testing. A given evaluation for a given pathway could therefore employ a range of site and CDF data sources and levels of detail. Use of existing information or conservative estimates of the needed site variables is most appropriate for evaluations in the early tiers. Use of case-specific data is more appropriate for later tiers.

### **2.1.6 Decisions after Each Tier**

After completion of the technical evaluation in each tier, a decision concerning the next step is made in the following manner:

1. If the available information *is sufficient* for a decision regarding the need for management actions, evaluation of the pathway under consideration stops at this point and management actions, if appropriate, are considered. The evaluation then proceeds to the next pathway of concern. This generic decision process is described in detail for every tier of each pathway in Chapters 4 through 9.
2. If the information available at the completion of a particular tier *is not sufficient* to make a decision regarding the need for management actions, the evaluation of the pathway under consideration may proceed to the next tier, or appropriate management actions may be considered as an alternative to further testing.

### **2.1.7 Management Actions**

If a decision is made that management actions are needed for a given pathway, the influence of the management actions on other pathways should be considered. For example, the placement of a surface cover of clean material to

control surface runoff will also control plant or animal bioaccumulation. Consideration of such influences may allow for a reduction in testing efforts or the need to reevaluate some pathways. The full evaluation of all pathways may therefore be an iterative process, depending on the project requirements.

## 2.2 Considerations for Risk Assessment

This section discusses the similarities between risk assessment and the general UTM evaluation process within any tier of each pathway. As discussed in Section 2.1, the tiered process is intended to provide a decision in most cases without having to conduct a formal, quantitative risk assessment in Tier IV. However, even while intending to avoid Tier IV, it is important to recognize that some aspects of the project evaluation may require a Tier IV risk assessment. The evaluations in Tiers I through III provide the data for risk assessment, should it be needed.

### 2.2.1 Overview of Risk Assessment

Risk assessment as it has often been used in other applications has typically been thought of as a complex, time-consuming, and expensive process. However, the concept of “screening level” risk assessments is being more widely embraced, and risk assessment concepts are being applied in simpler, quicker, and more efficient forms. The UTM is consistent with this trend, with its integration of risk assessment elements into a tiered testing framework culminating in a formal, quantitative risk assessment in the ultimate tier.

The fundamentals of the risk assessment process and its application to dredged material evaluation are discussed in Moore, Bridges, and Cura (1998). This overview of the risk assessment process is supplemented by Cura et al. (2001), which discusses risk assessment as it applies to aquatic disposal of dredged material, and Cura, Wickwire, and McArldc (in preparation), which discusses risk assessment in the management of dredged material in wetland and terrestrial habitats. The brief summary of risk assessment in this section merely provides a context for discussing the risk elements of the UTM evaluation process. The much more thorough discussion by Cura, Wickwire, and McArldc (in preparation) is an important companion to the UTM, and the user should be familiar with it to make the best use of the UTM in the context of risk assessment. If it is necessary to carry the evaluation in the UTM to Tier IV, the guidance on Tier IV risk assessments provided by Cura, Wickwire, and McArldc (in preparation) should be followed.

At a fundamental level, risk assessment consists of the following four steps, illustrated in Figure 2-2.

- **Problem formulation** involves a thorough description of the activity being evaluated, with an emphasis on the COC (Section 2.2.2), ROC (Section 2.2.3), and complete exposure route(s) by which ROC could plausibly come into direct physiological contact with COC under the

conditions expected as a result of the proposed project. The UTM processes of scoping the technical evaluation and identification of relevant COC migration pathway(s) discussed in Section 3.1 is generally analogous to this step of the risk assessment process.

- **Effects assessment** determines the dose-response that might cause an effect, such as exceedence of a water quality standard or an effect resulting from bioaccumulation. Effects assessment characterizes the dredged material and is independent of the CDF. The evaluations conducted in Tiers I through III concerning releases or impacts of the contaminant migration pathways in Chapters 4 through 9 are generally analogous to this step of the risk assessment process.
- **Exposure assessment** determines the conditions of exposure to COC that populations, communities, or ecosystems would experience in the field as a result of the proposed project. Exposure assessment characterizes conditions in the field related to the project and is independent of the effects assessment. The mixing, dispersion, or attenuation of effluent, runoff, leachate and volatiles, and the exposure conditions to entire dredged material in Tiers I through III of the contaminant migration pathways in Chapters 4 through 9 are one aspect of exposure assessment. The exposure evaluation should also consider exposure times in relation to the times implicit in the measurements of effects. Exposure evaluation should consider the spatial scale of the release in relation to the scale of the receiving water body and the distribution of the ROC at the population level and in relation to potential ecosystem effects. The considerations discussed in Section 2.2.4 are an important part of exposure evaluation.
- **Risk characterization** basically involves comparison of the results of the effects assessment and exposure assessment to determine whether there is a risk. If conditions necessary to cause an effect (effects assessment) are greater than the exposure expected in the field (exposure assessment), there is no risk. However, if exposure conditions are greater than those that will cause effects, a potential risk exists. The evaluation and decision processes in Tiers I through III of the pathways in Chapters 4 through 9 are generally analogous to this step of the risk assessment process.

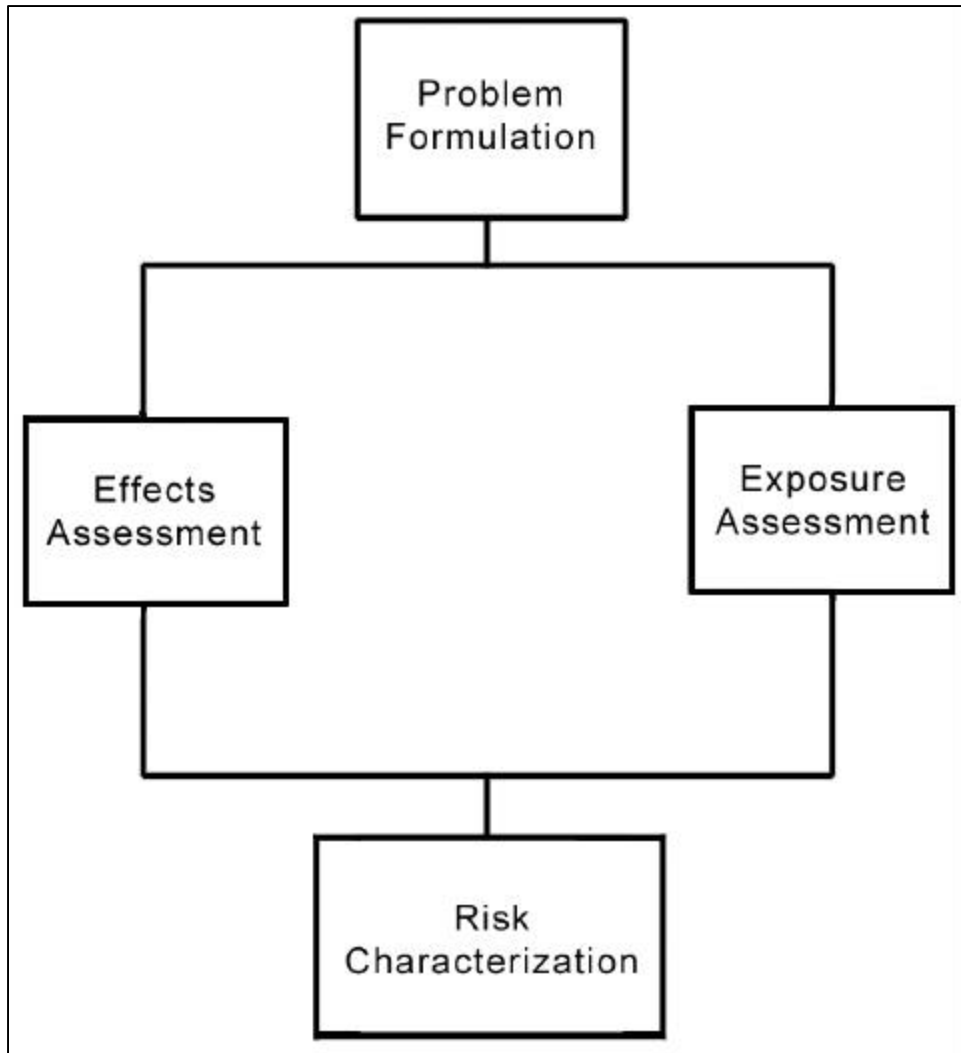

Figure 2-2. Schematic illustration of the relationship of the four major components of risk assessment

The following components of the evaluative process in the UTM and risk assessment are conceptually analogous:

Upland Testing Manual*	Risk Assessment
Identification of relevant pathways	Problem formulation
Determination of environmental quality	Effects assessment
Determination of biological availability and spatial and temporal distribution of COC in relation to populations, communities, and ecosystems of interest	Exposure assessment
Determination of management need	Risk characterization
* Identification of relevant pathways is discussed in Chapter 3. The other UTM processes are discussed in relation to the tiers for each pathway in Chapters 4 through 9.	



### **2.2.2 Contaminants of Concern**

COC are the constituents or contaminants present in the dredged material being evaluated that may have a potential to affect ROC. General COC concepts are presented here, and COC are discussed in relation to Tier I evaluations in Section 3.4 and in detail specific to each pathway in Chapters 4 through 9.

The COC are likely to be different for each dredged material and for a particular dredged material, are likely to be different for different pathways. COC to be evaluated are identified on a case-specific basis in the Tier I evaluation for each pathway. If little information is available, the evaluation may enter Tier I with a “standard laundry list” of potential COC. However, through the Tier I process the “standard laundry list” should be replaced by a set of potential COC specific to the dredged material and pathway being investigated. It is important that all constituents relevant to the disposal activity being evaluated are included as potential COC. Constituents that Tier I shows may be important to a particular investigation should be added, and constituents that Tier I provides no reason to believe may be relevant to a particular investigation should be deleted from the potential COC. While there may be some constituents that are truly of concern and are legitimately among the COC for most investigations, detailed investigation of constituents not relevant to the disposal activity being evaluated are of no benefit and should be avoided.

### **2.2.3 Receptors of Concern**

ROC are the resources that may have a potential to be affected by COC. ROC include abiotic resources such as water quality, groundwater quality, and air quality as well as the more commonly thought of biotic resources such as particular plant or animal species. ROC may be different for each CDF, and for a given CDF, are likely to be different for different pathways.

ROC are mentioned here because ROC is a term common to both the UTM and risk assessment. Because ROC are the resources potentially at risk, the ROC determine the tests that will be conducted. In some cases, ROC are evaluated directly, such as when water quality is evaluated by measuring COC concentrations and comparing these to standards. In other cases, ROC may not be amenable to direct evaluation. For example, the resource of concern may be a local population of edible fish. It is often not possible to directly evaluate potential effects on the population, and it may not even be possible or practical to test individual fish of the species of interest. Such cases are common and are addressed with tests of surrogate species from which effects on the population of interest are inferred. The selection of appropriate test species is discussed in the sections of Chapters 4 through 9 in evaluations that use biological effects tests.

### **2.2.4 Basis of Management Action Decisions**

The purpose of management actions is to protect ROC outside the CDF. As noted above, ROC may be abiotic, such as water quality standards, or biotic, such as particular organisms. The decision that management actions are required to

protect abiotic ROC is quite straightforward. If a standard is not met, it is assumed that the abiotic ROC the standard is intended to protect is at risk unless it can be clearly demonstrated otherwise. In this case, some type of management action may be appropriate.

The case of biotic ROC is much more complex. The state of the art of predictive biological testing and evaluation is such that standard laboratory tests address changes at the organism or suborganism level, while effects on ROC occur in the field at higher levels of biological organization. Predictive tests are usually conducted under laboratory conditions, or occasionally under “controlled” field conditions. Thus, interpretation of results in terms of an effect on a biotic ROC requires extrapolation from laboratory to field conditions, as well as extrapolation from lower to higher levels of biological organization and perhaps from surrogate species to the ROC. Figure 2-3 is a conceptual illustration of the hierarchy of biological organization in relation to ecological relevance and tractability of testing. The most tractable tests address responses at the cellular, organ, and individual levels (i.e., levels 1 through 4) of biological organization. Population, community, and ecosystem levels of biological organization (levels 5 through 7) are much more difficult to test and evaluate predictively but are the levels at which the potential for effects should be evaluated. Most of the biological evaluations in the UTM are at the life history level of organization (level 4), measuring effects on survival, growth, and reproduction of individual organisms under laboratory conditions. Some tests may be conducted at lower levels of biological organization, and there is ongoing scientific attention to prediction of population-level responses from individual life history data. At present, however, evaluation of the potential for effects should be based on results of laboratory tests at the level of individual organisms extrapolated to populations, communities, and ecosystems in the field.

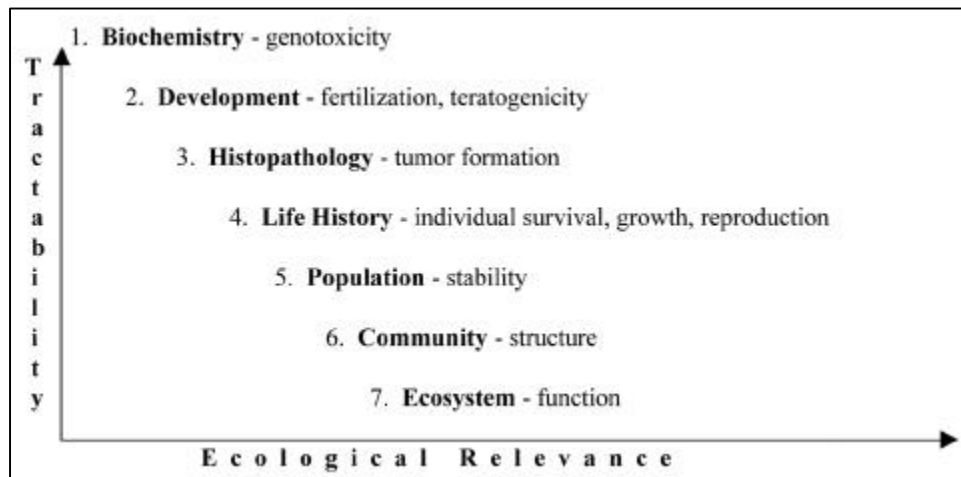

Figure 2-3. Lower levels of biological organization are more tractable for testing than higher levels, but are less ecologically relevant

Whether risks to individual organisms imply that management actions are needed to protect ROC at the population, community, or ecosystem level depends on many factors, all of which should be considered, because none are singularly

determinative according to EPA (1998), from which much of the following discussion is taken. Important factors that should be considered include:

- Nature and intensity of effects.
- Spatial and temporal scale of effects.
- Potential for recovery from effects.

**Nature and Intensity of Effects.** Distinguishing important effects from those of little importance requires consideration of the nature and extent of effects. For example, effects on growth are less likely to be reflected in population changes than effects on survival or reproduction. Large reductions in survival of offspring are more likely to result in measurable population effects than small reductions. A statistically significant 1-percent decrease in fish growth may not be ecologically relevant at the population level. A 10-percent decline in reproduction may be more significant for a population of a slowly reproducing species than for a rapidly reproducing species.

**Spatial and Temporal Scale of Effects.** Important considerations include the extent and pattern of effects in space and time as well as the context of the effects in the surrounding area over time. The size of the affected area is important. A larger affected area may be subject to a greater number of other stressors, increasing the complications from stressor interactions. A larger area may be more likely to contain sensitive species or critical habitat, and may be more susceptible to ecosystem-level changes because multiple communities may be altered. However, a smaller area may not necessarily mean a lower likelihood of the need for management actions. The extent to which critical habitats may be affected compared to the larger landscape of interest is important. The function of an area within the larger landscape may be more important than the absolute size of the area.

Some important population, community, and ecosystem features operate on short-time scales and others on very longtime scales. Hence, the time scale of stressor-induced changes should be considered in the context of the time scales of the multiple natural processes within which they operate. For example, effects of COC should be considered in the context of natural variability and cycles in populations, communities, and ecosystems. Temporal considerations for COC include the time scale of exposure, including repetitive exposures, and the rate at which COC may be accumulated and depurated from tissues. These scales should be considered relative to the time scale on which important population, community, and ecosystem features operate.

**Potential for Recovery from Effects.** Consideration of potential recovery is a logical extension of consideration of temporal scales. Recovery is the rate and extent of return of a population, community, or ecosystem to some aspect of its condition prior to the action being evaluated. Because populations, communities, and ecosystems are dynamic and continually change under natural conditions, it is unrealistic to expect them to remain static or return to the original state before the action being evaluated (Landis et al. 1993). However, the return to a state within

the typical range of variation is a reasonable target. Natural cycles should be considered when evaluating recovery potential.

## **2.3 Fundamentals of Testing and Evaluation**

This section includes a discussion of some fundamental principles of testing and evaluation that are common to multiple pathways. These include sampling considerations, use of water quality standards, mixing/attenuation/dispersion principles, and control and reference materials for testing. Specific application of these principles is also mentioned as needed within the tiered framework for each of the pathways in Chapters 4 through 9.

### **2.3.1 Sampling and Chemical Analysis**

The evaluations in Tiers II and III for all pathways involve sediment characterization and testing. Representative samples of the sediments under consideration must be used for the testing program. Samples of channel sediment, water from the dredging site, and receiving waters at the CDF location may be required, depending on the pathways of concern. The levels of effort, including number of sampling stations, quantity of material, and any schemes used for compositing samples, are highly project-specific. If at all possible, the sampling operations required for sediment characterization (both physical and chemical), design and evaluation of the disposal site, and contaminant pathway tests should be well coordinated to avoid unnecessary duplication of effort. A well-designed sampling plan is therefore essential.

Chemical analyses of sediment, water, and tissue may be required, depending on the contaminant pathways of concern. Accepted techniques for chemical analysis should be used. Detection limits are also an important consideration. The detection limits specified for the tests should be set sufficiently low to allow comparison of tests results with applicable standards.

Supporting guidance regarding sediment sampling, sample collection, handling, preservation and storage, and physical and chemical analyses is available (EPA/USACE 1995 which is included in Appendix K) and should be followed in conducting evaluations in the UTM.

### **2.3.2 Applicable Standards**

Several of the pathway evaluations may involve comparison of contaminant concentrations to applicable standards, such as water quality standards or groundwater standards. If applicable standards are not met, it is assumed that an ROC is at risk. Although standards are abiotic ROC, they are derived from considerations of effects on biotic ROC and are designed to protect biotic ROC. Applicable standards should be evaluated with regard to ambient concentrations of a particular COC in the environment outside the CDF. Additional discussions of specific types of standards are found in the respective pathway chapters.

### **2.3.3 Consideration of Mixing/Attenuation/Dispersion Zones**

The evaluation of effluent or surface runoff discharges should consider the effects of mixing and dispersion in receiving waters. Mixing zones are normally defined by the State regulatory agency as part of the CWA Section 401 Water Quality Certification requirements. When effluent or runoff enters receiving waters, it is dispersed by natural physical processes so that the concentration decreases spatially and temporally beyond the point of entry. This phenomenon is important in determining the potential for effects, because effects depend on both the concentration to which organisms are exposed and the length of time for which they are exposed. Effects are generally less at lower exposure concentrations or shorter exposure times, and for each COC there are exposure time-concentration combinations below which effects do not occur. The Federal regulations implementing Section 404(b)(1), Clean Water Act (40 CFR 230), and Section 103, Marine Protection, Research and Sanctuaries Act (40 CFR 227) recognize this and explicitly provide for consideration of mixing in evaluating dredged material discharges.

Mixing calculations will describe the spatial and temporal boundaries within which the discharge may reach the applicable water quality or toxicity standards. If these boundaries are within the established mixing zone limits, there should be no risk. If these boundaries exceed the established mixing zone limits, the discharge may not meet the mixing zone aspects of water quality certification requirements. Some regulatory entities make no provisions for such events, in which case the discharge should be managed or controlled to not exceed water quality certification requirements. Other regulatory entities have provisions for variances, waivers, or other case-by-case approaches for dealing with releases that exceed established mixing zone limits.

In a similar manner, attenuation of leachate in foundation soils should be considered in evaluation of the leachate pathway, and dispersion of volatile emissions should be considered in evaluation of the volatile pathway.

Detailed procedures for calculation of mixing zones for effluent and runoff are found in Appendix E. Guidance on considering attenuation in evaluating leachate and dispersion in evaluating volatile emissions is presented in the chapters on those pathways.

### **2.3.4 Control Material**

Use of control materials is an integral part of evaluations for toxicity or uptake (bioaccumulation) testing. The purposes of control materials in biological tests are to confirm the biological acceptability of the test conditions and help verify the health of the test plants or animals. The response to the control material is not to be compared to the response to the dredged material to determine the effect of the dredged material. The reference material (Section 2.4) is used for this purpose. The essential characteristics of control materials are that they be essentially free of COC and fully compatible with the needs of the test plants or animals such that they have no discernable influence on the response being measured in the test.

Test procedures are conducted with the control material in the same way as with the dredged material samples. Excessive mortality or other unacceptable response in the control material indicates a problem with test conditions or organisms and can invalidate the test.

Control water in biological tests with effluent or runoff (Chapters 4 and 5) is often the culture water in which the test organisms have been maintained in the laboratory. Control soil in biological tests of plant and animal uptake under terrestrial conditions (Chapters 8 and 9), or control sediments in aquatic and wetland tests, is often the soil or sediment within which the test plants or animals resided prior to collection in the field, or within which they were maintained in the laboratory. Generic control soils or sediments consisting of field-collected or laboratory prepared soil or sediment may also be appropriate in some cases.

Under certain circumstances, it may be appropriate to use specialized control soil or sediment to help discern the potential contribution of a known variable to the results of a test. For example, if the dredged material samples being tested are very fine-grained, it may be desirable in some cases to use a grain-size control (a soil or sediment physically similar to the dredged material and essentially free of contaminants) in addition to the standard control to indicate the degree to which the test plants' or animals' response may be influenced by the grain size of the test soils or sediments.

### **2.3.5 Reference Material for Plant and Animal Uptake Evaluations**

Appropriate reference material is an integral component of testing for evaluation of uptake of COC by plants and animals (Chapters 8 and 9). A reference soil is used in terrestrial evaluations, and reference sediment is used in wetland and aquatic evaluations. In these evaluations, it is important to clearly distinguish between control and reference materials and that both be properly selected and used in testing for effects of dredged materials on plants or animals and evaluating the results.

**Reference material concept.** Reference soil or sediment is the key to evaluating the need for management actions for plants or animals. After a test has been accepted by the control soil or sediment, reference soil or sediment results provide the point of comparison (reference point) against which any potential effects of the dredged material are evaluated. With a proper reference sediment, this will identify the extent, if any, to which the dredged material may cause conditions different from those at the reference site.

The essential characteristic of reference soil or sediment is that it reflects environmental conditions that would have existed in the vicinity of the CDF if dredged material had never been placed there, but all the other influences on environmental quality at the site had occurred. The reference soil or sediment reflects the environmental quality in the vicinity of the CDF because of all influences except dredged material discharges and is as free of COC as the vicinity of the CDF. In addition to this essential characteristic, the physical characteristics of reference soil or sediment should be sufficiently similar to the

dredged material that they have no discernable effect on the response being measured in the test plant or animal. As long as other requirements are met, it is acceptable to choose reference soil/sediment and/or test species to achieve this objective. In general, reference soil or sediment will be obtained in the vicinity of the CDF.

In some cases, it may be appropriate for one reference site to serve more than one CDF, or to use more than one reference material for a single CDF. This could occur, for example, when the dredged material or the CDF has a wide range of grain sizes or organic carbon, when management needs suggest that disposal of different dredged materials at different locations within the CDF is desirable, or when disposal of the dredged material at more than one CDF is being considered.

**Reference material approach.** Reference soil or sediment is generally collected outside the influence of previous operations at a CDF, but near enough to the CDF that the reference material is subject to all the same influences (except previous dredged material) as the CDF. If there is a potential for sediment migration or there is a reason to believe that previously placed dredged material has migrated, reference material should be collected from an area outside the CDF that is not expected to be influenced by material from the CDF. Both the reference point and reference area sampling approaches described below allow statistically valid comparisons and are appropriate under specific circumstances as described below.

**Reference point.** This approach is used when the area outside the CDF is sufficiently homogeneous that a single reference location is representative of the CDF. A single reference location is sampled and the soil or sediment is tested concurrently with the dredged material. The test results from the reference material are compared to those obtained from plant or animal bioaccumulation tests of the dredged material.

**Reference area.** This approach is used when the area outside the CDF is heterogeneous and more than one reference location should be sampled to adequately characterize it. Several reference locations are sampled, and a composite of all the samples is tested concurrently with the dredged material. The test results from the reference material composite are compared to those obtained from plant or animal bioaccumulation tests of the dredged material.

**Reference sampling plan.** The importance of thoughtful selection of the reference sampling approach cannot be overemphasized. To ensure that an appropriate approach is used, information gathered during the site specification process or other studies should be consulted for both the CDF and the reference sites. In some instances there are differences in the statistical methods used in comparing results from the various reference sampling methods to those obtained from the dredged material being evaluated. There may also be differences in costs among the approaches; statistical considerations are important in determining which approach best fits specific concerns and conditions, including feasibility, technical validity, and cost.

A well-designed sampling plan is essential to the collection, preservation, and storage of samples so that potential toxicity and bioaccumulation can be accurately assessed. The implementation of such a plan is equally essential for dredged material, control material, and reference material.

### 2.3.6 Statistical Considerations

A number of the pathway evaluations require comparison of test results with standards or reference material test results. Statistical significance should be considered in making such comparisons. The need for statistical comparisons is stated as appropriate in the respective pathway chapters, and additional detail on statistical methods applicable for the evaluations in the UTM is presented in Appendix L.

## 2.4 References

Cura, J., Heiger-Berneys, W., Bridges, T., and Moore, D. (2001). "Ecological and human health risk assessment guidance for aquatic environments," Technical Report DOER-2, U.S. Army Engineer Research and Development Center, Vicksburg, MS.

Cura, J., Wickwire, T., and McArde, M. "Ecological and human health risk assessment guidance for terrestrial environments," DOER Technical Report (in preparation), U.S. Army Engineer Research and Development Center, Vicksburg, MS.

Environmental Protection Agency/U.S. Army Corps of Engineers. (1995). "QA/QC guidance for sampling and analysis of sediments, water, and tissues for dredged material evaluations - chemical evaluations," EPA 823-B-95-001, Office of Water, Washington, DC.

Environmental Protection Agency. (1998). "Guidelines for ecological risk assessment," EPA/630/R-95/002F. Office of Research and Development, Washington, DC.

Landis, W. G., Matthews, R. A., Markeiwicz, A. J., and Matthews, G. B. (1993). "Multivariate analysis of the impacts of the turbine fuel JP-4 in a microcosm toxicity test with implications for the evaluation of ecosystem dynamics and risk assessment," *Ecotoxicology* 2, 271-300.

Moore, D. W., Bridges, T. S., and Cura, J. (1998). "Use of risk assessment in dredging and dredged material management," Technical Note DOER-R1, U.S. Army Engineer Waterways Experiment Station, Vicksburg, MS.



# 3 Initial Evaluations

---

This chapter describes the activities conducted at the beginning of a CDF pathway evaluation under Tier I. These initial Tier I evaluations include a scoping process and an evaluation of existing information to determine the need for pathway evaluations, identify relevant pathways for the project, and identify COCs. The existing information for each relevant pathway is evaluated to determine if a decision on the need for management actions can be made and identify which pathways require more detailed evaluations in higher tiers.

## 3.1 Determination of the Need for Contaminant Evaluations

The first step in the scoping process is the determination of the need for contaminant evaluations based on the potential for presence of COC in the dredged material. No further evaluation is needed if *any one* of the following criteria is met:

- The dredged material is excavated from a site far removed from existing and historical sources of contaminants, so as to provide reasonable assurance that the dredged material does not contain them.
- The dredged material is composed predominantly of sand, gravel, and/or rock.
- The dredged material is composed of previously undisturbed geological materials which have not been exposed to modern sources of pollution. (However, note that potential impacts from natural mineral deposits must also be considered).

Considering the dredged material characteristics in light of the above criteria, determine whether there is reason to believe COC in the dredged material may be of concern outside the CDF. The purpose at this initial stage is to eliminate projects for which COC clearly do not warrant further evaluation. Unless this is clear, the evaluation should be carried forward.

The decision, the rationale for which should be documented, will be either:

- There *is not* sufficient reason to believe that contaminants in the dredged material may be of concern for the project. Therefore, detailed evaluation is not necessary, and there is no need for further evaluation using this manual.
- There *is* sufficient reason to believe that contaminants in the dredged material *may* be of concern for the project to warrant a more detailed evaluation of potential COC effects outside the CDF. Because these effects can only be evaluated in the context of pathways, it is necessary to determine which pathway(s) may be of concern for the CDF being evaluated.

## 3.2 Identification of Relevant Pathways

If there is potential for the presence of COC in the dredged material, and an evaluation of pathways is deemed appropriate, the next step in the scoping process is to identify the relevant pathways of concern. This requires that a comprehensive, although at this stage not detailed, description of the project be developed, including:

- The environmental setting and general characteristics of the site (Section 3.2.1).
- The engineering design and management characteristics of the CDF (Section 3.2.2).
- The general environmental characteristics of the dredged material (Section 3.2.3).

The source of the information used for the project description is the compilation of existing information discussed in detail in Section 3.3.

### 3.2.1 Environmental Setting and General Characteristics

The general setting of the site or setting for the CDF should be described from the perspective of factors that might influence the migration of COC (if present) from the CDF, and the types of resources that might be exposed to any COC present. Such factors may include, for example:

- Aquatic, wetland, or terrestrial environment.
- Size of receiving water body that releases from the site might enter.
- Salinity of receiving water body and groundwater underlying the site.
- Circulation in receiving water body.
- History of site use.
- Surrounding land use.
- Characteristics of groundwater aquifers beneath and surrounding the site.

### 3.2.2 CDF Design and Management Characteristics

The general engineering design and the existing or anticipated management features of the CDF should be described from the perspective of factors that might influence the migration of COC from the CDF and the types of resources that might be exposed to any COC present. Depending on the nature of the project, the design and management characteristics of the CDF would be considered in one of two ways:

1. The possible adequacy of an existing CDF for the proposed disposal.
2. The required design of a new CDF for the proposed disposal.

In many cases, CDFs have been used for previous disposal of dredged material, sometimes for many years. Pathway evaluations will determine if contaminant controls or operational constraints are required for the proposed placement in such an existing site. For design of new CDFs, the evaluations will determine the requirements for the new site, e.g., minimum surface area or ponding depths and the need for controls or operational constraints. Details on the engineering design and management considerations for CDFs are provided in Engineer Manual 1110-2-5027.<sup>1</sup>

Factors to be considered may include, for example:

- Dike construction and height.
- Surface area of the CDF.
- Design life of the CDF.
- Anticipated frequency of use.
- Anticipated use of the CDF after filling.
- Method of filling the CDF.
- Rate at which the CDF will be filled.
- CDF management between projects.
- Minimum required ponding.
- Characteristics of the CDF foundation.

---

<sup>1</sup> Headquarters, U.S. Army Corps of Engineers. (1987). "Confined disposal of dredged material," Engineer Manual 1110-2-5027, Washington, DC.

### 3.2.3 Dredged Material Characteristics

The general characteristics of the dredged material should be described from the perspective of factors that might indicate the presence, type, and mobility of COC in the material. Such factors may include, for example:

- Area from which the material will be dredged.
- Land use in the watershed and local area surrounding the source.
- Known spills or discharges in the area.
- Physical characteristics of the material (grain-size distribution, water content, plasticity indexes, etc.).
- Volume of material to be dredged.
- Dredging schedule.
- Project dredging history.
- Salinity at the dredging site.
- Maintenance or new work material.
- Method of dredging and placement.

### 3.2.4 Identifying Relevant Pathways

Once the site and CDF characteristics are identified, every migration pathway for which COC may be of concern should be evaluated for relevance before proceeding further in the tiered testing process. The nature of each pathway should be considered in relation to the CDF characteristics (Section 3.2.2) and dredged material characteristics (Section 3.2.3). The purpose at this initial stage is to eliminate pathways that clearly do not warrant evaluation; unless this is clear, the evaluation should continue. Examples in which pathways would not warrant evaluation include situations such as the following:

- If the CDF will be paved when the project being evaluated is completed, runoff, volatilization, and direct uptake pathways would not warrant evaluation for that project. However, these pathways may warrant evaluation for projects that will not be paved upon completion or during filling prior to paving.
- If the frequency of CDF use will be sufficient to keep plants and animals from becoming established within the CDF, the direct uptake pathways would not warrant evaluation.

These examples are not intended as an exhaustive list and serve merely as illustrations to stimulate thinking about whether specific pathways warrant evaluation.

The identification of relevant pathways is crucial to the evaluation process. Only those pathways that have a potential to result in transport of contaminants out of the site require consideration. Three components must be present before any effects from COC are anticipated:

1. There must be a stressor. In the context of the UTM, a stressor would be a COC associated with the dredged material within a CDF.
2. There must be a receptor. In the context of the UTM, a receptor could be a person, wildlife, standard, or other receptor that could be adversely affected by the stressor.
3. There must be a complete exposure route by which a stressor (COC) can come into actual physiological contact with a receptor (ROC).

In order to determine the need to evaluate a pathway, it is important to clearly identify all three elements: the stressor(s), the receptor(s), and the exposure route(s) that connect them. The absence of a complete exposure route is one basis for early elimination of a pathway(s) and stressor/receptor set(s) from further consideration, so that the process can focus on situations that might reasonably constitute a potential risk. This is the opportunity to focus questions upon issues of real concern. Because the scoping process is so fundamental to the conduct and acceptance of the UTM evaluation, it is important that Federal and State agencies, stakeholders, and the general public have meaningful participation in the scoping process.

The rationale for carrying, or not carrying, each pathway into the tiered evaluation should be documented, and a list of pathways to be evaluated should be developed at this point.

### **3.3 Compilation of Information**

A separate Tier I evaluation should be conducted for each relevant pathway to be evaluated, because each pathway has specific characteristics. However, the Tier I evaluation process is very similar for every pathway. The generic Tier I evaluation process is described here and referenced as the basic process for conducting the Tier I evaluation in the detailed chapters on each of the pathways. Much of the existing information used in Tier I evaluations of one pathway will also be useful in evaluation of other relevant pathways. Therefore, whichever pathway is evaluated first will require the greatest Tier I effort, and Tier I evaluations of subsequent pathways will build upon and use much of the same information, requiring less effort.

Even if it is clear from the outset that the evaluation of a particular pathway must be carried to higher tiers, Tier I should be conducted for each pathway. This

is because Tier I is likely to resolve at least some issues, and Tier I provides much of the information that will guide evaluation in higher tiers if that should be necessary, including identification of the COC for the dredged material, CDF, and pathway being evaluated.

Information on a variety of physical, chemical, and biological factors related to the dredging site, the dredged material, and the CDF is important to maximize the utility of Tier I. Information on these factors may exist in a wide variety of sources, and the useful sources may differ for each dredging project. Therefore, the following lists are intended merely to indicate possible sources and stimulate thinking about sources of relevant existing information. Not all potential sources will provide relevant information for every pathway, and sources not listed will be helpful on others. It is not possible to determine in advance which sources will provide information useful in Tier I. All involved parties should work cooperatively to identify and obtain relevant existing information for use in Tier I.

Considerations relevant to the potential for the dredged material to be contaminated include:

- Sources of COC
- Pathways of COC transport to the dredging site
- Naturally occurring substances that may be harmful to biota
- Urban and agricultural runoff
- Sewer overflows/bypassing
- Industrial and municipal wastewater discharges
- Previous dredged or fill discharges
- Landfill leachate/groundwater discharge
- Spills of oil or chemicals
- Releases from Superfund and other hazardous waste sites
- Illegal discharges
- Air deposition
- Biological production (detritus)
- Mineral deposits

The information gathering must be as complete as is reasonably possible, including existing information from all reasonably available sources. This will increase the utility of the Tier I evaluation and the likelihood that decisions

concerning the need for management actions may be made at Tier I. Potential sources of available information include the following, without limitation:

- Results of prior physical, chemical, and biological tests and monitoring of the material proposed to be disposed.
- Information describing the source of the material to be disposed which would be relevant to the identification of potential COC.
- Existing data contained in files of agencies such as EPA or USACE or otherwise available from public or private sources. Examples of sources from which relevant information might be obtained include:
  - Selected Chemical Spill Listing (EPA)
  - Pesticide Spill Reporting System (EPA)
  - Pollution Incident Reporting System (United States Coast Guard)
  - Identification of In-Place Pollutants and Priorities for Removal (EPA)
  - Hazardous waste sites and management facilities reports (EPA)
  - USACE studies of sediment pollution and sediments
  - Federal STORET, BIOS, CETIS, and ODES databases (EPA)
  - Water and sediment data on major tributaries (Geological Survey)
  - National Pollutant Discharge Elimination System (NPDES) permit records
  - Agencies with COC or related information, for instance, Fish and Wildlife Service (FWS), National Oceanic and Atmospheric Administration (NOAA), regional planning commissions, state resource/survey agencies
  - CWA 404(b)(1) evaluations
  - Pertinent and applicable research reports
  - MPRSA 103 evaluations
  - Port and marina authorities
  - Colleges/Universities
  - Records of State agencies, (e.g., environmental, water survey, transportation, health)
  - Superfund sites, hazardous waste sites

- Published scientific literature

Factors that may influence the movement of COC from sources to the dredged material are important considerations, including:

- Bathymetry
- Water current patterns
- Tributary flows
- Watershed hydrology and land uses
- Sediment and soil types
- Sediment deposition rates

### **3.4 Identification of Contaminants of Concern (COC)**

This step in the Tier I evaluation identifies potential contaminants of concern (COC) and determines whether they may present a potential environmental problem. The evaluation in all tiers rests heavily upon proper identification of COC. The process begins in Tier I with the identification of potential COC. Tier I also begins the process, continued in Tier II, of narrowing the potential COC to a more focused set of COC that warrants detailed evaluation and documents the reasons others do not warrant further consideration. This will result in a focused list of COC necessary and sufficient for a thorough assessment of potential environmental problems associated with the proposed project.

Simple presence of a contaminant in the dredged material being evaluated is not sufficient to include that contaminant as a potential COC. However, a persistent and toxic chemical would be included. Some COC may occur in a dredged material below their toxic levels, yet may be sufficiently bioavailable and bioaccumulative that they present a potential problem to higher trophic levels. Some dredged materials may contain no COC.

There may be some COC common to many dredged materials, but the set of COC developed for one project will not necessarily be appropriate for another project. The COC may be similar for some pathways and may be very different for others. For example, the COC may be relatively similar for effluent and runoff, but potentially volatile contaminants that might be COC for air may not be COC for direct uptake. Salt can have major effects on water quality and terrestrial and freshwater organisms. Therefore, if the dredged material is from a saline waterway and may reach fresher surface or groundwater, salt should be considered a potential COC for all pathways except air and plant or animal uptake, even though salt is not, strictly speaking, a contaminant. COC should be developed for each pathway and each project.



Proper identification of COC is essential to accurate assessment of potential impacts and the need for management actions. If an important constituent is not included, the assessment could overlook potential effects. If an increasing number of unimportant constituents are included, evaluations tend to lose focus, become inefficient, and perhaps incorrectly identify potential effects where none actually exist. While it is usually better to err on the side of inclusion, each potential COC should be carefully considered, and constituents should not be included without objective justification for doing so.

### **3.4.1 Need for Sediment Chemistry**

If the available evidence indicates COC may be present, final selection of COC may require supplementing available information with chemical analyses of the sediment. Also, the Tier II evaluations for each pathway, if they are necessary, rely on bulk sediment data for the proposed dredged material. If adequate bulk sediment data are not available, samples should be collected and the bulk sediment chemistry should be determined. It is possible to skip Tier II and go directly to tests in higher tiers. However, this may not be an efficient use of resources in most cases, since subsequent testing may be unnecessary. In addition, proper interpretation of some pathway tests requires sediment chemistry data.

In some instances, it may be sufficient to perform confirmatory analyses for specific COC. In other cases where the initial evaluation indicates that a variety of COC may be present, chemical analysis of the dredged material could provide a useful inventory, and bulk sediment chemistry analysis may be appropriate. Should it be necessary to collect and analyze sediment samples at this point, it should be assumed that Tier II and Tier III testing may be needed for all pathways. Hence, consideration should be given to collecting sufficient material from the dredging, reference, and control sites to conduct these tests. Careful attention should be given to storage conditions and storage times for sediments prior to performing evaluations. If this is not done, it may be necessary to repeat the sampling.

### **3.4.2 Characteristics of Contaminants of Concern**

Contaminants for which there are applicable standards should be identified as a COC. COC include potentially toxic or bioaccumulative constituents and those that may promote undesirable organisms or growth. Salt is always a potential COC whenever dredged material from a saline waterway is placed in a CDF where nonsaline or lower-salinity environments may be affected. Other potential COC include those that might reasonably be expected to require management actions if the dredged material in question were to be placed in the CDF. The potential COC for each proposed action should be identified on the basis of the following, keeping in mind appropriate analytical considerations:

- Presence in the dredged material
- Concentration in the dredged material relative to the concentration in the reference material

- Toxicological importance
- Persistence in the environment
- Propensity to bioaccumulate from sediments/soil matrices, which is controlled primarily by the following chemical properties of the constituents:
  - **Hydrophobicity** - Literally, "fear of water"; the property of neutral (i.e., uncharged), organic molecules that causes them to associate with surfaces or organic solvents rather than to be in aqueous solution. The presence of a neutral surface such as an uncharged organic molecule causes water molecules to become structured around the intruding entity. This structuring is energetically unfavorable, and the neutral organic molecule tends to be partitioned to a less energetic phase, if one is available. In an operational sense, hydrophobicity is the reverse of aqueous solubility. The octanol/water partition coefficient ( $K_{ow}$ ,  $\log K_{ow}$ , or  $\log P$ ) is a measure of hydrophobicity. The tendency for organic chemicals to bioaccumulate is related to their hydrophobicity. Bioaccumulation factors increase with increasing hydrophobicity up to a  $\log K_{ow}$  of about 6.00. At hydrophobicities greater than about  $\log K_{ow} = 6.00$ , bioaccumulation factors tend not to increase due, most likely, to reduced bioavailability.
  - **Aqueous Solubility** - Chemicals such as acids, bases, and salts that speciate (dissociate) as charged entities tend to be water-soluble and those that do not speciate (neutral and nonpolar organic compounds) tend to be insoluble, or nearly so. Solubility favors rapid uptake of chemicals by organisms but at the same time favors rapid elimination, with the result that soluble chemicals generally do not bioaccumulate to a great extent. The soluble free ions of certain heavy metals are exceptional in that they bind with tissues and thus are actively bioaccumulated by organisms.
  - **Stability** - For chemicals to bioaccumulate, they must be stable, conservative, and resistant to degradation (although some contaminants degrade to other contaminants that may bioaccumulate). Organic compounds with structures that protect them from the catalytic action of enzymes or from nonenzymatic hydrolysis tend to bioaccumulate. Phosphate ester pesticides do not bioaccumulate because they are easily hydrolyzed. Unsubstituted polycyclic aromatic hydrocarbons (PAH) can be broken down by oxidative metabolism and subsequent conjugation with polar molecules. The presence of electron-withdrawing substituents tends to stabilize an organic molecule. Chlorines, for example, are bulky, highly electronegative atoms that tend to protect the nucleus of an organic molecule against chemical attack. Chlorinated organic compounds tend to bioaccumulate to high levels in animals because organisms

easily take them up, and, once in the body, they cannot be readily broken down and eliminated.

- **Stereochemistry** - The spatial configuration (i.e., stereochemistry) of a neutral molecule affects its tendency to bioaccumulate. Molecules that are planar tend to be more lipid- soluble (lipophilic) than do globular molecules of similar molecular weight. For neutral organic molecules, planarity can correlate with higher bioaccumulation unless organisms can easily metabolize the molecule.

### 3.4.3 Documentation of COC

Justification for identifying a contaminant as a COC *increases* with the *increase* of factors such as the:

- Toxicological importance of the contaminant.
- Amount of the contaminant known to have been introduced to the dredging site.
- Amount of the contaminant suspected to have been introduced to the dredging site.
- Amount of the contaminant included in continuing input from existing sources.
- Amount of the contaminant included in historical sources.

Justification for identifying a contaminant as a COC *decreases* with the *increase* of factors such as:

- Isolation of the dredging operation from known existing and historical sources of the contaminant.
- Time since historical sources of contaminant have been remediated.
- Number and frequency of maintenance dredging operations since abatement of the source of the contaminant.
- Mixing and dilution occurring between the contaminant source and the dredging site.
- Transport and potential deposition of sediment in the dredging area from sources other than those potentially affected by the contaminant.
- Grain size of the dredged material.

These and other considerations are complexly interrelated; i.e., the acceptable degree of isolation from sources of contaminants depends on the number, amount, and toxicological importance of the contaminants as well as on all other factors.

These considerations have to be evaluated for all dredged material. Even so, it is desirable that local guidance be developed, based on technical evaluations, which describes the emphasis on factors deemed appropriate in each area.

The results of the COC identification should be documented. This should identify all contaminants considered and briefly summarize the justification for identifying or not identifying each as a COC for the specific dredged material, CDF, and pathway being evaluated. These are the COC that will be evaluated in higher tiers as appropriate.

### **3.5 Consideration of Prior Evaluations and Testing**

An important aspect of a Tier I evaluation is the consideration of any previously conducted pathway evaluations for the project, especially those which included pathway testing. In some cases, COC may be present in the dredged material, but earlier detailed evaluation of the pathway indicated no management actions were required. Prior evaluations should be appropriately documented and used in the developing the Tier I decisions for each pathway.

### **3.6 Tier I Decisions**

After consideration of all available information in Tier I, one of the following conclusions is reached for each pathway. The conclusions are described here in generic terms and are described in terms specific to each pathway in the Tier I discussions of Chapters 4 through 9:

1. Existing information provides a sufficient basis for a decision about the need for management actions associated with the pathway being evaluated.
2. Existing information does not provide a sufficient basis for a decision about the need for management actions associated with the pathway being evaluated. In this case the evaluation must proceed to higher tiers.

It should be noted that the selection of a management action at this or any other tier may require reevaluation of the specific pathway, as well as other pathways as management actions may materially change the nature of the material, the CDF, or the pathways. Also, even though a decision that management actions are needed may be made at Tier I, more detailed information for the pathway may be needed for design of specific actions.

# 4 Effluent During Disposal Operations

---

## 4.1 General Considerations

Effluent is defined for purposes of this manual as water discharged from a confined disposal facility (CDF) during and as a result of the filling or disposal of dredged material in the CDF (USACE/EPA 1992). Regardless of the manner in which a CDF is filled, and especially if the CDF contains water or is hydraulically filled, there will be an effluent.

Effluent evaluation procedures and tests are also presented in the ITM (EPA/USACE 1998). For consistency and completeness, all effluent procedures in the ITM are included in this manual in their entirety and with no technical modification. However, this manual includes additional procedures for evaluation of the effluent pathway that address a wider range of possible conditions and additional computer-assisted tools for effluent evaluation.

### 4.1.1 Effluent Processes

A schematic of an active hydraulically filled CDF is shown in Figure 4-1. Dredged material hydraulically placed in a CDF settles, resulting in a thickened deposit of material overlaid by a clarified supernatant. The supernatant waters are discharged from the site as effluent during active dredging operations. The effluent may contain dissolved contaminants and suspended and colloidal particles with associated (adsorbed or held by ion exchange) contaminants. A large portion of the total contaminant load is particle-associated.

Supernatant waters from CDFs are discharged after a retention time that may vary from a few hours to several days. Actual withdrawal of the supernatant is governed by the hydraulic characteristics of the ponded area and the discharge weir. Several factors influence the concentration of suspended particles present in supernatant waters. Fine particles become suspended in the ponded water at the point of entry because of turbulence and mixing. The suspended particles are partially removed from the water column by sedimentation. However, particle concentrations may be maintained by upward flow of water through the slurry mass during settling. Wind and/or surface wave action may also resuspend settled particles.

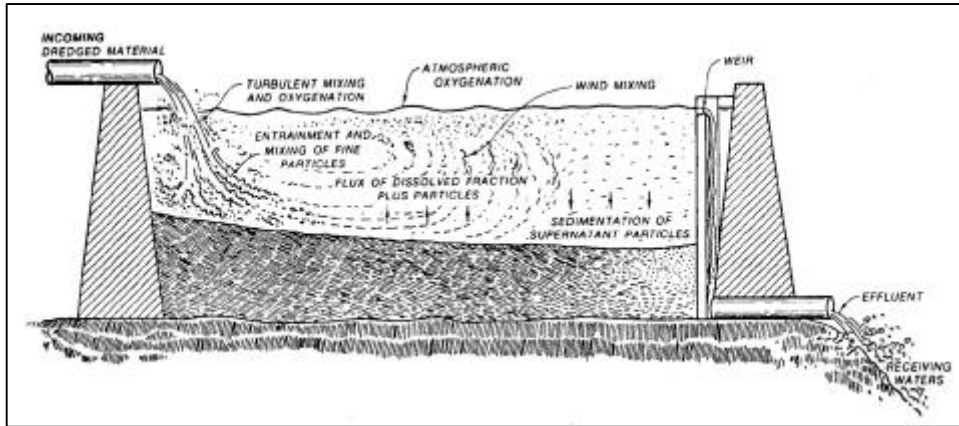

Figure 4-1. Schematic of supernatant water interaction in an active confined disposal facility affecting effluent quality

CDFs are typically designed to retain virtually all the solid fraction of dredged material. However, all solids cannot be retained during the disposal process, and associated contaminants are transported in dissolved form and with the particles in the effluent. The only solids in the effluent are typically very fine-grained and are widely dispersed so that any accumulation on the bottom of the receiving water body is negligible. Therefore, effluent typically has the potential for water column effects only, and evaluation of benthic effects related to effluent is usually not appropriate.

The duration of effluent discharges will roughly correspond to the time required to complete the dredging operation and may vary from days to months. Effluent discharges may occur from a few hours per day up to 24 hours per day, depending on project conditions.

It is important to distinguish intentional release of ponded water during filling and subsequent management of the CDF from runoff released from the CDF following precipitation. Precipitation runoff is another contaminant pathway and will require separate evaluation if there is a reason to believe that contaminants might be released (Chapter 5).

#### 4.1.2 Method of Filling

The techniques for evaluation of effluent discharges described here are specifically designed for the case of hydraulic disposal of material into CDFs with the effluent discharge to receiving waters occurring from an outlet pipe or weir structure or structures. Hydraulic disposal can be in the form of direct pipeline inflow from cutterhead or similar hydraulic suction dredges, intermittent hydraulic placement from hopper dredge pumpout operations, or intermittent hydraulic placement by reslurrying material from barges (which may have been filled by mechanical dredges). Such disposal operations would normally have an effluent discharge flowrate roughly equal to that of the inflow.

Some CDFs may be designed to allow flow of effluent water through filter cells or permeable dike sections. The techniques described here may be applied to

this case, but the influence of the filter media in retaining suspended particles and adsorption of contaminants from the effluent discharge should be considered.

Dredged material may be placed in some CDFs by direct mechanical means such as rehandling from barges or by truck. Although such filling operations normally involve handling relatively little free water, there may still be an effluent discharge. In addition, there may be ponded water in the CDF before filling begins, especially for CDFs constructed in water. For the case of mechanical filling, the effluent discharge involves the free water that is released during the mechanical disposal operation or the existing pond water that is displaced by the operation. Separate procedures are available in Tier II for mechanical filling. However, no specific Tier III laboratory tests have been developed for the case of direct mechanical disposal. The testing procedures described here for hydraulic disposal may be used in the interim for the case of mechanical disposal and are considered conservative for such evaluations.

### **4.1.3 Regulatory Considerations**

As discussed in Chapter 1, CDF effluent is administratively defined as the discharge of dredged or fill material into waters of the United States and is subject to regulation under CWA Section 404. The fact that the effluent is nationwide permitted at 33 CFR 330.5(16) does not relieve applicants from Corps of Engineers permits, nor does it relieve the Corps when undertaking dredging projects from ensuring that effluent does not violate applicable water quality standards. Specifically, the nationwide permit requires that a water quality certification be obtained from the appropriate agency, whether it be the State, tribe, or EPA in some cases.

In those instances where the effluent receives CWA Section 401 Water Quality Certification and there is no reason to believe that there will be contaminants released from the effluent during the filling operation and subsequent release of ponded water from CDF management, no further evaluation of effluent is needed.

### **4.1.4 Mixing Zones**

The evaluation of effluent discharges should consider the effects of mixing and dispersion (Section 2.3.3). Mixing zones are normally defined by the State regulatory agency as part of the CWA Section 401 Water Quality Certification requirements. When effluent enters receiving waters, it is dispersed by natural physical processes so that the concentration decreases spatially and temporally beyond the point of entry. This phenomenon is important in determining the potential for effects, because effects depend on both the concentration to which organisms are exposed and the length of time for which they are exposed. Effects are generally less at lower exposure concentrations or shorter exposure times, and for each COC there are exposure time-concentration combinations below which effects do not occur. The Federal regulations implementing Section 404(b)(1), Clean Water Act (40 CFR 230), recognize this and explicitly provide for

consideration of mixing in evaluating dredged material releases, as does the MPRSA.

Mixing calculations describe the spatial and temporal boundaries within which the discharge will reach the water quality standards (WQS). If these boundaries are within the established mixing zone limits, there should not be an effect. If these boundaries exceed the established mixing zone limits, there may be an effect.

Procedures for evaluation of initial mixing are presented in Appendix E.

#### **4.1.5 Data Requirements**

Data requirements for effluent evaluations include those pertaining to operational considerations (i.e., CDF site characteristics and dredge characteristics) and those pertaining to the properties of the dredged material (i.e., contaminant release characteristics and sedimentation characteristics). Data relating to operational considerations are usually determined by the disposal area design and by experience in dredging and disposal activities for the project under consideration or for similar projects. Data relating to the dredged material characteristics are obtained by sampling and testing the sediments to be dredged.

The process described in Section 3.4 should identify the case-specific effluent COC for effluent quality evaluations in all tiers. In addition to typical contaminants, WQS may exist for nutrients and physical parameters such as temperature, dissolved oxygen, pH, and turbidity or total suspended solids (TSS). Chlorides should be considered a potential COC whenever there is the potential for effluent from saline dredged material to enter a fresh water system. If the effluent pathway is of concern from the standpoint of contaminants, the retention of TSS within the CDF is of paramount importance, and TSS and/or turbidity should be considered a COC for the effluent pathway. Effluent elutriate tests and column settling tests provide the remaining data required for prediction of the quality of the effluent in Tier III. A summary of the data requirements for effluent quality prediction is given in Table 4-1.



<b>Table 4-1 Summary of Data Requirements for Prediction of the Quality of Effluent from Confined Dredged Material Disposal Areas</b>		
<b>Data Required</b>	<b>Symbol</b>	<b>Source of Data</b>
Dredge inflow rate	$Q_i$	Project information; site design
Dredge inflow solids concentration	$C_i$	Project information; site design
Ponded area in disposal site	$A_p$	Project information; site design
Average ponding depth in disposal site and at the weir	$D_p, D_{pw}$	Project information; site design
Hydraulic efficiency factor	HEF	Dye tracer or theoretical determination
Effluent total suspended solids concentration	$SS_{eff}$	Laboratory column settling tests
Dissolved concentration of contaminant in effluent	$C_{diss}$	Effluent elutriate tests
Fraction of contaminant in the total suspended solids in effluent	$F_{SS}$	Effluent elutriate tests
* This summary includes only those data required for effluent quality prediction. It is assumed that the disposal area under consideration is designed for effective sedimentation and storage capacity. Data requirements for such design or evaluation are found in EM 1110-2-5027 (Headquarters, USACE 1987).		

#### 4.1.6 CDF Design for Dredged Material Retention

When the quality of the effluent from a CDF is of concern, the design, operation, and management of the site should be carefully managed to ensure retention of TSS within the CDF. This includes aspects relating to both the volume required for effective sedimentation and the storage capacity of the site. Procedures for such evaluations are presented in Engineer Manual 1110-2-2-5027 (Headquarters (HQ), USACE 1987) a copy of which is included in Appendix K), and should be considered prior to the evaluations of potential effluent contaminant impacts for the project. These design procedures will determine the surface area and ponding depth required to achieve effective sedimentation, the required containment volume for storage (including required freeboard), and the proper sizing of weir structures. The prediction of the quality of the effluent is an extension and refinement of these design procedures. A list of data items required from the design evaluation is shown in Table 4-1.

#### 4.1.7 Summary of Tiered Evaluations for Effluent

A flowchart illustrating the tiered evaluation for effluent is shown in Figure 4-2. It should be noted that two types of evaluations of effluent may be required: 1) an evaluation of water quality to determine if applicable water quality standards will be met, and 2) an evaluation of water column toxicity. Each of these aspects involves separate evaluation and testing as appropriate.

If a decision regarding effluent cannot be reached based on the evaluation of existing information in Tier I, Tier II provides methods for effluent screening based on conservative assumptions. Tier III provides methods for column settling tests for evaluation effluents TSS, effluent elutriate tests (EET) for evaluating potential effluent water quality, and methods for conducting effluent water column toxicity tests. The toxicity evaluations are appropriate if there are COC for which WQS have not been established, or interactive effects of COC are of concern.

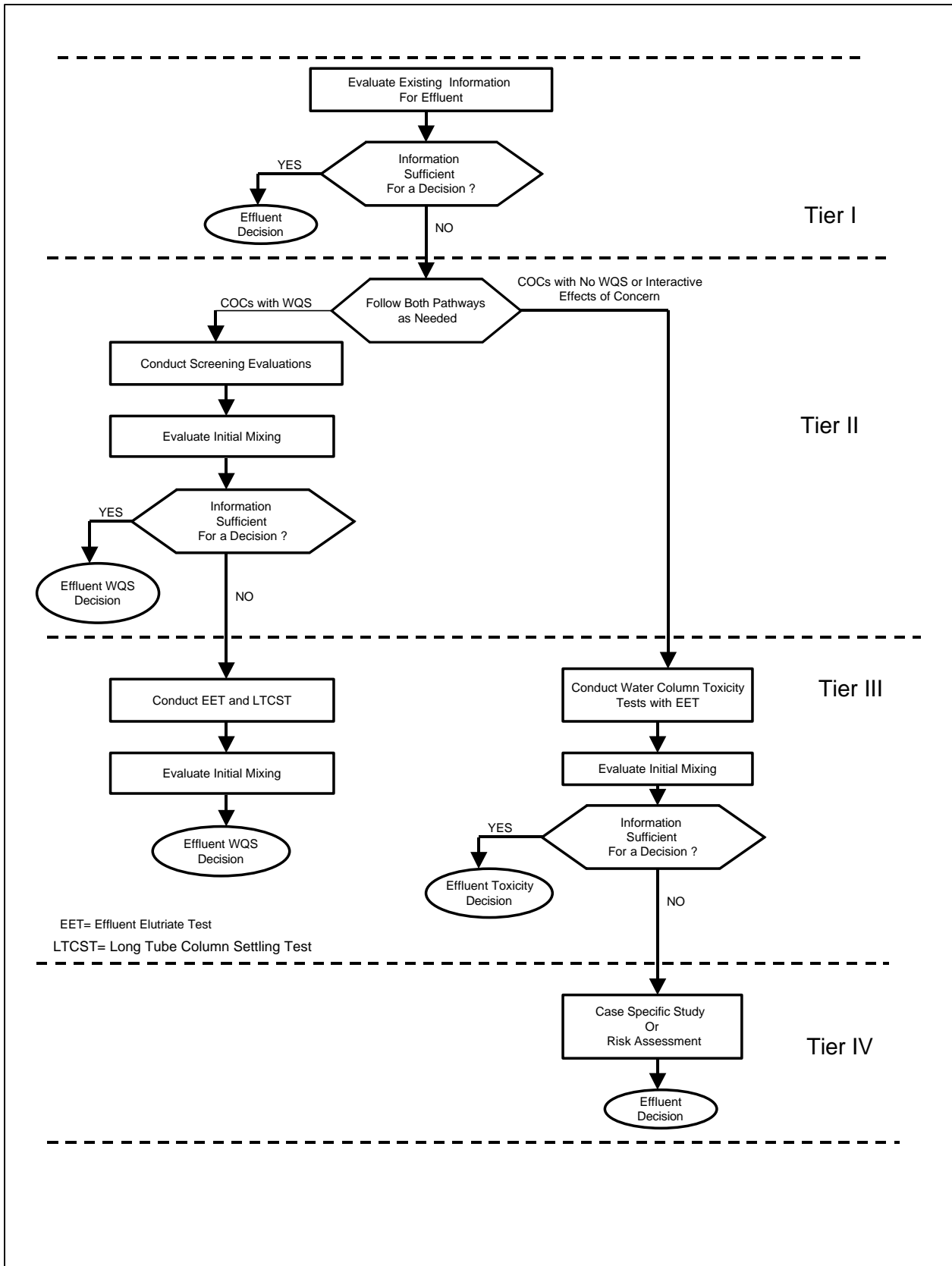

Figure 4-2. Flowchart illustrating tiered evaluation approach for the effluent pathway

The chemical and biological evaluations in Tier II and Tier III will be sufficient for evaluation of effluent discharges in the vast majority of cases. As with all pathways, Tier IV evaluations would involve consideration of effluent within the framework of a risk assessment.

The procedures in the various tiers can be applied to evaluate the performance of existing CDFs and to design new CDFs. For existing CDFs, the techniques can be used to predict the effluent quality for a given set of anticipated operational conditions (known flow and containment area size). In a similar manner, the required operational conditions for a new CDF (size, geometry, maximum allowable dredge size, etc.) can be determined to meet a given effluent quality requirement by comparing the predicted effluent quality for a variety of assumed operational conditions. In either case, evaluation of effluent quality can only be considered in conjunction with a sound design of the CDF for retention of suspended solids and initial storage of the sediments to be dredged.

#### **4.1.8 Sampling Requirements**

Note that water from the dredging site is used in the Tier III EET for evaluation of effluent discharges. Dredging site water is used since the effluent discharge only involves a small fraction of dredged material solids and the fractionation of contaminants to the dissolved phase will be influenced primarily by characteristics of the *dredging* site water. Note that *disposal* site receiving water samples should also be taken and analysed to evaluate mixing.

### **4.2 Tier I - Initial Evaluation of Effluent**

The Tier I evaluation for a proposed project (see Chapter 3) will result in determination of the need for contaminant evaluations, identification of pathways of concern, identification of contaminants of concern, and decisions based on existing information.

It is important to consider prior evaluations of the effluent pathway in Tier I to determine if additional evaluations are needed. For example, if prior tests or evaluations are available, and project conditions and dredged material characteristics are unchanged, new evaluations would not be required.

After consideration of the Tier I effluent quality information, one of the following conclusions is reached for effluent (Figure 4-2).

1. Information is sufficient to reach a decision without further evaluation.
2. Information is not sufficient to reach a decision regarding effluent quality. Conduct Tier II and/or Tier III evaluations.

## 4.3 Tier II - Water Quality Screens for Effluent

The Tier II effluent evaluations focus on the evaluation of water quality of the effluent and include two procedures and evaluation of initial mixing as an integral part of the effluent quality evaluations. The Tier II procedures rely on bulk sediment data for the proposed dredged material. If adequate bulk sediment data are not available, samples should be collected and the bulk sediment chemistry should be determined. It is possible to skip Tier II and go directly to the Tier III effluent elutriate test. However, this is not an efficient use of resources in most cases, since bulk sediment data are also needed for Tier II evaluations for the other pathways.

### 4.3.1 Tier II - Effluent Quality Screen - Assumed Total Dissolved Release

A screening procedure based on the assumption of total dissolved release of COC in effluent was developed for the ITM and is included here for the sake of completeness and consistency. This screening procedure is highly conservative, in that it grossly over-predicts the concentrations of COC in effluent.

The procedure involves a determination of whether the WQS, after consideration of mixing, would be met if the bulk concentration of COC present in the sediment were to be completely dissolved in the water flowing into the CDF and discharged as effluent from the disposal site.

The COC that would require the greatest dilution is determined by calculating the dilution that would be required to meet the applicable WQS. To determine the dilution (D) the following equation is solved for each COC:

$$D = [(C_s \times SS/1000) - C_{wq}] / (C_{wq} - C_{ds})$$

where

$C_s$  = concentration of the COC in the dredged material expressed as micrograms per kilogram ( $\mu\text{g/Kg}$ ), on a dry weight basis;

SS = suspended solids concentration in the CDF inflow expressed as grams per liter (g/L);

1000 = conversion factor, g to Kg;

$C_{wq}$  = WQS in micrograms per liter ( $\mu\text{g/L}$ ); and

$C_{ds}$  = background concentration of the COC at the disposal site in micrograms per liter ( $\mu\text{g/L}$ ).

The mixing zone evaluation is then made for the COC that would require the greatest dilution.

After consideration of the Tier II total release screen, one of the following conclusions is reached for effluent (Figure 4-2).

1. Information is sufficient to reach a decision. This is the case when WQS exist for all COC and are met for all COC after consideration of mixing. No further effluent evaluations are necessary.
2. Information is not sufficient to reach a decision. This is the case when WQS are exceeded for one or more COC after consideration of mixing. Conduct the effluent equilibrium partitioning screen (Section 4.3.2), and/or if applicable WQS are not available or there is concern about interactive effects, go to the Tier III toxicity evaluation.

#### **4.3.2 Tier II - Effluent Quality Screen - Equilibrium Partitioning**

The second Tier II evaluation for effluent is based on equilibrium partitioning principles and conservative (i.e., err on the side of environmental protection) application of design and operating principles for CDFs (Schroeder, Olin Estes, and Palermo in preparation). The equilibrium partitioning screen is based on the maximum COC concentrations that could possibly result from the dredged material effluent, considering the concentrations of dredged material solids in the ponded water and effluent, the bulk concentration of contaminants in the dredged material, the initial mixing of effluent in receiving waters, and applicable WQS. Separate procedures are available for evaluating effluent releases from both mechanically dredged and hydraulically dredged or offloaded sediments.

The effluent equilibrium partitioning procedure utilizes an electronic spreadsheet for the calculations. Project-specific information regarding the method and rate of CDF filling and dredged material properties is entered in the appropriate cells of the effluent tab of the spreadsheet. The evaluation uses these data and default values for pertinent variables to calculate a predicted maximum effluent concentration of contaminants. The results are compared to WQS. The spreadsheet, along with documentation, can be downloaded as an Automated Dredging and Disposal Alternatives Modeling System (ADDAMS) module from the USACE DOTS website at [www.wes.army.mil/el/dots](http://www.wes.army.mil/el/dots). If desired, equations for performing the calculations manually are also available (Schroeder, Olin-Estes, and Palermo in preparation).

#### **4.3.3 Tier II – Effluent Decisions**

After consideration of the Tier II effluent equilibrium partitioning evaluation, one of the following conclusions is reached (Figure 4-2).

1. Information is sufficient to reach a decision regarding effluent quality. In this case either:
  - a. WQS exist for all COC and are met for all COC after consideration of mixing. No further effluent evaluations are necessary.
  - b. WQS are exceeded for one or more COC after consideration of mixing, and information is sufficient such that management actions should be considered. A decision to implement management actions for effluent, such as operational modification or effluent treatment,

may require more detailed information prior to design of such actions. If management actions are selected, no further effluent evaluation is necessary.

2. Information is not sufficient to reach a decision, which includes cases where:
  - a. WQS are exceeded for one or more COC after consideration of mixing, and more detailed information is desired for a decision regarding WQS.
  - b. There are no applicable WQS or there is concern about interactive effects.

In either of these cases, further evaluation in Tier III, or management actions as an alternative to further evaluation, should be considered. A decision to implement management actions for effluent may require more detailed information for design of such actions. If management actions are selected, no further runoff evaluation is necessary.

In determining the potential level of concern regarding interactive effects, the number and classes of COCs that may be exceeded and the relative degree of exceedences should be considered. Interactive effects may be purely additive, synergistic (the resulting effect is greater than the sum of the effects stemming from individual COCs), or antagonistic (the resulting effect is less than the sum of the effects stemming from individual COCs). WQS were developed for single contaminants. Where several are present and are close to WQS, especially if they are the same class of contaminants (metals, chlorinated organics, metal-organic complexes, nonpolar organics, etc), interactive effects may be of concern.

## **4.4 Tier III – Effluent Water Quality and Toxicity Evaluations**

If Tier III is entered from Tier II because there was not sufficient information to make a decision about WQS, the evaluation of water quality should proceed as described in Sections 4.4.1 through 4.4.5. If Tier III is entered from Tier II because of the absence of applicable WQS or because of concern about interactive effects, the evaluation of toxicity should proceed as described in Sections 4.4.6 through 4.4.8.

### **4.4.1 Tier III - Effluent Total Suspended Solids Evaluation**

If Tier III is entered for WQS evaluation, TSS and/or turbidity should be evaluated as a COC. A Long Tube Column Settling Test (LTCST) is conducted for the Tier III evaluation of TSS in the effluent. The LTCST measures the effluent TSS for anticipated ponding and operational conditions (Averett, Palermo, and Wade 1988; Montgomery, Thackston, and Parker 1983; and Palermo and Thackston 1988c). This test is conducted in an 8-inch diameter,

8-foot-long column as shown in Figure 4-3. Also, if WQS for total or whole water concentrations are applicable, the column settling test is also required for the Tier III effluent water quality evaluation. Since the column test is also used for engineering design of the CDF for storage and solids retention (Section 4.1.6), in most cases, the column test will be conducted even if no WQS exist for effluent total suspended solids, turbidity, or whole water contaminants. Detailed procedures for the LTCST are provided in Appendix B and also in Engineer Manual 1110-2-5027 (HQUSACE 1987). A copy of EM 1110-2.5027 is also included in Appendix K.

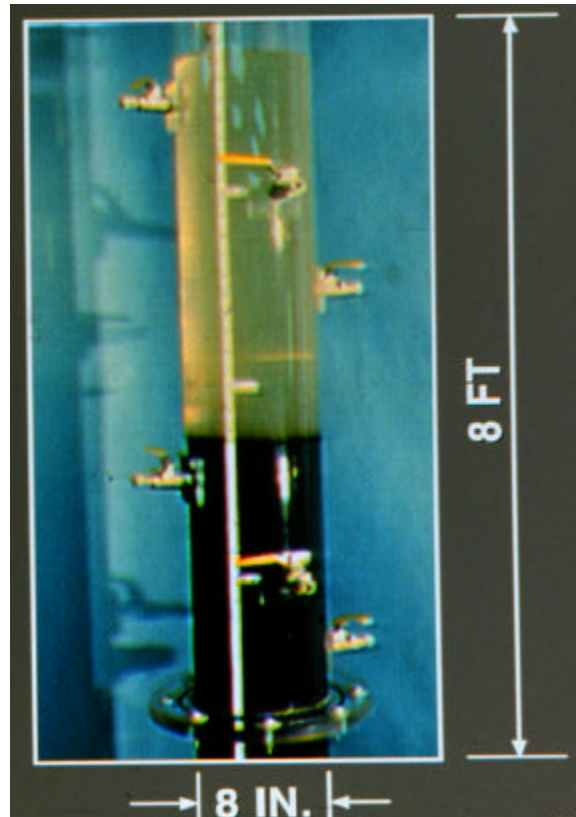

Figure 4-3. Photo of 8-inch settling column test

#### 4.4.2 Tier III - Effluent Water Quality Evaluation – Effluent Elutriate Test (EET)

The Tier III evaluation of effluent water quality is based on a laboratory elutriate simulation of the effluent discharge. This effluent elutriate test<sup>1</sup> (EET) is designed to account for the settling processes and geochemical changes occurring

---

<sup>1</sup> The effluent elutriate test (EET) has been called the “modified elutriate” in earlier literature to distinguish it from the “standard elutriate” test, which is applicable to open water discharges. The term “effluent elutriate test” is used in this manual and in the ITM for elutriate evaluations of CDF effluent, and the term “open water elutriate” is used in the ITM instead of the term “standard elutriate” to describe the procedure for the open water evaluations.

in the CDF supernatant water during active disposal operations (Palermo 1985a-d; Palermo and Thackston 1988a and b). EET results define the concentration of COCs discharged from the CDF (i.e., over the weir structure), therefore an evaluation of initial mixing should be conducted (Appendix E) prior to comparisons with WQS.

Figure 4-4 is a photo of a typical laboratory setup for the EET. Sediment and water from the dredging site are mixed into a slurry with a solids concentration equivalent to that expected in the CDF inflow. The slurry is placed in 4-L cylinders and aerated for 1 hour to ensure that oxidizing conditions will be present during the subsequent settling phase. The aerated slurry is allowed to settle for a time period equivalent to the expected field mean retention time in the CDF, up to a maximum settling time of 24 hour. The supernatant water is extracted from the cylinders and analysed as the effluent elutriate. The results may then be compared with applicable water quality standards after consideration of initial mixing.

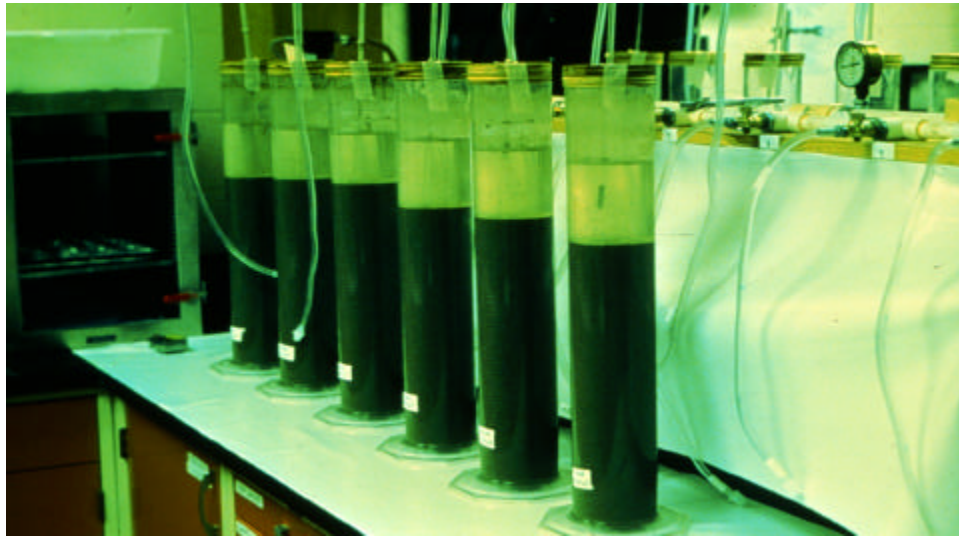

Figure 4-4. Photo of typical laboratory setup for the effluent elutriate test

Depending on the basis of applicable WQS (Section 2.3.2), the prediction of the quality of effluent from CDFs accounts for the dissolved concentration of contaminants and may also consider that fraction associated with the released total suspended solids. If the WQS are applied to dissolved concentrations, the effluent elutriate samples are analysed for dissolved contaminants only, and the results are compared to WQS after consideration of initial mixing (this approach is identical to that for effluent in the ITM).

If the WQS are applied to whole water concentrations, both the EET and LTCST are required. For this evaluation, the EET determines the contaminant partitioning between dissolved and particulate phases, while the LTCST determines the total particulates (TSS) in the effluent. In this case, the EET samples are analysed for TSS concentration and for both dissolved contaminants and total concentrations of contaminants, allowing for determination of both dissolved and particle-associated contaminant concentrations. Using results from both the EET and an estimate of effluent TSS from the LTCST, a mass balance



calculation for prediction of the total concentration of contaminants in the effluent can be made.

Comparisons of predicted concentrations based on laboratory tests with water quality standards should also consider background concentrations in receiving waters and the detection limits used in the tests. If background concentrations exceed the standards, a specified percentage above background may be considered in determining a dilution requirement (in this case, mixing to concentration slightly above background, say 10 percent, would not be expected to result in unacceptable adverse impacts). Considering predicted concentrations in effluent, standards, background, and detection limits, a number of different cases may apply in interpretation of the comparisons and dilution factor required. These cases are illustrated in Figure 4-5 and are considered in the EFQUAL program (Section 4.4.4).

Detailed procedures for conducting the EET and LTCST and calculations for prediction of effluent quality are provided in Appendix B.

#### **4.4.3 SETTLE – Computer-Assisted Settling Data Analysis**

The SETTLE application (Hayes and Schroeder 1992) of the Automated Dredging and Disposal Alternatives Modeling System (ADDAMS) suite of computer programs (Schroeder and Palermo 2000) provides a computer program to assist users in the design of a CDF for solids retention and initial storage in accordance with the design procedures in Engineer Manual 1110-2-5027 (HQ, USACE 1987). SETTLE performs the necessary calculations for prediction of effluent TSS concentrations for given CDF ponding and flow rate conditions, and a relationship between CDF retention time and effluent TSS can be developed. The laboratory column settling test is an integral part of these design procedures, and the data from the LTCST are required in order to use this application. The SETTLE application, along with documentation, is included in this manual as Appendix E and can also be downloaded from the USACE DOTS website at [www.wes.army.mil/el/dots](http://www.wes.army.mil/el/dots). If desired, manual data analysis procedures for CDF design using the column settling test data are available (EM 1110-2-5027 (HQ, USACE 1987); Appendix B Inland Testing Manual (EPA/USACE 1998; and Palermo 1985a-d)).

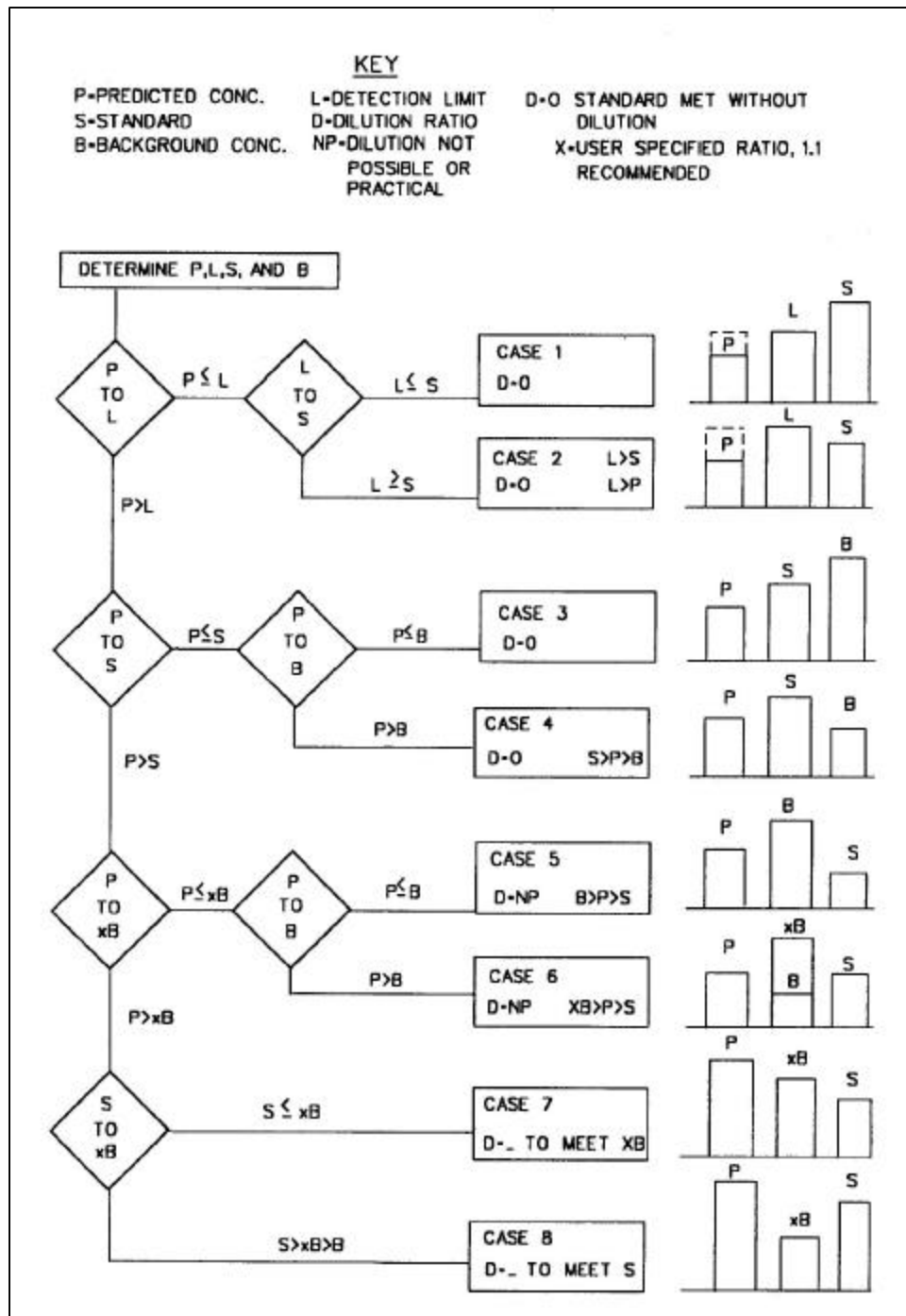

Figure 4-5. Possible conditions for comparison of effluent concentrations with standards

#### 4.4.4 EFQUAL – Computer-Assisted Analysis of Effluent Water Quality

The EFQUAL application (Palermo and Schroeder 1991) of the ADDAMS suite of computer programs (Schroeder and Palermo 2000) provides a computer

program to assist in the analysis of effluent elutriate data and the comparisons with WQS. The EFQUAL application considers and tabulates the EFQUAL application, along with documentation, and can be downloaded from the USACE DOTS website at [www.wes.army.mil/el/dots](http://www.wes.army.mil/el/dots). If desired, data analyses procedures for reducing effluent elutriate data and comparison of effluent with WQS using manual calculations are available (Appendix B; Appendix B of the ITM (EPA/USACE 1998); and Palermo 1985 a-d).

#### **4.4.5 Tier III - Effluent Elutriate - Water Quality Decision**

After consideration of the Tier III effluent elutriate water quality information, to include consideration of initial mixing, one of the following conclusions is reached (Figure 4-2):

1. Information is sufficient to reach an effluent decision regarding water quality. In this case either:
  - a. WQS exist for all COC and are met for all COC after consideration of mixing. No further effluent evaluations are necessary. Or,
  - b. WQS are exceeded for one or more COC after consideration of mixing, and management actions should be considered.
2. Information is not sufficient to reach a decision, which includes cases where there are no applicable WQS or there is concern about interactive effects. Evaluation of effluent toxicity, or management actions as an alternative to further evaluation should be considered. If management actions are selected, no further effluent evaluation is necessary.

In determining the potential level of concern regarding interactive effects, the number and classes of COCs that may be exceeded and the relative degree of exceedences should be considered. Interactive effects may be purely additive, synergistic (the resulting effect is greater than the sum of the effects from individual COCs), or antagonistic (the resulting effect is less than the sum of the effects from individual COCs). WQS were developed for single contaminants. Where several are present and are close to WQS, especially if they are the same class of contaminants (metals, chlorinated organics, metal-organic complexes, nonpolar organics, etc), interactive effects may be of concern.

#### **4.4.6 Tier III - Effluent Toxicity Evaluation**

Effluent toxicity should be evaluated in Tier III if there are COC for which there are no WQS or if there is concern regarding potential interaction of multiple contaminants. Bioassays provide information on the toxicity of contaminants not included in the WQS and indicate possible interactive effects of multiple contaminants. Tier III provides for evaluations of effluent toxicity based on use of the effluent elutriate as a medium to conduct water column toxicity tests. Tier III toxicity testing assesses the potential toxicity of effluent to appropriate sensitive water column organisms. As with chemical evaluations of effluent quality,

the results of the water column toxicity tests should be interpreted considering the effects of mixing (Appendix E).

The evaluation uses the effluent elutriate to determine the potential toxicity of effluent from the proposed operation. Results should be interpreted with consideration of mixing. The toxicity test medium is effluent elutriate prepared to simulate the whole effluent (i.e., not filtered). Detailed guidance for preparing the effluent elutriate for use in toxicity tests is provided in Appendix B.

Conventional water column toxicity test procedures are used to evaluate effluent toxicity in the water column. The toxicity tests involve exposing test organisms to a dilution series containing both dissolved and suspended components of the simulated effluent prepared with the elutriate procedure as described above. The test organisms are added to the exposure chambers and exposed for a prescribed period (usually 96 hours though some tests, e.g., bivalve larvae, may be run for shorter periods). The surviving organisms are examined at specified intervals and/or at the end of the test, and the concentration at which the test material produces an effect, if it does so, is determined. The results of the water column toxicity test are expressed in terms of the LC50 or EC50 expressed as a percentage of the original (i.e., 100 percent) effluent elutriate concentration. This result is then compared with the concentration of the effluent at the boundary of the allowable mixing zone to determine the acceptability of the effluent discharge.

The detailed procedures for conducting the water column toxicity tests with the effluent elutriate described above are provided in the ITM (EPA/USACE 1998).

#### **4.4.7 LAT-E - Computer-Assisted Effluent Toxicity Evaluation**

The LAT-E application (Brandon, Schroeder, and Lee 1997) of the ADDAMS suite of computer programs (Schroeder and Palermo 2000) provides a computer program to assist in the analysis of effluent toxicity. The LAT-E application, along with documentation, can be downloaded from the USACE DOTS website at [www.wes.army.mil/el/dots](http://www.wes.army.mil/el/dots). If desired, manual data analyses procedures for evaluation of effluent toxicity are available in the ITM (EPA/USACE 1998).

#### **4.4.8 Tier III - Effluent Toxicity Decision**

After consideration of the Tier III effluent toxicity information, one of the following conclusions is reached (Figure 4-2):

1. Information is sufficient to reach a decision regarding effluent toxicity. In this case either:
  - a. The effluent toxicity poses no risk after consideration of mixing, and no further effluent evaluations are necessary.

- b. The effluent toxicity poses a risk after consideration of mixing, and management actions should be considered. If management actions are selected, no further effluent evaluation is necessary.
2. Information is not sufficient to reach a decision regarding effluent toxicity. The case-specific risk from effluent should be determined in Tier IV, or management actions as an alternative to further evaluation should be considered. If management actions are selected, no further effluent evaluation is necessary.

## **4.5 Tier IV - Effluent Risk Assessment**

### **4.5.1 Evaluation**

Tier IV is intended to answer whatever specific, well-defined technical questions may remain unanswered after thorough evaluation in earlier tiers. If earlier tiers are used properly, Tier IV should rarely be necessary.

By the nature of the tiered evaluation approach, any technical questions that remain unresolved after Tier III can best be answered by a detailed, case-specific evaluation. By their very nature, detailed case-specific evaluations are not amenable to the kind of generic guidance that can be presented in a national manual. They require individual design to address unique technical questions under site-specific conditions.

The best approach for Tier IV is usually a case-specific risk assessment. Detailed guidance for conducting risk assessments for CDFs in Tier IV can be found by Cura, Wickwire, and McArlde (in preparation). The information generated in Tiers I through III should be used to the maximum extent technically justified throughout the Tier IV risk assessment.

### **4.5.2 Tier IV Effluent Decision**

After consideration of the Tier IV effluent evaluation results, all relevant information is available and no further evaluation is possible. One of the following conclusions is reached.

1. No management actions are required.
2. Management actions should be considered. A decision to implement management actions for effluent, such as operational modification or effluent treatment, may require more detailed information prior to design of such actions.

## **4.6 Effluent Management Actions**

If the testing and associated analysis of the effluent pathway indicates applicable WQS or toxicity concerns will not be satisfied after consideration of mixing, appropriate management actions may be considered to reduce effects. These may

include actions such as modification of the operation (e.g., use of a smaller dredge with reduced inflow rate, providing increased ponded area and depth of the CDF, or relocation of the inflow and effluent discharge points), treatment or filtration of effluent to reduce the concentration of suspended solids and associated contaminants in the effluent, and treatment of effluent to remove dissolved contaminants. Additional information on management actions and references for detailed guidance on implementation are found in Chapter 10 of this manual.

## 4.7 References

- Averett, D. E., Palermo, M. R., and Wade, R. (1988). "Verification of procedures for design of dredged material containment areas for solids retention," Technical Report D-88-2, U.S. Army Engineer Waterways Experiment Station, Vicksburg, MS.
- Brandon, D. L., Schroeder, P. R., and Lee, C. R. (1997). "Computerization of the decision-making framework: Effluent toxicity bioassay test results (LAT-E Program)," Technical Note EEDP-04-27, U.S. Army Engineer Waterways Experiment Station, Vicksburg, MS.
- Cura, J., Wickwire, T., and McArde, M. "Ecological and human health risk assessment guidance for terrestrial environments," DOER Technical Report (in preparation), U.S. Army Engineer Research and Development Center, Vicksburg, MS.
- Environmental Protection Agency/U.S. Army Corps of Engineers. (1998). "Evaluation of dredged material proposed for discharge in waters of the U.S. – testing manual," EPA-823-B-98-004, Office of Water, Washington, DC.
- Fulk, R., Gruber, D., and Wullschleger, R. (1975). "Laboratory study of the release of pesticide and PCB materials to the water column during dredging and disposal operations," Contract Report D-75-6, prepared by Envirex, Inc., under contract to the U.S. Army Engineer Waterways Experiment Station, Vicksburg, MS.
- Hayes, D. L., and Schroeder, P. R. (1992). "Documentation of the SETTLE module for ADDAMS: Design of confined disposal facilities for solids retention and initial storage," Technical Note EEDP-06-18, U.S. Army Engineer Waterways Experiment Station, Vicksburg, MS.
- Headquarters, U.S. Army Corps of Engineers. (1987). "Confined disposal of dredged material," Engineer Manual 1110-2-5027, Washington, DC.
- Krizek, R. K., FitzPatrick, J. A., and Atmatzidis, D. K. (1976). "Investigation of effluent filtering systems for dredged material containment facilities," Technical Report D-76-8, U.S. Army Engineer Waterways Experiment Station, Vicksburg, MS.

- Montgomery, R. L., Thackston, E. L., and Parker, F. L. (1983). "Dredged material sedimentation basin design," *Journal of Environmental Engineering*, American Society of Civil Engineers, 109 (2).
- Palermo, M. R. (1985a-d). "Interim guidance for predicting quality of effluent discharged from confined dredged material disposal areas," EEDP-04-01 through 04-4, U.S. Army Engineer Waterways Experiment Station, Environmental Laboratory, Vicksburg, MS.
- Palermo, M. R., and Schroeder, P. R. (1991). "Documentation of the EFQUAL module for ADDAMS: Comparison of predicted effluent quality with standards," Technical Note EEDP-06-13, U.S. Army Engineer Waterways Experiment Station, Vicksburg, Miss.
- Palermo, M. R., and Thackston, E. L. (1988a). "Test for dredged material effluent quality," *Journal of Environmental Engineering*, American Society of Civil Engineers, 114 (6).
- \_\_\_\_\_. (1988b). "Verification of predictions of dredged material effluent quality," *Journal of Environmental Engineering*, American Society of Civil Engineers, 114 (6).
- \_\_\_\_\_. (1988c). "Flocculent settling above the zone settling interface," *Journal of Environmental Engineering*, American Society of Civil Engineers, 114 (4).
- Schroeder, P. R., and Palermo, M. R. (2000). (Revision of 1990). "The automated dredging and disposal alternatives management system (ADDAMS)," Environmental Effects of Dredging Technical Note EEDP-06-12, U.S. Army Engineer Waterways Experiment Station, Vicksburg, MS.
- Schroeder, P. R., Olin-Estes, T. J., and Palermo, M. R. "Screening evaluations for confined disposal facility effluent quality," Environmental Effects of Dredging Technical Note in preparation, U.S. Army Engineer Research and Development Center, Vicksburg, MS.
- Thackston, E. L., and Palermo, M. R. (2000). "Improved methods for correlating turbidity and suspended solids for monitoring," *DOER Technical Notes Collection* (ERDC TN-DOER-E8), U.S. Army Engineer Research and Development Center, Vicksburg, MS. [www.wes.army.mil/el/dots/doer](http://www.wes.army.mil/el/dots/doer)
- U.S. Army Corps of Engineers/Environmental Protection Agency. (1992). "Evaluating environmental effects of dredged material management alternatives - A technical framework," EPA842-B-92-008, Washington, DC.
- U.S. Environmental Protection Agency/U.S. Army Corps of Engineers (1995). "QA/QC guidance for sampling and analysis of sediments, water, and tissues for dredged material evaluations - chemical evaluations," EPA-823-B-95-001, Washington, DC.

# 5 Surface Runoff After Disposal Operations

---

## 5.1 General Considerations

Runoff is the water and associated suspended and dissolved materials released from island, nearshore, or upland CDFs resulting from precipitation events on exposed dredged material. The tiered structure of evaluation procedures for surface runoff is similar to that for effluent. Like effluent, runoff typically enters nearby surface water but may be released onto the surface of the adjacent soil. Unlike effluent, which is generated only during the disposal and initial dewatering of dredged material, runoff is a long-term pathway that exists as long as the dredged material surface is exposed to precipitation and there is a discharge of runoff from the CDF.

The runoff evaluation procedures generally consider worst-case scenarios in the evaluation of runoff release:

1. Newly placed dredged material that is easily eroded during precipitation events.
2. Oxidized, older material subject to increased solubility of metals.
3. No vegetative cover.
4. Direct discharge of generated runoff water.
5. Intense precipitation event equivalent to rainfall of 5.08 cm (2 in.) per hour.

Considerations of runoff retention through ponding, effects of vegetation, and low precipitation rates are currently not incorporated into the evaluation process. These and other considerations will be included in the evaluation process as the runoff pathway evaluation procedures are further developed.



### 5.1.1 Runoff Processes

The runoff pathway is of potential concern as soon as the water ponded during placement is decanted and the dredged material is exposed to precipitation and continues as long as the dredged material surface is exposed through the life of the CDF. A schematic of CDF conditions and fate of runoff water in a CDF is shown in Figure 5-1. Immediately after disposal and initial decanting processes, resuspension of newly placed dredged material through the process of precipitation impact on the dredged material surface will generate runoff water similar to effluent water produced during filling. Suspended solids in the runoff can range up to 10 g/L during this stage, and most contaminants will be associated with these suspended solids. Most heavy metals will be low in the dissolved phase and high nutrient levels associated with anaerobic conditions in the dredged material will still be present. If CDF weirs are boarded such that they provide retention of runoff prior to discharge, TSS in runoff will be reduced.

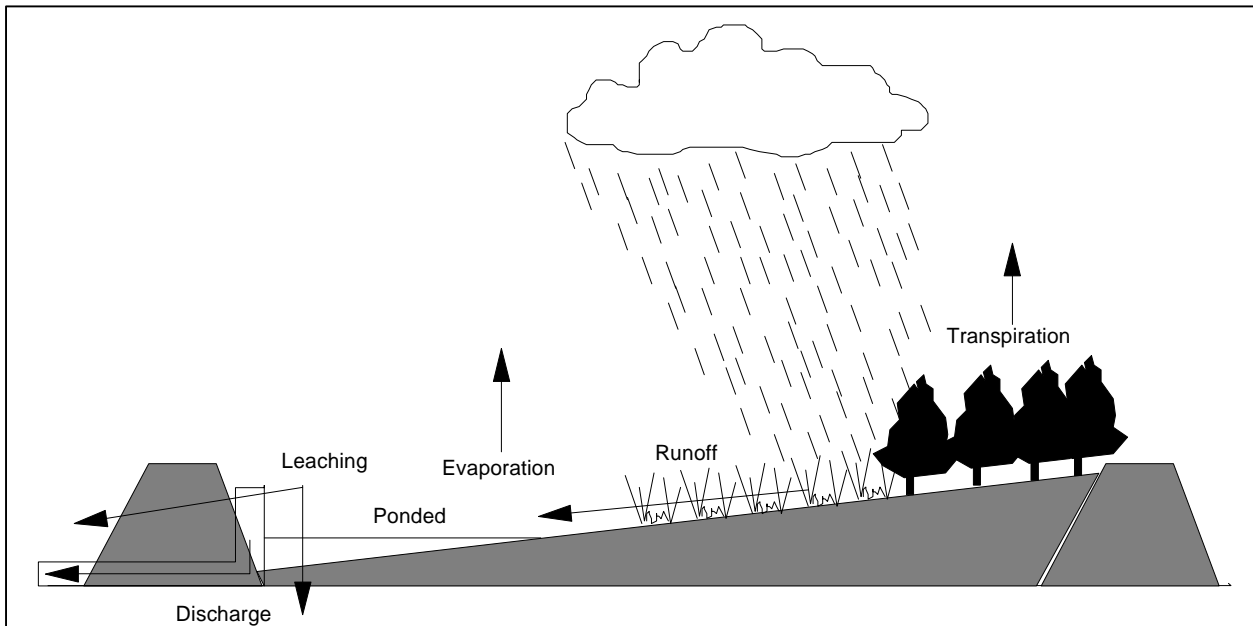

Figure 5-1. Illustration of the CDF surface runoff process

Once the dredged material surface is exposed, the material begins to dry and oxidize. Runoff quality from dried and oxidized dredged material may differ significantly from the effluent water quality during dredged material disposal. For instance, some metals become very soluble once dredged material oxidizes, and simply controlling suspended solids discharges in runoff will not control the discharge of metals in runoff released from the CDF. Since effects on runoff quality, such as ponding and runoff rates, are variable because of site management and climatic conditions, the runoff evaluation presently only considers direct, uncontrolled discharge in the testing process.

### **5.1.2 Influence of CDF Design and Operation on Runoff**

The method of filling can affect the erosiveness of the dredged material, the rate of runoff, and resulting suspended solids generation. Hydraulic disposal tends to provide a smoother surface while mechanical disposal from a conveyor or truck tends to provide a rougher surface unless altered by grading equipment. Most runoff studies to date have addressed the hydraulic disposal option. No data have been gathered to determine if there is any significant difference in runoff characteristics as a result of mechanical disposal. It is assumed that although suspended solids generation may be different between disposal options, the effects on soluble contaminants would not be significantly affected and the current testing approach is suitable for both.

### **5.1.3 Regulatory Considerations**

If there is a reason to believe that surface water runoff might contain contaminants, evaluations using this chapter will be required. As defined, surface water runoff is considered as a discharge of dredged material to waters of the United States and is subject to the same nationwide permit as effluent discharge, requiring Section 401 Water Quality Certification. The water quality certification issues for surface runoff should be addressed at the same time that certification is obtained for the effluent discharge.

In addition to typical contaminants, WQS may exist for nutrients and physical parameters such as turbidity or TSS. Chlorides should be considered a potential COC whenever there is the potential for runoff from saline dredged material to enter a fresh water system.

### **5.1.4 Mixing Zones**

As for effluent, the evaluation of runoff discharges should consider the effects of mixing and dispersion. Mixing zones are normally defined by the State regulatory agency as part of the CWA Section 401 Water Quality Certification requirements. When runoff enters receiving waters, it is dispersed by natural physical processes so that the concentration decreases spatially and temporally beyond the point of entry. This phenomenon is important in determining the potential for effects, because effects depend on both the concentration to which organisms are exposed and the length of time for which they are exposed. Effects are generally less at lower exposure concentrations or shorter exposure times, and for each COC, there are exposure time-concentration combinations below which effects do not occur. The Federal regulations implementing Section 404(b)(1) of the Clean Water Act (40 CFR 230) recognize this and explicitly provide for consideration of mixing in evaluating dredged material releases.

Mixing calculations describe the spatial and temporal boundaries within which the discharge will reach the WQS. If these boundaries are within the established mixing zone limits, there should not be an effect. If these boundaries exceed the established mixing zone limits, there may be an effect.

### 5.1.5 Data Requirements

Data requirements for runoff evaluations include those pertaining to the dredged material characteristics and should be obtained by sampling the sediments to be dredged and testing them. The process described in Chapter 3 should identify the COCs for runoff quality evaluations. The dredged material characterization data, the simplified laboratory runoff procedure (SLRP), and/or the runoff simulator/lysimeter system (RSLs) tests described below provide the remaining data required for prediction of the quality of the runoff. The CDF surface area, slopes, and precipitation data for the region are also required. A summary of the data requirements for runoff quality prediction is given in Table 5-1.

<b>Table 5-1 Summary of Data Requirements for Prediction of the Quality of Runoff from Confined Dredged Material Disposal Areas</b>	
<b>Data Required</b>	<b>Source of Data</b>
Runoff total suspended solids concentration	
Dissolved concentration of COC in runoff	Equilibrium Partitioning or SLRP or RSLs tests
Total concentration of COC in runoff	SLRP or RSLs tests
Fraction of COC in the total suspended solids in runoff	SLRP or RSLs tests
CDF Surface Area	Site information
CDF Slope	Site information
Precipitation Data	National Weather Service
* This summary includes only those data required for runoff quality prediction. It is assumed that the disposal area under consideration is designed for effective sedimentation and storage capacity to handle effluent. Data requirements for such design or evaluation are found in EM 1110-2-5027 (HQUSACE 1987). The runoff evaluation assumes the worst case (direct discharge of runoff with no retention time), so ponding effects are not considered in the evaluation of results.	

### 5.1.6 CDF Design for Runoff Control

When the quality of the runoff from a CDF is of concern, the design, operation, and management of the site is important. Because the runoff pathway is of concern after filling and initial dewatering operations, CDF management for runoff is different than for effluent. However, the storage time required for effective sedimentation of TSS in runoff should be considered. Procedures described in Engineer Manual 1110-2-2-5027 (HQUSACE 1987) for evaluating TSS retention in CDF are generally applicable to runoff. These design procedures determine the surface area and ponding depth required to achieve effective sedimentation, the required containment volume for storage (including required freeboard), and the proper sizing of weir structures.

Generally, a CDF designed for effective management of effluent would have adequate storage capacity for managing precipitation runoff. However, as the dredged material oxidizes and some contaminants become more soluble, simply allowing time for settling may not be sufficient to reduce contaminants dissolved in runoff.

### 5.1.7 Overview of Evaluations for Runoff Discharges

A flowchart illustrating the tiered evaluation for runoff is shown in Figure 5-2. It should be noted that two types of evaluations of runoff may be required:

1. An evaluation of water quality to determine if applicable water quality standards will be met.
2. An evaluation of water column toxicity.

Each of these aspects involves separate evaluation and testing as appropriate.

If a decision regarding runoff cannot be reached based on the evaluation of existing information in Tier I, Tier II provides methods for screening based on conservative assumptions. Tier III provides tests for evaluating potential runoff quality and methods for conducting water column bioassays for evaluating water column toxicity for the runoff discharge. The toxicity evaluations are used if there are COC for which WQS have not been established, or interactive effects of COC are of concern. The Tier II and Tier III evaluations will be sufficient for evaluation of runoff discharges in the vast majority of cases. As with all pathways, Tier IV evaluations would involve consideration of runoff within the framework of a risk assessment.

The procedures in the various tiers are designed to evaluate runoff for both new and existing sites. For new sites, the runoff evaluation can provide information necessary to design the CDF to manage runoff water effectively to meet water quality standards. For existing sites, additional controls, not part of the existing design and management, may need to be added to control runoff. The techniques described in this chapter are designed to evaluate worst-case conditions, and specific conditions such as vegetative cover, low precipitation intensities and other factors that restrict runoff should be evaluated on a case-by-case basis. Management of runoff should be considered as part of an overall long-term management strategy.

## 5.2 Tier I - Initial Evaluation of Runoff

The Tier I evaluation for a proposed project (Chapter 3) will result in determination of the need for contaminant evaluations, identification of pathways of concern, identification of contaminants of concern, and decisions based on existing information.

It is important to consider prior evaluations of the runoff pathway in Tier I to determine if additional evaluations are needed. For example, if prior tests or evaluations are available, and project conditions and dredged material characteristics are unchanged, new evaluations would not be required.

After consideration of the Tier I runoff quality information, one of the following conclusions is reached for runoff (Figure 5-2).

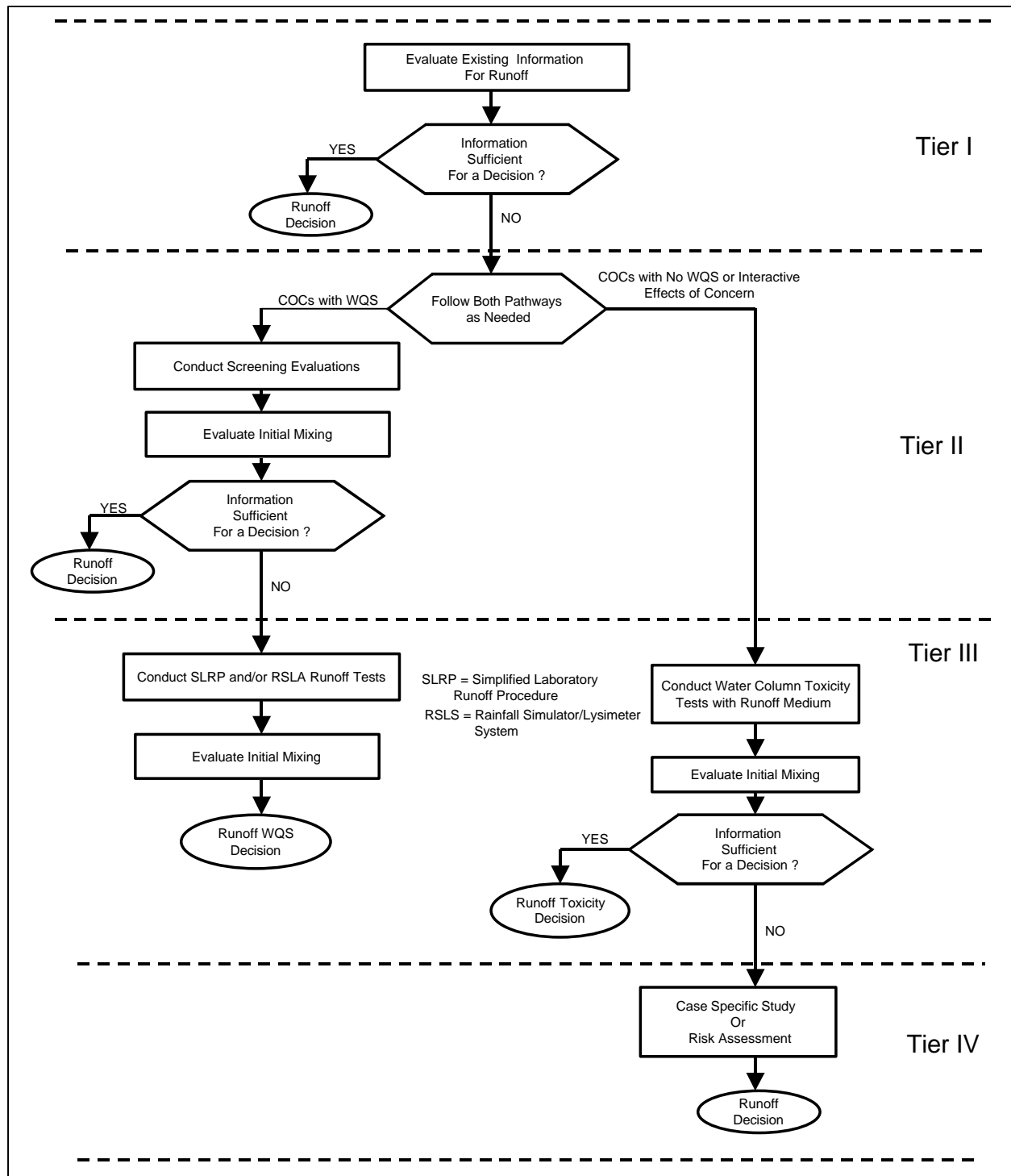

Figure 5-2. Flowchart illustrating tiered evaluation approach for the runoff pathway

1. Information is sufficient to reach a decision without further evaluation.
2. Information is not sufficient to reach a decision regarding runoff quality. Conduct Tier II and/or Tier III evaluations.

## **5.3 Tier II – Water Quality Screen for Runoff**

The Tier II screens rely on bulk sediment data of the proposed dredged material. If adequate bulk sediment data are not available, samples should be collected and the bulk sediment chemistry should be determined. It is possible to skip the screens and go directly to the Tier III runoff tests. However, this is not an efficient use of resources in most cases, since bulk sediment data are also needed for screening evaluations for the other pathways.

### **5.3.1 Tier II - Runoff Water Quality Screen - Equilibrium Partitioning**

The screen for runoff is based on equilibrium partitioning principles and conservative (i.e., err on the side of environmental protection) application of design and operating principles for CDFs (Schroeder, Lee, and Price in preparation). The evaluation utilizes site-specific data and default values for pertinent variables to calculate a predicted runoff concentration of contaminants. The results are compared to water quality standards.

The surface runoff quality screening protocol, during the early stages of drying, is similar to that for effluent quality for hydraulic disposal of dredged material in a confined disposal facility and was likewise developed based on the equilibrium and mixing boundary conditions. [The protocol produces two estimates of the runoff concentration based on these boundary conditions. The smaller of the two estimates (smaller calculated sediment contaminant concentration meeting standards) is used as the screening criteria.] The equilibrium partitioning calculations assume that only a fraction of the metals in the sediment is soluble. The fraction varies from metal to metal.

After the dredged material dries out and becomes oxidized, the surface runoff quality screening protocol was developed based on solubility/equilibrium and mixing boundary conditions. During drying, the dredged material consolidates and forms cracks in the surface of the CDF. Surfaces of the dredged material tend to accumulate salt as the pore water moisture evaporates from the surface, leaving any salt dissolved in the pore water on the surface of the cracks. Precipitation dissolves the salt and removes it from the dredged material. During the drying process many metals such as zinc, cadmium, copper, nickel, lead, and mercury are converted from poorly soluble metal sulfides formed under reduced, anaerobic conditions to more soluble metal salts. Organic contaminants become tightly adsorbed onto soil and organic particulates and remain associated with suspended solids in surface runoff water. As with effluent, dilution occurring within the mixing zone at the point of discharge should be considered in evaluating runoff.

An electronic spreadsheet program is available to apply the screens to include all necessary calculations. The spreadsheet, along with documentation can be downloaded as an ADDAMS module from the USACE DOTS website at [www.wes.army.mil/el/dots](http://www.wes.army.mil/el/dots). If desired manual calculation procedures are available (Schroeder, Lee, and Price in preparation).

### 5.3.2 Tier II - Runoff Water Quality Decision

After consideration of the Tier II runoff partitioning screen, one of the following conclusions is reached for runoff (Figure 5-2).

1. Information is sufficient to reach a decision regarding runoff quality. In this case either:
  - a. WQS exist for all COC and are met for all COC after consideration of mixing. No further runoff evaluation is necessary.
  - b. WQS are exceeded for one or more COC after consideration of mixing, and management actions should be considered. A decision to implement management actions for runoff, such as placement of surface covers or runoff treatment, may require more detailed information for design of such actions. If management actions are selected, no further runoff evaluation is necessary.
2. Information is not sufficient to reach a decision, which includes cases where:
  - a. WQS are exceeded for one or more COC after consideration of mixing, and more detailed information is desired for a decision regarding WQS.
  - b. There are no applicable WQS, or there is concern about interactive effects.

In either case, further evaluation in Tier III, or management actions as an alternative to further evaluation, should be considered. A decision to implement management actions for runoff may require more detailed information for design of such actions. If management actions are selected, no further runoff evaluation is necessary.

In determining the potential level of concern regarding interactive effects, the number and classes of COCs that may be exceeded and the relative degree of exceedences should be considered. Interactive effects may be purely additive, synergistic (the resulting effect is greater than the sum of the effects resulting from individual COCs), or antagonistic (the resulting effect is less than the sum of the effects from individual COCs). WQS were developed for single contaminants. Where several are present and are close to WQS, especially if they are the same class of contaminants (metals, chlorinated organics, metal-organic complexes, nonpolar organics, etc), interactive effects may be of concern.

## **5.4 Tier III – Runoff Water Quality and Toxicity Evaluations**

If Tier III is entered from Tier II because there was not sufficient information to make a decision about WQS, the evaluation of runoff water quality should proceed as described in Sections 5.4.1 through 5.4.5. If Tier III is entered from Tier II because of the absence of applicable WQS or because of concern about interactive effects, the evaluation of runoff toxicity should proceed as described in Sections 5.4.6 through 5.4.8.

### **5.4.1 Tier III - Runoff Simulation Approaches**

Two laboratory tests are available in Tier III for prediction of runoff quality, the Simplified Laboratory Runoff Procedure (SLRP) and the Rainfall Simulator/ Lysimeter System (RSLs). The SLRP is a simple and cost-effective batch extraction test for runoff quality prediction. The RSLs is a more costly, time-consuming, and logistically demanding test in that it requires use of a mechanical rainfall simulator and a large volume sediment sample exposed in a soil bed (lysimeter) to a simulated rainfall runoff event. The SLRP is a more conservative test procedure than the RSLs with respect to the predicted contaminant release to the dissolved phase because the procedure exposes all particles in the test sample to the extraction, while the RSLs only exposes the surface of the sediment sample to the runoff simulation. Since the RSLs makes use of a simulator and large-scale movable soil bed, it provides a more accurate simulation of runoff quality by accounting for field conditions such as rainfall intensity, CDF slope, surface exposure to runoff, and dredged material profile conditions to include crust formation and cracking. Based on these considerations, the recommended approach for Tier III runoff evaluations is to conduct the SLRP procedure initially. If more accurate data are considered necessary prior to a decision, the RSLs procedure can then be conducted.

### **5.4.2 Tier III - Simplified Laboratory Runoff Procedure (SLRP)**

The SLRP is a predictive laboratory test consisting of an oxidation and suspension simulation of the runoff generated within the CDF (Figure 5-3). The occurrence of precipitation events on freshly placed dredged material will normally produce water quality similar to the effluent during disposal and dewatering operations. However, differences in carrier water (receiving water vs. precipitation) and other exposure characteristics prevent the effluent data from being used to predict precipitation runoff at this time. The SLRP also evaluates potential oxidation and increased solubility of metals resulting from long-term drying of dredged material.

Depending on the basis of applicable WQS, the prediction of the quality of runoff from CDFs accounts for the dissolved concentration of contaminants and may also consider that fraction associated with the released total suspended solids. Although total contaminants in runoff are generally not required for water quality comparisons, these data can be determined by analysis of unfiltered SLRP



elutriates or from analysis of samples of wet, dry, and oxidized sediments using a dilution calculation. If no standards for whole water contaminants exist, the runoff water only requires analysis of dissolved contaminants. This will be true in most cases.

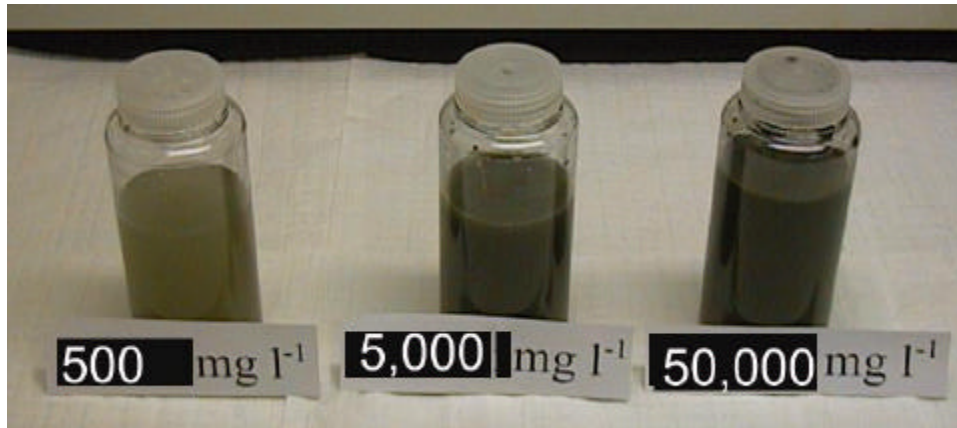

Figure 5-3. Photo of the Simplified Laboratory Runoff Procedure (SLRP) Apparatus

Predicted dissolved contaminant concentrations based on the results of the SLRP can be used with applicable WQS to determine if the discharge is in compliance with the standards after consideration of mixing. The mixing zone evaluation is made for the contaminant that would require the greatest dilution.

Detailed procedures for conducting the SLRP water quality prediction of runoff are provided in Appendix C.

#### 5.4.3 Tier III - Rainfall Simulator/Lysimeter System (RSLs)

The Tier III RSLs, shown in Figure 5-4, provides a quantitative evaluation of the effects of long-term drying and oxidation of dredged material on runoff water quality. The RSLs procedure uses a mechanical rainfall simulator that accurately simulates the kinetic energy and drop pattern distribution of natural rainfall. Wet dredged material is placed in a soil lysimeter and is then subjected to rainfall simulations at a standard rainfall intensity and duration. Runoff rates are determined and samples are collected during the runoff period for analysis of suspended solids, total and soluble COC. The lysimeter is then covered with a transparent, ventilated top and moved outside to allow natural drying and oxidation processes to occur. After 6 months of drying, the rainfall simulation is repeated on the oxidized material. Conditions of the RSLs procedure can be modified to site-specific conditions including precipitation intensity, duration, vegetative cover, physical disturbance, etc. to provide realistic, accurate assessments of potential water quality problems or effects of treatments or controls to improve water quality.

Detailed procedures for conducting the RSLs test and prediction of runoff quality are provided in Appendix C.

#### 5.4.4 RUNQUAL Computer-Assisted Analysis of Runoff Quality

The RUNQUAL application (Schroeder, Gibson, and Dardeau 1995) of the ADDAMS suite of computer programs (Schroeder and Palermo 2000) provides a computer program to assist in the analysis of runoff test data and the comparisons with WQS. The RUNQUAL application, along with documentation, can be downloaded from the USACE DOTS website at [www.wes.army.mil/el/dots](http://www.wes.army.mil/el/dots).



Figure 5-4. Photo of the Rainfall Simulator/Lysimeter System (RSLs)

#### 5.4.5 Tier III - Runoff Water Quality Decision

After consideration of the runoff Tier III water quality information based on SLRP or RSLs results, one of the following conclusions is reached (Figure 5-2):

1. Information is sufficient to reach a decision regarding water quality aspects of runoff. This is this case when WQS exist for all COC and are met for all COC after consideration of mixing. No further runoff evaluation is necessary.
2. Information is not sufficient to reach a decision. This may be the case when:
  - a. SLRP results indicate WQS are exceeded for one or more COC after consideration of mixing, and additional information using the RSLs test is desired; or
  - b. There are no applicable WQS for some COC; or
  - c. There is concern about interactive effects.

Conducting the RSLs, evaluation of toxicity of runoff, or management actions as an alternative to further evaluation should be considered. A decision to implement management actions for runoff, such as placement of surface covers or treatment, may require more detailed information for design of such actions. If management actions are selected, no further runoff evaluation is necessary.

In determining the potential level of concern regarding interactive effects, the number and classes of COCs that may be exceeded and the relative degree of exceedences should be considered. Interactive effects may be purely additive, synergistic (the resulting effect is greater than the sum of the effects from individual COCs), or antagonistic (the resulting effect is less than the sum of the effects from individual COCs). WQS were developed for single contaminants. Where several are present and are close to WQS, especially if they are the same class of contaminants (metals, chlorinated organics, metal-organic complexes, nonpolar organics, etc.), interactive effects may be of concern.

#### 5.4.6 Tier III - Runoff Toxicity Evaluation

Runoff should be evaluated for toxicity in Tier III if there are COC for which there are no WQS or if there is concern regarding potential interaction of multiple contaminants. Bioassays provide information on the toxicity of contaminants not included in the water quality standards, and indicate possible interactive effects of multiple contaminants. The Tier III runoff toxicity evaluation is based on use of simulated runoff samples from the SLRP or RSLs as a medium to conduct water column toxicity tests. Tier III toxicity testing assesses the potential toxicity of runoff to appropriate sensitive water column organisms. As with water quality evaluations of runoff, the results of the runoff toxicity tests should be interpreted considering the effects of mixing (Appendix E).

The evaluation determines the potential toxicity of the SLRP or RSL simulation of runoff from the proposed operation, considering the times and concentrations under which water-column organisms are potentially exposed to runoff in the field. The toxicity test medium is SLRP or RSL samples prepared to simulate the whole-water runoff (i.e., not filtered). Detailed guidance for preparing the runoff for use in toxicity tests is provided in Appendix C.

Procedures to evaluate runoff toxicity in the water column are conventional water column toxicity tests. The toxicity tests involve exposing test organisms to a dilution series containing both dissolved and suspended components of the simulated runoff prepared as described in Appendix C. The test organisms are added to the exposure chambers and exposed for a prescribed period (usually 96 h though some tests, e.g., bivalve larvae, may be run for shorter periods). The surviving organisms are examined at specified intervals and/or at the end of the test, and the concentration at which the simulated runoff produces an effect, if it does so, is determined. The results of the water column toxicity test are expressed in terms of the LC50 or EC50 expressed as a percentage of the original (i.e., 100 percent) runoff test medium concentration. This result is then compared with the concentration of the suspended dredged material at the boundary of the allowable mixing zone to determine the acceptability of the runoff discharge.

The detailed procedures for conducting the water column toxicity tests with the runoff described above are those provided for elutriate in the ITM (EPA/CE 1998).

#### **5.4.7 LAT-R Computer-Assisted Runoff Toxicity Evaluation**

The LAT-R application (Brandon, Schroeder, and Lee 1997) of the ADDAMS suite of computer programs (Schroeder and Palermo 2000) provides a computer program to assist in the analysis of runoff toxicity. The LAT-R application, along with documentation, can be downloaded from the USACE DOTS website at [www.wes.army.mil/el/dots](http://www.wes.army.mil/el/dots). Manual data analyses procedures for evaluation of water column toxicity are available in the ITM (EPA/CE 1998). These are applicable to water column toxicity tests for runoff and can be used, if desired.

#### **5.4.8 Tier III - Runoff Toxicity Decision**

After consideration of the runoff Tier III toxicity information, one of the following conclusions is reached (Figure 5-2):

1. Information is sufficient to reach a decision regarding toxicity aspects of runoff. This is the case when runoff toxicity poses no risk after consideration of mixing, and no further runoff evaluation is necessary.
2. Information is not sufficient to reach a decision regarding toxicity aspects of runoff. This is the case when simulated runoff indicates toxicity after consideration of mixing. Further evaluation of toxicity aspects of runoff under Tier IV, or management actions as an alternative to further

evaluation, should be considered. If management actions are selected, no further runoff evaluation is necessary.

## **5.5 Tier IV – Runoff Risk Assessment**

### **5.5.1 Tier IV Runoff Evaluation**

Tier IV is intended to answer whatever specific, well-defined technical questions may remain unanswered after thorough evaluation in earlier tiers. If earlier tiers are used properly, Tier IV should rarely be necessary.

By the nature of the tiered evaluation approach, any technical questions that remain unresolved after Tier III can best be answered by a detailed, case-specific evaluation. By their very nature, detailed case-specific evaluations are not amenable to the kind of generic guidance that can be presented in a national manual. They require individual design to address unique technical questions under site-specific conditions.

The best approach for Tier IV is usually a case-specific risk assessment. Detailed guidance for conducting risk assessments for CDFs in Tier IV can be found in Cura, Wickshire, and McArilde (in preparation). The information generated in Tiers I through III should be used to the maximum extent technically justified throughout the Tier IV risk assessment.

### **5.5.2 Tier IV Runoff Decision**

After consideration of the Tier IV evaluation results, all relevant information is available and no further evaluation is possible. One of the following conclusions is reached.

1. No management actions are required.
2. Management actions should be considered. A decision to implement management actions for runoff, such as placement of surface covers or treatment, may require more detailed information for design of such actions.

## **5.6 Runoff Management Actions**

If the evaluation indicates that runoff may be a concern after consideration of mixing, appropriate management actions may be considered. The runoff pathway may require management as long as the dredged material is exposed to precipitation. Management should take into consideration the short- and long-term physical and chemical changes to dredged material that occur as a result of drying and oxidation. Runoff management may include actions such as providing increased ponded area and depth to minimize runoff discharge, treatment or filtration of runoff to reduce the concentration of suspended solids and associated contaminants in the runoff,

treatment of runoff to remove dissolved contaminants, and vegetation management to increase infiltration and transpiration. Additional information on management actions and references for detailed guidance on implementation are found in Chapter 10 of this manual.

## 5.7 References and Bibliography

- Brandon, D. L, Schroeder, P. R., and Lee, C. R. (1997). "Computerization of the decision-making framework: Runoff toxicity bioassay test results (LAT-R Program)," Technical Note EEDP-04-28, U.S. Army Engineer Waterways Experiment Station, Vicksburg, MS.
- Cura, J., Wickwire, T., and McArilde, M. "Ecological and human health risk assessment guidance for terrestrial environments," DOER Technical Report in preparation, U.S. Army Engineer Research and Development Center, Vicksburg, MS.
- Environmental Protection Agency/U.S. Army Corps of Engineers. (1998). "Evaluation of dredged material proposed for discharge in waters of the U.S. – Testing manual," EPA-823-B-98-004, Office of Water (4305), Washington, DC.
- Headquarters, U.S. Army Corps of Engineers. (1987). "Confined disposal of dredged material," Engineer Manual 1110-2-5027, Washington, DC.
- Schroeder, P. R., Gibson, A. C., and Dardeau, E. A., Jr. (1995). "Documentation of the RUNQUAL module for ADDAMS: Comparison of predicted runoff quality with standards," Environmental Effects of Dredging Technical Note EEDP-06-19, U.S. Army Engineer Waterways Experiment Station, Vicksburg, MS.
- Schroeder, P. R., and Palermo, M. R. (2000). (Revision of 1990). "The automated dredging and disposal alternatives management system (ADDAMS)," Environmental Effects of Dredging Technical Note EEDP-06-12, U.S. Army Engineer Waterways Experiment Station, Vicksburg, MS.
- Schroeder, P. R., Lee, C. R., and Price, R. A. "Screening evaluations for confined disposal facility surface runoff quality," Environmental Effects of Dredging Technical Note (in preparation), U.S. Army Engineer Research and Development Center, Vicksburg, MS.
- U.S. Army Corps of Engineers/Environmental Protection Agency. (1992). "Evaluating environmental effects of dredged material management alternatives - A technical framework," EPA-842-B-92-008, Washington, DC.
- U.S. Environmental Protection Agency/U.S. Army Corps of Engineers. (1995). "QA/QC guidance for sampling and analysis of sediments, water, and tissues for dredged material evaluations - chemical evaluations," EPA-823-B-95-001, Washington, DC.

# 6 Leachate to Groundwater

---

## 6.1 General Considerations

Leachate is the water with associated dissolved and colloidal materials that seeps through dredged material in a CDF and subsequently through dikes or foundation material. Solid particles are not generally transported with the leachate and therefore the concerns for leachate quality are limited to the apparent dissolved (including fine colloidal fraction) concentrations of contaminant. The leachate pathway is perhaps the most technically complex to evaluate, yet it rarely is of environmental concern for contaminant migration because of the physical characteristics of most dredged materials, the nature of contamination, and the isolation characteristics common to most CDFs. Prudent site selection for the CDF will eliminate most concerns with leachate. For example, the CDF siting process (USEPA/USACE 1992) should eliminate sites near wells for potable water or over freshwater drinking water aquifers for CDFs intended for disposal of dredged materials from a saltwater environment.

This chapter addresses leachate to groundwater as the primary migration pathway for leachate. Water ponded over the dredged material that seeps through porous dike sections is considered effluent rather than leachate because it does not have the characteristics of passing through deposited dredged material. Leachate that passes through dredged material and directly enters surface waters is not generally a concern with regard to water column impacts, since the rate of flow of leachate is so low and the leachate would be mixed and diluted to background levels almost immediately. However, if this process is viewed as a concern for a specific site, the procedures for prediction of leachate quality in this chapter are applicable.

It is conceptually possible that leachate from a CDF may reach groundwater that may resurface and enter surface water bodies. However, this occurring with sufficient leachate concentration to be a concern is not a realistic possibility, and is not addressed in the UTM. The character of the leachate would not be expected to be significantly different from the effluent from the CDF. As such, if the effluent does not pose a problem, the leachate is not likely to pose a problem. If this process is viewed as a concern for a specific site, the procedures for prediction of leachate quality are applicable.

Leachate from dredged material placed in a CDF is produced by three potential sources: gravity drainage of the original pore water, inflow of

groundwater, and infiltration of precipitation. Immediately after dredging and disposal, dredged material is saturated (all voids are filled with water). As evaporation, consolidation, and seepage remove water from the voids, the amount of water stored and available for gravity drainage decreases. Thus, leachate generation and transport in a CDF depend on site-specific hydrology and geohydrology, engineering controls at the disposal site, dredged material hydraulic conductivity, initial water content, and nature of any contaminants in the dredged material. The potential leaching pathway and processes are shown in Figure 6-1.

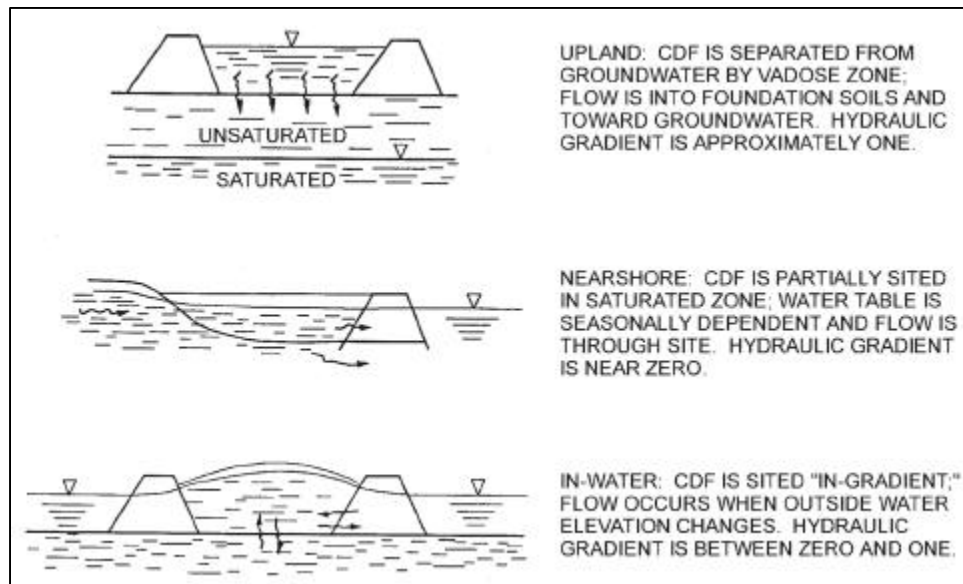

Figure 6-1. Illustration of potential CDF leachate pathways

If there is leachate from upland CDFs, it typically seeps through the vadose zone (soil above the water table) and/or the saturated groundwater zone where it can affect groundwater quality. Leachate from upland CDFs can also seep through the dikes to the surface of adjacent lands but this seepage typically evaporates or infiltrates and does not generally pose an environmental concern. If the site is situated so that groundwater will flow through the dredged material within the CDF (typically, a nearshore CDF), percolating groundwater may be the primary source of water through the material. If the CDF is a nearshore or island facility, surface water may be in contact with the dredged material as a result of fluctuating water levels and transport contaminants from the CDF in a process termed "tidal or wave flushing" (Schroeder 2000).

### 6.1.1 Leachate and Contaminant Transport Considerations

Contaminant migration via leachate seepage is a porous medium contaminant transport problem (Figure 6-2). Solid particles will not migrate with the leachate, but the contaminants in the aqueous phase are convected with pore water in the dredged material as leachate. As leachate is transported through the porous media of the vadose zone, the contaminant concentrations are reduced as the leachate passes through cleaner layers of dredged material, foundation soils, and fine-grained soils. This process is called attenuation. The contaminant concentration



of leachate exposed to a receptor (such as a well ) is further impacted by dispersion or mixing as the leachate is transported from the CDF locale to the receptor through the coarse-grained layers of an aquifer. In effect, the contaminant concentration in the leachate is diluted by the groundwater flow. Attenuation by adsorption to organic matter and interactions with fine-grained materials will also occur in the aquifer, but the effect is generally small as a result of low concentration of organic and clayey materials in the main regions of saturated groundwater flow.

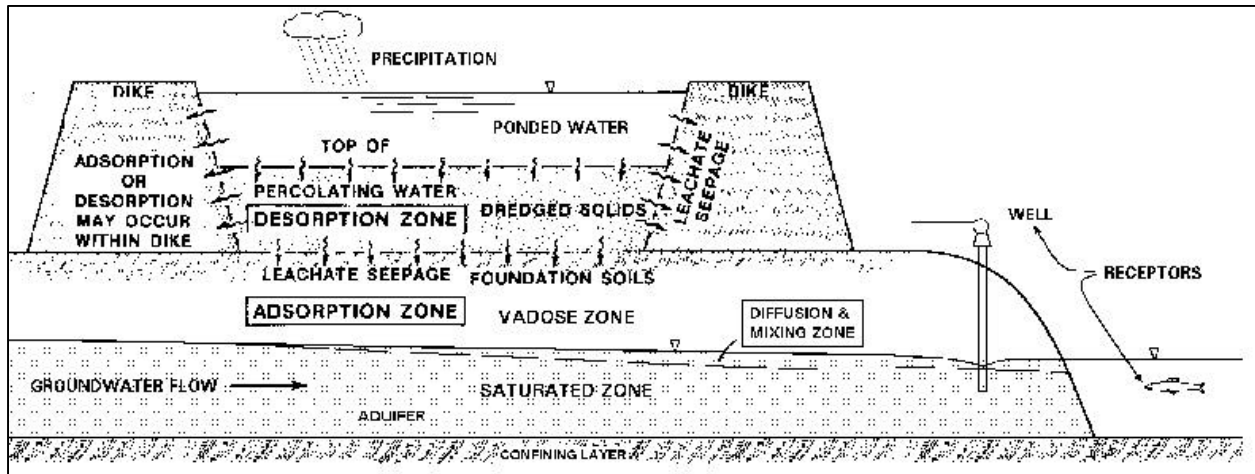

Figure 6-2. Illustration of the vadose zone, saturated groundwater flow zone, and leachate pathway to groundwater receptors

Leachate generation and transport depend on site-specific hydrology, engineering controls at the disposal site, dredged material hydraulic conductivity, initial water content, and nature of contaminants. Therefore, evaluation of potential leachate impacts will be greatly affected by the nature of the site and the engineering controls in place. Varying the engineering controls during the evaluation also allows selection of the optimum controls.

Two aspects of leachate generation from CDFs are of particular concern:

1. **Leachate contaminant concentrations.** If maximum leachate contaminant concentrations do not exceed applicable groundwater standards, this may be sufficient to indicate no need for leachate management actions. However, maximum leachate concentrations exceeding such standards, without consideration of leachate flow and dispersion, do not provide sufficient basis for a decision to implement leachate control measures.
2. **Leachate flow.** The flow of leachate from the CDF and its interaction with groundwater flow is the mechanism for migration to a receptor. The most significant effect of a CDF leachate management action is in the leachate mass flow. For example, mass flow through a 1-m lift of the same dredged material will be higher from a 2-ha site than from a 1-ha site with the same precipitation and climate. Leachate concentrations at

the site boundaries (interface between dredged material and the bottom of the CDF) will generally be similar regardless of the leachate management actions used.

Leachate flow in conjunction with leachate contaminant concentration determines the mass of contaminant that can potentially leave the site boundaries. Contaminant mass leaving the site boundaries is particularly important when comparing various leachate management actions such as depth of fill, drainage of surface water, collection, and treatment.

To determine leachate mass flow, site-specific factors affecting leachate generation must be considered. After dredging and disposal, dredged material is initially saturated (all voids are filled with water). As evaporation and seepage remove water from the voids, the amount of water stored and available for gravity drainage decreases. After some time, usually several years for conventional CDF designs, a quasi-equilibrium is reached in which water that seeps or evaporates is replenished by infiltration through the surface. The amount of water stored when a quasi-equilibrium is reached and the amount released before a quasi-equilibrium is reached depend primarily on local hydrology, dredged material properties, and facility design features. To predict time-varying leachate flow, all these factors must be considered.

Preproject estimation of leachate flow, therefore, requires coupled simulation of local weather patterns and hydrologic processes governing leachate generation. Important climatic variables include precipitation, temperature, wind, and humidity. Important hydrologic processes include infiltration, runoff, and evaporation. Important subsurface processes include evaporation from dredged material voids and flow in unsaturated and saturated zones. The Hydrologic Evaluation of Leachate Production and Quality (HELPO) model (Aziz and Schroeder 1999a and 1999b) can be used to simulate these processes for selected disposal scenarios.

### **6.1.2 Water Quality Standards for Leachate**

It is the position of the USACE that drinking water standards should be considered applicable in evaluation of potential leachate discharges only for CDFs constructed over freshwater aquifers with potential for use for drinking water. Drinking water standards should not be applied for evaluation of leachate from nearshore or island CDFs or upland CDFs constructed near or adjacent to shorelines with underlying brackish or saline aquifers. In such cases, comparison of potential leachate with applicable surface water standards would be more appropriate.

Section 230.10(c), CWA Guidelines, prohibits the discharge of dredged material that might cause significant adverse “effects on municipal water supplies,” and is a guiding principle when determining whether to perform leachate evaluations. Unless there are overriding navigation factors outlined in Section 404(b)(2), CWA, discharges of dredged material into CDFs should be avoided if leachate evaluations reveal the potential for impacts to municipal water

supplies. Chlorides should be considered as a COC for leachate whenever there is the potential for leachate from saline dredged material to enter a fresh water system.

### **6.1.3 Consideration of Attenuation**

The evaluation of leachate should consider the effects of attenuation, mixing, and dispersion in the dikes, foundation materials, and aquifer between the dredged material and the leachate receptors. The point of compliance for leachate in the groundwater is normally defined by the State regulatory agency.

### **6.1.4 Data Requirements**

Data requirements for prediction of leachate quality, summarized in Table 6-1, include those pertaining to:

1. Operational considerations (i.e., CDF site characteristics, site management and dredge characteristics). Data relating to operational considerations are usually determined by the disposal area design and by experience in dredging and disposal activities for the project under consideration or for similar projects.
2. Properties of the dredged material (i.e., contaminant release characteristics). Data relating to the dredged material characteristics should be obtained by sampling and testing the sediments to be dredged.
3. Foundation, dikes, and aquifer. Data relating to the foundation, dikes, and aquifer are usually determined by site investigation and are typically available from the site selection and design evaluation.
4. Climate. Climatic data are available from the U.S. National Weather Service.

<b>Table 6-1 Summary of Data Requirements for Prediction of the Quality of Leachate from Confined Dredged Material Disposal Areas</b>	
<b>Data Required</b>	<b>Source of Data</b>
Thickness of dredged material	Project information; site design
Thickness of dikes, vadose zone, and aquifer	Site design; site selection
Ponded area in disposal site	Project information; site design
Dredged material solids concentration	Project information; site design
Grain size distribution of dredged material	Project information
Grain size distribution of foundation soils, dike materials, and aquifer	Site selection; site design
Organic content of dredged material	Project information
Organic content of foundation soils, dike materials, and aquifer	Site selection; site design
Acid Volatile Sulfides (AVS) and salinity of dredged materials	Project information
Bulk sediment chemistry of dredged materials	Project information
Bulk chemistry of foundation soils	Site selection
Groundwater velocity	Site selection
Climate	NOAA
Partitioning coefficients of contaminant in dredged material and foundation soils	Leaching tests; literature

### 6.1.5 Disposal Area Design

When the quality of the leachate from a CDF is of concern, the design, operation, and management of the site should be carefully considered. This includes aspects relating to the design features, dewatering, and the disposal sequence of materials in the CDF. Procedures for such evaluations are presented in Engineer Manual 1110-2-2-5027 (HQUSACE 1987) and should be considered prior to the evaluation of the leachate for the project.

### 6.1.6 Summary of Tiered Evaluations for Leachate

A flowchart illustrating the tiered evaluation for leachate is shown in Figure 6-3. If a decision cannot be reached in Tier I, Tiers II and III provide evaluation methods and laboratory tests for evaluating potential leachate impacts. If a decision about leachate cannot be reached in Tiers I through III, a site-specific risk assessment is available in Tier IV.

The Tier II evaluation of leachate quality is a screening procedure based on solubility and partitioning. Attenuation and diffusion that will occur in the vadose and groundwater zones is considered. Conservative procedures (i.e., those that err on the side of environmental protection) are employed in Tier II to identify scenarios when testing or testing for some classes of contaminants would not be needed.

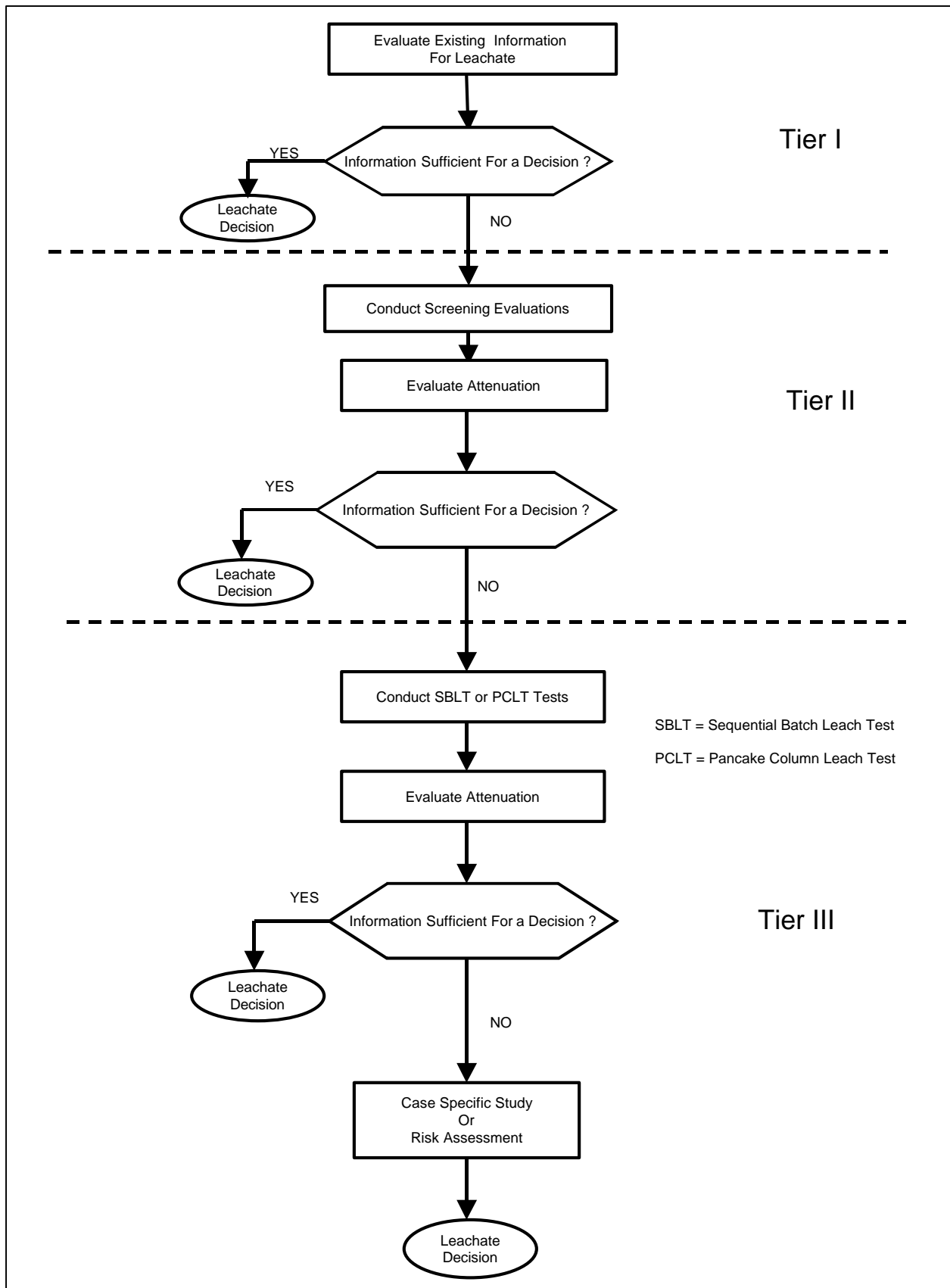

Figure 6-3. Flowchart illustrating tiered evaluation approach for the leachate pathway

Tier III provides site-specific laboratory testing and mathematical modeling approaches to evaluate leachate quality. Both batch and column leaching tests are available. Leachate testing considers concentrations of COC released from the dredged material and, after allowance for attenuation and diffusion in the existing materials in the CDF, dikes, foundation soils and aquifer, the predicted leachate quality (Myers, Brannon, and Tardy 1996; Brannon, Myers, and Tardy 1994). The predictive technique can be applied to evaluate the performance of existing sites and to design new sites. For existing sites, the technique can be used to characterize the leaching and adsorption of contaminants for the existing materials in the CDF.

## **6.2 Tier I Leachate Evaluation**

The Tier I evaluation for a proposed project (Chapter 3) will result in determination of the need for contaminant evaluations, identification of pathways of concern, identification of contaminants of concern, and decisions based on existing information.

It is important to consider prior evaluations of the leachate pathway in Tier I to determine if additional evaluations are needed. For example, if prior tests or evaluations are available, and project conditions and dredged material characteristics are unchanged, new evaluations would not be required.

After consideration of the Tier I leachate quality information, one of the following conclusions is reached for leachate:

1. Information is sufficient to reach a decision without further evaluation.
2. Information is not sufficient to reach a decision regarding leachate quality. Conduct Tier II evaluations.

## **6.3 Tier II Leachate Quality Evaluations**

If the Tier I evaluation indicates insufficient information for a leachate decision, the Tier II leachate quality screening evaluation is appropriate. The screening evaluation considers the bulk concentration of contaminants in the dredged material and mixing, diffusion, and attenuation in groundwater at the disposal site.

The Tier II leachate screen evaluates leachate quality based on bulk sediment data for the proposed dredged material. If adequate bulk sediment data are not available, samples should be collected and the bulk sediment chemistry should be determined. It is possible to skip the screens and go directly to the Tier III leachate test. However, this is not an efficient use of resources in most cases, since bulk sediment data are also needed for screening evaluations for the other pathways.

### 6.3.1 Tier II - Leachate Quality Screen

The Tier II leachate screening procedure is based on equilibrium partitioning principles and conservative (e.g., environmentally protective) application of design and operating variables for CDFs (Myers and Schroeder 2000). The evaluation makes use of site-specific data provided by the user and default values for pertinent variables to calculate a predicted leachate concentration of contaminants in groundwater.

A computerized spreadsheet program is available to perform all necessary calculations. The spreadsheet, along with documentation, can be downloaded as an ADDAMS module from the USACE DOTS web site at [www.wes.army.mil/el/dots](http://www.wes.army.mil/el/dots). If desired, equations for manual screening calculations are available (Myers and Schroeder 2000).

### 6.3.2 Tier II - Leachate Decision

After consideration of the Tier II leachate partitioning screen, one of the following conclusions is reached for leachate:

1. Information is sufficient to reach a decision. In this case either:
  - a. Standards applicable to the intended use of the groundwater (Section 6.1.1) exist for all COC and are met for all COC after consideration of attenuation. No further leachate evaluation is necessary.
  - b. Standards applicable to the intended use of the groundwater (Section 6.1.1) are exceeded for one or more COC after consideration of attenuation, and management actions should be considered. A decision to implement management actions for leachate, such as design modification or leachate collection, may require more detailed information prior to design of such actions. If management actions are selected, no further leachate evaluation is necessary.
2. Information is not sufficient to reach a decision, which includes cases where standards applicable to groundwater are exceeded for one or more COC after consideration of attenuation, and more detailed information is desired for a decision regarding the leachate pathway. Further evaluation in Tier III, or management actions as an alternative to further evaluation, should be considered. A decision to implement management actions for leachate, such as design modification or leachate collection, may require more detailed information prior to design of such actions. If management actions are selected, no further leachate evaluation is necessary.

## 6.4 Tier III - Leachate Quality Evaluations

Tier III leachate quality testing and modeling consist of a number of steps and procedures to gather more information on the effects of leachate and to reduce the uncertainty of the results. All of the steps or procedures may not be necessary to reach a decision. The testing options and procedures are a function of the sediment salinity, the possible presence of Non-Aqueous Phase Liquids (NAPLs), CDF site conditions, and the COC. The Tier III laboratory test results serve to

estimate dredged material-specific equilibrium distribution coefficients. These data establish a “source of strength” or concentration of COC in leachate potentially migrating from the CDF. The appropriate leachate test is either the Sequential Batch Leaching Test (SBLT), Figure 6-4, or the Pancake Column Leach Test (PCLT), Figure 6-5. The choice of which test to conduct is dependent on a number of factors. In general, the PCLT should be used for all saltwater sediments and sediments containing NAPLs. Either the SBLT or PCLT may be used for freshwater dredged materials. Since the SBLT test is a simpler procedure and is more cost and time effective than the PCLT, the SBLT test would normally be preferred for freshwater sediments. Appendix D contains more detailed discussions on selection of SBLT vs. PCLT and appropriate test conditions.



Figure 6-4. Photo of Sequential Batch Leachate Test setup



Figure 6-5. Photo of Pancake Column Leach Test setup



Evaluation of attenuation of contaminants in the foundation soils and estimation of groundwater flow are also an integral part of the Tier III leachate quality evaluations. Initial groundwater modeling using site data could improve the estimates of attenuation and diffusion in the vadose zone and groundwater between the CDF and the receptors. The SBLT and/or the PCLT provide better long-term estimates of the leachate source strength. Adsorption tests on the existing material in the CDF, on liner materials, on the foundation materials in the vadose zone, and on dike materials would provide better estimates of attenuation. Three-dimensional (3-D) groundwater and contaminant transport modelling could improve the prediction of contaminant concentrations at the point of compliance or exposed to the receptors as a function of time.

#### **6.4.1 Tier III - Sequential Batch Leachate Test (SBLT)**

The SBLT is recommended for leachate testing of freshwater sediments (Brannon, Myers, and Tardy 1994). However, major differences in leaching characteristics of freshwater and estuarine sediment make it difficult to predict leachate quality for estuarine sediments using the SBLT, and it should not be used for this purpose.

In the SBLT, sediment solids are challenged with successive aliquots of distilled-deionized water in an agitated system. After the aqueous and solid phases have reached steady-state, the phases are separated by centrifugation and filtration, and the leachate is analyzed for contaminants of concern. The solid phase is then reequilibrated with fresh distilled-deionized water, and the process of phase separation and leachate analysis is repeated. Each cycle in the test involves an equilibration step, a phase separation step, and a leachate analysis step. A table of solid phase and aqueous phase concentrations is developed from chemical analysis of the leachates, and these data are plotted to produce desorption isotherms.<sup>1</sup> From the desorption isotherms, contaminant-specific equilibrium distribution coefficients are obtained (Myers and Brannon 1991).

Leaching of freshwater dredged materials in the SBLT usually yields a classical desorption isotherm, but may also yield other types of partitioning coefficients described in Section 6.4.4 for the HELPQ program. The key feature of a classical desorption isotherm is a single-distribution coefficient that is constant throughout the sequential leaching procedure. The constancy of distribution coefficients during leaching of freshwater dredged materials is critical to the prediction of leachate quality in CDFs from sequential batch leach test data. Detailed guidance for conducting the SBLT is provided in Appendix D.

---

<sup>1</sup> An isotherm is the measured equilibrium sorption (particle or solids-associated concentration) as a function of the fluid phase concentration at a given temperature (Rieble 1999). Isotherm is a term commonly used in the environmental engineering literature and is derived from the fact that such relationships are developed under constant temperature.

### **6.4.2 Tier III - Pancake Column Leachate Testing (PCLT)**

A thin-layer, column leach test, called the PCLT, has been developed to simulate contaminant leaching in CDFs (Myers, Brannon, and Tardy 1996). This test is recommended for leachate testing of estuarine sediments that are dredged and disposed in CDFs for which the primary source of water for leaching is low in ionic strength (i.e., freshwater). Leaching of estuarine sediments and dredged materials with low-ionic strength water results in destabilization of the colloidal system as salt is washed out. Colloids and colloid-bound contaminants are released.

The PCLT test is a column leaching test conducted with a column configuration of 25 cm (10 in.) in diameter and 4.5 cm ( 1.77 in.) in height, a flat shape resembling a pancake. The PCLT column device can be constructed in any well equipped machine shop. The pancake design overcomes some of the shortcomings of conventionally shaped columns. This design minimizes wall effects by having a large column diameter-to-particle diameter ratio, minimizes run time for obtaining elution curves by having a short column length, and provides sufficient sample volume for chemical analysis since the flow-through area is large (Myers and Brannon 1991).

The PCLT serves as a laboratory-scale physical model of contaminant elution from dredged material that includes advection-dispersion, colloid release, and other mass transfer effects. Contaminated sediment is mixed, weighed, and loaded into the column leach apparatus. Deoxygenated, distilled-deionized water is introduced into the loaded column over an extended time interval. Water flow is controlled by a constant-volume pump. Leachate samples are collected at specified time intervals and are analyzed for COCs. The PCLT results take the form of an elution curve rather than an isotherm as for the SBLT. The elution curve is then analyzed with a dispersion-advection model to derive partitioning coefficients. For saline sediments, the results do not conform to a single coefficient.

Detailed guidance for conducting the PCLT is provided in Appendix D.

### **6.4.3 Tier III - SBLT or PCLT Adsorption or Challenge Testing**

Adsorption or challenge testing can be performed to examine the attenuation expected to occur when the leachate passes through cleaner materials and foundation soils. The adsorption or challenge tests are performed in an identical manner as the SBLT or PCLT with two exceptions:

1. Clean materials and foundation soils are used in the test instead of the dredged material.
2. Leachate and/or water spiked with higher concentrations of the COC are used as the leach test water.

The adsorption or challenge tests yield data on the adsorption of contaminants on clean materials and attenuation for use in contaminant transport modeling.

#### 6.4.4 Tier III - Groundwater Modeling

Leachate testing provides data regarding the water quality of leachate as it migrates from the dredged material at the bottom or sides of the CDF. Leachate pathway evaluations should also consider leachate attenuation, mixing, and dispersion to determine leachate impacts on a receptor. A variety of groundwater attenuation and/or mixing or dispersion models are available for this purpose. These include one-dimensional (1-D) models which simulate vertical migration and attenuation processes. There are also multidimensional models which may be used to simulate more complex groundwater flow conditions. Any validated groundwater model can be used to evaluate CDF leachate attenuation. The models presented below have been successfully applied to CDF leachate evaluations.

**HELPQ Model for CDF and Vadose Zone.** The HELPQ application (Aziz and Schroeder 1999a, b) of the ADDAMS suite of computer programs (Schroeder and Palermo 1995) provides a computer program to assist in evaluation of the fate of leachate as the leachate migrates from the dredged material to the receptors. HELPQ is the only available leachate attenuation model specifically developed for evaluation of the CDF leachate pathway.

The HELPQ program accepts data from the leachate tests (such as SBLT or PCLT) to predict leachate generation and attenuation. Leachate quality and quantity are predicted as a function of time and location in the vadose zone. The leachate quality can be compared with applicable water quality standards for leachate at the appropriate point of compliance. The HELPQ application, along with documentation, can be downloaded from the USACE DOTS web site at <http://www.wes.army.mil/el/dots>.

HELPQ has a quasi-two-dimensional (2-D) hydrologic water budget model that accounts for the effects of surface storage, runoff, infiltration, percolation, evapotranspiration, soil moisture storage, lateral drainage to leachate collection systems, and percolation through liners (Aziz and Schroeder 1999a, b). HELPQ can model cover soils, dredged material, liner systems, and foundation soils down to the saturated zone. Alternative scenarios can be selected and evaluated using the HELPQ model to estimate percolation rates and to compare management actions. Scenarios which may be evaluated include:

1. Land farming with different lift depths.
2. Different lift depths inside CDFs with no engineering controls other than routine operation and management for drainage of surface runoff.
3. Extensive CDF management with leachate collection system and a composite liner (Lee et al. 1992; Brannon, Myers, and Price 1992).

The HELPQ model is developed based on contaminant mass balance and utilizes the principle of conservation of mass as it applies to the sediment solids, the percolating fluid (leachate), and the contaminants dissolved in the fluid and associated with the sediment solids. The hydrologic modeling for contaminant

routing in the soil profile is composed of balancing the water budget at the ground surface and then routing the infiltrated water and the available contaminants throughout the soil profile. The Hydrologic Evaluation of Landfill Performance model (HELP) is used for surface water hydrology, infiltration, and drainage in the soil.

Since the HELP model was developed for evaluating landfill performance, it offers additional features that are useful in CDF design and performance evaluation. These features include the use of sand or gravel layers for lateral drainage or leachate collection and clay and synthetic materials as liners. To allow for flexibility in the design of confined disposal facilities, lateral drainage of leachate and barrier liners can also be used in HELPQ for preliminary design and CDF performance evaluation.

Contaminant routing in the soil profile relies heavily on the results of the subsurface water routing performed by the HELP model. Routing of contaminants begins after vertical drainage, lateral drainage, and soil moisture contents are computed. Except for lateral drainage layers, contaminants enter a layer from above and leave from below. In lateral drainage layers, contaminants may also leave the layer laterally to a drain, and hence out of the CDF, thus reducing the amount of contaminant entering the barrier soil liner and eventually contaminating the groundwater. Since the HELP model allows for evapotranspiration, contaminant mass may increase in the soil segments affected by this process; volatilization of contaminants is not modeled in HELPQ. When lateral drainage layers are used, lateral drainage occurs at the top of liner systems or barrier soils. Therefore, lateral drainage in the contaminant routing model is taken into consideration in the mass balance for contaminants at the bottom of lateral drainage layers. The net result is a decrease in the amount of contaminants that may percolate into the underlying barrier soil.

The HELPQ program requires partitioning coefficient data for the contaminants to be considered, initial concentrations of the contaminants in each soil layer, and the salinity (conductivity) in each layer if the dredged material is of estuarine origin. Equilibrium-partitioning data for pollutants that are typically present in dredged material are classified as one of the following types: a constant partitioning coefficient, a point  $K_d$ , a data-averaged  $K_d$ , a best fit  $K_d$ , or a salinity-dependent  $K_d$ . The partitioning data could be conservative values from the literature, past dredging projects, or testing. In addition, HELPQ requires the same data needed to run the HELP model such as weather data (precipitation, temperature, evapotranspiration) and soil and design data (soil properties, layer types, etc). The HELP model input requirements are explained in Schroeder et al. (1994a and 1994b).

The use of the water budget method for routing contaminants in CDFs provides an economic method for preliminary design and for evaluating the performance of various CDF design alternatives. The HELPQ model produces results that can be used by management and planning personnel for assessing the potential contamination of surrounding waters due to the construction of a CDF. Moreover, the use of lateral drainage layers and clay liners to control and restrict

the flow of contaminants provides valuable alternatives for design and operation of CDFs.

The HELPQ model predicts the concentration of contaminants in the CDF and vadose (unsaturated) zone below the CDF. Concentrations are predicted in the pore water and associated with the solid materials as a function of time. Additionally, the model predicts the leachate flow rate and contaminant mass flux.

**Saturated Zone Models.** Modeling contaminant transport beyond the vadose zone and to the receptor requires use of additional models such as the MULTIMED model, the Multimedia Environmental Pollutant Assessment System (MEPAS) (<http://mepas.pnl.gov:2080/>) or the Department of Defense Groundwater Modeling System (GMS) (<http://chl.wes.army.mil/software/gms/>). Similarly, for CDF sites where groundwater flows directly into the dredged material (such as nearshore CDFs), more complex modeling operations using the GMS may be needed to predict the movement and concentration of contaminants at the CDF boundaries. Flow of anaerobic leachate through oxic dikes is another complicated situation potentially requiring complex modeling to predict contaminant concentrations.

#### 6.4.5 Tier III Leachate Quality Decision

After consideration of the Tier III leachate quality information based on test data and modeling, one of the following conclusions is reached (Figure 6-2):

1. Information is sufficient to reach a decision. In this case either:
  - a. Standards applicable to the intended use of the groundwater (Section 6.1.1) exist for all COC and are met for all COC after consideration of attenuation. No further leachate evaluation is necessary.
  - b. Standards applicable to the intended use of the groundwater (Section 6.1.1) are exceeded for one or more COC after consideration of attenuation, and management actions should be considered.
2. Information is not sufficient to reach a decision, which includes cases where there are no standards applicable to the intended use of the groundwater (Section 6.1.1). The case-specific risk from leachate should be determined in Tier IV, or management actions as an alternative to further evaluation should be considered. A decision to implement management actions for leachate, such as design modification or leachate collection, may require more detailed information prior to design of such actions. If management actions are selected, no further leachate evaluation is necessary.

## **6.5 Tier IV - Leachate Risk Assessment**

### **6.5.1 Evaluation**

Tier IV is intended to answer whatever specific, well-defined technical questions may remain unanswered after thorough evaluation in earlier tiers. If earlier tiers are used properly, Tier IV should rarely be necessary.

By the nature of the tiered evaluation approach, any technical questions that remain unresolved after Tier III can best be answered by a detailed, case-specific evaluation. By their very nature, detailed case-specific evaluations are not amenable to the kind of generic guidance that can be presented in a national manual. They require individual design to address unique technical questions under site-specific conditions.

The best approach for Tier IV is usually a case-specific risk assessment. Detailed guidance for conducting risk assessments for CDFs in Tier IV can be found in Cura, Wickwire, and McArde (in preparation). The information generated in Tiers I through III should be used to the maximum extent technically justified throughout the Tier IV risk assessment.

### **6.5.2 Tier IV Leachate Decision**

After consideration of the Tier IV leachate evaluation results, all relevant information is available and no further evaluation is possible. One of the following conclusions is reached.

1. No management actions are required.
2. Management actions should be considered. A decision to implement management actions for leachate, such as lining or operational modification, may require more detailed information prior to design of such actions.

## **6.6 Leachate Management Actions**

If evaluation of the leachate pathway indicates leachate is of concern after consideration of attenuation, appropriate actions to manage leachate may be considered. These may include modification of the operation (e.g., encapsulating the contaminated dredged material between cleaner layers of materials), liners and leachate collection systems, and low permeability cover systems, among other approaches. Additional information on management actions and references for detailed guidance on such actions is found in Chapter 10 of this manual.

## 6.7 References and Bibliography

- American Society for Testing and Materials. (1999). "Standard specification for reagent water," D1193-99, West Conshohocken, PA.
- Aziz, N. M., and Schroeder, P. R. (1999a). "Documentation of the hydrologic evaluation of leachate production and quality (HELPQ) module," Dredging Research Technical Note EEDP-06-20, U.S. Army Engineer Waterways Experiment Station, Vicksburg, MS.
- \_\_\_\_\_. (1999b). "ADDAMS Application: Hydrologic evaluation of leachate production and quality (HELPQ) module in CDFs," Dredging Research Technical Note EEDP-06-21, U.S. Army Engineer Waterways Experiment Station, Vicksburg, MS.
- Bahr, J. M., and Rubin, J. (1987). "Direct comparison of kinetic and local equilibrium formulations for solute transport affected by surface reactions," *Water Resources Research* 23 (3), 438-452.
- Brandon, D. L., Schroeder, P. R., and Lee, C. R. (1997). "Computerization of the decision-making framework: Effluent toxicity bioassay test results (LAT-E Program)," Dredging Research Technical Note EEDP-04-27, U.S. Army Engineer Waterways Experiment Station, Vicksburg, Miss.
- Brannon, J. M., Myers, T. E., Gunnison, D., and Price, C. B. (1991). "Non-constant PCB partitioning in New Bedford Harbor sediment during sequential batch leaching," *Environmental Science and Technology* 45 (6), 1082-1087.
- Brannon, J. M., Myers, T. E., and Price, C. B. (1990). "Factors affecting the behavior of metals in leachate," Environmental Effects of Dredging Technical Notes EEDP-02-13, U.S. Army Engineer Waterways Experiment Station, Vicksburg, MS.
- Brannon, J. M., Myers, T. E., and Price, C. B. (1992). "Leachate testing of Hamlet City Lake, North Carolina, sediment," Miscellaneous Paper D-92-5, U.S. Army Engineer Waterways Experiment Station, Vicksburg, MS.
- Brannon, J. M., Myers, T. E., and Tardy, B. A. (1994). "Leachate testing and evaluation for freshwater sediments," Miscellaneous Paper D-94-1, U.S. Army Engineer Waterways Experiment Station, Vicksburg, MS.
- Brannon, J. M., Pennington, J. C., Myers, T. E., and Price, C. B. (1989). "Factors affecting leachate quality," Environmental Effects of Dredging Technical Notes EEDP-02-11, U.S. Army Engineer Waterways Experiment Station, Vicksburg, MS.
- Cura, J., Wickwire, T., and McArlde, M. "Ecological and human health risk assessment guidance for terrestrial environments," DOER Technical Report (in preparation), U.S. Army Engineer Research and Development Center, Vicksburg, MS.

- Environmental Modeling Research Laboratory. (1999). Department of Defense groundwater modeling system v3.0 Reference Manual, Brigham Young University, Provo, UT.
- Headquarters, U.S. Army Corps of Engineers. (1987). "Confined disposal material," Engineer Manual 1110-2-5027, Washington, DC.
- Hill, D. O., Myers, T. E., and Brannon, J. M. (1988). "Development and application of techniques for predicting leachate quality in confined disposal facilities; background and theory," Miscellaneous Paper D-88-1, U.S. Army Engineer Waterways Experiment Station, Vicksburg, MS.
- Jennings, A. A., and Kirkner, J. J. (1984). "Instantaneous equilibrium approximation analysis," *Journal of Hydraulic Engineering* 110 (12), 1700-1717.
- Lee, C. R., Tatum, H. E., Simmers, J. W., Skogerboe, J. G., Folsom, B. L., Jr., Price, R. A., Brannon, J. M., Brandon, D. L., Price, C. L., Averett, D. E., and Palermo, M. R. (1992). "Evaluation of upland disposal of Oakland Harbor, California, sediment. Volume 1: Turning basin sediments," Miscellaneous Paper EL-92-12, U.S. Army Engineer Waterways Experiment Station, Vicksburg, MS.
- Myers, T. E., and Brannon, J. M. (1991). "Technical considerations for application of leach tests to sediments and dredged material," Environmental Effects of Dredging Technical Notes EEDP-02-15, U.S. Army Engineer Waterways Experiment Station, Vicksburg, MS.
- Myers, T. E., Brannon, J. M., and Tardy, B. A. (1996). "Leachate testing and evaluation for estuarine sediments," Technical Report D-96-1, U.S. Army Engineer Waterways Experiment Station, Vicksburg, MS.
- Myers, T. E., and Schroeder, P. R. "Screening evaluations for confined disposal facility leachate quality," Environmental Effects of Dredging Technical Note (in preparation), U.S. Army Engineer Research and Development Center, Vicksburg, MS.
- Reible, D. (1999). *Fundamentals of Environmental Engineering*. Lewis Publishers, Washington, DC.
- Schroeder, P. R. (2000). "Leachate screening considerations," DOER Technical Notes Collection, ERDC TN-DOER-C16, U.S. Army Engineer Research and Development Center, Vicksburg, MS, [www.wes.army.mil/el/dots/doer](http://www.wes.army.mil/el/dots/doer).
- Schroeder, P. R., Aziz, N. M., Lloyd, C. M., and Zappi, P. A. (1994a). "The hydrologic evaluation of landfill performance (HELP) model: User's guide for version 3," EPA/600/R-94/168a, U.S. Environmental Protection Agency Office of Research and Development, Washington, DC.
- Schroeder, P. R., Dozier, T. S., Zappi, P. A., McEnroe, B. M., Sjostrom, J. W., and Peyton, R. L. (1994b). "The hydrologic evaluation of landfill performance (HELP) model: Engineering documentation for version 3," EPA/600/R-



94/168b, U.S. Environmental Protection Agency, Office of Research and Development, Washington, DC.

- Schroeder, P. R., and Palermo, M. R. (1995). "The Automated Dredging and Disposal Alternatives Management System (ADDAMS)," Environmental Effects of Dredging Technical Note EEDP-06-12, U.S. Army Engineer Waterways Experiment Station, Vicksburg, MS.
- Streile, G. P., Shields, K. D., Stroh, J. L., Bagaasen, L. M., Whelan, G., McDonald, J. P., Droppo, J. G., and Buck, J. W. (1996). "Multimedia environmental pollutant assessment system (MEPAS): Source term formulations," PNL-11248, Pacific Northwest National Laboratory, Richland, WA.
- Stumm, W., and Morgan, J. J. (1981). *Aquatic Chemistry*, Wiley, New York.
- U.S. Environmental Protection Agency/U.S. Army Corps of Engineers. (1992). "Evaluating environmental effects of dredged material management alternatives - A technical framework," EPA-842-B-92-008, Washington, DC.
- U.S. Environmental Protection Agency/U.S. Army Corps of Engineers. (1995). "QA/QC guidance for sampling and analysis of sediments, water, and tissues for dredged material evaluations - chemical evaluations," EPA-823-B-95-001, Washington, DC.
- Valocchi, A. J. (1985). "Validity of the local equilibrium assumption for modeling sorbing solute transport through homogenous soils," *Water Resources Research* 21 (6), 808-820.

# 7 Guidance for Evaluation of Volatile Emissions

---

## 7.1 General Considerations

Volatilization is the movement of a chemical into the air from a liquid surface. Volatilization from dredged material solids, even those that appear “dry,” involves desorption through a water film covering the solids and then from the water to the air. Two major conditions for possible volatile losses from dredged material in CDFs are volatilization from exposed dredged material and volatilization from dredged material submerged under ponded water. The objective of evaluating volatile emissions from dredged material is to determine the potential releases of volatile and semivolatile contaminants from sediment to the atmosphere following disposal of dredged material. Volatile emissions assessments may be necessary if the Tier I evaluation (Chapter 3) indicates the dredged material may contain contaminants that could result in air quality concerns in and around the CDF from the perspective of human exposure. The volatilization pathway will be of concern only for sediments with comparatively high concentrations of volatile organic contaminants.

### 7.1.1 Volatilization Processes

Disposal and storage operations associated with dredged material disposal in CDFs can increase the opportunity for volatile organic compound (VOC) emissions. Sediment physical characteristics, such as aging, porosity, moisture content, and percent oil and grease can play a significant role in controlling volatile emissions from sediments. Contaminant chemical properties such as Henry’s Law Constant and vapor pressure are also very important in determining contaminant flux to air. Environmental variables such as relative air humidity and temperature can also play a part in contributing to volatile losses. Volatile emissions pathways from CDFs can include releases from plant-covered dredged material, exposed dredged materials, ponded water, and from effluent released from the CDF.

The highest volatile contaminant transfer condition is in the first few hours after the surface of the dredged material is exposed, i.e., just after a pond is removed (USEPA 1996). After initial drying of the surface occurs, the rate of volatile contaminant transfer is reduced to levels less than that for a ponded

condition. Since ponded conditions can remain over dredged material in a CDF for considerable periods, the ponded condition is likely the most critical for most sites.

Because chemicals must enter the water phase before they can volatilize from dredged material, the tendency of a chemical to volatilize from dredged material can be generally related to the Henry's constant. Henry's constant is the equilibrium distribution of a volatile chemical between air and water if true equilibrium solutions exist in both phases (Thibodeaux 1979). Henry's constant and, therefore, volatilization tendency depend on aqueous solubility, vapor pressure, and molecular weight. Chemicals with high Henry's constant will tend to volatilize while chemicals with low Henry's constant will tend to dissolve in water. Henry's constant is directly proportional to vapor pressure and inversely proportional to aqueous solubility. The actual direction of chemical movement across the air-water interface depends on chemical concentrations in aqueous and air phases and Henry's constant. The transfer rate (desorption for transfer to water and volatilization for transfer to air) depends on wind-induced turbulence at the air-water interface.

Contaminant transport from *in situ* dredged material to air is a relatively slow process because most contaminants should first be released to the water phase prior to reaching the air. Thibodeaux (1989) discusses volatilization of organic chemicals during dredging and disposal and identifies four locales or conditions in which volatilization may occur:

1. Dredging site, disposal site, and other water areas where suspended solids are elevated, usually during active operations.
2. Quiescent, ponded CDF with a low-suspended solids concentration after disposal is completed and prior to dewatering.
3. Dredged material exposed directly to air during transport and disposal and during dewatering after disposal is completed.
4. Dredged material covered with vegetation and crust.

Figure 7.1 illustrates these conditions. Conditions 1 and 3 above are of the most concern for volatilization in CDFs, and, therefore, the volatile loss analyses presented in this manual are limited to the conditions of ponded water overlying dredged material and exposed dredged material solids (USEPA 1996).

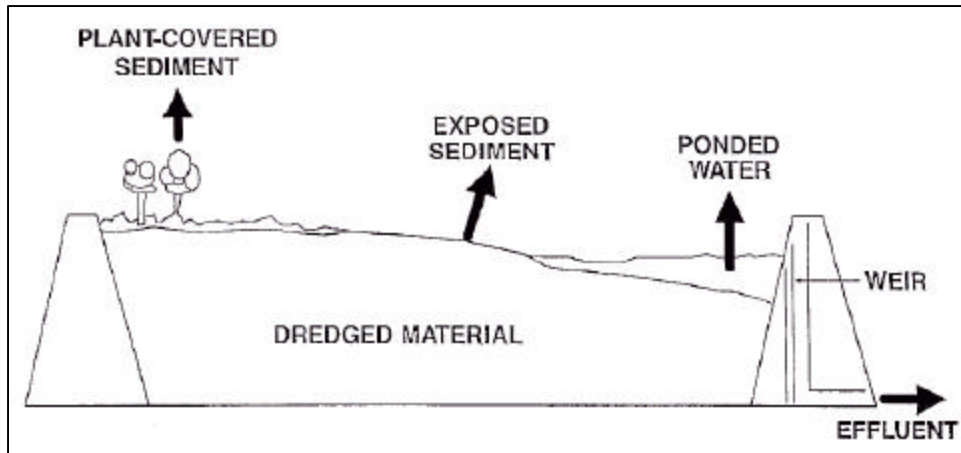

Figure 7-1. Illustration of locales or conditions for volatile emissions from CDFs

### 7.1.2 Condition 1 - Submerged Dredged Material

Dredged material slurries pumped to primary settling facilities or CDFs undergo sedimentation, resulting in a thickened deposit of settled material overlain by ponded water containing varying concentrations of suspended solids. Thus, the submerged dredged material condition is characterized by water containing contaminated suspended solids and a thickened bottom deposit of dredged material. The volatilization pathway in this case involves desorption from the contaminated suspended solids followed by transport through the air-water interface.

The deposited dredged material is not part of the pathway because suspended solids control dissolved contaminant concentrations, and it is the dissolved chemicals that volatilize. While deposited dredged material can contribute to dissolved contaminant concentrations, the contribution from deposited material is not important until the suspended solids concentration becomes negligible. In a primary settling facility, there is a continuous flux of suspended solids through the water column while dredged material is being disposed. Diffusion from bottom deposits is, therefore, unimportant relative to desorption from suspended solids in controlling dissolved contaminant concentrations in primary settling facilities.

### 7.1.3 Condition 3 - Exposed Dredged Material

This volatilization condition is characterized by dredged material that is exposed directly to air and void of vegetation or other cover. Exposed dredged material is probably the largest of the four volatilization conditions as a source of volatile emissions (Thibodeaux 1989). Dredged material begins evaporative drying and volatile chemical emission as soon as it is exposed to air. Initially, gas-side resistance affects the chemical emission rate. The top microlayer quickly becomes depleted of volatile chemicals (and water); so that, continuing losses of volatile chemicals come from the pore spaces within the dredged material. At this point, the emission process is transient and changes from being gas-side resistance controlled to dredged material-side vapor diffusion controlled. Exposed dredged

material will be a source of volatile emissions during various stages of CDF operation and flow equalization as follows:

- a. Delta formed during primary settling of dredged material slurries.
- b. Dredged material in filled primary settling facilities after ponded water is drawn off.
- c. Delta formed during mechanical disposal of dredged material in in-water or nearshore flow equalization facilities.
- d. Dredged material in upland flow equalization facilities for mechanically dredged material.

The rate at which chemicals volatilize from exposed dredged material is affected by many factors. Geotechnical properties such as porosity and water content, chemical factors such as water and air diffusivities, and environmental factors such as wind speed and relative humidity all affect volatilization rates. In addition, processes such as air-water-solids chemical partitioning, diffusion of thermal energy, evaporation of water, and desiccation cracking of the dredged material can have pronounced impacts on volatile emission rates for exposed sediment.

#### **7.1.4 Regulatory Considerations**

As dredged material is placed in the CDF, volatiles may escape through the air/water interface, and volatiles may escape from dredged material as the drying dredged material is exposed to the air. However, there are no known instances where volatiles from CDFs have posed a potential release sufficient to trigger the regulatory application of the Clean Air Act (CAA). Importantly, the CAA regulates emissions from a point source (stack), and the CAA regulates only a few parameters such as particulates and carbon dioxide. Neither of these scenarios apply to CDFs. Nevertheless, there are occasions where workers might be exposed to volatile emissions while undertaking management actions at the CDF such as dike rehabilitation using dredged material from the CDF, dewatering using specialized equipment or trenching equipment to dewater the dredged material.

This chapter on emissions is designed to ensure that worker safety measures are properly undertaken to meet standards of exposure established by the Occupational Safety and Health Administration (OSHA). The approach for evaluation of the volatile pathway involves prediction of a flux rate of contaminants to air and calculation of the concentration of contaminants in air (mass/cubic meter), considering dispersion because of atmospheric processes such as wind. The receptor of concern for volatile emissions is humans working on site or humans adjacent to the CDF. The predicted air quality or exposure concentration data can be compared with OSHA standards. The dispersion models provided consider dispersion occurring at a height of 1.8 m (6 ft) above the dredged material surface or adjacent ground surface.

### 7.1.5 Data Requirements

Data requirements for volatile emissions evaluations include those variables specific to the proposed CDF operation. The predictive equations and models used to evaluate volatilization require many assumptions, site variables, operating variables, and chemical properties. The information used in volatile evaluations should be specific to the proposed CDF and disposal operation. Project specific information such as CDF size, area of each deposit event, exposure, wind speed, temperature, and physical and chemical characteristics of the dredged material are required for evaluating air quality as a result of volatilization. A summary of the data requirements for volatile emissions predictions is given in Table 7-1.

<b>Table 7-1 Variables for Volatile Emissions Evaluation</b>
1. Total area of CDF
2. Available area for each deposit event
3. Disposal frequency
4. Daily worker exposure period to exposed material
5. Daily worker exposure period to ponded material
6. Air exchange control volume
7. Bulk density of dredged material
8. Contaminant concentration in pore water
9. Contaminant concentration in ponded water
10. Wind-driven currents in ponded water (assumed to be 3% of wind speed)
11. Wind speed and direction
12. Fetch length
13. Average weight of worker
14. Minute ventilation
15. Molecular wt. of air
16. Molar volume of air
17. Universal gas constant
18. Contaminant diffusivity in water
19. Atmospheric pressure
20. Temperature
21. Total porosity of dredged material
22. Air-filled porosity of drying material
23. Partitioning coefficient
24. Henry's Law constant of contaminant
25. Vapor pressure of contaminant
26. Molecular weight of contaminant
27. Solubility of contaminant
28. Water depth
29. Receptors
30. Receptors location

### 7.1.6 Summary of Tiered Evaluations for Volatile Emissions

A flowchart illustrating the tiered evaluation for volatilization is shown in Figure 7-2. If a decision regarding volatile emissions cannot be reached based on the evaluation of existing information in Tier I, Tier II provides a method for volatile emissions screening based on conservative assumptions. Tier III consists of a laboratory test for prediction of volatile flux rate from exposed sediment. Both the Tier II and Tier III evaluations consider dispersion of the volatile emissions at the CDF as a part of the evaluation. The evaluations in Tiers II and III will be sufficient for evaluation of volatile emissions in the vast majority of cases. As with all pathways, Tier IV evaluations involve consideration of volatilization within the framework of a risk assessment.

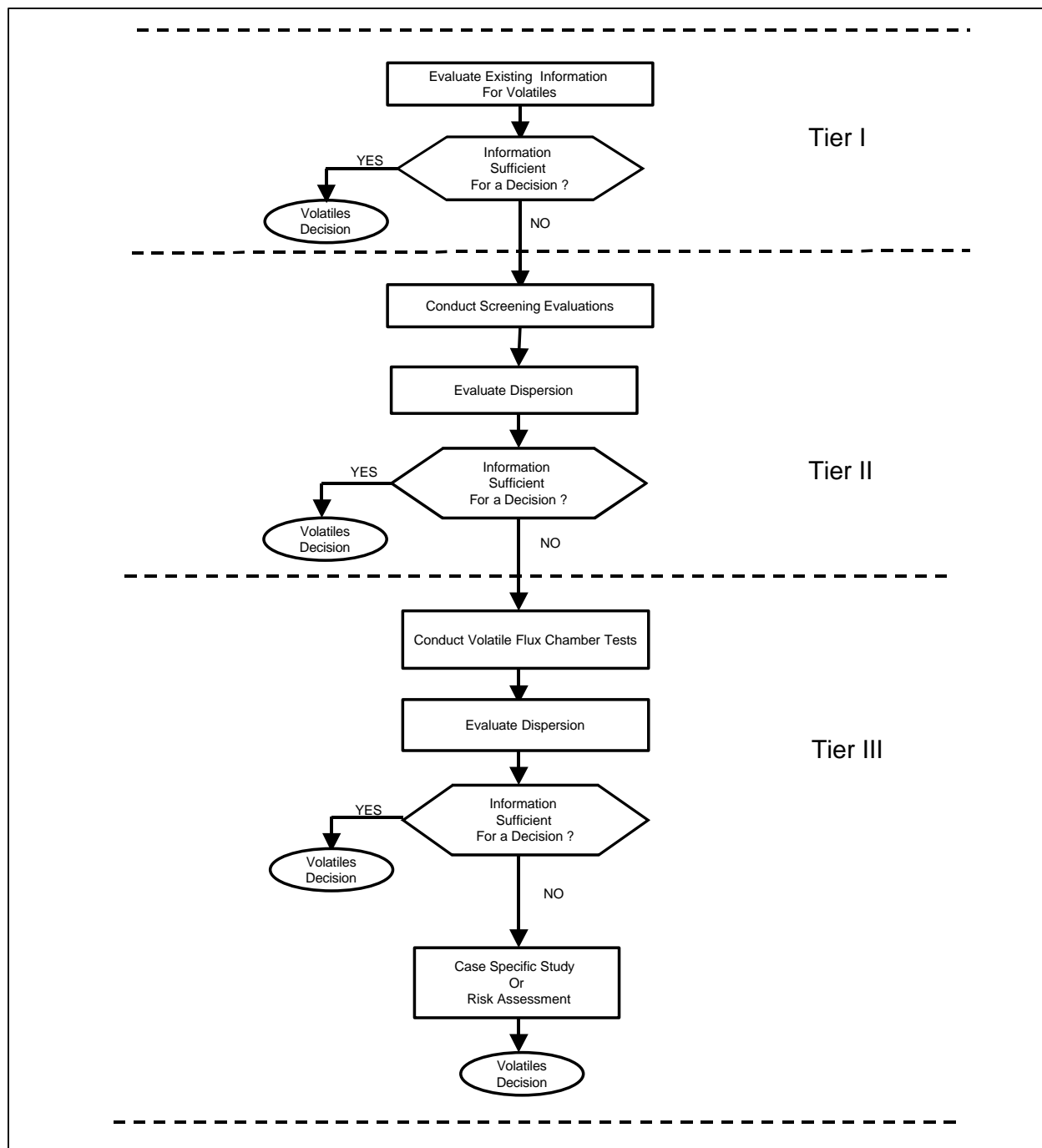

Figure 7-2. Flowchart illustrating tiered approach for evaluation of the volatile pathway

### 7.1.7 OSHA Air Quality Standards

When volatile emissions are determined by a Tier I evaluation to be of concern, Tier II screen and Tier III evaluations are performed, and predicted emission concentrations are compared to OSHA standards to determine compliance. Table 7-2 provides the current OSHA standards (29 CFR) for air contaminants.

<b>Table 7-2 OSHA Regulations (Standards – 29 CFR) Limits for Air Contaminants</b>		
<b>Compound</b>	<b>TWA, ppm<sup>a</sup></b>	<b>mg/m<sup>3</sup><sup>b</sup></b>
<b>Metals</b>		
Aluminum		15 dust, 5 respirable
Antimony		0.50
Arsenic	See 29 CFR 1990.103 <sup>c</sup>	
Beryllium		0.002, 0.005, 0.025 (30-minute maximum peak)
Cadmium		0.005
Chromium (hexavalent)		0.50
Copper		0.10 fume, 1.0 dust mist
Lead		0.05
Mercury		2.0
Nickel (soluble)		1.0
Phosphorus		0.10
Selenium		0.20
Silver (soluble)		0.01
Thallium (soluble)		0.10
<b>Polyaromatic Hydrocarbons (PAHs)</b>		
Benzo(a)Pyrene		0.20 (as coal tar pitch volatiles) <sup>d</sup>
Chrysene		0.20 (as coal tar pitch volatiles)
Naphthalene	10	50
<b>Organophosphorus Pesticides</b>		
Azinphos Methyl		0.20
Demeton, Total		0.10
Malathion (total dust)		15.0
<b>Chlorinated Pesticides</b>		
DDT		1.00
Aldrin		0.25
Chlordane		0.50
Dieldrin		0.25
Endrin		0.10
Lindane		0.50
Heptachlor		0.50
Methoxychlor (total dust)		15.0
Toxaphene		0.50
<b>Semivolatile Organic Compounds</b>		
1,3-Dichlorobenzene	© 50	© 300
1,4-Dichlorobenzene	75	450
3,3'-Dichlorobenzidine	See 29 CFR 1910.1003-1016 <sup>e</sup>	
Di-N-Butyl Phthalate		5.0
Di-N-Octyl Phthalate		5.0
Hexachloroethane	1.0	10.0
Isophorone	25	140

(Continued)



<b>Table 7-2 (Concluded)</b>		
<b>N-Nitrosodimethylamine</b>		
Nitrobenzene	1.0	5.0
Pentachlorophenol		0.50
Phenol	5.0	19
<b>PCBs</b>		
Chlorodiphenyl (42%) Arochlor 1242		1.0
Chlorodiphenyl (54%) Arochlor 1254		0.50
<sup>a</sup> TWA refers to 8 hour time weighted average in parts of vapor per million parts of contaminated air by volume at 25 degrees C and 760 torr. <sup>b</sup> Milligrams of substance per cubic meter of air. When entry is in this column only, the value is exact; when listed with a ppm entry, it is approximate. <sup>c</sup> Reference 29 CFR 1990.103. Identified as a possible occupational carcinogen. Further recommended by the National Institute for Occupational Safety and Health (NIOSH) that occupational exposure to contaminant be limited to lowest feasible concentration. <sup>d</sup> Benzene – soluble fraction, Anthracene, BaP, Phenanthrene, acridine, chrysene, pyrene. <sup>e</sup> Included in the thirteen OSHA-regulated carcinogens. Exposures of workers to these 13 chemicals are to be controlled through the required use of engineering controls, work practices, and personal protective equipment, including respirators.		

## 7.2 Tier 1 – Initial Evaluation of Volatile Emissions

The Tier I evaluation for a proposed project (Chapter 3) will result in determination of the need for contaminant evaluations, identification of pathways of concern, identification of contaminants of concern, and decisions based on existing information.

It is important to consider prior evaluations of the volatilization pathway in Tier I to determine if additional evaluations are needed. If prior tests or evaluations are available, and project conditions and dredged material characteristics are unchanged, new evaluations would not be required.

After consideration of Tier I volatilization information, one of the following conclusions is reached for volatile emissions (Figure 7-1).

1. Information is sufficient to reach a decision without further evaluation.
2. Information is not sufficient to reach a decision regarding volatile emissions. Conduct Tier II and/or Tier III evaluations.

## 7.3 Tier II – Volatile Emissions Screen

Tier II provides a screening tool, which gives a conservative estimate of volatilization from a submerged sediment and an exposed sediment scenario based on partitioning from bulk sediment. The screen relies on bulk sediment data, site conditions, and applicable OSHA exposure standards. If adequate bulk sediment data are not available, samples should be collected and bulk sediment chemistry should be determined. It is possible to skip the screen and go directly to the Tier III laboratory test that quantifies emission from exposed sediment. However, this is not an efficient use of resources in most cases, since bulk sediment data are also needed for screening evaluations for other pathways.

### 7.3.1 Tier II – Volatilization Screen

The volatilization screen utilizes an electronic spreadsheet for the calculations and considers the bulk concentration of contaminants in the dredged material and variables specific to the proposed CDF operation (Table 7-1). Necessary data include both site and operating conditions and COC chemical properties. Chemical partitioning assumptions are used to give conservative estimates of the maximum COC air concentrations and fluxes on- and off-site under both submerged and exposed dredged material conditions. Project specific information such as CDF size, area of each disposal event, exposure, wind speed, temperature and physical and chemical characteristics of the dredged material are required for the Tier II evaluation. Site-specific values for these variables are entered into the appropriate cells of the spreadsheet and output provides information on predicted contaminant fluxes. The results can be compared to OSHA standards. The spreadsheet, along with documentation, can be downloaded as an ADDAMS module from the USACE DOTS website at [www.wes.army.mil/el/dots](http://www.wes.army.mil/el/dots). If desired, equations for manual screening calculations are also available (Myers in preparation).

The volatilization calculations in the spreadsheet yield COC concentrations at the interface surface between air and the ponded water or the dredged material in the CDF. Thus, they are somewhat analogous to effluent concentrations at the point of release, before mixing is considered. A screening model for evaluation of dispersion is therefore included in the Tier II spreadsheet calculations for volatiles (Section 7.5).

### 7.3.2 Tier II - Volatile Emissions Decision

After consideration of the Tier II volatile emissions screen and dispersion information, one of the following conclusions is reached for volatile emissions (Figure 7-2):

1. Information is sufficient to reach a decision regarding volatile emissions. In this case either:
  - a. Volatile emissions, after consideration of dispersion, are below applicable OSHA standards. No further emissions evaluation is necessary.
  - b. Volatile emissions, after consideration of dispersion, exceed applicable OSHA standards, and management actions should be considered. A decision to implement management actions for emissions, such as a surface cove or treatment, may require more detailed information prior to design of such actions. If management actions are selected, no further emissions evaluation is necessary.
2. Information is not sufficient to reach a decision regarding volatile emissions. Further evaluation in Tier III, or management actions as an alternative to further evaluation, should be considered. A decision to implement management actions for emissions, such as capping or

treatment, may require more detailed information prior to design of such actions. If management actions are selected, no further emissions evaluation is necessary.

## 7.4 Tier III –Volatile Flux Chamber Test

### 7.4.1 Volatile Emissions Laboratory Test Procedure – Volatile Flux Chamber (VFC)

A volatile flux chamber (VFC) test is available for Tier III evaluations of volatile emissions from exposed sediment. Actual volatile contaminant measurements may be needed in order to determine emissions under a variety of site environmental and operational conditions for which the Tier II volatile screens and models are not designed. The procedure involves loading dredged material into a laboratory “flux chamber” and sampling air that has been passed over the dredged material surface. A photo of the flux chamber is shown in Figure 7.3. This procedure can be used to evaluate CDF operating scenarios, such as crust management, for which the available models and predictive equations are not designed.

The influence of dispersion as described in Section 7.5 on contaminant concentrations should be considered in the Tier III evaluation of volatile emissions.

Detailed procedures for conducting the VFC test are provided in Appendix F.

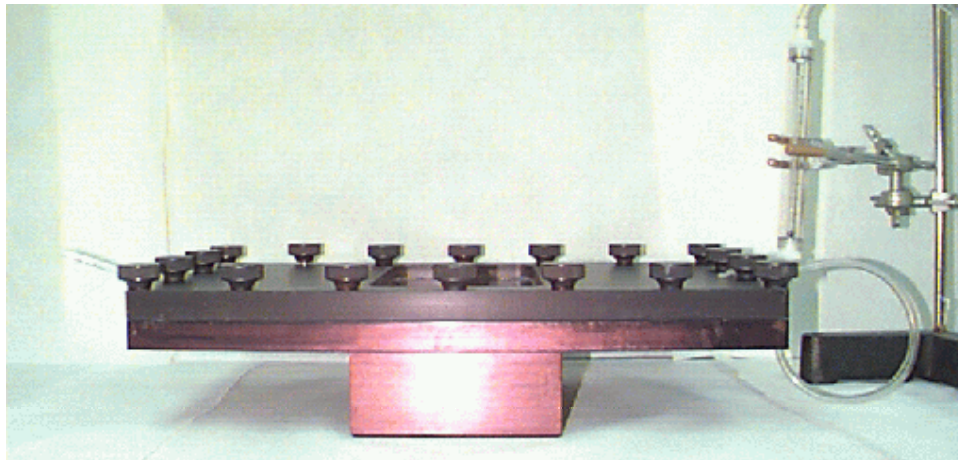

Figure 7-3. Photo of the volatile flux chamber device

### 7.4.2 Tier III - Volatile Emissions Decision

After consideration of the Tier III volatile emissions test and dispersion information, one of the following conclusions is reached for volatile emissions (Figure 7-2):

1. Information is sufficient to reach a decision regarding volatile emissions. In this case either:
  - a. Volatile emissions, after consideration of dispersion, are below applicable OSHA standards. No further emissions evaluation is necessary.
  - b. Volatile emissions, after consideration of dispersion, exceed applicable OSHA standards, and management actions should be considered. A decision to implement management actions for emissions, such as capping or treatment, may require more detailed information prior to design of such actions. If management actions are selected, no further emissions evaluation is necessary.
2. Information is not sufficient to reach a decision regarding volatile emissions. Further evaluation in Tier IV, or management actions as an alternative to further evaluation, should be considered. A decision to implement management actions for emissions, such as capping or treatment, may require more detailed information prior to design of such actions. If management actions are selected, no further emissions evaluation is necessary.

## 7.5 Dispersion Evaluations for Volatile Emissions

Actual contaminant concentrations in the air resulting from sediment contaminant fluxes are site specific and are affected by atmospheric conditions such as wind speed, mixing, temperature, as well as the location of the receptor. To evaluate the impact of sediment contaminant fluxes upon site and near-site air concentrations, a conservative estimate of actual air concentrations should be applied for both Tier II and Tier III volatile evaluations. An example scenario to estimate contaminant air concentrations could incorporate maximum fluxes obtained from modeling or laboratory testing into calculations that assume a worst-case, well-mixed set volume of air over the CDF. Contaminant concentrations can then be estimated for a predetermined period of time to give a conservative estimate of possible contaminant air concentrations.

The contaminant flux predictions obtained from the models and fluxes obtained from evaluation of sediment properties or laboratory testing can be converted to an exposure concentration to evaluate the emission. The contaminant emission is mixed with the overlying column of air, which is stripped or entrained into prevailing winds and transported offsite. The resulting contaminant concentration in the air overlying the site is a function of the contaminant flux, size of the site, and the air exchange rate with prevailing wind. The air exchange rate is a function of wind speed and site exposure. As such, the evaluation should be performed at low, medium, and high wind speed.

A screening model for evaluation of dispersion is included in the Tier II spreadsheet calculations for volatiles. An additional model developed using data obtained from testing conducted with the laboratory apparatus described in

Appendix F addresses volatile emissions from an exposed sediment. The predictive equations for modeling these emissions consider a uniformly contaminated dredged material that is freshly deposited and dewatered in a CDF. Evaporation begins from the upper segments of the dredged material and as depletion of contaminants occurs, the flux to air decreases to small values.

The detailed calculations for determining on- and off-site exposure concentrations are given in Appendix F. The model is part of the Automated Dredging and Disposal Alternatives Modeling System (ADDAMS) suite of models currently available through ERDC at: <http://www.wes.army.mil/el/elmodels/index.html#addams>.

## **7.6 Tier IV – Volatile Emissions Risk Assessment**

### **7.6.1 Evaluation**

Tier IV is intended to answer whatever specific, well-defined technical questions may remain unanswered after thorough evaluation in earlier tiers. If earlier tiers are used properly, Tier IV should rarely be necessary.

By the nature of the tiered evaluation approach, any technical questions that remain unresolved after Tier III can best be answered by a detailed, case-specific evaluation. By their very nature, detailed case-specific evaluations are not amenable to the kind of generic guidance that can be presented in a national manual. They require individual design to address unique technical questions under site-specific conditions.

The best approach for Tier IV is usually a case-specific risk assessment. Detailed guidance for conducting risk assessments for CDFs in Tier IV can be found in Cura, Wickwire, and McArde (in preparation). The information generated in Tiers I through III should be used to the maximum extent technically justified throughout the Tier IV risk assessment.

### **7.6.2 Tier IV - Volatile Emissions Decision**

After consideration of the Tier IV effluent evaluation results, all relevant information is available and no further evaluation is possible. One of the following conclusions is reached.

1. No management actions are required.
2. Management actions should be considered. A decision to implement management actions for emissions, such as capping or treatment, may require more detailed information prior to design of such actions.

## 7.7 Volatile Emissions Controls

If evaluation of the volatilization pathway indicates air quality may not be acceptable after consideration of dispersion, appropriate actions to manage air quality may be considered. Management actions for air quality may include capping of the dredged material to effectively seal off volatile releases, or treatment of the dredged material to reduce volatile releases upon disposal. Additional information on management actions and references for detailed guidance on such actions are found in Chapter 10 of this manual.

## 7.8 References and Bibliography

- Carslaw, H. S., and Jaeger, J. C. (1959). *Conduction of heat in solids*. Oxford University Press, Oxford, UK.
- Cura, J., Wickwire, T., and McArde, M. "Ecological and human health risk assessment guidance for terrestrial environments," DOER Technical Report (in preparation), U.S. Army Engineer Research and Development Center, Vicksburg, MS.
- Dilling, W. L. (1977). "Interphase transfer processes. II. Evaporation rates of chloromethanes, ethanes, ethylenes, propane, and propylenes from dilute aqueous solutions. Comparisons with theoretical predictions," *Environmental Science and Technology* 11, 405-409.
- Dupont, R. R. (1986). "Evaluation of air emission release rate model predictions of hazardous organics from land treatment facilities," *Environmental Progress* 5(3), 197.
- Haliburton, T. A. (1978). "Guidelines for dewatering/densifying confined dredged material," Technical Report DS-78-11, U.S. Army Engineer Waterways Experiment Station, Vicksburg, MS.
- Hamaker, J. W. (1972). "Diffusion and volatilization," *Organic Chemicals in the Soil Environment, Volume I*. E.A.I. Goring and J.W. Hamaker, ed., Marcel Dekker, New York.
- Liss, P. S., and Slater, P. G. (1974). "Flux of gases across the air-water interface," *Nature* 247, 181-184.
- Lunney, P. D., Springer, C., and Thibodeaux, L. J. (1985). "Liquid-phase mass transfer coefficients for surface impoundments," *Environmental Progress* 109(4), 203-211.
- Mayer, R., Letey, J., and Farmer, W. J. (1974). "Models for predicting volatilization of soil-incorporated pesticides," *Soil Science Society of America Proceeding* 38, 563-568.

- Myers, T. "Screening evaluations for confined disposal facility volatile losses," Environmental Effects of Dredging Technical Note (in preparation), U.S. Army Engineer Research and Development Center, Vicksburg, MS.
- Price, C., Brannon, J., Myers, T., Valsaraj, K., Thibodeaux, L., and Reible, D. (1997). "Development of laboratory procedures to predict volatile losses from contaminated sediments," Environmental Effects of Dredging Technical Notes EEDP-02-23, U.S. Army Engineer Waterways Experiment Station, Vicksburg, MS.
- Price, C., Brannon, J., Yost, S., Valsaraj, K., and Ravikrishna, R. (1998). "Volatile losses from exposed sediment," Environmental Effects of Dredging Technical Notes EEDP-02-24, U.S. Army Engineer Waterways Experiment Station, Vicksburg, MS.
- Price, C., Brannon, J., Yost, S., Valsaraj, K., and Ravikrishna, R. (1999). "Volatile losses from aged field sediments," Environmental Effects of Dredging Technical Notes EEDP-02-26, U.S. Army Engineer Waterways Experiment Station, Vicksburg, MS.
- Semmler, J. A. (1990). "PCB volatilization from dredged material, Indiana Harbor, Indiana," Environmental Effects of Dredging Technical Notes EEDP-02-12, U.S. Army Engineer Waterways Experiment Station, Vicksburg, MS.
- Taylor, A. W., and Glotfelty, D. E. (1988). "Evaporation from soils and crops," *Environmental Chemistry of Herbicides Volume I*. R. Grover, ed., CRC Press, Boca Raton, FL.
- Thibodeaux, L. J. (1979). *Chemodynamics*. Wiley Interscience, New York.
- \_\_\_\_\_. (1989). "Theoretical models for evaluation of volatile emissions to air during dredged material disposal with applications to New Bedford Harbor, MA," Miscellaneous Paper EL-89-3, U.S. Army Engineer Waterways Experiment Station, Vicksburg, MS.
- Thibodeaux, L. J., Parker, D. G., and Heck, H. H. (1984). "Chemical emissions from surface impoundments," *Environmental Progress* 3(2), 73-78.
- Thibodeaux, L. J., and Hwang, S. T. (1982). "Landfarming of petroleum waste modeling the air pollution problem," *Environmental Progress* 1(1), 42.
- Thomas, R. G. (1990a). "Volatilization from water," *Handbook of Chemical Property Estimation Methods*. W.J. Luman, W.F. Reehl, and D.H. Rosenblatt, ed., American Chemical Society, Washington, DC.
- \_\_\_\_\_. (1990b). "Volatilization from soil," *Handbook of Chemical Property Estimation Methods*. W.J. Luman, W.F. Reehl, and D.H. Rosenblatt, ed., American Chemical Society, Washington, DC.
- U.S. Environmental Protection Agency (USEPA). (1996). "Estimating contaminant losses from components of remediation alternatives for contaminated sediments," EPA 905-R96-001, USEPA Great Lakes National Program Office, Chicago, IL.

# 8 Animal Bioaccumulation

---

## 8.1 General Considerations

In the context of the UTM, animal uptake refers to the bioaccumulation of COC from dredged material in the tissues of animals exposed to the dredged material. Depending on its design and management, different portions of a CDF may consist of terrestrial, wetland, or aquatic habitats at any one time, and these habitats may occur in any portion of a CDF at different times during the design life of the CDF. The UTM addresses bioaccumulation by terrestrial animals of COC from the dredged material under terrestrial habitat conditions. If an evaluation of bioaccumulation by aquatic and wetland animals under aquatic and wetland habitat conditions in a CDF is necessary, it may be conducted using appropriate variations on the Tier II and/or Tier III technical procedures in the bioaccumulation chapter of the ITM. In evaluation of aquatic and wetland animal bioaccumulation in CDFs, the interpretive guidance for Tiers II and III provided in the UTM should be followed, even though the test procedures from the ITM are used.

### 8.1.1 Animal Bioaccumulation Processes

Animals may bioaccumulate COC from dredged material in terrestrial, wetland, and aquatic habitats in a CDF. In general, those species that live or feed in direct contact with the dredged material are most likely to bioaccumulate COC from the dredged material. Once a COC is in the tissues of an organism, it can be passed along to other species in the food web that prey on it. This trophic transfer can create complete exposure routes by which COC from the dredged material can come into direct physiological contact with organisms that do not live or feed in direct contact with the dredged material. These complete exposure routes may include organisms such as animals, birds, or humans that eat fish caught from aquatic habitats in a CDF, foxes that eat rodents from terrestrial habitats, and numerous species that eat organisms in wetland habitats.

### 8.1.2 Regulatory Considerations

As explained in Chapter 1, there are no regulatory standards for contaminant uptake by plants and animals at CDFs. Land application of sludge and waste soils



regulatory protocols are not designed to address the unique characteristics that occur as sediments dry and colonize with wetland or terrestrial plants and animals. Also, the plant and animal routes of exposure are different and are treated differently in this manual. It is USACE policy that the procedures used in this manual provide a basis for determining if bioaccumulation poses a risk of effects on populations of receptors of concern outside the CDF.

The UTM is concerned only with effects outside the CDF. Therefore, in the UTM animal bioaccumulation is of concern only if it is part of a complete exposure pathway from the dredged material to predators that live outside the site and feed on organisms that bioaccumulate COC from the dredged material in the site. To illustrate the concept, in the context of the UTM there is typically not a concern about COC

Bioaccumulation by:

- Earthworms in terrestrial habitats within a CDF
- Fish in aquatic habitats within a CDF
- Mussels in wetland habitats within a CDF

Unless:

- A bird flies in from offsite and eats the worms
- A person catches and eats the fish, or a bird flies in from offsite and eats the fish
- A raccoon comes onto the site and eats the mussels

Because the concern in the UTM is for potential effects outside the site, bioaccumulation is considered a component of *exposure* for off-site ROC, and is not evaluated as an indicator of potential effects on the on-site organisms that may accumulate the COC directly from the dredged material. This emphasis on effects of bioaccumulation on predators is in contrast to the OTM and ITM, in which bioaccumulation data have frequently been evaluated in relation to potential effects on the organism whose tissues contain the COC rather than on the predators of that organism.

Unlike the other contaminant mobility pathways addressed in the UTM, there are presently no standards or criteria that can be directly applied in a technically sound manner to animal (or plant) bioaccumulation. Therefore, bioaccumulation is evaluated on the basis of its potential to cause effects on ROC populations outside the CDF (Section 2.2.4). The exception to evaluation on the basis of effects on ROC populations outside the CDF is when the ROC are humans or endangered species, in which case there is concern about effects on individuals within or outside the CDF.

The first step in determination of the potential for effects is to compare bioaccumulation from the dredged material to bioaccumulation from a properly selected reference material. If bioaccumulation from the dredged material is not statistically greater than bioaccumulation from the reference material, bioaccumulation is not considered to pose a potential for effects. If bioaccumulation from the dredged material is statistically greater than from the reference material, further evaluation in subsequent tiers is necessary to determine the potential for effects. Because the reference material is carefully selected to represent acceptable conditions, whatever bioaccumulation it may cause is an

acceptable level of animal bioaccumulation. Although statistical significance, *per se*, cannot indicate environmental importance, a statistically significant increase above reference bioaccumulation has been considered in the OTM and ITM to indicate a potential for effects, and that convention is followed in the Tier II and III animal bioaccumulation in the UTM. Detailed decision guidance is provided in the discussions of each of the tiers.

### 8.1.3 Data Requirements

The evaluation of animal bioaccumulation requires information on the CDF and its environmental setting, the planned dredged material management, and the characteristics of the dredged material. Much of this comes from the available information compiled in Tier I, and supplemented (if necessary) by the Tier II and Tier III test data.

### 8.1.4 Summary of Tiered Evaluation of Animal Bioaccumulation

A flowchart illustrating the tiered evaluation for animal uptake is shown in Figure 8-1. The other contaminant mobility pathways addressed in the UTM are evaluated primarily on the basis of standards or criteria, and risk assessment plays a relatively minor role in Tiers I through III. In the absence of technically applicable standards or criteria, animal (and plant) bioaccumulation evaluations in the UTM rely more directly on risk assessment in Tiers I through III. Evaluation of all pathways relies on risk assessment in Tier IV.

The risk-based approach to evaluation of animal bioaccumulation is structured around the conceptual site model developed in Tier I. The conceptual site model provides the framework and the context for conducting the evaluation (Cura, Wickwire, and McArlde in preparation). It describes the dredged material management planned, the environmental setting of the site, and how the planned site management interacts with the environmental setting to determine what effects might potentially occur. The evaluation in Tiers I through III emphasizes three components evaluated in the context of the conceptual site model:

- Populations of receptors of concern (ROC) outside the CDF, discussed in Section 2.2.3
- Constituents of concern (COC), discussed in Sections 2.2.2 and 3.4
- Complete exposure routes, discussed in Section 2.2.4. Identification of reasonable complete exposure routes by which ROC populations outside the CDF can come into direct physiological contact with COC is key to the entire evaluation. If there are no reasonable complete exposure routes, there can be no exposure and thus no effect or risk.

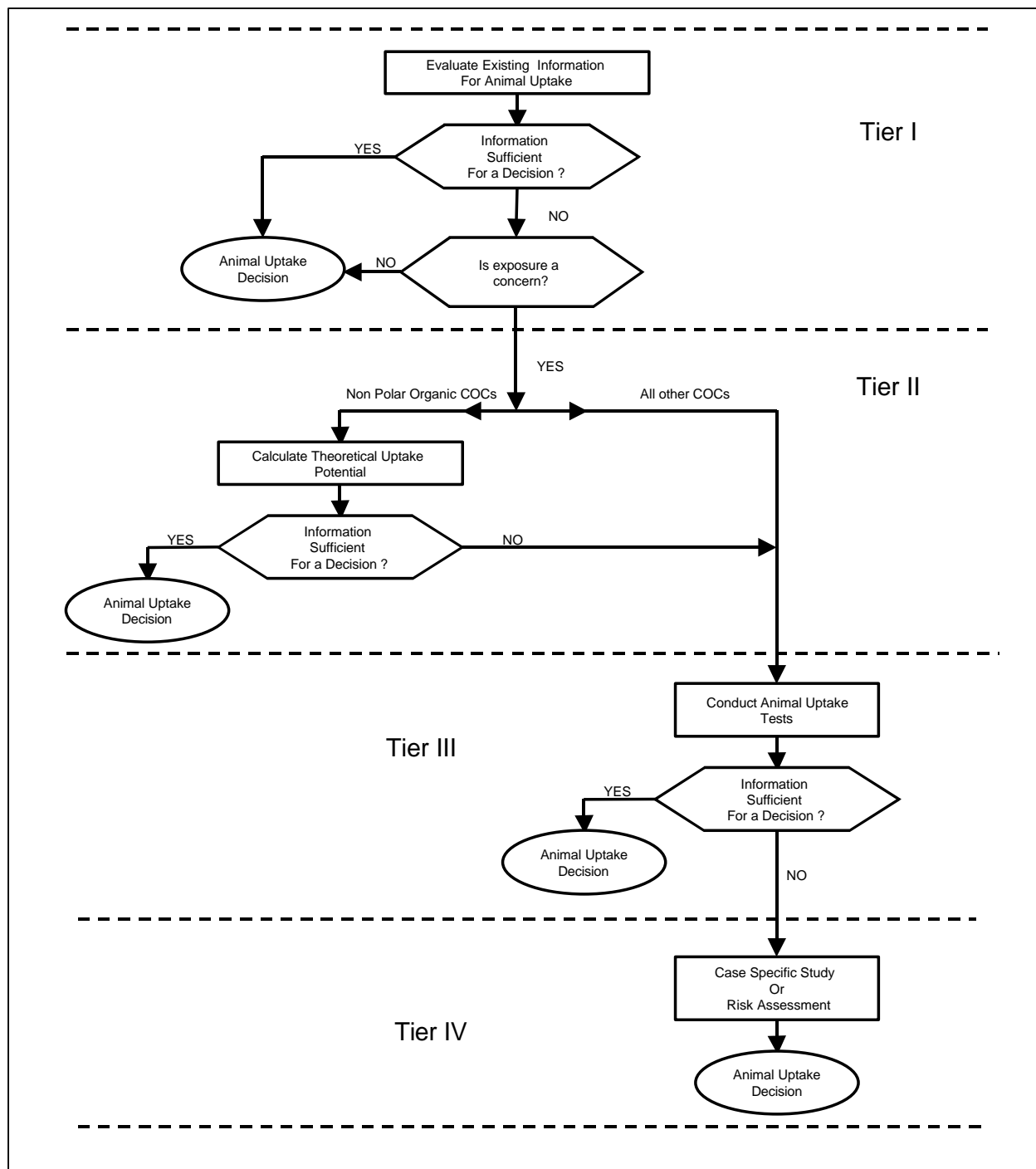

Figure 8-1. Flowchart illustrating tiered evaluation approach for the animal uptake pathway

Tier I involves many activities essential to the entire evaluation. It includes compilation of available information, construction of a conceptual site model, development of initial COC, identification of ROC, and identification of complete exposure routes to populations of animal ROC off the site. Identification of complete exposure routes to off-site animal ROC populations (and by implication, those potential exposure routes that are not complete and thus pose no risk) is a major emphasis of Tier I. Tier I also includes evaluation of the available information to reach a decision about the acceptability of any COC/ROC/exposure pathway combinations for which there is sufficient information for a decision and identify the remaining COC for further evaluation in subsequent tiers.

If a decision about the need for management actions based on animal bioaccumulation cannot be reached based on existing information in Tier I, the evaluation may be carried to Tier II. Tier II consists of evaluation of the theoretical bioaccumulation potential (TBP) of nonpolar organic COC. Those COC for which the results indicate little potential for bioaccumulation may be eliminated with regard to animal bioaccumulation, and those for which further information is necessary to reach a decision may be carried to Tier III.

Tier III consists of laboratory bioaccumulation tests for the remaining COC using surrogate species. Those COC for which the results indicate little potential for bioaccumulation may be eliminated with regard to animal bioaccumulation, and those for which further information is necessary to reach a decision may be carried to Tier IV.

The evaluations of Tiers I through III will be sufficient to reach a decision about most COC in most cases. In those situations where this is not the case, a full risk assessment of the remaining COC may be conducted in Tier IV.

The procedures in the various tiers can be applied to evaluate the performance of existing CDFs and to design new sites. For existing sites, the techniques can be used to predict the potential for bioaccumulation for a given set of anticipated operational conditions (e.g., CDF size). In a similar manner, the required operational conditions for a new site (e.g., frequency of new lifts) to avoid bioaccumulation can be determined by comparing the predicted bioaccumulation for a variety of assumed operational conditions. In either case, evaluation of bioaccumulation must be considered in conjunction with a sound design of the CDF for retention of suspended solids and initial storage of the sediments to be dredged.

## **8.2 Tier I – Initial Evaluation of Animal Bioaccumulation**

Animal bioaccumulation is evaluated only if the Tier I evaluation of the proposed project (Chapter 3) demonstrates that contaminant evaluations are needed and that animal bioaccumulation is a contaminant mobility pathway of concern for the project. It is important to consider prior evaluations of the animal bioaccumulation pathway to determine if additional evaluations are needed. For example, if prior tests or evaluations are available, and project conditions and

dredged material characteristics are unchanged, new evaluations may not be necessary.

### **8.2.1 Compilation and Evaluation of Existing Information**

The Tier I information generated in Chapter 3 is the technical basis for the Tier I evaluation of animal bioaccumulation. Because the Tier I animal (and plant) bioaccumulation evaluation relies more heavily on a risk assessment approach than the evaluation of the other pathways, the Tier I information from Chapter 3 is organized and used in a risk assessment framework. The information compiled and used in Chapter 3 to identify relevant contaminant mobility pathways is organized and used as described below to develop a conceptual site model specific to the project being evaluated. The information from Chapter 3 on COC and ROC is evaluated in the context of the conceptual site model. The Tier I animal bioaccumulation evaluation emphasizes identification of complete exposure routes in the context of the conceptual site model. There can be no risk unless there is a complete exposure route by which an ROC can come into direct physiological contact with a COC.

### **8.2.2 Development of Conceptual Site Model**

Guidance on development of a conceptual site model is available in Cura, Wickwire, and McArde (in preparation), from which this section, specific to evaluation of animal bioaccumulation, is summarized. The conceptual site model for evaluation of animal bioaccumulation is an integration of existing information which identifies the COC and their sources, describes the exposure routes involving animal bioaccumulation by which they may reach ecological and human ROC, and specifies which ecological and human ROC might be linked to the COC by these routes. The conceptual site model is a narrative or diagram that describes the links between COC and ROC along explicit fate and transport routes involving animal bioaccumulation.

The conceptual model is the basis for determining which fate and transport processes involving animal bioaccumulation will be examined, deciding which receptors to address, and identifying the COC that will be evaluated. In order to evaluate risks, it is important to clearly identify all three elements: the stressors, the receptors, and the exposure routes that connect them. The absence of a complete exposure route is one basis for early elimination of some exposure routes and stressor/receptor sets from further consideration in a risk assessment, so that the process can focus on situations that might reasonably constitute a potential risk. This is the opportunity to focus questions upon issues of real concern. Because the conceptual model is so fundamental to the conduct and acceptance of the risk assessment, it is important that Federal and State agencies, interested parties, and the general public have meaningful participation in the development of the conceptual model.

The conceptual model serves two purposes in evaluation of animal bioaccumulation, based on the Tier I compilation of existing information (Chapter 3):

- a. **Site characterization.** Site characterization is a general description of the environmental setting that is an integral part of an ecological or human health evaluation of animal bioaccumulation. It should:
  - i. Provide a brief overview of the CDF in terms of its current and past uses.
  - ii. Characterize the CDF relative to receptors.
  - iii. Describe the presence of contaminants in the dredged material.
- b. **Defining complete exposure routes.** Complete exposure routes are the links between sources of COC and humans or ecological ROC. A complete exposure route is a combination of physical, chemical, and biological processes that may transport a COC from a source, such as dredged material in a CDF, into direct physiological contact with a specified human or ecological ROC. The presence of a complete exposure route does not necessarily translate to risk. The conceptual model attempts only to describe the potential for migration of COC based on the site-specific physical conditions, chemistry, and biology. It provides neither a quantitative estimate of the amount of COC moving along a specific route nor an estimate of resulting exposure concentrations. Subsequent components of the risk assessment will incorporate information on the amount of each COC moving along each complete exposure route and evaluate whether that amount poses a potential risk to a human or ecological ROC.

The following are the seven steps in developing a conceptual site model using the existing information compiled in Chapter 3. The discussion here focuses on identification of COC and ROC, determination of complete exposure routes involving animal bioaccumulation, and elimination of those potential routes that are not complete from further evaluation. Detailed guidance on all steps is available in Cura, Wickwire, and McArldde (in preparation).

1. Describe the dredged material management activity. This description should include the dredging, transportation and disposal processes, the amount and source of dredged material, and physical, chemical and biological characteristics of the CDF and its surroundings. The product of this step is a written description of the proposed dredged material management activity.
2. Identify the kinds and spatial extent of habitats and land uses that are present in and around the CDF and those that may reasonably exist in the future. It is important to identify habitats in and near the CDF, because these will largely determine human uses and ecological receptors for the conceptual model. The identifications should be specific and conform to

common ecological descriptions of terrestrial or aquatic habitats. The habitat classifications should not be so broad as to lose ecological meaning, nor so specific that they lack information regarding the relationships among organisms. The product of this step is narrative text, maps, and figures, as necessary, which describe the habitats at and adjacent to the CDF.

3. Identify the off-site animal species and humans that may consume animals that have bioaccumulated COC from the dredged material at present and under reasonably foreseeable future conditions. To identify ecological ROC, first identify nearby biological communities as general types such as riverine, forest, or meadow/grassland. Then list the animals of various types and feeding habits that are likely to be important within these general communities and to consume animals that have taken up COC from the dredged material. The ecological ROC should reflect the variety of trophic levels, feeding types, and phylogenetic diversity in the identified habitats. The product is a list (generally three to eight are sufficient) of ecological ROC that may, now and within the reasonably foreseeable future, consume animals that have taken up COC from the dredged material. The list describes the role each ROC plays at the site and how they represent other species of similar feeding types, etc. It also briefly describes why other species at the site were not selected as ROC.
4. Specify the COC for animal bioaccumulation. The goals are to focus on those constituents that warrant detailed evaluation, and document the reasons others do not warrant further consideration, resulting in a focused list of COC necessary and sufficient for a thorough assessment of risks associated with animal bioaccumulation for the project being evaluated. Simple presence of a constituent in the dredged material being evaluated is not sufficient to include that constituent as a potential COC. The primary factors to consider in identifying COC for animal bioaccumulation include frequency of presence in the dredged material, concentration in the dredged material relative to the concentration in the reference material, toxicological importance, persistence in the environment and propensity to bioaccumulate in animals. The product is a site-specific list of COC, documenting why each was retained, and why other constituents were not considered COC.
5. Describe mechanisms that may bring COC into contact with a human or ecological ROC. This step in a risk assessment is essentially the same as the identification of relevant contaminant mobility pathways, completed in Section 3.2, which showed animal bioaccumulation warrants evaluation for the project in question. The product of this step is a narrative that describes how animal bioaccumulation of COC from the dredged material could reach animals living outside the CDF.
6. Describe the potential processes of contact between COC and ROC. The simple existence of a mechanism that may transport a COC to a ROC will not result in a complete exposure route unless there is some process by which the COC comes into actual physiological contact with a ROC.

These processes may include dermal contact, ingestion, or inhalation. The product should (1) specify the likely contact process(s) for each ROC separately, and (2) document those processes that, even though they may be part of complete exposure routes, are sufficiently minor to not warrant further attention.

7. Describe the complete exposure routes, and eliminate from further evaluation those potential routes that are not complete. This step describes each complete exposure route in detail, including the identity and source of each COC, the release mechanism, the process of exposure and the activities of the ROC that bring it into direct physiological contact with the COC. A complete exposure route is a combination of physical, chemical, and biological processes that bring a COC from dredged material into direct physiological contact with an ecological (e.g., a bird) or a human (e.g., fisherman) ROC. Potential exposure routes that are incomplete should be documented and not considered further. A complete exposure route does not necessarily translate to risk. Risk depends on the concentration or dose of COC to the ROC relative to that receptor's toxic response. The exposure assessment component of the risk assessment will address issues regarding the dose or concentration of COC to which a ROC is likely to be exposed in the field, and the effects assessment component addresses the levels at which the COC has the potential to adversely affect the receptor. The product of Steps 6 and 7 is a graphical and narrative description of the complete exposure routes specific for the COCs, habitats, and ecological and human ROC. It is a written summary of the chemical, physical, and biological conditions at the CDF.

Where data are insufficient to fully develop a complete conceptual site model, the site model should be developed as completely as possible, using clearly identified assumptions and estimations where necessary. As the evaluation progresses through the tiers, these assumptions and estimations may be replaced with more definitive information as it becomes available.

### **8.2.3 Tier I - Evaluation Procedure**

A fundamental emphasis of the Tier I evaluation is on identification of complete exposure routes to ROC outside the CDF. Complete exposure routes are evaluated in Tier I if the available information is sufficient to make a decision, and if there is not sufficient information to support a decision, they are carried to subsequent tiers for more detailed evaluation. Incomplete exposure routes to ROC outside the CDF, and complete routes that clearly involve such minimal potential exposure as to pose negligible risk of unacceptable adverse effect, are documented and eliminated from further consideration.

A key to the evaluation of ecological impacts of animal bioaccumulation in Tier I, as well as in subsequent tiers, is the concept of effect as discussed in Section 2.2.4. Effects are generally evaluated at the population or higher level rather than at the level of individual organisms, except in the case of endangered



species and humans, where individuals are of concern. If a reasonable complete exposure route to a ROC population outside the CDF exists, there is generally no risk of an effect unless there is potential for a sufficient number of individual organisms to be affected in a manner severe enough to threaten the long-term sustainability of viable local populations of the ROC species outside the CDF.

The conceptual site model constructed from existing Tier I information is examined. The site-specific COC and ROC for animal bioaccumulation are identified. Any reasonable, potentially complete exposure routes to ROC outside the CDF are described. Any incomplete exposure routes to ROC outside the CDF, and any potentially complete routes that clearly involve such minimal potential exposure as to pose negligible risk of unacceptable adverse effect, are described.

#### **8.2.4 Tier I - Animal Bioaccumulation Decision**

After consideration of the Tier I animal bioaccumulation information in the context of the conceptual site model, one of the following conclusions is reached (Figure 8-1).

1. Information is sufficient to reach a decision without further evaluation. This is the case if there are no reasonable, potentially complete exposure routes, or all potentially complete routes clearly involve such minimal potential exposure as to pose negligible risk of any effects, to ROC populations outside the CDF. No further evaluation of animal bioaccumulation is necessary.
2. Information is not sufficient to reach a decision regarding animal bioaccumulation. This is the case if there are potentially complete exposure routes that may pose a potential risk to ROC populations outside the CDF.

### **8.3 Tier II – Theoretical Bioaccumulation Potential**

The Tier II animal bioaccumulation evaluation considers earthworms as the primary animals for direct bioaccumulation of COC from dredged material in terrestrial habitats in CDFs. If these organisms bioaccumulate COC, they may provide a crucial link in a complete exposure route to off-site consumers that may feed in the CDF. There is generally not a complete exposure route to off-site consumers for those COC not taken up by earthworms. Theoretical bioaccumulation potential (TBP) is used for Tier II evaluation of animal bioaccumulation.

To date, the TBP calculation has been used only in relation to bioaccumulation of nonpolar organic chemicals such as PCBs in aquatic organisms. However, theoretical considerations indicate the procedure should also be applicable to earthworms, and its utility for these organisms is being confirmed. TBP is used for bioaccumulation of nonpolar organic chemicals by

earthworms in the Tier II evaluation animal bioaccumulation in the UTM. Methods for TBP calculations with metals and polar organic compounds are under development and may be added to this manual in the future.

It is useful to calculate the TBP for nonpolar organic COC, because it may show these compounds are not bioavailable and thus do not warrant further evaluation in higher tiers. If further evaluation of any nonpolar organic COC is warranted, TBP provides an indication of the magnitude of bioaccumulation that may occur.

Nonpolar organic chemicals include all organic compounds that do not dissociate or form ions. This includes the chlorinated hydrocarbon pesticides, many other halogenated hydrocarbons, PCBs, many PAHs including all the priority pollutant PAHs, dioxins, and furans. It does not include metals and metal compounds, organic acids or salts, or organometallic complexes such as tributyltin or methyl mercury.

The environmental distribution of nonpolar organic chemicals is controlled largely by their solubility in various media. Therefore, in sediments they tend to occur primarily in association with organic matter (Karickhoff 1981). In organisms they are found primarily in the body fats or lipids (Konemann and van Leeuwen 1980; Geyer et al. 1982; Mackay 1982; Bierman 1990).

### **8.3.1 Tier II – Theoretical Bioaccumulation Potential Procedure**

Bioaccumulation of nonpolar organic compounds from dredged material can be estimated from the organic carbon content of the material, the lipid content of the organism, and the relative affinities of the chemical for sediment organic carbon and animal lipid content. The TBP calculation assumes that various lipids in different organisms and organic carbon in different sediments are similar and have similar distributional properties. Other simplifying assumptions are that chemicals are freely exchanged between the sediments and tissues and that compounds behave conservatively. In reality, compound size and structure may influence accumulation, and portions of organic compounds present on suspended particulates may have kinetic or structural barriers to availability. Another important assumption implicit in the TBP calculations is that there is no metabolic degradation or biotransformation of the chemical. Organic carbon normalized contaminant concentrations are used such that the sediment-associated chemical can be characterized as totally bioavailable to the organism. Calculations based on these assumptions yield an environmentally protective (e.g., overestimate) TBP value for the dredged material if the dredged material in question is the only source of the contaminant for the organism. Note that TBP calculations are not valid for sediments or soils with total organic carbon (TOC) content less than or equal to 0.2 percent.

For each nonpolar organic COC, TBP is calculated for the dredged material and the reference material according to the guidance in Appendix G. The TBP of the dredged material is compared statistically to the reference TBP to determine

whether there is an indication of greater bioaccumulation from the dredged material than from the reference.

### **8.3.2 Tier II – Theoretical Bioaccumulation Potential Decision**

After consideration of the Tier II animal bioaccumulation information in the context of the conceptual site model and the complete exposure routes to ROC populations outside the CDF, one of the following conclusions is reached for nonpolar organic COC.

1. Information is sufficient to reach a decision regarding animal bioaccumulation. This is the case where the TBP of the dredged material is not statistically greater than the TBP of the reference material. No further evaluation of animal bioaccumulation is necessary.
2. Information is not sufficient to reach a decision regarding animal bioaccumulation. This is the case if the TBP of the dredged material is statistically greater than the TBP of the reference material, or there are COC other than nonpolar organics. Further evaluation in Tier III, or management actions as an alternative to further evaluation, should be considered. A decision to implement management actions for animal bioaccumulation by interrupting complete exposure routes to ROC outside the CDF may require more detailed information prior to design of such actions. If management actions are selected, no further evaluation of animal bioaccumulation is necessary.

## **8.4 Tier III – Animal Bioaccumulation Test**

The Tier III animal bioaccumulation test uses earthworms for the same reason as the Tier II evaluation. The Tier III procedure determines the potential bioaccumulation of COC under freshwater terrestrial conditions by earthworms, a representative soil invertebrate known to accumulate a wide variety of contaminants from the soil in which it lives. This test procedure has been established as ASTM SE-1676 Standard Procedure (ASTM 1997) and is provided in Appendix G. The procedure is applicable to all COC for animal bioaccumulation, whatever their chemical nature. The bioaccumulation assay provides information on (1) bioavailability and mobility of COC from soil to the soil-dwelling earthworms, and (2) the potential for COC movement to higher organisms (e.g., birds, mammals, amphibians, reptiles) from off the site linked to worms in the food web.

### **8.4.1 Tier III – Animal Uptake Test Procedure**

The Tier III animal bioaccumulation procedure measures COC bioaccumulation by earthworms from the dredged material and a reference material. The test consists of a direct exposure of the earthworms in both dredged material and reference. A photo of a typical test setup is shown in Figure 8-2.

Concentrations of COC in tissues of organisms in the dredged material are statistically compared to the concentrations in tissues of organisms in the reference material to determine whether there is an indication of greater bioaccumulation from the dredged material than from the reference. See Section 2.3.5 for additional details on selection of an appropriate reference material.

#### 8.4.2 Tier III - Animal Bioaccumulation Decision

After consideration of the Tier III animal bioaccumulation information in the context of the conceptual site model and the complete exposure routes to ROC populations outside the CDF, one of the following conclusions is reached.

1. Bioaccumulation from the dredged material is not statistically greater than bioaccumulation from the reference material. No further evaluation of animal bioaccumulation is necessary.
2. Bioaccumulation from the dredged material is statistically greater than bioaccumulation from the reference material. Therefore the magnitude of potential effects on ROC populations outside the CDF must be considered, leading to a conclusion that either:



Figure 8-2. Photo of the animal uptake bioassay setup

- a. There is little potential for effects on ROC populations outside the CDF. No further evaluation of animal bioaccumulation is necessary.
- b. Effects on ROC populations outside the CDF are likely, and management actions should be considered. A decision to implement management actions for animal bioaccumulation by interrupting

complete exposure routes to ROC populations outside the CDF may require more detailed information prior to design of such actions. If management actions are selected, no further evaluation of animal bioaccumulation is necessary.

3. Information is not sufficient to reach a decision regarding animal bioaccumulation. Further evaluation in Tier IV, or management actions as an alternative to further evaluation, should be considered. A decision to implement management actions for animal bioaccumulation by interrupting complete exposure routes to ROC populations outside the CDF may require more detailed information prior to design of such actions. If management actions are selected, no further evaluation of animal bioaccumulation is necessary.

## **8.5 Tier IV – Animal Bioaccumulation Risk Assessment**

### **8.5.1 Evaluation**

The elimination of incomplete exposure pathways in Tier I and the elimination of COC that do not bioaccumulate to levels causing effects in ROC populations outside the CDF in Tiers II and III should have resolved most animal bioaccumulation issues for most dredged materials. Tier IV is intended to answer whatever specific, well-defined technical questions may remain unanswered after thorough evaluation in earlier tiers. If earlier tiers are used properly, Tier IV should rarely be necessary for navigation projects (Sections 2.1.4 and 2.1.5).

By the nature of the tiered evaluation approach, any technical questions that remain unresolved after Tier III can best be answered by a detailed, case-specific evaluation. By their very nature, detailed case-specific evaluations are not amenable to the kind of generic guidance that can be presented in a national manual. They require individual design to address unique technical questions under site-specific conditions.

The best approach for Tier IV is usually a case-specific risk assessment. Detailed guidance for conducting risk assessments for CDFs in Tier IV can be found in Cura, Wickwire, and McArde (in preparation). The information generated in Tiers I through III should be used to the maximum extent technically justified throughout the Tier IV risk assessment.

### **8.5.2 Tier IV - Animal Bioaccumulation Decision**

After consideration of the Tier IV evaluation results, all relevant information is available and no further evaluation is possible. One of the following conclusions is reached.

1. No management actions are required.

2. Management actions should be considered. A decision to implement management actions for animal bioaccumulation by interrupting complete exposure routes to ROC populations outside the CDF may require more detailed information prior to design of such actions.

## 8.6 Animal Bioaccumulation Management Actions

When there is concern about the potential for effects related to animal bioaccumulation, management actions related to the design, operation, and management of the CDF may be considered. In general, anything that interrupts a complete exposure route to ROC populations outside the CDF may act as an effective control of animal bioaccumulation. Therefore, the evaluation that identifies complete exposure routes will often also provide ideas for management actions that interrupt them. Additional information on management actions and references for detailed guidance on such actions are found in Chapter 10 of this manual.

## 8.7 References

- American Society for Testing and Materials (ASTM). (1997). "Standard guide for conducting laboratory soil toxicity or bioaccumulation tests with the lumbriced earthworm *eisenia fetida*," ASTM SE-1676, West Conshohocken, PA.
- Bierman, V. J. (1990). "Equilibrium partitioning and biomagnification of organic chemicals in benthic animals," *Environ. Sci. Technol.* 24, 1407-1412.
- Cura, J., Wickwire, T., and McArld, M. "Ecological and human health risk assessment guidance for terrestrial environments," DOER Technical Report (in preparation), U.S. Army Engineer Research and Development Center, Vicksburg, MS.
- Geyer, H., Sheehan, P., Kotzias, D., and Korte, F. (1982). "Predictions of ecological behavior of chemicals: Relationship between physico-chemical properties and bioaccumulation of organic chemicals in the mussel *Mytilus edulis*," *Chemosphere* 11, 1121-1134.
- Karickhoff, S. (1981). "Semi-empirical estimation of sorption of hydrophobic pollutants on natural sediments and soils," *Chemosphere* 9, 3-10.
- Konemann, H., and van Leeuwen, K. (1980). "Toxicokinetics in fish: Accumulation and elimination of six chlorobenzenes by guppies," *Chemosphere* 9 (1), 3-19.
- Mackay, D. (1982). "Correlation of bioconcentration factors," *Environ. Sci. Technol.* 5, 274-278.

Simmers, J. W., Rhett, R. G., and Lee, C. R. (1986). "Upland animal bioassays of dredged material," Technical Note EEDP-02-2, U.S. Army Engineer Waterways Experiment Station, Vicksburg, MS.

Stafford, E. A. (1988). "Upland animal bioassays of dredged material," Technical Note EEDP-02-4, U.S. Army Engineer Waterways Experiment Station, Vicksburg, MS.

# 9 Plant Bioaccumulation

---

## 9.1 General Considerations

In the context of the UTM, plant uptake refers to the bioaccumulation of COC from dredged material in the tissues of plants growing on the dredged material. Depending on its design and management, different portions of a CDF may consist of terrestrial, wetland, or aquatic habitats at any one time, and these habitats may occur in any portion of a CDF at different times during the design life of the CDF. The UTM addresses bioaccumulation by terrestrial plants of COC from the dredged material under terrestrial (wetland and upland) habitat conditions.

Metals are the most common class of COC for which plant uptake is of concern. Only a limited number of organics are of concern for plant uptake, e.g., certain energetics (RDX), certain solvents (e.g., TCE).

### 9.1.1 Plant Bioaccumulation Processes

Plants may bioaccumulate COC from dredged material in terrestrial, wetland, and aquatic habitats in a CDF. Once a COC is in the tissues of a plant, it can be passed along to other species in the food web that feed on it. This trophic transfer can create complete exposure routes by which COC from the dredged material can come into direct physiological contact with organisms that do not live or feed in direct contact with the dredged material. These complete exposure routes may include organisms such as foxes that prey on rodents that eat plants from terrestrial habitats in CDFs, numerous species that prey on herbivores in wetland habitats in CDFs, and birds, animals, or humans that eat fish caught from aquatic habitats in CDFs.

### 9.1.2 Regulatory Considerations

As explained in Chapter 1, there are no regulatory standards for contaminant uptake by plants and animals at CDFs. Land application of sludge and waste soils regulatory protocols are not designed to address the unique characteristics that occur as sediments dry and colonize with wetland or terrestrial plants and animals. Also, the plant and animal routes of exposure are different and are treated differently in this manual. It is USACE policy that the procedures used in this



manual provide a basis for determining if bioaccumulation in plants poses a risk of effects on populations of receptors of concern outside the CDF.

The UTM is concerned only with effects outside the CDF. Therefore, in the UTM plant bioaccumulation is of concern only if it is part of a complete exposure pathway from the dredged material to animals that live outside the CDF and feed (either as herbivores or predators of herbivores) on plants that bioaccumulate COC from the dredged material in the CDF.

To illustrate the concept, in the context of the UTM there is typically not a concern about COC.

- |                               |   |
|-------------------------------|---|
| Bioaccumulation by:           | Unless:   |
| • Terrestrial plants in a CDF | • A bird flies in from offsite and eats the the plant (geese eat tubers and leaves)                                     |
| • Aquatic plants in a CDF     | • A person catches and eats a fish from aquatic habitats within the CDF that feeds on herbivorous aquatic invertebrates |
| • Wetland plants in a CDF     | • A fox comes onto the site and eats a herbivorous rodent   |

Because the concern in the UTM is for potential effects outside the site, bioaccumulation is considered a component of *exposure* for off-site ROC, and is not evaluated as an indicator of potential effects on the on-site plants that may accumulate the COC directly from the dredged material. Unlike the other contaminant mobility pathways addressed in the UTM, there are presently no standards or criteria that can be directly applied in a technically sound manner to plant (or animal) bioaccumulation. Therefore, plant bioaccumulation from dredged material in a CDF is evaluated on the basis of its potential to cause effects on animal populations outside the site (Section 2.2.4).

The first step in determination of the potential for effects is to compare bioaccumulation from the dredged material to that from a properly selected reference material. If bioaccumulation from the dredged material is not statistically greater than that from the reference material, bioaccumulation is not considered to pose a potential for effects. If bioaccumulation from the dredged material is statistically greater than from the reference material, further evaluation in subsequent tiers is necessary to determine the potential for effects. Because the reference material is carefully selected to represent acceptable conditions, whatever bioaccumulation it may cause is an acceptable level of plant bioaccumulation. Although statistical significance, *per se*, cannot indicate environmental importance, a statistically significant increase above reference bioaccumulation has been considered in the OTM and ITM to indicate a potential for effects, and that convention is followed in the Tiers II and III plant bioaccumulation in the UTM. Detailed decision guidance is provided in the discussions of each of the tiers.

### 9.1.3 Data Requirements

The evaluation of plant bioaccumulation requires information on the CDF and its environmental setting, the planned dredged material management, and the characteristics of the dredged material, as well as information on animal ROC populations outside the CDF from Chapter 8. Much of this comes from the available information compiled in Tier I, supplemented (if necessary) by the Tier II and Tier III test data.

### 9.1.4 Summary of Tiered Evaluation of Plant Bioaccumulation

The other contaminant mobility pathways addressed in the UTM are evaluated primarily on the basis of standards or criteria, and risk assessment plays a relatively minor role in Tiers I through III. In the absence of technically applicable standards or criteria, plant (and animal) bioaccumulation evaluations in the UTM rely more directly on risk assessment in Tiers I through III. Evaluation of all pathways relies on risk assessment in Tier IV.

The risk-based approach to evaluation of plant bioaccumulation is structured around the conceptual site model developed in Tier I. The conceptual site model provides the framework and the context for conducting the evaluation (Cura, Wickwire, and McArde in preparation). It describes the dredged material management planned, the environmental setting of the site, and how the planned site management interacts with the environmental setting to determine what effects might potentially occur. The evaluation in Tiers I through III emphasizes three components evaluated in the context of the conceptual site model:

- Receptors of concern (ROC), discussed in Section 2.2.3. These are animal populations off the site.
- Constituents or contaminants of concern (COC), discussed in Sections 2.2.2 and 3.4.
- Complete exposure routes, discussed in Section 3.2.4. Identification of reasonable complete exposure routes by which ROC can come into direct physiological contact with COC is key to the entire evaluation. If there are no reasonable complete exposure routes, there can be no exposure and thus no effect or risk.

Tier I involves many activities essential to the entire evaluation. It includes compilation of available information, construction of a conceptual site model, development of initial COC, identification of ROC, and identification of complete exposure routes. Identification of complete exposure routes (and by implication, those potential exposure routes that are not complete and thus pose no risk) is a major emphasis of Tier I. Tier I also includes evaluation of the available information to reach a decision about the acceptability of any COC/ROC/exposure pathway combinations for which there is sufficient information for a decision and identify the remaining COC for further evaluation in subsequent tiers.

If a decision about the need for management actions based on plant bioaccumulation cannot be reached based on existing information in Tier I, the evaluation may be carried to Tier II. Tier II consists of evaluation of the potential for bioaccumulation of metals by plants growing in freshwater dredged material in terrestrial or upland habitats based on dredged material extraction with diethylenetriamine pentaacetic acid (DTPA), as well as a prescreen applicable in specific circumstances described in Section 9.3. Those metals for which the DTPA results indicate little potential for bioaccumulation may be eliminated with regard to plant bioaccumulation, and those metals and other COC for which further information is necessary to reach a decision may be carried to Tier III.

Tier III consists of laboratory bioaccumulation tests for the remaining COC by plants growing in freshwater or saltwater dredged material under terrestrial or wetland conditions. Those COC for which the results indicate little potential for bioaccumulation may be eliminated with regard to plant bioaccumulation, and those for which further information is necessary to reach a decision may be carried to Tier IV. The evaluations of Tiers I through III will be sufficient to reach a decision about most COC in most cases. In those situations where this is not the case, a full risk assessment of the remaining COC may be conducted in Tier IV.

The procedures in the various tiers can be applied to evaluate the performance of existing CDFs and to design new sites. For existing sites, the techniques can be used to predict the potential for bioaccumulation for a given set of anticipated operational conditions (e.g., CDF size). In a similar manner, the required operational conditions for a new site (e.g., frequency of new lifts) to avoid bioaccumulation can be determined by comparing the predicted bioaccumulation for a variety of assumed operational conditions. In either case, evaluation of bioaccumulation must be considered in conjunction with a sound design of the CDF for retention of suspended solids and initial storage of the sediments to be dredged.

## **9.2 Tier I – Initial Evaluation of Plant Bioaccumulation**

Plant bioaccumulation is evaluated only if the Tier I evaluation of the proposed project (Chapter 3) demonstrates that contaminant evaluations are needed and that plant bioaccumulation is a contaminant mobility pathway of concern for the project. It is important to consider prior evaluations of the plant bioaccumulation pathway to determine if additional evaluations are needed. For example, if prior tests or evaluations are available, and project conditions and dredged material characteristics are unchanged, new evaluations may not be necessary.

### **9.2.1 Compilation and Evaluation of Existing Information**

The Tier I information generated in Chapter 3 is the technical basis for the Tier I evaluation of plant bioaccumulation. Because the Tier I plant (and animal) bioaccumulation evaluation relies more heavily on a risk assessment approach than the evaluation of the other pathways, the Tier I information from Chapter 3 is

organized and used in a risk assessment framework. The information is compiled and used as described for evaluation of animal bioaccumulation in Section 8.2.1. The project-specific conceptual site model developed for animal bioaccumulation is also used for plant bioaccumulation, with the obvious modifications to identify COC for plant bioaccumulation (which may be different from animal bioaccumulation COC) and reasonable potentially complete exposure routes involving plant bioaccumulation to ROC populations outside the CDF. The ROC populations outside the CDF for plant bioaccumulation will be the same as the ROC populations for animal bioaccumulation. The Tier I plant bioaccumulation evaluation emphasizes identification of complete exposure routes in the context of the conceptual site model. There can be no risk unless there is a complete exposure route by which a ROC can come into direct physiological contact with a COC.

### **9.2.2 Tier I - Evaluation Procedure**

A fundamental emphasis of the Tier I evaluation is on identification of complete exposure routes to ROC outside the CDF. Complete exposure routes are evaluated in Tier I if the available information is sufficient to make a decision, and if there is not sufficient information to support a decision, they are carried to subsequent tiers for more detailed evaluation. Incomplete exposure routes to ROC outside the CDF, and complete routes that clearly involve such minimal potential exposure as to pose negligible risk of unacceptable adverse effect, are documented and eliminated from further consideration.

A key to the evaluation of ecological impacts of plant bioaccumulation in Tier I, as well as in subsequent tiers, is the concept of effect as discussed in Section 2.2.4. Effects are generally evaluated at the population or higher level rather than at the level of individual organisms, except in the case of endangered species and humans, where individuals are of concern. If a reasonable complete exposure route to an ROC population outside the CDF exists, there is generally no risk of an effect unless there is potential for a sufficient number of individual organisms to be affected in a manner severe enough to threaten the long-term sustainability of viable local populations of the ROC species outside the CDF.

The conceptual site model constructed from existing Tier I information is examined. The site-specific COC and ROC for plant bioaccumulation are identified. Any reasonable, potentially complete exposure routes to ROC outside the CDF are described. Any incomplete exposure routes to ROC outside the CDF and any potentially complete routes that clearly involve such minimal potential exposure as to pose negligible risk of unacceptable adverse effect are described.

### **9.2.3 Tier I - Plant Bioaccumulation Decision**

After consideration of the Tier I plant bioaccumulation information in the context of the conceptual site model, one of the following conclusions is reached (Figure 9-1).

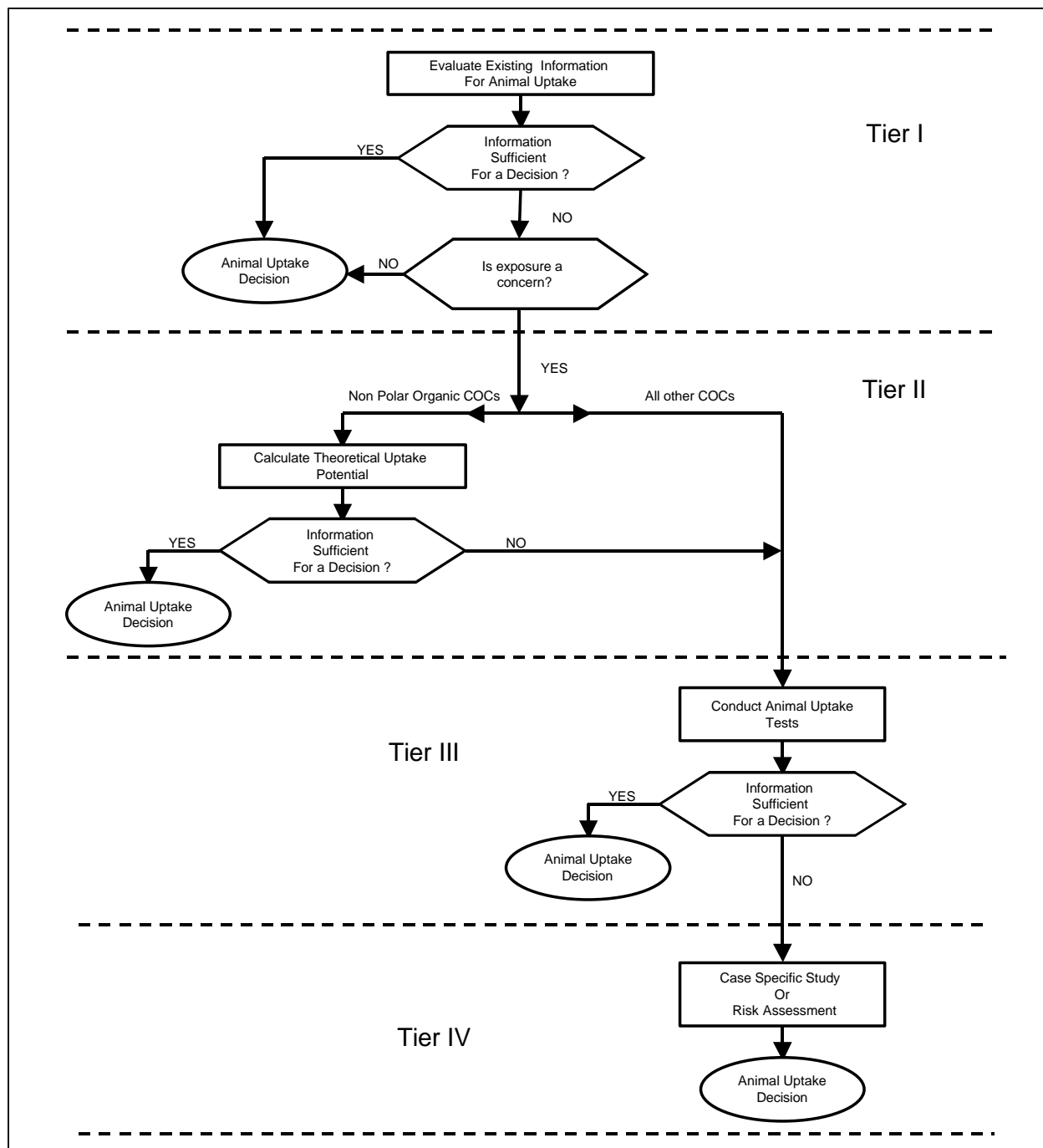

Figure 9-1. Flowchart illustrating tiered evaluation approach for the plant uptake pathway

1. Information is sufficient to reach a decision without further evaluation. This is the case if there are no reasonable, potentially complete exposure routes, or all potentially complete routes clearly involve such minimal potential exposure as to pose negligible risk of any effects, to ROC populations outside the CDF. No further evaluation of plant bioaccumulation is necessary.
2. Information is not sufficient to reach a decision regarding plant bioaccumulation. This is the case if there are potentially complete exposure routes that may pose a potential risk to ROC populations outside the CDF.

## **9.3 Tier II –Prediction of Plant Bioaccumulation Potential**

### **9.3.1 Tier II - Prescreen Evaluation of Field Plant Tissue**

Tier II provides a prescreening procedure that may be used in situations where (1) a CDF has historically received only dredged material from the project being evaluated, (2) there is reason to believe contaminant-related characteristics of the dredged material have not changed since the last placement of this material in the CDF, and (3) plants of the same species are established on the CDF and on nearby naturally occurring habitats that reflect environmental conditions that would have existed in the vicinity of the CDF if dredged material had never been placed there, but all other influences on environmental quality at the site had occurred. Under these circumstances, the same species of plants from the CDF and the similar nearby habitats may be sampled and analyzed for COC and their COC concentrations compared. If the COC concentrations in the plants from the dredged material do not statistically exceed the concentrations in the plants from the nearby habitats, this indicates that bioavailability of the COC from the dredged material is not greater than in surrounding habitat and there is no need for further evaluation. Other results indicate that further evaluation in Tiers II or III should be considered.

### **9.3.2 DTPA Procedure for Prediction of Plant Bioaccumulation Potential**

A simplified tool for the prediction of plant bioaccumulation of metals by plants is the extraction of metals from sediment using diethylenetriamine-pentaacetic acid (DTPA). The DTPA extraction procedure is described by Lee et al. (1978) and Folsom, Lee, and Bates (1981). The DTPA procedure has been used in a number of studies to successfully predict plant bioaccumulation from dredged material placed in terrestrial (wetland and upland) environments (Lee, Folsom, and Engler 1982; Lee, Folsom, and Bates 1983; U.S. Army Engineer Waterways Experiment Station 1987) and compared well with actual concentrations of metals in leaves of bioassay plants. Sediment from the proposed dredging project is extracted using the DTPA procedure in both the wet and air-dried conditions to represent wetland and terrestrial conditions in a CDF. Reference soil is also subjected to the DTPA extraction for comparison. The DTPA procedure can be applied directly to freshwater dredged material. For upland conditions, plant growth in dredged material from saltwater environments

effectively occurs only after the salts have been leached from the surface layer by precipitation. Therefore the DTPA can be applied to saltwater dredged material after the material has been prepared in the laboratory to reflect salt leached conditions.

Guidance for the DTPA extraction procedures is provided in Appendix H. Although DTPA extraction can only be used for evaluation of potential plant bioaccumulation of metals from freshwater dredged material, it is a useful procedure because metals are the most common COC for plant bioaccumulation. Because the DTPA is limited to metals, evaluation in a subsequent tier is necessary for plant bioaccumulation of all other COC. If there are COC other than metals, the DTPA should not be conducted and the plant bioaccumulation evaluation may proceed to Tier III.

### 9.3.3 Tier II - Plant Uptake Program (PUP)

A computerized program, the Plant Uptake Program (PUP) uses the results of the DTPA extraction procedure to predict bioaccumulation of metals from freshwater dredged material by freshwater plants and compare the results to a background or reference sediment or soil (Folsom and Houck 1990). The model requires total sediment metals concentrations, DTPA extraction data, sediment organic matter content, and the sediment pH in the condition of placement (wetland or terrestrial). The PUP program statistically compares the DTPA prediction of plant bioaccumulation from the dredged material to the prediction from the reference material to determine whether there is an indication of greater bioaccumulation from the dredged material than from the reference. Because the reference material is carefully selected to represent acceptable conditions, whatever bioaccumulation it may cause is an acceptable level of plant bioaccumulation. Although statistical significance, *per se*, cannot indicate environmental importance, a statistically significant increase above reference bioaccumulation has previously been considered to indicate a potential for effects, and that convention is followed in the Tiers II and III plant bioaccumulation in the UTM. The PUP program is described in <http://www.wes.army.mil/el/elmodels/pdf/ee-04-12.pdf> and the program can be downloaded from <http://www.wes.army.mil/el/elmodels/index.html>.

### 9.3.4 Tier II - Plant Bioaccumulation DTPA Decision

After consideration of the Tier II plant bioaccumulation information in the context of the conceptual site model and the complete exposure routes to ROC populations outside the CDF, one of the following conclusions is reached for nonpolar organic COC.

1. Information is sufficient to reach a decision regarding plant bioaccumulation. This is the case where the DTPA prediction of plant bioaccumulation from the dredged material is not statistically greater than the prediction from the reference material. No further evaluation of plant bioaccumulation is necessary.
2. Information is not sufficient to reach a decision regarding plant bioaccumulation. This is the case if the DTPA prediction of plant bioaccumulation from the dredged material is statistically greater than the

prediction from the reference material, or there are COC for plant uptake other than metals. Further evaluation in Tier III, or management actions as an alternative to further evaluation, should be considered. A decision to implement management actions for plant bioaccumulation by interrupting complete exposure routes to ROC outside the CDF may require more detailed information prior to design of such actions. If management actions are selected, no further evaluation of plant bioaccumulation is necessary.

## 9.4 Tier III – Plant Bioaccumulation Test

The Tier III plant bioaccumulation procedure involves growing index plants on the dredged material and reference soils and determining growth and bioaccumulation of COC. A photo of the test setup is shown in Figure 9-2. Two index plant species are available for use, depending on the dredged material and habitat tested. The procedure determines both the potential plant growth and the plant bioaccumulation of all COC. Plant growth is measured by the yield of aboveground tissue. Bioaccumulation is measured by the translocation and accumulation of COC into the aboveground tissues of the plant. The procedure applies to both marine and freshwater dredged material in both wetland and terrestrial habitat conditions. Detailed, step-by-step procedures are provided in Appendix I.



Figure 9-2. Photo of the plant bioassay test setup



### 9.4.1 Tier III - Plant Survival and Growth

The initial information of interest is whether or not plants will grow on the dredged material. This is usually not a concern with dredged material disposal in a CDF unless plant cover is part of the management strategy for aesthetics, to minimize surface water runoff, for habitat, or other reasons. Obviously, plant bioaccumulation would not be a concern if plants were unable to survive in the CDF because of toxicity from salts, metals or organic contaminants, low pH, or other plant-limiting soil conditions. However, toxicity to plants is a flag that may indicate a potential need to carefully manage the site to include possible control measures for other pathways such as surface runoff or animal bioaccumulation.

The procedure can be used to determine the plant growth on dredged material in both saturated (wetland) and air-dried (terrestrial) habitat conditions. Except for leaching of salts for the evaluation of saline dredged material under terrestrial conditions, no other processes to enhance plant growth are conducted. The specific use of index plants is described in the next section. A control sediment or soil is included in the test for the usual purposes of a laboratory control, and a reference sediment or soil is included to provide a point of comparison for evaluation of the test results.

### 9.4.2 Tier III - Plant Bioaccumulation of Contaminants

The plant bioaccumulation test procedure addresses geochemical changes in dredged material in a CDF and the subsequent bioaccumulation of COC by plants growing on the dredged material. The procedure is described by Folsom and Price (1989) for plants in freshwater dredged material under terrestrial and wetland habitat conditions, by Lee et al. (1992a, 1992b, 1993a and 1993b) for plants in saltwater dredged material under terrestrial habitat conditions, and by Lee et al. (2000) for plants in saltwater dredged material under wetland habitat conditions.

The plant bioaccumulation procedure consists of the exposure of index plants to dredged material and to a reference soil or sediment. The dredged material and reference material are (1) prepared to simulate wetland (saturated) habitat conditions, or (2) processed by drying and oxidation to simulate terrestrial habitat conditions, then planted with seedlings of the appropriate specie. *Spartina alterniflora* is used for saltwater wetland habitat conditions. *Cyperus esculentus* is used for saltwater terrestrial, freshwater wetland, and freshwater terrestrial habitat conditions. The procedure calls for growth of the plant through vegetative maturity on the sediment in an environmentally controlled greenhouse. Aboveground plant tissues are harvested and analyzed for COC concentrations.

Concentrations of COC in tissues of plants grown in the dredged material are statistically compared to the concentrations in tissues of plants in the reference material to determine whether there is an indication of greater bioaccumulation from the dredged material than from the reference. Because the reference material is carefully selected to represent acceptable conditions, whatever bioaccumulation it may cause is an acceptable level of plant bioaccumulation.

### 9.4.3 Tier III - Plant Bioaccumulation Decision

After consideration of the Tier III plant bioaccumulation information in the context of the conceptual site model and the complete exposure routes to ROC populations outside the CDF, one of the following conclusions is reached.

1. Bioaccumulation from the dredged material is not statistically greater than bioaccumulation from the reference material. No further evaluation of plant bioaccumulation is necessary.
2. Bioaccumulation from the dredged material is statistically greater than bioaccumulation from the reference material. Therefore the magnitude of potential effects on ROC populations outside the CDF must be considered, leading to a conclusion that either:
  - a. There is little potential for effects on ROC populations outside the CDF. No further evaluation of plant bioaccumulation is necessary.
  - b. Effects on ROC populations outside the CDF are likely, and management actions should be considered. A decision to implement management actions for plant bioaccumulation by interrupting complete exposure routes to ROC populations outside the CDF may require more detailed information prior to design of such actions. If management actions are selected, no further evaluation of plant bioaccumulation is necessary.
  - c. Information is not sufficient to reach a decision regarding plant bioaccumulation. Further evaluation in Tier IV, or management actions as an alternative to further evaluation, should be considered. A decision to implement management actions for plant bioaccumulation by interrupting complete exposure routes to ROC populations outside the CDF may require more detailed information prior to design of such actions. If management actions are selected, no further evaluation of plant bioaccumulation is necessary.

## 9.5 Tier IV – Plant Bioaccumulation Risk Assessment

### 9.5.1 Evaluation

The elimination of incomplete exposure pathways in Tier I and the elimination of COC that do not bioaccumulate to levels causing effects to ROC populations outside the CDF in Tiers II and III should have resolved most plant bioaccumulation issues for most dredged materials. Tier IV is intended to answer whatever specific, well-defined technical questions may remain unanswered after thorough evaluation in earlier tiers. If earlier tiers are used properly, Tier IV should rarely be necessary for navigation projects (Sections 2.1.4 and 2.1.5).

By the nature of the tiered evaluation approach, any technical questions that remain unresolved after Tier III can best be answered by a detailed, case-specific evaluation. By their very nature, detailed, case-specific evaluations are not amenable to the kind of generic guidance that can be presented in a national manual. They require individual design to address unique technical questions under site-specific conditions.

The best approach for Tier IV is usually a case-specific risk assessment. Detailed guidance for conducting risk assessments for CDFs in Tier IV can be found in Cura, Wickwire, and McArde (in preparation). The information generated in Tiers I through III should be used to the maximum extent technically justified throughout the Tier IV risk assessment.

### **9.5.2 Tier IV - Plant Bioaccumulation Decision**

After consideration of the Tier IV evaluation results, all relevant information is available and no further evaluation is possible. One of the following conclusions is reached.

1. No management actions are required.
2. Management actions should be considered. A decision to implement management actions for plant bioaccumulation by interrupting complete exposure routes to ROC populations outside the CDF may require more detailed information prior to design of such actions.

### **9.5.3 Plant Bioaccumulation Management Actions**

When there is concern about the potential for effects related to plant bioaccumulation, management actions related to the design, operation, and management of the CDF may be considered. In general, anything that interrupts a complete exposure route to ROC populations outside the CDF may act as an effective control of plant bioaccumulation. Therefore, the evaluation that identifies complete exposure routes will often also provide ideas for management actions that interrupt them. Additional information on management actions and references for detailed guidance on such actions are found in Chapter 10 of this manual.

## **9.6 References**

Cura, J., Wickwire, T., and McArde, M. "Ecological and human health risk assessment guidance for terrestrial environments," DOER Technical Report (in preparation), U.S. Army Engineer Research and Development Center, Vicksburg, MS.

Folsom, B. L., Jr., Lee, C. R., and Bates, D. J. (1981). "Influence of disposal environment on availability and plant uptake of heavy metals in dredged

material,” Technical Report EL-81-12, U.S. Army Engineer Waterways Experiment Station, Vicksburg, MS.

- Folsom, B. L., Jr., and Price, R. A. (1989). “A plant bioassay for assessing plant uptake of heavy metals from contaminated freshwater dredged material,” Technical Note EEDP-04-11. U.S. Army Engineer Waterways Experiment Station, Vicksburg, MS.
- Folsom, B. L., Jr., and Houck, M. H. (1990). “A computerized procedure for predicting plant uptake of heavy metals from contaminated freshwater dredged material,” Technical Note EEDP-04-12, U.S. Army Engineer Waterways Experiment Station, Vicksburg, MS.
- Lee, C. R., Smart, R. M., Sturgis, T. C., Gordon, R. N., and Landin, M. C. (1978). “Prediction of heavy metal uptake by marsh plants based on chemical extraction of heavy metals from dredged material,” Technical Report D-78-6, U.S. Army Engineer Waterways Experiment Station, Vicksburg, MS.
- Lee, C. R., Folsom, B. L., Jr., and Engler, R. M. (1982). “Availability and uptake of heavy metals from contaminated dredged material placed in flooded and upland disposal environments,” *Environment International* (7), 65-71.
- Lee, C. R., Folsom, B. L., Jr., and Bates, D. J. (1983). “Prediction of plant uptake of toxic metals using a modified DTPA soil extractant,” *The Science of the Total Environment*, (28), 191-202.
- Lee, C. R., Tatem, H. E., Brandon, D. L., Kay, S. H., Peddicord, R. K., Palermo, M. R., and Francingues, N. R., Jr. (1991). “A general decisionmaking framework for management of dredged material: Example application to Commencement Bay, Washington,” Miscellaneous Paper D-91-1, U.S. Army Engineer Waterways Experiment Station, Vicksburg, MS.
- Lee, C. R., Brandon, D. L., Tatem, H. E., Simmers, J. W., Skogerboe, J. G., Folsom, B. L., Jr., Price, R. A., Brannon, J. M., Brandon, D. L., Price, C. L., Averett, D. E., and Palermo, M. R. (1992a). “Evaluation of upland disposal of Oakland Harbor, California, sediment; Vol I: Turning basin sediments,” Miscellaneous Paper EL-92-12, U.S. Army Engineer Waterways Experiment Station, Vicksburg, MS.
- Lee, C. R., Brandon, D. L., Tatem, H. E., Simmers, J. W., Skogerboe, J. G., Price, R. A., Brannon, J. M., Palermo, M. R., and Myers, T. E. (1992b). “Evaluation of upland disposal of Oakland Harbor California, sediment; Vol. II: Inner and outer harbor sediments,” Miscellaneous Paper EL-92-12, U.S. Army Engineer Waterways Experiment Station, Vicksburg, MS.
- Lee, C. R., Brandon, D. L., Tatem, H. E., Simmers, J. W., Skogerboe, J. G., Price, R. A., Brannon, J. M., Myers, T. E., and Palermo, M. R. (1993a). “Evaluation of upland disposal of the J. F. Baldwin ship channel sediment,” Miscellaneous Paper EL-93-17, U.S. Army Engineer Waterways Experiment Station, Vicksburg, MS.

- Lee, C. R., Brandon, D. L., Tatem, H. E., Skogerboe, J. G., Brannon, J. M., Palermo, M. R., and Myers, T. E. (1993b). "Evaluation of upland disposal of Richmond Harbor, California, sediment from Santa Fe Channel," Miscellaneous Paper EL-93-18, U.S. Army Engineer Waterways Experiment Station, Vicksburg, MS.
- Lee, C. R., Brandon, D. L., Simmers, J. W., Tatem, H. E., and Price, R. A., (2000). "Evaluation of wetland creation with John F. Baldwin Ship Channel sediment," ERDC/EL SR-00-14, U.S. Army Engineer Research and Development Center, Vicksburg, MS.
- Price, R. A., Lee, C. R., and Simmers, J. W. (1999). "Phytoreclamation of dredged material: A working group summary," DOER Technical Notes TN-DOER-C9, U.S Army Engineer Research and Development Center, Vicksburg, MS.
- Schroeder, P. R., Lee, C. R., and Price, R. A. "Screening evaluations for confined disposal facility effluent quality," Environmental Effects of Dredging Technical Note (in preparation), U.S. Army Engineer Research and Development Center, Vicksburg, MS.
- Stafford, E. A., Simmers, J. W., Rhett, R. G., and Brown, C. P. (1991). "Interim report: Collation and interpretation of data for Times Beach Confined Disposal Facility," Miscellaneous Paper D-91-17, U.S. Army Engineer Waterways Experiment Station, Vicksburg, MS.
- U.S. Army Engineer Waterways Experiment Station. (1987). "Disposal alternatives for PCB-contaminated sediments from Indiana Harbor, Indiana; Vol. I: Main Report," Miscellaneous Paper EL-87-9, Vicksburg, MS.
- Winfield, L. E., and Lee, C. R. (1999). "Dredged material characterization tests for beneficial use suitability." DOER Technical Notes TN-DOER-C2, U.S Army Engineer Research and Development Center, Vicksburg, MS.

# 10 CDF Contaminant Management Actions

---

If the evaluations for one or more of the contaminant pathways indicate impacts for the proposed CDF design and placement option under consideration, management actions may be considered (USACE/EPA 1992). Management actions may include managing or modifying the proposed placement operation, modification of the CDF design or geometry, treatment of effluent, runoff, or leachate discharges, and physical management such as covers, liners, or barrier systems. Several studies have described these management actions and the degree to which they have been applied to CDFs (Averett, Perry, and Torrey 1990; USEPA 1994; National Research Council 1997; Permanent International Navigation Association (PIANC) 1996; Palermo and Averett 2000).

Since CDFs are a containment option, necessary management actions can be designed, constructed, and operated to meet requirements for even the most highly contaminated dredged sediments. For this reason, use of the CDF option *per se* would rarely be found technically infeasible.

In considering appropriate management actions, the influence of a given action on multiple pathways should be considered. For example, incorporating a surface cover of clean material as a final layer in the CDF may serve to reduce potential impacts of surface runoff, leachate and bioaccumulation pathways. Table 10-1 summarizes the applicability of various types of control measures management actions to each CDF pathway.

Once a management action is considered, the pathways influenced by that action should be reevaluated. The reevaluation would necessarily be an iterative process, as the reduction of the various pathway releases is considered.

Management Actions	Applicability to Pathways					
	Effluent	Runoff	Leachate	Volatiles	Animal	Plant
Operational controls	●	●	●	●		
Selective placement		●	●	●	●	●
Surface covers		●	●	●	●	●
Lateral barrier systems			●			
Bottom and side liners			●			
Treatment of discharges	●	●	●			
Sediment treatment		●	●	●	●	●

## 10.1 Operational Management Actions

If the CDF cannot be sized to provide sufficient clarification of effluent to meet applicable suspended solids/turbidity standards, control and treatment measures can be considered. Since a large portion of the total concentration of contaminants in effluents is associated with the suspended solids, reduction in the suspended solids also serves to control contaminant releases. Suspended solids removal therefore offers the greatest benefits in improving effluent quality not only by reducing turbidity but also by removing particulate-associated contaminants. Effluent quality may be improved by:

- Use of a smaller dredge with reduced inflow rate.
- Providing increased ponded area and depth of the CDF.
- Relocation of the inflow and effluent discharge points.
- Treatment or filtration of effluent to reduce the concentration of suspended solids and associated contaminants in the effluent.
- Treatment of effluent to remove dissolved contaminants.

Simply increasing the ponding depth will increase retention time in the pond for a given inflow rate. Restricting the inflow rate or consideration of intermittent pumping will also increase retention time. Relocation of inflow and weir locations may also increase the hydraulic settling efficiency of the site. Although these management actions are easy to implement, they will influence the production rate and may increase costs.

Site operations can also be used to manage CDFs to reduce the exposure of material through the surface water, volatilization, and leachate pathways. Management actions may include management of the water ponded in the CDF during and after disposal operations. Mobilization of contaminants from dredged material depends on the oxidation state of the solids. Most metals are much less mobile when maintained in an anaerobic reduced condition. On the other hand, aerobic sediments generally improve conditions for biodegradation of organic contaminants. Aerobic sediments generally present the greatest potential for

volatilization of contaminants. Whether to cultivate or inhibit plant and animal propagation is also an issue. Management of the site both during filling and after disposal requires a comprehensive understanding of the migration pathways and the effects various management actions have on the overall mass balance and rate of contaminant releases. The decision to apply certain management actions requires trade-offs for the site and contaminant-specific conditions for the project.

Selective placement is another management action especially useful for control of the leachate pathway. Options include:

- Sequencing or sandwiching with alternating layers of clean and contaminated material to provide for attenuation (sorption, ion exchange, filtration, biodegradation, etc.) or containment of contaminants.
- Self-sealing/self-lining taking advantage of the fine-grained nature of dredged material which yields low permeability when subjected to consolidation in a CDF.
- Placing dredged material with suitable chemical and physical properties as the final layer in a CDF, forming a *de facto* cover.
- Placement of sand layers to enhance dewatering and consolidation.
- Control of ponded water to reduce hydrostatic head or maintain a negative hydraulic gradient, causing seepage flow into the CDF as opposed to flow from the CDF.

## 10.2 Treatment of Effluent, Runoff, and Leachate Discharges

For CDF liquid streams, the solids remaining will be clay or colloidal size material that may require flocculants to promote further settling in clarifiers or sedimentation ponds. Chemical clarification using organic polyelectrolytes is a proven technology for CDF effluents (Schroeder 1983; Schroeder and Shields 1983, HQUSACE 1987). Filtration, permeable dikes, sand-filled weirs, and wetlands have also been used on occasion for CDF demonstrations or pilot evaluations.

## 10.3 Engineered Control Measures

Site controls (e.g., surface covers and liners) can be effective management actions applied at a CDF to prevent migration of contaminants from the dredged material (Cullinane et al. 1986; Averett, Perry, and Torrey 1990). There are few CDFs where operational or physical management actions have been implemented. Most of these sites are associated with sediment remediation projects, which involve more highly contaminated sediments than normally associated with navigation projects (Palermo and Averett 2000). The implementability and effectiveness of these management actions is highly specific to the CDF location



and the dredged material characteristics. Use of management actions such as liners, slurry walls, groundwater pumping, and subsurface drainage can be considered for CDFs. Graded stone dikes with low-permeability cores or steel sheet-pile cutoffs have been used or proposed at CDFs to control leachate migration. The low permeability of fine-grained sediments following compaction can reduce the need for liners in many cases, but it can also limit the effectiveness and implementability of groundwater pumping and subsurface drainage.

### **10.3.1 Barrier systems**

Barriers are layers of low-permeability materials designed to prevent vertical or lateral migration of water and minimize groundwater contamination. Soil barriers can use natural geologic formations of low-permeability material if available at a site or constructed layers. Barrier systems might utilize soils, synthetic membranes, grout mattresses, and slurry walls.

### **10.3.2 Surface covers**

A surface cover is a barrier layer placed on top of a filled CDF. The term surface cover is used here to describe both a cap and cover layer for CDFs to distinguish this option from a subaqueous cap as used for contaminant control in the aquatic environment. A cover can be highly effective in reducing leachate generation by avoiding precipitation infiltration, isolation from bioturbation and uptake by plants and animals, limiting direct human contact, minimizing volatilization of contaminants from the surface, and eliminating detachment and transport of contaminants by precipitation and runoff. A layer of clean material can achieve the last three benefits mentioned. However, prevention of infiltration requires a barrier of very low permeability, such as a flexible membrane or a compacted clay layer, both of which are not easily or reliably implemented for CDFs.

### **10.3.3 Liners**

Liners are commonly considered as a leachate or seepage control measure and can be placed on the sides and bottom of a CDF. However, liners have not been used extensively for contaminated dredged material sites because of the inherent low permeability of fine-grained dredged material, the retention of contaminants on solids, and the difficulty and expense of construction of a reliable liner system for wet dredged material.

Liners may be designed using utilize soils, synthetic membranes, or grout mattresses. Fine-grained sediments may have permeabilities comparable to clay barriers following compaction. Leachate collection systems and groundwater pumping systems may also be considered in conjunction with liners to control leachate.

## 10.4 Treatment of Dredged Material Solids

Various treatment processes have been investigated for dredged material treatment, including biological, chemical, extraction, immobilization, and thermal processes. Dredged material may be treated at a temporary rehandling facility, with the treated material subsequently transported to an ultimate disposal facility. Treatment can also be considered for a smaller portion of the total volume of material to create stabilized material for use in constructing liners, covers, etc.

A variety of process options are potentially available for each type of technology; however, prior to recent demonstration programs and Superfund cleanups, only a limited number of treatment technologies had actually been applied on a pilot scale or full scale. The base of experience for treatment of contaminated sediment is still very limited.

## 10.5 Guidance for CDF Management Actions

Guidance for design, construction, and operation of CDF contaminant controls is available in Engineer Manual 1110-2-5027 (HQUSACE 1987), USACE Environmental Effects of Dredging Programs (EEDP) technical notes (<http://www.wes.army.mil/el/dots/eedptn.html>), and USACE Dredging Operations and Environmental Research (DOER) technical notes (<http://www.wes.army.mil/el/dots/doer/technote.html>). EPA guidance on control measures is also available (USEPA 1994). All available information on CDF controls is also being incorporated in a combined Engineer Manual 1110-2-5028, Dredging and Dredged Material Management (HQUSACE in preparation), which is to be published on the internet and periodically updated. These references contain testing procedures and criteria needed for evaluating and selecting appropriate contaminant control measures for CDFs and should be consulted for additional detailed discussions of the attributes of the various technologies.

## 10.6 References

- Averett, D. E., Perry, B. D., and Torrey, E. J. (1990). "Review of removal, containment and treatment technologies for remediation of contaminated sediment in the Great Lakes," Miscellaneous Paper EL-90-25, U.S. Army Engineer Waterways Experiment Station, Vicksburg, MS.
- Cullinane, J., Averett, D., Shafer, R., Male, J., Truitt, C., and Bradbury, M. (1986). "Guidelines for selecting control and treatment options for contaminated dredged material requiring restrictions," Report prepared for the U.S. Army Engineer District, Seattle, Puget Sound Dredged Disposal Analysis, by the U.S. Army Engineer Waterways Experiment Station, Vicksburg, MS.
- Headquarters, U.S. Army Corps of Engineers. (1987). "Confined disposal of dredged material," Engineer Manual 1110-2-5027, Washington, DC.

- Headquarters, U.S. Army Corps of Engineers. "Dredging and dredged material management," Engineer Manual (in preparation), Washington, DC.
- National Research Council. (1997). *Contaminated Sediments in Ports and Waterways*, National Academy Press, Washington, DC. (Available from National Academy Press <http://www.nap.edu/bookstore>)
- Palermo, M. R., and Averett, D. E. (2000). "Confined disposal facility (CDF) containment measures: A summary of field experience," DOER Technical Notes Collection (ERDC TN-DOER-C18), U.S. Army Engineer Research and Development Center, Vicksburg, MS. [www.wes.army.mil/el/dots/doer](http://www.wes.army.mil/el/dots/doer)
- Permanent International Association of Navigation Congresses. (1996). "Handling and treatment of contaminated dredged material from ports and inland waterways - CDM," Report of Working Group No. 17 of the Permanent Technical Committee I, Permanent International Association of Navigation Congresses, Brussels, Belgium. (In two volumes, available on CD from PIANC - <http://www.tornado.be/~navigation-aipcn-pianc/part06.htm>)
- \_\_\_\_\_. "Guidelines for marine, nearshore, and inland confined disposal facilities," (in preparation), Report of Working Group No. 5 of the Permanent Environmental Committee, Permanent International Association of Navigation Congresses, Brussels, Belgium.
- Shroeder, P. R. (1983). "Chemical clarification methods for confined dredged material disposal," Technical Report D-83-2, U.S. Army Engineer Waterways Experiment Station, Vicksburg, MS.
- Shroeder, P. R., and Shields, F. D. (1983). "Chemical clarification of dredged material," *Journal of Environmental Engineering*, 109 (2).
- U.S. Army Corps of Engineers/Environmental Protection Agency. (1992). "Evaluating environmental effects of dredged material management alternatives — A technical framework," EPA 842-B-92-008, Office of Water, Washington, DC.
- U.S. Environmental Protection Agency (USEPA). (1994). "Assessment and remediation of contaminated sediments (ARCS) program - remediation guidance document," EPA 905-R94-003, U.S. Environmental Protection Agency, Great Lakes National Program Office, Chicago, IL. <http://www.epa.gov/glnpo/arcs/EPA-905-B94-003/EPA-905-B94-003-toc.html>

# Appendix A

## Glossary

---

**Attenuation** – A reduction in concentration of a contaminant with increasing distance from the source. Attenuation is specifically used in this document to describe reductions in leachate concentrations as a result of mixing with groundwater, adsorption of contaminants in foundation soils, degradation, volatilization, and precipitation.

**Aquatic habitat** – Bodies of water that serve as habitat for plants and animals.

**Background sediment or soil** – Sediment used as a point of comparison for plant and animal bioaccumulation evaluations.

**Beneficial uses** – Placement or use of dredged material for some productive purpose. Beneficial uses may involve either the dredged material or the placement site as the integral component of the beneficial use.

**Bioaccumulation** – The accumulation of contaminants in the tissues of plants or animals through any route, including respiration, ingestion, or direct contact with contaminated water, sediment, or dredged material.

**Complete exposure route** – A set of chemical, biological, and/or physical processes by which a receptor of concern (ROC) can come into direct physiological contact with a contaminant of concern (COC).

**Confined disposal** – Placement of dredged material within a confined disposal facility (CDF). Confined disposal as used in the UTM does not refer to subaqueous capping or contained aquatic disposal.

**Confined disposal facility (CDF)** – An engineered structure consisting of dikes or other structures that extend above any adjacent water surface and enclose a disposal area for containment of dredged material, isolating the dredged material from adjacent waters or land. Other terms used for CDFs that appear in the literature include “confined disposal area,” “confined disposal site,” and “dredged material containment area.” In the context of the UTM, CDFs may be constructed in upland, nearshore, or island location types, and a CDF in any type of location may contain terrestrial, wetland, or aquatic habitat.

**Conservative** – Tending to over-estimate the potential for effects, or err on the side of environmental protection.

**Contaminant** – A chemical or biological substance in a form that can be incorporated into, onto, or be ingested by organisms, consumers of organisms, or users of the environment.

**Contaminants of concern (COC)** – Contaminants present in dredged material that have the potential to affect receptors of concern (ROC) under the project-specific conditions.

**Control sediment or soil** – Material used in plant or animal bioaccumulation evaluations to ensure that extraneous factors do not affect the results.

**Criteria** – Laboratory derived values from which standards are developed.

**Diffusion** – The transport of contaminants by random molecular motion and turbulence.

**Dispersion** – The transport and dilution of contaminants and/or suspended particles in air or water by the combined effects of shear and diffusion. Dispersion is specifically used in this document to describe dilution of volatile emissions in air.

**Discharge** – See Dredged material discharge

**Disposal** – See Confined disposal.

**Disposal site or area** – A precise geographical area within which disposal of dredged material occurs.

**Dredged material** – Material excavated from waters of the United States or ocean waters. The term dredged material refers to material which has been dredged from a water body, while the term sediment refers to material in a water body prior to the dredging process.

**Dredged material discharge** – In the context of this document, any addition of dredged material into waters of the United States or ocean waters. The term includes discharges from confined disposal facilities that enter waters of the United States.

**Effect** – In the context of this document, a measurable response of an organism to a contaminant.

**Effluent** – Water that is discharged from a confined disposal facility during and as a result of the filling or placement of dredged material.

**Elutriate** – A sample generated by washing contaminants from a sediment sample using water, usually by mixing water with the sediment, allowing the sediment to settle, and extracting the sample from the overlying water. In this document, the effluent elutriate test is designed to simulate the release of contaminants from CDFs in effluent discharged during filling operations.

**Environmental assessment (EA)** – A document presenting an environmental impact analysis prepared in response to NEPA.

**Environmental impact statement (EIS)** – A document prepared in response to NEPA presenting a more rigorous environmental impact analysis than that required by an EA.

**Exposure** – The degree of accessibility of a contaminate to an organism.

**Habitat** – The specific area or environment in which a particular type of plant or animal lives. An organism's habitat provides all of the basic requirements for the maintenance of life. Typical coastal habitats include beaches, marshes, rocky shores, bottom sediments, mudflats, and the water itself. The UTM considers terrestrial, wetland, and aquatic habitats.

**Leachate** – Water or any other liquid that may contain dissolved materials such as organic or mineral salts leached from a solid material, and leaves a CDF by seepage through the dikes or foundation. For example, precipitation that percolates through a CDF, picks up dissolved contaminants and leaves the site is considered leachate.

**Major Federal action** – Includes actions with effects that may be major and that are potentially subject to Federal control and responsibility. Major refers to the context (meaning that the action must be analyzed in several contexts, such as the effects on the environment, society, regions, interests, and locality) and intensity (meaning the severity of the impact). It can include (a) new and continuing activities, projects, and programs entirely or partly financed, assisted, conducted, regulated, or approved by Federal agencies; (b) new or revised agency rules, regulations, plans, policies, or procedures; and (c) legislative proposals. Action does not include funding assistance solely in the form of general revenue-sharing funds where there is no Federal agency control over the subsequent use of such funds. Action does not include judicial or administrative civil or criminal enforcement action.

**Management action** – Activities that may be considered necessary to control or reduce the potential physical, chemical, or biological effects of dredged material disposal outside a CDF. These management actions may include: operational controls, such as limiting the inflow rate or increasing the depth or retention time of water ponded in the CDF; physical control measures for containment of contaminants, such as surface cover layers, liners or low-permeability dike cores; treatment for discharges such as effluent, runoff, or collected leachate; and biological measures such as management of plants and animals.

**Mixing** – The dilution or mingling of a discharge of water within receiving waters. Mixing is used specifically in this document to describe dilution of effluent or runoff discharges in surface waters.

**Mixing zone** – A limited volume of water serving as a zone of initial dilution in the immediate vicinity of the discharge point where receiving water quality may not meet quality standards or other requirements otherwise applicable to the receiving water. The mixing zone should be considered as a place where wastes and water mix and not as a place where wastes are treated.

**Nearshore** – Adjacent to a shoreline.

**NEPA** – National Environmental Policy Act (40 CFR 1500-1508)

**Pathway** – A route by which contaminants may leave a CDF.

**Polluted dredged material** – Dredged materials that have been demonstrated to impair the designated use of a water body.

**Receptors of concern** – Humans, organisms, or other resources that have the potential to be affected by contaminants of concern (COC) under the project-specific conditions.

**Reference Sediment or Soil** – A soil or sediment that reflects environmental conditions that would have existed in the vicinity of a CDF if dredged material had never been placed there, but all the other influences on environmental quality at the site had occurred.

**Risk assessment** – A procedure for evaluating and managing risk.

**Runoff** – The liquid fraction of dredged material or the surface flow caused by precipitation on upland or nearshore dredged material disposal sites.

**Screen** – A procedure that has been demonstrated to have (1) some operational advantage such as ease of conduct, low cost, short completion time, etc. and (2) a low incidence of false indications of no environmental effect (low false negatives), although it may have a higher incidence of false indications of potential environmental effect (false positives). As a result of the second characteristic, screening procedures can identify projects with little potential for effects and projects for which more information is needed to make a decision, but cannot identify projects that have a potential for effects.

**Sediment** – Material, such as sand, silt, or clay, suspended in or settled on the bottom of a water body. Sediment input to a body of water comes from natural sources, such as erosion of soils and weathering of rock, or as the result of anthropogenic activities, such as forest or agricultural practices, or construction activities. The term dredged material refers to material, which has been dredged from a water body, while the term sediment refers to material in a water body prior to the dredging process.

**Standard** – A legally enforceable measure of an unacceptable effect.

**Suspended solids** – Organic or inorganic particles that are suspended in water. The term includes sand, silt, and clay particles as well as other solids, such as biological material, suspended in the water column.

**Terrestrial habitat** – Habitat where the soil is typically unsaturated and aerobic.

**Theoretical bioaccumulation potential (TBP)** – A screening tool to estimate the uptake of nonpolar organics by animals.

**Toxicity** – Level of mortality or other end point demonstrated by a group of organisms that have been affected by the properties of a substance, such as contaminated water, sediment, or dredged material.

**Turbidity** – An optical measure of the amount of material suspended in the water. Increasing the turbidity of the water decreases the amount of light that penetrates the water column.

**Upland habitat** – The geochemical environment in which dredged material becomes unsaturated, dried, and oxidized, and supports terrestrial plants and animals.

**Volatiles** – Chemical substances which move from solid or liquid substrates into the atmosphere.

**Vadose Zone** – A subsurface zone that is unsaturated and aerobic, containing capillary water and air or gases at atmospheric pressure.

**Wetlands** – Areas that are inundated or saturated by surface or ground water at a frequency and duration sufficient to support, and that, under normal circumstances, do support a prevalence of vegetation typically adapted for life in saturated-soil conditions. Wetlands generally include swamps, marshes, bogs, and similar areas.



# Appendix B

## Column Settling Test and Effluent Elutriate Procedures

---

### B.1 Introduction

This appendix provides detailed step-by-step procedures for conducting tests for evaluation of confined disposal facility (CDF) effluent. The background, rationale, and tiered framework for application of these procedures are discussed in Chapter 4 of the main text of the Upland Testing Manual (UTM). Three test procedures are included in this appendix:

- a.* Effluent elutriate tests for water quality evaluations.
- b.* Effluent elutriate tests for water column toxicity evaluations.
- c.* Long-tube column settling tests used to evaluate effluent total suspended solids (TSS) concentrations and total concentrations of contaminants of concern (COC) in effluent.

### B.2 Effluent Elutriate Tests for Water Quality Evaluation

The effluent elutriate test<sup>1</sup> is designed to simulate the quality of water discharged as effluent from a CDF and accounts for geochemical changes occurring in the CDF during active disposal operations. Test procedures allow for estimates of dissolved contaminant concentrations in milligrams per liter and fractions of contaminants in the TSS in milligrams per kilogram suspended solids

---

<sup>1</sup> The effluent elutriate is also called the “modified elutriate” in the literature to distinguish the procedure from the “standard elutriate” test, which is applicable to open water discharges. To avoid confusion, the term “effluent elutriate” is used in this manual and the Inland Testing Manual (ITM), and the term “open water elutriate” has been adopted for open water evaluations described in the ITM.

(SS) under quiescent settling conditions. The test consists of mixing a sediment sample with dredging site water to form a slurry, allowing the slurry to settle under conditions equivalent to those in a CDF, then extracting an effluent elutriate sample for chemical analysis. Field verification studies have shown that the effluent elutriate test is a conservative predictor of CDF effluent quality (Palermo 1985a-d; Palermo and Thackston 1988a and b).

The effluent elutriate tests should be conducted, and appropriate chemical analyses should be performed as soon as possible after sample collection. If effluent elutriate tests for both water quality and toxicity evaluations are to be conducted, sufficient effluent elutriate should be prepared for both purposes. The volume of effluent elutriate needed for water quality evaluations will vary depending upon the number and types of chemical analyses to be conducted. Both dissolved and total concentrations of contaminants may be determined. The volume required for each analysis, the number of variables measured, and the desired analytical replication will influence the total elutriate sample volume required. A 4-L cylinder is normally used to prepare the elutriate, and the supernatant volume available for sample extraction will vary from approximately 500 to 1,000 mL, depending on the sediment properties, settling times, and initial concentration of the slurry. It may be necessary to composite several extracted sample volumes or to use large diameter cylinders to obtain the total required volume.

### **B.2.1 Apparatus**

The following items are required:

- a.* Laboratory mixer, preferably with Teflon shaft and blades.
- b.* Several 4-L graduated cylinders. Larger cylinders may be used if large sample volumes are required for analytical purposes. Nalgene cylinders are acceptable for testing involving analysis of inorganic compounds such as metals and nutrients. Glass cylinders are required for testing involving analysis of organic compounds.
- c.* Assorted glassware for sample extraction and handling.
- d.* Compressed air source with deionized water trap and tubing for bubble aeration of slurry.
- e.* Vacuum or pressure filtration equipment, including vacuum pump or compressed air source and an appropriate filter holder capable of accommodating 47-, 105-, or 155-mm-diam filters.
- f.* Presoaked filters with a 0.45- $\mu$ m pore-size diameter.
- g.* Plastic sample bottles, 500-mL capacity for storage of water and liquid phase samples for metal and nutrient analyses.

- h. Wide-mouth, 1-gal capacity glass jars with Teflon-lined screw-type lids for sample mixing. These jars should also be used for sample containers when samples are to be analyzed for organic COC.

Prior to use, all glassware, filtration equipment, and filters should be thoroughly cleaned. Wash all glassware with detergent, rinse five times with tap water, place in a clean 10-percent (or stronger) HCl acid bath for a minimum of 4 hr, rinse five times with tap water, and then rinse five times with distilled or deionized water. Soak filters for a minimum of 2 hr in 5 molar HCl bath, and then rinse 10 times with distilled water. It is also a good practice to discard the first 50 mL of filtrate.

### B.2.2 Effluent elutriate test procedure

The step-by-step procedure for conducting the effluent elutriate test (Figure B-1) is outlined below.

**Step 1 - Slurry preparation.** The sediment and water from the proposed dredging site should be mixed to a concentration approximately equal to the expected average field inflow concentration. If estimates of the average field inflow concentration cannot be made based on past data, a slurry concentration of 150 g/L (dry weight basis) should be used. Predetermine the concentration of the well-mixed sediment in grams per liter (dry weight basis) by oven drying a small subsample of known volume. Each 4-L cylinder to be filled will require a mixed slurry volume of 3-3/4 L. The volumes of sediment and water to be mixed for a 3-3/4-L slurry volume may be calculated using the following expressions:

$$V_{\text{sediment}} = 3.75 \frac{C_{\text{slurry}}}{C_{\text{sediment}}} \quad (\text{B-1})$$

and

$$V_{\text{water}} = 3.75 - V_{\text{sediment}} \quad (\text{B-2})$$

where

$V_{\text{sediment}}$  = volume of sediment, in L

3.75 = volume of slurry for 4-L cylinder, L

$C_{\text{slurry}}$  = desired concentration of slurry, g/L (dry weight basis)

$C_{\text{sediment}}$  = predetermined concentration of sediment, g/L (dry weight basis)

$V_{\text{water}}$  = volume of disposal site water, in L

**Step 2 - Mixing.** Mix the 3-3/4 L of slurry by placing appropriate volumes of sediment and water from the proposed dredging site in a 1-gal glass jar and

mixing for 5 min with the laboratory mixer. The slurry should be mixed to a uniform consistency, with no unmixed agglomerations of sediment.

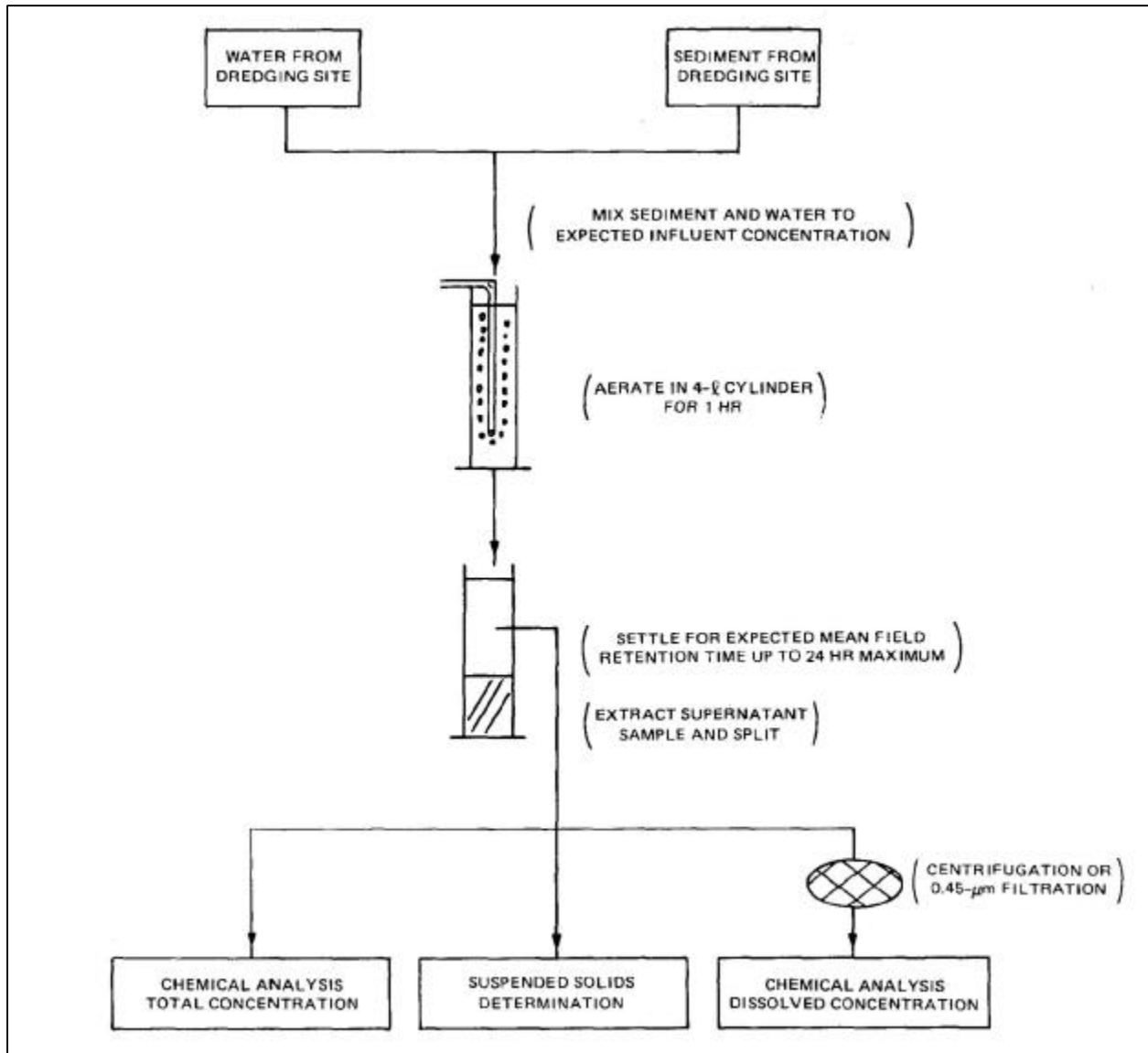

Figure B-1. Schematic of Effluent Elutriate Test

<b>Table B-1 Recommended Resuspension Factors for Various Poned Areas and Depths</b>		
<b>Anticipated Poned Area</b>	<b>Resuspension Factor for Anticipated Average Poned Depth</b>	
	<b>Less than 2 ft</b>	<b>2 ft or Greater</b>
Less than 100 acres	2.0	1.5
Greater than 100 acres	2.5	2.0

**Step 3 - Aeration.** The prepared slurry must be aerated to ensure that oxidizing conditions will be present in the supernatant water during the subsequent settling phase. Bubble aeration is therefore used as a method of sample agitation. Pour the mixed slurry into a 4-L graduated cylinder. Attach glass tubing to the aeration source and insert the tubing to the bottom of the cylinder. The tubing can be held in place by insertion through a predrilled No. 4 stopper placed in the top of the cylinder. Compressed air should be passed through a deionized water trap, through the tubing, and bubbled through the slurry. The flow rate should be adjusted to agitate the mixture vigorously for 1 hr.

**Step 4 - Settling.** Remove the tubing, and allow the aerated slurry to undergo quiescent settling for a time equal to the anticipated field mean retention time, up to a maximum of 24 hr. If the field mean retention time is not known, allow settling for 24 hr.

Field mean retention time  $T_d$  can be estimated for a given flow rate and ponding conditions by applying a hydraulic efficiency correction factor (HECF) to the theoretical detention time as follows:

$$T_d = \frac{T}{(HECF)} \quad (B-3)$$

where

$T_d$  = mean detention time, hr

$T$  = theoretical detention time, hr

HECF = hydraulic efficiency correction factor (HECF > 1.0) defined as the inverse of the hydraulic efficiency

The theoretical detention time is calculated as follows:

$$T = \frac{V_p}{Q_i} (12.1) = \frac{A_p D_p}{Q_i} (12.1) \quad (B-4)$$

where

$V_p$  = volume ponded, acre-ft

$Q_i$  = average inflow rate, cfs

$A_p$  = area ponded, acres

$D_p$  = average depth of ponding, ft

12.1 = conversion factor, acre-ft/cfs to hr

The hydraulic efficiency correction factor HECF can be estimated by several methods. The most accurate estimate is that made from dye tracer studies to

determine  $T_d$  at the actual site under operational conditions at a previous time, with the conditions similar to those for the operation under consideration. This approach can be used only for existing sites.

Alternatively, the ratio  $T_d/T = 1/\text{HECF}$  can be estimated from the equation:

$$\frac{T_d}{T} = 0.9 \left[ 1 - \exp \left( -0.3 \frac{L}{W} \right) \right] \quad (\text{B-5})$$

where  $L/W$  is the length-to-width ratio of the proposed basin.

The  $L/W$  ratio can be increased greatly by the use of internal spur dikes, resulting in a higher hydraulic efficiency and a lower required total area. In the absence of dye tracer data or values obtained from other theoretical approaches, a value for HECF of 2.25 may be used based on field studies conducted at several sites (Montgomery, Thackston, and Parker 1983).

**Step 5 - Sample extraction.** After the appropriate period of quiescent settling, an interface will usually be evident between the supernatant water, with a low concentration of suspended solids above, and the more concentrated settled material below the interface. Samples of the supernatant water should be extracted from the cylinder at a point midway between the water surface and interface using syringe and tubing. Care should be taken not to resuspend the settled material.

**Step 6 - Sample preservation and analyses.** The sample should be analyzed as soon as possible after extraction. If applicable water quality standards are in terms of dissolved concentrations, the elutriate samples should be analysed for dissolved concentrations of COC. If applicable water quality standards are in terms of total or whole water concentrations, the elutriate samples should be split and analysed for both dissolved and total concentrations of COC, and for total suspended solids in milligrams per liter. This will allow the calculation of the fraction of analytes in the total suspended solids in milligrams per kilogram SS. Filtration using 0.45-um filters should be used to obtain subsamples for analysis of dissolved concentrations. Samples to be analyzed for dissolved pesticides or polychlorinated biphenyls (PCBs) must be free of particles but should not be filtered because of the tendency for these materials to adsorb on the filter. However, particulate matter can be removed before analysis by high-speed centrifugation at 10,000 times gravity using Teflon, glass, or aluminum centrifuge tubes (Fulk, Gruber, and Wullschleger 1975). The total suspended solids concentration can also be determined by filtration (0.45 um).

### B.2.3 Chemical analyses

Chemical analyses of the effluent elutriate samples should be performed according to the guidance in Chapter 9 of the ITM (USEPA/USACE 1998).

## B.2.4 Effluent contaminant concentrations

**Dissolved concentrations.** If applicable water quality standards are defined in terms of dissolved concentrations, the dissolved concentrations of COC in the effluent elutriate (determined directly from the test) and may be compared with the standards after consideration of mixing.

**Calculation of total concentrations.** If applicable water quality standards are defined in terms of total or whole water concentrations, calculations of the fractions of contaminants in the total suspended solids and the total concentrations in the effluent are required. The fraction of COCs in the total suspended solids may be calculated in terms of milligrams per kilogram SS as follows:

$$F_{SS} = (1 \times 10^6) \frac{C_{total} - C_{diss}}{SS} \quad (B-6)$$

where

$F_{SS}$  = fraction of analyte in the total suspended solids, mg analyte/kg of suspended solids

$C_{total}$  = total concentration, mg analyte/L of sample

$C_{diss}$  = dissolved concentration mg, analyte/L of sample

$SS$  = total suspended solids concentration, mg solids/L of samples

The calculation of total concentration of COCs in the effluent is based on results of both the elutriate test and an estimate of effluent TSS under the anticipated operating conditions for the CDF. The total COC concentration in milligrams per liter in the effluent may be estimated as:

$$C_{total} = C_{diss} \frac{F_{SS} S_{eff}}{(1 \times 10^6)} \quad (B-7)$$

where

$C_{total}$  = estimated total concentration in effluent, mg analyte/L of water

$C_{diss}$  = dissolved concentration determined by effluent elutriate tests, mg analyte/L of sample

$F_{SS}$  = fraction of analyte in the total suspended solids calculated from effluent elutriate results, mg analyte/kg of suspended solids

$SS_{eff}$  = suspended solids concentration of effluent estimated from evaluation of sedimentation performance, mg suspended solids/L of water (this may be determined by a long column settling test as described in Section B.3).

$(1 \times 10^6)$  = conversion factor, mg/mg to mg/kg

## B.3 Effluent Elutriate for Water Column Toxicity

For effluent toxicity evaluations, an effluent elutriate for the suspended phase is prepared and used as a test medium for water column toxicity tests. This procedure is essentially the same as that for water quality evaluations, except that the elutriate sample is handled differently following extraction. The volume of effluent elutriate required for toxicity testing will be influenced by the number of species to be tested, their size, and requirements for water change during the test. A 4-L cylinder is normally used to prepare the effluent elutriate, and the resulting supernatant volume will vary from approximately 500 to 1,000 mL, depending on the sediment properties, settling times, and initial concentration of the slurry. It may be necessary to composite several extracted sample volumes or to use large diameter cylinders to obtain the total required volume.

### B.3.1 Effluent elutriate apparatus

The apparatus necessary for preparation of effluent elutriate is described in Section B.2.1. However, for biological testing the effluent elutriate is not filtered, so only items a through d are required to prepare effluent elutriate for toxicity testing.

Prior to use, all glassware should be thoroughly cleaned. Wash all glassware with detergent, rinse five times with tap water, place in a clean bath for a minimum of 4 hr, rinse five times with tap water, and then rinse five times with distilled or deionized water.

### B.3.2 Effluent elutriate procedure

The step-by-step procedure for preparing the effluent elutriate for use in toxicity tests is outlined below.

**Step 1 - Slurry preparation.** Same as Section B.2.2.

**Step 2 - Mixing.** Same as Section B.2.2.

**Step 3 - Aeration.** Same as Section B.2.2.

**Step 4 - Settling.** Same as Section B.2.2.

**Step 5 - Sample extraction.** After the appropriate period of quiescent settling, an interface will usually be evident between the supernatant water, with a low concentration of suspended solids above, and the more concentrated settled material below the interface. The liquid plus the material remaining in suspension after the settling period represents the 100 percent effluent for toxicity testing. Carefully siphon the supernatant, without disturbing the settled material, and immediately use it for toxicity testing. The suspension should be clear enough at the first observation time for the organisms to be visible. With some very fine-grained dredged materials, it may be necessary to centrifuge the supernatant for a short time to achieve this.

Effluent toxicity tests should be performed according to the guidance in Chapter 11 of the ITM (USEPA/USACE 1998), using the effluent elutriate prepared as described in this section as the test medium. Results should be evaluated in light of mixing considerations, as discussed in Chapter 4 of the UTM.



### **B.3.3 Effluent Elutriate Toxicity Evaluation**

The end result of this evaluation is the 96-hr LC50 or 96-hr EC50 expressed as a percentage of the suspended dredged material concentration (or 100 percent elutriate). This result is then compared with the concentration of the suspended dredged material at the boundary of the allowable mixing zone.

## **B.4 Column Settling Tests for Effluent TSS/ Turbidity**

If turbidity or SS are identified as COCs, or if water quality standards (WQS) are specifically defined in terms of whole water (total) concentrations of COCs, settling tests are necessary to provide data for design or evaluation of disposal areas for retention of suspended solids and to compare to WQS (Figure B-2). These tests are designed to define the settling behavior of a particular sediment and to provide information concerning the volumes occupied by newly placed layers of dredged material. If WQS exist for turbidity, a sediment-specific correlation of suspended solids and turbidity must be developed (Thackston and Palermo 2000).

Sedimentation of freshwater slurries (mixtures of sediment and water) of concentration less than 100 g/L can generally be characterized as flocculent settling. As slurry concentrations are increased, the sedimentation process may be characterized as a zone settling process, in which a clearly defined interface is formed between the clarified supernatant water and the more concentrated settled material. Zone settling also occurs when the sediment/water salinity is approximately 3 parts per thousand (ppt) or greater. Flocculent settling also describes the behavior of residual suspended solids in the clarified supernatant water above the sediment/water interface for slurries exhibiting an interface. The procedures described below define the sedimentation of suspended solids under flocculent settling conditions or above the settled material/water interface under zone setting conditions. The settling test procedures consist of withdrawing samples from the settling column at various depths and times and measuring the concentrations of suspended solids. Additional data should be collected from the column settling test for purposes of CDF design for initial storage and minimum surface area for a given inflow rate. These procedures are provided in Engineer Manual 1110-2-5027 (USACE 1987).

### **B.4.1 Column settling test apparatus**

An 8-in.-diam settling column such as shown in Figure B-3 is used. The test column depth should approximate the effective settling depth of the proposed disposal area. A practical limit on the depth of the test is 6 ft. The column should be at least 8 in. in diameter with interchangeable sections and with sample ports at 1/2-ft or closer intervals.

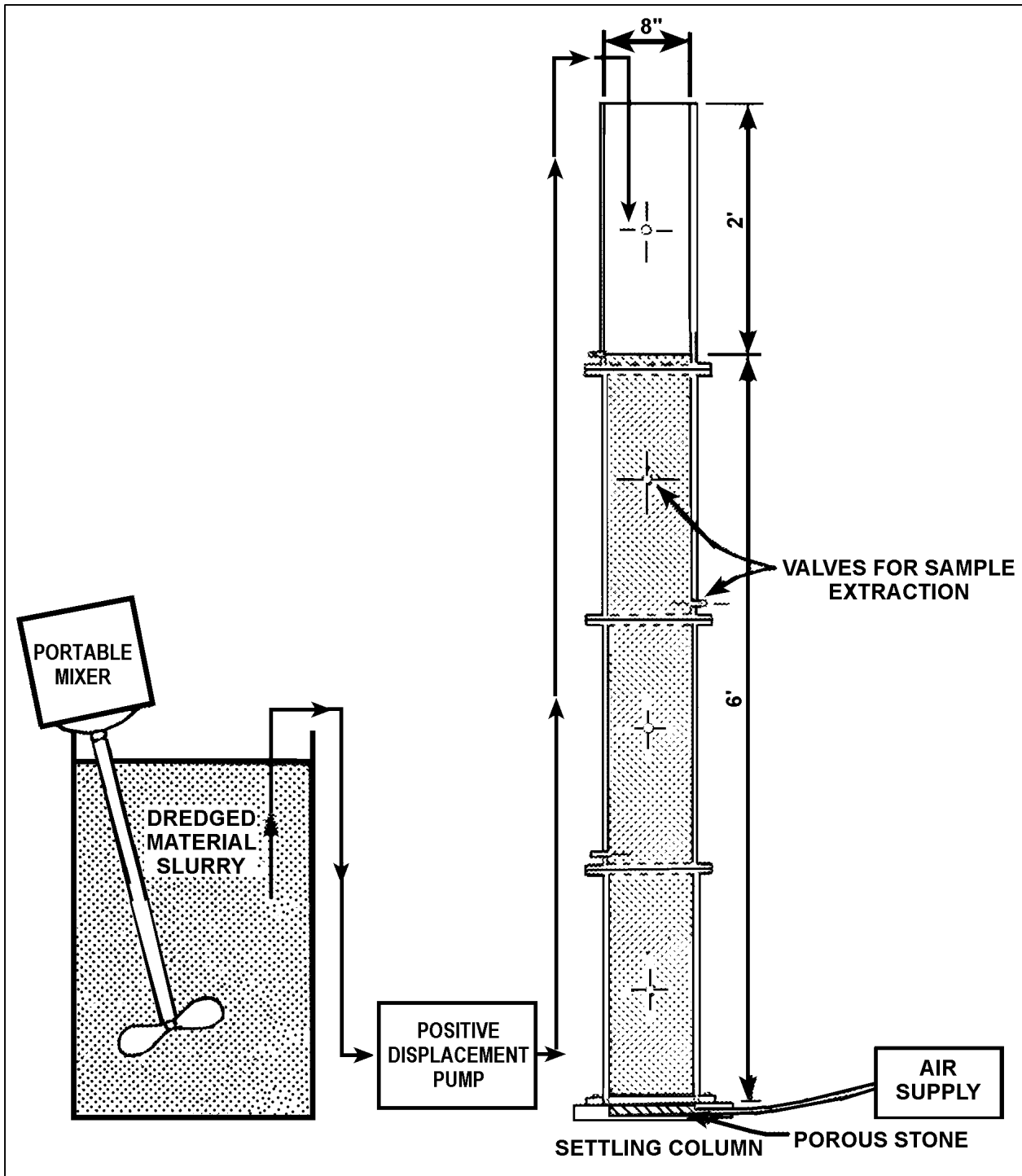

Figure B-2. Schematic of the Long Tube Column Settling Test

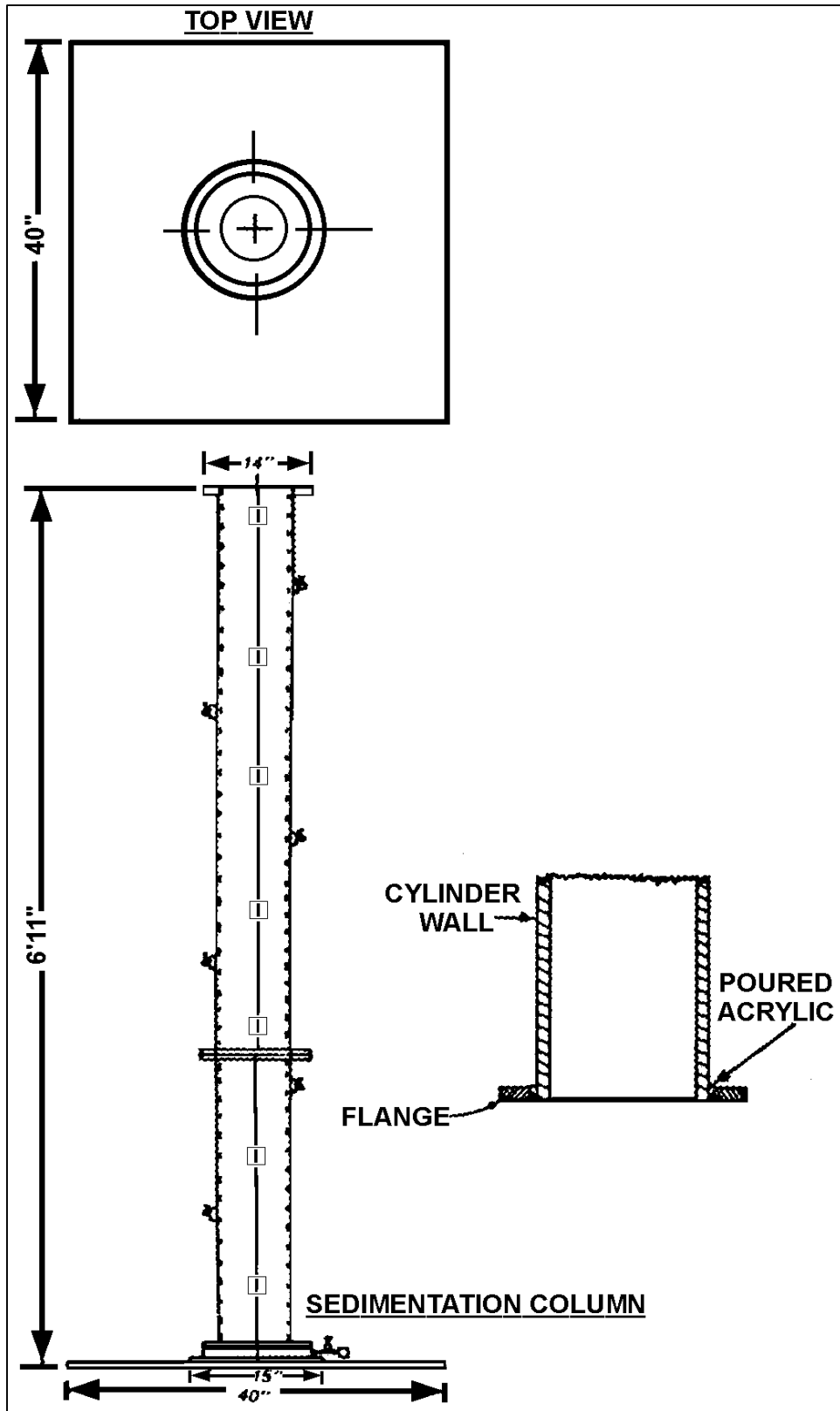

Figure B-3a. Specifications and plan for Long Tube Settling Column

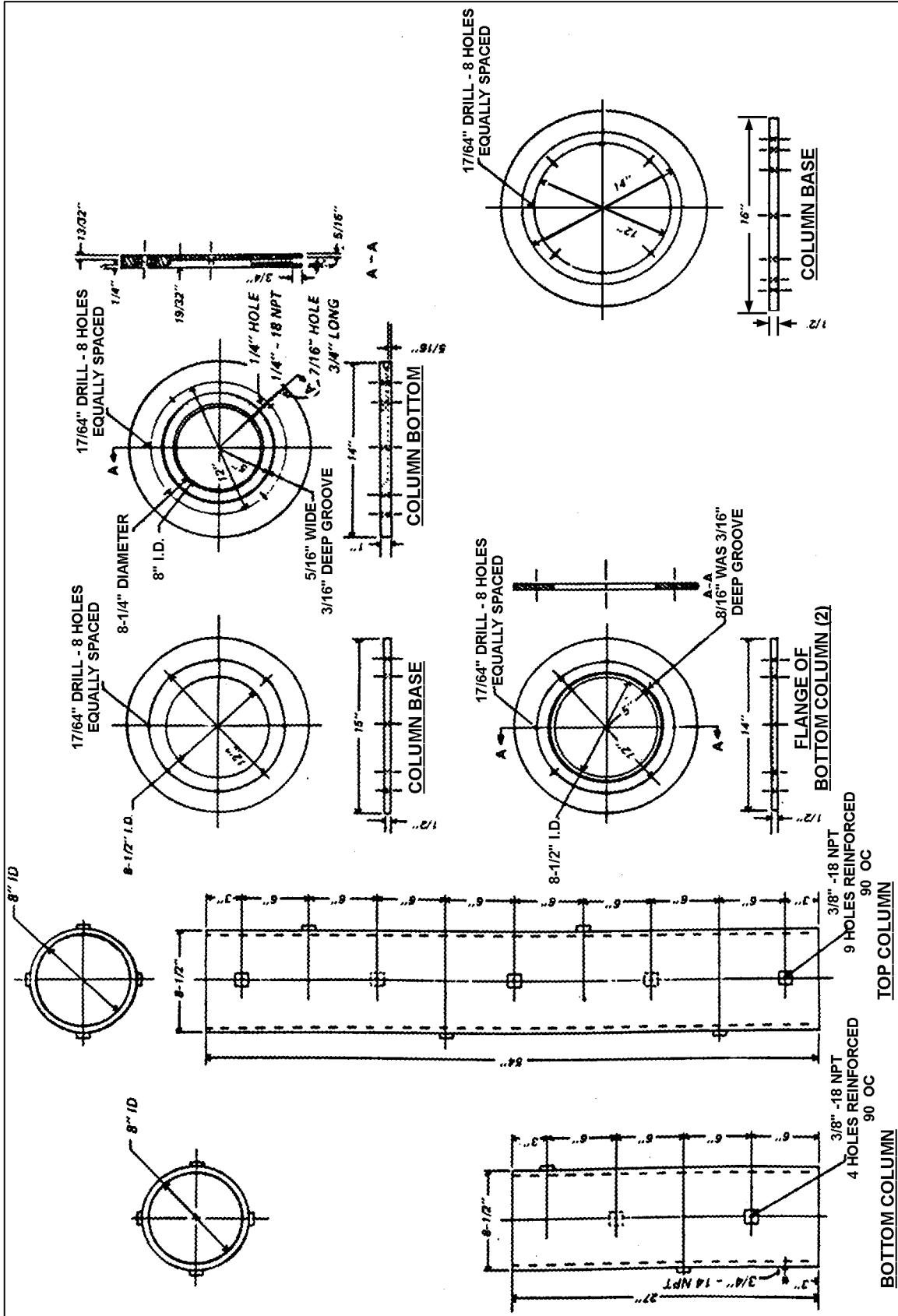

Figure B-3b. Plans for top and bottom sections of Long Tube Setting Column

## B.4.2 Column settling test procedure

The following test procedure should be used:

**Step 1.** Mix the sediment slurry to a suspended solids concentration  $C$  equal to the expected concentration of the dredged material influent  $C_i$ . The slurry should be mixed in a container with sufficient volume to fill the test column. Field studies indicate that for maintenance dredging of fine-grained material, the disposal concentration will average about 150 g/L. This concentration should be used in the test if better data are not available.

**Step 2.** Pump or pour the slurry into the test column using compressed air or mechanical agitation to maintain a uniform concentration during the filling period.

**Step 3.** When the slurry is completely mixed in the column, stop the compressed air or mechanical agitation and immediately draw off samples at each sample port and determine their suspended solids concentration. Use the average of these values as the initial slurry concentration at the start of the test. The test is initiated with the drawing of the first samples.

**Step 4a.** If an interface has not formed during the first day, flocculent settling is occurring in the entire slurry mass. Allow the slurry to settle and withdraw samples from each sampling port at regular time intervals to determine the suspended solids concentrations. Record the water surface height and time at the start of the sampling period. Analyze each sample for total suspended solids. Substantial reductions of suspended solids will occur during the early part of the test, but reductions will decrease with longer retention times. Therefore, the intervals can be extended as the test progresses. Recommended sampling intervals are 1, 2, 4, 6, 12, 24, 48 hr, etc., until the end of the test. As a rule, a 50-mL sample should be taken from each port. Continue the test until either an interface can be seen near the bottom of the column and the suspended solids concentration in the fluid above the interface is less than 1 g/L, or until the suspended solids concentrations in extracted samples shows no decrease.

**Step 4b.** If an interface forms the first day, zone settling is occurring in the slurry below the interface, and flocculent settling is occurring in the supernatant water. In this case, samples should be extracted from all side ports above the falling interface. The first of these samples should be extracted immediately after (a) the interface has fallen sufficiently below the uppermost port to allow extraction, or (b) a sufficient sample can be withdrawn from the surface without disturbing the interface. This sample can usually be extracted within a few hours after the beginning of the test. Record the time of extraction, water surface height, and port height for each port sample taken and analyze each sample for suspended solids. As the interface continues to fall, extract samples from all ports above the interface at regular time intervals. As before, a suggested sequence of sampling intervals would be 1, 2, 4, 6, 12, 24, 48, 96 hr, etc. The samples should continue to be taken until either the suspended solids concentration of the extracted samples shows no decrease or for a maximum time of 15 days. For this case, the suspended solids in the samples should be less than 1 g/L, and filtration will be required to determine the concentrations. The data should be expressed in milligrams per liter

for these samples. In reducing the data for this case, the concentration of the first port sample taken above the falling interface is considered the initial concentration.

## B.5 References

- Averett, D. E., Palermo, M. R., and Wade, R. (1988). "Verification of procedures for design of dredged material containment areas for solids retention," Technical Report D-88-2, U.S. Army Engineer Waterways Experiment Station, Vicksburg, MS.
- Brandon, D. L., Schroeder, P. R., and Lee, C. R. (1997). "Computerization of the decision-making framework effluent toxicity bioassay test results (LAT-E Program)," Technical Note EEDP-04-27, U.S. Army Engineer Waterways Experiment Station, Vicksburg, MS.
- Fulk, R., Gruber, D., and Wullschleger, R. (1975). "Laboratory study of the release of pesticide and PCB materials to the water column during dredging and disposal operations," Contract Report D-75-6, Envirex, Inc., under contract to the U.S. Army Engineer Waterways Experiment Station, Vicksburg, MS.
- Hayes, D. L., and Schroeder, P. R. (1992). "Documentation of the SETTLE module for ADDAMS: Design of confined disposal facilities for solids retention and initial storage," Technical Note EEDP-06-18, U.S. Army Engineer Waterways Experiment Station, Vicksburg, MS.
- Headquarters, U.S. Army Corps of Engineers (1987). "Confined disposal material," Engineer Manual 1110-2-5027, Washington, DC.
- Kriezck, R. K., FitzPatrick, J. A., and Atmatzidis, D. K. (1976). "Investigation of effluent filtering systems for dredged material containment facilities," Technical Report D-76-8, U.S. Army Engineer Waterways Experiment Station, Vicksburg, MS.
- Montgomery, R. L., Thackston, E. L., and Parker, F. L. (1983). "Dredged material sedimentation basin design," *Journal of Environmental Engineering, American Society of Civil Engineers* 109(2).
- Palermo, M. R. (1985a-d). "Interim guidance for predicting quality of effluent discharged from confined dredged material disposal areas," EEDP-04-01 through 04-4, U.S. Army Engineer Waterways Experiment Station, Environmental Laboratory, Vicksburg, MS.
- Palermo, M. R., and Schroeder, P. R. (1991). "Documentation of the EFQUAL module for ADDAMS: Comparison of predicted effluent quality with standards," Technical Note EEDP-06-13, U.S. Army Engineer Waterways Experiment Station, Vicksburg, MS.

- Palermo, M. R., and Thackston, E. L. (1988a). "Test for dredged material effluent quality," *Journal of Environmental Engineering, American Society of Civil Engineers* 114(6).
- \_\_\_\_\_. (1988b). "Verification of predictions of dredged material effluent quality," *Journal of Environmental Engineering, American Society of Civil Engineers* 114(6).
- \_\_\_\_\_. (1988c). "Flocculent settling above the zone settling interface," *Journal of Environmental Engineering, American Society of Civil Engineers* 114(4).
- Schroeder, P. R., and Palermo, M. R. 2000. "The automated dredging and disposal alternatives management system (ADDAMS)," Environmental Effects of Dredging Technical Note EEDP-06-12 (Revision of 1990), U.S. Army Engineer Waterways Experiment Station, Vicksburg, MS.
- Schroeder, P. R., Palermo, M. R., and Olin-Estes, T. J. "Screening evaluations for confined disposal facility effluent quality," Environmental Effects of Dredging Technical Note EEDP (in preparation), U.S. Army Engineer Research and Development Center, Vicksburg, MS.
- Thackston, E. L., and Palermo, M. R. (2000). "Improved methods for correlating turbidity and suspended solids for monitoring," DOER Technical Notes Collection, ERDC TN-DOER-E8, U.S. Army Engineer Research and Development Center, Vicksburg, MS. [www.wes.army.mil/el/dots/doer](http://www.wes.army.mil/el/dots/doer)
- U.S. Army Corps of Engineers/U.S. Environmental Protection Agency. (1992). "Evaluating environmental effects of dredged material management alternatives - A technical framework," EPA842-B-92-008, Washington, DC.
- U.S. Environmental Protection Agency/U.S. Army Corps of Engineers. (1995). "QA/QC guidance for sampling and analysis of sediments, water, and tissues for dredged material evaluations - chemical evaluations," EPA-823-B-95-001, Washington, DC.
- U.S. Environmental Protection Agency/U.S. Army Corps of Engineers (1998). "Evaluation of dredged material proposed for discharge in waters of the U.S. - testing manual," EPA-823-B-98-004 Office of Water (4305), Washington, DC.

# Appendix C

## Test Procedures for Surface Runoff Discharges

---

### C.1 Introduction

This appendix provides detailed, step-by-step procedures for conducting tests for evaluation of confined disposal facility (CDF) runoff. The background, rationale, and tiered framework for application of these procedures are discussed in Chapter 5 of the main text of the Upland Testing Manual (UTM). Four test procedures are included in this appendix:

- a.* Simplified laboratory runoff procedure (SLRP) for water quality evaluations.
- b.* Rainfall simulator/lysimeter system (RSLS) test for water quality evaluations.
- c.* Water column toxicity tests using the SLRP elutriate.
- d.* Water column toxicity tests using the RSLS elutriate.

### C.2 Simplified Laboratory Runoff Procedure for Runoff Quality Evaluation

The SLRP was designed to simulate the water quality of precipitation runoff from dredged material. The procedure evaluates the surface water generated on the CDF as a result of two cases: 1) Precipitation under wet, anaerobic conditions where consolidation is at a minimum as interstitial water is removed. At this stage, suspended solids in precipitation generated surface water within the CDF are possible within the range of 500 to 50,000 mg l<sup>-1</sup>; 2) The opposite



worst-case scenario is that of complete dryness with no vegetative cover. Suspended solids in this stage may range from 50 to 5,000 mg l<sup>-1</sup>.<sup>1</sup>

The SLRP was developed to provide a faster, less expensive initial evaluation of surface runoff quality from dredged material placed in an upland environment (Skogerboe 1995; Price, Skogerboe, and Lee, 1998; and Price and Skogerboe 1999). The test determines runoff quality from wet, anoxic and dry, oxidized conditions. The core of the SLRP procedure is the use of hydrogen peroxide to rapidly oxidize air-dried sediment to simulate the long-term effects of chemical and microbial oxidation on the solubility of specific metals.

### **C.2.1 Materials and apparatus**

The following equipment and materials are required to conduct the SLRP.

#### **Apparatus.**

- a. 4-L glass bottles with teflon tops.
- b. Assorted graduated cylinders up to 1 L.
- c. Horizontal mechanical shaker.
- d. Millipore microanalysis vacuum filter apparatus.
- e. 0.45- $\mu$ m membrane filters.
- f. 0.7- $\mu$ m glass fiber filters without binders.
- g. 2.7- $\mu$ m glass fiber filters without binders.

Prior to use, all glassware should be thoroughly cleaned. Wash all glassware with detergent, rinse five times with tap water, place in a clean bath for a minimum of 4 hr, rinse five times with tap water, and then rinse five times with distilled or deionized water.

#### **Reagents.**

- a. 30 percent hydrogen peroxide.
- b. Concentrated nitric acid.
- c. Other preservation reagents as required.

---

<sup>1</sup> It is important to note that use of these total suspended solids (TSS) values in the runoff test are intended to “bracket” the results for evaluation of dissolved contaminants of concern (COC) in runoff. Actual TSS concentration in runoff for a properly managed CDF would be lower.

- d. Distilled or deionized water.

## C.2.2 Procedure

**Step 1. Sediment Preparation.** Sediment core or grab samples are normally collected from the proposed dredging site for evaluation of various contaminant pathways. These may be composited into one bulk sediment or composited according to horizontal and/or vertical position. The SLRP procedure must be conducted on each composite considered for separate upland placement. No more than a 22-L and a minimum 13.2-L volume of each composite to be tested is required. The sediment should be stored in a sealed polyurethane bucket at 4 °C until ready to conduct the SLRP procedure. Prior to removing sediment from the bucket, it should be thoroughly mixed using a stainless steel electric mixer. Sufficient samples to conduct the SLRP evaluation can then be removed from the container. Prior to conducting the following analyses, the sediment should be sieved through a 2-mm sieve to remove inert gravel fractions or other oversize materials.

**Step 1a. Sediment Moisture.** Three replicate samples (1 to 2 g) of wet sediment are placed in preweighed aluminum pans and oven-dried at 110 °C for 24 hr. The pans are then removed and reweighed to determine percent water on a dry weight basis using the formula:

$$DM_{DWB} = (WW - DW / DW) \times 100 \quad (C-1)$$

where:

$DM_{DWB}$  = percent moisture on a dry weight basis

$WW$  = wet weight of sediment

$DW$  = oven dry weight of sediment

100 = conversion to percent

To determine the amount of wet sediment needed to provide a dry weight equivalent of any given amount, use the formula:

$$DWeqv = (DWreq \times M_{DWB}) + DWreq \quad (C-2)$$

where

$DWeqv$  = amount of wet sediment equal to the dry weight

$M_{DWB}$  = percent moisture on a dry weight basis

$DWreq$  = dry weight sediment required

**Step 1b. Air Drying.** Approximately 400 g dry weight of wet sediment is placed in a stainless steel drying pan and air-dried in a greenhouse for 3 weeks to

less than 5 percent moisture on a dry weight basis. The material should be mixed daily to facilitate the drying process. When drying is complete the sediment is ground to again pass a 2-mm screen. This material is referred to as the air-dried sediment and will be evaluated in the SLRP for organics and nutrients.

**Step 1c. Chemical Oxidation.** Chemical and microbial oxidation of iron sulfides in some sediment may result in the formation of sulfuric acids and a significant reduction of pH. This may have a substantial increase in the solubility of metals. The SLRP addresses this by oxidation with hydrogen peroxide. The air-dried sediment or wet sediment oven-dried for 48 hr at 95 °C may be used for this procedure. After drying is complete, 30 percent hydrogen peroxide (H<sub>2</sub>O<sub>2</sub>) is added to rapidly oxidize the sediment, simulating long-term effects of the oxidation of iron sulfides. A pretest is necessary to determine the amount of H<sub>2</sub>O<sub>2</sub> necessary to fully oxidize the sediment. Dried sediment (10 g) is placed in a 250-mL beaker and 30 percent H<sub>2</sub>O<sub>2</sub> is slowly added in 10-ml increments, each time observing for an effervescent reaction. When there is no longer an oxidation response from additional inputs of H<sub>2</sub>O<sub>2</sub>, the process is complete. The amount of H<sub>2</sub>O<sub>2</sub> used is multiplied times 10 and used in the oxidation procedure below; however, no more than 500 mL total should be used.

A large open-top glass container, such as a 4-L beaker is used for the oxidation process. Clear glass allows for easy viewing of the reaction process. The large volume is required because of the violent bubbling that occurs as the H<sub>2</sub>O<sub>2</sub> reacts with the sediment. An amount of 100 g of the air-dried or oven-dried sediment is placed in the beaker and 100 mL of H<sub>2</sub>O<sub>2</sub> is slowly added. A glass stirring rod is used to ensure adequate mixing. Allow sufficient time for the H<sub>2</sub>O<sub>2</sub> to react, and wait until the reaction stops before proceeding to and more H<sub>2</sub>O<sub>2</sub>. Once the entire volume of H<sub>2</sub>O<sub>2</sub> is determined in the pretest has been added, allow the reaction to cease and the material to cool to room temperature before handling. If the pretest indicates H<sub>2</sub>O<sub>2</sub> in excess of 500 mL is required, do not exceed. Instead, after addition of a total of 500 mL to the sediment, cover the beaker with a watch glass and allow setting overnight. Bring the sediment back to dryness by placing in an oven at 95 °C for 48 hr. The sediment is now ready to be reground and used to prepare runoff samples.

**Step 2. SLRP Runoff Water Preparation.** The SLRP requires the preparation of simulated runoff water using wet, unoxidized and dry, and oxidized sediment using sediment: water ratios corresponding to the suspended solids concentrations shown in Tables C1 and C2. Each ratio for the sediment condition should be replicated three times. For purposes of describing runoff quality from CDFs, the term total contaminants refers to unfiltered samples and dissolved refers to filtered samples. Volume of sample for each of the sediment conditions described below is dependent on the required chemical analysis. Typically, 4 L will be sufficient volume to evaluate priority metals, PAHs, PCBs, and selected nutrients. The volume required by the analytical laboratory should first be determined and the necessary volume required can then be generated. Both dissolved and total contaminants may be determined however, only dissolved is generally necessary for water quality comparisons. If total contaminant determinations are required the values can be determined by

analysis of unfiltered runoff samples or from the computations described in Section 5.3.1.

**Step 2a. Wet Sediment Evaluation.** The wet sediment evaluation begins with the placement of replicate wet sediment samples into 4-L glass bottles using the oven-dry weight equivalents shown in Table C1. Three replicates of each sediment to water ratio is prepared. Deionized water is added to bring total sample volume to four liters. The containers are placed horizontally on a mechanical shaker and agitated for 1 hr to ensure complete suspension of sediment and sediment to water contact. It is advised to tape the caps to prevent leakage. After shaking is complete the sample is filtered using appropriate for

<b>Table C1 Target Suspended Solids and Required Sediment for Simulated Runoff Samples from Wet Sediment</b>		
<b>Sediment: Water Ratio</b>	<b>Suspended Solids, mg/L</b>	<b>Sediment / 1 L, g<sup>1</sup></b>
1:2,000	500	0.5
1:200	5,000	5
1:20	50,000	50
<sup>1</sup> Oven-dry weight equivalent of wet sediment.		

<b>Table C2 Target Suspended Solids and Required Sediment for Simulated Runoff Samples from Dry Sediment</b>		
<b>Sediment: Water Ratio</b>	<b>Suspended Solids, mg L<sup>-1</sup></b>	<b>Sediment / 1 L, g<sup>1</sup></b>
1:20,000	50	0.05
1:2,000	5,00	0.5
1:200	5,000	5
<sup>1</sup> Oven-dry weight.		

the contaminants in question. Organic contaminants are pre-filtered through a Whatman® GF/D 2.7-um glass fiber filter followed by a Whatman® GF/F 0.7-um glass fiber filter or equivalent. Inorganic contaminants are in addition filtered through a MF-Millipore® 0.45-um membrane filter or equivalent. Preservation of filtered samples is accomplished according to U.S. Environmental Protection Agency (USEPA) standards appropriate for each contaminant.

**Step 2b. Dry Sediment Evaluation for Organics and Nutrients.** The purpose of the dry portion of the SLRP is to predict the long-term effects of drying and oxidation of dredged material on movement of contaminants from upland CDFs. For the determination of all contaminants except priority metals, three replicates of air-dried sediment from Step 1b are weighed to the nearest 0.001 g and placed in 4-L bottles as shown in Table C2. An amount of deionized water equal to the total volume required minus the sediment weight is added to the bottle and capped. Sediment samples are collected from the sample bucket and placed in a drying oven at 90 °C for 48 hr. Place the oven-dried sediment in the 4-L bottles and incrementally add the 30 percent H<sub>2</sub>O<sub>2</sub> until the full volume required for oxidation has been added. Reactions to the H<sub>2</sub>O<sub>2</sub> vary by sediment and some may be subject to boil-over. For the 500- and 50-mg l<sup>-1</sup> samples, smaller containers, such as 500- and 50-mL glass beakers, respectively, should

be used to ensure effective oxidation of sediment. Samples are then transferred to the 4-L bottles after oxidation is complete and deionized water is added to bring the total volume of all samples to 1 L. The samples are shaken for 1 hr as described above, and one-half of the samples are immediately placed in the Nalgene containers and preserved with nitric acid to pH 2.0. The remaining halves are then filtered as described for the wet sediment.

**Step 3 - Chemical Analyses.** The samples should be analyzed as soon as possible after extraction. Dissolved and, if required, total concentrations of desired analytes in the samples should be determined. (If water quality standards for chemical contaminants are in terms of dissolved concentrations, the total concentration of contaminants in the runoff samples need not be determined).

### **C.3 Rainfall Simulator/Lysimeter System (RSLs) Procedure for Evaluation of Surface Runoff Quality**

The Waterways Experiment Station (WES)/U.S. Army Engineer Research and Development Center (ERDC) rainfall simulator lysimeter system (RSLs) predicts these effects so that restrictions and/or treatments, such as controlling movement of suspended solids or providing adequate mixing zones, can be incorporated into the CDF design. The testing protocol for surface runoff quality using the RSLs has been applied to dredged material from a number of locations. Contaminants have included heavy metals, PAHs, PCBs, pesticides, organotins, and dioxins. Although the RSLs is a very effective tool for predicting surface runoff quality from upland CDFs, the procedure is time-consuming, requires a large volume of sediment, and can only be conducted at the WES/ERDC. However, when the SLRP predicts exceedence of water quality standards (WQS) after consideration of mixing, the RSLs test may be used to satisfy the requirements for Section 401 water quality certification.

#### **C.3.1 Materials and apparatus**

The following equipment and materials are required to conduct the RSLs procedure.

##### **Apparatus/Equipment.**

- a. Rainfall simulator/lysimeter system (see description below).
- b. Sampling pump with a minimum of 6 L/min pumping rate.
- c. Millipore microanalysis vacuum filter apparatus.
- d. 0.45- $\mu$ m membrane filters.
- e. 0.7- $\mu$ m glass fiber filters without binders, Type GF/F.

- f.* 1.2-um glass fiber filters, Type GF/C.
- g.* 2.7-um glass fiber filters without binders, Type GF/D.
- h.* Stainless steel vacuum manifold.
- i.* Clock with second hand.
- j.* Assorted graduated cylinders (glass, Nalgene, 100 to 2,500 L in size).
- k.* Assorted glassware.
- l.* Meters: pH, conductivity.
- m.* Analytical balance (0.0001 accuracy).
- n.* Nine 4-L glass bottles w/teflon caps.
- o.* Numerous Nalgene and glass containers for sample submission.

Prior to use, all glassware should be thoroughly cleaned. Wash all glassware with detergent, rinse five times with tap water, place in a clean bath for a minimum of 4 hr, rinse five times with tap water, and then rinse five times with distilled or deionized water.

#### **Reagents.**

- a.* Concentrated nitric acid
- b.* Other preservation reagents as required
- c.* Distilled or deionized water

**Rainfall Simulator/Lysimeter System Description.** The RSLS uses a rotating disk type rainfall simulator modified from a previous design (Morin, Goldberg, and Seginer 1967). The rainfall simulator incorporates several features designed to duplicate accurately the drop size distribution and terminal drop velocities of natural rainfall--a critical factor in erosion and infiltration studies (Westerdahl and Skogerboe 1982). The lysimeter is an aluminum bin, 4.57 m by 1.22 m (15 ft by 4 ft), and has removable sides so soil or sediment depth can be increased or decreased in increments of 0.15 m (0.5 ft). The lysimeter can also be attached to power lifts that can vary the slope from 0 to 20 percent. Generally, runoff tests conducted on dredged material are at a slope of 1 percent. The lysimeter is wheeled and can be moved from the simulation bay to the outside, covered with a ventilated transparent top and allowed to air-dry and oxidize over a 6-month time period, simulating the long-term effects of aging. This specific RSLS is only available at the WES/ERDC. Other are available and can be used if they meet the minimum specifications described below.

### C.3.2 Sediment characterization

The following sediment characterization test should be performed in replicates of three on the dredged material in the lysimeter prior to each rainfall simulation run (wet and dry).

**Sediment Moisture.** Three replicate samples (1 to 2 g) of wet sediment are placed in preweighed aluminum pans and oven-dried at 95 °C for 48 hr. The pans are then removed and reweighed to determine percent water on a dry weight basis using the formula  $((\text{wet weight} - \text{dry weight}) / \text{dry weight}) \times 100$ .

### C.3.3 RSLs procedure

Up to eleven 208-L (45-gal) drums or 2,290 L of sediment are required to conduct the RSLs test. The sediment is loaded into the lysimeter one drum at a time, mixing as the sediment is dumped. Polyethylene shovels or large spatulas are used to mix the material as effectively as possible. Final depth of the sediment in the lysimeter is approximately 33.0 cm. The interstitial water is allowed to evaporate and a series of rainfall simulations are conducted while the sediment is still anaerobic. Three 30-min storm events at 5.08 cm/hr (2 in./hr) are applied on successive days (Skogerboe et al. 1987). Runoff rates are measured every minute, and 4-L runoff samples are collected at 5, 15, and 25 min after runoff begins to occur. Additional samples are collected in 250-ml polyethylene bottles for pH, electrical conductivity and suspended solids determinations every minute through 15 min and then every 5 min thereafter to 30 min. The 4-L samples are combined at the end of the each day's test representing one replicate of three successive test runs. After the three test runs are complete the lysimeter is moved outside and covered with a ventilated, transparent top, and the sediment is allowed to dry and oxidize over a 6-month period. After 6 months of drying, the lysimeter is moved back into the rainfall simulation bay and the three consecutive storm events are repeated on the now dry and oxidized sediment. The sampling protocol is the same as for the wet sediment.

### C.3.4 Characterization of runoff samples and preparation for analysis

The 250-mL samples collected are subjected to the determination of suspended solids, pH and electrical conductivity as described below. The composite runoff samples are split and half are placed into appropriate containers for contaminants of concern for analysis of total contaminants. The other half of the samples are prefiltered, if necessary, through a 2.7- $\mu\text{m}$  filter and then filtered through a 0.45- $\mu\text{m}$  membrane filter for metals or a 0.7- $\mu\text{m}$  glass fiber filter for organics to represent the soluble fraction of contaminants. Preservation of filtered samples should be done according to specific requirements for each contaminant according to USEPA (1986).

The samples should be analyzed as soon as possible after extraction. Dissolved and, if required, total concentrations of desired analytes should be

determined. The total or unfiltered sample analysis is not explicitly required unless water quality standards for chemical contaminants are based on the total concentration of contaminants. Dissolved to total comparisons for each COC provides a determination of solubility, which may increase or decrease as the material dries and oxidizes. Chemical analyses of the runoff samples should be performed according to the guidance in Chapter 9 of the Upland Testing Manual (UTM) (USEPA/USACE 1998).

### C.3.5 Other analyses of runoff water

Other analyses required for runoff sample include the following and are conducted on the 250-mL samples collected at each simulation run.

**Suspended solids.** Suspended solids (SS) in runoff are determined by filtering a 100-mL volume of each runoff water sample, after vigorous shaking through a preweighed 1.2-um glass fiber filter. The filter is carefully removed and dried at 95 °C for 24 hr and reweighed to determine suspended solids in mg L<sup>-1</sup> using the following formula:

$$SS = (mg \text{ dry filter} + \text{filtered solids}) - (mg \text{ dry filter}) * 10 \quad (C-3)$$

**Determination of water pH.** A pH electrode is placed directly into the runoff water sample collected and the pH is read on a pH meter. May be required to determine if water quality standards for pH are met.

**Electrical conductivity (EC).** A conductivity cell is inserted directly into the runoff samples collected and EC is determined on a conductance meter to determine EC in mmhos cm<sup>-1</sup>. This is a concern when discharging runoff water from a saltwater dredged material into freshwater receiving water.

### C.3.6 Interpretation of results

The results of the RSLs test are evaluated as described in Chapter 5. A computer program (RUNQUAL) is provided for this purpose (Schroeder, Gibson, and Dordeau 1995) and is a module of the Automated Dredging and Disposal Alternatives Modeling System (ADDAMS). The program can be downloaded from the WES/ERDC Environmental Laboratory website: (<http://www.wes.army.mil/el/elmodels/index.html>)

## C.4 Runoff Toxicity Evaluation

Additional testing may be required to assess the impacts of contaminants in the dredged material runoff on appropriate sensitive organisms to determine if there is potential for the dredged material to have an effect due to interactive effects of multiple contaminants or from contaminants with no WQS. The runoff toxicity test uses lethality as the primary endpoint because the importance of this endpoint is easily interpreted. These acute tests use organisms representative of the water



column at the disposal site. The recommended procedures for water column toxicity tests for evaluation of runoff discharges are conducted in generally the same manner as those for discharges of material into open water as described in the Inland Testing Manual (ITM) (USEPA/USACE 1998). The only exception is that the toxicity test medium is prepared using the SLRP or RSLs runoff procedure.

The results of the water column toxicity tests should be interpreted considering the effects of mixing. If the concentration of dissolved plus suspended contaminants, after allowance for mixing, does not exceed 0.01 of the toxic (LC50 or EC50) concentration beyond the boundaries of the mixing zone, the discharge is predicted not to be acutely toxic to water column organisms. If the concentration of dissolved plus suspended contaminants, after allowance for mixing, exceeds 0.01 of the toxic concentration, the discharge is predicted to be acutely toxic to water column organisms.

#### **C.4.1 Runoff water preparation for water column toxicity test**

The volume required for each analysis, the number of variables measured, and the desired analytical replication will influence the total runoff sample volume required. A 4-L cylinder is normally used for the test, and the supernatant volume available for sample extraction will vary from approximately 500 to 1,000 mL, depending on the sediment properties, settling times, and initial concentration of the slurry. It may be necessary to composite several extracted sample volumes or to use large-diameter cylinders to obtain the total required volume.

#### **C.4.2 Apparatus**

The following items are required:

- a.* SLRP or RSLs apparatus.
- b.* Several 4-L glass bottles with teflon caps.
- c.* Clock with second hand.

#### **C.4.3 Test procedure**

**Sample collection and preparation.** Runoff samples for the water column toxicity test are collected in 4-L bottles as described in the SLRP or RSLs runoff procedures. It may be necessary to let the samples settle and the supernatant carefully removed so that the suspension is clear enough at the first observation time for the organisms to be visible. The general guidance in the ITM should be followed in performing the toxicity tests.

#### C.4.4 LAT-R computer-assisted runoff toxicity evaluation

The LAT-R application (Brandon, Schroeder, and Lee 1997) of the ADDAMS suite of computer programs (Schroeder and Palermo 2000) provides a computer program to assist in the analysis of effluent(wrong- still doesn't exist.) toxicity. The LAT-E application, along with documentation, can be downloaded from the USACE DOTS website at [www.wes.army.mil/el/dots](http://www.wes.army.mil/el/dots). If desired, manual data analyses procedures for evaluation of runoff toxicity are available in the ITM (USEPA/USACE 1998).

### C.5 References

- Averett, D. E., Palermo, M. R., and Wade, R. (1988). "Verification of procedures for design of dredged material containment areas for solids retention," Technical Report D-88-2, U.S. Army Engineer Waterways Experiment Station, Vicksburg, MS.
- Brandon, D. L, Schroeder, P. R., and Lee, C. R. (1997). "Computerization of the decision-making framework: effluent toxicity bioassay test results (LAT-E program)," Technical Note EEDP-04-27, U.S. Army Engineer Waterways Experiment Station, Vicksburg, MS.
- Fulk, R., Gruber, D., and Wullschleger, R. (1975). "Laboratory study of the release of pesticide and PCB materials to the water column during dredging and disposal operations," Contract Report D-75-6, Envirex, Inc., under contract to the US Army Engineer Waterways Experiment Station, Vicksburg, MS.
- Hayes, D. L., and Schroeder, P. R. (1992). "Documentation of the SETTLE module for ADDAMS: Design of confined disposal facilities for solids retention and initial storage," Technical Note EEDP-06-18, U.S. Army Engineer Waterways Experiment Station, Vicksburg, MS.
- Kriezck, R. K., FitzPatrick, J. A., and Atmatzidis, D. K. (1976). "Investigation of effluent filtering systems for dredged material containment facilities," Technical Report D-76-8, U.S. Army Engineer Waterways Experiment Station, Vicksburg, MS.
- Montgomery, R. L., Thackston, E. L., and Parker, F. L. (1983). "Dredged material sedimentation basin design," *Journal of Environmental Engineering, American Society of Civil Engineers* 109(2).
- Morin, J., Goldberg, D., and Seginer, I. (1967). "A rainfall simulatory with a rotating disk," *Transactions of the American Society of Agricultural Engineers* 10(1), 74-79.
- Palermo, M. R. (1985a-d). "Interim guidance for predicting quality of effluent discharged from confined dredged material disposal areas," EEDP-04-01

through 04-4, U.S. Army Engineer Waterways Experiment Station, Vicksburg, MS.

Palermo, M. R., and Schroeder, P. R. (1991). "Documentation of the EFQUAL module for ADDAMS: Comparison of predicted effluent water quality with standards," Technical Note EEDP-06-13, U.S. Army Engineer Waterways Experiment Station, Vicksburg, MS.

Palermo, M. R., and Thackston, E. L. (1988a). "Test for dredged material effluent quality," *Journal of Environmental Engineering, American Society of Civil Engineers* 114(6).

\_\_\_\_\_. (1988b). "Verification of predictions of dredged material effluent quality," *Journal of Environmental Engineering, American Society of Civil Engineers* 114(6).

\_\_\_\_\_. (1988c). "Flocculent settling above the zone settling interface," *Journal of Environmental Engineering, American Society of Civil Engineers* 114(4).

Price, R. A., Skogerboe, J. G., and Lee, C. R. (1998). "Predicting surface runoff quality from puland disposal contaminated dredged material," Dredging Research Technical Note EEDP-02-25, U.S. Army Engineer Waterways Experiment Station, Vicksburg, MS.

Price, R. A., and Skogerboe, J. G. (1999). Application of SLRP to Pearl Harbor dredged material," Dredging Research Technical Note EEDP-02-27, U.S. Army Engineer Waterways Experiment Station, Vicksburg, MS.

Schroeder, P. R., Gibson, A. C., and Dardeau, E. A., Jr. (1995). "Documentation of the RUNQUAL module for ADDAMS: Comparison of predicted runoff water quality with standards," Dredging Research Technical Note EEDP-06-19, U.S. Army Engineer Waterways Experiment Station, Vicksburg, MS.

Schroeder, P. R., and Palermo, M. R. 2000. "The automated dredging and disposal alternatives management system (ADDAMS)," Environmental Effects of Dredging Technical Note EEDP-06-12 (revision of 1990), U.S. Army Engineer Waterways Experiment Station, Vicksburg, MS.

Schroeder, P. R., Palermo, M. R., and Olin-Estes, T. J. (2000). "Screening evaluations for confined disposal facility effluent quality," Environmental Effects of Dredging Technical Note EEDP-xx-xx, U.S. Army Engineer Research and Development Center, Vicksburg, MS.

Skogerboe, J. G. (1995). "A simplified laboratory test for predicting surface runoff quality from contaminated upland dredged material disposal sites," M.S. thesis, College of Engineering, Louisiana Tech University, Ruston, LA.

Skogerboe, J. G., Lee, C. R., Price, R. A., Brandon, D. L., and Hollins, G. (1987). "Prediction of surface runoff water quality from Black Rock Harbor

dredged material placed in an upland disposal site,” Miscellaneous Paper D-87-1, U.S. Army Engineer Waterways Experiment Station, Vicksburg, MS.

Thackston, E. L., and Palermo, M. R. (2000). “Improved methods for correlating turbidity and suspended solids for monitoring,” *DOER Technical Notes Collection* (ERDC TN-DOER-E8), U.S. Army Engineer Research and Development Center, Vicksburg, MS. [www.wes.army.mil/el/dots/doer](http://www.wes.army.mil/el/dots/doer)

U.S. Army Corps of Engineers. (1987). “Confined disposal material, Engineer Manual 1110-2-5027, Washington, DC.

U.S. Army Corps of Engineers/U.S. Environmental Protection Agency. (1992). “Evaluating environmental effects of dredged material management alternatives - A technical framework,” EPA842-B-92-008, Washington, DC.

U.S. Environmental Protection Agency. (1986). “Test methods for evaluating solid wastes, SW-846 Methods 8080 and 8270.” 3rd ed., Office of Solid Waste and Emergency Response, Washington, DC.

U.S. Environmental Protection Agency/U.S. Army Corps of Engineers. (1995). “QA/QC guidance for sampling and analysis of sediments, water, and tissues for dredged material evaluations - chemical evaluations,” EPA-823-B-95-001, Washington, DC.

U.S. Environmental Protection Agency/U.S. Army Corps of Engineers. (1998). “Evaluation of dredged material proposed for discharge in waters of the U.S. – Testing Manual,” EPA-823-B-98-004, Office of Water (4305), Washington, DC.

Westerdahl, H. E., and Skogerboe, J. G. (1982). “Realistic rainfall and watershed response simulations for assessing water quality impacts of land use management; Modeling components of hydrologic cycle.” *International Symposium on Rainfall – Runoff Modeling*, Mississippi State University, Mississippi State, MS.

# Appendix D

## Leachate Testing Procedures

---

### D.1 Introduction

This appendix provides detailed step-by-step procedures for conducting tests for evaluation of confined disposal facilities (CDF) leachate. The background, rationale, and tiered framework for application of these procedures are discussed in Chapter 6 of the main text of this Upland Testing Manual (UTM). Two test procedures are included in this appendix:

- a.* Sequential Batch Leachate Test (SBLT).
- b.* Pancake Column Leach Test (PCLT).

### D.2 Theoretical Basis and Considerations for Testing

A basic understanding of the theoretical aspects of interphase contaminant transfer is necessary for informed interpretation of leachate testing results. Contaminant migration via leachate seepage is a porous-medium contaminant transport problem (Figure D-1). Leaching is defined as interphase transfer of contaminants from dredged material solids to the pore water surrounding the solids and the subsequent transport of these contaminants by pore water seepage. Interphase mass transfer during dredged material leaching is a complicated interaction of many elementary processes and factors affecting these processes (Figure D-2). A complete description of all these processes, factors, and interactions is not presently possible. Instead, a lumped variable, the distribution coefficient, is used to describe the distribution of contaminant between aqueous and solid phases.

#### D.2.1 Equilibrium Assumption

In order for contaminants to cross the interface between dredged material solids and water, a difference in chemical potentials must exist. Chemicals migrate from a region of high chemical potential to a region of low chemical

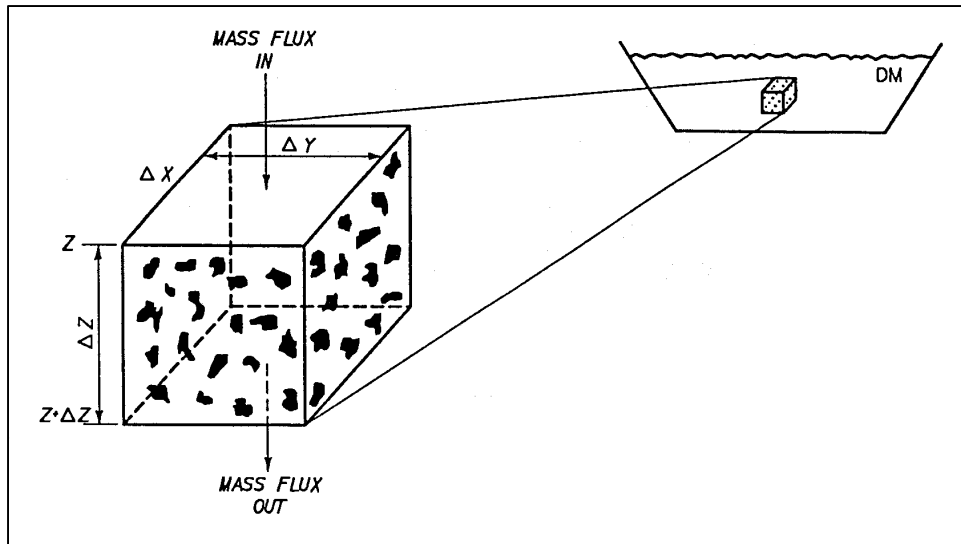

Figure D-1. Model of dredged material leaching (from Hill, Myers, and Brannon 1988)

potential just as electric current flows from a region of high electrical potential to one of lower electrical potential. When chemical potentials are equal, the net transfer of contaminant across the solid-water interface is zero, and the mass of contaminant in each phase is constant, but not necessarily equal. The processes shown in Figure D-2 control the rate at which equilibrium is reached and the equilibrium distribution of contaminant between solid and aqueous phases. Once equilibrium is reached, the ratio of contaminant mass in the solid phase to the contaminant mass in the aqueous phases does not change.

In practice, a true equilibrium between dredged material solids and pore water never exists because some of the processes shown in Figure D-2 have very slow reaction rates. However, a pseudo steady state can be reached between dredged material solids and water if the water is moving past the solids slowly enough, as discussed in a following section. By assuming equilibrium between solid and aqueous phases, the need for determining controlling processes and the rate coefficients for these processes is eliminated. Without the equilibrium assumption, laboratory testing and mathematical modeling would require determination of controlling processes and investigation of the kinetics for these processes. As is apparent from Figure D-2, predictive laboratory tests and mathematical models based on chemical and mass transfer kinetics would be too complicated for routine evaluation of dredged material leaching. Thus, application of the equilibrium assumption is imperative for the development of predictive techniques suitable for routine use.

Under equilibrium conditions, only the relative distribution of contaminant between solid and aqueous phases is needed to predict leachate quality.

$$K_d = q / C \quad (D-1)$$

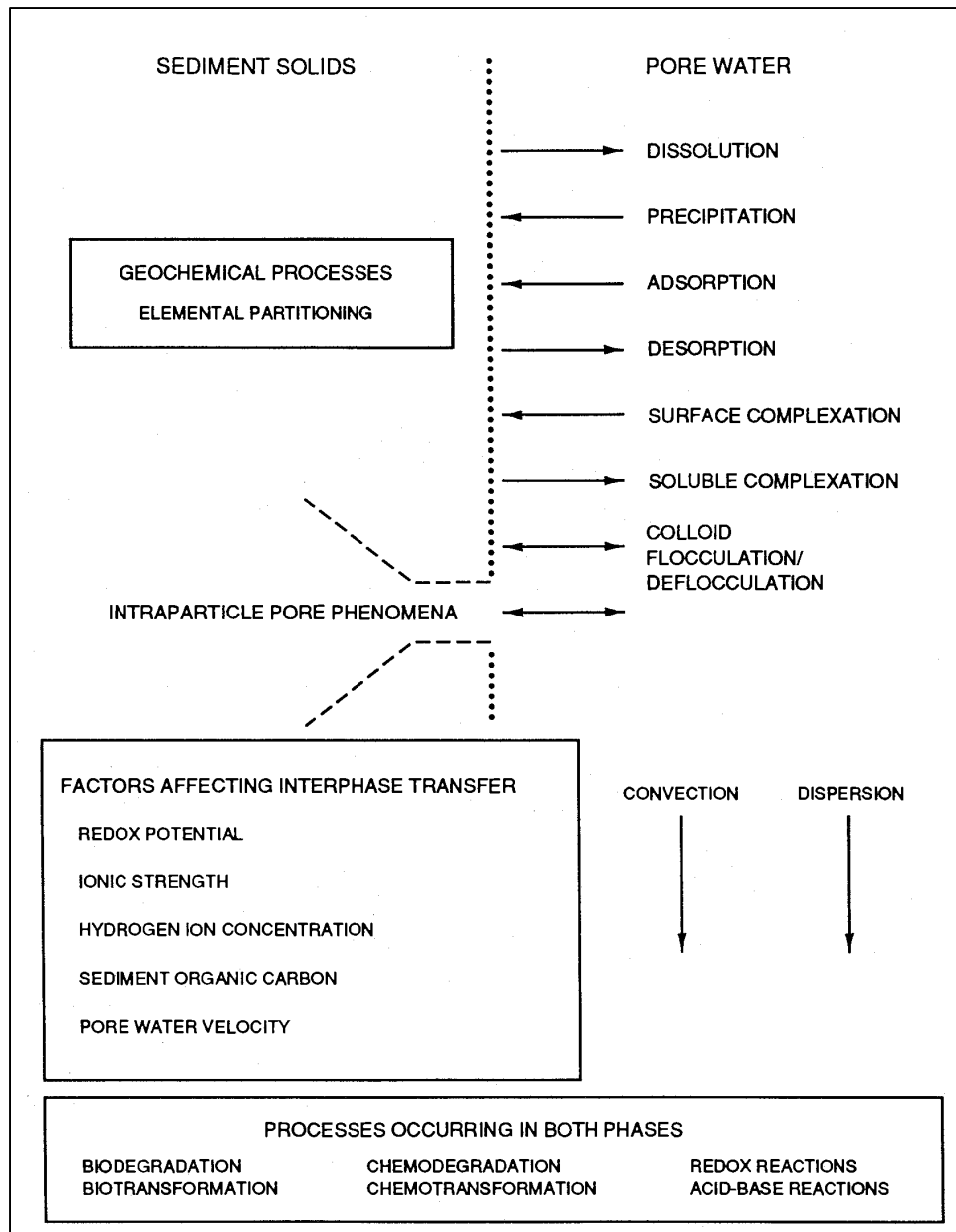

Figure D-2. Interphase transfer processes and factors affecting interphase transfer processes

where

$K_d$  = equilibrium distribution coefficient, L/kg

$q$  = contaminant concentration in solid phase at equilibrium, mg/kg

$C$  = contaminant concentration in aqueous phase at equilibrium, mg/L

Equation D-1 describes the equilibrium distribution of a single contaminant in a dredged material; that is, equilibrium distribution coefficients are contaminant and dredged material specific.  $K_d$  is affected by various factors

(sediment oxidation status, pH, and ionic strength). Varying these factors during leaching can shift the equilibrium position of the system and change  $Kd$ .

### D.2.2 Equilibrium-controlled desorption in a CDF

The assumption of equilibrium-controlled desorption in a CDF is based on two arguments: (a) the intuitive argument that the interphase transfer rates affecting leachate quality are fast relative to the volumetric flux of pore water in CDFs and (b) the argument that equilibrium-controlled desorption provides conservative predictions of leachate quality. This section discusses these arguments. The term “desorption” as used here and in the remainder of the leachate discussion refers to the composite effect of the elementary interphase transfer processes shown in Figure D-2.

Contaminated dredged materials are usually fine-grained and have hydraulic conductivities in the range of  $10^{-8}$  to  $10^{-5}$  cm/sec. When the hydraulic conductivity is this low, pore water velocity is also low for the gradients normally encountered in CDFs. Consolidation with excess pore pressure can yield greater localized gradients at the bottom. For gradients near 1, pore water velocities approximate hydraulic conductivities; that is, the water moves very slowly at velocities of  $10^{-8}$  to  $10^{-5}$  cm/sec.

When the rate at which water moves is slow relative to the rate at which equilibrium is approached, a local chemical equilibrium exists between the pore water and the sediment solids. The local equilibrium concept is illustrated in Figure D-3. The local equilibrium assumption implies that as a parcel of water passes a parcel of dredged material solids, the water and solids come to chemical equilibrium before the parcel of water moves to contact the next parcel of dredged material solids. Leachate quality at the surface of a CDF will differ from leachate quality at the bottom of a CDF, while leachate in both locations will be in equilibrium with the dredged material solids. In reality, equilibrium-controlled desorption requires an infinitely fast desorption rate. However, if the critical interphase transfer rates are sufficiently fast, the equilibrium assumption can yield results indistinguishable from full kinetic modeling (Jennings and Kirkner 1984; Valocchi 1985; Bahr and Rubin 1987).

In addition to being a good approximation, the assumption of equilibrium-controlled desorption is conservative; that is, predictions based on the equilibrium assumption will overestimate leachate contaminant concentrations for dredged material where contaminant desorption is occurring. However, the equilibrium assumption is not conservative in the foundation soils where contaminant adsorption, retardation, and diffusion occurs, because less contaminants would be removed from the leachate as it passes through the foundation soils than would be removed if equilibrium were achieved. The equilibrium assumption is conservative because interphase transfer is from the dredged material solids to the pore water, and equilibrium means that all of the desorption that can occur has occurred. Thus, for clean water entering the dredged material, pore water contaminant concentrations cannot be higher than the equilibrium value.



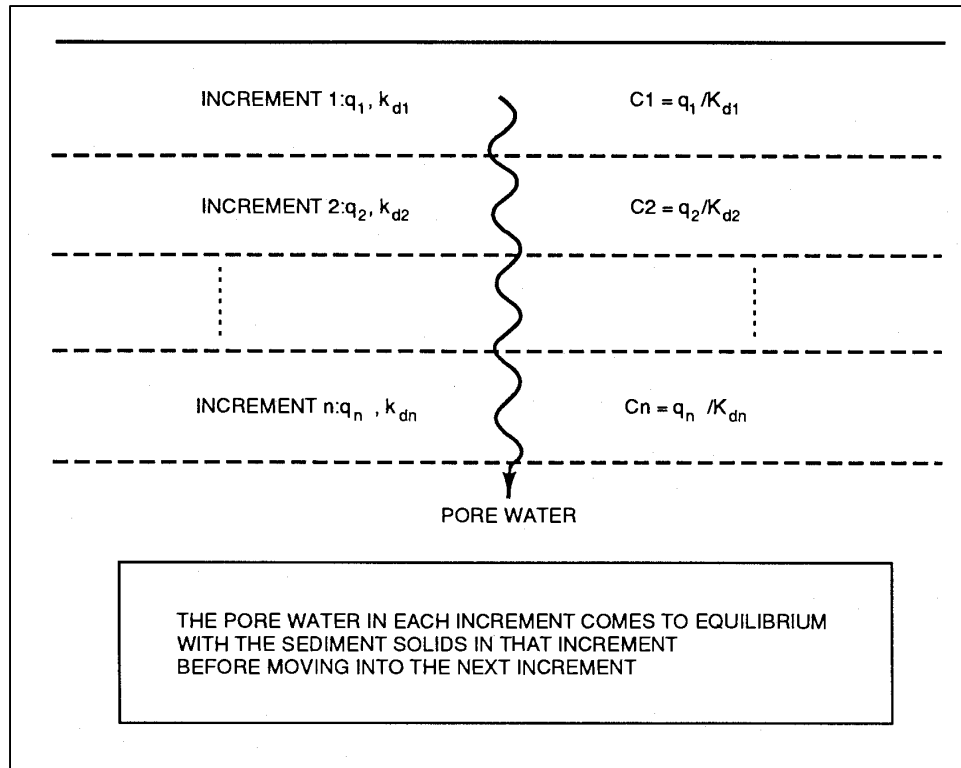

Figure D-3. Illustration of local equilibrium assumption for leaching in a CDF

### D.2.3 Oxidation status of sediment

Neither hydraulic nor mechanical dredging adds sufficient oxygen to overcome the sediment oxygen demand of fine-grained sediments. As a result, the dredged material in a CDF remains anaerobic except for a surface crust that may develop if the CDF dewateres by evaporation and seepage. Such an oxidized crust may eventually be several feet thick but seldom represents a significant portion of the vertical profile for the typically fine-grained material in CDFs. An aerobic leaching procedure may be necessary if the full lift thickness is dewatered prior to disposal of the next lift. Sequential batch leaching of aerobic, aged sediment can be used to simulate leaching of the surface crust in a CDF (Brannon, Myers, and Tardy 1994).

### D.2.4 Ionic Strength

Sequential batch leaching of freshwater sediments usually yields desorption isotherms such as shown in Figure D-4 (Brannon, Myers, and Tardy 1994). This is what is known as a classical desorption isotherm. Its key feature is a single distribution coefficient that is constant throughout the sequential leaching procedure. A commonly observed feature of desorption isotherms for metals in freshwater sediments is that they do not go through the origin but rather intercept the ordinate at some other point. The intercept indicates the amount of metal in geochemical phases that are resistant to aqueous leaching.

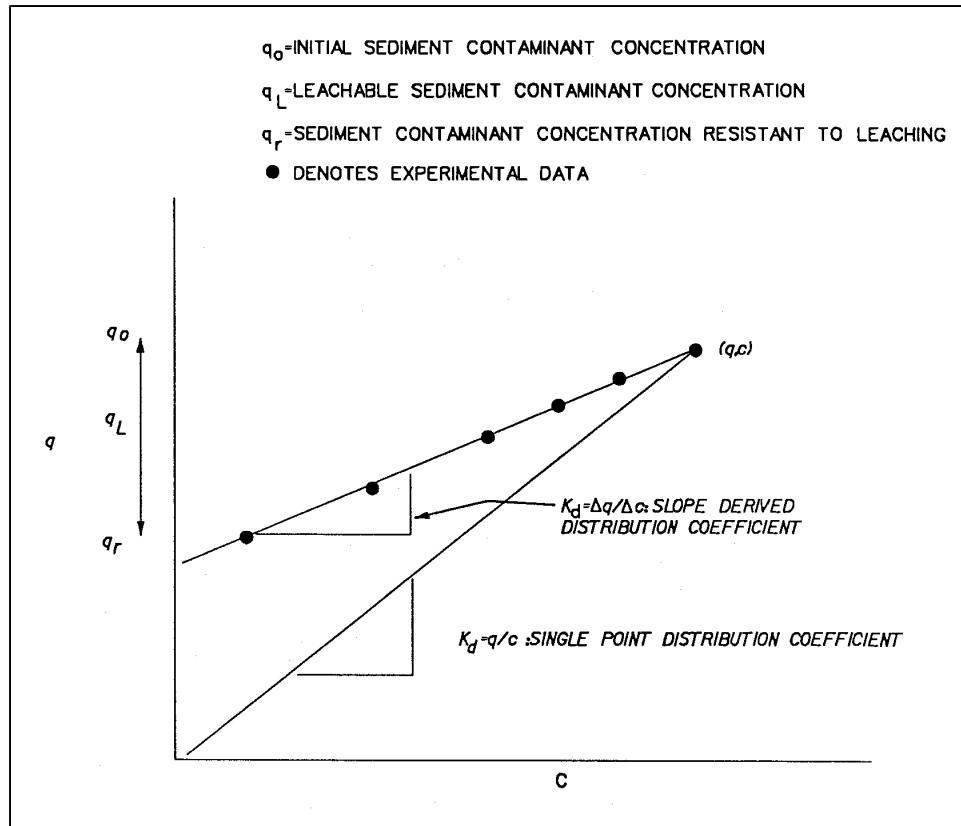

Figure D-4. Desorption isotherms for slope-derived and single-point distribution coefficients

The general form of the  $q$  versus  $C$  relationship for classical desorption isotherms is as follows:

$$q = K_d C + q_r \quad (D-2)$$

where  $q_r$  is contaminant concentration in solid phase resistant to leaching, mg/kg

Nonconstant distribution of contaminants between dredged material solids and water is commonly observed during leaching of estuarine sediments (Brannon et al. 1989; Brannon, Myers, and Price 1990; Brannon et al. 1991). Nonconstant contaminant partitioning yields batch isotherms for which the distribution coefficient changes as the solid phase concentration  $q$  decreases during sequential leaching, until a turning point is reached (Figure D-5). At the turning point, the distribution coefficient becomes constant and desorption begins to follow the classical isotherm. The nonconstant distribution coefficient portion of the desorption isotherm is related to elution of salt.

As salt is eluted from estuarine sediments, the ionic strength of the aqueous phase is reduced. According to the Gouy-Chapman model of charge distribution in double layers, decreasing the ionic strength increases repulsive forces (Stumm and Morgan 1981) and causes the double-layer thickness between colloids to increase. Flocculated colloidal matter becomes increasingly deflocculated and more easily entrained in flow. The overall effect is an increase in dissolved

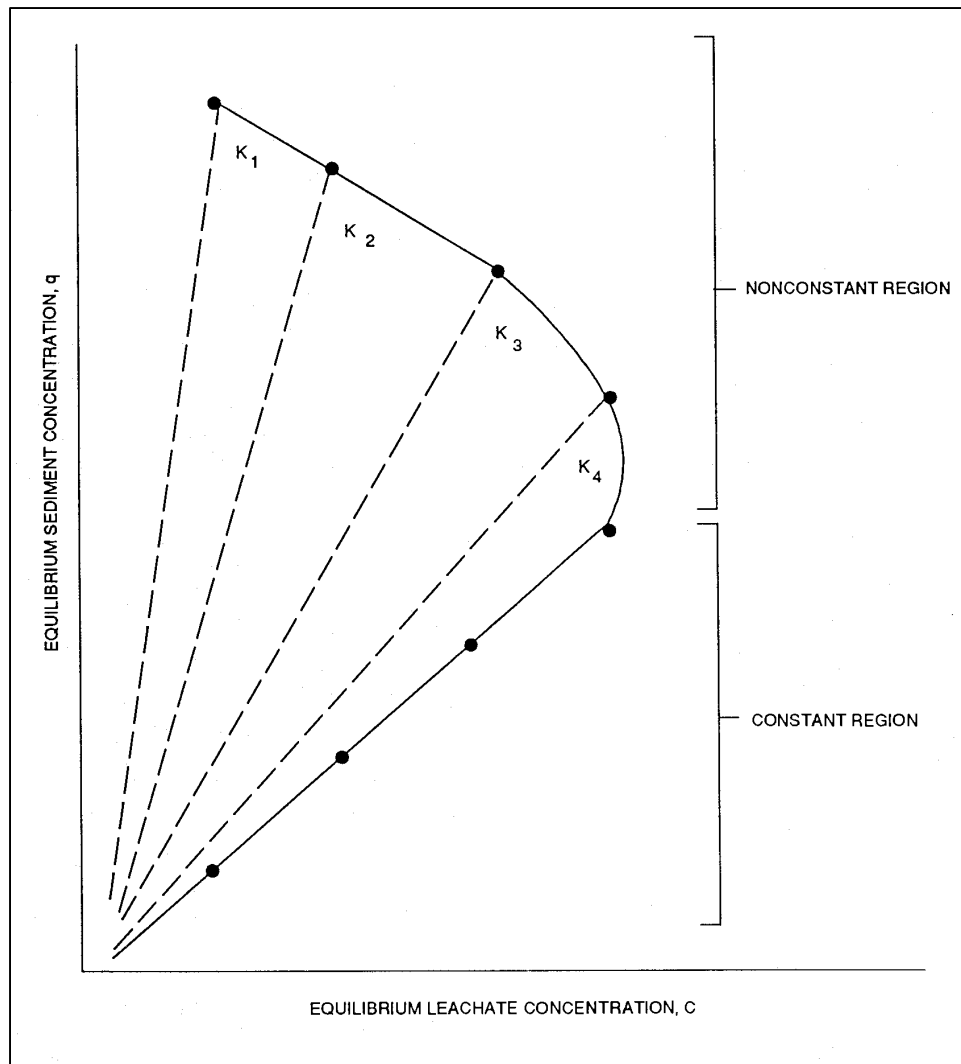

Figure D-5. Desorption isotherm illustrating nonconstant and constant partitioning

organic carbon (DOC) concentrations in the aqueous phase, mobilizing metals and organic contaminants bound to the colloidal matter (Brannon et al. 1991). For these reasons, the type of desorption isotherm shown in Figure D-5 is referred to as a DOC-facilitated desorption isotherm. Since the relationship of  $q$  versus  $C$  is not a one-to-one correspondence for DOC-facilitated desorption isotherms,  $q$  as a function of  $C$  cannot be developed from the isotherm.

The shear velocity at particle surfaces affects colloid release from sediment particles under the influence of decreasing ionic strength. The shear velocities developed by agitation during batch testing are infinitely large compared to the low shear velocities developed as water percolates through dredged material in a CDF. Colloidal mass release in a batch test, therefore, is not representative of colloidal mass release in a CDF under the influence of decreasing ionic strength. In addition, batch testing requires a liquid-solids separation step that alters the size distribution of colloids that are included in the dissolved phase. Thus, in a batch test, neither the mass nor the size distribution of colloidal release to pore

waters in a CDF is properly represented. For these reasons, it is difficult to couple results from sequential batch leaching with porous media fluid mechanics (advection and dispersion) and from this coupling predict leachate quality.

### D.2.5 Considerations in Test Selection and Test Conditions

This section presents recommendations for selecting the appropriate leach test and testing conditions, accounting for both the theoretical considerations described above and the practical aspects of testing. The selection of the appropriate test (SBLT or PCLT) and testing options and procedures are a function of the sediment salinity, the possible presence of Non-Aqueous Phase Liquids (NAPLs), CDF site conditions, and the COC. The following tabulation summarizes the recommended test for various sediment characteristics:

Sediment/ Site Characteristics	Recommended Leach Test
Sediments containing NAPL	PCLT
Saltwater Sediments with freshwater infiltration	PCLT
Saltwater Sediments without freshwater infiltration	SBLT
Freshwater Sediments	SBLT
Freshwater Sediments with Hydrophobic Organics as the only COC	SBLT (single cycle)

**Presence of NAPL.** If the sediments contain NAPLs, the PCLT is the recommended leachate test. During the SBLT, the physical process of agitation during the test has resulted in a release of trapped NAPL from the sediment matrix that would not be expected under field leaching conditions. Since the PCLT is conducted using a column, no agitation problems occur.

**Ionic strength.** Either the SBLT or PCLT may be used for freshwater dredged materials. Since the SBLT test is a simpler procedure and is more cost and time effective than the PCLT, the SBLT test would normally be preferred for freshwater sediments. The PCLT is recommended for saltwater sediments because of the influence of colloidal materials if the sediments are placed such that they are subject to freshwater infiltration, e.g., in an upland CDF. As salt is progressively leached from saline sediments during any leachate testing process, the colloids become destabilized and are subsequently released. Since the SBLT is a batch test, the aqueous phase concentrations of contaminants are obtained by centrifugation or filtration of the test samples. These processes remove a portion of the colloids, resulting in potentially erroneous results with saline sediments for the SBLT. The PCLT is a column leach test in which samples are obtained directly from the test column and analyzed without centrifugation or filtration, and any potential colloidal release is properly accounted for. For this reason, the PCLT test is required for saline sediments subject to freshwater infiltration.

**Hydrophobic organics.** Hydrophobic organics, such as PCBs or DDT and its metabolites, have *K<sub>d</sub>* values on the order of hundreds to thousands. Since such a small portion of the contaminant mass is partitioned to a given pore water

volume, test results will show little difference in sequential leach test cycles. So, results of an SBLT test on freshwater sediments will result in a “clustered” desorption isotherm for these compounds, with the data reduced essentially to a dot when plotted on the isotherm graph. For such clustered isotherms,  $K_d$  is the single point distribution coefficient. Therefore, if the only contaminants of concern are hydrophobic organics and these COCs are or are assumed to be reversibly sorbed with no subfraction resistant to leaching, a single-point isotherm, based on one SBLT test cycle, is sufficient.

**Challenge water.** Both the SBLT and PCLT involve “challenging” a sediment sample with water to produce a leachate sample for testing. The site conditions expected at the CDF should be considered in selecting the water used in the tests. Most leachate tests should be performed using deoxygenated, distilled-deionized (DDI) water, which is the appropriate challenge water to simulate leachate generated by freshwater infiltration via precipitation. Tests conducted with challenge water simulating acid rain conditions have shown no effects on results as compared to DDI water because of the buffering capacity of the sediments. Therefore, DDI water should be used for testing freshwater sediments and for saltwater dredged materials placed in upland CDFs. For saltwater dredged material placed in nearshore or island CDFs, the anticipated site conditions should be considered to determine if fresh or saline challenge water is appropriate. For example, some portions of sediments placed in nearshore or island CDFs constructed in brackish or saltwater may remain below the mean low water level and would never be exposed to freshwater infiltration. For these conditions, dredging site water would be the appropriate challenge water for leachate tests. In this case, salinity washout is not expected, and the SBLT is appropriate.

**Oxidation status of sediments.** Most leachate tests should be conducted using anaerobic sediment (no drying or oxidation prior to testing). Anaerobic sediments are appropriate for testing related to all nearshore or island CDFs in which the sediments will remain below the mean low water elevation. For upland CDFs, anaerobic conditions are also appropriate in most cases, since lower horizons of the dredged material will remain saturated and anaerobic, even if an aerobic surface crust develops. An aerobic leaching procedure (in which the sediments are dried and oxidized prior to testing) may be necessary if anticipated site management would result in dewatering the full lift thickness prior to disposal of all subsequent lifts.

### D.3 Sequential Batch Leach Test (SBLT) for Freshwater Sediments

The sequential batch leach test (SBLT), used to evaluate potential leachate quality in freshwater dredged material, involves exposing anaerobic dredged material to successive aliquots of anaerobic distilled-deionized water (<http://www.wes.army.mil/el/dots/pdfs/mpd941.pdf>). Sediment is prepared and loaded into centrifuge tubes under anaerobic conditions at a 4:1 water to sediment ratio, then sequentially leached for 24 hr with distilled-deionized (DDI)

water. Leachate is separated from sediment by centrifugation, and the leachate is chemically analyzed. Fresh DDI water<sup>1</sup> is added to the centrifuge tube to replace that removed, and the process is repeated a minimum of four complete cycles.<sup>2</sup>

### D.3.1 Materials and apparatus

- 450-mL stainless steel centrifuge tubes for organic contaminants
- 250-mL polycarbonate centrifuge tubes with leakproof caps for metals
- Weighing scale with sufficient capacity to accurately weigh centrifuge bottle, cap, and added sediment and water
- Glove box of sufficient size to contain centrifuge bottles, sediment, and scale
- High purity nitrogen gas
- DDI water conforming to American Society for Testing and Materials (ASTM) Type II (ASTM D1193-99) (ASTM 1999)
- Concentrated HCl
- Concentrated Ultrex HNO<sub>3</sub>
- Vacuum source
- Mechanical mixer
- Stainless steel spatula
- Paper towels
- Glass fiber filter, 1 micron, 47-mm diam, binder free, (Gelman Type A/E or equivalent)
- Glass fiber prefilters, 4 micron, 47-mm diam, binder free, (Whatman Type GD/F or equivalent)
- Cellulose acetate filters, 0.45 micron, 47-mm diameter, (Millipore or equivalent)
- Filtration manifolds for organics and metals
- High capacity tumbler
- Muffle furnace
- Oxygen meter

---

<sup>1</sup> DDI water is the appropriate challenge water when the sediments will be exposed to freshwater infiltration in the CDF. In some cases, dredging site water may be a more appropriate challenge water (see Section D.2.5).

<sup>2</sup> The distribution coefficient for hydrophobic organics is constant and on the order of hundreds to thousands. In this case, an SBLT test will result in a clustered desorption isotherm. Therefore, if the only contaminants of concern are hydrophobic organics, a single-point isotherm, based on one SBLT test cycle, is sufficient (see Section D.2.5).

- 1-L amber glass sample bottles for organic contaminants
- 250-mL plastic sample bottles for metals
- Dredged material

### D.3.2 Procedure

- For organic contaminant leaching, use clean stainless steel centrifuge tubes, stainless steel spatulas, and glass filtration apparatus according to instructions for analysis of organic contaminants in SW-846, Test Methods for Evaluating Solid Waste, U.S. Environmental Protection Agency, Office of Solid Waste and Emergency Response, Washington, DC 20460 (USEPA 1986). Combust glass fiber filter and prefilter at 400 °C for 15 min.
- For metal contaminant leaching, use clean polycarbonate centrifuge tubes, stainless steel spatulas, and polycarbonate filtration apparatus according to instructions for metals analysis in SW-846 (USEPA 1986).
- Prepare forms and labels. Conduct percent solids determination on mixed sediment sample and calculate solids and water content and required weights of water and sediment to achieve a water to solids ratio of 4:1 (weight of pore water + weight of distilled deionized (DDI) water/dry weight of sediment).
- Seal the glove box, and using alternate vacuum and nitrogen addition, purge and vent until the oxygen meter registers 0 percent. Ensure that a slight overpressure of nitrogen exists inside the glove box. This can be determined by observation of a slight expansion of the rubber gloves attached to the glove box.
- Add all necessary equipment to the glove box through the airlock. Cycle as necessary to remove any residual oxygen.
- In the glove box, remix the sediment to ensure uniformity. Place a centrifuge bottle with cap on the balance and record the weight. Tare the centrifuge bottle and cap and load with sediment to the desired weight. Record the weight of the sediment added. Tare the centrifuge bottle, cap, and added sediment, and add DDI water to bring the final water to sediment ratio to 4:1. Wipe sediment from any surface that contacts the o-ring of the leakproof top. Record the weight of DDI water, then zero the balance and record the weight of bottle, cap, sediment, and leach water. Bottles should be loaded such that pairs of bottles balance to within 2 g. For organic contaminants, multiple bottles may be required to obtain sufficient leachate (1 L) for chemical analysis.
- Ensure that all centrifuge bottles are sealed, then remove the bottles from the glove box, and transfer them to a tumbler. Tumble the samples for

24 hr at a rate of 40 revolutions per minute. Record the time tumbling starts and stops.

- h.* Remove the centrifuge bottles from the tumbler and place paired bottles opposite one another in a refrigerated centrifuge. Centrifuge stainless steel tubes for organic contaminant analysis at  $6,500 \times g$  for 30 minutes. Note: Stainless steel centrifuge tubes are heavy, limiting the speed of centrifugation. Leachates for metals are centrifuged at  $9,000 \times g$ .
- i.* Assemble the decontaminated filtration apparatus. For organic contaminants, the 4-micron prefilter is placed over the 1-micron glass fiber filter. Filter the samples, maintaining a nitrogen atmosphere over the samples while filtration is ongoing. Acidify leachate for organic analysis with 1 mL of concentrated HCl per liter of leachate to prevent iron precipitation and organic scavenging, then transfer sample to a precleaned, 1-L amber glass bottle. Bottles for analysis of organic contaminants should be filled to the top. For metals, much the same procedure is followed. Filter the sample through a 0.45-micron filter and acidify with 1 mL of concentrated Ultrex nitric acid per liter of leachate. Transfer leachate samples to plastic bottles for storage and analysis.
- j.* In the deoxygenated glove box, record the weight of the centrifuge bottle with lid and sediment after filtering. Repeat with remaining samples.
- k.* Add DDI water to the centrifuge tubes to bring them back to the same water to solids ratio of 4:1. Record the weight of bottle with lid, DDI water, and sediment. Repeat with remaining samples.
- l.* Tumble samples and centrifuge as described in steps *g* through *i*. Repeat a minimum of four times.
- m.* Using DDI water, prepare and run a procedure blank according to the procedure described above for one cycle.
- n.* Using DDI water, prepare a lab blank.

### D.3.3 Data presentation

The data for each contaminant of concern should be presented in separate tables that include the following information:

- Leachate concentration for each leach cycle
- Calculated sediment concentration ( $q$ ) for each leach cycle where  $q_i = -q_{i-1} - 4C_{i-1}$  and  $q_0$  equals the initial sediment concentration
- Contaminant distribution coefficient ( $K_d$ ), which is the slope of the linear regression of the leachate concentration for each leach, cycle,  $C$ , (x axis)



versus the sediment concentration,  $q$ , (y axis) for each leach cycle. Units for  $q$  are mg/Kg and units for  $C$  are mg/L. Units for  $K_d$  are L/kg.

## D.4 Pancake Column Leach Test for Estuarine Sediments

The Pancake Column Leach Test (PCLT), used to evaluate potential leachate quality in estuarine dredged material, serves as a laboratory-scale physical model of contaminant elution from dredged material that includes advection-dispersion, colloid, release, and other mass transfer effects. Contaminated sediment is mixed, weighed, and loaded into the column leach apparatus. DDI<sup>1</sup> water is introduced into the loaded column over an extended time interval. Water flow is controlled by a constant-volume pump. Leachate samples are collected at specified time intervals and are analyzed for COC.

### D.4.1 Column materials and apparatus

- Column Leach Apparatus (Figure D-6)
- Kg weighing scale
- Two 9/16-in. open-ended wrenches
- One 10-in. crescent wrench
- Mechanical mixer
- Polyethylene beaker (5,000 mL)
- Stainless steel spatula, 12 in.
- Stainless steel spatula, 6 in.
- Polyethylene scoop
- Paper towels
- Glass fiber filter, 1 micron, 257-mm diam, binder free, (Gelman Type A/E or equivalent)
- Polyethylene gloves

---

<sup>1</sup> DDI water is the appropriate challenge water when the sediments will be exposed to freshwater infiltration in the CDF. In some cases, dredging site water may be a more appropriate challenge water (see Section D.2.5).

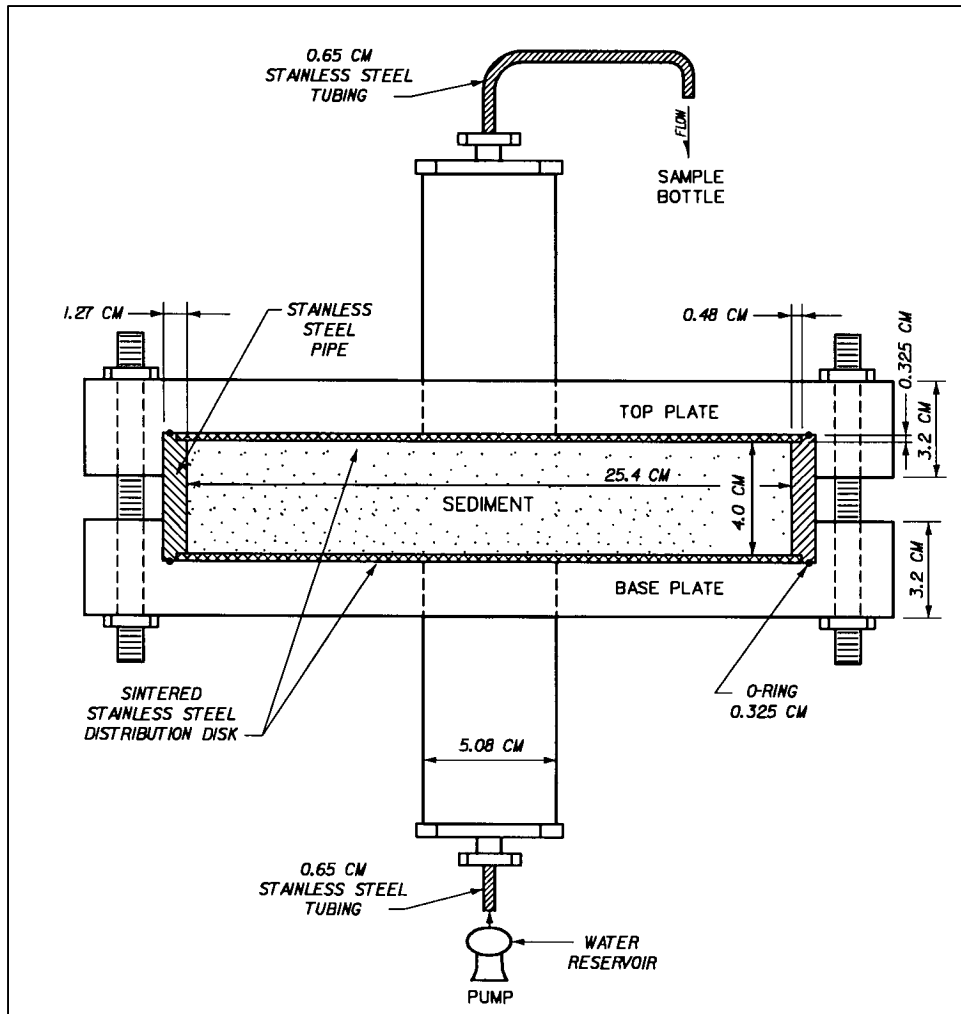

Figure D-6. Schematic of the Pancake Column Leach Test apparatus

- Teflon tubing (ID 5/32 in., OD 1/4 in.)
- Contaminated sediments
- Constant-volume metering pump (Example: Fluid Metering, Inc., Model # QG6-0-SSY and QG6-2-SSY)
- Dial indicator kit (Example: Fluid Metering, Inc., Q485-1)
- O-rings (ring diameter 10.75 in., OD 0.157 in.)
- Stainless steel plug valve, (Example: Hoke # 7312G4Y)
- Stainless steel tubing, (OD 1/4 in., ID 1/8 in.)
- Stainless steel tubing, (OD 1/8 in.)
- Compression fittings, (1/4 in. × 1/2 in.) and (1/4 in. × 1/8 in.)

- 5-gal glass bottle
- Support table for columns
- Detergent
- Deoxygenated, distilled-deionized (DDI) water conforming to ASTM Type II (ASTM D1193-99) (ASTM 1999).

#### **D.4.2 Column Preparation Procedure**

- a.* Assemble the Fluid Metering Pump and Dial Indicator Kit according to manufacturer's instructions.
- b.* Clean the column parts with a liquid, nonionic, metal-free, detergent solution, rinse thoroughly with DDI water, and let dry.
- c.* Screw the nuts onto the bottom of the threaded rods and insert the rods through the column base plate. Place the base plate in the 3-in.-diam hole on the table.
- d.* Using ¼-in. × ½-in. compression fittings, attach a 2-in. piece of ¼-in. stainless steel tubing to the inlet of the base plate. (Note: Use ¼-in. × ½-in. compression fittings to make all stainless steel/teflon tubing/plug valve/fluid pump connections.)
- e.* Connect a stainless steel plug valve to the 2-in. piece of stainless steel tubing. Use a suitable length of ¼-in. OD teflon tubing to connect the plug valve to the outlet side of the Fluid Metering Pump.
- f.* Attach a suitable length of ¼-in. OD, teflon tubing to the inlet side of the pump, and insert the opposite end of this tubing in a 5-gal glass bottle filled with deaired, DDI water. Securely cover the mouth of the bottle with parafilm.
- g.* Open the plug valve, and turn on the fluid pump. When the water level reaches the grooves inside the base plate, turn off the pump.
- h.* Place an O-ring inside the base plate making sure the O-ring is properly seated to avoid water leakage. Place a distribution disk in the base plate. Place a glass fiber filter on top of the distribution disk. Place the sediment chamber in the base plate, properly aligning it on top of the O-ring.
- i.* On a mechanical mixer, carefully mix the sediment. Mixing under an oxygen-free atmosphere is recommended.

- j.* Weigh the 5,000-mL beaker, spatula, and scoop. Use the scoop to transfer approximately 4 kg of sediment to the beaker. Record the total weight of the sediment, beaker, spatula, and scoop.
- k.* Slowly fill the sediment chamber with sediment from the beaker, while carefully avoiding entrapment of air bubbles. When the sediment is level with the top part of the sediment chamber, carefully smooth the surface of the sediment with the spatula. (**Note:** In order to properly seat the top distribution plate, clean the groove in the sediment chamber.)
- l.* Place a distribution plate on top of the sediment chamber. Place a glass fiber filter on top of the distribution plate. Wet the O-ring before placing it in the top groove of the sediment chamber.
- m.* Carefully place the top plate on the sediment chamber, aligning the plate with the threaded rods in the base plate. Tighten all nuts. Connect ¼-in. stainless steel tubing to the outlet of the top plate.
- n.* Connect a suitable length of stainless steel, or teflon tubing to the outlet of the top plate. (Teflon is recommended for leaching of metals.)
- o.* Set the dial indicator to obtain the correct flow rate for experimental conditions. Turn on the fluid pump, carefully check all areas for leaks, and tighten connections if necessary.
- p.* Reweigh the beaker, spatula, scoop, and sediment remaining in the beaker. Determine the weight of sediment in the column leach apparatus, by difference, and record this weight.

#### **D.4.3 Collection and preservation of column leachate samples for total metal, chloride ion, total organic carbon, pH, and electrical conductivity analyses**

This procedure describes the collection and preservation of samples generated from leaching of sediment and dredged material in laboratory column leaching apparatus. Column leachate samples are collected at a prescribed frequency, preserved with acid to pH < 2, and stored at 4 °C prior to metals, chloride ion, and total organic carbon (TOC) analyses. The pH and electrical conductivity are determined on discrete nonacidified samples.

##### **A. Sampling and preservation materials.**

- Analytical balance
- pH paper
- Parafilm, minimum 4 in. in width

- Labeling tape
- pH meter
- Electrical conductivity meter
- Clamp, large
- Ring stand
- Pipetter
- Pipet tips: 1 mL, 5 mL
- Polyethylene stirring rods
- Polyethylene bottles: 60, 250, 500, 1,000 mL  
*Note: All plastic ware must be prewashed with a metal-free, nonionic detergent solution, rinsed, soaked in 1 + 1 nitric acid for 24 hr, and rerinsed in distilled-deionized (DDI) water.*
- DDI water conforming to ASTM Type II Water (ASTM D1193-99) (ASTM 1999)
- Ultrex nitric acid, concentrated
- Ultrex sulfuric acid, concentrated

**B. Sample preservation procedure.**

- a. Place two strips of labeling tape on each polyethylene sample collection bottle. Consult the sample collection chart in Table D1, then pipette 0.5 mL DDI water and 0.5 ml concentrated Ultrex nitric acid per 100 mL of leachate sample for metal analysis into the polyethylene bottle. For TOC analysis, pipette 0.5 mL DDI water and 0.5 mL concentrated Ultrex sulfuric acid into the collection bottle. Weigh the bottle and lid, and record this weight on one strip of labeling tape.
- b. On the other strip of tape, label each collection vessel with the sediment identification, column leach apparatus number, sample number, and parameter code. Suggested parameter codes are M = metals, C = chloride, T = Total Organic Carbon, and PE = pH and electrical conductivity.
- c. Remove the lid, and securely cover each bottle with parafilm. Puncture a small hole in the center of the parafilm with a pipette tip.
- d. Attach a large clamp to a ring stand, and secure the collection bottle to the clamp. Place the bottle under the column leach apparatus, tilting, and elevating the bottle in such a manner that the end of the outlet tubing

is in contact with the acid solution in the bottle. Tightly seal the parafilm around the outlet tubing.

**C. Sample collection procedure.**

- a. Collect leachate samples at a prescribed frequency. Recommended frequency is provided in the Sample Collection Chart in Table D1.
- b. After collection, replace the lid, carefully mix the leachate sample, and reweigh. Determine the weight of sample collected, by difference, and record this weight.
- c. Insert a polyethylene stirring rod in the sample, and check the pH of the sample with pH paper. If the pH of the sample is greater than 2, add concentrated Ultrex nitric acid in 0.1-mL increments until the pH is less than 2.
- d. For chloride determination, weigh 40 g of leachate sample into a 60-mL polyethylene bottle. Label the bottle with the sediment identification, column leach apparatus number, sample number, and parameter code. Store samples at 4 °C.

<b>Table D1 Sample Collection Chart</b>		
<b>Sample Number</b>	<b>Approximate Sample Size (grams)</b>	
	<b>Metals</b>	<b>TOC</b>
1	250	100
2	250	100
3	250	100
4	250	100
5	250	100
6	250	100
7	500	250
8	500	250
9	500	250
10	500	250
11	500	250
12	500	250
13	500	250
14	500	250
15	500	250
16	500	250
17	500	250
18	500	250
19	500	250
20	1,000	500
21	1,000	500
22	1,000	500
23	1,000	500
24	1,000	500
25	1,000	500
26	1,000	1,000
27	1,000	1,000
28	1,000	1,000
29	1,000	1,000
30	1,000	1,000

- e. After each metal/chloride and TOC leachate sample has been collected, place a labeled, preweighed 20-mL polyethylene bottle under the column outlet. Collect approximately 12 g of leachate. (Reweigh the bottle to determine the exact weight of leachate.) Check the pH and electrical conductivity of this sample on a pH meter and electrical conductivity meter.

#### **D.4.4 Collection and preservation of column leachate samples for analysis of organic constituents**

This procedure describes collection and preservation techniques for samples generated from leaching of sediments, and dredged materials in laboratory column leaching apparatus. Column leachate samples are collected in amber glass bottles, in a prescribed manner. The samples are stored at 4 °C, then analyzed for polycyclic aromatic hydrocarbons (PAHs), polychlorinated biphenyls (PCBs), and other related organic constituents.

##### **A. Materials.**

- Analytical balance
- Labeling tape
- Fraction Collector, with the capability of time-based sample collection in seconds or minutes (Example: Eldex Laboratories, Inc., Model UP-1A)
- Silicone tubing, plasticizer-free, additive-free (1/8 in. ID × 1/4 in. OD and 1/4 in. ID × 3/8 in. OD)
- Amber glass bottles with Teflon-lined lids, precleaned to EPA Level 1: 1,000 mL
- Distilled-deionized (DDI) water conforming to ASTM Type II (ASTM D1193-99) (ASTM 1999).
- Methanol, pesticide grade or equivalent

##### **B. Procedure for preparation of fraction collector.**

- a. Assemble the Fraction Collector according to manufacturer's instructions, and place it on the table near the Column Leach Apparatus described previously. Attach a 12-in. section of silicone tubing (1/8-in. ID × 1/4-in. OD, cleaned with methanol and rinsed repeatedly with DDI water) to the outlet tubing on the Column Leach Apparatus.
- b. Attach 1/8-in. ID silicone tubing to the bottom of the glass tubes on the Fraction Collector. (This silicone tubing will be later connected to 1/8-in. stainless steel tubing inserted in lids used to cover the amber bottles during sample collection.)

- c. Remove the lids from two 1-L amber bottles. Drill four 1/8-in.-diam holes in each lid. Insert pieces of 1/8-in. stainless steel tubing, equal to the height of the amber glass bottle (plus about 2 in.), through each hole.

### **C. Procedure for sample collection.**

- a. Place a strip of labeling tape on each amber sample collection bottle. Weigh the bottle and lid, and record this weight on the tape.
- b. Label each collection vessel with the sediment identification, column leach apparatus number, sample number, and parameter code. Suggested parameter codes are PAH = polycyclic aromatic hydrocarbons, PCB = polychlorinated biphenyls.
- c. Remove the lids from the weighed bottle and replace them with the lids described above. Place the bottle on the base of the Fraction Collector. Connect the silicone tubing described above to the stainless steel tubing on top of the lids.
- d. Set the time-based control module on the Fraction Collector to collect a minimum of 500 mL of leachate sample per collection vessel.

### **D. Procedure for sample preservation.**

- a. After collection, place the original lid on each leachate sample, and reweigh. Determine the weight of sample collected, by difference, and record this weight.
- b. Immediately after collection, store samples at 4 °C.

### **E. Data presentation.**

The data for contaminant of concern should be presented in tables that include contaminant concentrations and concentrations of other relevant chemical species such as chloride ion, total organic carbon, pH, and electrical conductivity as a function of pore volumes eluted (T).

### **F. Data analysis.**

Column leach tests are laboratory-based physical models of contaminant leaching in a CDF, designed to show leachate concentration (C) as a function of pore volumes eluted (T). Unlike freshwater sediment leaching, where maximum leachate contaminant concentrations occur at the beginning of leaching, estuarine sediment leaching yields maximum leachate contaminant concentrations after a number of pore volumes have been leached. This phenomenon is the result of the release of colloids as ionic strength decreases. Examples of elution curves can be found in Myers, Brannon, and Tardy (1996) <http://www.wes.army.mil/el/dots/pdfs/trd961.pdf>.



The number of pore volumes required to reach the peak on contaminant elution curves can be used to estimate the time to reach maximum contaminant concentrations in a CDF. This time will depend on a number of site-specific factors that govern hydraulic flux. These factors include dredged material hydraulic conductivity, degree of saturation, and hydraulic gradients. A simple method for estimating the field time to peak leachate concentrations is as follows:

$$t_p = \frac{T_f L}{v_f} \quad (D-1)$$

where

$t_p$  = time to peak concentrations at bottom of a CDF, years

$T_p$  = pore volumes eluted to reach peak in laboratory leaching column

$L$  = depth of fill in CDF, m

$v_f$  = annual average pore water velocity in CDF, m/year

To use Equation F1, an estimate of the annual average pore water velocity is needed. In some cases, the annual average pore water velocity is approximated by the hydraulic conductivity of the dredged material. Better estimates can be obtained by modeling water movement in the CDF. The Hydrologic Evaluation of Leachate Production and Quality (HELPQ) model <http://www.wes.army.mil/el/elmodels/index.html#addams> is applicable for some CDFs. Full groundwater modeling using the GMS is an alternative but requires allocation of substantial resources for model calibration.

In addition to modeling water movement, contaminant transport can be modeled using the HELPQ or other groundwater and multi-media models. Contaminant transport modeling usually requires more than estimates of peak contaminant concentrations and pore volumes or time to peak concentrations. A mathematical formulation of the source term (Equation 1 in Myers, Brannon, and Tardy (1996) is required. Interim formulations for the source term are discussed in detail in Myers, Brannon, and Tardy (1996) <http://www.wes.army.mil/el/dots/pdfs/trd961.pdf>.

## D.5 References

- American Society of Testing and Materials. (1999). "Standard specification for reagent water," D1193-99, West Conshohocken, PA.
- Aziz, N. M., and Schroeder, P. R. (1999a). "Documentation of the hydrologic evaluation of leachate production and quality (HELPQ) module," Dredging Research Technical Note EEDP-06-20, U.S. Army Engineer Waterways Experiment Station, Vicksburg, MS.

- Aziz, N. M., and Schroeder, P. R. (1999b). "ADDAMS application: Hydrologic evaluation of leachate production and quality (HELPO) module in CDFs," Dredging Research Technical Note EEDP-06-21, U.S. Army Engineer Waterways Experiment Station, Vicksburg, MS.
- Bahr, J. M., and Rubin, J. (1987). "Direct comparison of kinetic and local equilibrium formulations for solute transport affected by surface reactions," *Water Resources Research* 23(3), 438-452.
- Brandon, D. L., Schroeder, P. R., and Lee, C. R. (1997). "Computerization of the decision-making framework effluent toxicity bioassay test results (LAT-E Program)," Technical Note EEDP-04-27, U.S. Army Engineer Waterways Experiment Station, Vicksburg, MS.
- Brannon, J. M., Myers, T. E., Gunnison, D., and Price, C. B. (1991). "Non-constant PCB partitioning in New Bedford Harbor sediment during sequential batch leaching," *Environmental Science and Technology* 45(6), 1082-1087.
- Brannon, J. M., Myers, T. E., and Price, C. B. (1990). "Factors affecting the behavior of metals in leachate," Environmental Effects of Dredging Technical Notes EEDP-02-13, U.S. Army Engineer Waterways Experiment Station, Vicksburg, MS.
- Brannon, J. M., Myers, T. E., and Price, C. B. (1992). "Leachate testing of Hamlet City Lake, North Carolina, sediment," Miscellaneous Paper D-92-5, U.S. Army Engineer Waterways Experiment Station, Vicksburg, MS.
- Brannon, J. M., Myers, T. E., and Tardy, B. A. (1994). "Leachate testing and evaluation for freshwater sediments," Miscellaneous Paper D-94-1, U.S. Army Engineer Waterways Experiment Station, Vicksburg, MS.
- Brannon, J. M., Pennington, J. C., Myers, T. E., and Price, C. B. (1989). "Factors affecting leachate quality," Environmental Effects of Dredging Technical Notes EEDP-02-11, U.S. Army Engineer Waterways Experiment Station, Vicksburg, MS.
- Environmental Modeling Research Laboratory. (1999). *Department of Defense groundwater modeling system v3.0 Reference Manual*, Brigham Young University, Provo, UT.
- U.S. Environmental Protection Agency/U.S. Army Corps of Engineers. (1998). "Evaluation of dredged material proposed for discharge in waters of the U.S. – Testing manual," EPA-823-B-98-004, Office of Water (4305), Washington, DC.
- Francingues, N. R., Jr., Palermo, M. R., Lee, C. R., and Peddicord, R. K. (1985). "Management strategy for disposal of dredged material: Contaminant testing and controls," Miscellaneous Paper D-85-1, U.S. Army Engineer Waterways Experiment Station, Vicksburg, MS.

- Hill, D. O., Myers, T. E., and Brannon, J. M. (1988). "Development and application of techniques for predicting leachate quality in confined disposal facilities; background and theory," Miscellaneous Paper D-88-1, U.S. Army Engineer Waterways Experiment Station, Vicksburg, MS.
- Jennings, A. A., and Kirkner, J. J. (1984). "Instantaneous equilibrium approximation analysis," *Journal of Hydraulic Engineering* 110(12), 1,700-1,717.
- Lee, C. R., Tatum, H. E., Simmers, J. W., Skogerboe, J. G., Folsom, B. L., Jr., Price, R.A., Brannon, J. M., Brandon, D. L., Price, C. L., Averett, D. E., and Palermo, M. R. (1992). "Evaluation of upland disposal of Oakland Harbor, California, sediment. Volume 1: Turning basin sediments," Miscellaneous Paper EL-92-12 v. 1, U.S. Army Engineer Waterways Experiment Station, Vicksburg, MS.
- Myers, T. E., and Brannon, J. M. (1991). "Technical considerations for application of leach tests to sediments and dredged material," Environmental Effects of Dredging Technical Notes EEDP-02-15, U.S. Army Engineer Waterways Experiment Station, Vicksburg, MS.
- Myers, T. E., Brannon, J. M., and Tardy, B. A. (1996). "Leachate testing and evaluation for estuarine sediments," Technical Report D-96-1, U.S. Army Engineer Waterways Experiment Station, Vicksburg, MS.
- Myers, T. E., and Schroeder, P. R. "Screening evaluations for confined disposal facility leachate quality," Environmental Effects of Dredging Technical Note (in preparation), U.S. Army Engineer Research and Development Center, Vicksburg, MS.
- Schroeder, P. R. (2000). "Leachate screening considerations," DOER Technical Notes Collection (ERDC TN-DOER-C16), U.S. Army Engineer Research and Development Center, Vicksburg, MS. [www.wes.army.mil/el/dots/doer](http://www.wes.army.mil/el/dots/doer)
- Schroeder, P. R., Aziz, N. M., Lloyd, C. M., and Zappi, P. A. (1994a). "The hydrologic evaluation of landfill performance (HELP) model: User's guide for version 3," EPA/600/R-94/168a, U.S. Environmental Protection Agency Office of Research and Development, Washington, DC.
- Schroeder, P. R., Dozier, T. S., Zappi, P. A., McEnroe, B. M., Sjostrom, J. W., and Peyton, R. L. (1994b). "The hydrologic evaluation of landfill performance (HELP) model: Engineering documentation for version 3," EPA/600/R-94/168b, U.S. Environmental Protection Agency Office of Research and Development, Washington, DC.
- Schroeder, P. R., and Palermo, M. R. (1995). "The automated dredging and disposal alternatives management system (ADDAMS)," Environmental Effects of Dredging Technical Note EEDP-06-12, U.S. Army Engineer Waterways Experiment Station, Vicksburg, MS.

- Streile, G. P., Shields, K. D., Stroh, J. L., Bagaasen, L. M., Whelan, G., McDonald, J. P., Droppo, J. G., and Buck, J. W. (1996). "Multimedia environmental pollutant assessment system (MEPAS): Source term formulations," PNL-11248, Pacific Northwest National Laboratory, Richland, WA.
- Stumm, W., and Morgan, J. J. (1981). *Aquatic chemistry*, Wiley, New York.
- U.S. Army Corps of Engineers. (1987). Confined disposal material," Engineer Manual 1110-2-5027, Washington, D.C.
- U.S. Army Corps of Engineers/U.S. Environmental Protection Agency. (1992). "Evaluating environmental effects of dredged material management alternatives - A technical framework," EPA842-B-92-008, Washington, DC.
- U.S. Environmental Protection Agency. (1979). "Methods for chemical analysis of water and wastes," EPA-600/4-79-020, Revised March 1983, Environmental Monitoring and Support Laboratory, Cincinnati, OH.
- \_\_\_\_\_. (1986). "Test methods for evaluating solid waste," SW-846, Office of Solid Waste and Emergency Response, Washington, DC.
- U.S. Environmental Protection Agency/U.S. Army Corps of Engineers. (1995). "QA/QC guidance for sampling and analysis of sediments, water, and tissues for dredged material evaluations - chemical evaluations," EPA-823-B-95-001, Washington, DC.
- Valocchi, A. J. (1985). "Validity of the local equilibrium assumption for modeling sorbing solute transport through homogenous soils," *Water Resources Research* 21(6), 808-820.

# Appendix E

## Evaluation of Mixing in Surface Waters

---

### E.1 Introduction

This appendix presents a variety of techniques for evaluating the size of mixing zones for effluent and surface runoff discharges from confined disposal facilities (CDFs) to surface water. Discussions of the applicability and limitations of the techniques and procedures for performing the required calculations or applying the models are presented.

#### E.1.1 Background

Whenever contaminant concentrations in a dredged material discharge are above WQS, there will be some limited initial mixing zone (or zone of dilution) in the vicinity of the discharge point where receiving WQS (WQS) may be exceeded. It is not possible to set universal standards for the acceptable size of mixing zones since receiving water conditions vary so much from one location to another. The 404(b)(1) Guidelines (U.S. Army Engineer Waterways Experiment Station (USAEWES 1976)) therefore instruct that, as part of the dredging permit process, the size of any proposed mixing zone should be estimated and submitted to the permitting authority. The permitting authority must then consider receiving water conditions at the proposed site and decide if the proposed mixing-zone size is acceptable.

Many state regulatory agencies may specify a limit to mixing-zone dimensions as a condition in granting the State water quality certification. In this case, the mixing zone necessary to meet applicable standards must not exceed the specified limits.

The size of a mixing zone depends on a number of factors including the contaminant or dredged material concentrations in the discharge, concentrations in the receiving water, the applicable WQS, discharge density and flow rate, receiving water flow rate and turbulence, and the geometry of the discharge vessel, pipeline, or outlet structure and the receiving water boundaries. Since the maximum allowable mixing zone specified by regulatory agencies is usually on the

order of hundreds of meters, the evaluation of mixing-zone sizes must necessarily be based on calculation of near-field dilution and dispersion processes.

There are a variety of possible estimation techniques for most real mixing-zone problems, but any choice of a suitable technique involves some trade-offs. The available techniques may be thought of as ranging from sophisticated computer models, which are sometimes capable of very accurate predictions, to simple approximations that yield order-of-magnitude estimates. The most sophisticated models may not run on a microcomputer, and they may require a considerable amount of effort and measured data for calibration of the model to a single site. By contrast, the simplest of approximations may be made on the basis of several simplifying assumptions and hand calculations.

### **E.1.2 Regulatory considerations**

Any evaluation of potential water column effects from effluent surface runoff discharges from CDFs should consider the effects of mixing. Section 230.3(m) of the 404(b)(1) Guidelines (USAEWES 1976) defines the mixing zone as follows:

The term “mixing zone” means a limited volume of water serving as a zone of initial dilution in the immediate vicinity of the discharge point where receiving water quality may not meet quality standards or other requirements otherwise applicable to the receiving water. The mixing zone should be considered as a place where wastes and water mix and not as a place where wastes are treated.

Further, Section 230.11(f) (USAEWES 1976) requires that:

The mixing zone shall be confined to the smallest practicable zone within each specified disposal site that is consistent with the type of dispersion determined to be appropriate by the application of these Guidelines. In a few special cases under unique environmental conditions, where there is adequate justification to show that widespread dispersion by natural means will result in no significantly adverse environmental effects, the discharged material may be intended to be spread naturally in a very thin layer over a large area rather than be contained within the disposal site.

### **E.1.3 Potential applications of initial mixing**

There are three potential applications of initial mixing evaluations:

- a.* Screening calculations under Tier II for water quality evaluations.
- b.* Evaluation of contaminant concentrations by comparison of discharge concentrations with WQS after allowance for mixing under Tier III.

- c. Evaluation of concentrations of suspended plus dissolved constituents by comparison with toxicity test results after allowance for mixing under Tier III.

#### **E.1.4 Evaluation of dissolved contaminant concentrations by comparison with WQS**

If necessary, the potential for water quality effects may be evaluated by comparison of predicted contaminant concentrations, as determined by screens or laboratory tests, with the WQS, considering the effects of mixing. The mixing evaluation need only be made for the contaminant requiring the greatest dilution to meet its WQS. The key information derived from the model is the maximum dissolved concentration of the contaminant at the boundary of the mixing zone. This concentration is compared to the applicable WQS. See Section 2.3.2, Chapter 2, maintext, for additional discussion of applicable WQS.

#### **E.1.5 Evaluation of concentrations of suspended plus dissolved constituents by comparison with toxicity test results**

The potential water column toxicity of the discharge material may be determined with toxicity tests evaluated in consideration of mixing. In this case, the dilution of the discharge expressed as a percent of the initial volume of disposed fluid in a given volume of water column is calculated. The key parameters derived from the evaluation are the maximum concentration of the discharge in the water column at the boundary of the mixing zone. These concentrations are compared to toxicity endpoints such as LC50 or EC50 as determined by toxicity tests.

#### **E.1.6 Physical characteristics of dredged material discharges**

Discharges of effluent or runoff from CDFs can be introduced to the receiving waters in a variety of ways including direct pipeline outfalls or open channels. For purposes of evaluation of initial mixing, barges or hopper dredge discharges are discrete discharges, while direct discharges of effluent, runoff, or leachate to surface water should be considered continuous discharges.

#### **E.1.7 Confined disposal facility (CDF) effluent discharge**

Dredged material, hydraulically placed in a confined disposal area, settles into a thickened deposit of material overlaid by a clarified supernatant. The supernatant waters are discharged from the site as effluent during active dredging operations. The effluent may contain both dissolved contaminants and suspended colloidal particles with associated (adsorbed or held by ion exchange) contaminants. Supernatant waters from confined disposal sites are discharged after a retention time of up to several days. Furthermore, actual withdrawal of the supernatant is governed by the hydraulic characteristics of the ponded area and the discharge weir. The effluent suspended solids concentration is typically

less than 100 mg/L for sediments dredged from estuarine environments and less than a few grams per liter for sediments dredged from freshwater environments. Since effluent is normally discharged from a hydraulically filled CDF over a time period of weeks while dredged material is being disposed in the CDF, the discharge can be assumed continuous for purposes of mixing-zone calculation.

### **E.1.8 Surface runoff discharge**

Runoff flowrate from a CDF is a function of the site conditions prior to a precipitation event, the intensity and duration of the precipitation event, and the degree to which water is controlled by ponding during and immediately following the precipitation event. Discharges of surface runoff normally occur over a period of days following an event. However, in northern latitudes there may be no runoff for long periods during freezing temperatures, followed by high runoff over a relatively short period during thawing.

## **E.2 Applicability of Models and Techniques**

### **E.2.1 General considerations**

General considerations for applicability of models for a variety of discharges, including discrete barge and hopper discharges, are discussed in the Inland Testing Manual (ITM). Only those considerations applicable to CDF discharges are discussed here.

### **E.2.2 Considerations for tidally influenced rivers and estuaries**

The assumptions necessary for evaluation of mixing are more difficult to satisfy in estuaries and the tidally influenced portions of rivers. The assumption that velocities in the water body near the mixing zone can be represented by a single mean velocity parallel to the bank is usually a reasonable one in the nontidally influenced portion of a river. However, it is not always acceptable in estuaries. Typically the downstream section of an estuary exhibits horizontal circulation patterns, so that the horizontal water velocity and direction vary with distance parallel to the bank, distance perpendicular to the bank, and time. Under these conditions, water near the mixing zone may not always travel parallel to the bank. Therefore, simple mixing-zone equations may not be applicable to the wide, open low-velocity sections of estuaries.

Also, mixing-zone equations are not theoretically applicable as the mean velocity tends to zero. This is because the equations are dependent upon the process of advection, which does not exist in the absence of a flow velocity, and also because the primary source of dispersion is assumed to be the turbulence caused by the horizontal movement of water. However, in a real water body, as the velocity tends to zero, the primary sources of turbulence and dispersion are the wind and waves.



The rate of change of water velocity resulting from tidal effects can also cause problems. The time taken for material to travel the length of the mixing zone should be an order of magnitude smaller than the time taken for a 10-percent change in the mean water velocity. It may be possible to satisfy this condition in a river, but it will probably not be possible to do so in most estuaries during a significant portion of the tidal cycle.

Another potential difficulty in estuaries is the phenomenon of stratification. Estuaries with low water velocities sometimes have a layer of relatively fresh water near the surface with a much more saline denser layer of water near the bottom and with quite a distinct interface between the two layers. The abrupt change of density at the interface tends to inhibit vertical mixing through the entire depth of the water column.

### E.2.3 Recommended models and techniques

Several models and approaches for evaluation of initial mixing for CDF discharges are provided in this appendix. Table E-1 provides a summary of the characteristics of the various types of dredged material discharges, hydrodynamic environments, and the models recommended for use in evaluation of initial mixing for those conditions. Descriptions of each of the models and details on applying the models are provided in the following sections of this appendix.

<b>Table E-1 Summary of Hydrodynamic Conditions and Applicable Models for CDF Effluent and Surface Runoff Discharges</b>			
<b>Applicable Model or Technique</b>	<b>Model Hydrodynamics</b>	<b>Section</b>	<b>Conditions</b>
Dilution Volume	Steady Uniform		General
MacIntyre	Steady Uniform	C4.0	Riverine
CORMIX <sup>1</sup>	Steady Uniform	C3.0	
TABS <sup>2</sup>	Unsteady Nonuniform	C5.0	Tidally influenced Rivers and Estuaries
<sup>1</sup> CD-CORMIX has not been developed and verified for national application. However, the fundamental processes contained in CD-CORMIX are applicable for continuous pipeline discharges and this model is currently under investigation for future use. <sup>2</sup> TABS has not been developed and verified for national application for the indicated discharges. However, the fundamental far-field processes contained in TABS are applicable for the indicated discharges and this model can be adapted for use on a regional basis. Note that the TABS model computes far-field effects only. Some independent near-field analysis is usually required.			

### E.3 Cornell Mixing Zone Expert System (CORMIX)

The Cornell Mixing Zone Expert System (CORMIX) is a steady state three-dimensional (3-D) model (Donekar and Jirka 1990). CORMIX was developed to predict the dilution and trajectory of a submerged single port discharge of arbitrary density (positive, neutral, or negative) into a stratified or uniform-density ambient environment with or without cross-flow. CORMIX is an

integral model that accounts for most near-field and some far-field steady state dynamics. CORMIX is presently designed for use in shallow water systems where the jet mixing processes are expected to encounter bottom boundary interaction. CORMIX is capable of representing negatively buoyant plume dynamics through application of mirroring principles; however, the present version does not include sediment settling and deposition.

The current version of the CORMIX model requires some modifications to extend its capabilities to simulate the characteristics of dredged material discharges. Efforts are underway for adaptations of the CORMIX model for simulating the mixing hydrodynamics of several types of dredged material discharges. When these efforts are completed, the revised CORMIX model will be included in subsequent revisions of this appendix.<sup>1</sup>

## **E.4 Macintyre Analytical Method for CDF Discharge in Riverine Conditions**

### **E.4.1 Introduction**

This section presents a simplified approach that is applicable to relatively shallow confined riverine water bodies. The method involves a simplistic two-dimensional (2-D) calculation based on dispersion principles (MacIntyre 1987). If the mixing-zone size as calculated using simple approximations is within mixing-zone guidelines specified by regulatory agencies, more precise calculations may not be necessary. The mixing-zone calculations depend on a number of assumptions that are difficult to satisfy for estuaries and the tidally influenced portions of rivers. The difficulties are discussed after the presentation of the procedure to be used for a riverine environment.

The analytical solution technique for calculating mixing-zone size described in this section is based on theoretical and empirical relationships for dispersion as summarized by Fischer et al. (1979). Only equations for calculating mixing-zone size resulting from a single-point discharge are presented.

A schematic illustrating a typical single-source effluent discharging into a receiving water body is shown in Figure E-1. For such a condition, the mixing-zone length extends downstream and the body of the mixing zone remains close to the shoreline of the receiving water body.

---

<sup>1</sup> The latest release of CORMIX (Version 2.10) can be obtained without charge from U.S. EPA Office of Research and Development, Center for Exposure Assessment Modeling (CEAM), Athens Environmental Research Laboratory, 960 College Station Road, Athens, Georgia 30605-2720. CORMIX can be either downloaded from CEAM's on-line Bulletin Board System by calling 1-706-546-3402 (FTS 250 3402), or sent through the mail by sending user-supplied diskettes or 9-track magnetic tapes to the CEAM Model Distribution Coordinator at the above address. User documentation is also available from the same source.

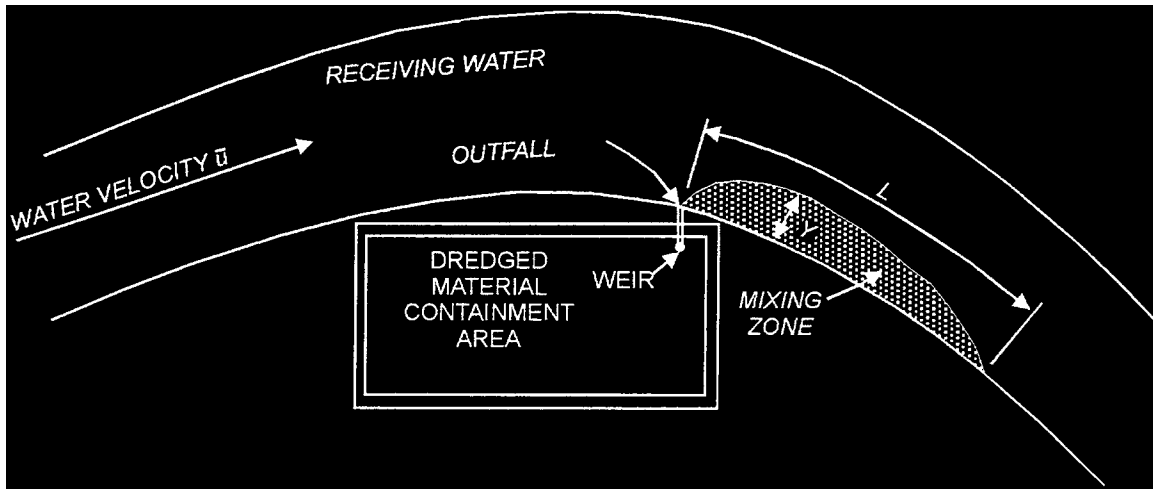

Figure E-1. Schematic of typical single-source effluent discharging into a receiving water body with unidirectional flow

#### E.4.2 Data requirements

The following data are required for evaluating mixing-zone sizes for confined disposal area effluents:

- a. Effluent concentrations at the point of discharge and receiving water background concentrations for all contaminants of concern.
- b. WQS applicable at the limit of the allowable mixing zone for all contaminants of concern.
- c. Depth, cross-sectional area, and current velocity of the receiving water body during expected low flow conditions during the period of dredging.
- d. Effluent volumetric flow rate.

#### E.4.3 Calculation procedure

- a. *Step 1.* Verify that the assumptions on which the equations depend are reasonable for conditions at the proposed discharge site.
- b. *Step 2.* Use effluent, receiving water, and WQS concentrations of all contaminants of concern to identify the critical contaminant. The critical contaminant is the one that requires the greatest dilution, which will define the boundary of the mixing zone. If mixing evaluations are conducted for toxicity test results, the background concentration of dredged material is assumed to be zero and the percentages of dredged material are used to calculate the required dilution.
- c. *Step 3.* Use receiving-water depth and velocity data to calculate a lateral mixing coefficient. This coefficient is a measure of how rapidly the effluent is dispersed through the receiving water.

- d. *Step 4.* Calculate mixing-zone length.
- e. *Step 5.* Check assumptions that depend on mixing-zone length.
- f. *Step 6.* Calculate the maximum width of the mixing zone.

**Step 1 - Assumptions.** In order to apply the analytical solution described in this section, the following assumptions are required:

- a. No major change in cross-sectional shape, sharp bends, major inflows or outflows, or obstructions to flow exist in the receiving water body in proximity to the mixing zone.
- b. The receiving water body can be reasonably approximated by a shallow rectangular cross section.
- c. The confined disposal area effluent enters the receiving water as a point source at the bank with negligible horizontal momentum.
- d. Differences in density between the effluent and receiving water and in settling rates of suspended particles within the boundary of the mixing zone are negligible.
- e. The flow condition in the vicinity of the mixing zone can be approximated as a steady-state velocity flowing parallel to the bank of the receiving water.
- f. The major cause of dispersion in the receiving water body is the turbulence and shear flow associated with the horizontal water flow.
- g. The effluent plume is vertically well mixed, so that contaminant concentrations do not vary significantly with depth.
- h. The width of the effluent plume is small enough that its lateral dispersion is not restricted by the opposite bank of the receiving water body.

**Step 2 - Identify critical contaminant.** It is necessary to calculate the dilution required within the mixing zone in order to reach applicable WQS for all contaminants of concern. This requires an estimate of the effluent concentrations of regulated contaminants. The contaminant that requires the greatest amount of dilution should be calculated as described in Chapter 4, Section 4.3.1, of the main text.

The maximum boundary of the mixing zone will be defined as the isopleth (line of constant concentration) where the concentration of the most critical contaminant is reduced to the concentration specified by the appropriate WQS. It should be noted that if background concentrations exceed the WQS, the concept of a mixing zone is inapplicable.

This approach for calculating required dilution is not applicable to turbidity (an optical property of water), which is reduced in a nonlinear fashion by dilution. A correlation curve for total suspended solids (TSS) versus turbidity may be used to define the TSS concentration corresponding to the WQS for turbidity. Such correlation curves will need to be empirically determined for each discharge.

**Step 3 - Estimate of lateral mixing coefficient.**

- a. *Step 3.1.* The depth of a simplified rectangular cross section for the receiving water body should be calculated as follows:

$$d = \frac{A}{W} \tag{E-1}$$

where

$d$  = average depth of the receiving water body channel, m

$A$  = cross-sectional area of the channel, m<sup>2</sup>

$W$  = surface width of the channel, m

- d. Check to ensure that  $W$  is equal to or greater than 10 times the average depth  $d$ . If not, the estimate of a lateral mixing coefficient is likely to be inadequate.

- b. *Step 3.2.* Estimate the shear velocity by one of the following methods. In rivers where the mean channel slope is known, use:

$$u^* = \sqrt{gds} \tag{E-2}$$

In rivers where the channel slope is not known, use:

$$u^* = 0.1 \bar{u} \tag{E-3}$$

where

$u^*$  = shear velocity in receiving water, m/sec<sup>-1</sup>

$g$  = gravitational acceleration, 9.81 m/sec<sup>-2</sup>

$d$  = average channel depth, m

$S$  = slope of river bed (dimensionless)

$\bar{u}$  = average of instantaneous velocities across the channel cross section, m/sec<sup>-1</sup>.

If the flow rate of the receiving water is known,  $\bar{u}$  can be calculated as the flow rate divided by the channel cross-sectional area. If the receiving-water flow

rate is not known,  $\bar{u}$  must be determined from velocity measurements taken at the proposed site. It should be noted that  $\bar{u}$  should not be determined over a period of time during which velocity changes occur as a result of changes in the receiving-water flow rate.

- c. *Step 3.3.* Estimate the lateral mixing coefficient by using one of the following equations.

$$\text{In rivers: } E_t = 0.3 d u^* \quad (\text{E-4})$$

$$\text{In estuaries: } E_t = 0.4 d u^* \quad (\text{E-5})$$

where

$E_t$  = lateral mixing coefficient,  $\text{m}^2/\text{sec}^{-1}$

$d$  = average channel depth, m

$u^*$  = shear velocity,  $\text{m}/\text{sec}^{-1}$

The values of lateral mixing coefficient are derived from Fischer et al. (1979) and are based on experimental studies of dispersion in various rivers. Lateral mixing coefficients have been shown to vary widely from one location to another, and the above equations give the lowest reasonable values so that estimates of mixing zone size will be conservative.

**Step 4 - Estimate mixing-zone length.** If the assumptions presented earlier are valid, the mixing zone will have a shape similar to the one shown in Figure E-1. The length of the mixing zone (measured parallel to the bank) can be estimated as:

$$L = \left( \frac{1}{P E_t \bar{u}} \right) \left[ \frac{Q_e C_e}{(C_s - C_b) d} \right]^2 \quad (\text{E-6})$$

where

$L$  = mixing zone length, m

$Q_e$  = effluent volumetric discharge rate,  $\text{m}^3/\text{sec}^{-1}$

**Step 5 - Check length-dependent assumptions.**

- a. *Step 5.1.* The flow in the water body near the mixing zone can be treated as a steady-state flow as long as:

$$L \leq \frac{\bar{u} T_c}{10} \quad (\text{E-7})$$

where

$L$  = predicted mixing zone length, m

$\bar{u}$  = cross-sectional average velocity (instantaneous or averaged over a few minutes),  $\text{m}/\text{sec}^{-1}$

$T_c$  = time taken for the observed value of  $\bar{u}$  to change by 10 percent, in seconds

b. *Step 5.2.* The lateral dispersion of the effluent plume will not be restricted by opposite bank of the receiving water body as long as:

$$W \geq \sqrt{\frac{8 E_t L}{\bar{u}}} \quad (\text{E-8})$$

where  $W$  is surface width of receiving water channel, m.

c. *Step 6 - Estimate maximum width of mixing zone.* The maximum width of the mixing zone (measured perpendicular to the bank as shown in Figure E-1 can be estimated as:

$$Y = \frac{0.4840 Q_e C_e}{u(C_s - C_b)d} \quad (\text{E-9})$$

where  $Y$  is maximum width of the mixing zone, m.

#### E.4.4 Example mixing-zone calculation

Following is a hypothetical mixing-zone calculation designed to illustrate the use of the mixing-zone estimation equations. A proposed dredged material containment area is expected to discharge into a river 480 ft (146.3 m) wide. From a study of U.S. Geological Survey stream gage records, it is anticipated that while effluent will be discharged, the lowest river flow will be about 7,600  $\text{ft}^3/\text{sec}$  (212.8  $\text{m}^3/\text{sec}$ ) and that the river has a cross-sectional area of 4,000  $\text{ft}^2$  (371.6  $\text{m}^2$ ) at this flow rate. The local bed slope of the river is very variable because of sediment transport. The containment area is expected to have a peak discharge of 15 cfs. The only effluent contaminant that exceeds WQS will be cadmium, which is expected to have an effluent concentration of 3.5  $\mu\text{g}/\text{L}$ . The background concentration of cadmium in the river is below the detection limit of 0.1  $\mu\text{g}/\text{L}$ , and the applicable cadmium WQS is 0.25  $\mu\text{g}/\text{L}$ . It has been specified that the maximum acceptable mixing-zone size is a 750-ft (228.6-m) radius centered on the effluent outfall.

**Step 1 - Assumptions.** Since the purpose of this hypothetical problem is to demonstrate the use of the mixing-zone calculations, it has been defined so that all the assumptions on which the calculations depend are valid. Decisions on whether the assumptions are valid depend largely on the professional judgement of personnel familiar with the disposal site.

**Step 2 - Identify critical contaminant.** Cadmium is the only effluent contaminant that exceeds WQS for this example. It is therefore unnecessary to determine the critical contaminant.

**Step 3 - Estimate lateral mixing coefficient.**

a. *Step 3.1.* From the problem statements,

$$A = 4,000 \text{ ft}^2 (371.6 \text{ m}^2)$$

$$W = 480 \text{ ft} (146.3 \text{ m})$$

Calculate depth,

$$d = \frac{A}{W}$$

$$d = \frac{371.6 \text{ m}^2}{146.3 \text{ m}} = 2.54 \text{ m}$$

Check that  $W$  is greater than or equal to  $10d$ . It is.

b. *Step 3.2.* Since the local bed slope can vary because of sediment transport, the shear velocity should be estimated from the mean velocity. Calculate the mean velocity by dividing the river flow of  $7,600 \text{ ft}^3/\text{sec}$  ( $212.8 \text{ m}^3/\text{sec}$ ) by the cross-sectional area of  $4,000 \text{ ft}^2$  ( $371.6 \text{ m}^2$ ):

$$\bar{u} = \frac{7,600 \text{ cfs}}{4,000 \text{ ft}^2} = 1.90 \text{ ft/sec}^{-1} (0.579 \text{ m/sec}^{-1})$$

and calculate the shear velocity of the receiving waters as follows:

$$u^* = 0.1 \bar{u}$$

$$u^* = 0.1 (0.579 \text{ m/sec}^{-1}) = 0.0579 \text{ m/sec}^{-1}$$

c. *Step 3.3.* In rivers, the lateral mixing coefficient should be estimated as:

$$E_t = 0.3 d u^*$$

$$E_t = 0.3 (2.54 \text{ m}) (0.0579 \text{ m/sec}^{-1})$$

$$E_t = 0.0441 \text{ m}^2/\text{sec}^{-1}$$

**Step 4 - Estimate mixing-zone length.** Estimate using the problem statements:

$$Q_e = 15 \text{ cfs} (0.425 \text{ m}^3/\text{sec}^{-1})$$



$$C_e = 3.5 \text{ mg/L}^{-1} (3.5 \times 10^{-3} \text{ mg/L})$$

$$C_s = 0.25 \text{ mg/L}^{-1} (2.5 \times 10^{-4} \text{ mg/L})$$

$$C_b < 0.1 \text{ mg/L}^{-1} (1.0 \times 10^{-4} \text{ mg/L})$$

In order to be environmentally protective, it would be wise to assume that the background concentration is only just under the detection limit, rather than zero. Therefore use:

$$C_b = 1.0 \times 10^{-4} \text{ mg/L}$$

Calculate mixing-zone length:

$$L = \left( \frac{I}{P E_t \bar{u}} \right) \left[ \frac{Q_e C_e}{(C_s - C_b) d} \right]^2$$

$$L = \left[ \frac{I}{\pi(0.0441 \text{ m}^2/\text{sec}^{-1})(0.579 \text{ m}/\text{sec}^{-1})} \right]$$

$$\left\{ \frac{(0.425 \text{ m}^2/\text{sec})(3.5 \times 10^{-3} \text{ mg/L})}{[(2.5 - 1.0) \times 10^{-4} \text{ mg/L}](2.54 \text{ m})} \right\}$$

$$L = 190 \text{ m} (623 \text{ ft})$$

### Step 5 - Check length-dependent assumptions.

- a. *Step 5.1.* Verify that the flow of the water body near the mixing zone can be treated as a steady state flow.

$$L \leq \frac{\bar{u} T_c}{10}$$

therefore:

$$T_c \geq \frac{10L}{\bar{u}}$$

$$T_c \geq \frac{10(190 \text{ m})}{0.579 \text{ m}/\text{sec}^{-1}}$$

$$T_c \geq 3,280 \text{ sec} (55 \text{ min})$$

This is acceptable since the river flow will certainly not change by 10 percent in less than 1 hr.

b. Step 5.2:

$$W \geq \sqrt{\frac{8 E_t L}{u}}$$

$$W \geq \sqrt{\frac{8(0.0441 \text{ m}^2 / \text{sec}^{-1})(190 \text{ m})}{(0.579 \text{ m/sec}^{-1})}}$$

$$W \geq 10.8 \text{ m}$$

This condition is amply satisfied since W equals 146 m.

**Step 6 - Estimate maximum width of mixing zone.** Estimate the maximum mixing zone width as:

$$Y = \frac{0.484 Q_e C_e}{u(C_s - C_b)d}$$

$$Y = \frac{0.484(0.425 \text{ m}^3 / \text{sec}^{-1})(3.5 \times 10^{-3} \text{ mg/L})}{0.579 \text{ m/sec}^{-1} [(2.5 - 1.0) \times 10^{-4} \text{ mg/L}](2.54 \text{ m})}$$

$$Y = 3.3 \text{ m} (10.7 \text{ ft})$$

Since the mixing zone is predicted to have a length of 623 ft (190 m) and a maximum width of 10.7 ft (3.3 m), it is within the allowable limits of 750 ft (228.6 m) from the effluent outfall.

## E.5 Fasttabs Modeling System for Evaluation of Hydrodynamic Transport

Rivers, reservoirs, and estuaries have been modeled for a number of years using the USACE TABS numerical modeling system. TABS is a family of 2-D numerical models that can simulate hydrodynamic, sediment, and constituent transport processes in these water bodies. TABS has been used to simulate far-field dispersion of instantaneous and continuous dredged material discharges. Some independent near-field analysis is usually required. TABS can handle complex geometries and unsteady flow conditions. Either particulate or dissolved phases of dredged material can be modeled.

The TABS system consists of many separate programs that individually address different aspects of the modeling process (Thomas and McAnally 1990). These include mesh development, geometry input file generation, boundary condition definition, hydrodynamic input file generation, job status monitoring, and post-processing of the results.

A new graphical implementation of TABS (FastTABS) (Lin, Jones, and Richards 1991) has been developed that successfully addresses the need for efficient model setup, execution, and analysis. It is mouse driven with pull-down menus and requires a minimum of manual data entry to complete an application from start to finish. FastTABS was designed to allow easy application of each of the models in the TABS system which include hydrodynamics, constituent, and sediment transport. The FastTABS software runs on Macintosh and DOS-based personal computers as well as most UNIX workstations. A primer, user's manual, and tutorial are available.<sup>1</sup>

## E.6 Dilution Volume Method for CDF Effluent Discharges

### E.6.1 Approach

A simplified approach to evaluation of mixing zones for CDF effluent discharges is presented in this section in which the volume of water required for dilution is expressed as a rate of flow (USAEWES 1976). This approach is generally applicable in both riverine and estuarine conditions. However, the approach should only be applied where there is a discrete discharge source such as a conduit or a weir. Since the effluent discharge will occur at a specified rate  $V_p$ , the volume of ambient site water per unit time that would be required to dilute the discharge to acceptable levels can be defined as:

$$V_A = V_p D = V_p \left[ \frac{(C_e - C_{BG})}{(C_{WQ} - C_{BG})} \right] \quad (\text{E-10})$$

where

$V_A$  = volume of site water/unit time required for dilution, cfs

$V_p$  = rate of effluent discharge, cfs

$C_e$  = concentration of the contaminant in the effluent in ug/L

$C_{BG}$  = background concentration of the contaminant in the disposal site water in ug/L

$C_{WQ}$  = applicable WQS for the contaminant in ug/L

It is assumed that the mixing zone associated with an effluent discharge will resemble the shape in Figure E-2. Therefore, once the required volume per unit

---

<sup>1</sup> A limited government license allows USACE office use of the FastTABS software supplied through the USACE Waterways Experiment Station (WES). Other users may obtain the software from Brigham Young University, (801)-378-5713. The point of contact for additional information is: Dr. David R. Richards, USACE Waterways Experiment Station, 3909 Halls Ferry Road, Vicksburg, MS 39180-6199, (601) 634-2126.

time has been calculated, the next step is to determine the dimensions of the mixing zone.

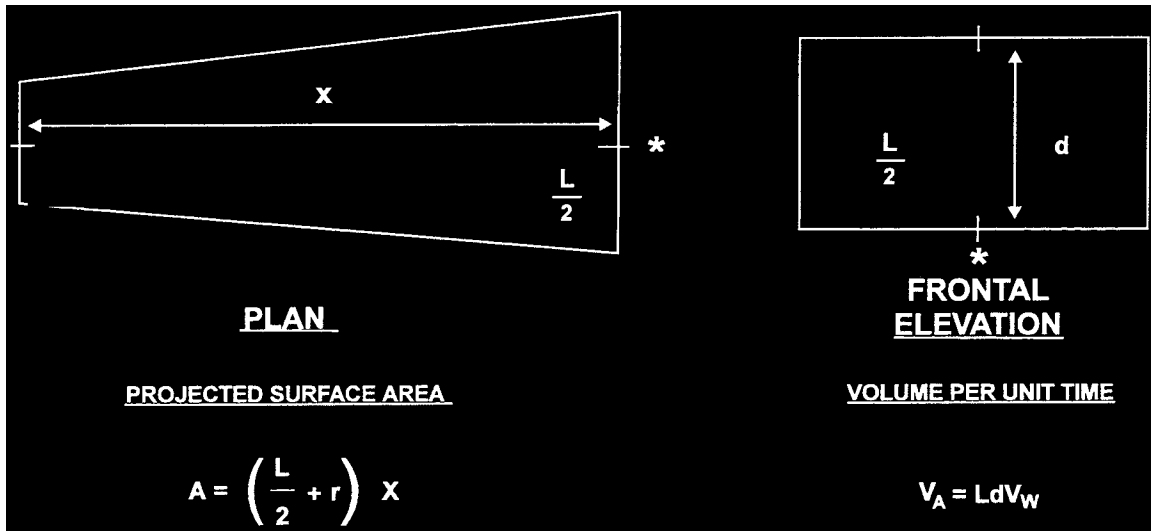

Figure E-2. Simplified shape assumed for mixing zone associated with an effluent discharge

The required volume per unit time can also be expressed as:

$$V_A = L d V_w \quad (\text{E-11})$$

where

$V_A$  = required volume of water per unit time, cfs

$L$  = width of mixing zone at time  $t$ , ft

$d$  = depth, ft

$V_w$  = velocity of water at disposal site, ft/sec

Since the depth and water velocity are known or can be measured, the width of the front edge of the mixing zone can be calculated as:

$$L = \frac{V_A}{d V_w} \quad (\text{E-12})$$

Based on Brooks (1960) and Johnson and Boyd (1975), the time required for the front edge of the mixing zone to spread laterally to the required width  $L$  can be computed from:

$$t = \frac{L}{I} (0.094 L^{2/3} - 0.149 r^{2/3}) \quad (\text{E-13})$$

where

$t$  = required time for lateral spreading, sec

$L$  = necessary width of the front edge of mixing zone, ft

$r$  = one-half initial width of the plume at point of discharge (radius of initial surface mixing), ft

$\epsilon$  = turbulent dissipation parameter

Values for  $\epsilon$  range from 0.00015 to 0.005 with a value of 0.005 being appropriate in a dynamic environment such as an estuary (Brandsma and Divoky 1976). As discussed earlier, values for  $r$  will be influenced by the method of disposal and will be site specific.

The calculated time can then be used to determine the longitudinal distance the discharge will travel as it is spreading to the required width. This distance can be computed from:

$$X = V_w t \quad (E-14)$$

where

$X$  = longitudinal movement of discharge, ft

$V_w$  = velocity of water at disposal site, ft/sec

$t$  = necessary time of travel, sec

The results of the previous equations can then be combined to estimate the projected surface area of the proposed discharge. This area can be computed as:

$$A = \frac{L + 2r}{2} X \quad (E-15)$$

where

$A$  = surface area, ft<sup>2</sup>

$L$  = width of front edge of mixing zone, ft

$r$  = radius of initial surface mixing, ft

$X$  = length of the mixing zone, ft

This approach will characterize a proposed discharge by defining the volume of dilution water per unit time that will be required to achieve some acceptable concentration at the edge of the mixing zone. Also, the length and width (and hence the surface area) of the necessary mixing zone will be approximated.

## E.6.2 Sample computations

The following computations are presented to illustrate the dilution volume method for a continuous effluent discharge.

The following input values are used in the sample computations:

Volume of effluent discharge per unit time $V_p$	= 44 cu ft/sec
Turbulent dissipation parameter ?	= 0.005
Water column depth $d$	= 10 ft
Water velocity $V_w$	= 0.5 ft/sec
Initial width of plume $2r$	= 30 ft
Background concentration $C_{BG}$	= 0.1 mg/L
Effluent discharge concentration $C_e$	= 30 mg/L
Applicable WQS, $C_{wQ}$	= 0.5 mg/L

The required volume per unit time will be:

$$V_A = V_p D = 44 \left( \frac{30 - 0.5}{0.5 - 0.1} \right) = 3,245 \text{ cu ft/sec} \quad (\text{E-16})$$

The required width of the mixing zone will be:

$$L = \frac{V_A}{d V_w} = \frac{3,245}{(10)(0.5)} = 649 \text{ ft} \quad (\text{E-17})$$

The time required to achieve the lateral spread  $L$  will be:

$$t = \frac{L}{0.005} \left[ (0.094)(649)^{2/3} - (0.149)(15)^{2/3} \right] = 1,228 \text{ sec} \quad (\text{E-18})$$

The length of the mixing zone will be:

$$X = (0.5 \text{ ft/sec})(1,228 \text{ sec}) = 614 \text{ ft} \quad (\text{E-19})$$

Thus the proposed mixing zone would have dimensions of:

$$\text{Surface area} = \left( \frac{30 + 649}{2} \right) 614 = 208,453 \text{ sq ft} \quad (\text{E-20})$$

*Maximum dimensions = 614 ft by 649 ft*

This information would be used in considering the compatibility of the size of the mixing zone required to dilute the discharge with the available mixing zone.

## E.7 References

- Ariathurai, R., MacArthur, R. C., and Krone, R. B. (1977). "Mathematical model of estuarial sediment transport," Technical Report D-77-12, U.S. Army Engineer Waterways Experiment Station, Vicksburg, MS.
- Bokuniewicz, H. J., Gebert, J., Gordon, R. B., Higgins, J. L., Kaminsky, P., Pilbeam, C. C., Reed, M., and Tuttle, C. (1978). "Field study of the mechanics of the placement of dredged material at open-water disposal sites," Technical Report D-78-7, U.S. Army Engineer Waterways Experiment Station, Vicksburg, MS.
- Bowers, G. W., and Goldenblatt, M. K. (1978). "Calibration of a predictive model for instantaneously discharged dredged material," EPA-699/3-78-089, U.S. Environmental Protection Agency, Corvallis, OR.
- Brandsma, M. G., and Divoky, D. J. (1976). "Development of models for prediction of short-term fate of dredged material discharged in the estuarine environment," Contract Report D-76-5, DACW39-74-C-0075, prepared by Tetra Tech, Inc., under contract to U.S. Army Engineer Waterways Experiment Station, Vicksburg, MS.
- Brandsma, M. G., and Sauer, T. C., Jr. (1983). "Mud discharge model: Report and user's guide," Exxon Production Research Co., Houston, TX.
- Brooks, N. H. (1960). "Diffusion of sewage effluent in an ocean current." *Proceedings of First International Conference on Waste Disposal in the Marine Environment*. Pergamon Press, New York, NY.
- Buhler, J., and Hauenstein, W. (1981). "Axisymmetric jets in a crossflow." *19th Congress of the International Association of Hydraulic Research*. New Delhi, India, February 1-8, 1981.
- Donekar, R. L., and Jirka, G. H. (1990). *Expert System for Hydrodynamic Mixing Zone Analysis of Conventional and Toxic Submerged Single Port Discharges (CORMIX1)*, PA/600/3-90/012, U.S. Environmental Protection Agency, Washington, DC.
- Fischer, H. R., List, E. J., Koh, R. C. Y., Imberger, J., Brooks, N. H. (1979). *Mixing in Inland and Coastal Waters*. Academic Press, Inc., New York, NY.
- Gowda, T. P. H. (1984a). "Critical point method for mixing zones in rivers," *J. Environ. Engineer., Am. Soc. Civil Engineers* 110, 244-262.

- Gowda, T. P. H. (1984b). "Water quality prediction in mixing zones of rivers," *J. Environ. Engineer., Am. Soc. Civil Engineers* 110, 751-769.
- Jirka, G. H., Stalzenbach, K. D., and Adams, E. E. (1981). "Buoyant surface jets," *J. Hydraul. Engineer. Am. Soc. Civil Engineers* 107, 1,467-1,487.
- Johnson, B. H. (1990). "User's guide for models of dredged material disposal in open water," Technical Report D-90-5, U.S. Army Engineer Waterways Experiment Station, Vicksburg, MS.
- Johnson, B., and Boyd, M. B. (1975). "Mixing zone estimate for interior guidance," Unpublished Memo., Mathematical Hydraulics Division, Hydraulics Laboratory, U.S. Army Engineer Waterways Experiment Station, Vicksburg, MS.
- Johnson, B. H., McComas, D. N., McVan, D. C., and Trawle, M. J. (1993). "Development and verification of numerical models for predicting the initial fate of dredged material disposed in open water. Report 1, Physical model tests of dredged material disposal from a split-hull barge and a multiple bin vessel," Technical Report DRP-93-1, U.S. Army Engineer Waterways Experiment Station, Vicksburg, MS.
- King, I. P. (1992). "A finite element model for stratified flow-RMA10-user's guide-Version 4.3," Report prepared by Resource Management Associates for U.S. Army Engineer Waterways Experiment Station, Vicksburg, MS.
- Koh, R. C. Y., and Chang, Y. C. (1973). "Mathematical model for barged ocean disposal of waste," Environmental Protection Technology Series EPA 660/2-73-029, U.S. Army Engineer Waterways Experiment Station, Vicksburg, MS.
- Kraus, N. C. (1991). "Mobile, Alabama, field data collection project, 18 August-2 September 1989. Report 1, Dredged material plume survey data report," Technical Report DRP-91-3, U.S. Army Engineer Waterways Experiment Station, Vicksburg, MS.
- Lin, H. J., Jones, N. L., and Richards, D. R. (1991). "A microcomputer-based system for two-dimensional flow modelling." *Proceedings of the 1991 National Conference on Hydraulic Engineering*. American Society of Civil Engineers, Nashville, TN.
- MacIntyre, D. F. (1987). "Interim procedures for estimating mixing zones for effluent from dredged material disposal sites," Technical Note EEDP-04-5, U.S. Army Engineer Waterways Experiment Station, Vicksburg, MS.
- Motz, L. H., and Benedict, B. A. (1972). "Surface jet model for heated discharges," *J. Hydraul. Div., Am. Soc. Civil Engineers* 98, 181-199.
- Prakash, A. (1977). "Convective-dispersion in perennial streams," *J. Environ. Engineer., Am. Soc. Civil Engineers* 103, 321-340.



- Schroeder, P. R., and Palermo, M. R. (1990). "Automated dredging and disposal alternatives management system, user's guide," Technical Note EEDP-06-12, U.S. Army Engineer Waterways Experiment Station, Vicksburg, MS.
- Stefan, H., and Gulliver, J. S. (1978). "Effluent mixing zone in a shallow river," *J. Environ. Engineer., Am. Soc. Civil Engineers* 104, 199-213.
- Thomas, W. A., and McAnally, W. H., Jr. (1990). "User's manual for the generalized computer program system: Open-channel flow and sedimentation, TABS-2," Instruction Report HL-85-1, U.S. Army Engineer Waterways Experiment Station, Vicksburg, MS.
- U.S. Army Engineer Waterways Experiment Station. (1976). "Ecological evaluation of proposed discharge of dredged or fill material into navigable waters, interim guidance for implementation of Section 404(b)(1) of Public Law 92-500 (Federal Water Pollution Control Act Amendments of 1972)," Miscellaneous Paper D-76-17, Vicksburg, MS.
- Wright, S. J. (1984). "Buoyant jets in density-stratified crossflow," *J. Hydraul. Engineer., Am. Soc. Civil Engineers* 110, 643-656.
- Zeller, R. W., Hoopes, J. A., and Rohlich, G. A. (1971). "Heated surface jets in steady crosscurrent," *J. Hydraul. Engineer., Am. Soc. Civil Engineers* 97, 1403-1426.

# Appendix F

## Laboratory Evaluation of Volatile Emissions and Volatile Dispersion Modeling

---

### F.1 Introduction

This appendix provides procedures for conducting laboratory tests for the evaluation of volatile emissions from exposed sediments. The background, rationale, and tiered framework for application of these procedures are discussed in Chapter 7 of the main text of the Upland Testing Manual (UTM). Also provided in this appendix are equations for estimating on-site and off-site volatile contaminant exposure concentrations.

This chapter contains two procedures:

- a. Laboratory volatile emission test procedure.
- b. Volatile exposure evaluation.

### F.2 Laboratory Volatile Emission Test Procedure

Actual measurements of volatile contaminant of concern (COC) may be needed in order to determine emissions under a variety of site environmental and operational conditions for which spreadsheet models described in Chapter 7 are not designed. Highest volatile COC concentrations tend to occur during initial loading or disposal stages (0-48 hr) of the sediment (Price et al. 1997, 1999; Ravikrishna et al. 1998; Valsaraj et al. 1999). The laboratory procedures described herein can be conducted to obtain data on the emission of volatile COC from dredged material. These data can be used in validated predictive volatile emissions models for dredged material. Actual volatile COC emissions from dredged material in place in a confined disposal facility (CDF) can be measured if there is a need to quantify emissions from CDF management procedures such as dredged material reworking.

The following laboratory procedures describe methods for obtaining initial contaminant fluxes from exposed sediment. The procedure involves sampling air that has been passed over the sediment surface. Sediment is prepared and loaded into a chamber, herein referred to as a “flux” chamber, which is sealed, and air is then passed over the sediment for a prescribed period. The exit air is passed through contaminant-specific adsorbent-filled air sampling tubes that can be analyzed for volatile COC.

### **F.2.1 Apparatus**

The following items are required:

- a.* Flux chamber.
- b.* Air supply of sufficient purity not to interfere with emissions data and with a means to control a constant flow rate.
- c.* Laboratory air or compressed air from a cylinder may be used for pushing air over the sediment surface.
- d.* A vacuum pump can also be used to pull air over the sediment surface.
- e.* Flow meter used to determine air flow through the chamber with the ability to handle air flows of greater than 1 L/min.
- f.* Contaminant-specific air sampling tubes.<sup>1</sup>
- g.* Tygon tubing used to attach traps, supply air, and flow meter.

### **F.2.2 Flux chamber**

Flux measurements are conducted using a chamber detailed in Figure F-1. The chamber is constructed of two pieces of anodized aluminum, which are sealed together with an o-ring and threaded fasteners to ensure an airtight seal. The bottom portion of the chamber is designed to hold a 10-cm depth of sediment with a surface area of 375 cm<sup>2</sup>. The upper portion is grooved to provide an air space above the sediment for air flow and is designed with channels to distribute air flow uniformly across the sediment surface. A glass window can be inserted in the top portion of the chamber to allow for visual monitoring of the sediment surface.

---

<sup>1</sup> Supelco Inc., PA, supplies a wide variety of prepacked air sampling tubes. Table F-1 gives a list of commonly analyzed volatile compounds and appropriate sampling tube.

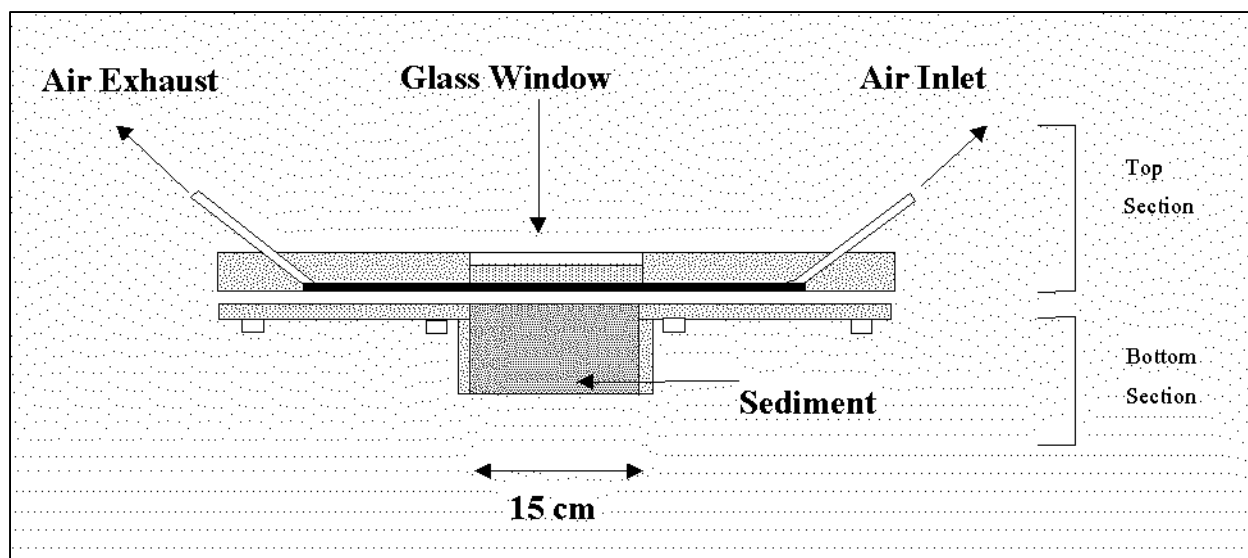

Figure F-1. Flux chamber for quantifying volatile emissions in a laboratory setting

<b>Table F1 Contaminant-Specific Air Sampling Tubes Available through Supelco, Inc., Bellefonte, PA, and Accompanying Analytical Method</b>			
<b>Contaminant</b>	<b>Trapping Material</b>	<b>Tube Type</b>	<b>Analytical Method</b>
Polychlorinated biphenyls	XAD-2	Orbo-44	EPA Method 8081
Polyaromatic Hydrocarbons	XAD-2	Orbo-44	EPA Method 8270
Total Recoverable Petroleum Hydrocarbons	XAD-2	Orbo-44	EPA Method 8270
Pesticides	XAD-2	Orbo-44	EPA Method 8081
Ammonia	H <sub>2</sub> SO <sub>4</sub> -coated silica gel	Orbo-554	OSHA Method 6015
Hydrogen Sulfide	Treated activated coconut charcoal	Orbo-34	NIOSH Method 6013
Dimethyl Sulfides	Carbosieve S-111 carbon	Orbo-91	NIOSH Method 2542
Methyl Mercaptans	Carbosieve S-111 carbon	Orbo-91	NIOSH Method 2542

### F.2.3 Sediment preparation

Sediment core or grab samples collected from the proposed area of dredging should completely fill storage containers and be immediately refrigerated (4 °C) following sampling to preserve sample integrity. Intact core samples, not removed to a storage container, should be immediately sealed and refrigerated. To ensure a representative sample, the sediment samples may be composited into one bulk sample or combined according to horizontal or vertical stratification. Approximately 20 L of material is needed to perform bulk sediment chemical and physical characterization and volatile emissions testing. This volume can be more or less depending upon the number of COC. If COC are trapped on the same type of material only one chamber is needed to measure emissions, an

example being that of sampling for PAHs and PCBs. If other COC that require different sorbent traps are present, additional flux chambers will need to be used. All samples should be thoroughly homogenized before conducting bulk sediment analysis and volatile emissions testing.

#### **F.2.4 Laboratory conditions**

Testing can be conducted at laboratory ambient temperatures or the chambers can be placed in temperature controlled water baths to give colder or warmer sediment temperatures.

#### **F.2.5 Laboratory volatile emissions test procedure<sup>1</sup>**

The step-by-step procedure for conducting volatiles emissions testing is outlined below:

**Step 1 – Loading flux chamber.** Fill flux chamber with a known amount of sediment to the top of the sediment well (10 cm in height). Ensure that the sediment surface is as level as possible to promote laminar air flow over the surface. Seal the chamber using an o-ring and threaded fasteners.

**Step 2 – Trap attachment.** Apply contaminant-specific air sampling tube to the exit port of the chamber. Sampling tubes can be arranged in a series to ensure capture of all contaminants if contaminant trap breakthrough is a possibility. If sediment is extremely wet and trap material retention capacity is affected by moisture, a moisture retention trap, such as a tube loaded with Drierite, can be added in-line prior to trap (Figure F-2).

**Step 3 – Carrier air application.** If laboratory “house” air or compressed air is used, it should be passed through adsorbent traps to remove potential contaminants prior to use. Attach a flow meter to the air entrance port, followed by a line to compressed air supply (Figure F-2). If a vacuum pump is used to pull air over the sediment surface, first attach drier tube (if needed), followed by adsorbent trap, flow meter, and then attach vacuum pump tube to exit side of flow meter. Pass or pull dry air over the sediment surface at a rate of 1.7 L/min. (This will ensure maximum contaminant fluxes from the sediment).

**Step 4 – Sampling.** The length of sampling and total sampling period will be dependent upon contaminant concentrations in the sediment. If concentrations are relatively low, a longer sampling interval (i.e., 24-hr continuous sample) may be necessary to ensure trap contaminant concentrations are above analytical detection limits. An example sampling regime used in previous laboratory investigations consisted of sampling at intervals of 6 hr, 24 hr, 7 days, 10 days, and 14 days.

---

<sup>1</sup> A sample laboratory schematic is shown in Figure F-2.

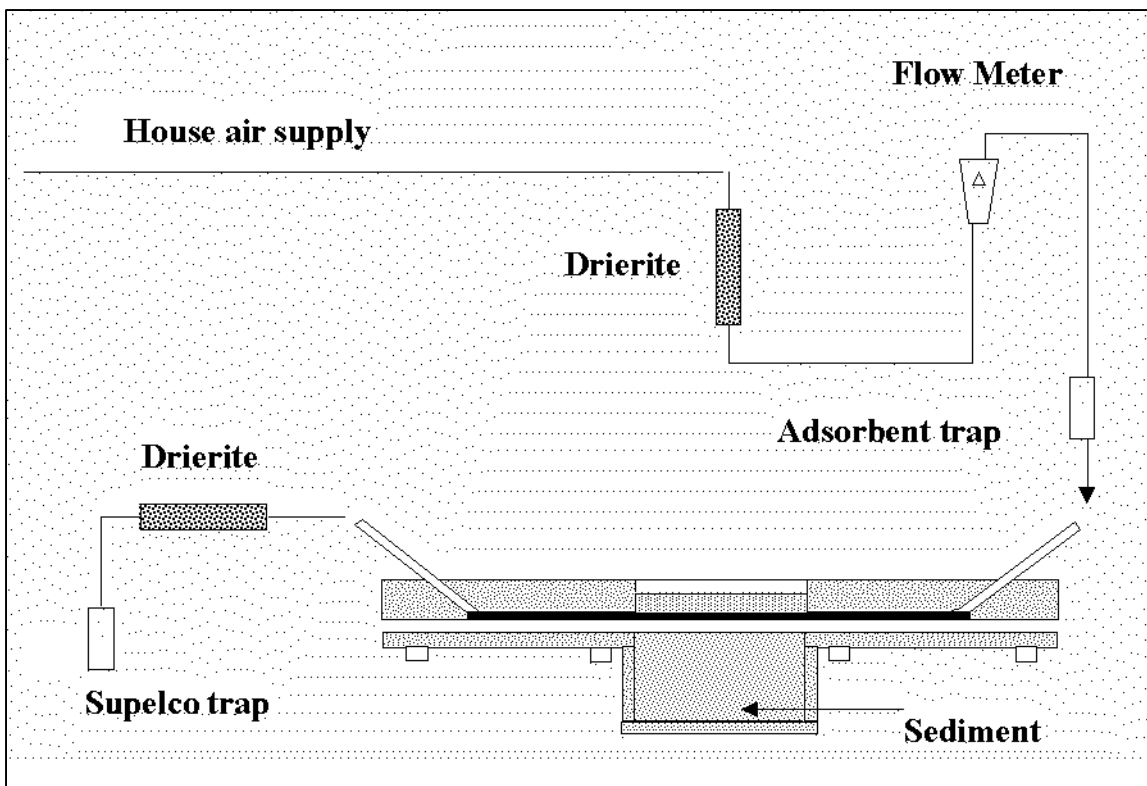

Figure F-2. Laboratory sampling schematic

Sampling can be conducted continuously by sampling for 6 hr or desired interval. The initial trap can then be removed and replaced with a second in order to collect another sample for 18 hr to give a 24-hr sample and so on. If the sediment sample has high contaminant concentrations, which can result in trap breakthrough, shortening sampling times can reduce the sampling period. Samples can then be taken for much shorter periods of time (i.e., 1 or 2 hr) over a prescribed interval such as 1 week. During the exposure, air is continuously passed over the sediment with collection of air samples conducted daily for a prescribed time to determine contaminant concentrations being emitted from the sediment.

**Step 5 – Trap storage.** Remove traps after each sampling interval, seal ends with provided seals, and refrigerate. Sample holding time will be dependent upon traps used. Commercially available air sampling tubes through Supelco Inc. have a holding time of 7 days (refrigerated).

### F.2.6 Data analysis

**Flux Determination.** Contaminant flux [ $N_A(t)$ ] from the chamber is calculated by determining the total mass of material captured in a given time interval using the equation

$$N_A(t) = Dm / DtA_c \quad (F-1)$$

where

$Dm$  = mass (ng) of compound collected on the trap in time  $Dt$  (hr)

$A_c$  = area of the sediment-air interface,  $\text{cm}^2$

$N_A(t)$  is expressed in  $\text{ng}/\text{cm}^2/\text{hr}$ .

An example of actual fluxes obtained from a contaminated dredged material is given in Figure F-3. These fluxes represent phenanthrene emissions over a 17-day sampling period. Continuous sampling was conducted, meaning that a trap was attached to the chamber for the entire sampling period. The first five points on the graph represent samples of 6, 24, 72, 168, and 240 hr with corresponding sampling times of 6, 18, 48, 96, and 72 hr. This figure gives a representative pattern for organic compound (PCBs, PAHs) emissions from a contaminated dredged material.

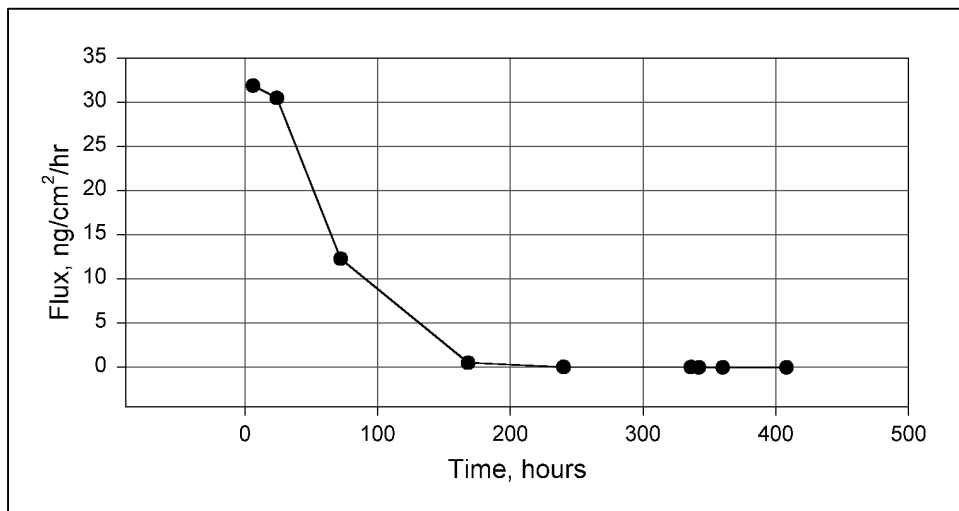

Figure F-3. Phenanthrene fluxes from a contaminated dredged material

## F.3 Volatile Exposure Evaluation

### F.3.1 Site exposure concentration

To estimate the exposure concentration at the site:

- a. A control volume of air overlying the site should be designated as a mixing volume for the contaminant flux. This control volume would extend over the entire area of volatilization locale to a height characteristic of worker exposure (typically, about 2 m or 6 ft) and its volume should be estimated in cubic meters.
- b. Next, the air residence time of the control volume for low, medium, and high wind speeds should be estimated by dividing the length of the site by the wind speed.

- c. The contaminant mass emission should be computed for one residence time for the three wind speeds. The emission should be computed by first estimating the contaminant flux rate in mg/m<sup>2</sup>/s for the given locale and wind speed.
- d. The flux rate is then multiplied by the area of the locale in m<sup>2</sup> to obtain the contaminant emission rate in mg/s.
- e. The emission rate is then multiplied by the residence time in seconds to obtain the contaminant emission in milligrams for one control volume of air. The contaminant site exposure concentration in mg/m<sup>3</sup> or ug/L is then computed by dividing the contaminant emission for the three wind conditions by the control volume. The highest of the three site exposure concentrations is used for evaluations of air quality at the site.

The contaminant exposure concentration is compared with the air quality standard to determine the acceptability of the volatile emission. If an air quality standard is not available, a health and safety standard in terms of an inhalation reference dose may be available. The reference dose in mg/kg/day can be converted to an air quality standard in ug/L by multiplying the dose by the weight of the receptor (person being protected) and dividing the result by the volume of air breathed by the receptor at the exposure point in a day considering the receptor's activity level. If the receptor were a worker, exposure might be limited to 9 hr per day while a nearby resident might be exposed 24 hr per day.

### F.3.2 Off-site exposure concentration

To evaluate off-site air quality, the off-site exposure concentration is predicted using a Gaussian dispersion model for the same three wind conditions. The Gaussian dispersion equation given below describes a ground level source with no thermal or momentum flux.

$$C_{x,0,0} = \frac{Q}{p s_y s_z u} \quad (\text{F-2})$$

where

$C_{x,0,0}$  = concentration of pollutants at coordinate x above background, mg/m<sup>3</sup>

$Q$  = emission rate of pollutants, mg/s

$s_y$  = horizontal standard deviation of pollutant concentration along the centerline of plume at X distance, m

$s_z$  = vertical standard deviation of pollutant concentration along the centerline of plume at X distance, m

$u$  = mean wind velocity, m/s



The horizontal and vertical dispersion variables,  $s_y$  and  $s_z$ , can be estimated as follows for the conservative neutral atmospheric stability condition:

$$s_y = 68 \left( \frac{X}{1000} \right)^{0.894} \quad (\text{F-3})$$

$$s_z = \left[ 33.2 \left( \frac{X}{1000} \right)^{0.725} \right] - 1.7 \quad (\text{F-4})$$

The Gaussian dispersion air quality model has been programmed and will be available through ADDAMS as the file Gaussian.html to run on Java-script enabled browsers.

The emission rate and contaminant concentration must be computed for each volatile contaminant. Based on the standard and background concentration, the required dispersion to achieve the standard can be computed for each contaminant to determine which contaminant requires the greatest dispersion and is the contaminant of concern for volatilization. The required dispersion factor,  $D$ , is computed as follows:

$$D = \frac{C_o + C_b - C_x}{C_x - C_b} \quad (\text{F-5})$$

where

$C_o$  = contaminant concentration above background at center of exposed area,  $\text{mg}/\text{m}^3$

$C_s$  = required contaminant concentration,  $\text{mg}/\text{m}^3$

$C_b$  = background contaminant concentration,  $\text{mg}/\text{m}^3$

## F.4 References

Price, C., Brannon, J., Myers, T., Valsaraj, K., Thibodeaux, L., and Reible, D. (1997). "Development of laboratory procedures to predict volatile losses from contaminated sediments," Environmental Effects of Dredging Technical Notes EEDP-02-23, U.S. Army Engineer Waterways Experiment Station, Vicksburg, MS.

Price, C., Brannon, J., Yost, S., Valsaraj, K., and Ravikrishna, R. (1999). "Volatile losses from aged field sediments," Environmental Effects of Dredging Technical Notes EEDP-02-26, U.S. Army Engineer Waterways Experiment Station, Vicksburg, MS.

Ravikrishna, R., Valsaraj, K. T., Yost, S., Price, C.B., and Brannon, James, M. (1998). "Air emissions from exposed, contaminated sediment and dredged

materials 2. Diffusion from Laboratory-Spiked and Aged Field Sediments,”  
*Journal of Hazardous Materials* 60, 89-104.

Valsaraj, K. T., Ravikrishna, R., Choy, B., Reible, D., Thibodeaux, L., Price, C.,  
Yost, S., Brannon, J., and Myers, T. (1999). “Air emissions from exposed  
contaminated sediments and dredged material,” *Environ. Sci. Technol.* 33,  
142-149.

# Appendix G

## Animal Bioaccumulation Test Procedures

---

### G.1 Introduction

This appendix provides detailed step-by-step procedures for conducting tests for evaluation of terrestrial animal bioaccumulation of contaminants. The background, rationale, and tiered framework for application of these tests are discussed in Chapter 8 of the main text of this Upland Testing Manual (UTM). Two test procedures are included in this appendix:

- a.* Calculation of theoretical bioaccumulation potential for evaluation of potential terrestrial animal bioaccumulation of nonpolar organic contaminants.
- b.* Quantitative test for bioaccumulation of contaminants by terrestrial animals as represented by the earthworm.

### G.2 Tier II - Theoretical Bioaccumulation Potential (TBP) Of Nonpolar Organic Chemicals

The TBP is an approximation of the equilibrium concentration in tissues if the dredged material in question were the only source of contaminant to the organisms. The TBP calculation in Tier II is applied as a screen to calculate the magnitude of bioaccumulation likely to be associated with nonpolar organic contaminants in the dredged material.

Nonpolar organic chemicals include all organic compounds that do not dissociate or form ions. This includes the chlorinated hydrocarbon pesticides, many other halogenated hydrocarbons, PCBs, many PAHs including all the COC PAHs, dioxins, and furans. It does not include metals and metal compounds, organic acids or salts, or organometallic complexes such as tributyltin or methyl mercury.

The TBP calculation assumes that various lipids in different organisms and organic carbon in different sediments are similar and have similar distributional properties. Other simplifying assumptions are that chemicals are freely exchanged between the sediments and tissues and that compounds behave conservatively. In reality, compound size and structure may influence accumulation, and portions of organic compounds present on suspended particulates may have kinetic or structural barriers to availability. Another important assumption implicit in the TBP calculations is that there is no metabolic degradation or biotransformation of the chemical. Organic-carbon normalized contaminant concentrations are used such that the sediment-associated chemical can be characterized as totally bioavailable to the organism. Calculations based on these assumptions yield an environmentally conservative TBP value for the dredged material if the dredged material in question is the only source of the contaminant for the organism. However, note that TBP calculations are not valid for sediments with TOC less than or equal to 0.2 percent.

McFarland (1984) calculated that the equilibrium concentration of nonpolar organic chemicals, which the lipids of an organism could accumulate as a result of exposure to dredged material, would be about 1.7 times the organic carbon-normalized concentration of the chemical in the dredged material. Concentrations are directly proportional to the lipid content of the organism and the contaminant content of the dredged material or reference sediment, and are inversely proportional to the organic carbon content of the dredged or reference material (Lake, Rubenstein, and Pavignano 1987).

The possible chemical concentration in an organism's lipids [the lipid bioaccumulation potential (LBP)] would theoretically be 1.7 times the concentration of that chemical in the sediment organic carbon. Rubinstein et al. (1987) have shown, based on field studies with PCBs, that a value of 4 for calculating LBP is appropriate. LBP represents the potential contaminant concentration in lipid if the sediment is the only source of that contaminant to the organism. It is generally desirable to convert LBP to whole-body bioaccumulation potential for a particular organism of interest. This is done by multiplying LBP by that organism's lipid content, as determined by lipid analysis or from reported data. Soft-bodied animal lipid contents may range from 1 to 2% wet weight (based on data from an oligochaete, midge, and amphipod species).<sup>1</sup>

Based on work by McFarland and Clarke (1987), TBP can be calculated relative to the biota sediment accumulation factor (BSAF) as:

$$\text{TBP} = \text{BSAF} (C_s / \% \text{TOC}) \%L$$

where TBP is expressed on a whole-body wet-weight basis in the same units of concentration as  $C_s$ , and

---

<sup>1</sup> G. Angley, Environmental Protection Agency, Duluth, and H. Lee, EPA, Newport, personal communication.

$C_s$  = concentration of nonpolar organic chemical in the dredged material or reference sediment (any units of concentration may be used)

BSAF = 4 (Ankley et al. 1992)

%TOC = total organic carbon content of the dredged material or reference sediment expressed as a decimal fraction (i.e., 2% = 0.02)

%L = organism lipid content expressed as a decimal fraction (i.e., 3% = 0.03) of whole-body wet weight.

## G.3 TIER III - Terrestrial Animal Bioaccumulation Test

Unless adverse conditions exist (excessively low pH, excessively high salinity, contaminant toxicity, etc.), animals and plants will colonize dredged material that has dewatered. Dredged material in a terrestrial habitat condition is subject to physicochemical changes over time that will affect availability of contaminants from animals to plants and from plants to animals.

### G.3.1 Terrestrial species selection

In the Tier III animal bioaccumulation test, the concentration of contaminant of concern (COC) in the tissues of a soil invertebrate (earthworm) living in the dredged material is compared to the concentration of COC in earthworms living in the reference material. The procedure to evaluate bioaccumulation of all COC is presented below. This test is based on the bioaccumulation evaluations developed at WES for the ASTM Standard Procedure E 1676-97 (ASTM 1997).

The earthworm species *Eisenia fetida* used in this procedure has been used successfully as a laboratory test organism in many testing media, including artificial soil (Neuhauser et al. 1985); contaminated field soils (Stafford and Edwards 1985, Callahan, Russell, and Peterson 1985); activated sludge (Hartenstein, Hartenstein, and Hartenstein 1981); sediment (Athey et al. 1989) and cow manure (Reinecke and Venter 1985).

#### G.3.1.1 Life history.

The life-cycle of *E. fetida* can be divided into three distinct phases: (1) the cocoon phase, consisting of an egg cocoon that can produce from 1 to 11 hatchlings under laboratory conditions (2) the young (immature) phase, during which the hatchlings grow physically but cannot produce cocoons; and (3) the adult (mature) phase, which is reached when the worms become capable of producing cocoons. Adult worms may still grow physically. The life cycle for *E. fetida* to vary from a mean of 51.5 days at 25 °C to more than 166 days at 13 °C, i.e., from freshly deposited cocoon through clitellate worm and deposition of the

next generation of cocoons. *E. fetida* has a maximum life expectancy of 4 to 5 years, although between 1 and 2 years is more usual.

*Eisenia fetida* is an epigeic species (i.e., they live and feed on the surface) that rarely inhabits agricultural soils but is found in compost piles, manure piles, and other disturbed sites rich in organic matter. The rate of soil consumption in the laboratory by *E. fetida* individuals weighing 300 mg has been estimated at 16 mg soil/individual/day (Stafford and Edwards 1985).

Worms digest the microorganisms from ingested soil and organic debris, which illustrates their interactions with the soil environment. Independently of whether mineral matter or fibrous organic material was ingested, approximately 2.5 h were required at 25 °C for *E. fetida* to pass ingesta from mouth to anus (Hartenstein, Neahauser, and Narahara 1981).

### **G.3.1.2 Taxonomy.**

The taxonomic status of what Bouché (1992) calls the complex is unclear in the literature. Some authors consider this complex to consist of two subspecies, *E. fetida fetida* and *E. fetida andrei*, while other authors consider the complex to consist of two separate species, *E. fetida* and *Eisenia andrei*. This guide chooses to use the subspecies designations. The dorsal surface of *E. f. andrei* is uniformly reddish, while *E. f. fetida* is striped or banded. Bouché (1992) states that the *andrei* form is relatively homogeneous, while *fetida* may be multispecific. It is recommended that the *andrei* form be used as the test organism, that is, *E. f. andrei*.

### **G.3.2 Laboratory procedures**

**Culture of Test Organisms.** Earthworms are obtained through either culture procedures or from commercial vendors.

**Age.** Tests with *E. fetida* tests should use sexually mature fully clitellate earthworms.

**Experimental Design.** Decisions concerning the various aspects of experimental design, such as the number of replicates, the number of test containers, and the mass of earthworms, should be based on the amount of tissue material needed for chemical analysis.

**Test Material.** Test materials are (1) the dredged material being evaluated, (2) reference soil, and (3) control material such as earthworm culture media for use in evaluating test acceptability.

**Test Containers.** Test material is placed in transparent Plexiglas cylinders 30 cm deep and 15 cm in diameter. The cylinder ends are closed with a 17-cm PVC and either 340 $\mu$  Nytex mesh or cotton muslin cloth. The bottom end is then placed in a 20-cm-diam plastic dish of test water to allow water movement into the substrate and allow earthworms to move into areas of optimum moisture.

**Test Initiation (Day 0).** A random sample of earthworms should be analyzed for the COC as a Day 0 background tissue sample. The Day 0 background tissue sample is used to quantify COC present in earthworms prior to the test and should not be confused with control or reference tissue samples, which are exposed to test cylinders for the full 28 days. If greater than 10 percent mortality is seen in control containers, the test is considered invalid. If earthworms cannot survive in the dredged material, bioaccumulation in the earthworm is not a concern. Prior to testing, earthworms are rinsed with test water, and placed on paper towels to remove excess water. On Day 0 the mass of earthworms needed for the particular chemical analysis procedures for the contaminant(s) of concern are added to the test cylinder. Test containers have accommodated up to 30 grams (~75 earthworms)/ cylinder.

**Test Breakdown (Day 28).** On Day 28, earthworms are removed, rinsed with test water, blotted, counted, and weighed. The earthworms are depurated for 24 hr on moist filter paper, then rinsed, reweighed, and frozen in preparation for chemical analysis.

**Feeding.** Dredged material that contains organic material does not require an additional food source. Substrates with lesser nutrients tested with this procedure may require added food because of test length. Any food added would need to be chemically analyzed for concentrations of COC.

**Test Specifications and Quality Control.** A summary of the test specifications is given in Table G1. Temperature, pH, percent moisture, and salinity should be controlled or monitored throughout the test. Ideally these variables should be the same as in the field, and within the range of the earthworms' requirements. Acceptable temperature range is from 10 to 29 °C with a recommended range of 19 to 25 °C. Acceptable pH range is between 4 and 10 (Greene et al. 1989). Recommended photoperiod is 24 hr within 100-1080 lux. This photoperiod is recommended to prevent earthworm escape, encourage maximum exposure to test material, and to discourage contact with container sides.

<b>Table G-1 Test Specifications for the 28-day <i>Eisenia fetida</i> Bioaccumulation Test</b>	
<b>Test Duration</b>	<b>28 days</b>
Biological Endpoint	Contaminant accumulation
Temperature	Same as field condition if within 10-29 °C
Photoperiod	24 hr/ 100-1080 lx
pH	Same as field condition if within 4-10
% moisture	Same as field condition
Salinity	Same as field condition
Test Containers	Plexiglas cylinders

### **G.3.2.1 Test variations.**

**Laboratory Procedure with Sod.** This procedure considers the potential effects of vegetation on bioaccumulation by earthworms (Kay, Scolten, and Bowmer 1988). This variation is conducted with Bermuda grass planted in the cylinders (Skogerboe et al. 1996). The procedure differs from the above as follows; On Day 0, 1 gm of Bermuda grass seeds are spread over the cylinder surface. Seeds are covered with 1mm of peat moss and lightly watered with reverse osmosis (RO) water. Each cylinder receives 125 mL of a dilute (600 mg/liter of water) solution of soluble plant food (13-13-13), during the first 2 weeks to enhance seed sprouting. Excess water is collected in plastic trays and poured off. On Day 30, earthworms are added. On Day 60, Bermuda grass is harvested, earthworms are counted and weighed, and both grass and earthworms are prepared for chemical analysis. The following alterations are made in the temperature and lighting test conditions to promote grass growth: temperature 22 °C (night) to 29 °C (day), acceptable lighting is 400 lux illumination for a period of 14 hr light/10 hr dark.

***In Situ* Field Procedure.** An *in situ* field bioaccumulation procedure may be used. This procedure is very similar to the laboratory procedure described above, with a 7.5-l polyethylene bucket with screen-covered holes in the base and lid to allow air and water but not earthworm exchange. Test containers are implanted 25 cm deep (soil level) in the dredged material in place in the CDF and filled with the material removed from the hole (Simmers et al. 1986).

### **G.3.2.2 Chemical analysis.**

Chemical analysis of earthworm tissue for the animal bioaccumulation COC should follow the tissue analysis guidance in Chapter 9 of the ITM (USEPA/USACE 1998).

## **G.3.3 Data Presentation and Analysis**

### **Data Presentation.**

Data should be presented in tabular format, listing tissue concentration of each COC by organism and by sediment type (e.g., dredged material and reference). Although bioaccumulation tests cannot be used to quantify toxicity, any mortality that occurs during bioaccumulation testing should be documented.

### **Data Analysis.**

At the end of the 28-day test period, concentrations of COC in the tissues of earthworms in the dredged material should be statistically compared to concentrations of COC in worms in the reference material. The results of this evaluation are interpreted according to the Tier III guidance in Chapter 8. Concentrations of COC in the tissues of earthworms archived at the initiation of the exposure may provide perspective helpful in reaching a Tier III decision.



## G.4 References

- American Society of Testing and Materials (ASTM). (1997). "Standard guide for conducting laboratory soil toxicity of bioaccumulation tests with the lumbriced earthworm *Eisenia Fetida*," Designation ASTM E 1676-97, West Conshohocken, PA.
- Ankley, G. T., Cook, P. M., Carlson, A. R., Call, D. J., Swenson, J. K., Corcoran, H. F., and Hoke, R.A. (1992). "Bioaccumulation of PCB from sediments by oligochaetes and fishes," *Can. J. Fish. Aquat. Sci.* 49, 2080-2085.
- Athey, L. A., Thomas, J. M., Miller, W. E., and Word, J. Q. (1989). "Evaluation of bioassays for designing sediment cleanup strategies at a wood treatment site," *Environmental Toxicology and Chemistry* 8, 223-230.
- Bouché, M. B. (1992). "Earthworm species and ecotoxicological studies," *Ecotoxicology of Earthworms*, P. W. Greig-Smith, H. Becker, P. J. Edwards, and F. Heimbach, eds., Intercept, Andover, United Kingdom, 20-35.
- Callahan, C. A., Russell, L. K., and Peterson, S. A. (1985). "A comparison of three earthworm bioassay procedures for the assessment of environmental samples containing hazardous wastes," *Biology and Fertility of Soils* 1, 195-200.
- Greene, J. C., Bartels, C. L., Warren-Hicks, W. J., Parkhurst, B. R., Linder, G. L., Peterson, S. A., and Miller, W. E. (1989). "Protocols for short term toxicity screening of hazardous waste sites," EPA/600/3-88/029, U.S. Environmental Protection Agency, Environmental Research Laboratory, Corvallis, OR.
- Hartenstein, R., Neuhauser, E. F., and Narahara, A. (1981). "Effects of heavy metal and other elemental additives to activated sludge on growth of *Eisenia fetida*," *Journal of Environmental Quality* 10, 372-376.
- Hartenstein, F., Hartenstein, E., and Hartenstein, R. (1981). "Gut load and transit time in the earthworm *Eisenia fetida*," *Pedobiologia* 22, 5-20.
- Kay, S. H., Scolten, M. C. Th., and Bowmer, C. T. (1988). "Mobility of soil contaminants in an ecosystem of trees growing on dredged material- The Broekpolder (Rotterdam, The Netherlands)," Technical Report R88/488, Technology for Society Division (MT) of Netherlands Organization for Applied Scientific Research (TNO), Delft, NL.
- Lake, J. L., Rubinstein, N., and Pavignano, S. (1987). "Predicting bioaccumulation: Development of a simple partition model for use as a screening tool for regulating ocean disposal of wastes," *Fate and Effects of Sediment-Bound Chemicals in Aquatic Systems*, K. L. Dickson, A. W. Maki, and W. A. Brungs, eds., Pergamon Press, New York, NY, 151-166.

- McFarland, V. A. (1984). Activity-based evaluation of potential bioaccumulation from sediments." *Dredging '84. Proc. Am. Soc. Civ. Eng.* 1, 461-467.
- McFarland, V. A., and Clarke, J. (1987). Simplified approach for evaluating bioavailability of neutral organic chemicals in sediment," *Environmental Effects of Dredging Tech. Note EEDP-01-8*. U.S. Army Engineer Waterways Experiment Station, Vicksburg, MS.
- Neuhauser, E. F., Loehr, R. C., Milligan, D. L., and Malecki, M. R. (1985). "Toxicity of metals to the earthworm *Eisenia fetida*," *Biology and Fertility of Soils* 1, 149-152.
- Reinecke, A. J., and Venter, J. M. (1985). "Influence of Dieldrin on the reproduction of the earthworm *Eisenia fetida* (Oligochaeta)," *Biology and Fertility of Soils* 1, 39-44.
- Rubinstein, N. I., Lake, J. L., Pruell, R. J., Lee II, H., Taplin, B., Heltshe, J., Bowen, R., and Pavignano, S. (1987). "Predicting bioaccumulation of sediment associated organic contaminants: Development of a regulatory tool for dredged material evaluation," Tech. Rept. D-87 prepared by the U.S. Environmental Protection Agency, Narragansett, RI, for the U.S. Army Engineer Waterways Experiment Station, Vicksburg, MS.
- Simmers, J. W., Rhett, R. G., Kay, S. H., and Marquenie, J. M. (1986). "Bioassay and biomonitoring assessments of contaminant mobility from dredged material," *The Science of the Total Environment* 56, 173-182.
- Skogerboe, J. G., Tatem, H. E., Lee, C. R., Simmers, J. W., Brannon, D. L., Brannon, J. M., and Palermo, M. R. (1996). "Evaluation of terrestrial disposal reconditioning and bioremediation tests of Hamlet City Lake Sediment, NC," Miscellaneous Paper D-96, U.S. Army Engineer Waterways Experiment Station, Vicksburg, MS.
- Stafford, E. A., and Edwards, C. A. (1985). "Comparison of heavy metal bioaccumulation by *Eisenia fetida* with that of other common earthworms," Final Technical Report, Contract No. DAJA 45-84-C-0027, Rothamsted Experimental Station, Harpendnen, Herts, United Kingdom.
- U.S. Environmental Protection Agency/U.S. Army Corps of Engineers. (1998). "Evaluation of dredged material proposed for discharge in waters of the U.S. – Testing Manual," EPA-823-B-98-004 Office of Water (4305), Washington, DC.

# Appendix H

## Plant Bioaccumulation Procedures

---

### H.1 Introduction

This appendix provides detailed step-by-step procedures for conducting tests for evaluation of bioaccumulation of contaminants of concern (COC) by wetland and terrestrial plants from both freshwater and marine dredged materials. The background, rationale, and tiered framework for application of these procedures are discussed in Chapter 9 of the main text of this Upland Testing Manual (UTM). Two test procedures are provided in this appendix:

- a.* DTPA extraction and application of the plant bioaccumulation program (PUP).
- b.* Plant bioaccumulation procedures applicable to terrestrial and wetland dredged material disposal alternatives.

### H.2 DTPA Extraction Procedure for Plant Bioaccumulation

The screen for the evaluation of plant bioaccumulation of metals involves the extraction of metals from the dredged material using diethylenetriamine-pentaacetic acid (DTPA). The DTPA screen may be used to evaluate bioaccumulation of metals by plants from freshwater dredged material under wetland or terrestrial habitat conditions. A computerized program, the PUP uses the results of the DTPA extraction to predict bioaccumulation from the dredged material and compare the results to bioaccumulation from the reference sediment or soil (Folsom and Houck 1990). The PUP requires data on total sediment metals concentrations, DTPA extraction, organic matter percentage, and the sediment pH in the condition of disposal (wetland or terrestrial).

## H.2.1 Materials

### Apparatus and equipment.

- a. Stainless steel electric mixer
- b. Magnetic stir plate
- c. Combustion oven (550 °C capability)
- d. 500-mL polycarbonate centrifuge bottles
- e. Centrifuge
- f. Mechanical horizontal shaker

### Reagents.

- a. Diethylenetriamine-pentaacetic acid
- b. Calcium chloride
- c. Triethanolamine
- d. Hydrochloric acid
- e. Sodium hydroxide

## H.2.2 Sediment preparation

Sediment collected for testing should be consolidated and thoroughly mixed with a high shear mixer to ensure homogeneity. Samples are collected after mixing for the determination of sediment physical and chemical characteristics. The mixed sediment should be stored at 4 °C until needed. Any reference or background sediment or soils should be handled in the same manner as the dredged material. Half the mixed sediment is left saturated and anaerobic for use wetland tests. For terrestrial tests, the other half of the mixed sediment should be placed in an aluminum drying pan of appropriate size to allow for no greater than a 1-in. depth of sediment in the bottom of the pan. The sediment is turned twice daily with a polyethylene shovel to facilitate drying and any debris is removed. After the material is air-dried to less than 5 percent moisture on a dry weight basis, it is ground to pass a 2-mm screen and then remixed. The mixed material is then ready for use in the terrestrial testing portions in the following sections.

## H.2.3 Sediment characterization

**Sediment pH.** Ten grams (10 g) (oven-dried weight [ODW] to nearest 0.001 g) of original wet, dried, and dried + peroxide sediment are weighed into

tall 50-mL Pyrex glass beakers. Twenty (20) mL of distilled water is added to each beaker and the mixture is stirred with a polyethylene rod until all particles are saturated. The mixture is stirred with a magnetic stirrer for 1 min every 15 min for 45 min. After 45 min, the pH electrode is placed into the solution above the surface of the sediment and the pH is read on a pH meter (Folsom, Lee, and Bates 1981).

**Organic matter.** Organic matter (OM) is determined by weight loss on ignition at 550 °C on air-dried (AD) and air-dried + washed (ADW) sediment. Procedure No. 209E (American Public Health Association 1976) is used for this test. A 5-g (ODW) subsample is weighed to the nearest 0.001 g and dried at  $105 \pm 2$  °C until constant weight (48 hr). Five (5) grams of the oven-dried sediment is weighed to the nearest 0.001 g and combusted at  $550 \pm 5$  °C for 24 hr in a muffle furnace. The sample is allowed to cool to room temperature in a moisture desiccator and weighed to the nearest 0.001 g. Weight loss on ignition is calculated and reported as percent OM using the following formula:

$$\frac{((\text{oven dry weight} - \text{combusted weight}) / \text{oven dry weight}) \times 100}{\text{organic matter}} = \%$$

#### H.2.4 DTPA extraction procedure

**Wetland condition.** A 50.0-g (ODW to the nearest 0.001 g) subsample of the wet, unoxidized sediment is weighed into a 500-mL polycarbonate centrifuge bottle and centrifuged at 4 °C and 9,500 rpm for 30 min. The supernatant is decanted; pH is determined on the supernatant and represents the saturated sediment pH. To the sediment remaining in the centrifuge bottle is added 250 mL of 0.005 M DTPA + 0.01 M calcium chloride + 0.1 M triethanolamine solution (Lee et. al. 1978) buffered at pH 7.3. The bottle is sealed, placed on a mechanical shaker and centrifuged as before. The supernatant is carefully poured into a polyethylene bottled and analyzed for metals according to the methods described in USEPA (1986).

**Terrestrial condition.** The procedure for the terrestrial condition is the same as that for the wetland condition except that air-dried sediment is used. After extractions are complete, samples are stored in polyethylene bottles at 4 °C until chemical analysis. In addition, an extracting solution blank is also analyzed and resulting data are subtracted from the test sediment data prior to performing the following calculation for both the wetland and terrestrial evaluation:

$$\frac{DTPA \text{ metal Conc.} - (DTPA \text{ extracting solution metal conc.}) \times (\text{extracting solution vol.})}{g \text{ of ODW sediment}}$$

#### H.2.5 Prediction of plant bioaccumulation and comparison to reference

The results of the DTPA extractions along with chemical and physical sediment characteristics described above are entered into the PUP program as

described in (<http://www.wes.army.mil/el/elmodels/pdf/ee-04-12.pdf>). The program can be downloaded from (<http://www.wes.army.mil/el/elmodels/index.html>). Plant contaminant concentrations from several years of plant bioaccumulation results are contained in the PUP database and are separated by sediment redox status, pH and organic matter. Data separation improves the prediction capability when the data collected from the above procedures are entered into the PUP model and model results are generated.

### H.2.6 Comparison of DTPA results to reference

The mean DTPA and total sediment metal concentrations are entered along with pH and organic matter content into the PUP as described in Folsom and Houck (1990). Results are presented as plant metals concentration in  $\mu\text{g g}^{-1}$  and as total plant bioaccumulation in  $\mu\text{g}$  on an ODW basis. In addition, test results from the reference sediment are included for comparison.

An example DTPA evaluation using PUP as described above is shown in Table H.1. The DTPA results are noted as exceeded (EXCD) the comparison or did not exceed (DNEX) the comparison. As shown in this example, As, Cd, Cr, Cu, Pb, Hg, and Zn exceed all cases comparing plant bioaccumulation from the dried dredged material to bioaccumulation from the reference material.

Case	As	Cd	Cr	Cu	Pb	Hg	Ni	Ag	Zn	No. Exceeded
1a	EXCD	EXCD	EXCD	EXCD	EXCD	EXCD	DNEX	DNEX	EXCD	7
1b	DNEX	EXCD	EXCD	EXCD	EXCD	EXCD	EXCD	DNEX	EXCD	7
2a	EXCD	EXCD	EXCD	EXCD	EXCD	EXCD	DNEX	DNEX	EXCD	7
2b	DNEX	EXCD	EXCD	EXCD	EXCD	EXCD	EXCD	DNEX	EXCD	7
3a	EXCD	EXCD	EXCD	EXCD	EXCD	EXCD	DNEX	DNEX	EXCD	7
3b	DNEX	EXCD	EXCD	EXCD	EXCD	EXCD	EXCD	DNEX	EXCD	7

The results of the comparisons show that dredged material DTPA Cd, Cu, Cr, Pb, Hg, and Zn will exceed the reference all cases described above. This information is evaluated according to the Tier II guidance in Chapter 9.

The plant metals concentrations and total plant bioaccumulation predicted by the PUP program for the example summarized above are presented in Table H.2. This information may provide perspective useful in the Tier II evaluation of plant bioaccumulation.

<b>Table H.2 DTPA-Predicted Plant Metal Concentrations (<math>\mu\text{g g}^{-1}</math>) and Total Plant Bioaccumulation (<math>\mu\text{g}</math>)</b>				
	<b>Wet</b>		<b>Oven Dry</b>	
<b>Metal</b>	<b>Concentration</b>	<b>Total bioaccumulation</b>	<b>Concentration</b>	<b>Total bioaccumulation</b>
<b>Arsenic</b>	0.576	0.977	0.324	0.608
<b>Cadmium</b>	2.23	49.54	1.95	31.67
<b>Chromium</b>	12.33	15.93	9.33	22.10
<b>Copper</b>	21.02	178.48	26.04	162.5
<b>Lead</b>	2.07	6.86	1.63	9.81
<b>Mercury</b>	0.01	-0.38	0.048	-1.59
<b>Nickel</b>	6.04	-20.62	5.32	5.45
<b>Zinc</b>	35.09	1321	44.1	2202

## H.3 Laboratory Plant Bioaccumulation Procedures

### H.3.1 Plant bioaccumulation/toxicity assessment

The plant bioaccumulation procedure consists of the exposure of index plants to dredged material and a reference soil or sediment. The dredged material and reference material are prepared to simulate wetland conditions or are processed by drying and oxidation to simulate terrestrial conditions before being planted with seedlings of the appropriate specie. *Spartina alterniflora* (SA) and is used for saline wetland conditions. *Cyperus esculentus* (CE) is used for fresh wetland, fresh terrestrial, and saline terrestrial conditions. The procedure calls for sediment exposure through maturity of the plant in an environmentally controlled greenhouse. Aboveground plant tissues are harvested and analyzed for COC concentrations.

### H.3.2 Apparatus and materials

**Apparatus.** The apparatus for performing the plant bioaccumulation procedure is shown in Figure H.1. It is basically a double bucket with an inner bucket that allows water flow through holes in the bottom. The purpose is to facilitate adequate watering by adding water to the outer bucket and allowing movement of water by hydraulic pressure into the inner bucket through the holes in the bottom. A soil tensiometer placed in the sediment indicates when enough water has been added to bring the sediment to approximately field capacity moisture content.

**Materials.** Tubers of yellow nutsedge (*Cyperus esculentus*) can be obtained through commercial suppliers (for example, Valley Seed Services, Fresno, CA, or Wildlife Nurseries, Oshkosh, WI). Tubers are germinated prior to use in the plant bioaccumulation procedure. The tubers are first rinsed in distilled water and then placed between paper towels and kept moist and at 23 °C in a lighted germination chamber. Generally, the germination rate is low and the

process should begin with twice as many tubers as needed. Tubers are suitable for planting when sprouts are 3 cm long.

Seedlings of *Spartina alterniflora* are required for the saline wetland bioaccumulation procedure. These may be obtained from commercial growers. Field collected *Spartina alterniflora* should not be used unless new seedlings are propagated in clean potting media.

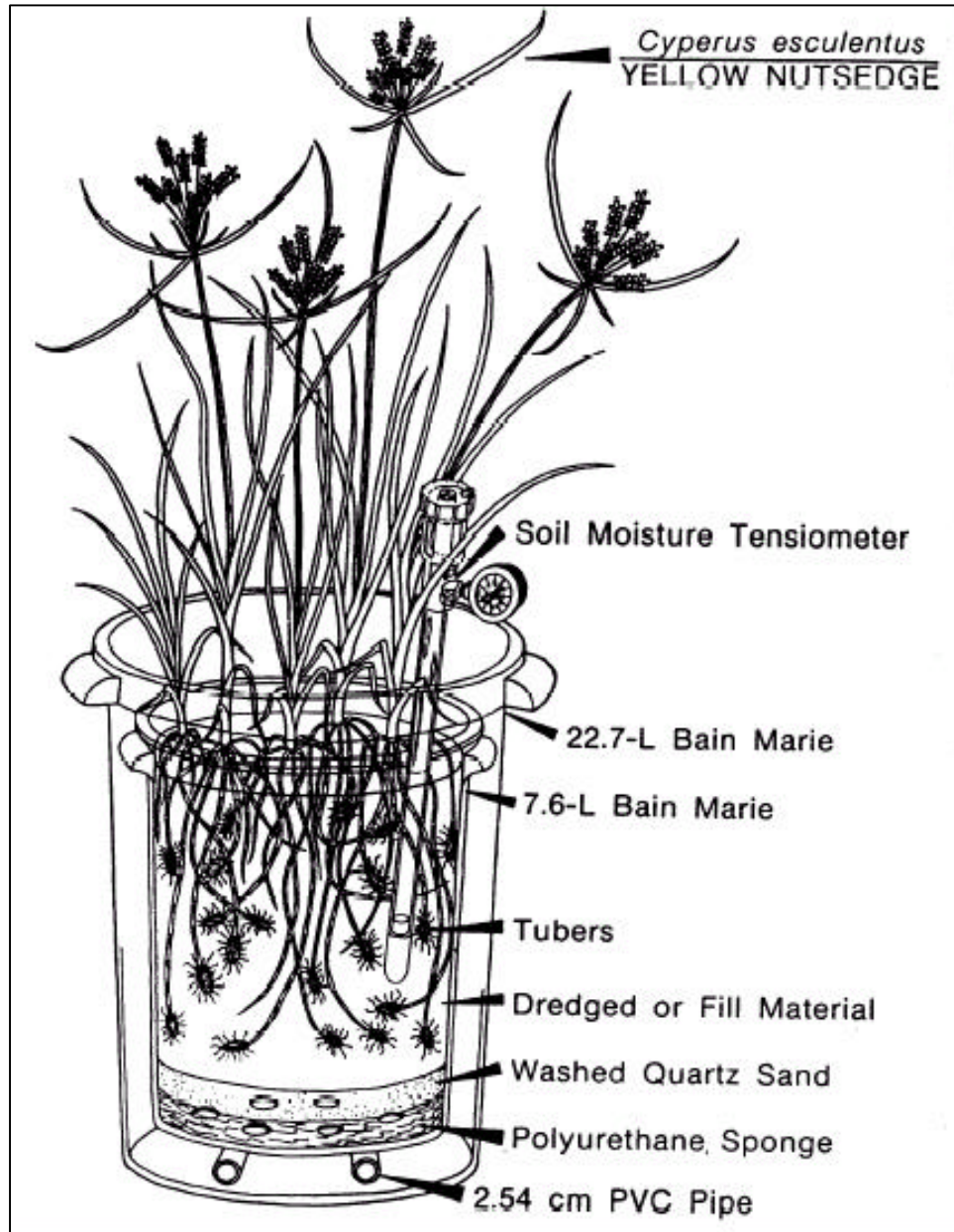

Figure H.1. Plant bioaccumulation double bucket apparatus



### H.3.3 Sediment collection and preparation

**Freshwater.** A minimum of 20 kg of sediment is required to conduct each segment (wetland and terrestrial) of the plant bioaccumulation procedure. More may be necessary if analyses requiring considerable biomass are necessary and poor plant growth in the dredged material is expected. Sediment collected for testing should be consolidated and thoroughly mixed with a high shear mixer to ensure homogeneity. Samples are collected after mixing for the determination of sediment physical and chemical characteristics and placed in new glass bottles with Teflon lined lids. The mixed sediment should be stored at 4 °C until needed. Half the mixed sediment is left saturated and anaerobic for use wetland tests. For terrestrial tests, the other half of the mixed sediment should be placed in an aluminum drying pan of appropriate size to allow for no greater than a 1-in. depth of sediment in the bottom of the pan. The sediment is turned twice daily with a polyethylene shovel to facilitate drying and any debris is removed. After the material is air-dried to less than 5 percent moisture on a dry weight basis, or at least 3 weeks, it is ground to pass a 2-mm screen and then remixed. The mixed material is then ready for use in the terrestrial testing portions in the following sections.

**Saltwater.** Saltwater sediment is prepared as above and in addition requires the leaching of salts from the sediment to support terrestrial plants on the air-dried sediment. One part air-dried sediment (5 kg ODW) and three parts of reverse osmosis (RO) purified water (15 kg) (weight to weight basis) are placed in 19.0-L buckets. Ten buckets are needed for each sediment. The sediment/water in each bucket is then mixed for 5 min every hour for 5 hr using an electric mixer. The suspension is allowed to settle until all visible suspended particles have settled out and then the water is carefully siphoned off. A sample of the water is collected from each bucket and a composite of all 10 buckets is collected for pH and electrical conductivity determinations. The sediment from each bucket is placed back into the drying flats and the drying, grinding, and washing process is repeated until the sediment had been washed three times, and dried and ground four times or until salinity of the sediment is 10 parts per thousand or below.

**Reference soil.** A reference soil or sediment should be provided for a comparison in the terrestrial and wetland tests, respectively. The reference soil or sediment should be prepared as described above for the terrestrial or wetland dredged material.

### H.3.4 Sediment characterization

**Electrical conductivity and salinity.** Electrical conductivity is determined on saturated extracts of each air-dried (AD) and air-dried + washed (ADW) sediment using the method of Rhoades (1982). The extracts are measured on a conductance meter to determine electrical conductivity (EC) in mmhos/cm. Salinity is also measured on the extracts using a hand refractometer. EC and salinity are also determined on original wet test sediment, reference sediment, and wash water samples.

**Sediment pH.** Ten (10) g (ODW to nearest 0.001 g) of original wet, AD, or ADW sediment are weighed into a tall 50-ml Pyrex glass beaker. Twenty (20) mL of distilled water are added and the mixture is stirred with a polyethylene rod until all particles are saturated. The mixture is stirred with a magnetic stirrer for 1 min every 15 min for 45 min. After 45 min, the pH electrode is placed into the solution above the surface of the sediment and the pH is read on a pH meter (Folsom, Lee, and Bates 1981).

**Organic matter.** OM is determined by weight loss on ignition at 550 °C on AD and ADW sediment. Procedure No. 209E (American Public Health Association 1976) is used for this test. A 5-g subsample (ODW) is weighed to the nearest 0.001 g and dried at  $105 \pm 2$  °C until constant weight (48 hr). Five (5) g (ODW to the nearest 0.001 g) of sediment is weighed and combusted at  $550 \pm 5$  °C for 24 hr in a muffle furnace. The sample is allowed to cool to room temperature in a moisture desiccator and weighed to the nearest 0.001 g. Weight loss on ignition is calculated and reported as percent OM using the following formula:

$$\% OM = \frac{\text{weight oven-dry sediment} - \text{weight combusted sediment}}{\text{weight oven-dry sediment}} \times 100$$

### H.3.5 Greenhouse operation and bioaccumulation techniques

Four replicates of each sediment condition are prepared by placing 4,500 g (ODW) of sediment (one 500-mL scoop-full at a time) into each prepared 7.6-l Bain-Marie container. Seedlings of the appropriate plant species are transplanted into the wetland sediment or in premoistened terrestrial sediment. Four replicates of reference sediment or soil are also prepared and planted with four replicates each of SA or CE. The replicates are randomly placed on tables in the greenhouse. Day length of 16 hr is maintained. Light fixture faces should be 130 cm from the top of the 19.0-L bucket. The 130-cm height allows maximum potential plant growth to occur without damage from the heat produced. Lights are arranged in a pattern of alternating a high-pressure sodium lamp and a high-pressure multi-vapor halide lamp. Alternating the lamps provides an even photosynthetic active radiation (PAR) distribution pattern of 1,200  $\mu\text{Einstein}/\text{m}^2$ . The temperature of the greenhouse is maintained at  $32 \pm 2$  °C maximum during the day and  $21 \pm 2$  °C minimum at night to simulate a summer environment. Relative humidity is maintained as close to 100 percent as possible, but never less than 50 percent. Soil/sediment moisture content is maintained between 30 and 60 MPa (field capacity is 30 MPa) by adding RO water as necessary. Soil moisture tensiometers, placed in each container, are monitored daily and water added when tensiometers read greater than 60MPa. RO water is added to the outer container up to the level of the inner container and allowed to move through holes in the bottom of the inner container. When tensiometers read less than 40 MPa, the water is siphoned from the outer container.

### H.3.6 Plant tissue collection and preparation for analysis

After 45 days, CE is harvested from each container, (SA is harvested after 90 days). Stainless steel scissors are used to cut the plant tissue 5 cm above the sediment surface. The tissue is immediately washed in distilled water to remove any salt, sediment, or dust particles and blotted dry. Total fresh weight and dry weight of each replicate is then determined. Plant tissues from replicates are split as appropriate for analysis of inorganic and organic contaminants. The amount of plant material required for each analyte must be determined before splits are performed and tissues placed in appropriate containers for preservation for analysis.

Chemical analysis of plant tissues for COC should be conducted according the animal tissue analysis guidance in Chapter 9 of the ITM (USEPA/USACE 1998). Analysis should include blanks and NBS plant tissue standards. Inorganics are normally reported on a dry weight basis and organics are reported on a wet weight basis although either can be calculated provided that moisture content of the plant tissue is determined prior to analysis.

### H.3.7 Data presentation and analysis

**Data presentation.** Data should be presented in tabular format, listing tissue concentration of each COC by organism and by sediment type (e.g., dredged material and reference).

**Data analysis.** At the end of the test period, concentrations of COC in the tissues of plants in the dredged material should be statistically compared to concentrations of COC in plants in the reference material. The results of this evaluation are interpreted according to the Tier III guidance in Chapter 9.

## H.4 References

American Public Health Association. (1976). "Standard methods for the examination of water and wastewater," 14th ed., Washington, DC.

Beckett, P. H. T., and Davis, R. D. (1977). "Upper critical levels of toxic elements in plants," *New Phytol* 79, 95-106.

Chaney, R. L., Hundemann, P. T., Palmer, W. T., Small, R. J., White, M. C., and Decker, A. M. (1978). "Plant accumulation of heavy metals and phytotoxicity resulting from utilization of sewage sludge composts on cropland," Proc Nat Conf Composting Municipal Residues and Sludge, Information Transfer, Inc., Rockville, MD, 86-97.

Chaney, R. L. (1983). "Potential effects of waste constituents on the food chain in land treatment of hazardous wastes," Noyes Data Corp., NJ, 152-240.

- Davis, R. D., Beckett, P. H. T., and Wollan, E. (1978). "Upper critical levels of toxic elements in plants II. Critical levels of copper in young barley wheat, rape, lettuce and ryegrass and of nickel and zinc in young barley and ryegrass," *New Phytol* 80, 23-32.
- Davis, R. D., and Beckett, P. H. T. (1978). "Critical levels of twenty potentially toxic elements in young spring barley," *Plant Soil* 49, 395-408.
- Dutch Ministry of Agriculture and Fisheries, Committee on Mineral Nutrition (DMAFCMN). (1973). "Tracing and treating mineral disorders in dairy cattle," Center for Agricultural Publishing and Documentation, Wageningen, The Netherlands.
- Folsom, B. L., Jr., Lee, C. R., and Bates, D. J. (1981). "Influence of disposal environment on availability and plant bioaccumulation of heavy metals in dredged material," Technical Report EL-81-12, U.S. Army Engineer Waterways Experiment Station, Vicksburg, MS.
- Folsom, B. L., Jr., and Houck, M. H. (1990). "A computerized procedure for predicting plant bioaccumulation of heavy metals from contaminated freshwater dredged material," Technical Note EEDP-04-12, U.S. Army Engineer Waterways Experiment Station, Vicksburg, MS.
- Lee, C. R., et al. (1978). "Prediction of heavy metal bioaccumulation by marsh plants based on chemical extraction of heavy metals from dredged material," Technical Report D-78-6, U. S. Army Engineer Waterways Experiment Station, Vicksburg, MS.
- Lee, C. R., Tatem, H. E., Brandon, D. L., Kay, S. H., Peddicord, R. K., Palermo, M. R., and Francingues, Jr., N. R. (1991). "A general decisionmaking framework for management of dredged material: Example application to Commencement Bay, Washington," Miscellaneous Paper D-91-1, U.S. Army Engineer Waterways Experiment Station, Vicksburg, MS.
- MAFF. (1972). "General decisionmaking framework for management of dredged material, example application to Commencement Bay, Washington," Miscellaneous Paper D-91-1, U.S. Army Engineer Waterways Experiment Station, Vicksburg, MS, C23.
- Rhoades, J. D. (1982). "Soluble salts." *Methods of soil analysis*. C. A. Black ed., Monograph No. 9, American Society of Agronomy, Madison, WI, 167-179.
- U.S. Environmental Protection Agency/U.S. Army Corps of Engineers. (1998). "Evaluation of dredged material proposed for discharge in waters of the U.S. – Testing manual," EPA-823-B-98-004, Office of Water (4305), Washington, DC.
- U.S. Food and Drug Administration. (1987). "Action levels for poisonous or deleterious substances in human food and animal feed," FDA Center for Food Safety and Applied Nutrition Guidelines and Compliance Research Branch (HFF-312), Washington, DC.

- U.S. Environmental Protection Agency. (1986). "Test methods for evaluating solid wastes, SW-846 Methods 8080 and 8270," 3rd ed., Office of Solid Waste and Emergency Response, Washington, DC.
- Van Driel, W., Smilde, K. W., and van Luit, B. (1985). "Comparison of the heavy-metal bioaccumulation of *Cyperus esculentus* and of agronomic plants grown on contaminated dutch sediments," Miscellaneous Paper D-83-1, U.S. Army Engineer Waterways Experiment Station, Vicksburg, MS.
- World Health Organization. (1972). "Evaluation of certain food additives and the contaminants mercury, lead and cadmium," Technical Report, Series 505, Washington, DC.

# Appendix I Reserved

---

# Appendix J RESERVED

---

# Appendix K Reserved

---



# Appendix L

## Statistical Methods

---

### L.1 Introduction

This Appendix presents appropriate statistical methods for analyzing data from confined disposal facility (CDF) pathway testing procedures. The methodology is not intended to be exhaustive, nor is it intended to be a “cook-book” approach to data analysis. Statistical analyses are routine only under ideal experimental conditions. The methods presented here will usually be adequate for the tests conducted under the conditions specified in this document. An experienced applied statistician should be consulted whenever there are questions.

The following are examples of departures from ideal experimental conditions that may require additions to or modifications of the statistical methods presented in this chapter:

- Unequal numbers of experimental organisms assigned to each treatment container, or loss of organisms during the experiment.
- Unequal numbers of replications (e.g., containers or aquaria) of the treatments.
- Different conditions of salinity, pH, dissolved oxygen, temperature, etc., among exposure chambers.
- Differences in placement conditions of the testing containers, or in the organisms assigned to different treatments.
- Contaminant concentration data reported as less than detection limit.

Treatment of nonideal data from dredged sediment evaluations is discussed at length in Clarke and Brandon (1996).

Statistical analysis of CDF pathway testing data is needed primarily for two types of biological tests—water column toxicity and bioaccumulation. The following statistical procedures will be covered:

- Tests of assumptions (normality and equality of variances).
- Data-scale transformations.
- Two-sample *t*-test.
- Nonparametric two-sample test.
- Power and sample size calculations.
- LC<sub>50</sub> calculations.
- Linear regression.
- Parametric multiple comparisons among treatments.
- Nonparametric multiple comparisons among treatments.
- Confidence interval calculations.
- Comparisons to action levels.

Decision trees are included to provide a general overview of each biological test. These trees illustrate which of the above statistical methods are appropriate for analyzing the results of each biological test, and the order in which the statistical procedures should be conducted. The trees include three general levels of decisions in the biological testing evaluation process: (1) decisions made by evaluating the experimental QA/QC and examining test treatment and reference means, (2) decisions concerning which statistical comparison procedure to use based on tests of assumptions, and (3) decisions concerning the significance of statistical comparisons.

The statistical methods (with the exception of linear regression) are illustrated in this Appendix with example data analyzed by SAS programs (SAS Institute, Inc. 1990a-d). This manual does not constitute official endorsement or approval of these or any other commercial hardware or software products. Other equally acceptable hardware and software products are commercially available and may be used to perform the necessary analyses. If it is necessary to write original programs to perform statistical analysis, the appropriateness of the techniques and accuracy of the calculations must be very carefully verified and documented.

Each example data set included in this Appendix is analyzed using several different statistical methods (usually, all of the possible tests in the appropriate decision tree) for illustrative purposes only. *Note that the results of different statistical tests will occasionally disagree, and it is never appropriate to conduct several tests in order to choose a preferred result.* Decisions concerning the proper statistical tests to use should be made *a priori*, based on such considerations as experimental design, hypotheses of interest, relative importance of

Type I and Type II error rates (Section L.1.2), and tests of assumptions (Sections L.2.1.1.1 and L3.1).

### L.1.1 Basic statistics

Statistical methods are used to make inferences about *populations*, based on *samples* from those populations. In most toxicity and bioaccumulation tests, samples of exposed organisms are used to estimate the response of the population of laboratory organisms. The response from the samples is usually compared with the response to a reference,<sup>1</sup> or with some fixed standard such as an FDA action level. In any toxicity or bioaccumulation test, summary statistics such as means and standard errors for response variables (e.g., survival, contaminant levels in tissue) should be provided for each treatment (e.g., elutriate concentration, soil, or sediment).

In the tests described herein, samples or observations refer to *replicates* of treatments. Sample size  $n$  is the number of replicates (i.e., experimental units, test containers) in an individual treatment, not the number of organisms in a test container. Overall sample size  $N$  is the total number of replicates in all treatments combined, i.e.,

$$N = n_1 + n_2 + n_3 + \dots + n_k \quad (\text{L-1})$$

where  $k$  is the total number of treatments in the experiment including the reference.

The statistical methods discussed in this Appendix are described in general statistics texts such as Steel and Torrie (1980), Sokal and Rohlf (1981), Dixon and Massey (1983), Zar (1984), and Snedecor and Cochran (1989). We recommend that investigators using this Appendix have at least one of these texts on hand. A nonparametric statistics text such as Conover (1980) can also be helpful.

**Mean.** The sample mean ( $\bar{x}$ ) is the average value, or  $Sx_i / n$ , where

$n$  = number of observations (replicates)

$x_i$  =  $i$ th observation, e.g.,  $x_2$  is the second observation

$Sx_i$  = every  $x$  summed =  $x_1 + x_2 + x_3 + \dots + x_n$ ; *usually written*  $Sx$

Most calculators and statistical software packages will provide means.

---

<sup>1</sup> Reference is used generically to refer either to a reference material (soil or sediment used in bioaccumulation testing), or to dilution water or control water (used in toxicity testing).

**Standard deviation.** The sample standard deviation (SD or  $s$ ) is a measure of the variation of the data around the mean. The sample variance,  $s^2$ , is given by:

$$s^2 = \frac{\sum x^2 - (\sum x)^2/n}{n - 1} \quad (\text{L-2})$$

**Standard error of the mean.** The standard error of the mean (SE, or  $s/\sqrt{n}$ ) estimates variation among sample means rather than among individual values. The SE is an estimate of the SD among means that would be obtained from several samples of  $n$  observations each. Most of the statistical tests in this manual compare means with other means (e.g., soil treatment mean with reference mean) or with a fixed standard (e.g., FDA action level). Therefore, the “natural” or “random” variation of sample means (estimated by SE), rather than the variation among individual observations (estimated by  $s$ ), is required for the tests.

In addition to the summary statistics above, two other statistics derived from the normal (bell-shaped) frequency distribution are central to statistical testing and to the tests described in this Appendix. These two statistics are normal deviates ( $z$ -scores) and Student's  $t$ .

**Normal deviates ( $z$ ).**  $Z$ -scores or normal deviates measure distance from the mean in standard deviation units in a normal distribution. For example, an observation one standard deviation greater than the mean has a  $z$ -score of 1; the mean has a  $z$ -score of 0.  $Z$ -scores are usually associated with a cumulative probability or proportion. For example, suppose an investigator wants to know the proportion of values in a normal distribution less than or equal to the mean plus one standard deviation. In this situation  $z = 0.84$ , i.e., in a normal distribution, 84 percent of values will be less than or equal to the mean plus 1 standard deviation. Alternatively, an investigator may want to determine the  $z$ -score associated with a specific proportion or probability. For example, he or she may want to know the range in which 95 percent of the values in a normal distribution should fall. That range is the mean  $\pm$  1.96 standard deviation ( $z$ -scores from -1.96 to +1.96).

Tables of  $z$ -scores can be found in most statistical texts, and bear titles such as “Standard Normal Cumulative Probabilities,” “Ordinates of the Normal Curve,” or “Normal Curve Areas.” Typically the  $z$ -scores are listed in the column (top) and row (left) margins, with the column marginal value being added to the row marginal value to obtain the  $z$ -score. The body of the table contains the probability associated with each  $z$ -score. However, depending on the table, that probability may refer to the proportion of all values less than the  $z$ -score, the proportion of values falling between zero and the  $z$ -score, or the proportion of values greater than the  $z$ -score. For example, if the  $z$ -score is 1.96, 97.5 percent of the values in a normal distribution fall below the  $z$ -score (Kleinbaum and Kupper 1978, Table A-1), 47.5 percent fall between zero and the  $z$ -score (Rohlf and Sokal 1981, Table 11), and 2.5 percent fall above the

$z$ -score (Steel and Torrie 1980, Table A.4). It is important to distinguish which probability is of interest.

$Z$ -scores can also be obtained from functions in statistical software packages. For example, in SAS the PROBIT function will return a  $z$ -score for a specified probability, and the PROBNORM function will compute the proportion of values less than a given  $z$ -score.

**Student's  $t$ .** Normal deviates can only be used to make inferences when the standard deviation is known, rather than estimated. The true population mean ( $\mu$ ) and standard deviation ( $s$ ) are only known if the entire population is sampled, which is rare. In most cases samples are taken randomly from the population, and the  $s$  calculated from those samples is only an estimate of  $s$ . Student's  $t$ -values account for this uncertainty, but are otherwise similar to normal deviates. For example, an investigator may want to determine the range in which 95 percent of the values in a population should fall, based on a sample of 20 observations from that population. If the sample consisted of the entire population,  $\mu$  and  $s$  would be known with certainty, and normal deviates would be used to estimate the desired range (as in the above paragraph). However, if the sample represented only a small proportion of the population,  $t$ -values would be used to estimate the desired range. The degrees of freedom for the test, which is defined as the sample size minus one ( $n - 1$ ), must be used to obtain the correct  $t$ -value. Student  $t$ -values decrease with increasing sample size, because larger samples provide a more precise estimate of  $\mu$  and  $s$ . For a probability of 95 percent, the appropriate range of  $t$ -values is  $-2.09$  to  $+2.09$  when  $n = 20$  (19 degrees of freedom). In other words, 95 percent of the values in the population should lie within the range: sample mean  $\pm 2.09 s$ . Note that this is wider than the corresponding range calculated using normal deviates. As sample size increases,  $t$ -values converge on the  $z$ -scores for the same probability.

Tables of  $t$ -values typically give the degrees of freedom (df or  $v$ ) in the row (left) margin and probabilities or percentiles in the column (top) margin. percentiles refer to the cumulative proportion of values less than  $t$ , whereas probabilities (also known as  $\alpha$  in this case) refer to the proportion of values less than  $-t$  and/or greater than  $+t$ . A two-tailed probability refers to both "tails" of the  $t$ -distribution curve, i.e., the probability of a value either  $>+t$  or  $<-t$ . A one-tailed probability refers to only one of the tails of the curve, e.g., the probability of a value  $>+t$ .

When using a  $t$  table, it is crucial to determine whether the table is based on one-tailed probabilities (such as Table V in McClave and Dietrich (1979), and Table A-2 in Kleinbaum and Kupper (1978)), or two-tailed probabilities (such as Table A.3 of Steel and Torrie (1980)). Some tables give both (such as Table B.3 of Zar (1984)). For most applications involving  $t$ -values in this Appendix, one-tailed probabilities are desired. The body of the table contains the  $t$ -value for each df and percentile (or  $\alpha$ ). The  $t$ -value for a one-tailed probability may be found in a two-tailed table by looking up  $t$  under the column for twice the desired one-tailed probability. For example, the one-tailed  $t$ -value for  $\alpha = 0.05$  and  $df = 20$  is 1.725, and is found in a two-tailed table using the column for  $\alpha = 0.10$ .

Statistical software packages may also provide functions to determine  $t$ -values or their associated probabilities. In SAS, these functions are TINV and PROBT.

### L.1.2 Hypothesis testing

The goal in analyzing data from certain CDF pathway tests, such as bioaccumulation, is to determine whether the mean effect of exposure to a dredged material is significantly greater than the mean effect of exposure to a reference. Two formal hypotheses underlie the statistical analysis of data in the two-sample situation. Let  $\mu_R$  denote the mean effect of exposure to a reference R, and let  $\mu_D$  denote the mean effect of exposure to a dredged material D. Then, these two hypotheses are defined as follows:

#### Null hypothesis.

Case 0:  $H_0: \mu_D = \mu_R$

There is no difference in mean effect between the treatment and the reference.

#### Alternative hypotheses.

Case 1:  $H_1: \mu_D < \mu_R$

The mean effect of the treatment is less than the mean effect of the reference (e.g., survival in the 100 percent elutriate is less than survival in the control water).

OR

Case 2:  $H_1: \mu_D > \mu_R$

The mean effect of the treatment is greater than the mean effect of the reference (e.g., bioaccumulation from the dredged material is greater than bioaccumulation from the reference).

Our hypothesis test will either reject  $H_0$  for  $H_1$  (Case 1 or Case 2), or will be unable to reject  $H_0$  (Case 0). A one-tailed test is used because there is little concern about identifying a lesser negative effect from the treatment than from the reference.

In performing the hypothesis test, and in determining the sample size to use in the test, the investigator must be aware of the probabilities for two types of errors that can occur in the conclusion. Type I errors occur if, after analysis of the data,  $H_0$  is rejected when it was actually true. In Case 1 for example, a Type I error occurs when it is concluded that the mean effect (e.g., survival) of the treatment is less than the mean effect of the reference when, in fact, the true

mean effect of the treatment is not less than that for the reference. Type II errors occur when  $H_0$  is not rejected when it actually should have been rejected (e.g., in Case 2, it is concluded that there is no difference in mean effects of the treatment and reference when, in fact, the true mean effect of the treatment is greater than that of the reference).

To be environmentally protective in dredged material disposal evaluations, it is more important to guard against Type II errors. A Type II error could result in inappropriate placement of dredged sediment, while a Type I error could result in more costly placement alternatives. The probability of a Type I error is often represented by the letter  $\alpha$ ; the probability of a Type II error is often written as  $\beta$ . The significance level or confidence level of a statistical test is  $1 - \alpha$ . The power of a test is  $1 - \beta$ , which is the probability of rejecting  $H_0$  when it should be rejected, or in other words, the power to detect true significant differences. For example, in Case 2 above, the power is the probability of concluding that the mean effect is greater in the treatment than in the reference when, in fact, this is true. The types of errors and their associated probabilities are summarized in Table L-1.

<b>Table L-1 Types of Errors in Hypothesis Testing and Associated Probabilities</b>		
<b>Hypothesis Test Conclusion</b>	<b>True State of Nature</b>	
	<b><math>H_0</math> True</b>	<b><math>H_0</math> False</b>
$H_0$ True(do not reject)	Correct (probability = $1 - \alpha$ )	Type II Error (probability = $\beta$ )
$H_0$ False(reject)	Type I Error (probability = $\alpha$ )	Correct (probability = $1 - \beta$ )

In hypothesis testing, the Type I error rate is usually prespecified (biological tests, by convention, generally set  $\alpha = 0.05$ , although there is nothing magical about this probability). An ideal statistical procedure for hypothesis testing seeks to maintain the predetermined  $\alpha$ , while minimizing the Type II error rate (i.e., maximizing power). It may not be possible to do both, particularly if the sample data depart from a normal distribution. A test that does well in maintaining the predetermined  $\alpha$ , regardless of the characteristics of the sample data, is considered “robust.” Tests included in this Appendix were chosen primarily on the basis of power rather than robustness, as the consequences of Type II error were considered more severe than those of Type I error.

Simple formulae for calculating the power of certain statistical tests used in this Appendix are presented along with the descriptions of the tests in Sections L.2.1.1.1, L.3.1, L.3.2.1, and L.3.2.2. The formulae may be used to calculate the sample size required to ensure a specific power of detecting an effect of a given magnitude (effect size), assuming that the effect exists. The formulae can also be used to calculate the power of a specific sample size to detect a specified difference. This latter approach is often more relevant than calculating required sample sizes because budget or logistical constraints usually limit the number of replicates that can be used in biological tests. This is especially true if the tests include expensive chemical analyses such as bioaccumulation tests.

### L.1.3 Experimental design

Once the investigator has formulated the null hypotheses to be tested, decided upon significance ( $\alpha$ ) and power ( $1 - \beta$ ) levels for hypothesis testing, and determined the sample size necessary to achieve the desired power, the next step is to design an experiment to test the hypotheses. Instructions for setting up and conducting toxicity and bioaccumulation experiments are outlined in the CDF pathway appendices, but it is important at this point to review the basic principles of *experimental design*. These principles include replication, randomization, interspersions, and controls (Hurlbert 1984).

Replication refers to the assignment of a treatment to more than one experimental unit. The number of replicates, as stated earlier, is the sample size for that treatment. Recall that an experimental unit or replicate is the test container (e.g., beaker, pot, or aquarium), *not* an individual organism in the test container. The number of organisms in the test container is important only in terms of constituting an adequate measure of the endpoint being tested (e.g., providing sufficient tissue to measure contaminant bioaccumulation). Replication of treatments is necessary to control for random error in the conduct of the experiment. The pathway appendices include guidelines for minimum number of replicates for the various bioassays. However, we strongly recommend determining sample size *a priori* using the power formulae in Sections L.2.1.1.1, L.3.1, and L.3.2.2. In many cases, the number of replicates necessary for a powerful statistical test will be greater than the minimum guidelines.

Randomization and interspersions refer to the actual placement of experimental units in the laboratory setup. A random numbers table, available in most statistical texts, may be used to randomly assign treatments to the experimental units. If the randomization does not achieve a reasonable interspersions of treatments, e.g., if several experimental units of the same treatment are clumped together, then a new randomization should be tried. Randomization and interspersions are necessary to control for investigator bias, for initial or inherent variability among experimental units, and for variability in environmental conditions such as lighting, water flow, etc.

Replication, randomization, and interspersions all function to control extraneous sources of variability in an experiment. In addition, *control treatment(s)* are needed to control temporal or procedural variability. In the broadest sense, the control treatment is simply the treatment against which the other treatments are compared. This is the dilution water (or control water) in acute toxicity testing, and the reference in bioaccumulation testing. Laboratory controls, such as a clean sand exposure in bioaccumulation testing, may also be included. Laboratory controls, if needed, are used for quality assurance, and are not included in the statistical analyses.

Testing in Tier III can in most cases be best accomplished using simple experimental designs, either a completely randomized design or a randomized complete blocks design. These designs are discussed in most general statistics texts. In a completely randomized design, treatments are assigned to experimental units randomly over the entire experimental setup. A randomized



complete blocks design should be used when the experimental units are placed on or in several different tables, benches or water baths (i.e., “blocks”). Each block holds a certain proportion of the experimental units. Treatments are assigned to experimental units randomly within each block, and each block contains an equal number of replicates of each treatment. Either of these designs is acceptable, providing the principles of replication, randomization, interspersion, and controls are followed. Adherence to the principles of experimental design ensures that the most basic assumption of statistical hypothesis testing, the assumption that treatments are sampled independently, is met.

## L.2 Statistical Methods for Water Column Tests

### L.2.1 Water column toxicity tests

The objective of the analysis of water column toxicity test data is to assess the evidence for reduced survival because of the toxicity of suspended plus dissolved dredged material constituents. If reduced survival is evident, then the median lethal concentration ( $LC_{50}$ ) or effective sublethal concentration ( $EC_{50}$ ) of the dredged material is calculated from a serial dilution experiment. Figures L-1 and L-2 provide an overview of water column toxicity test data analysis. Control survival must be  $\geq 90$  percent or some other appropriate value, otherwise the test must be repeated. At the end of the exposure period, the effects, if any, on the survival of the test organisms should be clearly manifest in the 100 percent elutriate concentration. When the dilutions are prepared with other than control water, the dilution water treatment is preferred over the control water for the data analysis. If the elutriate survival exceeds the control survival, then the toxicity test indicates no adverse impact from the dredged material.

#### L.2.1.1 Comparison of 100 percent elutriate and dilution water

##### L.2.1.1.1 Methods

**Two-sample  $t$ -test.** The usual statistical test for comparing two independent samples, such as the 100 percent elutriate and the dilution water in water column toxicity tests, is the two-sample  $t$ -test (Snedecor and Cochran 1989). The  $t$ -statistic for testing the equality of means  $\bar{x}_1$  and  $\bar{x}_2$  from two independent samples with  $n_1$  and  $n_2$  replicates is:

$$t = (\bar{x}_1 - \bar{x}_2) / \sqrt{s_{pooled}^2 (1/n_1 + 1/n_2)} \quad (L-3)$$

where  $s_{pooled}^2$ , the pooled variance, is calculated as:

$$s_{pooled}^2 = [s_1^2(n_1 - 1) + s_2^2(n_2 - 1)] / (n_1 + n_2 - 2) \quad (L-4)$$

and where  $s_1^2$  and  $s_2^2$  are the sample variances of the two groups. If the sample sizes are equal ( $n_1 = n_2$ ), then:

$$s_{pooled}^2 (1/n_1 + 1/n_2) = 2s_{pooled}^2/n \quad (\text{L-5})$$

The calculated  $t$  is compared with the Student  $t$  distribution with  $n_1 + n_2 - 2$  degrees of freedom.

The use of Equation L-2 to calculate  $t$  assumes that the variances of the two groups are equal. If the variances are unequal (see Tests for Equality of Variances below),  $t$  is computed as:

$$t = (\bar{x}_1 - \bar{x}_2) / \sqrt{s_1^2/n_1 + s_2^2/n_2} \quad (\text{L-6})$$

This statistic is compared with the Student  $t$  distribution with degrees of freedom given by Satterthwaite's (1946) approximation:

$$df = \frac{(s_1^2/n_1 + s_2^2/n_2)^2}{(s_1^2/n_1)^2 / (n_1 - 1) + (s_2^2/n_2)^2 / (n_2 - 1)} \quad (\text{L-7})$$

This formula can result in fractional degrees of freedom, in which case one should round  $df$  down to the nearest integer in order to use a  $t$  table. The degrees of freedom for the  $t$ -test for unequal variances will usually be less than the degrees of freedom for the  $t$ -test for equal variances.

**Tests of Assumptions.** The two-sample  $t$ -test for equal variances (and other parametric tests such as analysis of variance) is only appropriate if:

- There are independent, replicate experimental units for each treatment.
- Each treatment is sampled from a normally distributed population.
- Variances for both treatments are equal or similar.

The first assumption is an essential component of experimental design (Section L.1.3.0). The second and third assumptions can be tested using the data obtained from the experiment. Therefore, prior to conducting the  $t$ -test, tests for normality and equality of variances should be performed. In some statistical software packages, these tests of assumptions are done in conjunction with  $t$ -tests or as part of data summary or screening routines that also provide means,  $s$ , SE and various diagnostic statistics.

Outliers (extreme values) and systematic departures from a normal distribution (e.g., a log-normal distribution) are the most common causes of departures from normality and/or equality of variances. An appropriate transformation will normalize many distributions. In fact, the arcsine transformation (arcsine, in radians, of  $\sqrt{p}$ , where  $p$  is the survival expressed as a proportion) is so effective, and so frequently necessary, that this Appendix recommends applying it automatically to all survival data in the analysis of toxicity tests. Problems with outliers can usually be solved only by using

nonparametric tests, but careful laboratory practices can reduce the frequency of outliers.

**Tests for Normality.** The most commonly used test for normality for small sample sizes (<50 observations total) is the Shapiro-Wilk's Test. This test determines if residuals are normally distributed. Residuals are the differences between individual observations and the treatment mean. Residuals, rather than raw observations, are tested because subtracting the treatment mean removes any differences among treatments. This scales the observations so that the mean of residuals for each treatment and over all treatments is zero. The Shapiro-Wilk's Test provides a test statistic  $W$ , which is compared to values of  $W$  expected from a normal distribution.  $W$  will generally vary between 0.3 and 1.0, with lower values indicating greater departure from normality. Because normality is desired, one looks for a high value of  $W$  with an associated probability greater than the prespecified a level.

Table L-2 provides a levels to determine whether departures from normality are significant. Normality should be rejected when the probability associated with  $W$  (or other normality test statistic) is less than a for the appropriate total number of replicates ( $N$ ) and design. A balanced design means that all treatments have an equal (or nearly equal) number of replicate experimental units. For applications in this Appendix, a design may be considered unbalanced when the treatment with the largest number of replicates ( $n_{\max}$ ) has at least twice as many replicates as the treatment with the fewest replicates ( $n_{\min}$ ). Note that higher a levels are used when number of observations is small, or when the design is unbalanced, because these are the cases in which departures from normality have the greatest effects on  $t$ -tests and other parametric comparisons. If data fail the test for normality, even after transformation, nonparametric tests should be used (see Nonparametric Tests below).

<b>Table L-2 Suggested a Levels to Use for Tests of Assumptions</b>			
<b>Test</b>	<b>Number of Observations<sup>1</sup></b>	<b>a When Design Is</b>	
		<b>Balanced</b>	<b>Unbalanced<sup>2</sup></b>
Normality	$N = 3$ to 9	0.10	0.25
	$N = 10$ to 19	0.05	0.10
	$N = 20$ or more	0.01	0.05
Equality of Variances	$n = 2$ to 9	0.10	0.25
	$n = 10$ or more	0.05	0.10
<sup>1</sup> $N$ = total number of observations (replicates) in all treatments combined; $n$ = number of observations (replicates) in an individual treatment. <sup>2</sup> $n_{\max} = 2n_{\min}$ .			

Tables of quantiles of  $W$  can be found in Shapiro and Wilk (1965), Gill (1978), Conover (1980), USEPA (1989) and other statistical texts. These references also provide methods of calculating  $W$ , although the calculations can be tedious. For that reason, computer programs are preferred for the calculation

of  $W$ . SAS can calculate  $W$  using the NORMAL option in PROC UNIVARIATE (see Program WATTOX.SAS in Section L.4.1.1).

The Kolmogorov-Smirnov (K-S) Test is also an acceptable test for normality for small sample sizes, provided that the probabilities developed by Lilliefors (1967) are used (Sokal and Rohlf 1981). The SYSTAT NPAR module provides the appropriate test, and specifically identifies the test as Lilliefors Test (Wilkinson 1990). Other statistical packages providing K-S Tests may not use the Lilliefors probabilities, and the package documentation should always be checked to determine if the appropriate probabilities are provided. The chi-square ( $\chi^2$ ) test for normality can be used for larger sample sizes (e.g.,  $N > 50$ ) (Sokal and Rohlf 1981).

**Tests for Equality of Variances.** There are a number of tests for equality of variances. Some of these tests are sensitive to departures from normality, which is why a test for normality should be performed first. Bartlett's Test, Levene's Test, and Cochran's Test (Winer 1971; Snedecor and Cochran 1989) all have similar power for small, equal sample sizes ( $n = 5$ ) (Conover, Johnson, and Johnson 1981), and any one of these tests is adequate for the analyses in this Appendix. Many software packages for  $t$ -tests and analysis of variance (ANOVA) provide at least one of the tests. SAS now provides several tests for equality of variances, including Levene's and Bartlett's, in the HOVTEST= option of the MEANS statement in the GLM or ANOVA procedures. In the absence of specific software tests for equality of variances, Levene's Test can be performed by comparing the absolute values of residuals between treatments using  $t$ -tests or ANOVA.

If no tests for equality of variances are included in the available statistical software, Hartley's  $F_{\max}$  can easily be calculated:

$$F_{\max} = (\text{larger of } s_1^2, s_2^2) / (\text{smaller of } s_1^2, s_2^2) \quad (\text{L-8})$$

When  $F_{\max}$  is large, the hypothesis of equal variances is more likely to be rejected.  $F_{\max}$  is a two-tailed test because it does not matter which variance is expected to be larger. Some statistical texts provide critical values of  $F_{\max}$  (Winer 1971; Gill 1978 [includes a table for unequal replication, but only for  $\alpha = 0.05$ ]; Rohlf and Sokal 1981). In the two-sample case, Hartley's  $F_{\max}$  is the same as the Folded- $F$  or  $F'$  test. The  $F'$  test is conducted automatically in the SAS TTEST procedure.

Cochran's Test, where  $C$  = the largest variance divided by the sum of the variances, is also simple to calculate by hand, and is somewhat more powerful than Hartley's  $F_{\max}$  for small, equal sample sizes (Conover, Johnson, and Johnson 1981). However, tables of critical values of Cochran's  $C$  are not available in most statistical texts. Winer (1971) and Dixon and Massey (1983) include a table for Cochran's Test, but the tables are limited to tests with equal sample sizes. Tables of critical values for tests such as Cochran's  $C$  and Hartley's  $F_{\max}$  may also be restricted to one or two  $\alpha$  levels (usually 0.05 and 0.01). Because of the limitations of these tables, computer programs are preferred for tests of equality of variances.

Levels of  $\alpha$  for tests of equality of variances are provided in Table L-2; these depend upon number of replicates in a treatment ( $n$ ) and allotment of replicates among treatments (design). Relatively high  $\alpha$ 's are recommended because the power of the above tests for equality of variances is rather low when  $n$  is small. Equality of variances is rejected if the probability associated with the test statistic is less than the appropriate  $\alpha$ . If the test for equality of variances is significant even after transformation, the  $t$ -test for unequal (separate) variances should be selected rather than the  $t$ -test for equal (pooled) variances.

**Nonparametric Tests.** Tests such as the  $t$ -test, which analyze the original or transformed data and which rely on the properties of the normal distribution, are referred to as parametric tests. Nonparametric tests, which do not require that data be normally distributed, generally analyze the ranks of data, comparing medians rather than means. The median of a sample is the middle or 50th percentile observation when the data are ordered from smallest to largest. In many cases, nonparametric tests can be performed simply by converting the data to ranks or normalized ranks, and then conducting the usual parametric test procedures on the ranks.

Nonparametric tests are useful because of their generality but may have less statistical power than corresponding parametric tests when the parametric test assumptions are met.

When parametric tests are not appropriate for comparisons because the normality assumption is not met, we recommend converting the data to normalized ranks (rankits). Rankits are simply the  $z$ -scores expected for the rank in a normal distribution. Thus, using rankits imposes a normal distribution over all the data, although not necessarily within each treatment. Rankits can be obtained by ranking the data, then converting the ranks to rankits using the following formula:

$$\text{rankit} = z_{[(\text{rank} - 0.375) / (N + 0.25)]} \quad (\text{L-9})$$

where

$z$  = normal deviate

$N$  = total number of observations

For example, the approximate rankit for the sixth lowest value (rank = 6) of 20 observations would be  $z_{[(6 - 0.375) / (20 + 0.25)]}$ , which is  $z_{0.278}$  or  $-0.59$ .

In SAS, normalized ranks or rankits can be provided in PROC RANK with the NORMAL = BLOM option. In SYSTAT and other packages, the ranks must be converted to rankits using the formula above (the conversion is a one-line command). In some programs the conversion may be more difficult to make, especially if functions to provide  $z$ -scores for any probability are not available. When rankits cannot easily be calculated, the original data may be converted to ranks.

In comparisons involving only two treatments, there is no real need to test assumptions on the rankits or ranks; simply proceed with a one-tailed  $t$ -test for unequal variances using the rankits or ranks.

**Statistical Power.** For a  $t$ -test, the basic formula for calculating the sample size (number of replicate experimental units,  $n$ ) per treatment necessary to provide a specified power ( $1 - \beta$ ) to detect a given effect size ( $d$ ) is:

$$n = 2 ( t_{1-a,v} + t_{1-b,v} )^2 ( s^2 / d^2 ) \quad (\text{L-10})$$

where

$v$  = degrees of freedom (df) or  $(n_1 + n_2 - 2)$

$t_{1-a,v}$  = Student  $t$ -value for probability  $1 - a$  and  $v$  df

$t_{1-b,v}$  = Student  $t$ -value for probability  $1 - \beta$  and  $v$  df

$d$  = the effect size or difference to be detected.

Recall that  $\beta$  is the probability of committing a Type II error. This formula for  $n$  must be solved iteratively, because an initial value of  $n$  must be used to determine  $v$ . A new  $n$  is then calculated using the initial value, and the process is repeated until  $n$  and  $v$  are consistent. The iterative process can be tedious if computer programs are not used. It is easier to use the following approximate formula (from Alldredge 1987):

$$n = 2 ( z_{1-a} + z_{1-b} )^2 ( s^2 / d^2 ) + 0.25 ( z_{1-a}^2 ) \quad (\text{L-11})$$

where

$z_{1-a}$  = normal deviate for  $1 - a$

$z_{1-\beta}$  = normal deviate for  $1 - \beta$

$0.25(z_{1-a}^2)$  = correction term to increase sample size when  $n$  is small

Calculated  $n$  derived from this formula should be regarded as approximate for  $n < 5$ . Regardless of which formula is used, a fractional  $n$  is always rounded up to the next integer.

A useful exercise when sample sizes are fixed because of budget or logistic constraints is to calculate the power of the test to detect a specific effect size ( $d$ ). In a test comparing 100 percent elutriate survival with dilution water survival,  $d$  is some selected reduction in mean 100 percent elutriate survival from mean dilution water survival. Equation L-8 can be rearranged and solved for  $t_{1-\beta}$  to determine the power:

$$t_{1-b,v} = \frac{\sqrt{n}(d)}{\sqrt{2}(s)} - t_{1-a,v} \quad (\text{L-12})$$

We then enter a  $t$  table at  $v$  df and find the column closest to the value of  $t_{1-B}$ ; power  $\approx 1 - P$ , where  $P$  is the probability for that column. SAS can calculate power more exactly using the PROBT function for  $t_{1-B}$  and  $v$  df. Note that  $t$ -values can be used because both  $n$  and  $v$  are known. One can also calculate the difference that can be detected for any given power and sample size:

$$d = (t_{1-a,v} + t_{1-b,v}) \sqrt{2s^2/n} \quad (\text{L-13})$$

The simplest power to use is 0.50, because then  $t_{1-B} = 0$ . Many computer programs will provide this difference, usually referred to as the “minimum significant difference,” “least significant difference,” or some similar term. The term “average detectable difference” would also be applicable, as this is the difference we expect to be able to detect 50 percent of the time. In this Appendix, we recommend reporting the minimum significant difference or some other indication of power along with the results of statistical analyses. If power is consistently and regularly reported, investigators will gain an appreciation of the strengths and limitations of various toxicity tests and analyses.

If values are transformed prior to analyses, all power calculations should be done on the transformed scale. In the case of arcsine-transformed survival, a constant effect size  $d$  on the percentage or proportion scale will not be constant on the arcsine scale, because the latter scale spreads out high and low values. Therefore, a reference survival must be specified and arcsine-transformed, and the effect size also transformed to a difference on the arcsine scale. For example, suppose we wanted to calculate the power of a  $t$ -test to detect a 25 percent reduction in survival from the reference. A reasonable reference survival (e.g., 90 percent) would be specified and arcsine-transformed (=1.249). We would also arcsine-transform a 25 percent reduction (=65 percent survival or 0.938 after transformation). The difference  $d$  would then be 1.249 - 0.938 or 0.311, and that value would be used in power calculations. Experimentation with arcsine-transformed data will rapidly reveal that toxicity tests are more powerful, in terms of the size of differences that can be detected on the original (untransformed) scale, when reference survival is higher. In other words, we are more likely to detect a 25 percent reduction in survival if reference survival is 90 percent than if reference survival is 75 percent. This is precisely what happens in real toxicity tests, which is why the arcsine transformation is used for survival data.

Simple formulae for calculation of sample size or power are not available for the tests of assumptions recommended in this Appendix.

#### **L.2.1.1.2 Analysis of example data.**

Table L-3 contains example data from a 96-hr water column toxicity test using a dilution water and a dredged-sediment elutriate at four serial dilutions. In this example, control (laboratory) water was also used for dilutions, and no

separate control was necessary. In other cases, the dilution water may be receiving water and a separate laboratory control would be required. Analysis of this example data will be conducted using the decision tree in Figure L-1. Numbers in parentheses in the text refer to numbered nodes of the decision tree. The SAS program WATTOX and complete results for water column toxicity test data analyses are provided in Section L.4.1; some additional analyses were conducted using SYSTAT programs.

Means (*I*) and SE for the survival data are provided in Table L-3. Overall mean survival in the control (= dilution) water was 98 percent, indicating that the test was acceptable (2). The statistical comparison of 100 percent elutriate survival and dilution water survival was then conducted because the 100 percent elutriate survival was at least 10 percent lower than the dilution water survival (3). The next step was to arcsine transform the survival proportions for the dilution water and 100 percent elutriate treatments (4).

**Tests of Assumptions.** Following arcsine transformation, the data were tested for normality (5) to determine whether parametric or nonparametric procedures should be used. Table L-4 provides the results of tests for normality and equality of variances for the example data. The value of Shapiro-Wilk's *W* for the arcsine-transformed data was 0.846, with associated probability (*P*) = 0.051. Because this value of *P* exceeds 0.05 (a level from Table L-2, *N* = 10, balanced design), we conclude that the data do not depart significantly from the normal distribution (5), and we now examine the results of the tests for equality of variances (6).

<b>Table L-3 Number of Survivors in a Hypothetical Water Column Toxicity Test after 96 hr</b>					
	<b>Treatment<sup>1</sup></b>				
<b>Replicate<sup>2</sup></b>	<b>Dilution Water<sup>3</sup></b>	<b>100 percent</b>	<b>50 percent</b>	<b>25 percent</b>	<b>12.5 percent</b>
1	20	6	8	12	17
2	19	7	8	18	17
3	20	9	9	15	18
4	20	5	10	14	16
5	19	8	11	13	18
Total	98	35	46	72	86
Mean	19.6 (98 percent)	7.0 (35 percent)	9.2 (46 percent)	14.4 (72 percent)	17.2 (86 percent)
SE	0.24	0.71	0.58	1.03	0.37

<sup>1</sup> Percent concentrations of dredged-material elutriate:  
100 percent = 1 part elutriate plus 0 part dilution water  
50 percent = 1 part elutriate plus 1 part dilution water  
25 percent = 1 part elutriate plus 3 parts dilution water  
12.5 percent = 1 part elutriate plus 7 parts dilution water.  
<sup>2</sup> 20 organisms per replicate at initiation of test.  
<sup>3</sup> In this example, the dilution water was control (laboratory) water.



Bartlett's Test (from SYSTAT) and  $F'$  both indicated that the variances of arcsine-transformed data were not significantly different for the two treatments, with  $P > 0.10$  (a level from Table L-2,  $n = 5$ , balanced design). Thus, on the basis of these tests, we would proceed with a  $t$ -test for equal variances (7).

**Two-sample t-tests.** Table L-4 provides the results of  $t$ -tests for equal (7) and unequal variances (8). The  $t$ -test for equal variances indicated that survival in the 100 percent elutriate was significantly ( $P < 0.05$ ) less than in the dilution water (9). If the data had been normally distributed with unequal variances, the  $t$ -test for unequal variances would have been used. With the example data, both test results are the same, but this will not always be the case.

**Nonparametric Test.** Nonparametric tests would generally not be performed on these data because the sample data did not depart significantly from a normal distribution. However, the data were converted to rankits (10), and a  $t$ -test for unequal variances (11) was conducted on the rankits (SAS Program WATTOX) for illustrative purposes. The  $t$ -test indicated that median survival in the 100 percent elutriate was significantly lower than in the dilution water (Table L-4).

**Statistical Power.** The difference in survival between the 100 percent elutriate and the dilution water was so large (63 percent) that it was easily detected (declared significant), even though there were only five replicates per treatment. The power of a  $t$ -test to detect such a large decrease in survival ( $d = 0.848$  on the arcsine scale) when  $n = 5$  and  $s = 0.1055$  (also on the arcsine scale) is  $>0.99$ . However, it is reasonable to ask if  $n = 5$  is adequate for detecting smaller differences. For example, what sample size would be required to provide a 0.95 chance ( $1 - \beta = 0.95$ ;  $z_{1-\beta} = 1.645$ ) of detecting a reduction of survival to 80 percent, with  $\alpha = 0.05$  ( $z_{1-\alpha} = 1.645$ )? In the example data, mean arcsine-transformed dilution water survival was 1.4806 (99 percent survival; back-transformation of means of transformed values will not be the same as means based on original data, although the difference is trivial in this case); the arcsine-transformed value for 80 percent survival is 1.1071, giving a reduction ( $d$ ) of 0.3736 on the arcsine scale; and the pooled  $s$  was 0.1055. Using Equation L-14:

$$n = 2(1.645 + 1.645)^2 (0.1055^2/0.3736^2) + 0.25(1.645^2) = 2.40 \quad (\text{L-14})$$

Rounding up gives  $n = 3$ . A more exact iterative computer program (SYSTAT DESIGN) based on  $t$ -values (Equation L-13) also yields  $n = 3$ . The sample size required for a 0.95 probability of detecting a reduction in survival to 90 percent is  $n = 6$ , again calculated with the iterative program. The minimum significant difference (i.e., the difference we have a 0.50 probability of detecting) when  $n = 5$  is  $t_{0.95,8}(2s^2/n)^{1/2}$  or  $1.86[2(0.1055^2/5)]^{1/2} = 0.1241$ . Subtracting that from the mean transformed dilution water survival, and back-transforming gives 95.5 percent survival. In other words, given the example data, the test can be expected to detect a reduction in survival from  $\approx 99$  percent to  $\approx 95$ -96 percent approximately half the time.

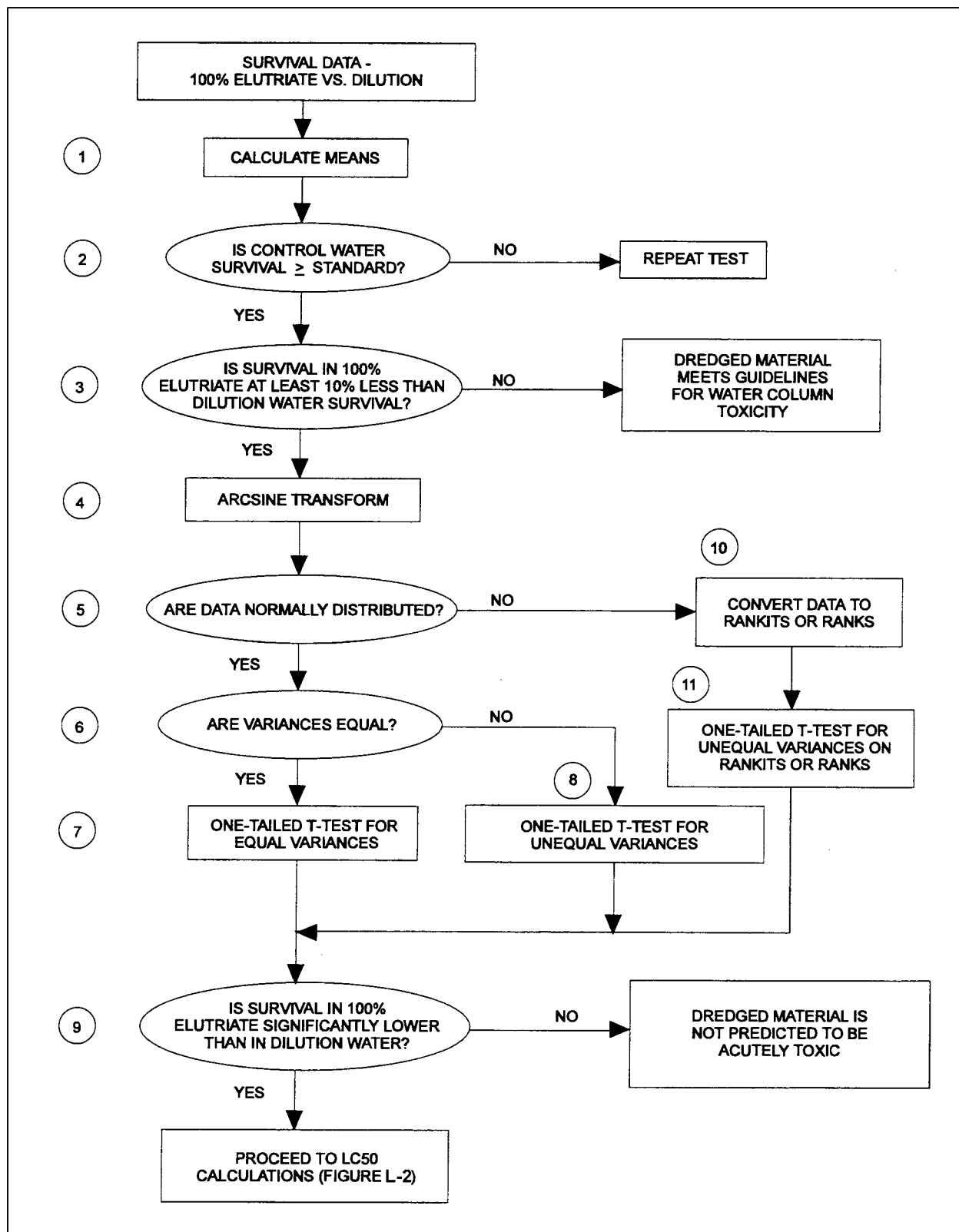

Figure L-1. Water column toxicity test decision tree

<b>Table L-4 Tests of Assumptions and Hypothesis Tests on Arcsine- Transformed Water Column Toxicity Test Example Data</b>				
<b>Null Hypothesis: Mean 100 percent Elutriate Survival Equals Mean Dilution Water Survival<sup>1</sup></b>				
<b>Test</b>	<b>Test Statistic</b>	<b>Probability, P</b>	<b><math>\alpha</math></b>	<b>Conclusion</b>
Normality Assumption: Shapiro-Wilk's Test	$W = 0.846$	0.051	0.05	Do not reject
Equality of Variances Assumption: Bartlett's Test	$F = 0.5$	0.47	0.25	Do not reject
$F?$ Test	$F? = 2.18$	0.468	0.25	Do not reject
Null Hypothesis: <u><math>t</math>-Test (equal variances)</u>	<u><math>t = 12.734</math></u>	<u><math>&lt;0.0001</math></u>	<u>0.05</u>	<u>Reject</u>
$t$ -Test (unequal variances)	$t = 12.734$	$<0.0001$	0.05	Reject
$t$ -Test on rankits (unequal variances)	$t = 4.631$	0.0010	0.05	Reject
<sup>1</sup> Based on tests of assumptions, appropriate statistical test of null hypothesis is underlined. Other test results are included for illustration only.				

When dilution water survival is near 100 percent and variation among replicates is low, as with the example data, a test with  $n = 5$  replicates may be too powerful. In many cases, we would declare survival of  $\geq 90$  percent in the 100 percent elutriate significantly lower than in the dilution water, yet that same  $\geq 90$  percent survival would be acceptable for the dilution water. For this reason, if survival in the 100 percent elutriate is not at least 10 percent lower than in the dilution water, the difference should not be considered significant and no statistical tests need be performed. *It is important to remember that a statistically significant difference is not necessarily biologically significant (and vice versa).* If dilution water survival were lower, say 90 percent instead of 98 percent, and  $s$  remained the same, the  $t$ -test would have less power. For example,  $n = 13$  would be required to provide a 0.95 probability of detecting a reduction in survival in the 100 percent elutriate to 80 percent. Much higher standard deviations can also be expected in many toxicity tests.

The SAS program WATTOX (Section L.4.1) provides minimum significant difference and power of a  $t$ -test. Power is determined for 10, 20, 30, 40 and 50 percent reductions in true population survival from the mean dilution water survival.

### **L.2.1.2 Calculating median lethal concentration**

In water column toxicity tests, the median lethal concentration, i.e., concentration lethal to 50 percent of the test organisms ( $LC_{50}$ ), is calculated when 100 percent elutriate survival is significantly lower than dilution water survival. Steps and decisions in the  $LC_{50}$  determination are shown in the decision tree in Figure L-2. Numbers in parentheses in the text refer to numbered nodes of the decision tree.

Ideally, data for at least five elutriate concentrations should be available to calculate an  $LC_{50}$ , although most methods described below can be used for fewer concentrations. The control or dilution water survival is not included. Survival

in the lowest elutriate concentration must be at least 50 percent (1); otherwise the test must be repeated using lower concentrations (2). An LC<sub>50</sub> should not be calculated unless at least 50 percent of the test organisms die in at least one of the serial dilutions (3). If there are no mortalities greater than 50 percent, then the LC<sub>50</sub> is assumed to be  $\geq 100$  percent elutriate (4).

If the conditions in (1) and (3) are met, then replicate mortality data for each concentration are pooled (5) for calculation of LC<sub>50</sub> (6). The Probit method (7) can be used if the data meet the requirements of the Probit method listed below and fit the probit model (8). The Trimmed Spearman-Kärber (TSK) and Logistic methods (described below) are acceptable substitutes for the Probit method, provided that these data meet the requirements of these alternative methods. If these data do not meet the requirements of the Probit method or alternatives, then the Linear Interpolation method should be used (9). When an LC<sub>50</sub> value has been determined, 1 percent of that value is entered into the mixing model (10) provided in Appendix E for mixing zone evaluation.

Calculation of LC<sub>50</sub> values is also recommended for reference toxicant tests to determine the relative health of the organisms used in toxicity and bioaccumulation testing.

#### **L.2.1.2.1 Methods for calculating LC<sub>50</sub>**

Stephan (1977) and Gelber et al. (1985) provide careful reviews of LC<sub>50</sub> estimation procedures. In addition, USEPA (1985) discusses in detail the mechanics of calculating LC<sub>50</sub> using various methods and contains, as an appendix, computer programs for each statistical method. The most commonly used methods are the Probit, Trimmed Spearman-Kärber (TSK) and Linear Interpolation. This Appendix recommends use of the Probit, TSK or Logistic methods if the data are appropriate; otherwise the Linear Interpolation method may be used (Figure L-2). In general, results from different methods should be similar. Programs commonly used to calculate LC<sub>50</sub> are PROBIT, developed for and available from the USEPA (Environmental Monitoring and Support Laboratory, Cincinnati, OH), and several programs developed by Dr. C.E. Stephan, the USEPA Environmental Research Laboratory, Duluth, MN. SAS program statements for the Probit procedure are included in WATTOX (Section L.4.1).

**Probit.** The Probit method is based on regression of the probit of mortality on the log of concentration. A probit is the same as a z-score; for example, the Probit corresponding to 70 percent mortality is  $z_{0.70}$  or  $\approx 0.52$ . The LC<sub>50</sub> is calculated from the regression, and is the concentration associated with  $z = 0$  (mortality = 50 percent). The Probit method can be used whenever the following conditions are met:

- There are at least two concentrations with partial mortality (i.e.,  $>0$  and  $<100$  percent).
- These data points fit the probit regression line reasonably well.

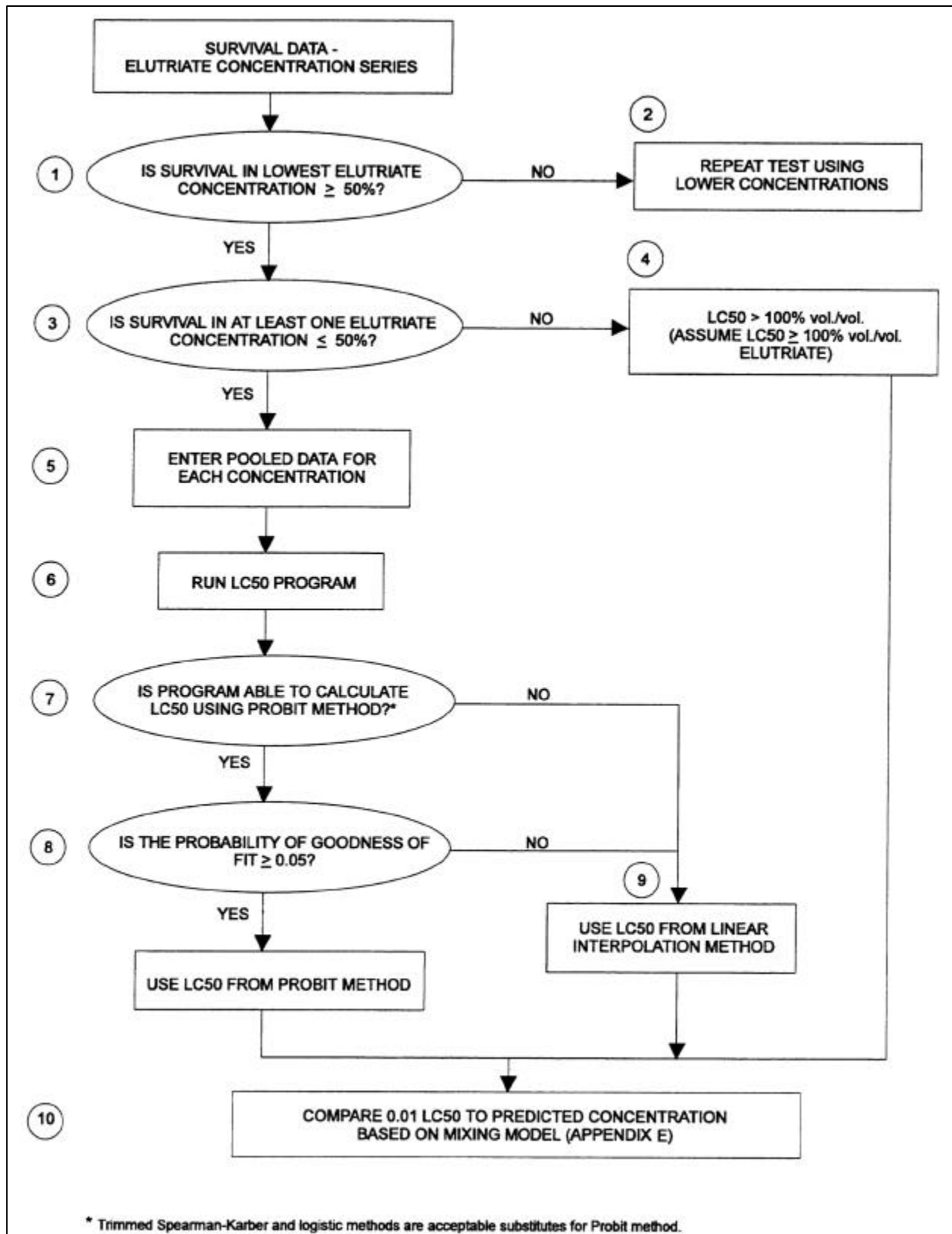

Figure L-2. LC<sub>50</sub> decision tree

The first condition is necessary because the regression line is estimated from the partial mortalities. The second condition, called goodness-of-fit, can be tested by the  $\chi^2$  statistic, which is a measure of the distance of the data points from the regression line. A low  $\chi^2$  indicates a good fit. By convention, the fit is considered adequate if the  $P$ -value for  $\chi^2$  is  $>0.05$  (in other words, goodness-of-fit is rejected if  $P \leq 0.05$ ). If the  $P$ -value is not provided, the goodness-of-fit  $\chi^2$  should be compared against tabled values with  $k - 2$  df, where  $k$  is the number of partial mortalities. If there are only two partial mortalities ( $k = 2$ ), then there are 0 df, and the goodness-of-fit cannot be tested (i.e., a line between two points is always a perfect fit). When there are only two partial mortalities, the  $LC_{50}$  is identical to the  $LC_{50}$  which would be calculated by Linear Interpolation (see below) with mortality expressed on a probit scale. Goodness-of-fit can also be assessed by eye, if the data are plotted on log-probit paper, or if the computer program provides a plot.

The SAS probit procedure (PROC PROBIT) provides a goodness-of-fit  $\chi^2$  and its associated  $P$ -value if the LACKFIT option is specified. Model-predicted mortalities can also be plotted against observed mortalities to assess model fit. The INVERSECL option provides an estimate of  $LC_{50}$  as well as other effects concentrations ranging from  $LC_1$  to  $LC_{99}$ .

**Logistic Method.** The Logistic method is similar to the Probit method except that mortalities are converted to logits rather than probits. A logit is  $\log [M/(100 - M)]$ , where  $M$  is percent mortality. The  $LC_{50}$  is derived from a regression of logits on log concentration. As with the Probit method, the Logistic method can be used whenever there are two or more partial mortalities, and the data fit the regression line. SAS PROC PROBIT can calculate  $LC_{50}$  using the Logistic method by specifying the D=LOGISTIC option in the model statement.

**Trimmed Spearman-Kärber (TSK) Method.** The TSK method is a nonparametric method that can be calculated by hand using the procedure in Gelber et al. (1985). The calculations can be tedious, especially for processing large numbers of tests, and computer programs are usually used. The method is labelled “trimmed” because extreme values (mortality much higher or lower than 50 percent) are “trimmed” or removed prior to calculation of the  $LC_{50}$ . Thus, the  $LC_{50}$  is calculated using points near 50 percent mortality, which may produce a more robust estimate. The TSK method can be used in many cases where the Probit method is unsuitable. Access to appropriate computer programs and difficulties in deciding what values to trim are probably the major factors limiting widespread use of the TSK method. Investigators with access to reliable programs should not hesitate to use the TSK method whenever there are two or more partial mortalities. Information concerning TSK computer programs may be obtained from the USEPA Environmental Research Laboratories in Athens, GA, or Duluth, MN, or CSC/USEPA, Cincinnati, OH.

**Linear Interpolation Method.** The Linear Interpolation method should be used when:

- There are 0 or 1 partial mortalities.

- The data do not fit the Probit (or Logistic) models.

The Linear Interpolation method should also be used when  $LC_{50}$ s are calculated and compared over an extended time series (i.e., for tracking reference toxicant results), because inevitably, one or more data sets will fail to meet the requirements for the Probit, TSK, or Logistic methods. Linear Interpolation may also be used if programs for the other methods are unavailable, but we strongly recommend that investigators have programs available for one or more of the other methods.

The Linear Interpolation method calculates an  $LC_{50}$  by interpolation between the two concentrations with mortality nearest to, and on either side of 50 percent. The interpolation is made on a log concentration scale, using the following formula:

$$LC_{50} = \text{antilog} \frac{(50 - M_L)(\log C_U) + (M_U - 50)(\log C_L)}{M_U - M_L} \quad (\text{L-15})$$

where

$C_L$  = concentration with mortality nearest to and below 50 percent

$C_U$  = concentration with mortality nearest to and above 50 percent

$M_L$  = percent mortality at  $C_L$

$M_U$  = percent mortality at  $C_U$ .

If there are no partial mortalities, the formula simplifies to:

$$LC_{50} = \sqrt{(C_U)(C_L)} \quad (\text{L-16})$$

For the example data given in Table L-3,  $C_L$  = 25 percent elutriate ( $\log = 1.398$ );  $M_L$  = 28 percent mortality;  $C_U$  = 50 percent elutriate ( $\log = 1.699$ ); and  $M_U$  = 54 percent mortality. Therefore:

$$LC_{50} = \text{antilog} \frac{(50 - 28)(1.699) + (54 - 50)(1.398)}{54 - 28} \quad (\text{L-17})$$

or 44.9 percent.

The formula and example given above express mortality on an arithmetic (untransformed) scale. Some computer programs or investigators may use arcsine-transformed mortalities (Stephan 1977; see Section L.2.1.1.1, Tests of Assumptions). One could also express mortality on a probit or logit scale, if there were one partial mortality on each side of 50 percent. In those cases, the Linear Interpolation should produce the same  $LC_{50}$  estimate as the Probit or

Logistic methods. In this manual, we recommend the use of untransformed mortality for simplicity and consistency. However, LC<sub>50</sub> estimates using other scales can easily be calculated for comparison.

### L.2.1.2.2 Analysis of example data

The data from Table L-3 were analyzed using several different LC<sub>50</sub> methods, including the Probit procedure in the SAS program WATTOX (Section L.4.1.1). In the Probit output (Section L.4.1.2), the chi-square goodness-of-fit statistic (shown in bold) is not significant ( $\chi^2 = 1.7558$ ,  $P = 0.4157$ ), indicating acceptable fit to the Probit model (i.e., no significant lack of fit). The LC<sub>50</sub> is obtained from the second output table of probabilities, where probability = 0.50 (shown in bold). Other lethal effects concentrations may be obtained from the same table, e.g., LC<sub>10</sub> or LC<sub>5</sub>. The SAS Probit plot of observed and predicted mortalities is given in Figure L-3.

Table L-5 provides LC<sub>50</sub> estimates calculated by several different methods using the example data in Table L-3. The data from the five replicates for each concentration may be pooled and entered as the number responding (dying) out of 100. *Because pooling over replicates ignores any additional variance in survival among replicates (i.e., beyond the expected error from sampling the binomial distribution), the confidence limits provided by the programs may not be accurate and should not be reported or used.* Because the LC<sub>50</sub> is required only for use in the mixing model (Appendix H), confidence limits are not needed.

<b>Table L-5 Calculated LC<sub>50</sub> Values for Example Water Column Toxicity Test Data</b>	
<b>Method</b>	<b>LC<sub>50</sub> Estimate (percent v/v)</b>
Probit	52.6
Linear Interpolation - untransformed mortality - arcsine-transformed mortality	44.9 45.1
Trimmed Spearman-Kärber	48.4
Logistic	52.6

The Probit LC<sub>50</sub> was calculated with the EPA PROBIT program and was almost identical to the Logistic LC<sub>50</sub> calculated using the SYSTAT LOGISTIC program (the same estimates are obtained using the SAS PROBIT procedure). The LC<sub>50</sub> estimated by Linear Interpolation, with untransformed mortality, was almost identical to the LC<sub>50</sub> calculated using arcsine-transformed mortality. The TSK LC<sub>50</sub> was calculated using a program modified from an original program described in Hamilton, Russo, and Thurston (1977), and was intermediate between the Linear Interpolation and regression (Probit and Logistic) estimates.



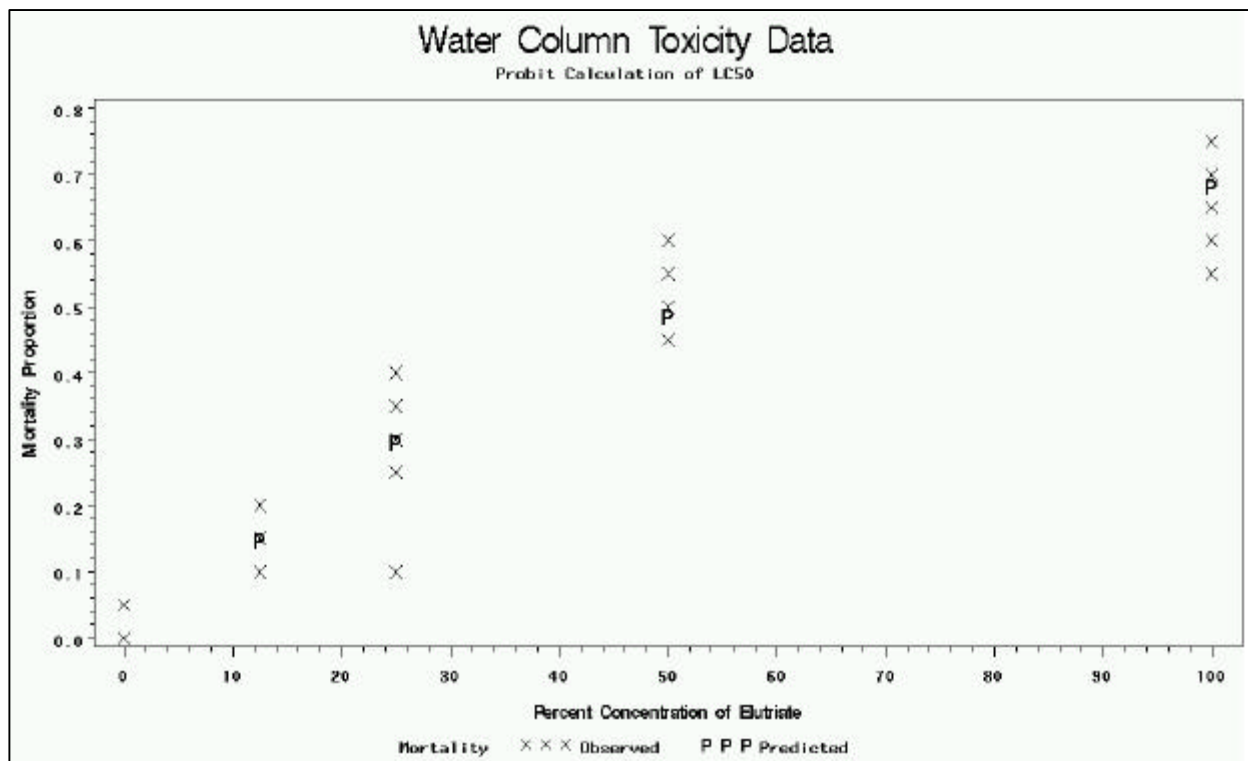

Figure L-3. SAS probit plot of water column toxicity test example data

The various estimates in Table L-5 differed by up to 7.7 percent elutriate, which is not unusual or alarming. The Probit or Logistic  $LC_{50}$  would be the preferred estimate, because the regression lines fit the data well, and the regression methods use more of the data in such cases. However, any of the estimates would be adequate for use in the mixing model in Appendix H, because the imprecision and uncertainty involved in the model calculations and estimates are undoubtedly far greater than the differences among the  $LC_{50}$  estimates.

Acute toxicity endpoints other than  $0.01*LC_{50}$  can be considered for use in the mixing model. These endpoints include low toxic effects concentrations such as  $LC_{10}$  (Moore and Caux 1997; Scholze et al. 2001); the No Observed Effects Concentration (NOEC) (Capizzi et al. 1985); and the Inhibition Concentration  $IC_p$ , where  $p$  is a percent reduction from control response (USEPA 1994).

## L.2.2 Linear regression

Linear regression may be needed to characterize the site-specific relationship between suspended solids and turbidity in effluent pathway testing. The regression equation is used to predict suspended solids concentrations from turbidity measurements. Linear regression may also be used to calculate the contaminant distribution coefficient ( $K_d$ ) in the sequential batch leach test for leachate evaluation.  $K_d$  is the slope of the linear regression of leachate concentrations versus sediment concentrations of a contaminant of concern for

each leach cycle. Linear regression is generally calculated using the method of least squares and follows the form

$$Y = aX + b \quad (\text{L-17})$$

where

$Y$  = dependent or response variable

$X$  = independent or predictor variable

$a$  = slope

$b$  = Y-intercept

Linear regression assumes the following:

- $Y$  values are statistically independent of one another.
- Relationship between  $Y$  and  $X$  is linear.
- Variance of  $Y$  is the same for any  $X$  (homoscedasticity).
- For any fixed value of  $X$ ,  $Y$  has a normal distribution.

As in hypothesis testing, satisfying these assumptions (especially the assumption of linearity) may require using a data transformation.

Linear regression may be performed using any general-purpose statistical package; many hand calculators also include regression functions. Data should always be plotted first in a scattergram to visually inspect for a functional relationship between the two variables. When regression is used to characterize the relationship between suspended solids and turbidity, it may be necessary to use a nonlinear regression model, or to calculate a linear regression only for a lower, linear portion of the data. Investigators should refer to Thackston and Palermo (2000) (<http://www.wes.army.mil/el/dots/doer/pdf/doere8.pdf>) for instructions on performing the regression analysis.

When a statistical package is used to calculate the regression analysis, the strength and validity of the relationship between  $Y$  and  $X$  can be evaluated by examining the regression output for the  $F$  statistic and its associated  $P$ -value, and for the  $R^2$  statistic. The  $P$ -value of  $F$  determines the probability that the regression coefficient (slope) is significantly different from zero, given the above assumptions.  $P$ -values  $> 0.05$  indicate that no significant linear relationship exists between the two variables.  $R^2$  or coefficient of determination is the proportion or percent of the variability in  $Y$  that is explained by  $X$ . Like the correlation coefficient  $r$ , strong relationships are indicated by coefficients approaching 1 (or 100 percent); conversely, low values of  $R^2$  signify weak or nonexistent relationships.

## L.3 Statistical Methods for Bioaccumulation

Bioaccumulation tests are applied to determine whether exposure to dredged material is likely to cause an elevation of contaminants in plant or animal tissues compared with exposure to a reference. Bioaccumulation tests may be conducted in the laboratory or in the field.

Situations may arise, particularly in the evaluation of plant or animal contaminant uptake, where several sites, treatments, or dredged sediments are simultaneously compared with a reference or control. If only one treatment is compared to the reference, then the procedures described in Section L.2.1.1.1 (tests of assumptions followed by a *t*-test using a transformation or rankits if necessary) for comparing two samples are used. If more than one treatment is compared to the reference, then the procedures described below (tests of assumptions followed by LSD, *t*-tests, or nonparametric equivalents) are used. These analyses assume that individual sites are relatively large, and that a decision concerning any particular site based on pathway testing results will be made independently for each site.

Because contaminant concentration data are not easily expressed as proportions, the arcsine transformation is not appropriate. The raw data are analyzed first and, if necessary, a transformation may be employed. Contaminant concentration data often follow a lognormal distribution so the logarithmic (either natural or base 10) transformation is frequently used, but other transformations such as square root are possible. As always, tests of assumptions must be rerun on the data following transformation. If the transformed data violate the normality assumption, the data are converted to rankits (or ranks) and the assumptions are retested.

### L.3.1 Methods for multiple comparisons

**Fisher's Least Significant Difference (LSD).** Fisher's Least Significant Difference (LSD) is appropriate for assessing differences in bioaccumulation when more than two means are being compared. This *a posteriori* parametric multiple comparison technique is discussed in many statistical texts, e.g., Steel and Torrie (1980); SAS Institute, Inc. (1990c); Snedecor and Cochran (1989); and Wilkinson (1990). The LSD controls the pairwise Type I error rate rather than the experimentwise Type I error rate. This means that when the test assumptions are met, the Type I error rate for each comparison is held to the preset  $\alpha$  even though the overall Type I error rate for all comparisons (i.e., experimentwise error rate) may be higher. A test that controls the pairwise error rate is appropriate when decisions are to be made independently for each test site regardless of how many sites are compared to the same reference. In situations where rigorous control of experimentwise Type I error rate is important, e.g., if decisions will not be made independently for each test site, Dunnett's test would be preferred to the LSD test.

The LSD is usually performed in conjunction with analysis of variance (ANOVA), and only if the data meet the assumptions of normality and equal

variances. The ANOVA is conducted primarily to provide the mean square error (*MSE*), which is an estimate of the pooled variance across all treatments. The ANOVA *F*-statistic and its associated probability are ignored in this application.

The test statistic for the LSD is *t*, calculated in much the same way as for a *t*-test:

$$t = (\bar{x}_1 - \bar{x}_2) / \sqrt{MSE(1/n_1 + 1/n_2)} \quad (\text{L-18})$$

This *t*-statistic is compared against the distribution of Student's *t* with *N - k* degrees of freedom, where *N* is the total number of observations (*Sn*) and *k* is the number of treatments including the reference. A *t*-statistic is computed for each possible pair of treatments in the analysis but comparisons other than with the reference are ignored.

The *MSE* can be calculated as:

$$MSE = \Sigma [s_i^2(n_i - 1)] / \Sigma(n_i - 1) \quad (\text{L-19})$$

where  $s_i^2$  and  $n_i$  are the variance and number of replicates for the *i*th treatment. The term  $\Sigma(n_i - 1)$  is equivalent to *N - k*.

If sample sizes are equal, then (from Equation L-14):

$$MSE(1/n_1 + 1/n_2) = 2MSE/n \quad (\text{L-20})$$

The major advantage of using the LSD as opposed to conducting individual two-sample *t*-tests comparing each dredged sediment to the reference is that the *MSE* is a better estimate of the true population variance than the pooled variance calculated from only two samples. Consequently, the LSD test is more powerful, as reflected in the greater df for the calculated *t*. It also follows that a pooled variance should only be calculated, and the LSD test conducted, if the variances for all treatments are not significantly different from each other.

**Tests of Assumptions.** The Shapiro-Wilk's Test described in Section L.2.1.1.1 can also be used to test for normality when more than two treatments are compared. If the data are not normally distributed, even after an appropriate transformation, then nonparametric tests should be used (see Nonparametric Tests below).

Bartlett's Test, Levene's Test,  $F_{\max}$ , or Cochran's Test can be used to test for equality of variances. When there are more than two samples,  $F_{\max}$  is equal to the largest variance divided by the smallest variance. If variances are significantly unequal, even after transformation, then each dredged sediment should be compared with the reference using two-sample *t*-tests.

**Nonparametric Tests.** When parametric tests are not appropriate for multiple comparisons because the normality assumption is violated, the data should be converted to rankits, and the rankits should be tested for normality and

equality of variances. If these assumptions are not violated, an LSD test is then performed on the rankits (Conover 1980, refers to this as van der Waerden's Test). Tests performed on rankits are robust to departures from normality and can still be used when the normality assumption is violated. Rankits will rarely fail tests for normality, partly because a normal distribution is imposed over the entire data set. The rankit data may fail the test for equality of variances, but then *t*-tests can be conducted for each treatment - reference comparison. If rankit-transformed data fail normality tests, it is probably safest to use the *t*-tests for unequal variances, as some tests for equality of variance are not robust when data are nonnormal.

When rankits cannot be easily calculated, the original data may be converted to ranks (using SAS PROC RANK, for example). Equality of variances should be tested after the data are ranked. There is a common misconception that nonparametric tests can be used when variances are not equal as well as when data are not normally distributed. However, nonparametric tests are not very robust if the variances of the ranks are not similar among treatments. Bartlett's Test should not be used to test equality of variances of ranks, as ranks will follow a uniform, rather than a normal distribution, and Bartlett's Test is unduly sensitive to nonnormality. Other tests discussed in Section L.2.1.1.1, Tests for Equality of Variances, may be used on ranks; there are also nonparametric tests for equality of variances provided by Conover (1980).

If the variances of the ranks are not significantly different, the Conover *T*-Test (Conover 1980) should be performed. This test can most easily be conducted by performing an LSD test on the ranks. If the variances of ranks are significantly unequal, a one-tailed *t*-test for unequal variances should be performed (using ranks) for each treatment - reference comparison.

Dunn's Test, as described in Hochberg and Tamhane (1987), is an acceptable nonparametric alternative to the Conover *T*-Test or the LSD on rankits.

**Statistical Power.** Power calculations for the LSD test are the same as for the *t*-test (Equation L-8), except that the degrees of freedom for  $t_{1-\alpha}$  and  $t_{1-\beta}$  are  $N - k$ , and *MSE* replaces  $s^2$ :

$$n = 2 ( t_{1-\alpha, v} + t_{1-\beta, v} )^2 (MSE / d^2) \quad (\text{L-21})$$

If the *z*-approximation (Equation L-9 with *MSE* replacing  $s^2$ ) is used to calculate samples size, the result will be a slight overestimate, although the overestimation is rarely of practical importance. Finally, the minimum significant difference should be reported for LSD tests. Note that the test is named the Least Significant Difference because another way to conduct the test is to compare the observed differences to the minimum significant difference.

If power (1 -  $\beta$ ) is low because of high variability or small sample size, one effective method of increasing power is to increase the number of reference replicates rather than increase the sample size for each treatment. It is even possible to increase power without increasing overall sample size by increasing

sample size for the reference, and decreasing sample size for the test sites. The optimal apportionment of replicates is to make the sample size for the reference  $\sqrt{k}$  times the sample size for the test sites (Dunnett 1955). Increasing sample size for the reference is effective because the reference is involved in every comparison, whereas the test sites are involved in only one comparison each.

### L.3.2 Analysis of example data

Table L-6 presents example results for one contaminant from a hypothetical laboratory bioaccumulation test, in which animals were exposed to a reference sediment and to three different dredged sediments. Chemical analysis of the tissue samples from each replicate shows that concentrations of the example contaminant varied among and within treatments. Two types of analyses may be performed on the tissue contaminant concentration data:

- Comparisons between each dredged sediment treatment and the reference.
- Comparisons with an action level when applicable.

Computer procedures for statistical analysis of bioaccumulation data are given in SAS program BIOACC (Section L.4.2).

<b>Table L-6 Results from a Hypothetical Bioaccumulation Test, Showing Contaminant Concentrations (<math>\mu\text{g/g}</math>) in Tissues of Animals Exposed to Different Treatments</b>				
	<b>Treatment</b>			
<b>Replicate</b>	<b>Reference</b>	<b>Sediment 1</b>	<b>Sediment 2</b>	<b>Sediment 3</b>
1	0.06	0.16	0.24	0.13
2	0.05	0.19	0.10	0.05
3	0.05	0.18	0.13	0.17
4	0.08	0.22	0.18	0.08
5	0.09	0.31	0.30	0.22
Mean	0.066	0.212	0.190	0.130
SE	0.008	0.026	0.036	0.030

#### L.3.2.1 Comparisons with a reference sediment

Analysis of the example data follows the decision tree steps in Figures L-4a and 4b, with numbers in parentheses in the text referring to numbered nodes of the decision trees. The objective of this type of analysis is to determine whether organisms exposed to the dredged material accumulate greater tissue contaminant levels than organisms exposed to the reference. One-sided tests are appropriate because there is little concern if bioaccumulation from dredged material is less than bioaccumulation from the reference. If mean tissue concentrations of contaminants of concern in organisms exposed to dredged material are less than or equal to those of organisms exposed to the reference (*I*), no statistical analysis is required.

The data in Table L-6 were analyzed using SAS program BIOACC (Section L.4.2), and the results are reported in Tables L-7 and L-8. The probability value for Shapiro-Wilk's Test (2) was  $>0.01$  (a level in Table L-2 for  $N = 20$ , balanced data), indicating no significant departure from normality. If the raw data had failed the normality test, then a log transformation (3) would be applied and the Shapiro-Wilk's Test rerun (2). If the log-transformed data still departed significantly from normality, then nonparametric hypothesis testing procedures would be performed (Figure L-4b).

The  $P$ -value for Levene's Test (4) was  $>0.10$  (a level in Table L-2,  $n = 5$ , balanced data), indicating that assumption of equality of variances need not be rejected for the raw data. If the variances had been significantly unequal, a log transformation would have been applied (3) and the tests of assumptions (2,4) rerun. Data that passed the normality test but failed the test for equality of variances would be analyzed using a  $t$ -test for each dredged sediment - reference sediment comparison (5).

<b>Table L-7</b>				
<b>Tests of Assumptions and Parametric Hypothesis Tests on Untransformed and Log<sub>10</sub>-Transformed Bioaccumulation Example Data</b>				
<b>Null Hypothesis: Mean Dredged Material Bioaccumulation Equals Mean Reference Bioaccumulation<sup>1</sup></b>				
<b>Test</b>	<b>Test Statistic</b>	<b>Probability <math>P</math></b>	<b><math>\alpha</math></b>	<b>Conclusion</b>
Normality Assumption: Shapiro-Wilk's Test				
Untransformed data	$W = 0.958$	0.511	0.01	Do not reject
Log-transformed data	$W = 0.980$	0.921	0.01	Do not reject
Equality of Variances Assumption: Levene's Test				
Untransformed data	$F = 2.15$	0.134	0.10	Do not reject
Log-transformed data	$F = 2.19$	0.129	0.10	Do not reject
Null Hypotheses: Sediment 1 = Reference				
LSD Test				
Untransformed data	<u><math>t = 3.76</math></u>	<u>0.0028</u>	<u>0.05</u>	<u>Reject</u>
Log-transformed data	$t = 4.45$	0.0011	0.05	Reject
$t$ -Test (unequal variances)				
Untransformed data	$t = 5.30$	0.0020	0.05	Reject
Log-transformed data	$t = 7.04$	$<0.0001$	0.05	Reject
Sediment 2 = Reference				
LSD Test				
Untransformed data	<u><math>t = 3.20</math></u>	<u>0.0063</u>	<u>0.05</u>	<u>Reject</u>
Log-transformed data	$t = 3.84$	0.0025	0.05	Reject
$t$ -Test (unequal variances)				
Untransformed data	$t = 3.33$	0.0129	0.05	Reject
Log-transformed data	$t = 4.34$	0.0020	0.05	Reject
Sediment 3 = Reference				
LSD Test				
Untransformed data	<u><math>t = 1.65</math></u>	<u>0.0688</u>	<u>0.05</u>	<u>Do not reject</u>
Log-transformed data	$t = 2.20$	0.0295	0.05	reject
$t$ -Test (unequal variances)				
Untransformed data	$t = 2.03$	0.0523	0.05	Do not reject
Log-transformed data	$t = 1.98$	0.0495	0.05	Reject

<sup>1</sup> Based on tests of assumptions, appropriate statistical tests of null hypotheses are underlined. Other test results are included for illustration only.

<b>Table L-8</b>				
<b>Tests of Assumptions and Nonparametric Hypothesis Tests on Bioaccumulation Example Data Converted to Rankits and Ranks</b>				
<b>Null Hypothesis: Median Dredged Material Bioaccumulation Equals Median Reference Bioaccumulation</b>				
<b>Test</b>	<b>Test Statistic</b>	<b>Probability P</b>	<b><math>\alpha</math></b>	<b>Conclusion</b>
<b>Normality Assumption:</b> Shapiro-Wilk's Test (rankits)	$W = 0.972$	0.791	0.01	Do not reject
<b>Equality of Variances Assumption:</b> Levene's Test (rankits)	$F = 0.61$	0.621	0.10	Do not reject
(ranks)	$F = 1.57$	0.236	0.10	Do not reject
<b>Null Hypotheses:</b>				
<b>Sediment 1 = Reference</b>				
LSD Test (rankits)	$t = 3.87$	0.0024	0.05	Reject
$t$ -Test (rankits, unequal variances)	$t = 4.69$	0.0011	0.05	Reject
Conover $T$ -Test	$t = 4.14$	0.0016	0.05	Reject
$t$ -Test (ranks, unequal variances)	$t = 6.18$	0.0003	0.05	Reject
<b>Sediment 2 = Reference</b>				
LSD Test (rankits)	$t = 3.32$	0.0053	0.05	Reject
$t$ -Test (rankits, unequal variances)	$t = 3.76$	0.0040	0.05	Reject
Conover $T$ -Test	$t = 3.54$	0.0038	0.05	Reject
$t$ -Test (ranks, unequal variances)	$t = 3.95$	0.0046	0.05	Reject
<b>Sediment 3 = Reference</b>				
LSD Test (rankits)	$t = 1.66$	0.0677	0.05	Do not reject
$t$ -Test (rankits, unequal variances)	$t = 1.69$	0.0706	0.05	Do not reject
Conover $T$ -Test	$t = 1.86$	0.0497	0.05	Reject
$t$ -Test (ranks, unequal variances)	$t = 1.85$	0.1215	0.05	Do not reject

Because the example data passed both tests of assumptions, the LSD (6) was conducted on the untransformed data to compare bioaccumulation from each dredged sediment with bioaccumulation from the reference. LSD results indicated that mean tissue levels for organisms exposed to dredged sediments 1 and 2 (but not 3) were significantly greater than mean tissue levels for organisms exposed to the reference (Table L-7).

For the sake of illustration, Table L-7 also includes results for log-transformed example data and for  $t$ -tests. Table L-8 gives nonparametric test results for the example data. Note that the different statistical tests give conflicting hypothesis test conclusions for the sediment 3 - reference comparison, because the  $P$ -values of the tests are close to  $\alpha$ . This situation will often arise in the analysis of actual bioaccumulation data. Once again, *it is not acceptable to conduct several different statistical tests in order to choose the results one prefers*. For dredged material evaluations, the decision trees in this Appendix should be followed to determine the appropriate statistical procedures in any given situation. In the case of the example data, the tests of assumptions indicate that the appropriate hypothesis testing procedure is the LSD test using untransformed data, and the results of this test should be accepted. However, in making decisions concerning placement, it is entirely appropriate to consider that the significance of the treatment 3 - reference comparison is marginal. The power of the LSD test (calculated below) should also be taken into consideration.



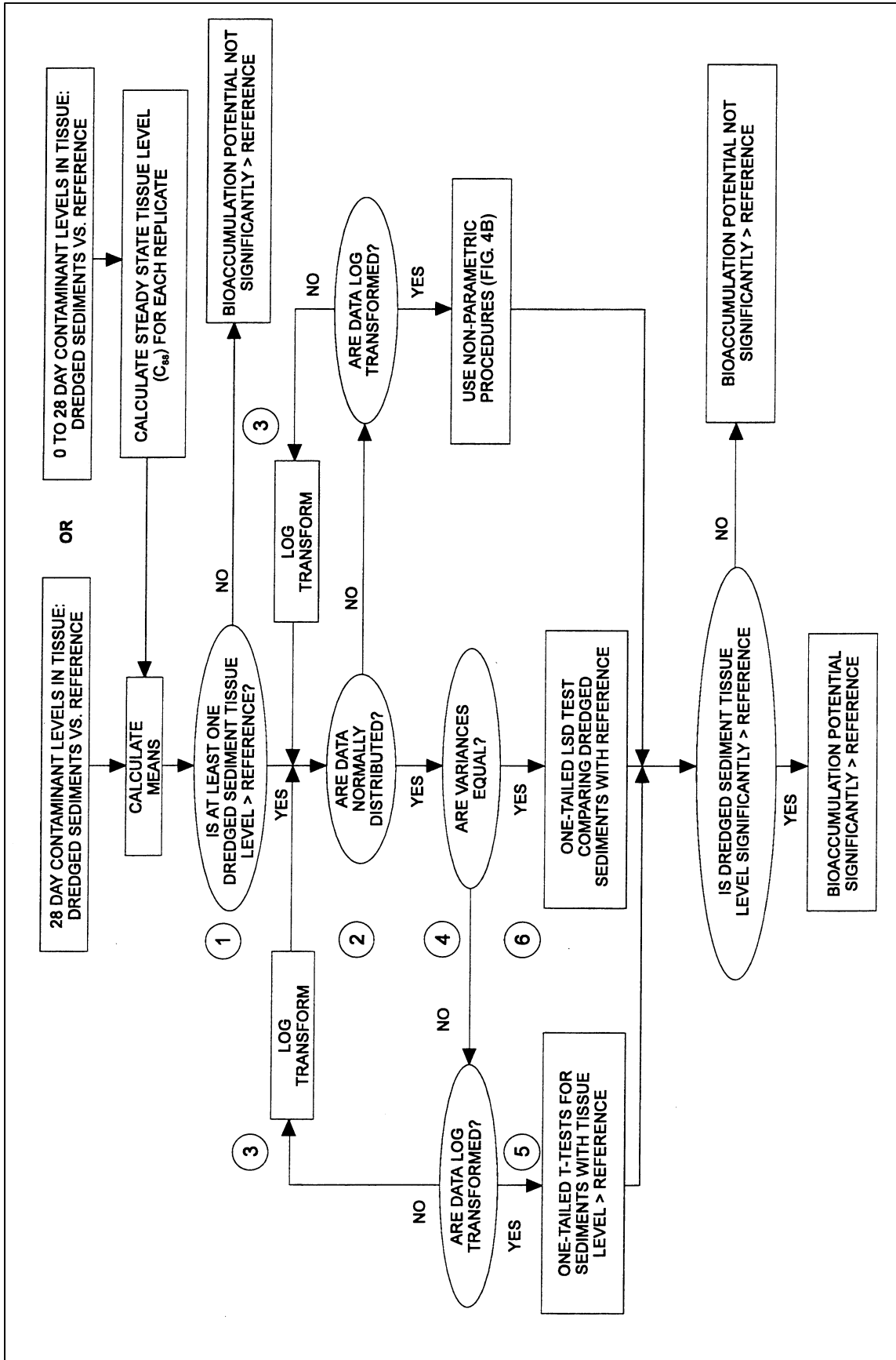

Figure L-4a. Bioaccumulation Test Decision Tree (Parametric Tests)

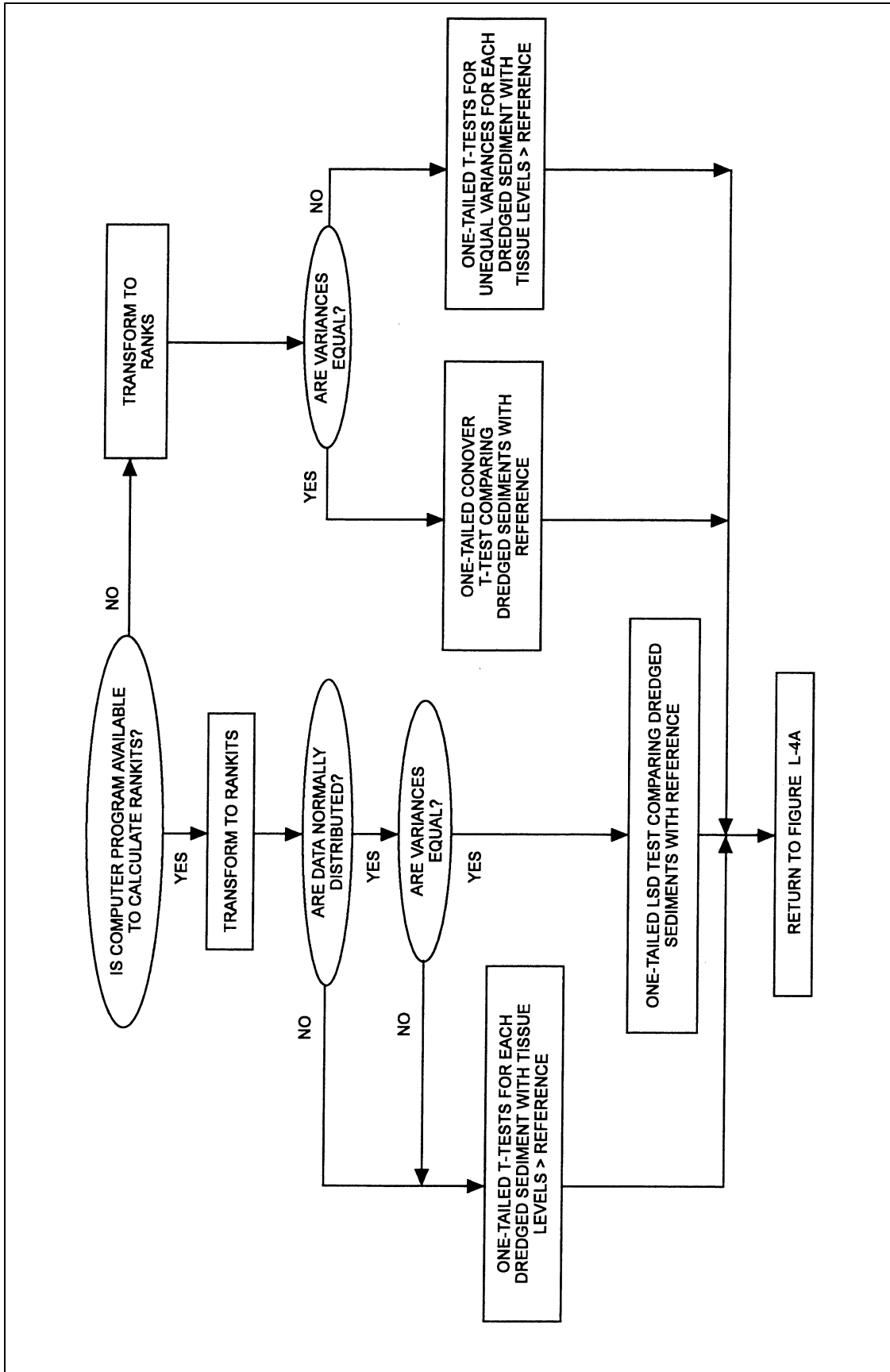

Figure L-4b. Bioaccumulation Test Decision Tree (Nonparametric Tests)

Power calculations for the example data are performed on the untransformed data. From Equation L-11, the minimum significant difference ( $d_{\min}$ , when  $t_{1-\beta} = 0$ ) for the parametric LSD test is:

$$d_{\min} = (t_{1-\alpha, v}) \sqrt{2MSE/n} \quad (\text{L-22})$$

$UCL = 0.190 + 1.746 (0.003763/5)^{1/2} = 0.238 \mu\text{g/g}$ , where  $v = 16$  df. SAS conveniently provides this value as the “Least Significant Difference” in the GLM or ANOVA procedures when the LSD test is requested (and sample sizes are equal).

The power of the LSD test for detecting a 100 percent increase in dredged material bioaccumulation over the mean reference bioaccumulation (i.e.,  $d = 0.066 \mu\text{g/g}$ ) can be determined by:

$$t_{1-\beta, v} = d \sqrt{n/2MSE} - t_{1-\alpha, v} \quad (\text{L-23})$$

$= (0.066) [5/2(0.003763)]^{1/2} - 1.746 = -0.045$ , and  $1 - \beta$  for  $t = -0.045$  with 16 df is 0.48. Power values for 10, 25, 50, 100, 200 and 300 percent increases over mean reference bioaccumulation are given in the output for SAS program BIOACC (Section L.4.2.2).

The sample size ( $n$ ) required to provide a 0.95 probability ( $1 - \beta = 0.95$ ) of detecting a 25 percent increase ( $0.0165 \mu\text{g/g}$ ) over the mean reference bioaccumulation, calculated using the  $z$ -approximation (Eq. 9) with  $MSE$  replacing  $s^2$ , is:

$$n = 2(1.645 + 1.645)^2 [0.003763/(0.0165)^2] + 0.25(1.645)^2 = 300 \quad (\text{L-24})$$

Using the same equation, to detect a 100 percent increase ( $0.066 \mu\text{g/g}$ ) over the mean reference bioaccumulation with a power of 0.95,  $n = 20$ . Assuming we are limited to 5 replicates, there is a 0.95 probability of detecting a difference ( $d$ ) of  $0.135 \mu\text{g/g}$ , which is a 205 percent increase over the mean reference bioaccumulation. Other values of  $d$  when power = 0.5, 0.6, 0.7, 0.8, 0.9, and 0.99 are given in the output for SAS program BIOACC (Section L.4.2.2).

**Less than detection limit data.** Statistical procedures for bioaccumulation data analysis in this Appendix cannot be applied directly in the common situation where some contaminant concentrations are reported only as less than some numerical detection limit (DL). The actual concentrations of these “censored” data (hereafter referred to as nondetects) are unknown and are presumed to fall between zero and the DL. Whenever possible, laboratories that analyze contaminant residues should be encouraged to report observed concentrations below DL (Porter, Ward, and Bell 1988), even though the precision of these measurements is less than that of above DL measurements. When below-DL concentrations (sometimes called “J-values”) are reported, they should be used as legitimate data in statistical comparisons. On the other hand, when bioaccumulation samples include nondetects, the unknown values must be replaced using a censored data method prior to statistical analysis.

A number of methods can be used to permit statistical comparisons of censored data, including simple substitution, uniform distribution substitution, maximum likelihood, and regression methods. Based on the results of a simulation study conducted to identify which of 10 censored data methods work best to maintain power and minimize Type I error rate in LSD comparisons when  $n$  is small, Clarke (1998) recommended the use of nonparametric tests. A constant lower than all reported values, such as zero, one-half DL, or negative DL, is assigned to all nondetects and then the data are converted to rankits or ranks prior to running a  $t$ -test or LSD test, or Dunn's Test may be performed. The power of any test will generally decline as the amount of censoring increases; statistical analysis is not recommended when more than 60 to 80 percent of the data are nondetects. Deletion of nondetects is not recommended as it results in excessive loss of information and power as amount of censoring increases.

### L.3.2.2 Comparison with an action level

In this comparison, the objective is to determine whether the mean bioaccumulation of contaminants in plants or animals exposed to a dredged material is significantly less than a specified action level or standard. If the mean tissue concentration of one or more contaminants of concern is greater than or equal to the applicable action level, then no statistical testing is required. If the mean tissue concentrations of a contaminant of concern are less than the applicable action level, then a confidence-interval approach is used to determine if these means are *significantly* less than the action level. One-sided tests are appropriate since there is concern only if bioaccumulation from the dredged material is not significantly less than the action level. There are two different approaches to conducting these tests, and both are acceptable.

The first approach is to calculate a value of  $t$ , much as in a  $t$ -test (this approach is often called a one-sample  $t$ -test):

$$t = \frac{\bar{x} - \text{action level}}{\sqrt{s^2/n}} \quad (\text{L-25})$$

where  $\bar{x}$ ,  $s^2$ , and  $n$  refer to mean, variance, and number of replicates for contaminant bioaccumulation from the dredged material.

If tests of equality of variances in the comparison of dredged materials with the reference indicate that variances are equal for all treatments, then  $MSE$  from the ANOVA is used as  $s^2$ , and calculated  $t$  is compared to  $t_{0.95}$ , with  $N - k$  degrees of freedom. If the variances are not equal, then  $s^2$  for the individual treatment is used, and calculated  $t$  compared with  $t_{0.95}$ , with  $n - 1$  degrees of freedom. If the data were transformed to normalize the distributions or equalize variances, then all calculations should be carried out on transformed values.

Another approach is to calculate the upper one-sided 95 percent confidence limit ( $UCL$ ), and compare it to the action level:

$$UCL = \bar{x} + (t_{0.95,v})(\sqrt{s^2/n}) \quad (\text{L-26})$$

As in the first approach, the *MSE* is used in place of  $s^2$  if variances are not significantly different, and the degrees of freedom ( $v$ ) are  $N - k$ . If variances are significantly different,  $s^2$  for the individual treatment is used, and  $v$  for each treatment  $i$  is  $n_i - 1$ . There is a 0.95 probability that the true population mean tissue level is below the *UCL*. If the *UCL* is below the action level, there is a  $\geq 0.95$  probability that the population mean tissue level for the dredged material is below the action level, and we conclude that the action level is not exceeded. If the *UCL* is above the action level, we cannot be sure that the mean population tissue level does not exceed the action level.

Either of the above procedures may be used with data that have failed the normality test, but the results should be considered approximate.

The choice of which approach to use depends on the computer software and the presentation method to be used. In SAS, it is more convenient to calculate the *UCL* and compare with the action level, as in program BIOACC (Section L.4.2). In SYSTAT, it is simpler to conduct a one-sample *t*-test. Both approaches can easily be performed by hand. If these data are presented graphically, as in Figure L-5, the confidence-level approach is used. If the investigator wants to provide the exact probability that the mean tissue level is less than the action level, then the one-sample *t*-test is used.

Figure L-5 presents a comparison of mean bioaccumulation from the three dredged sediments (see Table L-6) with a hypothetical action level of 0.2  $\mu\text{g/g}$ . There is no need to calculate the *UCL* for sediment 1 as the mean exceeds the action level. Because variances were not significantly different for the untransformed data (Table L-7), we use  $MSE = 0.003763$  and  $t_{0.95,16} = 1.746$  in Equation L-21 to obtain:

$$UCL = 0.190 + 1.746(0.003763/5)^{1/2} = 0.238 \quad (\text{L-27})$$

for sediment 2, and  $UCL = 0.178$  for sediment 3. SAS program BIOACC (Section L.4.2) calculates *UCL* for both equal and unequal variances.

If the *UCL* lies below the action level, there is a  $>0.95$  probability that the true population mean tissue level for that sediment is less than the action level. Thus, we would conclude that mean bioaccumulation for dredged sediment 3 is less than the action level. Because the *UCL* for sediment 2 exceeds the action level even though the sample mean does not, we cannot be sure that the true population mean tissue level for this sediment is less than the action level.

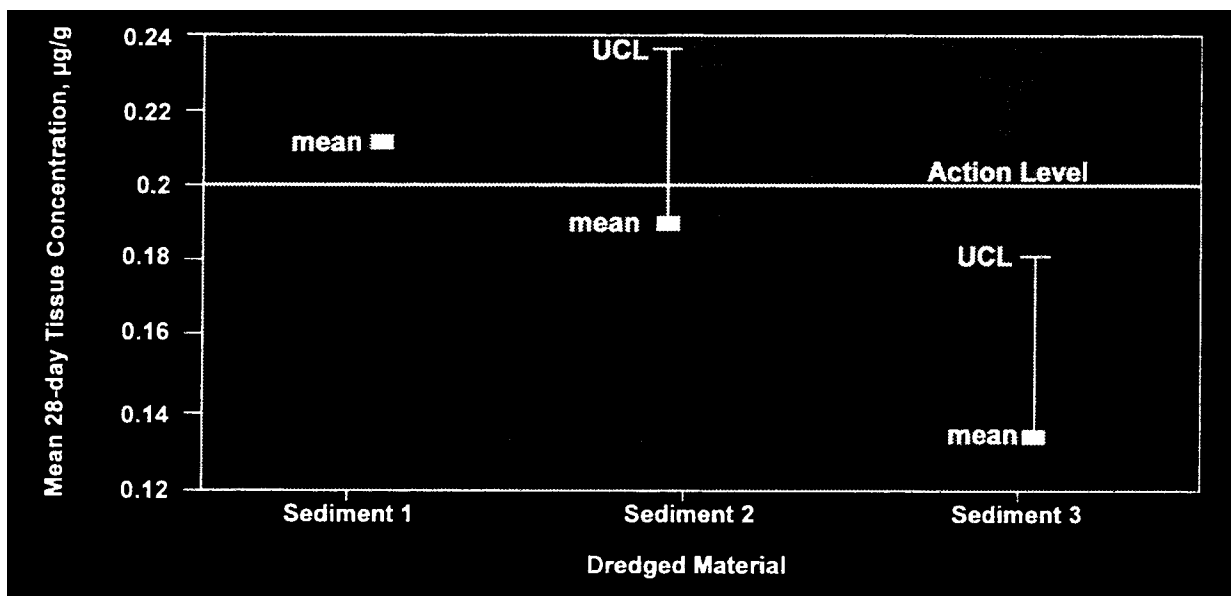

Figure L-5. Comparison of mean dredged material contaminant tissue levels and 95 percent upper confidence level (UCL) with hypothetical action level

Formulae for calculating statistical power for comparisons to a fixed standard such as an action level are very similar to Equations L-8 and L-9:

$$n = (t_{1-a,v} + t_{1-b,v})^2 (s^2/d^2) \quad (\text{L-28})$$

where  $s^2$  and  $v$  (degrees of freedom) are  $MSE$  and  $N - k$  if variances are equal (or expected to be equal, if the calculation is made prior to testing), and  $s^2$  for the individual sediment and  $n_i - 1$  if variances are unequal. It is usually easier to use the  $z$ -approximation (from Alldredge 1987) to avoid solving for  $n$  iteratively:

$$n = (z_{1-a} + z_{1-b})^2 (s^2/d^2) + 0.5(z_{1-a}^2) \quad (\text{L-29})$$

The formulae indicate that the sample size required to detect any given difference  $d$  will be approximately one-half that required for a comparison of two treatments. The sample size required is lower because the comparison is made to a fixed value, rather than to a reference which can also vary. Thus, at least in theory, there is no sampling uncertainty or error for the fixed standard and we know the true value of one of the two things being compared.

Using the  $z$ -approximation and  $s^2 = MSE$ , the sample size required to provide a 0.95 probability ( $1 - \beta = 0.95$ ) of detecting a tissue level 25 percent ( $0.05 \mu\text{g/g}$ ) below the action level is:

$$n = (1.645 + 1.645)^2(0.003763)/0.0025 + 0.5(1.645)^2 = 18 \quad (\text{L-30})$$

The minimum significant difference is:

$$d_{\min} = t_{0.95,16}(MSE/n)^{1/2} = 1.746(0.003763/5)^{1/2} = 0.048 \mu\text{g/g} \quad (\text{L-31})$$

The power of a comparison can be determined by:

$$t_{1-b} = \frac{d\sqrt{n}}{s} - t_{1-a,v} \quad (\text{L-32})$$

When variances are not significantly different,  $s$  is replaced by  $(MSE)^{1/2}$  and  $v = N - k$  df. Using  $MSE = 0.003763$  as above, the power to detect a 10 percent decrease in mean bioaccumulation below the action level is 0.16, and power to detect a 50 percent decrease is 0.96. Power for 10, 20, 30, 40 and 50 percent decreases are given in the output for SAS program BIOACC (Section L.4.2.2).

**Less than detection limit data.** Recommendations for analysis of bioaccumulation data with less than detection limit values were developed to facilitate comparisons of two or more samples. When a sample of contaminant bioaccumulation concentrations must be compared with an action level or standard, accurate estimation of the sample mean and standard deviation is important. In general, this may require different censored data methods than does the comparison of samples in the previous section. Most recommendations for censored data methods in estimation problems have been based on relatively large sample sizes ( $n = 10$  or more). Gleit (1985) identified certain methods that perform better than others for estimating the mean and variance of normal populations based on samples of  $n = 5$ . The best methods, depending on mean, coefficient of variation, and amount of censoring, included substitution of DL, DL/2, or zero, and an iterative method using expected values of order statistics. The latter method (which Gleit recommended), along with several others including regression and some maximum likelihood techniques, are available in UNCENSOR (Newman and Dixon 1990).

Recommendations for censored data methods for estimating mean and standard deviation when  $n$  is small are provided by Clarke and Brandon (1996). If zero is substituted for all nondetects and the sample mean is greater than or equal to the applicable action level, then clearly no statistical testing is required as the mean contaminant concentration cannot be less than the action level.

### L.3.3 Bioaccumulation from field data

A field bioaccumulation test may be designed to show differences, if any, between organisms living at the proposed disposal site and the same species living in the reference area. Tissue concentrations in organisms collected from replicate samples at the disposal site(s) are compared with tissue concentrations in organisms collected from replicate samples at the reference area, using the decision tree steps in Figures L-4A and 4B. If comparisons involve organisms from only one disposal site, then the appropriate statistical comparison procedures, depending on the results of the tests of assumptions, are the two-sample  $t$ -test for equal or unequal variances, or the  $t$ -test for unequal variances using rankits or ranks (Section L.2.1.1.1).

## L.4 SAS Programs and Output for Example Data

This Section provides SAS programs to analyze the example data sets given herein Appendix L. Each program includes all analyses from the corresponding decision tree that would be performed using SAS. While it is certainly possible to conduct the statistical analysis of a data set in a stepwise fashion, we find it much more efficient to perform all analyses at once, and then select the appropriate results based on the steps in the decision tree. Power calculations are provided in addition to the decision tree analyses.

SAS statements in the sections that follow are given in uppercase letters (although this is not required for SAS). Comments within the body of the programs are in upper and lowercase letters in the following format: /\* Comment line. \*/. Every SAS statement must end with a semicolon, but several statements may be included on the same line. The programs are designed for the analysis of Appendix L example data but can be used with other data sets after minor modifications. Investigators wishing to use these programs should have some familiarity with SAS. SAS output follows each program; the output has been edited to remove much of the nonessential information.

We recommend that data analysis reports include at least the following:

- Number of replicates, mean and SE for each treatment.
- Treatment of less-than detection limit data, if any.
- Results of tests of assumptions.
- Data transformation used, if any.
- Name of statistical hypothesis testing procedure, its calculated test statistic and associated probability, and conclusion reached regarding the null hypothesis.
- Minimum significant difference or some other indication of power for a parametric LSD test or  $t$ -test.

### L.4.1 Program WATTOX.SAS for water column toxicity test data analysis

WATTOX.SAS is a program to compare dilution water survival vs. 100 percent elutriate survival, using an arcsine-square root transformation on the data. The program performs all statistical analyses in Figure L-1. Included in these analyses are: mean survival for dilution water and elutriates, Shapiro-Wilk's Test for normality,  $t$ -test for equal or unequal variances, and a  $t$ -test for unequal variances on data converted to rankits. Refer to the decision tree in Figure L-1 to determine which test results should be used. Minimum significant difference and some other power calculations for the parametric  $t$ -test



are also provided. WATTOX.SAS also includes calculation of LC<sub>50</sub> using the Probit procedure.

#### L.4.1.1 WATTOX.SAS program statements

```
LIBNAME Q 'C:\SAS\SASFILES';
OPTIONS LINESIZE=79 PAGESIZE=59 NODATE NONUMBER;

/* Identify the treatment codes. */

PROC FORMAT;
  VALUE TRTFMT
    0='DILUTION WATER '
    1='100 percent ELUTRIATE '
    2='50 percent ELUTRIATE '
    3='25 percent ELUTRIATE '
    4='12.5 percent ELUTRIATE';

/* Input the toxicity test data after the CARDS statement,
listing the */
/* treatment code, replicate, and number of survivors. A
permanent SAS */
/* data set is created in the directory specified in the
LIBNAME statement. */

DATA Q.WATCOL;
  INPUT TRT REP SURV @@;
  CARDS;
0 1 20 0 2 19 0 3 20 0 4 20 0 5 19
1 1 6 1 2 7 1 3 9 1 4 5 1 5 8
2 1 8 2 2 8 2 3 9 2 4 10 2 5 11
3 1 12 3 2 18 3 3 15 3 4 14 3 5 13
4 1 17 4 2 17 4 3 18 4 4 16 4 5 18
;
/* Input no. of organisms (M) per test container at start of
test. */
/* Calculate proportion of survivors (SURV/M) and take the
SQRT. */
/* Arcsine transform SQRT(SURV/M). */
/* Format, print, sort the data. Print no. of observations,
mean, and */
/* standard error for survival in each treatment. */

DATA A0;
  SET Q.WATCOL;
  M=20;
  ARCSURV=ARSIN(SQRT(SURV/M));
  LABEL TRT='TREATMENT GROUP'
        REP='REPLICATE'
        M='NO. OF ORGANISMS PER REPLICATE'
        SURV='NUMBER OF SURVIVORS'
        ARCSURV='ARCSINE TRANSFORMATION';
  FORMAT TRT TRTFMT.;
  TITLE 'WATER COLUMN TOXICITY DATA';
  PROC PRINT LABEL; VAR TRT REP M SURV ARCSURV;
  PROC SORT; BY TRT;
  PROC MEANS NOPRINT; BY TRT; VAR SURV;
  OUTPUT OUT=Y N=N SUM=TOTAL MEAN=MEANSURV STDERR=SE;
  PROC PRINT LABEL; VAR TRT N MEANSURV SE;
  LABEL MEANSURV='MEAN SURVIVAL';
```

```

/* Delete data not needed for the dilution water-100 percent
elutriate comparison. */
/* Print descriptive statistics. */

DATA A;
  SET A0;
  IF TRT>1 THEN DELETE;
  TITLE2 'ARCSINE-SQUARE ROOT TRANSFORMATION';
PROC MEANS NOPRINT; VAR ARCSURV; BY TRT; ID M;
  OUTPUT OUT=X N=N MEAN=MEAN VAR=VARIANCE STD=S STDERR=SE;
PROC PRINT LABEL; VAR TRT N MEAN VARIANCE S SE;

/* Test normality of residuals using Shapiro-Wilk's Test. */

PROC GLM DATA=A NOPRINT;
  CLASS TRT;
  MODEL ARCSURV=TRT;
  OUTPUT OUT=Z R=RESID;
PROC UNIVARIATE NORMAL DATA=Z;
  VAR RESID;
  TITLE3 'SHAPIRO-WILKS TEST';

/* Conduct t-test, which includes F? test for equality of
variances. */

PROC TTEST DATA=A;
  CLASS TRT;
  VAR ARCSURV;

/* Convert data to rankits and conduct t-test. */

PROC RANK DATA=A NORMAL=BLOM OUT=A1;
  VAR SURV; RANKS RANKIT;
PROC TTEST DATA=A1;
  CLASS TRT;
  VAR RANKIT;
  TITLE2 'DATA CONVERTED TO RANKITS';

/* Calculate minimum significant difference and power of a
t-test to detect */
/* true population differences of 10, 20, 30, 40 and 50
percent below mean */
/* dilution water survival. */

DATA B0;
  MERGE X Y;
  IF TRT=0;
  MEAN0=MEAN; N0=N; S20=VARIANCE;
  MEANPCT=MEANSURV/M;
DATA B1;
  SET X;
  IF TRT=1;
  N1=N; S21=VARIANCE;
DATA B2;
  MERGE B0 B1;
  DF=N0+N1-2;
  N=(N0+N1)/2;
  S2POOL=(S20*(N0-1)+S21*(N1-1))/DF;
  TALPHA=TINV(.95,DF);
  DMIN=TALPHA*SQRT(2*S2POOL/N);

```

```

LABEL N='NO. OF REPLICATES'
      MEANPCT='MEAN DILUTION WATER SURVIVAL'
      S2POOL='POOLED VARIANCE'
      DF='DEGREES OF FREEDOM, DF'
      TALPHA='T VALUE FOR (1-ALPHA=0.95,DF)'
      DMIN='MINIMUM SIGNIFICANT DIFFERENCE';
TITLE2 'POWER OF T-TEST TO DETECT A TRUE POPULATION
DIFFERENCE (D)';
TITLE3 'FROM MEAN DILUTION WATER SURVIVAL USING ARCSINE
TRANSFORMATION';
PROC PRINT LABEL NOOBS; VAR M N MEANPCT S2POOL DF TALPHA
DMIN;
DATA B3;
  SET B2;
  DO PCTDIFF=10 TO 50 BY 10;
    SEDSURV=MEANPCT-PCTDIFF/100;
    ARCSURV=ARCSIN(SQRT(SEDSURV));
    ARCDIFF=MEAN0-ARCSURV;
    TBETA=(SQRT(N)*ARCDIFF)/SQRT(2*S2POOL)-TALPHA;
    POWER=PROBT(TBETA,DF);
    OUTPUT;
  END;
LABEL PCTDIFF=' percent REDUCTION IN SURVIVAL FROM DIL.
WATER'
      SEDSURV='100 percent ELUTRIATE SURVIVAL'
      ARCSURV='ARCSINE 100 percent ELUTRIATE SURVIVAL'
      ARCDIFF='D'
      TBETA='T VALUE FOR (1-BETA,DF)';
PROC PRINT LABEL;
  VAR PCTDIFF SEDSURV ARCSURV ARCDIFF TBETA POWER;
  TITLE;

/* Calculate median lethal concentration using the PROBIT
procedure */
/* Define elutriate concentrations */
/* Plot predicted and observed mortalities */

TITLE >WATER COLUMN TOXICITY DATA=;
TITLE2 >PROBIT CALCULATION OF LC50';

DATA C; SET A0;
  MORT=M-SURV;
  SELECT (TRT);
    WHEN (0) CONC=0;
    WHEN (1) CONC=100;
    WHEN (2) CONC=50;
    WHEN (3) CONC=25;
    WHEN (4) CONC=12.5;
  END;
PROC PROBIT LOG;
  MODEL MORT/M=CONC / LACKFIT INVERSECL D=NORMAL;
  OUTPUT OUT=0 P=PROB STD=STD XBETA=XBETA;
  /* Note: other analyses may be requested by changing
D=NORMAL to D=LOGISTIC or */ /* D=GOMPertz in the MODEL
statement above */

DATA C; SET O;
  MORT=MORT/M;

PROC GPLOT;
  PLOT MORT*CONC='X' PROB*CONC='P' / OVERLAY;

```

RUN;

### L4.1.2 WATTOX.SAS Program Output

#### WATER COLUMN TOXICITY DATA

OBS	TREATMENT GROUP	REPLICATE	NO. OF ORGANISMS PER REPLICATE	NUMBER OF SURVIVORS	ARCSINE TRANSFORMATION
1	DILUTION WATER	1	20	20	1.57080
2	DILUTION WATER	2	20	19	1.34528
3	DILUTION WATER	3	20	20	1.57080
4	DILUTION WATER	4	20	20	1.57080
5	DILUTION WATER	5	20	19	1.34528
6	100 % ELUTRIATE	1	20	6	0.57964
7	100 % ELUTRIATE	2	20	7	0.63305
8	100 % ELUTRIATE	3	20	9	0.73531
9	100 % ELUTRIATE	4	20	5	0.52360
10	100 % ELUTRIATE	5	20	8	0.68472
11	50 % ELUTRIATE	1	20	8	0.68472
12	50 % ELUTRIATE	2	20	8	0.68472
13	50 % ELUTRIATE	3	20	9	0.73531
14	50 % ELUTRIATE	4	20	10	0.78540
15	50 % ELUTRIATE	5	20	11	0.83548
16	25 % ELUTRIATE	1	20	12	0.88608
17	25 % ELUTRIATE	2	20	18	1.24905
18	25 % ELUTRIATE	3	20	15	1.04720
19	25 % ELUTRIATE	4	20	14	0.99116
20	25 % ELUTRIATE	5	20	13	0.93774
21	12.5 % ELUTRIATE	1	20	17	1.17310
22	12.5 % ELUTRIATE	2	20	17	1.17310
23	12.5 % ELUTRIATE	3	20	18	1.24905
24	12.5 % ELUTRIATE	4	20	16	1.10715
25	12.5 % ELUTRIATE	5	20	18	1.24905

OBS	TREATMENT GROUP	N	MEAN SURVIVAL	SE
1	DILUTION WATER	5	19.6	0.24495
2	100 % ELUTRIATE	5	7.0	0.70711
3	50 % ELUTRIATE	5	9.2	0.58310
4	25 % ELUTRIATE	5	14.4	1.02956
5	12.5 % ELUTRIATE	5	17.2	0.37417

#### WATER COLUMN TOXICITY DATA ARCSINE-SQUARE ROOT TRANSFORMATION

OBS	TREATMENT GROUP	N	MEAN	VARIANCE	S	SE
1	DILUTION WATER	5	1.48059	0.015257	0.12352	0.055239
2	100 % ELUTRIATE	5	0.63126	0.006986	0.08358	0.037379

WATER COLUMN TOXICITY DATA  
 ARCSINE-SQUARE ROOT TRANSFORMATION  
 SHAPIRO-WILKS TEST

UNIVARIATE PROCEDURE

Variable=RESID

N 10  
 W:Normal 0.846238 Prob<W 0.0507

WATER COLUMN TOXICITY DATA  
 ARCSINE-SQUARE ROOT TRANSFORMATION

TTEST PROCEDURE

Variable: ARCSURV ARCSINE TRANSFORMATION

TRT	N	Mean	Std Dev	Std Error
DILUTION WATER	5	1.48059096	0.12351878	0.05523928
100 % ELUTRIATE	5	0.63126480	0.08358232	0.03737915

Variances	T	DF	Prob> T
Unequal	12.7340	7.0	0.0001
Equal	12.7340	8.0	0.0000

For H0: Variances are equal, F' = 2.18 DF = (4,4) Prob>F' = 0.4679

WATER COLUMN TOXICITY DATA  
 DATA CONVERTED TO RANKITS

TTEST PROCEDURE

Variable: RANKIT RANK FOR VARIABLE SURV

TRT	N	Mean	Std Dev	Std Error
DILUTION WATER	5	0.74011839	0.44830825	0.20048954
100 % ELUTRIATE	5	-0.74011839	0.55672332	0.24897424

Variances	T	DF	Prob> T
Unequal	4.6306	7.7	0.0019
Equal	4.6306	8.0	0.0017

For H0: Variances are equal, F' = 1.54 DF = (4,4) Prob>F' = 0.6850

WATER COLUMN TOXICITY DATA  
 POWER OF T-TEST TO DETECT A TRUE POPULATION DIFFERENCE (D)  
 FROM MEAN DILUTION WATER SURVIVAL USING ARCSINE TRANSFORMATION

NO. OF ORGANISMS PER REPLICATE	N	MEAN DILUTION WATER SURVIVAL	POOLED VARIANCE	DEGREES OF FREEDOM, DF	T VALUE FOR (1-ALPHA=0.95, DF)	MINIMUM SIGNIFICANT DIFFERENCE
20	5	0.98	0.011121	8	1.85955	0.12403

OBS	% REDUCTION IN SURVIVAL FROM DIL. WATER	100 % ELUTRIATE SURVIVAL	ARCSINE 100 % ELUTRIATE SURVIVAL	D	T VALUE FOR (1-BETA, DF)	POWER
1	10	0.88	1.21705	0.26354	2.09166	0.96508
2	20	0.78	1.08259	0.39800	4.10768	0.99830
3	30	0.68	0.96953	0.51106	5.80277	0.99980
4	40	0.58	0.86574	0.61485	7.35888	0.99996
5	50	0.48	0.76539	0.71520	8.86344	0.99999

WATER COLUMN TOXICITY DATA  
 PROBIT CALCULATION OF LC50

Probit Procedure

Model Information

Data Set	WORK.B
Events Variable	MORT
Trials Variable	M
	NO. OF ORGANISMS PER REPLICATE
Number of Observations	20
Number of Events	161
Number of Trials	400
Name of Distribution	NORMAL
Log Likelihood	-234.4058782

Algorithm converged.

Goodness-of-Fit Tests

Statistic	Value	DF	Pr > ChiSq
Pearson Chi-Square	1.7558	2	0.4157
L.R. Chi-Square	1.7503	2	0.4168

Response-Covariate Profile

Response Levels	2
Number of Covariate Values	4

Since the chi-square is small ( $p > 0.1000$ ), fiducial limits will be calculated using a t value of 1.96.

Analysis of Parameter Estimates

Variable	DF	Estimate	Standard Error	Chi-Square	Pr > ChiSq
Intercept	1	-2.89012	0.33780	73.1989	<.0001
Ln(CONC)	1	0.72950	0.09051	64.9663	<.0001

WATER COLUMN TOXICITY DATA  
 PROBIT CALCULATION OF LC50

Probit Procedure

Probit Analysis on Ln(CONC)

Probability	Ln(CONC)	95 % Fiducial Limits	
0.01	0.7728	-0.1770	1.3600
0.02	1.1465	0.3135	1.6639
0.03	1.3836	0.6241	1.8572
0.04	1.5620	0.8575	2.0030
0.05	1.7070	1.0470	2.1218
0.06	1.8305	1.2081	2.2233
0.07	1.9388	1.3491	2.3124
0.08	2.0357	1.4751	2.3924
0.09	2.1239	1.5896	2.4654
0.10	2.2050	1.6947	2.5328
0.15	2.5411	2.1275	2.8142
0.20	2.8081	2.4669	3.0425
0.25	3.0372	2.7526	3.2438
0.30	3.2430	3.0022	3.4316
0.35	3.4336	3.2247	3.6143
0.40	3.6145	3.4255	3.7981
0.45	3.7895	3.6088	3.9869
0.50	3.9618	3.7790	4.1828
0.55	4.1341	3.9410	4.3870
0.60	4.3091	4.0992	4.6008
0.65	4.4900	4.2580	4.8266
0.70	4.6807	4.4217	5.0681
0.75	4.8864	4.5956	5.3316
0.80	5.1155	4.7870	5.6272
0.85	5.3826	5.0080	5.9739
0.90	5.7186	5.2840	6.4122
0.91	5.7997	5.3504	6.5183
0.92	5.8879	5.4224	6.6336
0.93	5.9848	5.5016	6.7606
0.94	6.0931	5.5899	6.9024
0.95	6.2166	5.6904	7.0643
0.96	6.3617	5.8085	7.2547
0.97	6.5400	5.9534	7.4889
0.98	6.7771	6.1458	7.8005
0.99	7.1508	6.4486	8.2920

WATER COLUMN TOXICITY DATA  
PROBIT CALCULATION OF LC50

Probit Procedure

Probit Analysis on CONC

Probability	CONC	95 % Fiducial Limits	
0.01	2.16588	0.83778	3.89622
0.02	3.14719	1.36817	5.27970
0.03	3.98923	1.86664	6.40567
0.04	4.76811	2.35721	7.41100
0.05	5.51255	2.84909	8.34642
0.06	6.23706	3.34701	9.23734
0.07	6.95026	3.85383	10.09863
0.08	7.65778	4.37154	10.93999
0.09	8.36359	4.90156	11.76819
0.10	9.07066	5.44504	12.58822
0.15	12.69305	8.39374	16.68045
0.20	16.57847	11.78589	20.95732
0.25	20.84700	15.68333	25.63096
0.30	25.60925	20.12970	30.92460
0.35	30.98818	25.14636	37.12550
0.40	37.13337	30.73745	44.61613
0.45	44.23644	36.92049	53.88635
0.50	52.55218	43.77361	65.54785
0.55	62.43114	51.46951	80.39802
0.60	74.37329	60.29232	99.56802
0.65	89.12208	70.66773	124.78810
0.70	107.84114	83.24102	158.87767
0.75	132.47618	99.05248	206.76309
0.80	166.58541	119.94013	277.89384
0.85	217.57820	149.60065	393.04744
0.90	304.46875	197.14864	609.23099
0.91	330.20877	210.68655	677.42467
0.92	360.64379	226.42966	760.25126
0.93	397.35639	245.07841	863.13948
0.94	442.79353	267.69998	994.69564
0.95	500.98996	296.02506	1170
0.96	579.20826	333.10952	1415
0.97	692.29671	385.05880	1788
0.98	877.52308	466.75313	2442
0.99	1275	631.81918	3992

#### L.4.2 Program BIOACC.SAS for bioaccumulation test data analysis

BIOACC.SAS is a program to compare bioaccumulation data from dredged materials or other treatments with a reference, using raw data or  $\log_{10}$  transformation. Included in these analyses are: mean bioaccumulation from each exposure, Shapiro-Wilk's Test for normality, Levene's Test for equality of variances,  $t$ -tests for equal or unequal variances, LSD test, and tests on rankits (normalized ranks for contaminant concentration). Refer to the decision tree in Figures L-4A and 4B to determine which test results should be used. The program includes power calculations for an LSD test on untransformed bioaccumulation data.



### L.4.2.1 BIOACC.SAS program statements

```
LIBNAME Q 'C:\SAS\SASFILES';
OPTIONS LINESIZE=79 PAGESIZE=59 NODATE NONUMBER;

/* Identify the treatment codes. */

PROC FORMAT;
  VALUE TRTFMT
    1='REFERENCE '
    2='SEDIMENT 1'
    3='SEDIMENT 2'
    4='SEDIMENT 3';

/* Input the bioaccumulation data after the CARDS statement, listing the */
/* treatment code, replicate, and contaminant concentration. A permanent */
/* SAS data set is created in the directory specified in the LIBNAME */
/* statement. */

DATA Q.BIOACC;
  INPUT TRT REP CONC @@;
  CARDS;
1 1 .06 1 2 .05 1 3 .05 1 4 .08 1 5 .09
2 1 .16 2 2 .19 2 3 .18 2 4 .22 2 5 .31
3 1 .24 3 2 .10 3 3 .13 3 4 .18 3 5 .30
4 1 .13 4 2 .05 4 3 .17 4 4 .08 4 5 .22
;

/* Format, print, sort the data. Print no. of observations, mean, and */
/* standard error for concentration in each treatment for both */
/* untransformed and log10-transformed data. Calculate rankits. */

DATA A0;
  SET Q.BIOACC;
  LOGCONC=LOG10(CONC);
  MERGEVAR=1;
  LABEL TRT='TREATMENT GROUP'
        REP='REPLICATE'
        CONC='CONTAMINANT CONCENTRATION, ug/g'
        LOGCONC='LOG10 CONCENTRATION';
  FORMAT TRT TRTFMT.;
  TITLE 'CONTAMINANT BIOACCUMULATION DATA';
PROC RANK NORMAL=BLOM OUT=A;
  VAR CONC; RANKS RANKIT;
PROC PRINT LABEL; VAR TRT REP CONC LOGCONC RANKIT;
  LABEL RANKIT='NORMALIZED RANK FOR CONCENTRATION';
PROC SORT; BY TRT;
PROC MEANS NOPRINT; BY TRT; VAR CONC LOGCONC; ID MERGEVAR;
  OUTPUT OUT=Y N=N NLOG MEAN=MEANCONC MEANLOG VAR=S2 S2LOG STDERR=SE SELOG;
PROC PRINT LABEL; VAR TRT N MEANCONC S2 SE MEANLOG S2LOG SELOG;
  LABEL MEANCONC='MEAN CONTAMINANT CONC.'
        S2='VARIANCE'
        SE='STANDARD ERROR'
        MEANLOG='MEAN LOG10 CONC.'
        S2LOG='VARIANCE OF LOGS'
        SELOG='STANDARD ERROR OF LOGS';

/* Test normality of residuals of untransformed and log-transformed data */
/* using Shapiro-Wilk's Test. */
```

```

PROC GLM NOPRINT DATA=A;
  CLASS TRT;
  MODEL CONC LOGCONC=TRT;
  OUTPUT OUT=Z R=RESID RESIDLOG;
PROC UNIVARIATE NORMAL;
  VAR RESID RESIDLOG;
  TITLE2 'SHAPIRO-WILKS TEST FOR NORMALITY';

/* Conduct Levene's Test for equality of variances of untransformed and */
/* log-transformed data. */
DATA AY;
  MERGE A Y; BY TRT;
  ABSDEV=ABS(CONC-MEANCONC);
  ABSLOG=ABS(LOGCONC-MEANLOG);
  LABEL    ABSDEV='ABSOLUTE DEVIATIONS FROM MEAN CONC.'
  ABSLOG='ABSOLUTE DEVIATIONS FROM MEAN LOGCONC.';
PROC GLM;
  CLASS TRT;
  MODEL ABSDEV ABSLOG=TRT;
  TITLE2 'LEVENE'S TEST';

/* Perform LSD on untransformed and log-transformed data. */

PROC GLM DATA=A OUTSTAT=W1;
  CLASS TRT;
  MODEL CONC=TRT;
  MEANS TRT/LSD ALPHA=.1;
  TITLE2 'LSD TEST (UNTRANSFORMED DATA)';
PROC GLM DATA=A OUTSTAT=W2;
  CLASS TRT;
  MODEL LOGCONC=TRT;
  MEANS TRT/LSD ALPHA=.1;
  TITLE2 'LSD TEST (LOG-TRANSFORMED DATA)';

/* Perform t-tests for each dredged sediment-reference sediment comparison */
/* using untransformed and log-transformed data. */

DATA T1;
  SET A;
  IF TRT>2 THEN DELETE;
PROC TTEST;
  CLASS TRT;
  VAR CONC LOGCONC;
DATA T2;
  SET A;
  IF TRT=2 OR TRT=4 THEN DELETE;
PROC TTEST;
  CLASS TRT;
  VAR CONC LOGCONC;
DATA T3;
  SET A;
  IF TRT=2 OR TRT=3 THEN DELETE;
PROC TTEST;
  CLASS TRT;
  VAR CONC LOGCONC;

/* Test normality and equality of variances of rankits. */

PROC GLM NOPRINT DATA=A;
  CLASS TRT;
  MODEL RANKIT=TRT;

```

```

OUTPUT OUT=Z2 R=RESID;
TITLE2 'BIOACCUMULATION DATA CONVERTED TO RANKITS';
PROC UNIVARIATE NORMAL;
VAR RESID;
TITLE3 'SHAPIRO-WILKS TEST FOR NORMALITY';
PROC MEANS DATA=A NOPRINT;
BY TRT; VAR RANKIT;
OUTPUT OUT=X MEAN=MEAN;
DATA AX;
MERGE A X; BY TRT;
ABSDEV=ABS(RANKIT-MEAN);
PROC GLM;
CLASS TRT;
MODEL ABSDEV=TRT;
TITLE3 'LEVENE'S TEST';

/* Perform LSD on rankits. */

PROC GLM DATA=A;
CLASS TRT;
MODEL RANKIT=TRT;
MEANS TRT/LSD ALPHA=.1;
TITLE3 'LSD TEST';

/* Perform t-tests for each dredged sediment-reference sediment comparison */
/* using rankits. */

PROC TTEST DATA=T1;
CLASS TRT;
VAR RANKIT;
PROC TTEST DATA=T2;
CLASS TRT;
VAR RANKIT;
PROC TTEST DATA=T3;
CLASS TRT;
VAR RANKIT;

/* Calculate power of an LSD test to detect true population differences */
/* 10, 25, 50, and 100 % above the reference mean contaminant concentration. */
DATA C1;
SET W1;
IF _TYPE_ ^= 'ERROR' THEN DELETE;
MSE=SS/DF;
MERGEVAR=1;
KEEP MSE DF MERGEVAR;
DATA C2;
SET Y;
IF TRT ^= 1 THEN DELETE;
DATA C3;
MERGE C1 C2;
TALPHA=TINV(.95,DF);
LABEL N='NO. OF REPLICATES, N'
MEANCONC='REFERENCE MEAN CONTAMINANT CONCENTRATION'
MSE='MEAN SQUARE ERROR, MSE'
DF='DEGREES OF FREEDOM, DF'
TALPHA='T VALUE FOR (1-ALPHA=0.95,DF)';
TITLE2 'POWER OF LSD TO DETECT A TRUE POPULATION DIFFERENCE (D)';
TITLE3 'ABOVE REFERENCE MEAN CONTAMINANT CONCENTRATION';
PROC PRINT LABEL NOOBS; VAR N MEANCONC MSE DF TALPHA;
DATA C4;

```

```

SET C3;
DO PCTDIFF=10,25,50,100,200,300;
  SEDCONC=MEANCONC+((PCTDIFF/100)*MEANCONC);
  D=SEDCONC-MEANCONC;
  TBETA=D*SQRT(N/(2*MSE))-TALPHA;
  POWER=PROBT(TBETA,DF);
  OUTPUT;
  END;
LABEL PCTDIFF=' % INCREASE IN CONC. ABOVE REFERENCE'
SEDCONC='DREDGED SEDIMENT BIOACCUMULATION'
TBETA='T VALUE FOR (1-BETA,DF)'
POWER='POWER (1-BETA)';
PROC PRINT LABEL NOOBS; VAR PCTDIFF SEDCONC D TBETA POWER;
  TITLE 'POWER OF LSD TO DETECT % INCREASE IN CONCENTRATION ABOVE REFERENCE';
  TITLE2 'MEAN CONTAMINANT CONCENTRATION GIVEN N, MSE AND DF SHOWN ABOVE';
DATA C5;
SET C3;
DO POWER=.5,.6,.7,.8,.9,.95,.99;
  TBETA=TINV(POWER,DF);
  D=((TBETA+TALPHA)*SQRT(2*MSE))/SQRT(N);
  SEDCONC=MEANCONC+D;
  PCTDIFF=(D*100)/MEANCONC;
  OUTPUT;
  END;
LABEL SEDCONC='DREDGED SEDIMENT BIOACCUMULATION'
PCTDIFF=' % INCREASE IN CONC. ABOVE REFERENCE'
TBETA='T VALUE FOR (1-BETA,DF)'
POWER='POWER (1-BETA)';
PROC PRINT LABEL NOOBS; VAR POWER D SEDCONC PCTDIFF TBETA;
  TITLE 'MINIMUM DREDGED SEDIMENT BIOACCUMULATION THAT CAN BE DETECTED BY LSD';
  TITLE2 'AS SIGNIFICANT GIVEN SPECIFIED POWER AND N, MSE, AND DF SHOWN ABOVE';

/* Calculation of upper confidence limits (UCL) for comparison of mean */
/* dredged sediment bioaccumulation with an action level. */

DATA D;
MERGE C1 Y; BY MERGEVAR;
IF TRT=1 THEN DELETE;
TALPHA1=TINV(.95,DF);
TALPHA2=TINV(.95,N-1);
UCL1=MEANCONC+TALPHA1*(SQRT(MSE/N));
UCL2=MEANCONC+TALPHA2*(SQRT(S2/N));
DMIN1=TALPHA1*SQRT(MSE/N);
DMIN2=TALPHA2*SQRT(S2/N);
LABEL UCL1='UCL (EQUAL VARIANCES)'
  UCL2='UCL (UNEQUAL VARIANCES)'
  TALPHA1='T VALUE FOR (1-ALPHA=.95,DF)'
  TALPHA2='T VALUE FOR (1-ALPHA=.95,N-1)'
  DMIN1='MINIMUM SIGNIFICANT DIFFERENCE'
  DMIN2='MINIMUM SIGNIFICANT DIFFERENCE'
  MSE='MEAN SQUARE ERROR'
  S2='VARIANCE'
  MEANCONC='MEAN BIOACCUMULATION';
  TITLE 'COMPARISON OF MEAN DREDGED SEDIMENT BIOACCUMULATION WITH ACTION
LEVEL: ';
PROC PRINT LABEL NOOBS; VAR TRT MEANCONC UCL1 MSE TALPHA1 DF DMIN1;
  TITLE2 'UPPER CONFIDENCE LIMITS (UCL) WHEN VARIANCES ARE EQUAL';
PROC PRINT LABEL NOOBS; VAR TRT MEANCONC UCL2 S2 TALPHA2 N DMIN2;
  TITLE2 'UPPER CONFIDENCE LIMITS (UCL) WHEN VARIANCES ARE UNEQUAL';

/* Calculate power of dredged sediment-action level comparisons using */

```

```
/* MSE given 10, 20, 30, 40, and 50 % decreases in mean concentration */
/* below action level. */
```

```
DATA D1;
SET C3;
ACTION=.2;
DO PCTDIFF=10 TO 50 BY 10;
D=PCTDIFF*ACTION/100;
SEDCONC=ACTION-D;
TBETA=D*SQRT(N/MSE)-TALPHA;
POWER=PROBT(TBETA,DF);
OUTPUT;
END;
LABEL PCTDIFF=' % DECREASE BELOW ACTION LEVEL'
SEDCONC='MEAN DREDGED SEDIMENT BIOACCUMULATION'
TBETA='T VALUE FOR (1-BETA,DF)'
POWER='POWER (1-BETA)';
PROC PRINT NOOBS LABEL; VAR PCTDIFF SEDCONC D TBETA POWER;
TITLE 'POWER TO DETECT % DECREASE IN CONCENTRATION BELOW';
TITLE2 'ACTION LEVEL OF 0.2 ug/g GIVEN N, MSE AND DF SHOWN ABOVE';

RUN;
```

#### L.4.2.2 BIOACC.SAS program output

##### CONTAMINANT BIOACCUMULATION DATA

OBS	TREATMENT GROUP	REPLICATE	CONTAMINANT CONCENTRATION, ug/g	LOG10 CONCENTRATION	NORMALIZED RANK FOR CONCENTRATION
1	REFERENCE	1	0.06	-1.22185	-0.91914
2	REFERENCE	2	0.05	-1.30103	-1.46660
3	REFERENCE	3	0.05	-1.30103	-1.46660
4	REFERENCE	4	0.08	-1.09691	-0.66680
5	REFERENCE	5	0.09	-1.04576	-0.44777
6	SEDIMENT 1	1	0.16	-0.79588	0.06193
7	SEDIMENT 1	2	0.19	-0.72125	0.58946
8	SEDIMENT 1	3	0.18	-0.74473	0.38117
9	SEDIMENT 1	4	0.22	-0.65758	0.83164
10	SEDIMENT 1	5	0.31	-0.50864	1.86824
11	SEDIMENT 2	1	0.24	-0.61979	1.12814
12	SEDIMENT 2	2	0.10	-1.00000	-0.31457
13	SEDIMENT 2	3	0.13	-0.88606	-0.12434
14	SEDIMENT 2	4	0.18	-0.74473	0.38117
15	SEDIMENT 2	5	0.30	-0.52288	1.40341
16	SEDIMENT 3	1	0.13	-0.88606	-0.12434
17	SEDIMENT 3	2	0.05	-1.30103	-1.46660
18	SEDIMENT 3	3	0.17	-0.76955	0.18676
19	SEDIMENT 3	4	0.08	-1.09691	-0.66680
20	SEDIMENT 3	5	0.22	-0.65758	0.83164

##### CONTAMINANT BIOACCUMULATION DATA

OBS	TREATMENT GROUP	N	MEAN CONTAMINANT CONC.	STANDARD VARIANCE	MEAN LOG10 CONC.	VARIANCE OF LOGS	STANDARD ERROR OF LOGS
1	REFERENCE	5	0.066	.00033	0.008124	-1.19332	0.013772
2	SEDIMENT 1	5	0.212	.00347	0.026344	-0.68561	0.012257

3	SEDIMENT 2 5	0.190	.00660	0.036332	-0.75469	0.037367	0.08645
4	SEDIMENT 3 5	0.130	.00465	0.030496	-0.94223	0.066666	0.11547

CONTAMINANT BIOACCUMULATION DATA  
SHAPIRO-WILKS TEST FOR NORMALITY

UNIVARIATE PROCEDURE

Variable=RESID

N	20
W:Normal	0.957973 Prob<W 0.5111

Variable=RESIDLOG

N	20
W:Normal	0.980207 Prob<W 0.9208

CONTAMINANT BIOACCUMULATION DATA  
LEVENE'S TEST

General Linear Models Procedure

Source	DF	Sum of Squares	Mean Square	F Value	Pr > F
Model	3	0.00647280	0.00215760	2.15	0.1339
Error	16	0.01605600	0.00100350		
Corrected Total	19	0.02252880			

Source	DF	Sum of Squares	Mean Square	F Value	Pr > F
Model	3	0.04702396	0.01567465	2.19	0.1291
Error	16	0.11456390	0.00716024		
Corrected Total	19	0.16158786			

CONTAMINANT BIOACCUMULATION DATA  
LSD TEST (UNTRANSFORMED DATA)

General Linear Models Procedure

T tests (LSD) for variable: CONC

NOTE: This test controls the type I comparisonwise error rate not the experimentwise error rate.

Alpha= 0.1 df= 16 MSE= 0.003763  
Critical Value of T= 1.75  
Least Significant Difference= 0.0677

Means with the same letter are not significantly different.

T Grouping	Mean	N	TRT
A	0.2120	5	SEDIMENT 1

	A			
B	A	0.1900	5	SEDIMENT 2
B				
B	C	0.1300	5	SEDIMENT 3
	C			
	C	0.0660	5	REFERENCE

LSD TEST (LOG-TRANSFORMED DATA)  
Alpha= 0.1 df= 16 MSE= 0.032515  
Critical Value of T= 1.75  
Least Significant Difference= 0.1991

Means with the same letter are not significantly different.

T	Grouping	Mean	N	TRT
	A	-0.686	5	SEDIMENT 1
	A			
B	A	-0.755	5	SEDIMENT 2
B				
B		-0.942	5	SEDIMENT 3
	C	-1.193	5	REFERENCE

CONTAMINANT BIOACCUMULATION DATA

TTEST PROCEDURE

Variable: CONC CONTAMINANT CONCENTRATION, ug/g

TRT	N	Mean	Std Dev	Std Error
REFERENCE	5	0.06600000	0.01816590	0.00812404
SEDIMENT 1	5	0.21200000	0.05890671	0.02634388
-----				
Variances	T	DF	Prob> T	
Unequal	-5.2960	4.8	0.0039	
Equal	-5.2960	8.0	0.0007	

For H0: Variances are equal, F' = 10.52 DF = (4,4) Prob>F' = 0.0426

Variable: LOGCONC LOG10 CONCENTRATION

TRT	N	Mean	Std Dev	Std Error
REFERENCE	5	-1.19331525	0.11735241	0.05248159
SEDIMENT 1	5	-0.68561391	0.11071260	0.04951218
-----				
Variances	T	DF	Prob> T	
Unequal	-7.0366	8.0	0.0001	
Equal	-7.0366	8.0	0.0001	

For H0: Variances are equal, F' = 1.12 DF = (4,4) Prob>F' = 0.9128

CONTAMINANT BIOACCUMULATION DATA

TTEST PROCEDURE

Variable: CONC CONTAMINANT CONCENTRATION, ug/g

TRT	N	Mean	Std Dev	Std Error
REFERENCE	5	0.06600000	0.01816590	0.00812404
SEDIMENT 2	5	0.19000000	0.08124038	0.03633180

Variances	T	DF	Prob> T
Unequal	-3.3307	4.4	0.0258
Equal	-3.3307	8.0	0.0104

For H0: Variances are equal, F' = 20.00 DF = (4,4) Prob>F' = 0.0132

Variable: LOGCONC LOG10 CONCENTRATION

TRT	N	Mean	Std Dev	Std Error
REFERENCE	5	-1.19331525	0.11735241	0.05248159
SEDIMENT 2	5	-0.75469033	0.19330562	0.08644890

Variances	T	DF	Prob> T
Unequal	-4.3371	6.6	0.0040
Equal	-4.3371	8.0	0.0025

For H0: Variances are equal, F' = 2.71 DF = (4,4) Prob>F' = 0.3570

CONTAMINANT BIOACCUMULATION DATA

TTEST PROCEDURE

Variable: CONC CONTAMINANT CONCENTRATION, ug/g

TRT	N	Mean	Std Dev	Std Error
REFERENCE	5	0.06600000	0.01816590	0.00812404
SEDIMENT 3	5	0.13000000	0.06819091	0.03049590

Variances	T	DF	Prob> T
Unequal	-2.0279	4.6	0.1045
Equal	-2.0279	8.0	0.0771

For H0: Variances are equal, F' = 14.09 DF = (4,4) Prob>F' = 0.0252

Variable: LOGCONC LOG10 CONCENTRATION

TRT	N	Mean	Std Dev	Std Error
REFERENCE	5	-1.19331525	0.11735241	0.05248159
SEDIMENT 3	5	-0.94222501	0.25819757	0.11546947

Variances	T	DF	Prob> T
Unequal	-2.0279	4.6	0.1045
Equal	-2.0279	8.0	0.0771



Unequal     -1.9796     5.6     0.0990  
 Equal       -1.9796     8.0     0.0831

For H0: Variances are equal, F' = 4.84     DF = (4,4)     Prob>F' = 0.1558

CONTAMINANT BIOACCUMULATION DATA  
 BIOACCUMULATION DATA CONVERTED TO RANKITS  
 SHAPIRO-WILKS TEST FOR NORMALITY

UNIVARIATE PROCEDURE

Variable=RESID

N                                 20  
 W:Normal     0.972308     Prob<W                 0.7907

CONTAMINANT BIOACCUMULATION DATA  
 BIOACCUMULATION DATA CONVERTED TO RANKITS  
 LEVENE'S TEST

General Linear Models Procedure

Dependent Variable: ABSDEV

Source	DF	Sum of Squares	Mean Square	F Value	Pr > F
Model	3	0.24147324	0.08049108	0.61	0.6212
Error	16	2.12865866	0.13304117		
Corrected Total	19	2.37013190			

CONTAMINANT BIOACCUMULATION DATA  
 BIOACCUMULATION DATA CONVERTED TO RANKITS  
 LSD TEST

General Linear Models Procedure

T tests (LSD) for variable: RANKIT

NOTE:This test controls the type I comparisonwise error rate not the experimentwise error rate.

Alpha= 0.1     df= 16     MSE= 0.503649  
 Critical Value of T= 1.75  
 Least Significant Difference= 0.7836

Means with the same letter are not significantly different.

T Grouping	Mean	N	TRT
A	0.746	5	SEDIMENT 1
A			
B	0.495	5	SEDIMENT 2
B			
B	-0.248	5	SEDIMENT 3
C			
C	-0.993	5	REFERENCE

CONTAMINANT BIOACCUMULATION DATA  
BIOACCUMULATION DATA CONVERTED TO RANKITS

TTEST PROCEDURE

Variable: RANKIT                      RANK FOR VARIABLE CONC

TRT	N	Mean	Std Dev	Std Error
REFERENCE	5	-0.99338019	0.46306944	0.20709095
SEDIMENT 1	5	0.74648762	0.68780736	0.30759680

Variances	T	DF	Prob> T
Unequal	-4.6920	7.0	0.0022
Equal	-4.6920	8.0	0.0016

For H0: Variances are equal, F' = 2.21      DF = (4,4)      Prob>F' = 0.4623

CONTAMINANT BIOACCUMULATION DATA  
BIOACCUMULATION DATA CONVERTED TO RANKITS

TTEST PROCEDURE

Variable: RANKIT                      RANK FOR VARIABLE CONC

TRT	N	Mean	Std Dev	Std Error
REFERENCE	5	-0.99338019	0.46306944	0.20709095
SEDIMENT 2	5	0.49476200	0.75465812	0.33749337

Variances	T	DF	Prob> T
Unequal	-3.7583	6.6	0.0079
Equal	-3.7583	8.0	0.0056

For H0: Variances are equal, F' = 2.66      DF = (4,4)      Prob>F' = 0.3671

CONTAMINANT BIOACCUMULATION DATA  
BIOACCUMULATION DATA CONVERTED TO RANKITS

TTEST PROCEDURE

Variable: RANKIT                      RANK FOR VARIABLE CONC

TRT	N	Mean	Std Dev	Std Error
REFERENCE	5	-0.99338019	0.46306944	0.20709095
SEDIMENT 3	5	-0.24786944	0.87038805	0.38924937

Variances	T	DF	Prob> T
Unequal	-1.6908	6.1	0.1411
Equal	-1.6908	8.0	0.1293

For H0: Variances are equal, F' = 3.53      DF = (4,4)      Prob>F' = 0.2491

CONTAMINANT BIOACCUMULATION DATA  
 POWER OF LSD TO DETECT A TRUE POPULATION DIFFERENCE (D)  
 ABOVE REFERENCE MEAN CONTAMINANT CONCENTRATION

NO. OF REPLICATES, N	REFERENCE MEAN CONTAMINANT CONCENTRATION	MEAN SQUARE ERROR, MSE	DEGREES OF FREEDOM, DF	T VALUE FOR (1-ALPHA=0.95,DF)
5	0.066	.0037625	16	1.74588

POWER OF LSD TO DETECT % INCREASE IN CONCENTRATION ABOVE REFERENCE  
 MEAN CONTAMINANT CONCENTRATION GIVEN N, MSE AND DF SHOWN ABOVE

% INCREASE IN CONC. ABOVE REFERENCE	DREDGED SEDIMENT BIOACCUMULATION	D	T VALUE FOR (1-BETA,DF)	POWER (1-BETA)
10	0.0726	0.0066	-1.57576	0.06732
25	0.0825	0.0165	-1.32056	0.10261
50	0.0990	0.0330	-0.89524	0.19196
100	0.1320	0.0660	-0.04460	0.48249
200	0.1980	0.1320	1.65668	0.94147
300	0.2640	0.1980	3.35796	0.99800

MINIMUM DREDGED SEDIMENT BIOACCUMULATION THAT CAN BE DETECTED BY LSD  
 AS SIGNIFICANT GIVEN SPECIFIED POWER AND N, MSE, AND DF SHOWN ABOVE

POWER (1-BETA)	D	DREDGED SEDIMENT BIOACCUMULATION	% INCREASE IN CONC. ABOVE REFERENCE	T VALUE FOR (1-BETA,DF)
0.50	0.06773	0.13373	102.622	0.00000
0.60	0.07772	0.14372	117.763	0.25760
0.70	0.08849	0.15449	134.069	0.53501
0.80	0.10127	0.16727	153.446	0.86467
0.90	0.11959	0.18559	181.195	1.33676
0.95	0.13546	0.20146	205.244	1.74588
0.99	0.16796	0.23396	254.477	2.58349

COMPARISON OF MEAN DREDGED SEDIMENT BIOACCUMULATION WITH ACTION LEVEL:  
 UPPER CONFIDENCE LIMITS (UCL) WHEN VARIANCES ARE EQUAL

TREATMENT GROUP	MEAN BIOACCUMULATION	UCL EQUAL VARIANCES)	MEAN SQUARE ERROR	T VALUE FOR (1-ALPHA=.95,DF)	MINIMUM SIGNIFICANT DIFFERENCE
SEDIMENT 1	0.212	0.25989	.0037625	1.74588	0.047893
SEDIMENT 2	0.190	0.23789	.0037625	1.74588	0.047893
SEDIMENT 3	0.130	0.17789	.0037625	1.74588	0.047893

COMPARISON OF MEAN DREDGED SEDIMENT BIOACCUMULATION WITH ACTION LEVEL:  
UPPER CONFIDENCE LIMITS (UCL) WHEN VARIANCES ARE UNEQUAL

TREATMENT GROUP	MEAN BIOACCUMULATION	UCL (UNEQUAL VARIANCES)	VARIANCE	T VALUE FOR (1-ALPHA=.95,N-1)	N	MINIMUM SIGNIFICANT DIFFERENCE
SEDIMENT 1	0.212	0.26816	.00347	2.13185	5	0.056161
SEDIMENT 2	0.190	0.26745	.00660	2.13185	5	0.077454
SEDIMENT 3	0.130	0.19501	.00465	2.13185	5	0.065013

POWER TO DETECT % DECREASE IN CONCENTRATION BELOW ACTION LEVEL OF 0.2 ug/g GIVEN N, MSE AND DF SHOWN ABOVE

% DECREASE BELOW ACTION LEVEL	MEAN DREDGED SEDIMENT BIOACCUMULATION	D	T VALUE FOR (1-BETA,DF)	POWER (1-BETA)
10	0.18	0.02	-1.01680	0.16219
20	0.16	0.04	-0.28772	0.38863
30	0.14	0.06	0.44136	0.66757
40	0.12	0.08	1.17045	0.87052
50	0.10	0.10	1.89953	0.96216

## L.5 References

- Allredge, J. R. (1987). "Sample size for monitoring of toxic chemical sites," *Environ. Monit. Assess.* 9, 143-154.
- Capizzi, T., Oppenheimer, L., Mehta, H., Naimie, H., and Fair, J. L. (1985). "Statistical considerations in the evaluation of chronic aquatic toxicity studies," *Environ. Sci. Technol.* 19, 35-43.
- Clarke, J. U. (1998). "Evaluation of censored data methods to allow statistical comparisons among very small samples with below detection limit observations," *Environ. Sci. Technol.* 32(1), 177-183.
- Clarke, J. U., and Brandon, D. L. (1996). "Applications guide for statistical analyses in dredged sediment evaluations," Miscellaneous Paper D-96-2, U.S. Army Engineer Waterways Experiment Station, Vicksburg, MS.
- Conover, W. J. (1980). *Practical nonparametric statistics*. 2nd ed. Wiley, New York, 493.
- Conover, W. J., Johnson, M. E., and Johnson, M. M. (1981). "A comparative study of tests for homogeneity of variances, with applications to the outer continental shelf bidding data," *Technometrics* 23, 351-361.
- Dixon, W. J., and Massey, Jr., F. J. (1983). *Introduction to statistical analysis*. 4th ed., McGraw-Hill, New York, 678.

- Dunnett, C. W. (1955). "Multiple comparison procedure for comparing several treatments with a control," *J. Amer. Statist. Assoc.* 50, 1096-1121.
- Gelber, R. D., Lavin, P. T., Mehta, C. R., and Schoenfeld, D. A. (1985). "Chapter 5: Statistical analysis." *Fundamentals of Aquatic Toxicology: Methods and Applications*. G. M. Rand and S. R. Petrocelli, eds., Hemisphere Publishing Corp., Washington, DC, 110-123.
- Gill, J. L. (1978). *Design and Analysis of Experiments in the Animal and Medical Sciences. Vol. 3. Appendices*. The Iowa State University Press, Ames, IA. 173.
- Gleit, A. (1985). "Estimation for small normal data sets with detection limits," *Environ. Sci. Technol.* 19, 1201-1206.
- Hamilton, M. A., Russo, R. C., and Thurston, R. V. (1977). "Trimmed Spearman-Kärber method for estimating median lethal concentrations in toxicity bioassays," *Environ. Sci. Technol.* 11, 714-719.
- Hochberg, Y. and Tamhane, A. C. (1987). *Multiple comparison procedures*. Wiley, New York, 450.
- Hurlbert, S. H. (1984). "Pseudoreplication and the design of ecological field experiments," *Ecol. Monogr.* 54, 187-211.
- Kleinbaum, D. G., and Kupper, L. L. (1978). *Applied regression analysis and other multivariable methods*. Duxbury Press, North Scituate, MA, 556.
- Lilliefors, H. W. (1967). "On the Kolmogorov-Smirnov test for normality with mean and variance unknown," *J. Amer. Statist. Assoc.* 62, 399-402.
- McClave, J. T., and Dietrich, II, F. H. (1979). *Statistics*. Dellen Publishing Company, San Francisco, CA. 681.
- Moore, D. R. J., and Caux, P.-Y. (1997). "Estimating low toxic effects," *Environ. Toxicol. Chem.* 16(4), 794-801.
- Newman, M. C., and Dixon, P. M. (1990). "UNCENSOR: A program to estimate means and standard deviations for data sets with below detection limit observations," *Amer. Environ. Lab.*, 26-30.
- Porter, P. S., Ward, R. C., and Bell, H. F. (1988). "The detection limit." *Environ. Sci. Technol.* 22, 856-861.
- Rohlf, F. J., and Sokal, R. R. (1981). *Statistical tables*. W. H. Freeman, New York, 219.
- SAS Institute, Inc. (1990a). *Language: Reference, Version 6*, 1<sup>st</sup> ed., Cary, NC, 1042.
- \_\_\_\_\_. (1990b). *SAS procedures guide, Version 6*, 3<sup>rd</sup> ed., Cary, NC, 705.

- SAS Institute, Inc. (1990c). *SAS/STAT™ user's guide, Version 6, 4<sup>th</sup> ed.*, Volumes 1 and 2. Cary, NC. 943 and 846.
- \_\_\_\_\_. (1990d). *SAS/GRAPH® Software: Reference, Version 6, 1<sup>st</sup> ed.*, Volumes 1 and 2. Cary, NC. 794 and 664.
- Satterthwaite, F. W. (1946). "An approximate distribution of estimates of variance components," *Biom. Bull.* 2, 110-114.
- Scholze, M., Boedeker, W., Faust, M., Backhaus, T., Altenburger, R., and Grimme, L. Horst. (2001). "A general best-fit method for concentration-response curves and the estimation of low-effect concentrations," *Environ. Toxicol. Chem.* 20(2), 448-457.
- Shapiro, S. S., and Wilk, M.B. (1965). "An analysis of variance test for normality (complete samples)," *Biometrika* 52, 591-611.
- Snedecor, G. W., and Cochran, G. C. (1989). *Statistical methods*. 8th ed., The Iowa State University Press, Ames, IA, 507.
- Sokal, R. R., and Rohlf, F. J. (1981). *Biometry*. 2nd ed., W. H. Freeman, San Francisco, CA. 859.
- Steel, R. G. D., and Torrie, J. H. (1980). *Principles and procedures of statistics*. 2nd ed., McGraw-Hill, New York, 633.
- Stephan, C. E. (1977). "Methods for Calculating an LC<sub>50</sub>." *Aquatic Toxicology and Hazard Evaluation*. F. L. Mayer and J. A. Hamelink, eds., ASTM Spec. Tech. Publ. 634. American Society for Testing and Materials, Philadelphia, PA, 65-84.
- Thackston, E. L., and Palermo, M. R. (2000). "Improved methods for correlating turbidity and suspended solids for monitoring," DOER Technical Notes Collection (ERDC TN-DOER-E8), U.S. Army Engineer Research and Development Center, Vicksburg, MS.
- U.S. Environmental Protection Agency. (1985). "Methods for measuring the acute toxicity of effluents to freshwater and marine organisms," EPA-600/4-85/013, 3rd ed, Environmental Monitoring and Support Laboratory, Cincinnati, OH.
- \_\_\_\_\_. (1989). "Short-term methods for estimating the chronic toxicity of effluents and receiving waters to aquatic organisms," EPA/600/4-89/001, 2<sup>nd</sup> ed., Cincinnati, OH, 262.
- \_\_\_\_\_. (1994). "Short-term methods for estimating the chronic toxicity of effluents and receiving waters to freshwater organisms," EPA/600/4-91/002, 3<sup>rd</sup> ed, Cincinnati, OH.

- Wilkinson, L. (1990). *SYSTAT: The system for statistics*. SYSTAT Inc., Evanston, IL, 677.
- Winer, B. J. (1971). *Statistical principles in experimental design*. 2nd ed., McGraw-Hill, New York, 907.
- Zar, J. H. (1984). *Biostatistical analysis*. 2nd ed., Prentice-Hall, Englewood Cliffs, NJ, 717.

# REPORT DOCUMENTATION PAGE

*Form Approved*  
OMB No. 0704-0188

Public reporting burden for this collection of information is estimated to average 1 hour per response, including the time for reviewing instructions, searching existing data sources, gathering and maintaining the data needed, and completing and reviewing this collection of information. Send comments regarding this burden estimate or any other aspect of this collection of information, including suggestions for reducing this burden to Department of Defense, Washington Headquarters Services, Directorate for Information Operations and Reports (0704-0188), 1215 Jefferson Davis Highway, Suite 1204, Arlington, VA 22202-4302. Respondents should be aware that notwithstanding any other provision of law, no person shall be subject to any penalty for failing to comply with a collection of information if it does not display a currently valid OMB control number. **PLEASE DO NOT RETURN YOUR FORM TO THE ABOVE ADDRESS.**

<b>1. REPORT DATE (DD-MM-YYYY)</b> January 2003		<b>2. REPORT TYPE</b> Final report		<b>3. DATES COVERED (From - To)</b>	
<b>4. TITLE AND SUBTITLE</b>  Evaluation of Dredged Material Proposed for Disposal at Island, Nearshore, or Upland Confined Disposal Facilities — Testing Manual				<b>5a. CONTRACT NUMBER</b>	
				<b>5b. GRANT NUMBER</b>	
				<b>5c. PROGRAM ELEMENT NUMBER</b>	
<b>6. AUTHOR(S)</b>  U.S. Army Corps of Engineers				<b>5d. PROJECT NUMBER</b>	
				<b>5e. TASK NUMBER</b>	
				<b>5f. WORK UNIT NUMBER</b>	
<b>7. PERFORMING ORGANIZATION NAME(S) AND ADDRESS(ES)</b>  U.S. Army Engineer Research and Development Center Environmental Laboratory 3909 Halls Ferry Road Vicksburg, MS 39180-6199				<b>8. PERFORMING ORGANIZATION REPORT NUMBER</b>  ERDC/EL TR-03-1	
<b>9. SPONSORING / MONITORING AGENCY NAME(S) AND ADDRESS(ES)</b>  U.S. Army Corps of Engineers Washington, DC 20314-1000				<b>10. SPONSOR/MONITOR'S ACRONYM(S)</b>	
				<b>11. SPONSOR/MONITOR'S REPORT NUMBER(S)</b>	
<b>12. DISTRIBUTION / AVAILABILITY STATEMENT</b>  Approved for public release; distribution is unlimited					
<b>13. SUPPLEMENTARY NOTES</b>					
<b>14. ABSTRACT</b>  This manual is a resource document providing technical guidance for evaluation of potential contaminant migration pathways from confined disposal facilities (CDFs). Disposal of dredged material in CDFs is one of the most commonly considered alternatives for material deemed unsuitable for conventional open water disposal because of potential contaminant impacts and is also an option commonly considered for disposal of contaminated sediments dredged for purposes of sediment remediation. If contaminated sediments are placed in a CDF, consideration of pathways for migration of contaminants from the site and potential contaminant impacts may be required. A suite of evaluation procedures and laboratory test procedures has been developed to evaluate CDF contaminant pathways and is presented in detail in this manual. A tiered testing and evaluation approach is used. The Tier I evaluation determines the need for pathway evaluations, pathways of concern, contaminants of concern, and which pathways require more detailed evaluations based on existing information. Tier II evaluations consist of determining the need for management actions derived from very conservative techniques that use the chemical, physical, and biological characteristics of the dredged material and basic information about the CDF. Tier III focuses primarily on definitive evaluations, including pathway testing. Tier IV, which should rarely be needed for navigation projects, includes formal quantitative risk assessment designed to answer specific, well-defined questions. <span style="float: right;">(Continued)</span>					
<b>15. SUBJECT TERMS</b> Confined disposal facilities Contaminant pathways		Contaminated sediments Dredged material Upland disposal			
<b>16. SECURITY CLASSIFICATION OF:</b>			<b>17. LIMITATION OF ABSTRACT</b>	<b>18. NUMBER OF PAGES</b>  335	<b>19a. NAME OF RESPONSIBLE PERSON</b>
<b>a. REPORT</b>  UNCLASSIFIED	<b>b. ABSTRACT</b>  UNCLASSIFIED	<b>c. THIS PAGE</b>  UNCLASSIFIED			<b>19b. TELEPHONE NUMBER (include area code)</b>



**14. ABSTRACT (Continued)**

This manual is intended for use by the U.S. Army Corps of Engineers (USACE), Federal, and state regulatory and resource agencies, dredging permit applicants, and others (e.g., scientists and engineers, managers, and other involved or concerned individuals). It can facilitate decision-making with regard to the management of dredged material. Because this manual is national in scope, the guidance provided is generic and may be applied within various regulatory settings. Application of this guidance in some site-specific situations will require best professional judgment, appropriately documented. Users of the manual are strongly encouraged to consult with their appropriate USACE District experts for additional guidance.